



BUREAU VERITAS

Test Report No.: RF180131W003-7



FCC TEST REPORT

(Part 15, Subpart E)



Applicant:	FIH International Co., Ltd.
Address:	No.18, Tongji zhonglu, Beijing Economic & Technological Development Area

Manufacturer or Supplier:	HMD Global Oy
Address:	Karaportti 2 02610 Espoo FINLAND
Product:	GSM/WCDMA/LTE Mobile Phone
Brand Name:	Nokia
Model Name:	TA-1049
FCC ID:	2AJOTTA-1049
Date of tests:	Mar. 23, 2018 ~ Apr. 17, 2018

The tests have been carried out according to the requirements of the following standard:

FCC Part 15, Subpart E, Section 15.407

CONCLUSION: The submitted sample was found to COMPLY with the test requirement

Prepared by Yuqiang Yin Engineer / Mobile Department	Approved by Sam Tung Manager / Mobile Department
	
Date: Apr. 18, 2018	Date: Apr. 18, 2018

This report is for your exclusive use. Any copying or replication of this report to or for any other person or entity, or use of our name or trademark, is permitted only with our prior written permission. This report sets forth our findings solely with respect to the test samples identified herein. The results set forth in this report are not indicative or representative of the quality or characteristics of the lot from which a test sample was taken or any similar or identical product unless specifically and expressly noted. Our report includes all of the tests requested by you and the results thereof based upon the information that you provided to us. You have 60 days from date of issuance of this report to notify us of any material error or omission caused by our negligence, provided, however, that such notice shall be in writing and shall specifically address the issue you wish to raise. A failure to raise such issue within the prescribed time shall constitute your unqualified acceptance of the completeness of this report, the tests conducted and the correctness of the report contents. Unless specific mention, the uncertainty of measurement has been explicitly taken into account to declare the compliance or non-compliance to the specification



TABLE OF CONTENTS

RELEASE CONTROL RECORD 4

1 SUMMARY OF TEST RESULTS..... 5

1.1 MEASUREMENT UNCERTAINTY 5

2 GENERAL INFORMATION 6

2.1 GENERAL DESCRIPTION OF EUT 6

2.2 DESCRIPTION OF TEST MODES 8

2.2.1 TEST MODE APPLICABILITY AND TESTED CHANNEL DETAIL..... 10

2.3 DUTY CYCLE OF TEST SIGNAL 13

2.4 DESCRIPTION OF SUPPORT UNITS 14

2.4.1 CONFIGURATION OF SYSTEM UNDER TEST 14

2.5 GENERAL DESCRIPTION OF APPLIED STANDARDS 15

3 TEST TYPES AND RESULTS..... 16

3.1 RADIATED EMISSION AND BANDEDGE MEASUREMENT 16

3.1.1 LIMITS OF RADIATED EMISSION AND BANDEDGE MEASUREMENT 16

3.1.2 LIMITS OF UNWANTED EMISSION 16

3.1.3 TEST INSTRUMENTS..... 17

3.1.4 TEST PROCEDURES 18

3.1.5 DEVIATION FROM TEST STANDARD 18

3.1.6 TEST SETUP 19

3.1.7 EUT OPERATING CONDITION 20

3.1.8 TEST RESULTS 21

3.2 CONDUCTED EMISSION MEASUREMENT 64

3.2.1 LIMITS OF CONDUCTED EMISSION MEASUREMENT 64

3.2.2 TEST INSTRUMENTS..... 64

3.2.3 TEST PROCEDURES 64

3.2.4 DEVIATION FROM TEST STANDARD 65

3.2.5 TEST SETUP 65

3.2.6 EUT OPERATING CONDITIONS 65

3.2.7 TEST RESULTS 66

3.3 MAXIMUM CONDUCTED OUTPUT POWER MEASUREMENT 68

3.3.1 LIMITS OF MAXIMUM CONDUCTED OUTPUT POWER MEASUREMENT 68

3.3.2 TEST SETUP 69



3.3.3	TEST INSTRUMENTS.....	69
3.3.4	TEST PROCEDURE.....	70
3.3.5	DEVIATION FROM TEST STANDARD	71
3.3.6	EUT OPERATING CONDITIONS.....	71
3.3.7	TEST RESULTS	72
3.4	MAXIMUM POWER SPECTRAL DENSITY MEASUREMENT.....	85
3.4.1	LIMITS OF MAXIMUM POWER SPECTRAL DENSITY MEASUREMENT	85
3.4.2	TEST SETUP.....	85
3.4.3	TEST INSTRUMENTS.....	85
3.4.4	TEST PROCEDURES	86
3.4.5	DEVIATION FROM TEST STANDARD	86
3.4.6	EUT OPERATING CONDITIONS.....	86
3.4.7	TEST RESULTS	87
3.5	FREQUENCY STABILITY	94
3.5.1	LIMITS OF FREQUENCY STABILITY MEASUREMENT.....	94
3.5.2	TEST SETUP.....	94
3.5.3	TEST INSTRUMENTS.....	94
3.5.4	TEST PROCEDURE.....	95
3.5.5	DEVIATION FROM TEST STANDARD	95
3.5.6	EUT OPERATING CONDITION	95
3.5.7	TEST RESULTS	96
4	PHOTOGRAPHS OF THE TEST CONFIGURATION.....	98
5	APPENDIX A – MODIFICATIONS RECORDERS FOR ENGINEERING CHANGES TO THE EUT BY THE LAB.....	99



BUREAU
VERITAS

Test Report No.: RF180131W003-7

RELEASE CONTROL RECORD

ISSUE NO.	REASON FOR CHANGE	DATE ISSUED
RF180131W003-7	Original release	Apr. 18, 2018



1 SUMMARY OF TEST RESULTS

The EUT has been tested according to the following specifications:

APPLIED STANDARD: FCC PART 15, SUBPART E (SECTION 15.407)			
STANDARD SECTION	TEST TYPE AND LIMIT	RESULT	REMARK
15.407(b)(5)	AC Power Conducted Emission	PASS	Meet the requirement of limit. Minimum passing margin is -9.24dB at 0.476000MHz.
15.407(b) (1/2/3/4/6)	Radiated Emission & Band Edge Measurement	PASS	Meet the requirement of limit. Minimum passing margin is -1.08dB at 5470MHz.
15.407(a/1/2/3)	Maximum conducted output Power	PASS	Meet the requirement of limit.
15.407(a/1/2/3)	Peak Power Spectral Density	PASS	Meet the requirement of limit.
15.407(e)	6 dB Bandwidth	PASS	Meet the requirement of limit. (U-NII-3 Band only)
15.407(g)	Frequency Stability	PASS	Meet the requirement of limit.
15.203	Antenna Requirement	PASS	No antenna connector is used.

1.1 MEASUREMENT UNCERTAINTY

Where relevant, the following measurement uncertainty levels have been estimated for tests performed on the EUT as specified in CISPR 16-4-2:

MEASUREMENT	FREQUENCY	UNCERTAINTY
Conducted emissions	9kHz~30MHz	2.66dB
Radiated emissions	9KHz ~ 30MHz	2.68dB
	30MHz ~ 1GMHz	3.26dB
	1GHz ~ 18GHz	4.48dB
	18GHz ~ 40GHz	4.12dB

This uncertainty represents an expanded uncertainty expressed at approximately the 95% confidence level using a coverage factor of k = 2.



2 GENERAL INFORMATION

2.1 GENERAL DESCRIPTION OF EUT

EUT	GSM/WCDMA/LTE Mobile Phone
MODEL NO.	TA-1049
POWER SUPPLY	5.0Vdc (adapter or host equipment) 3.9Vdc (Li-ion, battery)
MODULATION TYPE	64QAM, 16QAM, QPSK, BPSK
MODULATION TECHNOLOGY	OFDM
TRANSFER RATE	802.11a: 54.0/ 48.0/ 36.0/ 24.0/ 18.0/ 12.0/ 9.0/ 6.0Mbps 802.11n: up to MCS7
OPERATING FREQUENCY	5150 ~ 5250MHz, 5250 ~ 5350MHz, 5470 ~ 5725MHz, 5725 ~ 5850MHz
NUMBER OF CHANNEL	5180 ~ 5240MHz: 4 for 802.11a, 802.11n (20MHz) 2 for 802.11n (40MHz) 5260 ~ 5320MHz: 4 for 802.11a, 802.11n (20MHz) 2 for 802.11n (40MHz) 5500 ~ 5700MHz: 8 for 802.11a, 802.11n (20MHz) 3 for 802.11n (40MHz) 5745 ~ 5850MHz: 5 for 802.11a, 802.11n (20MHz) 2 for 802.11n (40MHz)
AVERAGE POWER	42.073mW for 5150 ~ 5250MHz 44.463mW for 5250 ~ 5350MHz 42.658mW for 5470 ~ 5725MHz 34.995mW for 5745 ~ 5850MHz
ANTENNA TYPE	PIFA Antenna with -1.98dBi gain
HW VERSION	HW0303
SW VERSION	000C_0_34A
I/O PORTS	Refer to user's manual
CABLE SUPPLIED	USB cable: non-shielded, detachable, 1.0m Earphone cable: non-shielded, detachable, 1.5m

NOTE:

- For a more detailed features description, please refer to the manufacturer's specifications or the user's manual.
- The EUT incorporates a SISO function. Physically, the EUT provides one completed transmitter and one receiver.

MODULATION MODE	TX FUNCTION
802.11a	1TX/1RX
802.11n (20MHz)	1TX/1RX
802.11n (40MHz)	1TX/1RX



3. For the test results, the EUT had been tested with all conditions. But only the worst case was shown in test report.

List of Accessories:

ACCESSORIES	BRAND	MANUFACTURER	MODEL	SPECIFICATION
Adapter 1	Salcomp	Salcomp (Shenzhen) Co., Ltd.	FC0202	I/P: 100-240Vac, 150mA O/P: 5Vdc, 1000mA
Adapter 2	Aohai	DONGGUAN AOHAO TECHNOLOGY CO., LTD.	AD-5WU	I/P: 100-240Vac, 150mA O/P: 5Vdc, 1000mA
Battery	SCUD	SCUD (Fujian) Electronics CO., Ltd.	HE336	Rating: 3.85Vdc, 2900mAh
Earphone 1	Nokia	FIT	WH-108	1.5m non-shielded cable w/o core
Earphone 2	Nokia	OBO	WH-108	1.5m non-shielded cable w/o core
USB Cable	Nokia	FIH	CA-190CD	1.0m non-shielded cable w/o core



2.2 DESCRIPTION OF TEST MODES

FOR 5150 ~ 5250MHz

4 channels are provided for 802.11a, 802.11n (20MHz):

CHANNEL	FREQUENCY	CHANNEL	FREQUENCY
36	5180 MHz	44	5220 MHz
40	5200 MHz	48	5240 MHz

2 channels are provided for 802.11n (40MHz):

CHANNEL	FREQUENCY	CHANNEL	FREQUENCY
38	5190 MHz	46	5230 MHz

FOR 5250 ~ 5350MHz

4 channels are provided for 802.11a, 802.11n (20MHz):

CHANNEL	FREQUENCY	CHANNEL	FREQUENCY
52	5260 MHz	60	5300 MHz
56	5280 MHz	64	5320 MHz

2 channels are provided for 802.11n (40MHz):

CHANNEL	FREQUENCY	CHANNEL	FREQUENCY
54	5270 MHz	62	5310 MHz

FOR 5470 ~ 5725MHz

8 channels are provided for 802.11a, 802.11n (20MHz):

CHANNEL	FREQUENCY	CHANNEL	FREQUENCY
100	5500 MHz	116	5580 MHz
104	5520 MHz	132	5660 MHz
108	5540 MHz	136	5680 MHz
112	5560 MHz	140	5700 MHz

3 channels are provided for 802.11n (40MHz):

CHANNEL	FREQUENCY	CHANNEL	FREQUENCY
102	5510 MHz	134	5670 MHz
110	5550 MHz		



FOR 5725 ~ 5850MHz

5 channels are provided for 802.11a, 802.11n (20MHz):

CHANNEL	FREQUENCY	CHANNEL	FREQUENCY
149	5745 MHz	161	5805 MHz
153	5765 MHz	165	5825 MHz
157	5785 MHz		

2 channels are provided for 802.11n (40MHz):

CHANNEL	FREQUENCY	CHANNEL	FREQUENCY
151	5755 MHz	159	5795 MHz



2.2.1 TEST MODE APPLICABILITY AND TESTED CHANNEL DETAIL

EUT CONFIGURE MODE	APPLICABLE TO				DESCRIPTION
	RE≥1G	RE<1G	PLC	APCM	
A	√	√	√	-	Powered by Adapter with wifi(5G) link
B	-	-	-	√	Powered by Battery with wifi(5G) link
C	-	-	-	-	Powered by USB with wifi(5G) link

Where **RE≥1G**: Radiated Emission above 1GHz **RE<1G**: Radiated Emission below 1GHz
PLC: Power Line Conducted Emission **APCM**: Antenna Port Conducted Measurement

NOTE:
The EUT had been pre-tested on the positioned of each 3 axis. The worst case was found when positioned on **X-plane**.
NOTE: "-" means no effect.

RADIATED EMISSION TEST (ABOVE 1GHz):

- Pre-Scan has been conducted to determine the worst-case mode from all possible combinations between available modulations, data rates and antenna ports (if EUT with antenna diversity architecture).
- Following channel(s) was (were) selected for the final test as listed below.

EUT CONFIGURE MODE	MODE	FREQ. BAND (MHz)	AVAILABLE CHANNEL	TESTED CHANNEL	MODULATION TECHNOLOGY	MODULATION TYPE	DATA RATE (Mbps)
A	802.11a	5150-5250	36 to 48	36, 40, 48	OFDM	BPSK	6.0
A	802.11n (20MHz)		36 to 48	36, 40, 48	OFDM	BPSK	MCS0
A	802.11n (40MHz)		38 to 46	38, 46	OFDM	BPSK	MCS0
A	802.11a	5250-5350	52 to 64	52, 60, 64	OFDM	BPSK	6.0
A	802.11n (20MHz)		52 to 64	52, 60, 64	OFDM	BPSK	MCS0
A	802.11n (40MHz)		54 to 62	54, 62	OFDM	BPSK	MCS0
A	802.11a	5470-5725	100 to 140	100, 116, 140	OFDM	BPSK	6.0
A	802.11n (20MHz)		100 to 140	100, 116, 140	OFDM	BPSK	MCS0
A	802.11n (40MHz)		102 to 134	102, 110, 134	OFDM	BPSK	MCS0
A	802.11a	5725-5850	149 to 165	149, 157, 165	OFDM	BPSK	6.0
A	802.11n (20MHz)		149 to 165	149, 157, 165	OFDM	BPSK	MCS0
A	802.11n (40MHz)		151 to 159	151, 159	OFDM	BPSK	MCS0



RADIATED EMISSION TEST (BELOW 1GHz):

- Pre-Scan has been conducted to determine the worst-case mode from all possible combinations between available modulations, data rates and antenna ports (if EUT with antenna diversity architecture).
- Following channel(s) was (were) selected for the final test as listed below.

EUT CONFIGURE MODE	MODE	FREQ. BAND (MHz)	AVAILABLE CHANNEL	TESTED CHANNEL	MODULATION TECHNOLOGY	MODULATION TYPE	DATA RATE (Mbps)
A	802.11n (40MHz)	5470-5725	102 to 134	102	OFDM	BPSK	MCS0

POWER LINE CONDUCTED EMISSION TEST:

- Pre-Scan has been conducted to determine the worst-case mode from all possible combinations between available modulations, data rates and antenna ports (if EUT with antenna diversity architecture).
- Following channel(s) was (were) selected for the final test as listed below.

EUT CONFIGURE MODE	MODE	FREQ. BAND (MHz)	AVAILABLE CHANNEL	TESTED CHANNEL	MODULATION TECHNOLOGY	MODULATION TYPE	DATA RATE (Mbps)
A	802.11n (40MHz)	5470-5725	102 to 134	102	OFDM	BPSK	MCS0

BANDEDGE MEASUREMENT:

- Pre-Scan has been conducted to determine the worst-case mode from all possible combinations between available modulations, data rates and antenna ports (if EUT with antenna diversity architecture).
- Following channel(s) was (were) selected for the final test as listed below.

EUT CONFIGURE MODE	MODE	FREQ. BAND (MHz)	AVAILABLE CHANNEL	TESTED CHANNEL	MODULATION TECHNOLOGY	MODULATION TYPE	DATA RATE (Mbps)
A	802.11a	5150-5250	36 to 48	36, 48	OFDM	BPSK	6.0
A	802.11n (20MHz)		36 to 48	36, 48	OFDM	BPSK	MCS0
A	802.11n (40MHz)		38 to 46	38, 46	OFDM	BPSK	MCS0
A	802.11a	5250-5350	52 to 64	52, 64	OFDM	BPSK	6.0
A	802.11n (20MHz)		52 to 64	52, 64	OFDM	BPSK	MCS0
A	802.11n (40MHz)		54 to 62	54, 62	OFDM	BPSK	MCS0
A	802.11a	5470-5725	100 to 140	100, 140	OFDM	BPSK	6.0
A	802.11n (20MHz)		100 to 140	100, 140	OFDM	BPSK	MCS0
A	802.11n (40MHz)		102 to 134	102, 134	OFDM	BPSK	MCS0
A	802.11a	5725-5850	149 to 165	149, 165	OFDM	BPSK	6.0
A	802.11n (20MHz)		149 to 165	149, 165	OFDM	BPSK	MCS0
A	802.11n (40MHz)		151 to 159	151, 159	OFDM	BPSK	MCS0



ANTENNA PORT CONDUCTED MEASUREMENT:

- This item includes all test value of each mode, but only includes spectrum plot of worst value of each mode.
- Pre-Scan has been conducted to determine the worst-case mode from all possible combinations between available modulations, data rates and antenna ports (if EUT with antenna diversity architecture).
- Following channel(s) was (were) selected for the final test as listed below.

EUT CONFIGURE MODE	MODE	FREQ. BAND (MHz)	AVAILABLE CHANNEL	TESTED CHANNEL	MODULATION TECHNOLOGY	MODULATION TYPE	DATA RATE (Mbps)
B	802.11a	5150-5250	36 to 48	36, 40, 48	OFDM	BPSK	6.0
B	802.11n (20MHz)		36 to 48	36, 40, 48	OFDM	BPSK	MCS0
B	802.11n (40MHz)		38 to 46	38, 46	OFDM	BPSK	MCS0
B	802.11a	5250-5350	52 to 64	52, 60, 64	OFDM	BPSK	6.0
B	802.11n (20MHz)		52 to 64	52, 60, 64	OFDM	BPSK	MCS0
B	802.11n (40MHz)		54 to 62	54, 62	OFDM	BPSK	MCS0
B	802.11a	5470-5725	100 to 140	100, 116, 140	OFDM	BPSK	6.0
B	802.11n (20MHz)		100 to 140	100, 116, 140	OFDM	BPSK	MCS0
B	802.11n (40MHz)		102 to 134	102, 110, 134	OFDM	BPSK	MCS0
B	802.11a	5725-5850	149 to 165	149, 165	OFDM	BPSK	6.0
B	802.11n (20MHz)		149 to 165	149, 165	OFDM	BPSK	MCS0
B	802.11n (40MHz)		151 to 159	151, 159	OFDM	BPSK	MCS0

TEST CONDITION:

APPLICABLE TO	ENVIRONMENTAL CONDITIONS	INPUT POWER	TESTED BY
RE<1G	23deg. C, 62%RH	DC 5V By Adapter	Star Le
RE≥1G	23deg. C, 62%RH	DC 5V By Adapter	Star Le
PLC	24deg. C, 61%RH	DC 5V By Adapter	Alex Chen
APCM	23.5deg. C, 60%RH	DC 3.9V By battery	Wenliang Wu



2.3 DUTY CYCLE OF TEST SIGNAL

Duty cycle of test signal is < 98%, duty factor shall be considered.

802.11a: Duty cycle = 1.391/1.439 = 0.967, Duty factor = 10 * log(1/0.967) = 0.15

802.11n (20MHz): Duty cycle = 1.292/1.353 = 0.955, Duty factor = 10 * log(1/0.955) = 0.20

802.11n (40MHz): Duty cycle = 0.646/0.691 = 0.935, Duty factor = 10 * log(1/0.935) = 0.29





2.4 DESCRIPTION OF SUPPORT UNITS

The EUT has been tested as an independent unit together with other necessary accessories or support units. The following support units or accessories were used to form a representative test configuration during the tests.

NO.	PRODUCT	BRAND	MODEL NO.	SERIAL NO.	FCC ID
1	PC	HP	A6608CN	3CR83825X3	N/A

NO.	SIGNAL CABLE DESCRIPTION OF THE ABOVE SUPPORT UNITS
1	AC Line: Unshielded, Detachable 1.5m

NOTE:

1. All power cords of the above support units are non shielded (1.8m).

2.4.1 CONFIGURATION OF SYSTEM UNDER TEST

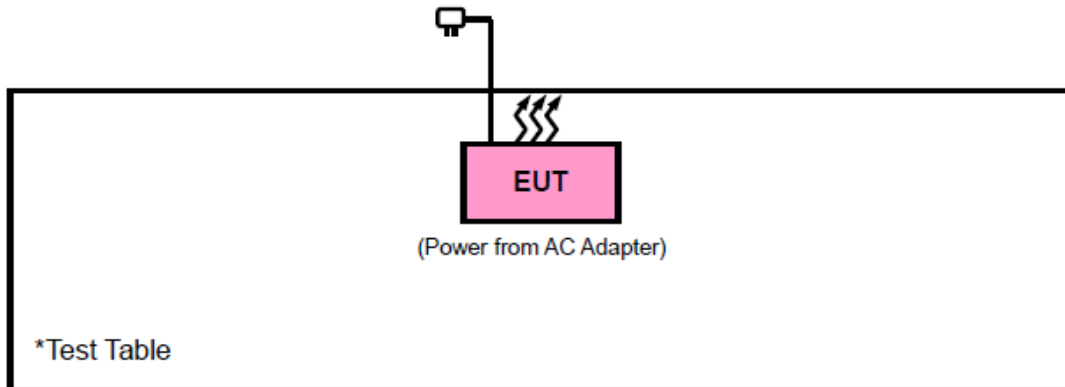



2.5 GENERAL DESCRIPTION OF APPLIED STANDARDS

The EUT is a RF Product. According to the specifications of the manufacturer, it must comply with the requirements of the following standards:

FCC Part 15, Subpart E (15.407)

KDB 789033 D02 General U-NII Test Procedures New Rules v02r01

ANSI C63.10-2013

All test items have been performed and recorded as per the above standards.

NOTE: The EUT is also considered as a kind of computer peripheral, because the connection to computer is necessary for typical use. It has been verified to comply with the requirements of FCC Part 15, Subpart B, Class B (Certification). The test report has been issued separately.



3 TEST TYPES AND RESULTS

3.1 RADIATED EMISSION AND BANDEDGE MEASUREMENT

3.1.1 LIMITS OF RADIATED EMISSION AND BANDEDGE MEASUREMENT

Radiated emissions which fall in the restricted bands must comply with the radiated emission limits specified as below table:

FREQUENCIES (MHz)	FIELD STRENGTH (microvolts/meter)	MEASUREMENT DISTANCE (meters)
0.009 ~ 0.490	2400/F(kHz)	300
0.490 ~ 1.705	24000/F(kHz)	30
1.705 ~ 30.0	30	30
30 ~ 88	100	3
88 ~ 216	150	3
216 ~ 960	200	3
Above 960	500	3

NOTE:

1. The lower limit shall apply at the transition frequencies.
2. Emission level (dBuV/m) = 20 log Emission level (uV/m).
3. For frequencies above 1000MHz, the field strength limits are based on average detector, however, the peak field strength of any emission shall not exceed the maximum permitted average limits, specified above by more than 20dB under any condition of modulation.

3.1.2 LIMITS OF UNWANTED EMISSION

RESTRICTED BANDS	APPLICABLE TO	LIMIT	
	789033 D02 General UNII Test Procedures New Rules v01r02	FIELD STRENGTH AT 3m (dBµV/m)	
	PK : 74	AV : 54	
OUT OF THE RESTRICTED BANDS	APPLICABLE TO	EIRP LIMIT (dBm/MHz)	EQUIVALENT FIELD STRENGTH AT 3m (dBµV/m)
	15.407(b)(1)	PK : -27	PK : 68.3
	15.407(b)(2)		
	15.407(b)(3)		
15.407(b)(4)	See note 2 (FCC 16-24)		



NOTE: The following formula is used to convert the equipment isotropic radiated power (eirp) to field strength:

$$E = \frac{1000000\sqrt{30P}}{3} \text{ } \mu\text{V/m, where P is the eirp (Watts).}$$

2. All emissions shall be limited to a level of -27 dBm/MHz at 75 MHz or more above or below the band edge increasing linearly to 10 dBm/MHz at 25 MHz above or below the band edge, and from 25 MHz above or below the band edge increasing linearly to a level of 15.6 dBm/MHz at 5 MHz above or below the band edge, and from 5 MHz above or below the band edge increasing linearly to a level of 27 dBm/MHz at the band edge.

3.1.3 TEST INSTRUMENTS

Equipment	Manufacturer	Model No.	Serial No.	Last Cal.	Next Cal.
3m Semi-anechoic Chamber	ETS-LINDGREN	9m*6m*6m	Euroshieldpn-CT0001143-1216	May 06,17	May 05,18
Bilog Antenna	ETS-LINDGREN	3143B	00161965	Nov. 26,16	Nov. 25,18
Horn Antenna	ETS-LINDGREN	3117	00168728	Nov. 26,16	Nov. 25,18
Loop antenna	Daze	ZN30900A	0708	Nov. 20,17	Nov. 19,18
Horn Antenna (18GHz-40GHz)	N/A	QWH-SL-18-40-K-SG/QMS-00361	15433	Dec. 16,16	Dec. 15,18
Test Software	E3	V 9.160323	N/A	N/A	N/A
Test Software	ADT	ADT_Radiated_V7.6.15.9.2	N/A	N/A	N/A
10dB Attenuator	JFW/USA	50HF-010-SMA	1505	Jul. 24,17	Jul. 23,18
MXE EMI Receiver	KEYSIGHT	N9038A-544	MY54450026	Mar. 16,18	Mar. 15,19
Signal Pre-Amplifier	EMSI	EMC 9135	980249	Jul. 24,17	Jul. 23,18
Signal Pre-Amplifier	EMSI	EMC 012645B	980257	Jul. 24,17	Jul. 23,18
Signal Pre-Amplifier	EMSI	EMC 184045B	980259	Jul. 24,17	Jul. 23,18

NOTE:

1. The calibration interval of the above test instruments is 12 months and the calibrations are traceable to CEPREI/CHINA, GRGT/CHINA and NIM/CHINA.
2. The test was performed in 3m Chamber.
3. The FCC Site Registration No. is 525120.



3.1.4 TEST PROCEDURES

- a. The EUT was placed on the top of a rotating table 0.8 meters (for below 1GHz) / 1.5 meters (for above 1GHz) above the ground at 3 meter chamber room for test. The table was rotated 360 degrees to determine the position of the highest radiation.
- b. The EUT was set 3 meters away from the interference-receiving antenna, which was mounted on the top of a variable-height antenna tower.
- c. The antenna is a broadband antenna, and its height is varied from one meter to four meters above the ground to determine the maximum value of the field strength. Both horizontal and vertical polarizations of the antenna are set to make the measurement.
- d. For each suspected emission, the EUT was arranged to its worst case and then the antenna was tuned to heights from 1 meter to 4 meters and the rotatable table was turned from 0 degrees to 360 degrees to find the maximum reading.
- e. The test-receiver system was set to Peak Detect Function and Specified Bandwidth with Maximum Hold Mode.
- f. If the emission level of the EUT in peak mode was 10dB lower than the limit specified, then testing could be stopped and the peak values of the EUT would be reported. Otherwise the emissions that did not have 10dB margin would be re-tested one by one using peak, quasi-peak or average method as specified and then reported in a data sheet.

NOTE:

1. The resolution bandwidth and video bandwidth of test receiver/spectrum analyzer is 120kHz for Peak detection (PK) and Quasi-peak detection (QP) at frequency below 1GHz.
2. The resolution bandwidth of test receiver/spectrum analyzer is 1MHz and video bandwidth is 3MHz for Peak detection at frequency above 1GHz.
3. The resolution bandwidth of test receiver/spectrum analyzer is 1MHz and the video bandwidth is 10Hz for Average detection (AV) at frequency above 1GHz.
4. All modes of operation were investigated and the worst-case emissions are reported.

3.1.5 DEVIATION FROM TEST STANDARD

No deviation.



3.1.6 TEST SETUP

< Frequency Range below 30MHz >

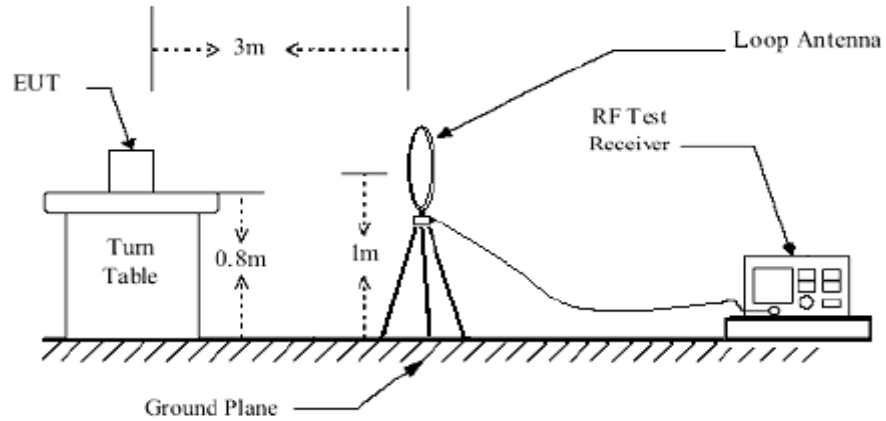

< Frequency Range 30MHz~1GHz >

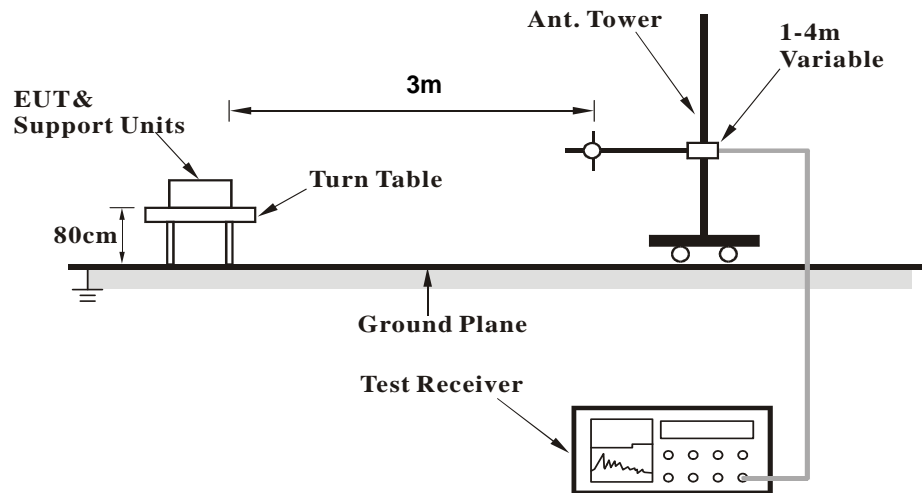



<Frequency Range above 1GHz>

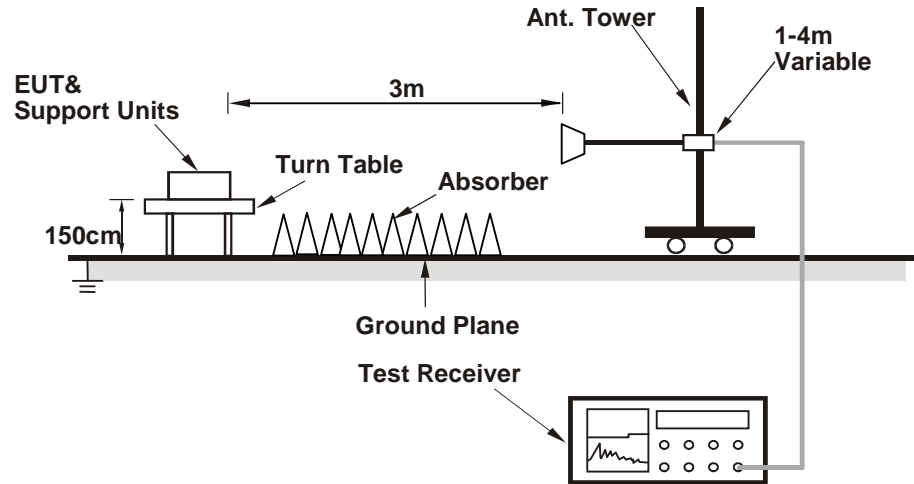

For the actual test configuration, please refer to the attached file (Test Setup Photo).

3.1.7 EUT OPERATING CONDITION

- Set the EUT under full load condition and placed them on a testing table.
- Set the transmitter part of EUT under transmission condition continuously at specific channel frequency.
- The necessary accessories enable the EUT in full functions.



3.1.8 TEST RESULTS

BELOW 1GHz WORST-CASE DATA:

9 KHz – 30 MHz data: the amplitude of spurious emissions attenuated more than 20 dB below the permissible value is not required in the report.

30 MHz – 1GHz data:

802.11n (40MHz)

CHANNEL	TX Channel 102	DETECTOR FUNCTION	Quasi-Peak (QP)
FREQUENCY RANGE	30MHz ~ 1GHz		

ANTENNA POLARITY & TEST DISTANCE: HORIZONTAL AT 3 M										
FREQ. (MHz)	EMISSION LEVEL (dBuV/m)	READ LEVEL (dBuV)	LIMIT (dBuV/m)	MARGIN (dB)	ANTENNA FACTOR (dB /m)	CABLE LOSS (dB)	PREAMP FACTOR (dB)	ANTENNA HEIGHT (cm)	TABLE ANGLE (Degree)	REMARK
36.79	22.98	47.18	40	-17.02	12.41	0.9	37.51	200	175	QP
98.87	28.01	55.6	43.5	-15.49	7.88	1.53	37	200	175	QP
162.89	27.51	52.13	43.5	-15.99	10.16	1.95	36.73	200	175	QP
189.08	29.39	53.91	43.5	-14.11	9.99	2.11	36.62	200	175	QP
200.72	30.58	54.82	43.5	-12.92	10.13	2.17	36.54	200	175	QP
311.3	26.08	46.36	46	-19.92	13.47	2.77	36.52	200	175	QP

REMARKS:

1. Emission level (dBuV/m) = Raw Value (dBuV) + Correction Factor (dB/m).
2. Correction Factor (dB/m) = Antenna Factor (dB/m) + Cable Factor (dB).
3. The other emission levels were very low against the limit.
4. Margin value = Emission level – Limit value.

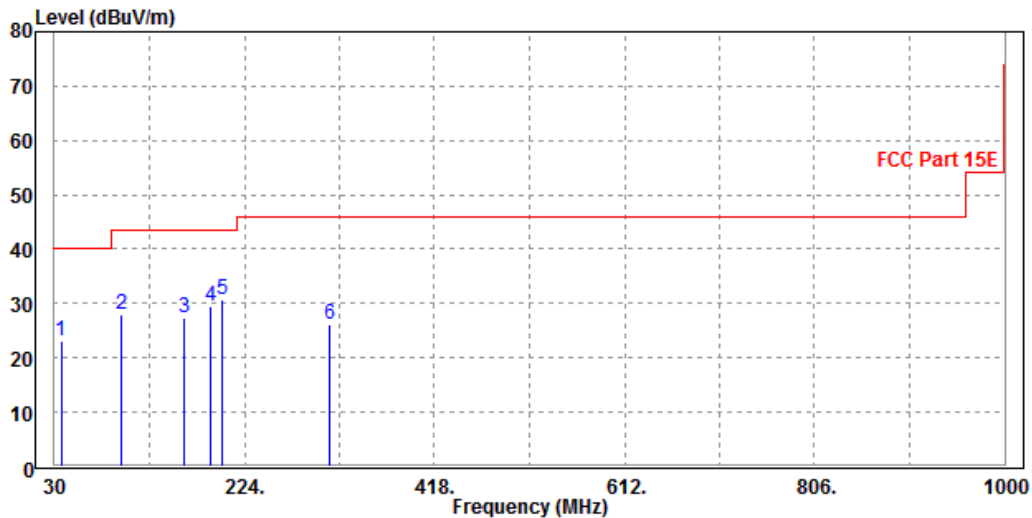



CHANNEL	Channel 102	DETECTOR FUNCTION	Quasi-Peak (QP)
FREQUENCY RANGE	30MHz ~ 1GHz		

ANTENNA POLARITY & TEST DISTANCE: VERTICAL AT 3 M										
FREQ. (MHz)	EMISSION LEVEL (dBuV/m)	READ LEVEL (dBuV)	LIMIT (dBuV/m)	MARGIN (dB)	ANTENNA FACTOR (dB /m)	CABLE LOSS (dB)	PREAMP FACTOR (dB)	ANTENNA HEIGHT (cm)	TABLE ANGLE (Degree)	REMARK
36.79	31.66	55.86	40	-8.34	12.41	0.9	37.51	100	125	QP
43.58	30.1	57.68	40	-9.9	8.88	0.99	37.45	100	125	QP
57.16	28.92	58.68	40	-11.08	6.43	1.15	37.34	100	125	QP
98.87	29.16	56.75	43.5	-14.34	7.88	1.53	37	100	125	QP
162.89	26.72	51.34	43.5	-16.78	10.16	1.95	36.73	100	125	QP
188.11	24.13	48.68	43.5	-19.37	9.98	2.1	36.63	100	125	QP

REMARKS:

1. Emission level (dBuV/m) = Raw Value (dBuV) + Correction Factor (dB/m).
2. Correction Factor (dB/m) = Antenna Factor (dB/m) + Cable Factor (dB).
3. The other emission levels were very low against the limit.
4. Margin value = Emission level – Limit value.

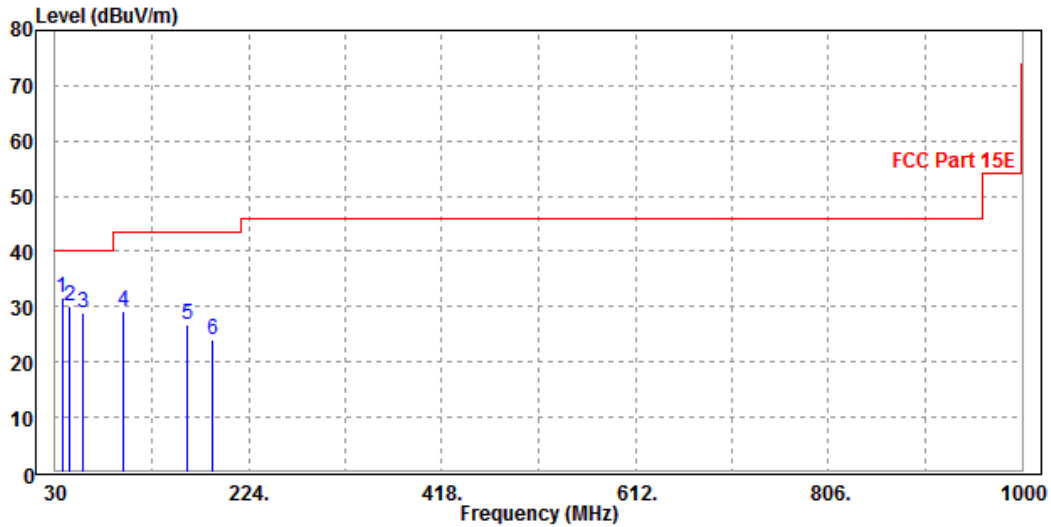



ABOVE 1GHz WORST-CASE DATA:

Note: For higher frequency, the emission is too low to be detected.

**Band 1
802.11a**

CHANNEL	TX Channel 36	DETECTOR FUNCTION	Peak (PK)
FREQUENCY RANGE	1GHz ~ 40GHz		Average (AV)

ANTENNA POLARITY & TEST DISTANCE: HORIZONTAL AT 3 M										
FREQ. (MHz)	EMISSION LEVEL (dBuV/m)	READ LEVEL (dBuV)	LIMIT (dBuV/m)	MARGIN (dB)	ANTENNA FACTOR (dB /m)	CABLE LOSS (dB)	PREAMP FACTOR (dB)	ANTENNA HEIGHT (cm)	TABLE ANGLE (Degree)	REMARK
5150	42.97	40.99	54	-11.03	34.48	13.71	46.21	100	357	Average
5150	54.34	52.36	74	-19.66	34.48	13.71	46.21	100	357	Peak
5180	92.96	90.87			34.52	13.79	46.22	100	357	Average
5180	100.96	98.87			34.52	13.79	46.22	100	357	Peak
5350	43.14	40.39	54	-10.86	34.72	14.28	46.25	100	357	Average
5350	53.97	51.22	74	-20.03	34.72	14.28	46.25	100	357	Peak

ANTENNA POLARITY & TEST DISTANCE: VERTICAL AT 3 M										
FREQ. (MHz)	EMISSION LEVEL (dBuV/m)	READ LEVEL (dBuV)	LIMIT (dBuV/m)	MARGIN (dB)	ANTENNA FACTOR (dB /m)	CABLE LOSS (dB)	PREAMP FACTOR (dB)	ANTENNA HEIGHT (cm)	TABLE ANGLE (Degree)	REMARK
5150	42.81	40.83	54	-11.19	34.48	13.71	46.21	125	277	Average
5150	56.33	54.35	74	-17.67	34.48	13.71	46.21	125	277	Peak
5180	94.86	92.77			34.52	13.79	46.22	125	277	Average
5180	103.63	101.54			34.52	13.79	46.22	125	277	Peak
5350	43.04	40.29	54	-10.96	34.72	14.28	46.25	125	277	Average
5350	55.11	52.36	74	-18.89	34.72	14.28	46.25	125	277	Peak

REMARKS:

- Emission Level = Read Level+ Antenna Factor + Cable Loss- Preamp Factor
Margin value = Emission level – Limit value.
- 5180MHz: Fundamental frequency.



CHANNEL	TX Channel 40	DETECTOR FUNCTION	Peak (PK)
FREQUENCY RANGE	1GHz ~ 40GHz		Average (AV)

ANTENNA POLARITY & TEST DISTANCE: HORIZONTAL AT 3 M										
FREQ. (MHz)	EMISSION LEVEL (dBuV/m)	READ LEVEL (dBuV)	LIMIT (dBuV/m)	MARGIN (dB)	ANTENNA FACTOR (dB /m)	CABLE LOSS (dB)	PREAMP FACTOR (dB)	ANTENNA HEIGHT (cm)	TABLE ANGLE (Degree)	REMARK
5150	42.85	40.87	54	-11.15	34.48	13.71	46.21	100	357	Average
5150	53.98	52	74	-20.02	34.48	13.71	46.21	100	357	Peak
5200	92.74	90.57			34.54	13.85	46.22	100	357	Average
5200	101.06	98.89			34.54	13.85	46.22	100	357	Peak
5350	43.13	40.38	54	-10.87	34.72	14.28	46.25	100	357	Average
5350	54.14	51.39	74	-19.86	34.72	14.28	46.25	100	357	Peak

ANTENNA POLARITY & TEST DISTANCE: VERTICAL AT 3 M										
FREQ. (MHz)	EMISSION LEVEL (dBuV/m)	READ LEVEL (dBuV)	LIMIT (dBuV/m)	MARGIN (dB)	ANTENNA FACTOR (dB /m)	CABLE LOSS (dB)	PREAMP FACTOR (dB)	ANTENNA HEIGHT (cm)	TABLE ANGLE (Degree)	REMARK
5150	42.94	40.96	54	-11.06	34.48	13.71	46.21	125	277	Average
5150	54.32	52.34	74	-19.68	34.48	13.71	46.21	125	277	Peak
5200	95.04	92.87			34.54	13.85	46.22	125	277	Average
5200	103.82	101.65			34.54	13.85	46.22	125	277	Peak
5350	43.34	40.59	54	-10.66	34.72	14.28	46.25	125	277	Average
5350	54.24	51.49	74	-19.76	34.72	14.28	46.25	125	277	Peak

REMARKS:

1. Emission Level = Read Level+ Antenna Factor + Cable Loss- Preamp Factor
Margin value = Emission level – Limit value.
2. 5200MHz: Fundamental frequency.



CHANNEL	TX Channel 48	DETECTOR FUNCTION	Peak (PK)
FREQUENCY RANGE	1GHz ~ 40GHz		Average (AV)

ANTENNA POLARITY & TEST DISTANCE: HORIZONTAL AT 3 M										
FREQ. (MHz)	EMISSION LEVEL (dBuV/m)	READ LEVEL (dBuV)	LIMIT (dBuV/m)	MARGIN (dB)	ANTENNA FACTOR (dB /m)	CABLE LOSS (dB)	PREAMP FACTOR (dB)	ANTENNA HEIGHT (cm)	TABLE ANGLE (Degree)	REMARK
5150	42.26	40.28	54	-11.74	34.48	13.71	46.21	100	335	Average
5150	53.2	51.22	74	-20.8	34.48	13.71	46.21	100	335	Peak
5240	92.35	90.02			34.59	13.97	46.23	100	335	Average
5240	100.54	98.21			34.59	13.97	46.23	100	335	Peak
5350	42.65	39.9	54	-11.35	34.72	14.28	46.25	100	335	Average
5350	55.47	52.72	74	-18.53	34.72	14.28	46.25	100	335	Peak
ANTENNA POLARITY & TEST DISTANCE: VERTICAL AT 3 M										
FREQ. (MHz)	EMISSION LEVEL (dBuV/m)	READ LEVEL (dBuV)	LIMIT (dBuV/m)	MARGIN (dB)	ANTENNA FACTOR (dB /m)	CABLE LOSS (dB)	PREAMP FACTOR (dB)	ANTENNA HEIGHT (cm)	TABLE ANGLE (Degree)	REMARK
5150	42.66	40.68	54	-11.34	34.48	13.71	46.21	125	277	Average
5150	53.72	51.74	74	-20.28	34.48	13.71	46.21	125	277	Peak
5240	95.95	93.62			34.59	13.97	46.23	125	277	Average
5240	104.11	101.78			34.59	13.97	46.23	125	277	Peak
5350	42.97	40.22	54	-11.03	34.72	14.28	46.25	125	277	Average
5350	55.1	52.35	74	-18.9	34.72	14.28	46.25	125	277	Peak

REMARKS:

1. Emission Level = Read Level+ Antenna Factor + Cable Loss- Preamp Factor
Margin value = Emission level – Limit value.
2. 5240MHz: Fundamental frequency.



802.11n (20MHz)

CHANNEL	TX Channel 36	DETECTOR FUNCTION	Peak (PK)
FREQUENCY RANGE	1GHz ~ 40GHz		Average (AV)

ANTENNA POLARITY & TEST DISTANCE: HORIZONTAL AT 3 M										
FREQ. (MHz)	EMISSION LEVEL (dBuV/m)	READ LEVEL (dBuV)	LIMIT (dBuV/m)	MARGIN (dB)	ANTENNA FACTOR (dB /m)	CABLE LOSS (dB)	PREAMP FACTOR (dB)	ANTENNA HEIGHT (cm)	TABLE ANGLE (Degree)	REMARK
5150	42.81	40.83	54	-11.19	34.48	13.71	46.21	100	356	Average
5150	54.31	52.33	74	-19.69	34.48	13.71	46.21	100	356	Peak
5180	91.78	89.69			34.52	13.79	46.22	100	356	Average
5180	100.2	98.11			34.52	13.79	46.22	100	356	Peak
5350	42.62	39.87	54	-11.38	34.72	14.28	46.25	100	356	Average
5350	53.99	51.24	74	-20.01	34.72	14.28	46.25	100	356	Peak

ANTENNA POLARITY & TEST DISTANCE: VERTICAL AT 3 M										
FREQ. (MHz)	EMISSION LEVEL (dBuV/m)	READ LEVEL (dBuV)	LIMIT (dBuV/m)	MARGIN (dB)	ANTENNA FACTOR (dB /m)	CABLE LOSS (dB)	PREAMP FACTOR (dB)	ANTENNA HEIGHT (cm)	TABLE ANGLE (Degree)	REMARK
5150	43.16	41.18	54	-10.84	34.48	13.71	46.21	118	276	Average
5150	55.22	53.24	74	-18.78	34.48	13.71	46.21	118	276	Peak
5180	94.95	92.86			34.52	13.79	46.22	118	276	Average
5180	103.79	101.7			34.52	13.79	46.22	118	276	Peak
5350	41.97	39.22	54	-12.03	34.72	14.28	46.25	118	276	Average
5350	54.09	51.34	74	-19.91	34.72	14.28	46.25	118	276	Peak

REMARKS:

1. Emission Level = Read Level+ Antenna Factor + Cable Loss- Preamp Factor
Margin value = Emission level – Limit value.
2. 5180MHz: Fundamental frequency.



CHANNEL	TX Channel 40	DETECTOR FUNCTION	Peak (PK)
FREQUENCY RANGE	1GHz ~ 40GHz		Average (AV)

ANTENNA POLARITY & TEST DISTANCE: HORIZONTAL AT 3 M

FREQ. (MHz)	EMISSION LEVEL (dBuV/m)	READ LEVEL (dBuV)	LIMIT (dBuV/m)	MARGIN (dB)	ANTENNA FACTOR (dB /m)	CABLE LOSS (dB)	PREAMP FACTOR (dB)	ANTENNA HEIGHT (cm)	TABLE ANGLE (Degree)	REMARK
5150	42.74	40.76	54	-11.26	34.48	13.71	46.21	100	356	Average
5150	54.3	52.32	74	-19.7	34.48	13.71	46.21	100	356	Peak
5200	91.74	89.57			34.54	13.85	46.22	100	356	Average
5200	100.41	98.24			34.54	13.85	46.22	100	356	Peak
5350	42.97	40.22	54	-11.03	34.72	14.28	46.25	100	356	Average
5350	54	51.25	74	-20	34.72	14.28	46.25	100	356	Peak

ANTENNA POLARITY & TEST DISTANCE: VERTICAL AT 3 M

FREQ. (MHz)	EMISSION LEVEL (dBuV/m)	READ LEVEL (dBuV)	LIMIT (dBuV/m)	MARGIN (dB)	ANTENNA FACTOR (dB /m)	CABLE LOSS (dB)	PREAMP FACTOR (dB)	ANTENNA HEIGHT (cm)	TABLE ANGLE (Degree)	REMARK
5150	42.8	40.82	54	-11.2	34.48	13.71	46.21	118	277	Average
5150	54.22	52.24	74	-19.78	34.48	13.71	46.21	118	277	Peak
5200	94.22	92.05			34.54	13.85	46.22	118	277	Average
5200	103.01	100.84			34.54	13.85	46.22	118	277	Peak
5350	42.52	39.77	54	-11.48	34.72	14.28	46.25	118	277	Average
5350	53.98	51.23	74	-20.02	34.72	14.28	46.25	118	277	Peak

REMARKS:

1. Emission Level = Read Level+ Antenna Factor + Cable Loss- Preamp Factor
Margin value = Emission level – Limit value.
2. 5200MHz: Fundamental frequency.



CHANNEL	TX Channel 48	DETECTOR FUNCTION	Peak (PK)
FREQUENCY RANGE	1GHz ~ 40GHz		Average (AV)

ANTENNA POLARITY & TEST DISTANCE: HORIZONTAL AT 3 M

FREQ. (MHz)	EMISSION LEVEL (dBuV/m)	READ LEVEL (dBuV)	LIMIT (dBuV/m)	MARGIN (dB)	ANTENNA FACTOR (dB /m)	CABLE LOSS (dB)	PREAMP FACTOR (dB)	ANTENNA HEIGHT (cm)	TABLE ANGLE (Degree)	REMARK
5150	42.83	40.85	54	-11.17	34.48	13.71	46.21	100	335	Average
5150	53.84	51.86	74	-20.16	34.48	13.71	46.21	100	335	Peak
5240	92.25	89.92			34.59	13.97	46.23	100	335	Average
5240	101.16	98.83			34.59	13.97	46.23	100	335	Peak
5350	42.32	39.57	54	-11.68	34.72	14.28	46.25	100	335	Average
5350	53.99	51.24	74	-20.01	34.72	14.28	46.25	100	335	Peak

ANTENNA POLARITY & TEST DISTANCE: VERTICAL AT 3 M

FREQ. (MHz)	EMISSION LEVEL (dBuV/m)	READ LEVEL (dBuV)	LIMIT (dBuV/m)	MARGIN (dB)	ANTENNA FACTOR (dB /m)	CABLE LOSS (dB)	PREAMP FACTOR (dB)	ANTENNA HEIGHT (cm)	TABLE ANGLE (Degree)	REMARK
5150	42.4	40.42	54	-11.6	34.48	13.71	46.21	125	277	Average
5150	53.22	51.24	74	-20.78	34.48	13.71	46.21	125	277	Peak
5240	95.19	92.86			34.59	13.97	46.23	125	277	Average
5240	103.38	101.05			34.59	13.97	46.23	125	277	Peak
5350	42.43	39.68	54	-11.57	34.72	14.28	46.25	125	277	Average
5350	53.8	51.05	74	-20.2	34.72	14.28	46.25	125	277	Peak

REMARKS:

1. Emission Level = Read Level+ Antenna Factor + Cable Loss- Preamp Factor
Margin value = Emission level – Limit value.
2. 5240MHz: Fundamental frequency.



802.11n (40MHz)

CHANNEL	TX Channel 38	DETECTOR FUNCTION	Peak (PK)
FREQUENCY RANGE	1GHz ~ 40GHz		Average (AV)

ANTENNA POLARITY & TEST DISTANCE: HORIZONTAL AT 3 M

FREQ. (MHz)	EMISSION LEVEL (dBuV/m)	READ LEVEL (dBuV)	LIMIT (dBuV/m)	MARGIN (dB)	ANTENNA FACTOR (dB /m)	CABLE LOSS (dB)	PREAMP FACTOR (dB)	ANTENNA HEIGHT (cm)	TABLE ANGLE (Degree)	REMARK
5150	46.85	44.87	54	-7.15	34.48	13.71	46.21	181	318	Average
5150	57.4	55.42	74	-16.6	34.48	13.71	46.21	181	318	Peak
5190	91.24	89.11			34.53	13.82	46.22	181	318	Average
5190	100.9	98.77			34.53	13.82	46.22	181	318	Peak
5350	42.77	40.02	54	-11.23	34.72	14.28	46.25	181	318	Average
5350	53.99	51.24	74	-20.01	34.72	14.28	46.25	181	318	Peak

ANTENNA POLARITY & TEST DISTANCE: VERTICAL AT 3 M

FREQ. (MHz)	EMISSION LEVEL (dBuV/m)	READ LEVEL (dBuV)	LIMIT (dBuV/m)	MARGIN (dB)	ANTENNA FACTOR (dB /m)	CABLE LOSS (dB)	PREAMP FACTOR (dB)	ANTENNA HEIGHT (cm)	TABLE ANGLE (Degree)	REMARK
5150	49.3	47.32	54	-4.7	34.48	13.71	46.21	198	318	Average
5150	58.6	56.62	74	-15.4	34.48	13.71	46.21	198	318	Peak
5190	94.9	92.77			34.53	13.82	46.22	198	318	Average
5190	103.03	100.9			34.53	13.82	46.22	198	318	Peak
5350	42.99	40.24	54	-11.01	34.72	14.28	46.25	198	318	Average
5350	54.41	51.66	74	-19.59	34.72	14.28	46.25	198	318	Peak

REMARKS:

- Emission Level = Read Level+ Antenna Factor + Cable Loss- Preamp Factor
Margin value = Emission level – Limit value.
- 5190MHz: Fundamental frequency.



CHANNEL	TX Channel 46	DETECTOR FUNCTION	Peak (PK)
FREQUENCY RANGE	1GHz ~ 40GHz		Average (AV)

ANTENNA POLARITY & TEST DISTANCE: HORIZONTAL AT 3 M										
FREQ. (MHz)	EMISSION LEVEL (dBuV/m)	READ LEVEL (dBuV)	LIMIT (dBuV/m)	MARGIN (dB)	ANTENNA FACTOR (dB /m)	CABLE LOSS (dB)	PREAMP FACTOR (dB)	ANTENNA HEIGHT (cm)	TABLE ANGLE (Degree)	REMARK
5150	43.23	41.25	54	-10.77	34.48	13.71	46.21	181	318	Average
5150	55.33	53.35	74	-18.67	34.48	13.71	46.21	181	318	Peak
5230	91.92	89.63			34.58	13.94	46.23	181	318	Average
5230	100.97	98.68			34.58	13.94	46.23	181	318	Peak
5350	42.62	39.87	54	-11.38	34.72	14.28	46.25	181	318	Average
5350	54.62	51.87	74	-19.38	34.72	14.28	46.25	181	318	Peak

ANTENNA POLARITY & TEST DISTANCE: VERTICAL AT 3 M										
FREQ. (MHz)	EMISSION LEVEL (dBuV/m)	READ LEVEL (dBuV)	LIMIT (dBuV/m)	MARGIN (dB)	ANTENNA FACTOR (dB /m)	CABLE LOSS (dB)	PREAMP FACTOR (dB)	ANTENNA HEIGHT (cm)	TABLE ANGLE (Degree)	REMARK
5150	43.22	41.24	54	-10.78	34.48	13.71	46.21	195	318	Average
5150	55.22	53.24	74	-18.78	34.48	13.71	46.21	195	318	Peak
5230	95.05	92.76			34.58	13.94	46.23	195	318	Average
5230	103.9	101.61			34.58	13.94	46.23	195	318	Peak
5350	43.28	40.53	54	-10.72	34.72	14.28	46.25	195	318	Average
5350	54.12	51.37	74	-19.88	34.72	14.28	46.25	195	318	Peak

REMARKS:

1. Emission Level = Read Level+ Antenna Factor + Cable Loss- Preamp Factor
Margin value = Emission level – Limit value.
2. 5230MHz: Fundamental frequency.



**Band 2
802.11a**

CHANNEL	TX Channel 52	DETECTOR FUNCTION	Peak (PK)
FREQUENCY RANGE	1GHz ~ 40GHz		Average (AV)

ANTENNA POLARITY & TEST DISTANCE: HORIZONTAL AT 3 M										
FREQ. (MHz)	EMISSION LEVEL (dBuV/m)	READ LEVEL (dBuV)	LIMIT (dBuV/m)	MARGIN (dB)	ANTENNA FACTOR (dB /m)	CABLE LOSS (dB)	PREAMP FACTOR (dB)	ANTENNA HEIGHT (cm)	TABLE ANGLE (Degree)	REMARK
5150	42.5	40.52	54	-11.5	34.48	13.71	46.21	100	335	Average
5150	53.26	51.28	74	-20.74	34.48	13.71	46.21	100	335	Peak
5260	92.26	89.86			34.61	14.02	46.23	100	335	Average
5260	100.56	98.16			34.61	14.02	46.23	100	335	Peak
5350	42.62	39.87	54	-11.38	34.72	14.28	46.25	100	335	Average
5350	55.09	52.34	74	-18.91	34.72	14.28	46.25	100	335	Peak

ANTENNA POLARITY & TEST DISTANCE: VERTICAL AT 3 M										
FREQ. (MHz)	EMISSION LEVEL (dBuV/m)	READ LEVEL (dBuV)	LIMIT (dBuV/m)	MARGIN (dB)	ANTENNA FACTOR (dB /m)	CABLE LOSS (dB)	PREAMP FACTOR (dB)	ANTENNA HEIGHT (cm)	TABLE ANGLE (Degree)	REMARK
5150	42.33	40.35	54	-11.67	34.48	13.71	46.21	125	277	Average
5150	54.03	52.05	74	-19.97	34.48	13.71	46.21	125	277	Peak
5260	96.08	93.68			34.61	14.02	46.23	125	277	Average
5260	104.27	101.87			34.61	14.02	46.23	125	277	Peak
5350	42.62	39.87	54	-11.38	34.72	14.28	46.25	125	277	Average
5350	54.43	51.68	74	-19.57	34.72	14.28	46.25	125	277	Peak

REMARKS:

1. Emission Level = Read Level+ Antenna Factor + Cable Loss- Preamp Factor
Margin value = Emission level – Limit value.
2. 5260MHz: Fundamental frequency.



CHANNEL	TX Channel 60	DETECTOR FUNCTION	Peak (PK)
FREQUENCY RANGE	1GHz ~ 40GHz		Average (AV)

ANTENNA POLARITY & TEST DISTANCE: HORIZONTAL AT 3 M

FREQ. (MHz)	EMISSION LEVEL (dBuV/m)	READ LEVEL (dBuV)	LIMIT (dBuV/m)	MARGIN (dB)	ANTENNA FACTOR (dB /m)	CABLE LOSS (dB)	PREAMP FACTOR (dB)	ANTENNA HEIGHT (cm)	TABLE ANGLE (Degree)	REMARK
5150	42.51	40.53	54	-11.49	34.48	13.71	46.21	100	335	Average
5150	54.09	52.11	74	-19.91	34.48	13.71	46.21	100	335	Peak
5300	92.21	89.65			34.66	14.14	46.24	100	335	Average
5300	100.42	97.86			34.66	14.14	46.24	100	335	Peak
5350	43.01	40.26	54	-10.99	34.72	14.28	46.25	100	335	Average
5350	55.97	53.22	74	-18.03	34.72	14.28	46.25	100	335	Peak

ANTENNA POLARITY & TEST DISTANCE: VERTICAL AT 3 M

FREQ. (MHz)	EMISSION LEVEL (dBuV/m)	READ LEVEL (dBuV)	LIMIT (dBuV/m)	MARGIN (dB)	ANTENNA FACTOR (dB /m)	CABLE LOSS (dB)	PREAMP FACTOR (dB)	ANTENNA HEIGHT (cm)	TABLE ANGLE (Degree)	REMARK
5150	42.45	40.47	54	-11.55	34.48	13.71	46.21	122	277	Average
5150	53.23	51.25	74	-20.77	34.48	13.71	46.21	122	277	Peak
5300	95.68	93.12			34.66	14.14	46.24	122	277	Average
5300	104.05	101.49			34.66	14.14	46.24	122	277	Peak
5350	43.69	40.94	54	-10.31	34.72	14.28	46.25	122	277	Average
5350	58.35	55.6	74	-15.65	34.72	14.28	46.25	122	277	Peak

REMARKS:

- Emission Level = Read Level+ Antenna Factor + Cable Loss- Preamp Factor
Margin value = Emission level – Limit value.
- 5300MHz: Fundamental frequency.



CHANNEL	TX Channel 64	DETECTOR FUNCTION	Peak (PK)
FREQUENCY RANGE	1GHz ~ 40GHz		Average (AV)

ANTENNA POLARITY & TEST DISTANCE: HORIZONTAL AT 3 M										
FREQ. (MHz)	EMISSION LEVEL (dBuV/m)	READ LEVEL (dBuV)	LIMIT (dBuV/m)	MARGIN (dB)	ANTENNA FACTOR (dB /m)	CABLE LOSS (dB)	PREAMP FACTOR (dB)	ANTENNA HEIGHT (cm)	TABLE ANGLE (Degree)	REMARK
5150	42.51	40.53	54	-11.49	34.48	13.71	46.21	100	335	Average
5150	53.52	51.54	74	-20.48	34.48	13.71	46.21	100	335	Peak
5320	91.16	88.52			34.68	14.2	46.24	100	335	Average
5320	99.2	96.56			34.68	14.2	46.24	100	335	Peak
5350	42.98	40.23	54	-11.02	34.72	14.28	46.25	100	335	Average
5350	55.11	52.36	74	-18.89	34.72	14.28	46.25	100	335	Peak

ANTENNA POLARITY & TEST DISTANCE: VERTICAL AT 3 M										
FREQ. (MHz)	EMISSION LEVEL (dBuV/m)	READ LEVEL (dBuV)	LIMIT (dBuV/m)	MARGIN (dB)	ANTENNA FACTOR (dB /m)	CABLE LOSS (dB)	PREAMP FACTOR (dB)	ANTENNA HEIGHT (cm)	TABLE ANGLE (Degree)	REMARK
5150	42.33	40.35	54	-11.67	34.48	13.71	46.21	122	277	5132
5150	53.2	51.22	74	-20.8	34.48	13.71	46.21	122	277	5132
5320	95.86	93.22			34.68	14.2	46.24	122	277	5320
5320	103.86	101.22			34.68	14.2	46.24	122	277	5320
5350	43.28	40.53	54	-10.72	34.72	14.28	46.25	122	277	5372
5350	55.97	53.22	74	-18.03	34.72	14.28	46.25	122	277	5372

REMARKS:

- Emission Level = Read Level+ Antenna Factor + Cable Loss- Preamp Factor
Margin value = Emission level – Limit value.
- 5320MHz: Fundamental frequency.



802.11n (20MHz)

CHANNEL	TX Channel 52	DETECTOR FUNCTION	Peak (PK)
FREQUENCY RANGE	1GHz ~ 40GHz		Average (AV)

ANTENNA POLARITY & TEST DISTANCE: HORIZONTAL AT 3 M										
FREQ. (MHz)	EMISSION LEVEL (dBuV/m)	READ LEVEL (dBuV)	LIMIT (dBuV/m)	MARGIN (dB)	ANTENNA FACTOR (dB /m)	CABLE LOSS (dB)	PREAMP FACTOR (dB)	ANTENNA HEIGHT (cm)	TABLE ANGLE (Degree)	REMARK
5150	42.5	40.52	54	-11.5	34.48	13.71	46.21	125	19	Average
5150	53.54	51.56	74	-20.46	34.48	13.71	46.21	125	19	Peak
5260	92.33	89.93			34.61	14.02	46.23	125	19	Average
5260	101.27	98.87			34.61	14.02	46.23	125	19	Peak
5350	42.62	39.87	54	-11.38	34.72	14.28	46.25	125	19	Average
5350	54	51.25	74	-20	34.72	14.28	46.25	125	19	Peak

ANTENNA POLARITY & TEST DISTANCE: VERTICAL AT 3 M										
FREQ. (MHz)	EMISSION LEVEL (dBuV/m)	READ LEVEL (dBuV)	LIMIT (dBuV/m)	MARGIN (dB)	ANTENNA FACTOR (dB /m)	CABLE LOSS (dB)	PREAMP FACTOR (dB)	ANTENNA HEIGHT (cm)	TABLE ANGLE (Degree)	REMARK
5150	42.51	40.53	54	-11.49	34.48	13.71	46.21	125	277	Average
5150	54.3	52.32	74	-19.7	34.48	13.71	46.21	125	277	Peak
5260	94.97	92.57			34.61	14.02	46.23	125	277	Average
5260	103.73	101.33			34.61	14.02	46.23	125	277	Peak
5350	42.62	39.87	54	-11.38	34.72	14.28	46.25	125	277	Average
5350	53.99	51.24	74	-20.01	34.72	14.28	46.25	125	277	Peak

REMARKS:

- Emission Level = Read Level+ Antenna Factor + Cable Loss- Preamp Factor
Margin value = Emission level – Limit value.
- 5260MHz: Fundamental frequency.



CHANNEL	TX Channel 60	DETECTOR FUNCTION	Peak (PK)
FREQUENCY RANGE	1GHz ~ 40GHz		Average (AV)

ANTENNA POLARITY & TEST DISTANCE: HORIZONTAL AT 3 M

FREQ. (MHz)	EMISSION LEVEL (dBuV/m)	READ LEVEL (dBuV)	LIMIT (dBuV/m)	MARGIN (dB)	ANTENNA FACTOR (dB /m)	CABLE LOSS (dB)	PREAMP FACTOR (dB)	ANTENNA HEIGHT (cm)	TABLE ANGLE (Degree)	REMARK
5150	41.81	39.83	54	-12.19	34.48	13.71	46.21	110	27	Average
5150	53.22	51.24	74	-20.78	34.48	13.71	46.21	110	27	Peak
5300	92.15	89.59			34.66	14.14	46.24	110	27	Average
5300	100.77	98.21			34.66	14.14	46.24	110	27	Peak
5350	42.62	39.87	54	-11.38	34.72	14.28	46.25	110	27	Average
5350	55.11	52.36	74	-18.89	34.72	14.28	46.25	110	27	Peak

ANTENNA POLARITY & TEST DISTANCE: VERTICAL AT 3 M

FREQ. (MHz)	EMISSION LEVEL (dBuV/m)	READ LEVEL (dBuV)	LIMIT (dBuV/m)	MARGIN (dB)	ANTENNA FACTOR (dB /m)	CABLE LOSS (dB)	PREAMP FACTOR (dB)	ANTENNA HEIGHT (cm)	TABLE ANGLE (Degree)	REMARK
5150	42.11	40.13	54	-11.89	34.48	13.71	46.21	150	273	Average
5150	53.22	51.24	74	-20.78	34.48	13.71	46.21	150	273	Peak
5300	95.03	92.47			34.66	14.14	46.24	150	273	Average
5300	103.42	100.86			34.66	14.14	46.24	150	273	Peak
5350	43.99	41.24	54	-10.01	34.72	14.28	46.25	150	273	Average
5350	55.44	52.69	74	-18.56	34.72	14.28	46.25	150	273	Peak

REMARKS:

- Emission Level = Read Level+ Antenna Factor + Cable Loss- Preamp Factor
Margin value = Emission level – Limit value.
- 5300MHz: Fundamental frequency.



CHANNEL	TX Channel 64	DETECTOR FUNCTION	Peak (PK)
FREQUENCY RANGE	1GHz ~ 40GHz		Average (AV)

ANTENNA POLARITY & TEST DISTANCE: HORIZONTAL AT 3 M										
FREQ. (MHz)	EMISSION LEVEL (dBuV/m)	READ LEVEL (dBuV)	LIMIT (dBuV/m)	MARGIN (dB)	ANTENNA FACTOR (dB /m)	CABLE LOSS (dB)	PREAMP FACTOR (dB)	ANTENNA HEIGHT (cm)	TABLE ANGLE (Degree)	REMARK
5150	41.85	39.87	54	-12.15	34.48	13.71	46.21	110	27	Average
5150	53.22	51.24	74	-20.78	34.48	13.71	46.21	110	27	Peak
5320	91.76	89.12			34.68	14.2	46.24	110	27	Average
5320	101.17	98.53			34.68	14.2	46.24	110	27	Peak
5350	42.24	39.49	54	-11.76	34.72	14.28	46.25	110	27	Average
5350	56	53.25	74	-18	34.72	14.28	46.25	110	27	Peak

ANTENNA POLARITY & TEST DISTANCE: VERTICAL AT 3 M										
FREQ. (MHz)	EMISSION LEVEL (dBuV/m)	READ LEVEL (dBuV)	LIMIT (dBuV/m)	MARGIN (dB)	ANTENNA FACTOR (dB /m)	CABLE LOSS (dB)	PREAMP FACTOR (dB)	ANTENNA HEIGHT (cm)	TABLE ANGLE (Degree)	REMARK
5150	41.9	39.92	54	-12.1	34.48	13.71	46.21	150	273	Average
5150	53.53	51.55	74	-20.47	34.48	13.71	46.21	150	273	Peak
5320	94.95	92.31			34.68	14.2	46.24	150	273	Average
5320	103.88	101.24			34.68	14.2	46.24	150	273	Peak
5350	43.65	40.9	54	-10.35	34.72	14.28	46.25	150	273	Average
5350	55.99	53.24	74	-18.01	34.72	14.28	46.25	150	273	Peak

REMARKS:

- Emission Level = Read Level+ Antenna Factor + Cable Loss- Preamp Factor
Margin value = Emission level – Limit value.
- 5320MHz: Fundamental frequency.



802.11n (40MHz)

CHANNEL	TX Channel 54	DETECTOR FUNCTION	Peak (PK)
FREQUENCY RANGE	1GHz ~ 40GHz		Average (AV)

ANTENNA POLARITY & TEST DISTANCE: HORIZONTAL AT 3 M

FREQ. (MHz)	EMISSION LEVEL (dBuV/m)	READ LEVEL (dBuV)	LIMIT (dBuV/m)	MARGIN (dB)	ANTENNA FACTOR (dB /m)	CABLE LOSS (dB)	PREAMP FACTOR (dB)	ANTENNA HEIGHT (cm)	TABLE ANGLE (Degree)	REMARK
5150	42.91	40.93	54	-11.09	34.48	13.71	46.21	181	318	Average
5150	52.84	50.86	74	-21.16	34.48	13.71	46.21	181	318	Peak
5270	91.56	89.12			34.62	14.05	46.23	181	318	Average
5270	100.37	97.93			34.62	14.05	46.23	181	318	Peak
5350	43.64	40.89	54	-10.36	34.72	14.28	46.25	181	318	Average
5350	56.41	53.66	74	-17.59	34.72	14.28	46.25	181	318	Peak

ANTENNA POLARITY & TEST DISTANCE: VERTICAL AT 3 M

FREQ. (MHz)	EMISSION LEVEL (dBuV/m)	READ LEVEL (dBuV)	LIMIT (dBuV/m)	MARGIN (dB)	ANTENNA FACTOR (dB /m)	CABLE LOSS (dB)	PREAMP FACTOR (dB)	ANTENNA HEIGHT (cm)	TABLE ANGLE (Degree)	REMARK
5150	42.85	40.87	54	-11.15	34.48	13.71	46.21	195	318	Average
5150	53.22	51.24	74	-20.78	34.48	13.71	46.21	195	318	Peak
5270	95.21	92.77			34.62	14.05	46.23	195	318	Average
5270	104.03	101.59			34.62	14.05	46.23	195	318	Peak
5350	45.52	42.77	54	-8.48	34.72	14.28	46.25	195	318	Average
5350	55.97	53.22	74	-18.03	34.72	14.28	46.25	195	318	Peak

REMARKS:

1. Emission Level = Read Level+ Antenna Factor + Cable Loss- Preamp Factor
Margin value = Emission level – Limit value.
2. 5270MHz: Fundamental frequency.



**BUREAU
VERITAS**

Test Report No.: RF180131W003-7

CHANNEL	TX Channel 62	DETECTOR FUNCTION	Peak (PK)
FREQUENCY RANGE	1GHz ~ 40GHz		Average (AV)

ANTENNA POLARITY & TEST DISTANCE: HORIZONTAL AT 3 M

FREQ. (MHz)	EMISSION LEVEL (dBuV/m)	READ LEVEL (dBuV)	LIMIT (dBuV/m)	MARGIN (dB)	ANTENNA FACTOR (dB /m)	CABLE LOSS (dB)	PREAMP FACTOR (dB)	ANTENNA HEIGHT (cm)	TABLE ANGLE (Degree)	REMARK
5150	42.91	40.93	54	-11.09	34.48	13.71	46.21	181	318	Average
5150	53.02	51.04	74	-20.98	34.48	13.71	46.21	181	318	Peak
5310	91.43	88.83			34.67	14.17	46.24	181	318	Average
5310	100.65	98.05			34.67	14.17	46.24	181	318	Peak
5350	46.93	44.18	54	-7.07	34.72	14.28	46.25	181	318	Average
5350	55.97	53.22	74	-18.03	34.72	14.28	46.25	181	318	Peak

ANTENNA POLARITY & TEST DISTANCE: VERTICAL AT 3 M

FREQ. (MHz)	EMISSION LEVEL (dBuV/m)	READ LEVEL (dBuV)	LIMIT (dBuV/m)	MARGIN (dB)	ANTENNA FACTOR (dB /m)	CABLE LOSS (dB)	PREAMP FACTOR (dB)	ANTENNA HEIGHT (cm)	TABLE ANGLE (Degree)	REMARK
5150	42.62	40.64	54	-11.38	34.48	13.71	46.21	195	318	Average
5150	53.31	51.33	74	-20.69	34.48	13.71	46.21	195	318	Peak
5310	95.16	92.56			34.67	14.17	46.24	195	318	Average
5310	104.16	101.56			34.67	14.17	46.24	195	318	Peak
5350	51.97	49.22	54	-2.03	34.72	14.28	46.25	195	318	Average
5350	60.08	57.33	74	-13.92	34.72	14.28	46.25	195	318	Peak

REMARKS:

- Emission Level = Read Level+ Antenna Factor + Cable Loss- Preamp Factor
Margin value = Emission level – Limit value.
- 5310MHz: Fundamental frequency.



Band 3

802.11a

CHANNEL	TX Channel 100	DETECTOR FUNCTION	Peak (PK)
FREQUENCY RANGE	1GHz ~ 40GHz		Average (AV)

ANTENNA POLARITY & TEST DISTANCE: HORIZONTAL AT 3 M										
FREQ. (MHz)	EMISSION LEVEL (dBuV/m)	READ LEVEL (dBuV)	LIMIT (dBuV/m)	MARGIN (dB)	ANTENNA FACTOR (dB /m)	CABLE LOSS (dB)	PREAMP FACTOR (dB)	ANTENNA HEIGHT (cm)	TABLE ANGLE (Degree)	REMARK
5460	43.15	39.97	54	-10.85	34.85	14.6	46.27	100	353	Average
5460	58.5	55.32	74	-15.5	34.85	14.6	46.27	100	353	Peak
#5470	59.65	56.44	68.30	-8.65	34.86	14.62	46.27	100	353	Peak
5500	97.21	93.88			34.9	14.71	46.28	100	353	Average
5500	105.2	101.87			34.9	14.71	46.28	100	353	Peak

ANTENNA POLARITY & TEST DISTANCE: VERTICAL AT 3 M										
FREQ. (MHz)	EMISSION LEVEL (dBuV/m)	READ LEVEL (dBuV)	LIMIT (dBuV/m)	MARGIN (dB)	ANTENNA FACTOR (dB /m)	CABLE LOSS (dB)	PREAMP FACTOR (dB)	ANTENNA HEIGHT (cm)	TABLE ANGLE (Degree)	REMARK
5460	42.85	39.67	54	-11.15	34.85	14.6	46.27	122	277	Average
5460	57.2	54.02	74	-16.8	34.85	14.6	46.27	122	277	Peak
#5470	59.51	56.3	68.30	-8.79	34.86	14.62	46.27	122	277	Peak
5500	96.22	92.89			34.9	14.71	46.28	122	277	Average
5500	104.57	101.24			34.9	14.71	46.28	122	277	Peak

REMARKS:

1. Emission Level = Read Level+ Antenna Factor + Cable Loss- Preamp Factor
Margin value = Emission level – Limit value.
2. 5500MHz: Fundamental frequency.
3. #: Out of restricted band.



CHANNEL	TX Channel 116	DETECTOR FUNCTION	Peak (PK)
FREQUENCY RANGE	1GHz ~ 40GHz		Average (AV)

ANTENNA POLARITY & TEST DISTANCE: HORIZONTAL AT 3 M

FREQ. (MHz)	EMISSION LEVEL (dBuV/m)	READ LEVEL (dBuV)	LIMIT (dBuV/m)	MARGIN (dB)	ANTENNA FACTOR (dB /m)	CABLE LOSS (dB)	PREAMP FACTOR (dB)	ANTENNA HEIGHT (cm)	TABLE ANGLE (Degree)	REMARK
5460	42.75	39.57	54	-11.25	34.85	14.6	46.27	100	353	Average
5460	53.9	50.72	74	-20.1	34.85	14.6	46.27	100	353	Peak
#5470	54.45	51.24	68.3	-13.85	34.86	14.62	46.27	100	353	Peak
5580	98.73	94.78			35	15.23	46.28	100	353	Average
5580	106.66	102.71			35	15.23	46.28	100	353	Peak

ANTENNA POLARITY & TEST DISTANCE: VERTICAL AT 3 M

FREQ. (MHz)	EMISSION LEVEL (dBuV/m)	READ LEVEL (dBuV)	LIMIT (dBuV/m)	MARGIN (dB)	ANTENNA FACTOR (dB /m)	CABLE LOSS (dB)	PREAMP FACTOR (dB)	ANTENNA HEIGHT (cm)	TABLE ANGLE (Degree)	REMARK
5460	42.75	39.57	54	-11.25	34.85	14.6	46.27	122	277	Average
5460	53.63	50.45	74	-20.37	34.85	14.6	46.27	122	277	Peak
#5470	54.46	51.25	68.3	-13.84	34.86	14.62	46.27	122	277	Peak
5580	98.88	94.93			35	15.23	46.28	122	277	Average
5580	107.14	103.19			35	15.23	46.28	122	277	Peak

REMARKS:

1. Emission Level = Read Level+ Antenna Factor + Cable Loss- Preamp Factor
Margin value = Emission level – Limit value.
2. 5580MHz: Fundamental frequency.
3. #: Out of restricted band.



CHANNEL	TX Channel 140	DETECTOR FUNCTION	Peak (PK)
FREQUENCY RANGE	1GHz ~ 40GHz		Average (AV)

ANTENNA POLARITY & TEST DISTANCE: HORIZONTAL AT 3 M										
FREQ. (MHz)	EMISSION LEVEL (dBuV/m)	READ LEVEL (dBuV)	LIMIT (dBuV/m)	MARGIN (dB)	ANTENNA FACTOR (dB /m)	CABLE LOSS (dB)	PREAMP FACTOR (dB)	ANTENNA HEIGHT (cm)	TABLE ANGLE (Degree)	REMARK
5700	97.44	92.57			35.14	16.01	46.28	103	360	Average
5700	105.06	100.19			35.14	16.01	46.28	103	360	Peak
#5725	61.44	56.37	68.30	-6.86	35.17	16.18	46.28	103	360	Peak
ANTENNA POLARITY & TEST DISTANCE: VERTICAL AT 3 M										
FREQ. (MHz)	EMISSION LEVEL (dBuV/m)	READ LEVEL (dBuV)	LIMIT (dBuV/m)	MARGIN (dB)	ANTENNA FACTOR (dB /m)	CABLE LOSS (dB)	PREAMP FACTOR (dB)	ANTENNA HEIGHT (cm)	TABLE ANGLE (Degree)	REMARK
5700	98.46	93.59			35.14	16.01	46.28	120	277	Average
5700	106.65	101.78			35.14	16.01	46.28	120	277	Peak
#5725	63.86	58.79	68.30	-4.44	35.17	16.18	46.28	120	277	Peak

REMARKS:

1. Emission Level = Read Level+ Antenna Factor + Cable Loss- Preamp Factor
Margin value = Emission level – Limit value.
2. 5700MHz: Fundamental frequency.
3. #: Out of restricted band.



802.11n (20MHz)

CHANNEL	TX Channel 100	DETECTOR FUNCTION	Peak (PK)
FREQUENCY RANGE	1GHz ~ 40GHz		Average (AV)

ANTENNA POLARITY & TEST DISTANCE: HORIZONTAL AT 3 M										
FREQ. (MHz)	EMISSION LEVEL (dBuV/m)	READ LEVEL (dBuV)	LIMIT (dBuV/m)	MARGIN (dB)	ANTENNA FACTOR (dB /m)	CABLE LOSS (dB)	PREAMP FACTOR (dB)	ANTENNA HEIGHT (cm)	TABLE ANGLE (Degree)	REMARK
5460	42.39	39.21	54	-11.61	34.85	14.6	46.27	105	45	Average
5460	54.42	51.24	74	-19.58	34.85	14.6	46.27	105	45	Peak
#5470	56.86	53.65	68.30	-11.44	34.86	14.62	46.27	105	45	Peak
5500	94.9	91.57			34.9	14.71	46.28	105	45	Average
5500	102.95	99.62			34.9	14.71	46.28	105	45	Peak

ANTENNA POLARITY & TEST DISTANCE: VERTICAL AT 3 M										
FREQ. (MHz)	EMISSION LEVEL (dBuV/m)	READ LEVEL (dBuV)	LIMIT (dBuV/m)	MARGIN (dB)	ANTENNA FACTOR (dB /m)	CABLE LOSS (dB)	PREAMP FACTOR (dB)	ANTENNA HEIGHT (cm)	TABLE ANGLE (Degree)	REMARK
5460	43	39.82	54	-11	34.85	14.6	46.27	145	273	Average
5460	54.75	51.57	74	-19.25	34.85	14.6	46.27	145	273	Peak
#5470	55.79	52.58	68.30	-12.51	34.86	14.62	46.27	145	273	Peak
5500	97.08	93.75			34.9	14.71	46.28	145	273	Average
5500	105.87	102.54			34.9	14.71	46.28	145	273	Peak

REMARKS:

- Emission Level = Read Level+ Antenna Factor + Cable Loss- Preamp Factor
Margin value = Emission level – Limit value.
- 5500MHz: Fundamental frequency.
- #: Out of restricted band.



CHANNEL	TX Channel 116	DETECTOR FUNCTION	Peak (PK)
FREQUENCY RANGE	1GHz ~ 40GHz		Average (AV)

ANTENNA POLARITY & TEST DISTANCE: HORIZONTAL AT 3 M										
FREQ. (MHz)	EMISSION LEVEL (dBuV/m)	READ LEVEL (dBuV)	LIMIT (dBuV/m)	MARGIN (dB)	ANTENNA FACTOR (dB /m)	CABLE LOSS (dB)	PREAMP FACTOR (dB)	ANTENNA HEIGHT (cm)	TABLE ANGLE (Degree)	REMARK
5460	42.42	39.24	54	-11.58	34.85	14.6	46.27	105	45	Average
5460	54.53	51.35	74	-19.47	34.85	14.6	46.27	105	45	Peak
#5470	56.43	53.22	68.30	-11.87	34.86	14.62	46.27	105	45	Peak
5580	95.81	91.86			35	15.23	46.28	105	45	Average
5580	104.35	100.4			35	15.23	46.28	105	45	Peak

ANTENNA POLARITY & TEST DISTANCE: VERTICAL AT 3 M										
FREQ. (MHz)	EMISSION LEVEL (dBuV/m)	READ LEVEL (dBuV)	LIMIT (dBuV/m)	MARGIN (dB)	ANTENNA FACTOR (dB /m)	CABLE LOSS (dB)	PREAMP FACTOR (dB)	ANTENNA HEIGHT (cm)	TABLE ANGLE (Degree)	REMARK
5460	42.42	39.24	54	-11.58	34.85	14.6	46.27	151	273	Average
5460	55.5	52.32	74	-18.5	34.85	14.6	46.27	151	273	Peak
#5470	57.27	54.06	68.30	-11.03	34.86	14.62	46.27	151	273	Peak
5580	98.19	94.24			35	15.23	46.28	151	273	Average
5580	107.1	103.15			35	15.23	46.28	151	273	Peak

REMARKS:

1. Emission Level = Read Level+ Antenna Factor + Cable Loss- Preamp Factor
Margin value = Emission level – Limit value.
2. 5580MHz: Fundamental frequency.
3. #: Out of restricted band.



CHANNEL	TX Channel 140	DETECTOR FUNCTION	Peak (PK)
FREQUENCY RANGE	1GHz ~ 40GHz		Average (AV)

ANTENNA POLARITY & TEST DISTANCE: HORIZONTAL AT 3 M										
FREQ. (MHz)	EMISSION LEVEL (dBuV/m)	READ LEVEL (dBuV)	LIMIT (dBuV/m)	MARGIN (dB)	ANTENNA FACTOR (dB /m)	CABLE LOSS (dB)	PREAMP FACTOR (dB)	ANTENNA HEIGHT (cm)	TABLE ANGLE (Degree)	REMARK
5700	95.74	90.87			35.14	16.01	46.28	100	45	Average
5700	104.53	99.66			35.14	16.01	46.28	100	45	Peak
#5725	58.27	53.2	68.30	-10.03	35.17	16.18	46.28	100	45	Peak
ANTENNA POLARITY & TEST DISTANCE: VERTICAL AT 3 M										
FREQ. (MHz)	EMISSION LEVEL (dBuV/m)	READ LEVEL (dBuV)	LIMIT (dBuV/m)	MARGIN (dB)	ANTENNA FACTOR (dB /m)	CABLE LOSS (dB)	PREAMP FACTOR (dB)	ANTENNA HEIGHT (cm)	TABLE ANGLE (Degree)	REMARK
5700	98.53	93.66			35.14	16.01	46.28	132	273	Average
5700	107.84	102.97			35.14	16.01	46.28	132	273	Peak
#5725	59.69	54.62	68.30	-8.61	35.17	16.18	46.28	132	273	Peak

REMARKS:

- Emission Level = Read Level+ Antenna Factor + Cable Loss- Preamp Factor
Margin value = Emission level – Limit value.
- 5700MHz: Fundamental frequency.
- #: Out of restricted band.



802.11n (40MHz)

CHANNEL	TX Channel 102	DETECTOR FUNCTION	Peak (PK)
FREQUENCY RANGE	1GHz ~ 40GHz		Average (AV)

ANTENNA POLARITY & TEST DISTANCE: HORIZONTAL AT 3 M										
FREQ. (MHz)	EMISSION LEVEL (dBuV/m)	READ LEVEL (dBuV)	LIMIT (dBuV/m)	MARGIN (dB)	ANTENNA FACTOR (dB /m)	CABLE LOSS (dB)	PREAMP FACTOR (dB)	ANTENNA HEIGHT (cm)	TABLE ANGLE (Degree)	REMARK
5460	44.32	41.14	54	-9.68	34.85	14.6	46.27	180	318	Peak
5460	57.42	54.24	74	-16.58	34.85	14.6	46.27	180	318	Average
#5470	62.18	58.97	68.30	-6.12	34.86	14.62	46.27	180	318	Peak
5510	91.73	88.32			34.91	14.78	46.28	180	318	Average
5510	100.94	97.53			34.91	14.78	46.28	180	318	Peak

ANTENNA POLARITY & TEST DISTANCE: VERTICAL AT 3 M										
FREQ. (MHz)	EMISSION LEVEL (dBuV/m)	READ LEVEL (dBuV)	LIMIT (dBuV/m)	MARGIN (dB)	ANTENNA FACTOR (dB /m)	CABLE LOSS (dB)	PREAMP FACTOR (dB)	ANTENNA HEIGHT (cm)	TABLE ANGLE (Degree)	REMARK
5460	49.41	46.23	54	-4.59	34.85	14.6	46.27	227	318	Average
5460	63.09	59.91	74	-10.91	34.85	14.6	46.27	227	318	Peak
#5470	67.22	64.01	68.30	-1.08	34.86	14.62	46.27	227	318	Peak
5510	98.62	95.21			34.91	14.78	46.28	227	318	Average
5510	106.91	103.5			34.91	14.78	46.28	227	318	Peak

REMARKS:

1. Emission Level = Read Level+ Antenna Factor + Cable Loss- Preamp Factor
Margin value = Emission level – Limit value.
2. 5510MHz: Fundamental frequency.
3. #: Out of restricted band.



CHANNEL	TX Channel 110	DETECTOR FUNCTION	Peak (PK)
FREQUENCY RANGE	1GHz ~ 40GHz		Average (AV)

ANTENNA POLARITY & TEST DISTANCE: HORIZONTAL AT 3 M

FREQ. (MHz)	EMISSION LEVEL (dBuV/m)	READ LEVEL (dBuV)	LIMIT (dBuV/m)	MARGIN (dB)	ANTENNA FACTOR (dB /m)	CABLE LOSS (dB)	PREAMP FACTOR (dB)	ANTENNA HEIGHT (cm)	TABLE ANGLE (Degree)	REMARK
5460	43.74	40.56	54	-10.26	34.85	14.6	46.27	179	318	Average
5460	56.85	53.67	74	-17.15	34.85	14.6	46.27	179	318	Peak
#5470	59.88	56.67	68.30	-8.42	34.86	14.62	46.27	179	318	Peak
5550	93.55	89.83			34.96	15.04	46.28	179	318	Average
5550	102.58	98.86			34.96	15.04	46.28	179	318	Peak

ANTENNA POLARITY & TEST DISTANCE: VERTICAL AT 3 M

FREQ. (MHz)	EMISSION LEVEL (dBuV/m)	READ LEVEL (dBuV)	LIMIT (dBuV/m)	MARGIN (dB)	ANTENNA FACTOR (dB /m)	CABLE LOSS (dB)	PREAMP FACTOR (dB)	ANTENNA HEIGHT (cm)	TABLE ANGLE (Degree)	REMARK
5460	44.04	40.86	54	-9.96	34.85	14.6	46.27	227	318	Average
5460	55.94	52.76	74	-18.06	34.85	14.6	46.27	227	318	Peak
#5470	58.63	55.42	68.30	-9.67	34.86	14.62	46.27	227	318	Peak
5550	99.77	96.05			34.96	15.04	46.28	227	318	Average
5550	108.11	104.39			34.96	15.04	46.28	227	318	Peak

REMARKS:

1. Emission Level = Read Level+ Antenna Factor + Cable Loss- Preamp Factor
Margin value = Emission level – Limit value.
2. 5550MHz: Fundamental frequency.
3. #: Out of restricted band.



CHANNEL	TX Channel 134	DETECTOR FUNCTION	Peak (PK)
FREQUENCY RANGE	1GHz ~ 40GHz		Average (AV)

ANTENNA POLARITY & TEST DISTANCE: HORIZONTAL AT 3 M										
FREQ. (MHz)	EMISSION LEVEL (dBuV/m)	READ LEVEL (dBuV)	LIMIT (dBuV/m)	MARGIN (dB)	ANTENNA FACTOR (dB /m)	CABLE LOSS (dB)	PREAMP FACTOR (dB)	ANTENNA HEIGHT (cm)	TABLE ANGLE (Degree)	REMARK
5670	93.38	88.74			35.1	15.82	46.28	181	318	Average
5670	102.98	98.34			35.1	15.82	46.28	181	318	Peak
#5725	59.42	54.35	68.30	-8.88	35.17	16.18	46.28	181	318	Peak
ANTENNA POLARITY & TEST DISTANCE: VERTICAL AT 3 M										
FREQ. (MHz)	EMISSION LEVEL (dBuV/m)	READ LEVEL (dBuV)	LIMIT (dBuV/m)	MARGIN (dB)	ANTENNA FACTOR (dB /m)	CABLE LOSS (dB)	PREAMP FACTOR (dB)	ANTENNA HEIGHT (cm)	TABLE ANGLE (Degree)	REMARK
5670	101.88	97.24			35.1	15.82	46.28	227	318	Average
5670	110.4	105.76			35.1	15.82	46.28	227	318	Peak
#5725	62.86	57.79	68.30	-5.44	35.17	16.18	46.28	227	318	Peak

REMARKS:

1. Emission Level = Read Level+ Antenna Factor + Cable Loss- Preamp Factor
Margin value = Emission level – Limit value.
2. 5670MHz: Fundamental frequency.
3. #: Out of restricted band.



Band 4

802.11a

CHANNEL	TX Channel 149	DETECTOR FUNCTION	Peak (PK)
FREQUENCY RANGE	1GHz ~ 40GHz		Average (AV)

ANTENNA POLARITY & TEST DISTANCE: HORIZONTAL AT 3 M										
FREQ. (MHz)	EMISSION LEVEL (dBuV/m)	READ LEVEL (dBuV)	LIMIT (dBuV/m)	MARGIN (dB)	ANTENNA FACTOR (dB /m)	CABLE LOSS (dB)	PREAMP FACTOR (dB)	ANTENNA HEIGHT (cm)	TABLE ANGLE (Degree)	REMARK
5745	98.08	92.86			35.19	16.31	46.28	100	311	Average
5745	105.87	100.65			35.19	16.31	46.28	100	311	Peak
ANTENNA POLARITY & TEST DISTANCE: VERTICAL AT 3 M										
FREQ. (MHz)	EMISSION LEVEL (dBuV/m)	READ LEVEL (dBuV)	LIMIT (dBuV/m)	MARGIN (dB)	ANTENNA FACTOR (dB /m)	CABLE LOSS (dB)	PREAMP FACTOR (dB)	ANTENNA HEIGHT (cm)	TABLE ANGLE (Degree)	REMARK
5745	103.31	98.09			35.19	16.31	46.28	102	211	Average
5745	109.06	103.84			35.19	16.31	46.28	102	211	Peak

REMARKS:

1. Emission Level = Read Level+ Antenna Factor + Cable Loss- Preamp Factor
Margin value = Emission level – Limit value.
2. 5745MHz: Fundamental frequency.



OOBE DATA

802.11a

ANTENNA POLARITY & TEST DISTANCE: HORIZONTAL AT 3 M										
FREQ. (MHz)	EMISSION LEVEL (dBuV/m)	READ LEVEL (dBuV)	LIMIT (dBuV/m)	MARGIN (dB)	ANTENNA FACTOR (dB /m)	CABLE LOSS (dB)	PREAMP FACTOR (dB)	ANTENNA HEIGHT (cm)	TABLE ANGLE (Degree)	REMARK
5575.65	56.25	52.34	68.3	-12.05	34.99	15.2	46.28	100	311	Peak
6003.15	59.01	51.83	68.3	-9.29	35.5	17.96	46.28	100	311	Peak
ANTENNA POLARITY & TEST DISTANCE: VERTICAL AT 3 M										
FREQ. (MHz)	EMISSION LEVEL (dBuV/m)	READ LEVEL (dBuV)	LIMIT (dBuV/m)	MARGIN (dB)	ANTENNA FACTOR (dB /m)	CABLE LOSS (dB)	PREAMP FACTOR (dB)	ANTENNA HEIGHT (cm)	TABLE ANGLE (Degree)	REMARK
5576.14	56.05	52.13	68.3	-12.25	34.99	15.21	46.28	102	211	Peak
5975.32	59.5	52.5	68.3	-8.8	35.47	17.81	46.28	102	211	Peak

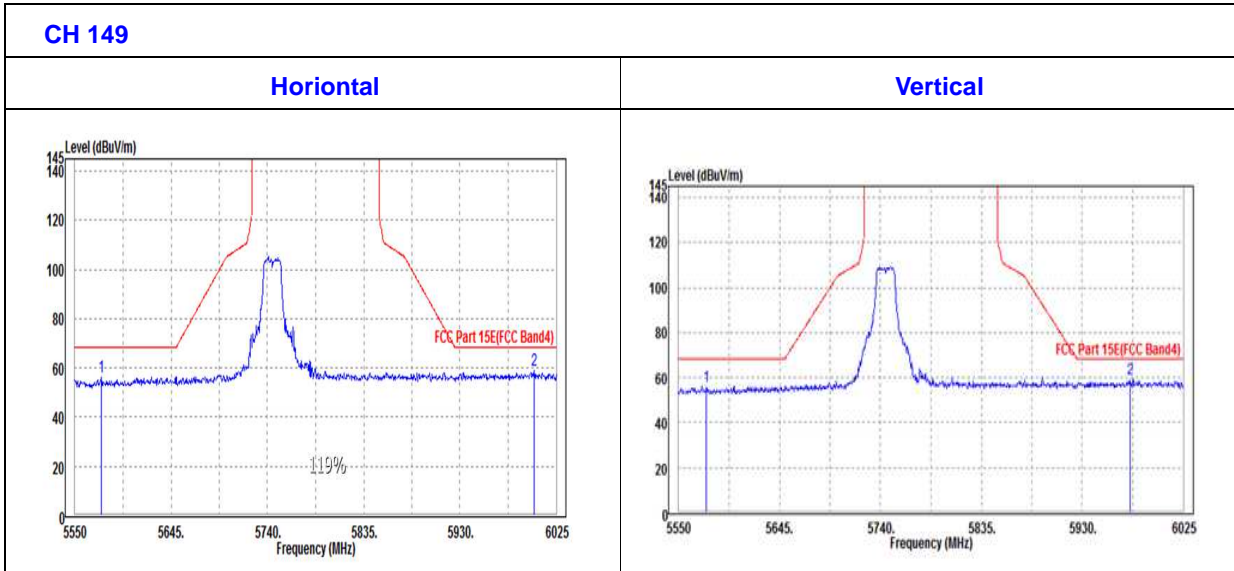



CHANNEL	TX Channel 157	DETECTOR FUNCTION	Peak (PK)
FREQUENCY RANGE	1GHz ~ 40GHz		Average (AV)

ANTENNA POLARITY & TEST DISTANCE: HORIZONTAL AT 3 M										
FREQ. (MHz)	EMISSION LEVEL (dBuV/m)	READ LEVEL (dBuV)	LIMIT (dBuV/m)	MARGIN (dB)	ANTENNA FACTOR (dB /m)	CABLE LOSS (dB)	PREAMP FACTOR (dB)	ANTENNA HEIGHT (cm)	TABLE ANGLE (Degree)	REMARK
5785	98.94	93.41			35.24	16.57	46.28	100	78	Average
5785	106.94	101.41			35.24	16.57	46.28	100	78	Peak
ANTENNA POLARITY & TEST DISTANCE: VERTICAL AT 3 M										
FREQ. (MHz)	EMISSION LEVEL (dBuV/m)	READ LEVEL (dBuV)	LIMIT (dBuV/m)	MARGIN (dB)	ANTENNA FACTOR (dB /m)	CABLE LOSS (dB)	PREAMP FACTOR (dB)	ANTENNA HEIGHT (cm)	TABLE ANGLE (Degree)	REMARK
5785	100.87	95.34			35.24	16.57	46.28	100	122	Peak
5785	108.71	103.18			35.24	16.57	46.28	100	122	Peak

REMARKS:

1. Emission Level = Read Level+ Antenna Factor + Cable Loss- Preamp Factor
Margin value = Emission level – Limit value.
2. 5785MHz: Fundamental frequency.



OOBE DATA

802.11a

ANTENNA POLARITY & TEST DISTANCE: HORIZONTAL AT 3 M										
FREQ. (MHz)	EMISSION LEVEL (dBuV/m)	READ LEVEL (dBuV)	LIMIT (dBuV/m)	MARGIN (dB)	ANTENNA FACTOR (dB /m)	CABLE LOSS (dB)	PREAMP FACTOR (dB)	ANTENNA HEIGHT (cm)	TABLE ANGLE (Degree)	REMARK
5597.025	57.46	53.38	68.3	-10.84	35.02	15.34	46.28	400	315	Peak
5974.65	60.26	53.27	68.3	-8.04	35.47	17.8	46.28	400	315	Peak
ANTENNA POLARITY & TEST DISTANCE: VERTICAL AT 3 M										
FREQ. (MHz)	EMISSION LEVEL (dBuV/m)	READ LEVEL (dBuV)	LIMIT (dBuV/m)	MARGIN (dB)	ANTENNA FACTOR (dB /m)	CABLE LOSS (dB)	PREAMP FACTOR (dB)	ANTENNA HEIGHT (cm)	TABLE ANGLE (Degree)	REMARK
5589.425	56.57	52.55	68.3	-11.73	35.01	15.29	46.28	400	315	Average
5956.6	59.25	52.39	68.3	-9.05	35.45	17.69	46.28	400	315	Peak

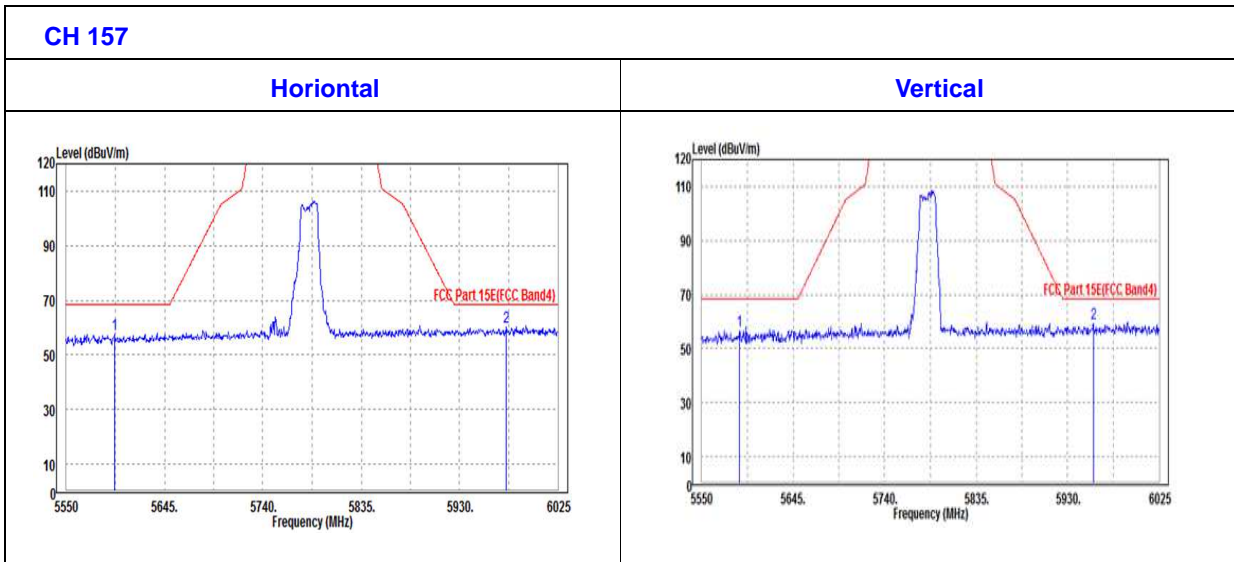



CHANNEL	TX Channel 165	DETECTOR FUNCTION	Peak (PK)
FREQUENCY RANGE	1GHz ~ 40GHz		Average (AV)

ANTENNA POLARITY & TEST DISTANCE: HORIZONTAL AT 3 M										
FREQ. (MHz)	EMISSION LEVEL (dBuV/m)	READ LEVEL (dBuV)	LIMIT (dBuV/m)	MARGIN (dB)	ANTENNA FACTOR (dB /m)	CABLE LOSS (dB)	PREAMP FACTOR (dB)	ANTENNA HEIGHT (cm)	TABLE ANGLE (Degree)	REMARK
5825	97.9	92.06			35.29	16.83	46.28	100	311	Average
5825	106.77	100.93			35.29	16.83	46.28	100	311	Peak

ANTENNA POLARITY & TEST DISTANCE: VERTICAL AT 3 M										
FREQ. (MHz)	EMISSION LEVEL (dBuV/m)	READ LEVEL (dBuV)	LIMIT (dBuV/m)	MARGIN (dB)	ANTENNA FACTOR (dB /m)	CABLE LOSS (dB)	PREAMP FACTOR (dB)	ANTENNA HEIGHT (cm)	TABLE ANGLE (Degree)	REMARK
5825	99.67	93.83			35.29	16.83	46.28	100	211	Average
5825	108.03	102.19			35.29	16.83	46.28	100	211	Peak

REMARKS:

1. Emission Level = Read Level+ Antenna Factor + Cable Loss- Preamp Factor
Margin value = Emission level – Limit value.
2. 5825MHz: Fundamental frequency.



OOBE DATA

802.11a

ANTENNA POLARITY & TEST DISTANCE: HORIZONTAL AT 3 M										
FREQ. (MHz)	EMISSION LEVEL (dBuV/m)	READ LEVEL (dBuV)	LIMIT (dBuV/m)	MARGIN (dB)	ANTENNA FACTOR (dB /m)	CABLE LOSS (dB)	PREAMP FACTOR (dB)	ANTENNA HEIGHT (cm)	TABLE ANGLE (Degree)	REMARK
5577.55	58.15	54.22	68.3	-10.15	34.99	15.22	46.28	100	311	Peak
5991.75	61.56	54.43	68.3	-6.74	35.49	17.92	46.28	100	311	Peak
ANTENNA POLARITY & TEST DISTANCE: VERTICAL AT 3 M										
FREQ. (MHz)	EMISSION LEVEL (dBuV/m)	READ LEVEL (dBuV)	LIMIT (dBuV/m)	MARGIN (dB)	ANTENNA FACTOR (dB /m)	CABLE LOSS (dB)	PREAMP FACTOR (dB)	ANTENNA HEIGHT (cm)	TABLE ANGLE (Degree)	REMARK
5589.9	57.66	53.63	68.3	-10.64	35.01	15.3	46.28	100	211	Peak
5977.5	60.68	53.67	68.3	-7.62	35.47	17.82	46.28	100	211	Peak

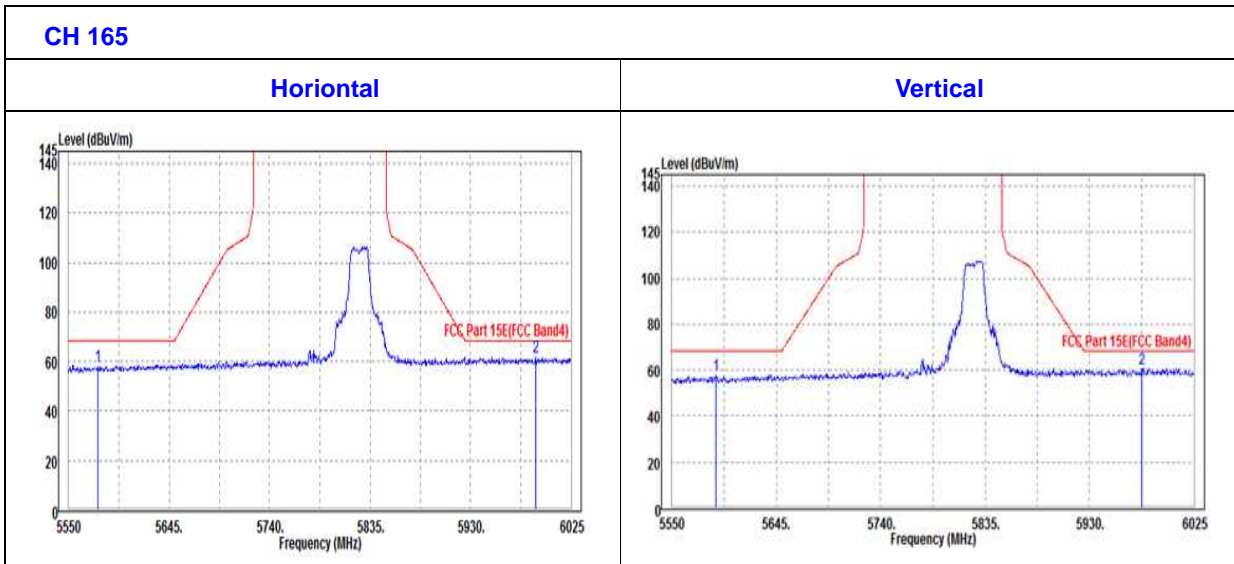



802.11n (20MHz)

CHANNEL	TX Channel 149	DETECTOR FUNCTION	Peak (PK)
FREQUENCY RANGE	1GHz ~ 40GHz		Average (AV)

ANTENNA POLARITY & TEST DISTANCE: HORIZONTAL AT 3 M										
FREQ. (MHz)	EMISSION LEVEL (dBuV/m)	READ LEVEL (dBuV)	LIMIT (dBuV/m)	MARGIN (dB)	ANTENNA FACTOR (dB /m)	CABLE LOSS (dB)	PREAMP FACTOR (dB)	ANTENNA HEIGHT (cm)	TABLE ANGLE (Degree)	REMARK
5745	97.45	92.23			35.19	16.31	46.28	100	164	Average
5745	106.18	100.96			35.19	16.31	46.28	100	164	Peak
ANTENNA POLARITY & TEST DISTANCE: VERTICAL AT 3 M										
FREQ. (MHz)	EMISSION LEVEL (dBuV/m)	READ LEVEL (dBuV)	LIMIT (dBuV/m)	MARGIN (dB)	ANTENNA FACTOR (dB /m)	CABLE LOSS (dB)	PREAMP FACTOR (dB)	ANTENNA HEIGHT (cm)	TABLE ANGLE (Degree)	REMARK
5745	99.15	93.93			35.19	16.31	46.28	102	80	Average
5745	108.09	102.87			35.19	16.31	46.28	102	80	Peak

REMARKS:

1. Emission Level = Read Level+ Antenna Factor + Cable Loss- Preamp Factor
Margin value = Emission level – Limit value.
2. 5745MHz: Fundamental frequency.



OOBE DATA

802.11n (20MHZ)

ANTENNA POLARITY & TEST DISTANCE: HORIZONTAL AT 3 M										
FREQ. (MHz)	EMISSION LEVEL (dBuV/m)	READ LEVEL (dBuV)	LIMIT (dBuV/m)	MARGIN (dB)	ANTENNA FACTOR (dB /m)	CABLE LOSS (dB)	PREAMP FACTOR (dB)	ANTENNA HEIGHT (cm)	TABLE ANGLE (Degree)	REMARK
5626	56.94	52.64	68.3	-11.36	35.05	15.53	46.28	100	164	Peak
5975.6	58.46	51.46	68.3	-9.84	35.47	17.81	46.28	100	164	Peak
ANTENNA POLARITY & TEST DISTANCE: VERTICAL AT 3 M										
FREQ. (MHz)	EMISSION LEVEL (dBuV/m)	READ LEVEL (dBuV)	LIMIT (dBuV/m)	MARGIN (dB)	ANTENNA FACTOR (dB /m)	CABLE LOSS (dB)	PREAMP FACTOR (dB)	ANTENNA HEIGHT (cm)	TABLE ANGLE (Degree)	REMARK
5590.85	55.84	51.81	68.3	-12.46	35.01	15.3	46.28	102	80	Peak
5965.15	58.51	51.59	68.3	-9.79	35.46	17.74	46.28	102	80	Peak

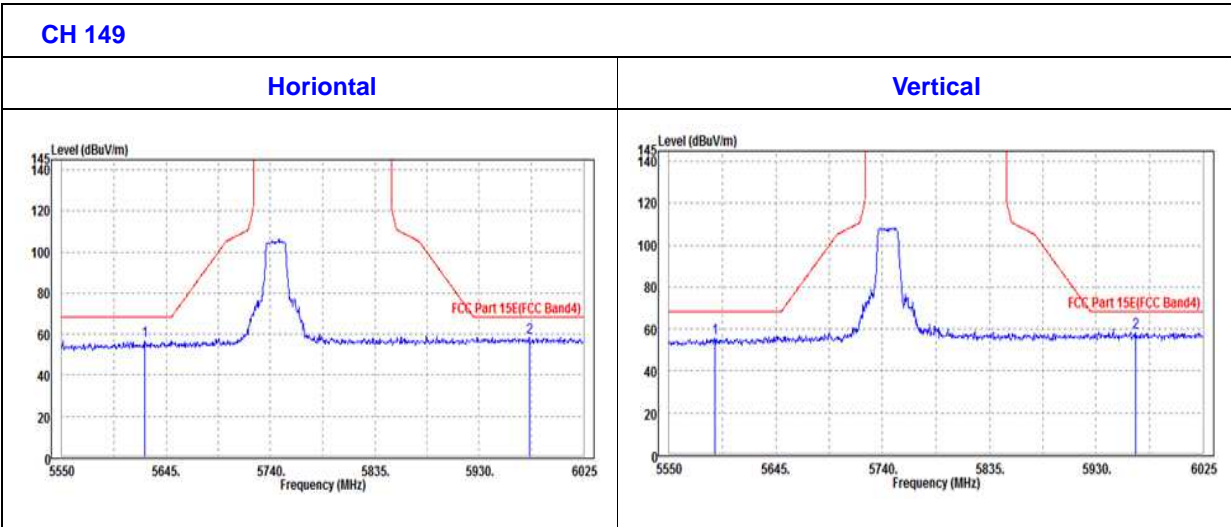



CHANNEL	TX Channel 157	DETECTOR FUNCTION	Peak (PK)
FREQUENCY RANGE	1GHz ~ 40GHz		Average (AV)

ANTENNA POLARITY & TEST DISTANCE: HORIZONTAL AT 3 M										
FREQ. (MHz)	EMISSION LEVEL (dBuV/m)	READ LEVEL (dBuV)	LIMIT (dBuV/m)	MARGIN (dB)	ANTENNA FACTOR (dB /m)	CABLE LOSS (dB)	PREAMP FACTOR (dB)	ANTENNA HEIGHT (cm)	TABLE ANGLE (Degree)	REMARK
5785	98.21	92.68			35.24	16.57	46.28	126	44	Average
5785	106.61	101.08			35.24	16.57	46.28	126	44	Peak
ANTENNA POLARITY & TEST DISTANCE: VERTICAL AT 3 M										
FREQ. (MHz)	EMISSION LEVEL (dBuV/m)	READ LEVEL (dBuV)	LIMIT (dBuV/m)	MARGIN (dB)	ANTENNA FACTOR (dB /m)	CABLE LOSS (dB)	PREAMP FACTOR (dB)	ANTENNA HEIGHT (cm)	TABLE ANGLE (Degree)	REMARK
5785	98.78	93.25			35.24	16.57	46.28	100	165	Average
5785	107.77	102.24			35.24	16.57	46.28	100	165	Peak

REMARKS:

1. Emission Level = Read Level+ Antenna Factor + Cable Loss- Preamp Factor
Margin value = Emission level – Limit value.
2. 5785MHz: Fundamental frequency.



OOBE DATA

802.11n (20MHZ)

ANTENNA POLARITY & TEST DISTANCE: HORIZONTAL AT 3 M										
FREQ. (MHz)	EMISSION LEVEL (dBuV/m)	READ LEVEL (dBuV)	LIMIT (dBuV/m)	MARGIN (dB)	ANTENNA FACTOR (dB /m)	CABLE LOSS (dB)	PREAMP FACTOR (dB)	ANTENNA HEIGHT (cm)	TABLE ANGLE (Degree)	REMARK
5635.025	56.06	51.69	68.3	-12.24	35.06	15.59	46.28	400	315	Peak
5990.8	58.83	51.71	68.3	-9.47	35.49	17.91	46.28	400	315	Peak
ANTENNA POLARITY & TEST DISTANCE: VERTICAL AT 3 M										
FREQ. (MHz)	EMISSION LEVEL (dBuV/m)	READ LEVEL (dBuV)	LIMIT (dBuV/m)	MARGIN (dB)	ANTENNA FACTOR (dB /m)	CABLE LOSS (dB)	PREAMP FACTOR (dB)	ANTENNA HEIGHT (cm)	TABLE ANGLE (Degree)	REMARK
5595.125	55.9	51.84	68.3	-12.4	35.01	15.33	46.28	400	315	Peak
6006.475	59.46	52.3	68.3	-8.84	35.5	17.94	46.28	400	315	Peak

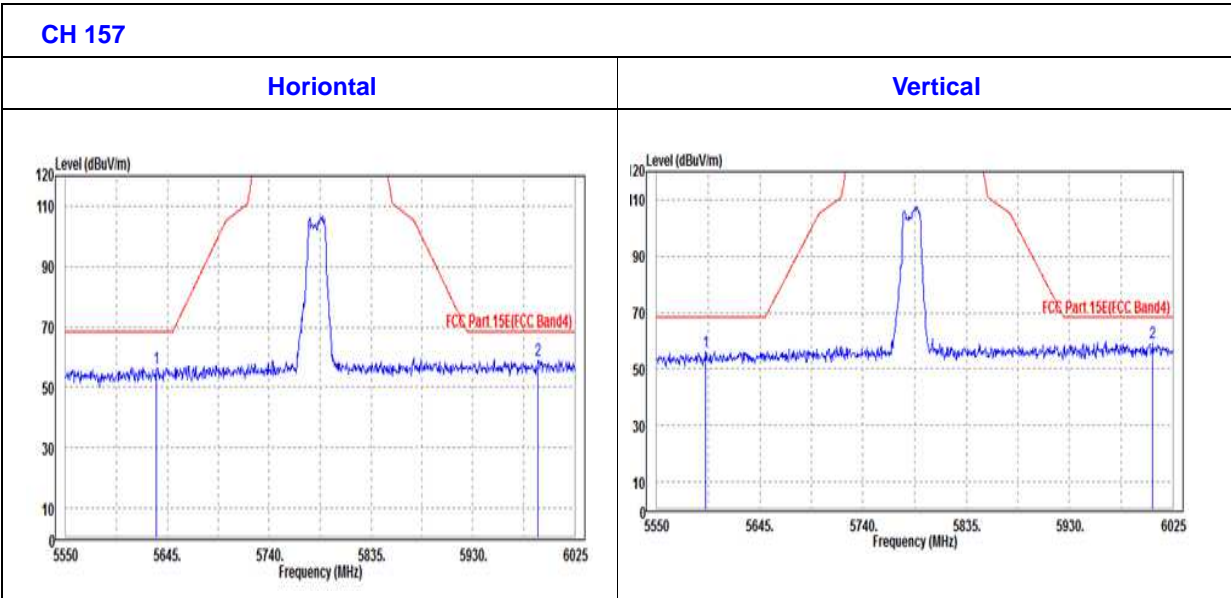



CHANNEL	TX Channel 165	DETECTOR FUNCTION	Peak (PK)
FREQUENCY RANGE	1GHz ~ 40GHz		Average (AV)

ANTENNA POLARITY & TEST DISTANCE: HORIZONTAL AT 3 M										
FREQ. (MHz)	EMISSION LEVEL (dBuV/m)	READ LEVEL (dBuV)	LIMIT (dBuV/m)	MARGIN (dB)	ANTENNA FACTOR (dB /m)	CABLE LOSS (dB)	PREAMP FACTOR (dB)	ANTENNA HEIGHT (cm)	TABLE ANGLE (Degree)	REMARK
5825	100.22	94.38			35.29	16.83	46.28	100	132	Average
5825	108.89	103.05			35.29	16.83	46.28	100	132	Peak
ANTENNA POLARITY & TEST DISTANCE: VERTICAL AT 3 M										
FREQ. (MHz)	EMISSION LEVEL (dBuV/m)	READ LEVEL (dBuV)	LIMIT (dBuV/m)	MARGIN (dB)	ANTENNA FACTOR (dB /m)	CABLE LOSS (dB)	PREAMP FACTOR (dB)	ANTENNA HEIGHT (cm)	TABLE ANGLE (Degree)	REMARK
5825	98.31	92.47			35.29	16.83	46.28	100	80	Average
5825	106.65	100.81			35.29	16.83	46.28	100	80	Peak

REMARKS:

1. Emission Level = Read Level+ Antenna Factor + Cable Loss- Preamp Factor
Margin value = Emission level – Limit value.
2. 5825MHz: Fundamental frequency.



OOBE DATA

802.11n (20MHZ)

ANTENNA POLARITY & TEST DISTANCE: HORIZONTAL AT 3 M										
FREQ. (MHz)	EMISSION LEVEL (dBuV/m)	READ LEVEL (dBuV)	LIMIT (dBuV/m)	MARGIN (dB)	ANTENNA FACTOR (dB /m)	CABLE LOSS (dB)	PREAMP FACTOR (dB)	ANTENNA HEIGHT (cm)	TABLE ANGLE (Degree)	REMARK
5620.3	54.96	50.71	68.3	-13.34	35.04	15.49	46.28	100	132	Peak
6011.7	58.21	51.07	68.3	-10.09	35.5	17.92	46.28	100	132	Peak
ANTENNA POLARITY & TEST DISTANCE: VERTICAL AT 3 M										
FREQ. (MHz)	EMISSION LEVEL (dBuV/m)	READ LEVEL (dBuV)	LIMIT (dBuV/m)	MARGIN (dB)	ANTENNA FACTOR (dB /m)	CABLE LOSS (dB)	PREAMP FACTOR (dB)	ANTENNA HEIGHT (cm)	TABLE ANGLE (Degree)	REMARK
5595.6	55.98	51.92	68.3	-12.32	35.01	15.33	46.28	100	80	Peak
5964.675	59.47	52.55	68.3	-8.83	35.46	17.74	46.28	100	80	Peak

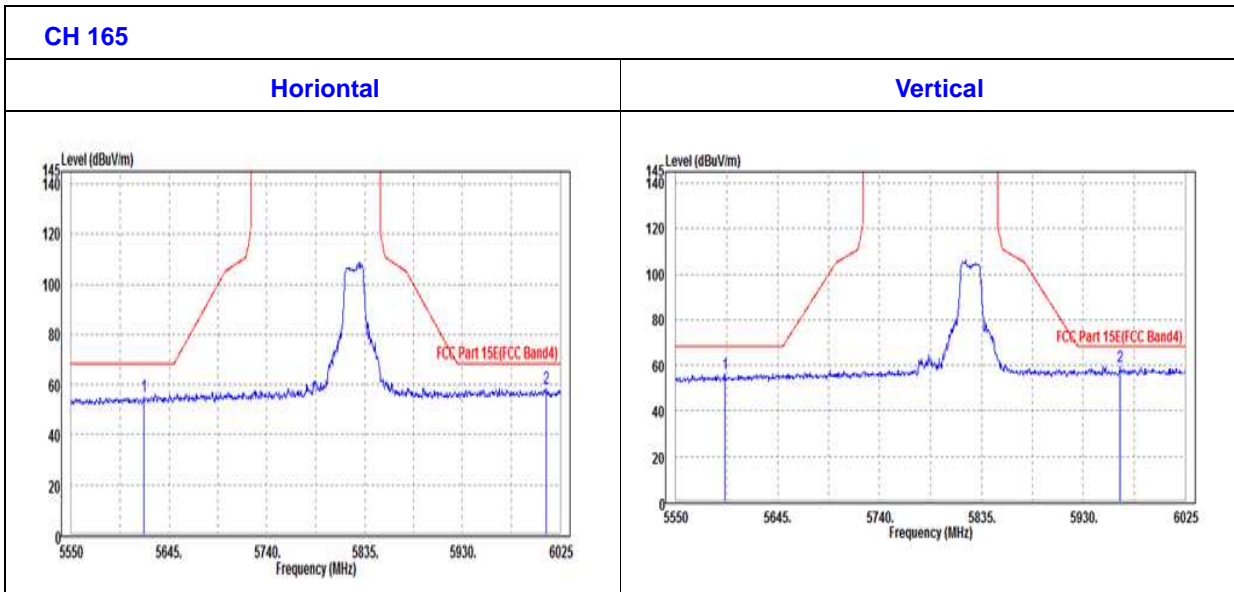



802.11n (40MHz)

CHANNEL	TX Channel 151	DETECTOR FUNCTION	Peak (PK)
FREQUENCY RANGE	1GHz ~ 40GHz		Average (AV)

ANTENNA POLARITY & TEST DISTANCE: HORIZONTAL AT 3 M										
FREQ. (MHz)	EMISSION LEVEL (dBuV/m)	READ LEVEL (dBuV)	LIMIT (dBuV/m)	MARGIN (dB)	ANTENNA FACTOR (dB /m)	CABLE LOSS (dB)	PREAMP FACTOR (dB)	ANTENNA HEIGHT (cm)	TABLE ANGLE (Degree)	REMARK
5755	95.12	89.82			35.21	16.37	46.28	100	142	Average
5755	103.86	98.56			35.21	16.37	46.28	100	142	Peak
ANTENNA POLARITY & TEST DISTANCE: VERTICAL AT 3 M										
FREQ. (MHz)	EMISSION LEVEL (dBuV/m)	READ LEVEL (dBuV)	LIMIT (dBuV/m)	MARGIN (dB)	ANTENNA FACTOR (dB /m)	CABLE LOSS (dB)	PREAMP FACTOR (dB)	ANTENNA HEIGHT (cm)	TABLE ANGLE (Degree)	REMARK
5755	100.83	95.53			35.21	16.37	46.28	103	81	Average
5755	109.16	103.86			35.21	16.37	46.28	103	81	Peak

REMARKS:

1. Emission Level = Read Level+ Antenna Factor + Cable Loss- Preamp Factor
Margin value = Emission level – Limit value.
2. 5755MHz: Fundamental frequency.



OOBE DATA

802.11n (40MHZ)

ANTENNA POLARITY & TEST DISTANCE: HORIZONTAL AT 3 M										
FREQ. (MHz)	EMISSION LEVEL (dBuV/m)	READ LEVEL (dBuV)	LIMIT (dBuV/m)	MARGIN (dB)	ANTENNA FACTOR (dB /m)	CABLE LOSS (dB)	PREAMP FACTOR (dB)	ANTENNA HEIGHT (cm)	TABLE ANGLE (Degree)	REMARK
5624.575	55.58	51.29	68.3	-12.72	35.05	15.52	46.28	100	142	Peak
5946.15	57.6	50.82	68.3	-10.7	35.44	17.62	46.28	100	142	Peak
ANTENNA POLARITY & TEST DISTANCE: VERTICAL AT 3 M										
FREQ. (MHz)	EMISSION LEVEL (dBuV/m)	READ LEVEL (dBuV)	LIMIT (dBuV/m)	MARGIN (dB)	ANTENNA FACTOR (dB /m)	CABLE LOSS (dB)	PREAMP FACTOR (dB)	ANTENNA HEIGHT (cm)	TABLE ANGLE (Degree)	REMARK
5631.7	56.2	51.85	68.3	-12.1	35.06	15.57	46.28	103	81	Peak
6000.775	57.65	50.46	68.3	-10.65	35.5	17.97	46.28	103	81	Peak

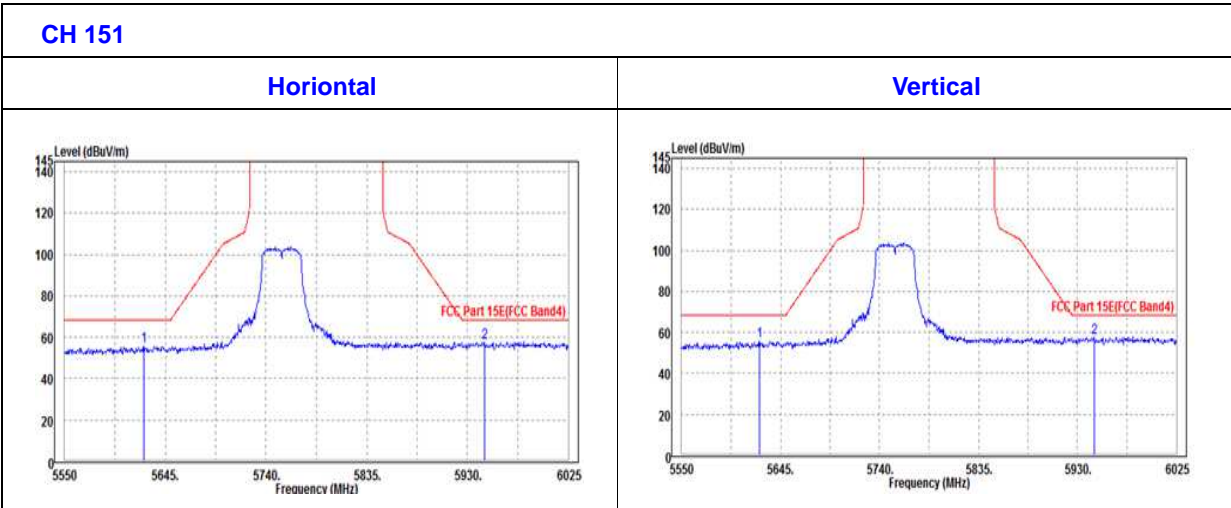



CHANNEL	TX Channel 159	DETECTOR FUNCTION	Peak (PK)
FREQUENCY RANGE	1GHz ~ 40GHz		Average (AV)

ANTENNA POLARITY & TEST DISTANCE: HORIZONTAL AT 3 M										
FREQ. (MHz)	EMISSION LEVEL (dBuV/m)	READ LEVEL (dBuV)	LIMIT (dBuV/m)	MARGIN (dB)	ANTENNA FACTOR (dB /m)	CABLE LOSS (dB)	PREAMP FACTOR (dB)	ANTENNA HEIGHT (cm)	TABLE ANGLE (Degree)	REMARK
5795	94.96	89.36			35.25	16.63	46.28	112	155	Average
5795	103.73	98.13			35.25	16.63	46.28	112	155	Peak

ANTENNA POLARITY & TEST DISTANCE: VERTICAL AT 3 M										
FREQ. (MHz)	EMISSION LEVEL (dBuV/m)	READ LEVEL (dBuV)	LIMIT (dBuV/m)	MARGIN (dB)	ANTENNA FACTOR (dB /m)	CABLE LOSS (dB)	PREAMP FACTOR (dB)	ANTENNA HEIGHT (cm)	TABLE ANGLE (Degree)	REMARK
5795	101.54	95.94			35.25	16.63	46.28	102	81	Average
5795	109.86	104.26			35.25	16.63	46.28	102	81	Peak

REMARKS:

1. Emission Level = Read Level+ Antenna Factor + Cable Loss- Preamp Factor
Margin value = Emission level – Limit value.
2. 5795MHz: Fundamental frequency.



OOBE DATA

802.11n (40MHZ)

ANTENNA POLARITY & TEST DISTANCE: HORIZONTAL AT 3 M										
FREQ. (MHz)	EMISSION LEVEL (dBuV/m)	READ LEVEL (dBuV)	LIMIT (dBuV/m)	MARGIN (dB)	ANTENNA FACTOR (dB /m)	CABLE LOSS (dB)	PREAMP FACTOR (dB)	ANTENNA HEIGHT (cm)	TABLE ANGLE (Degree)	REMARK
5563.3	54.79	50.97	68.3	-13.51	34.98	15.12	46.28	112	155	Peak
5949.95	58.03	51.23	68.3	-10.27	35.44	17.64	46.28	112	155	Peak
ANTENNA POLARITY & TEST DISTANCE: VERTICAL AT 3 M										
FREQ. (MHz)	EMISSION LEVEL (dBuV/m)	READ LEVEL (dBuV)	LIMIT (dBuV/m)	MARGIN (dB)	ANTENNA FACTOR (dB /m)	CABLE LOSS (dB)	PREAMP FACTOR (dB)	ANTENNA HEIGHT (cm)	TABLE ANGLE (Degree)	REMARK
5593.225	55.01	50.96	68.3	-13.29	35.01	15.32	46.28	102	81	Peak
5997.45	58.11	50.94	68.3	-10.19	35.5	17.95	46.28	102	81	Peak

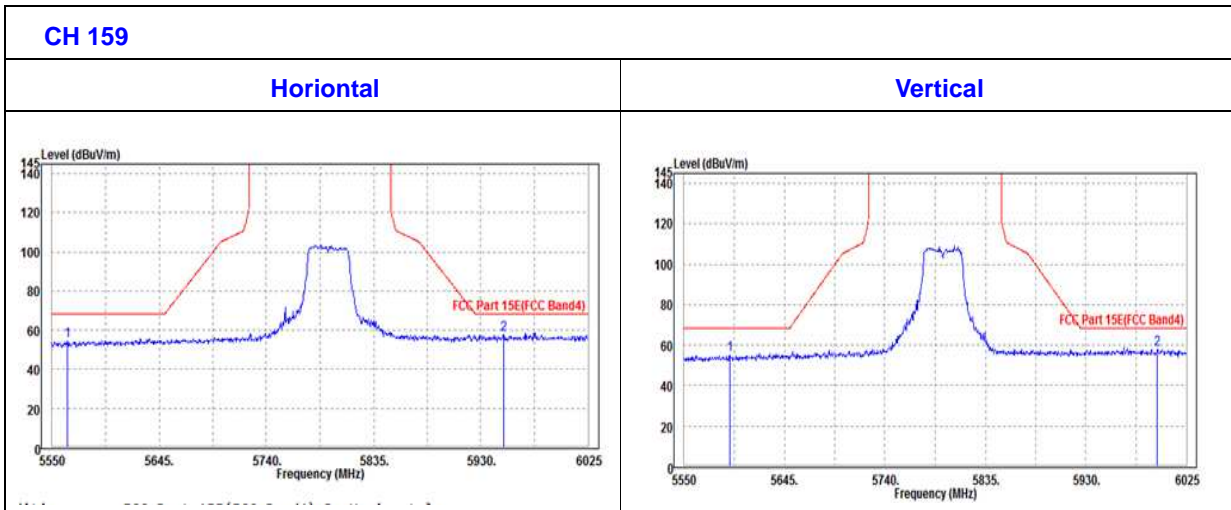



3.2 CONDUCTED EMISSION MEASUREMENT

3.2.1 LIMITS OF CONDUCTED EMISSION MEASUREMENT

FREQUENCY OF EMISSION (MHz)	CONDUCTED LIMIT (dBµV)	
	Quasi-peak	Average
0.15 ~ 0.5	66 to 56	56 to 46
0.5 ~ 5	56	46
5 ~ 30	60	50

- NOTE:**
1. The lower limit shall apply at the transition frequencies.
 2. The limit decreases in line with the logarithm of the frequency in the range of 0.15 to 0.50MHz.
 3. All emanations from a class A/B digital device or system, including any network of conductors and apparatus connected thereto, shall not exceed the level of field strengths specified above.

3.2.2 TEST INSTRUMENTS

Equipment	Manufacturer	Model No.	Serial No.	Last Cal.	Next Cal.
EMI Test Receiver	Rohde&Schwarz	ESR3	101900	Jun. 28,17	Jun. 27,18
EMC32 test software	Rohde&Schwarz	EMC32	NA	NA	NA
LISN network	Rohde&Schwarz	ENV216	101922	Sep. 18,17	Sep. 17,18

- NOTE:**
1. The test was performed in CE shielded room.
 2. The calibration interval of the above test instruments is 12 months. And the calibrations are traceable to CEPREI/CHINA, GRGT/CHINA and NIM/CHINA.

3.2.3 TEST PROCEDURES

- a. The EUT was placed 0.4 meters from the conducting wall of the shielded room with EUT being connected to the power mains through a line impedance stabilization network (LISN). Other support units were connected to the power mains through another LISN. The two LISNs provide 50 ohm/ 50uH of coupling impedance for the measuring instrument.
- b. Both lines of the power mains connected to the EUT were checked for maximum conducted interference.
- c. The frequency range from 150kHz to 30MHz was searched. Emission levels under (Limit - 20dB) was not recorded.

NOTE: All modes of operation were investigated and the worst-case emissions are reported.



3.2.4 DEVIATION FROM TEST STANDARD

No deviation.

3.2.5 TEST SETUP

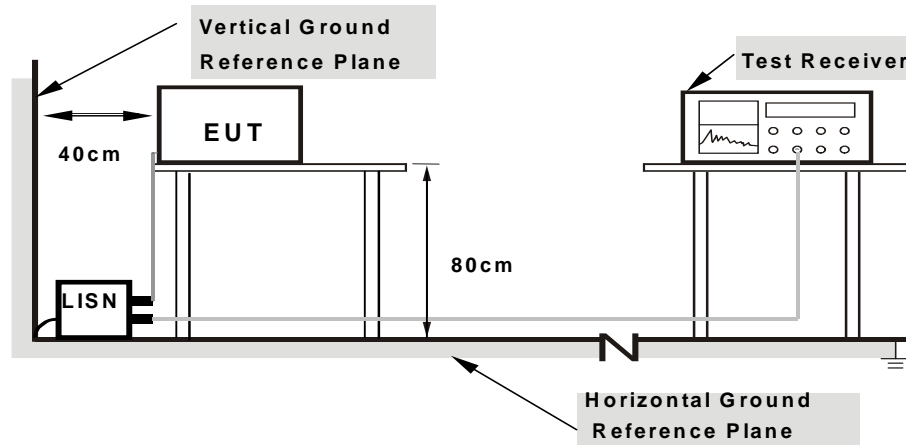

- Note: 1.Support units were connected to second LISN.
2.Both of LISNs (AMN) are 80 cm from EUT and at least 80
from other units and other metal planes**

For the actual test configuration, please refer to the attached file (Test Setup Photo).

3.2.6 EUT OPERATING CONDITIONS

Same as 3.1.6.



3.2.7 TEST RESULTS

CONDUCTED WORST-CASE DATA :

Frequency Range	150KHz ~ 30MHz	Detector Function & Resolution Bandwidth	Quasi-Peak (QP) / Average (AV), 9 kHz
Input Power	120Vac, 60Hz	Environmental Conditions	24deg. C, 55RH
Tested By	Alex Chen	TEST DATE	2018/4/2

Frequency (MHz)	QuasiPeak (dB μ V)	CAverage (dB μ V)	Limit (dB μ V)	Margin (dB)	Line	Filter	Corr. (dB)
0.476000	---	31.02	46.41	-15.39	L	ON	9.7
0.476000	35.15	---	56.41	-21.26	L	ON	9.7
1.068000	---	23.37	46.00	-22.63	L	ON	9.7
1.068000	31.42	---	56.00	-24.58	L	ON	9.7
1.804000	---	28.48	46.00	-17.52	L	ON	9.7
1.804000	35.10	---	56.00	-20.90	L	ON	9.7
3.464000	---	23.94	46.00	-22.06	L	ON	9.7
3.464000	31.04	---	56.00	-24.96	L	ON	9.7
3.576000	---	21.49	46.00	-24.51	L	ON	9.7
3.576000	29.28	---	56.00	-26.72	L	ON	9.7
23.516000	---	19.13	50.00	-30.87	L	ON	10.0
23.516000	30.28	---	60.00	-29.72	L	ON	10.0

- REMARKS:**
1. Q.P. and AV. are abbreviations of quasi-peak and average individually.
 2. "-": The Quasi-peak reading value also meets average limit and measurement with the average detector is unnecessary.
 3. The emission levels of other frequencies were very low against the limit.
 4. Margin value = Emission level - Limit value
 5. Correction factor = Insertion loss + Cable loss
 6. Emission Level = Correction Factor + Reading Value.

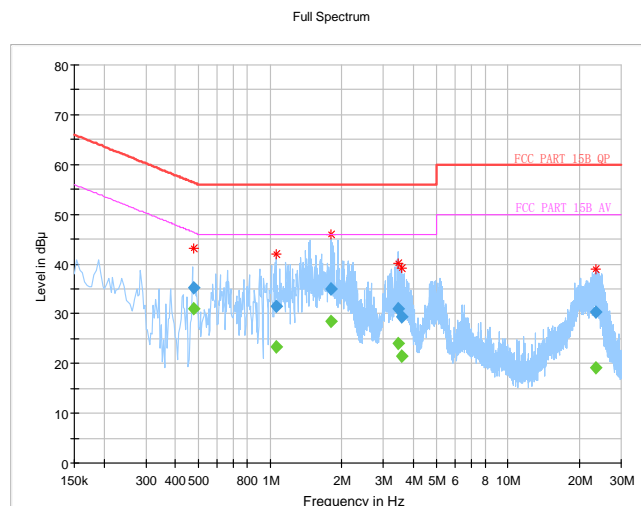



Frequency Range	150KHz ~ 30MHz	Detector Function & Resolution Bandwidth	Quasi-Peak (QP) / Average (AV), 9 kHz
Input Power	120Vac, 60Hz	Environmental Conditions	24deg. C, 55RH
Tested By	Alex Chen	TEST DATE	2018/4/2

Frequency (MHz)	QuasiPeak (dBµV)	CAverage (dBµV)	Limit (dBµV)	Margin (dB)	Line	Filter	Corr. (dB)
0.162000	---	27.20	55.36	-28.16	N	ON	10.1
0.162000	37.89	---	65.36	-27.47	N	ON	10.1
0.476000	---	37.17	46.41	-9.24	N	ON	10.1
0.476000	42.05	---	56.41	-14.36	N	ON	10.1
1.056000	---	29.52	46.00	-16.48	N	ON	9.9
1.056000	35.64	---	56.00	-20.36	N	ON	9.9
1.818000	---	30.17	46.00	-15.83	N	ON	9.8
1.818000	36.32	---	56.00	-19.68	N	ON	9.8
3.444000	---	25.43	46.00	-20.57	N	ON	9.8
3.444000	32.01	---	56.00	-23.99	N	ON	9.8
3.792000	---	25.50	46.00	-20.50	N	ON	9.8
3.792000	31.85	---	56.00	-24.15	N	ON	9.8

- REMARKS:**
1. Q.P. and AV. are abbreviations of quasi-peak and average individually.
 2. "-": The Quasi-peak reading value also meets average limit and measurement with the average detector is unnecessary.
 3. The emission levels of other frequencies were very low against the limit.
 4. Margin value = Emission level - Limit value
 5. Correction factor = Insertion loss + Cable loss
 6. Emission Level = Correction Factor + Reading Value.

Full Spectrum

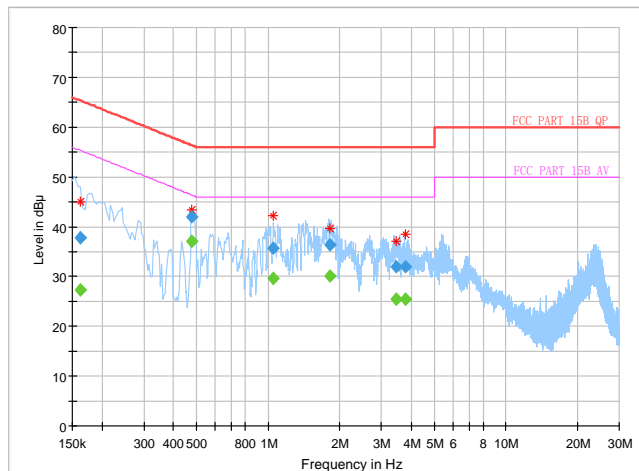



3.3 MAXIMUM CONDUCTED OUTPUT POWER MEASUREMENT

3.3.1 LIMITS OF MAXIMUM CONDUCTED OUTPUT POWER MEASUREMENT

Operation Band	EUT Category		LIMIT
U-NII-1		Outdoor Access Point	1 Watt (30 dBm) (Max. e.i.r.p \leq 125mW(21 dBm) at any elevation angle above 30 degrees as measured from the horizon)
		Fixed point-to-point Access Point	1 Watt (30 dBm)
		Indoor Access Point	1 Watt (30 dBm)
	√	Client devices	250mW (24 dBm)
U-NII-2A	√		250mW (24 dBm) or 11 dBm+10 log B*
U-NII-2C	√		250mW (24 dBm) or 11 dBm+10 log B*
U-NII-3	√		1 Watt (30 dBm)

NOTE: Where B is the 26dB emission bandwidth in MHz.



3.3.2 TEST SETUP

FOR POWER OUTPUT MEASUREMENT

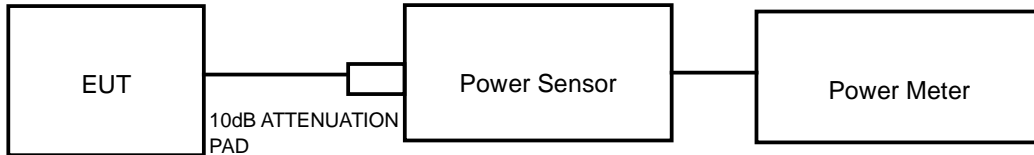

FOR 26dB BANDWIDTH

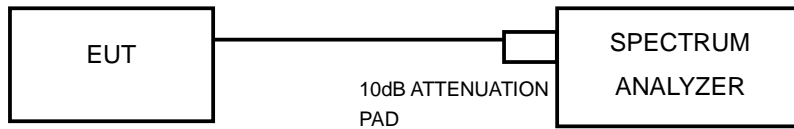

3.3.3 TEST INSTRUMENTS

Equipment	Manufacturer	Model No.	Serial No.	Last Cal.	Next Cal.
Power Meter	ANRITSU	ML2495A	1506002	Mar. 02,18	Mar. 01,19
EXA Signal Analyzer	KEYSIGHT	N9010A-526	MY54510523	Jun. 28,17	Jun. 27,18
EXA Signal Analyzer	KEYSIGHT	N9010A-544	MY54510332	Mar. 16,18	Mar. 15,19
Power Sensor	ANRITSU	MA2411B	1339352	Mar. 16,18	Mar. 15,19

NOTE:

1. The calibration interval of the above test instruments is 12 months and the calibrations are traceable to CEPREI/CHINA, GRGT/CHINA and NIM/CHINA.
2. The test was performed in RF Oven room.



3.3.4 TEST PROCEDURE

FOR POWER MEASUREMENT

For 802.11a, 802.11n (20MHz), 802.11n (40MHz)

Method PM is used to perform output power measurement, trigger and gating function of wide band power meter is enabled to measure max output power of TX on burst. Duty factor is not added to measured value.

FOR 99 PERCENT OCCUPIED BANDWIDTH

The following procedure shall be used for measuring (99 %) power bandwidth:

1. Set center frequency to the nominal EUT channel center frequency.
2. Set span = 1.5 times to 5.0 times the OBW.
3. Set RBW = 1 % to 5 % of the OBW
4. Set VBW $\geq 3 \cdot$ RBW
5. Video averaging is not permitted. Where practical, a sample detection and single sweep mode shall be used. Otherwise, peak detection and max hold mode (until the trace stabilizes) shall be used.
6. Use the 99 % power bandwidth function of the instrument (if available).
7. If the instrument does not have a 99 % power bandwidth function, the trace data points are recovered and directly summed in power units. The recovered amplitude data points, beginning at the lowest frequency, are placed in a running sum until 0.5 % of the total is reached; that frequency is recorded as the lower frequency. The process is repeated until 99.5 % of the total is reached; that frequency is recorded as the upper frequency. The 99% occupied bandwidth is the difference between these two frequencies.

FOR 26dB BANDWIDTH

- 1) Set RBW = approximately 1% of the emission bandwidth.
- 2) Set the VBW > RBW.
- 3) Detector = Peak.
- 4) Trace mode = max hold.
- 5) Measure the maximum width of the emission that is 26 dB down from the peak of the emission. Compare this with the RBW setting of the analyzer. Readjust RBW and repeat measurement as needed until the RBW/EBW ratio is approximately 1%.



FOR 6dB BANDWIDTH

1. Set RBW = 100 kHz.
2. Set the video bandwidth (VBW) ≥ 3 RBW.
3. Detector = Peak.
4. Trace mode = max hold.
5. Sweep = auto couple.
6. Allow the trace to stabilize.
7. Measure the maximum width of the emission that is constrained by the frequencies associated with the two outermost amplitude points (upper and lower frequencies) that are attenuated by 6 dB relative to the maximum level measured in the fundamental emission.

3.3.5 DEVIATION FROM TEST STANDARD

No deviation.

3.3.6 EUT OPERATING CONDITIONS

The software provided by client to enable the EUT under transmission condition continuously at specific channel frequencies individually.



3.3.7 TEST RESULTS

OUTPUT POWER:

802.11a

CHANNEL	CHANNEL FREQUENCY (MHz)	AVERAGE POWER (dBm)	AVERAGE POWER (mW)	POWER LIMIT (dBm)	PASS/FAIL
36	5180	15.80	38.019	24	PASS
40	5200	15.91	38.994	24	PASS
48	5240	16.24	42.073	24	PASS
52	5260	16.48	44.463	24	PASS
60	5300	15.73	37.411	24	PASS
64	5320	16.10	40.738	24	PASS
100	5500	15.80	38.019	24	PASS
116	5580	15.37	34.435	24	PASS
140	5700	16.30	42.658	24	PASS
149	5745	15.44	34.995	30	PASS
157	5785	15.24	33.420	30	PASS
165	5825	15.42	34.834	30	PASS



802.11n (20MHz)

CHANNEL	CHANNEL FREQUENCY (MHz)	AVERAGE POWER (dBm)	AVERAGE POWER (mW)	POWER LIMIT (dBm)	PASS/FAIL
36	5180	14.92	31.046	24	PASS
40	5200	14.77	29.992	24	PASS
48	5240	14.83	30.409	24	PASS
52	5260	15.23	33.343	24	PASS
60	5300	15.13	32.584	24	PASS
64	5320	15.02	31.769	24	PASS
100	5500	15.05	31.989	24	PASS
116	5580	14.89	30.832	24	PASS
140	5700	15.21	33.189	24	PASS
149	5745	14.69	29.444	30	PASS
157	5785	14.02	25.235	30	PASS
165	5825	13.62	23.014	30	PASS

802.11n (40MHz)

CHANNEL	CHANNEL FREQUENCY (MHz)	AVERAGE POWER (dBm)	AVERAGE POWER (mW)	POWER LIMIT (dBm)	PASS/FAIL
38	5190	15.49	35.400	24	PASS
46	5230	15.38	34.514	24	PASS
54	5270	14.68	29.376	24	PASS
62	5310	15.26	33.574	24	PASS
102	5510	15.11	32.434	24	PASS
110	5550	14.92	31.046	24	PASS
134	5670	15.16	32.810	24	PASS
151	5755	14.84	30.479	30	PASS
159	5795	14.75	29.854	30	PASS



**99% OCCUPIED BANDWIDTH & 26dB BANDWIDTH/6dB BANDWIDTH:
802.11a**

CHANNEL	CHANNEL FREQUENCY (MHz)	99% OCCUPIED BANDWIDTH	26dB BANDWIDTH (MHz)	PASS/FAIL
36	5180	16.62	19.89	PASS
40	5200	16.98	20.08	PASS
48	5240	16.92	20.30	PASS
52	5260	16.98	20.05	PASS
60	5300	16.98	20.48	PASS
64	5320	17.04	20.00	PASS
100	5500	16.92	20.10	PASS
116	5580	16.80	20.84	PASS
140	5700	16.86	19.90	PASS
CHANNEL	CHANNEL FREQUENCY (MHz)	99% OCCUPIED BANDWIDTH	6dB BANDWIDTH (MHz)	PASS/FAIL
149	5745	16.74	16.36	PASS
157	5785	16.68	16.36	PASS
165	5825	16.62	16.36	PASS



802.11n (20MHz)

CHANNEL	CHANNEL FREQUENCY (MHz)	99% OCCUPIED BANDWIDTH	26dB BANDWIDTH (MHz)	PASS/FAIL
36	5180	17.70	20.04	PASS
40	5200	17.70	19.99	PASS
48	5240	17.70	20.36	PASS
52	5260	17.70	19.97	PASS
60	5300	17.64	19.87	PASS
64	5320	17.70	19.93	PASS
100	5500	17.70	20.00	PASS
116	5580	17.64	19.95	PASS
140	5700	17.70	19.92	PASS
CHANNEL	CHANNEL FREQUENCY (MHz)	99% OCCUPIED BANDWIDTH	6dB BANDWIDTH (MHz)	PASS/FAIL
149	5745	17.70	17.60	PASS
157	5785	17.64	17.59	PASS
165	5825	17.64	17.59	PASS



802.11n (40MHz)

CHANNEL	CHANNEL FREQUENCY (MHz)	99% OCCUPIED BANDWIDTH	26dB BANDWIDTH (MHz)	PASS/FAIL
38	5190	36.18	41.19	PASS
46	5230	36.12	42.77	PASS
54	5270	36.12	40.92	PASS
62	5310	36.06	40.91	PASS
102	5510	36.24	40.84	PASS
110	5550	36.18	40.80	PASS
134	5670	36.18	41.17	PASS
CHANNEL	CHANNEL FREQUENCY (MHz)	99% OCCUPIED BANDWIDTH	6dB BANDWIDTH (MHz)	PASS/FAIL
151	5755	36.18	36.34	PASS
159	5795	36.18	36.33	PASS



BUREAU VERITAS

Test Report No.: RF180131W003-7

For U-NII-1:

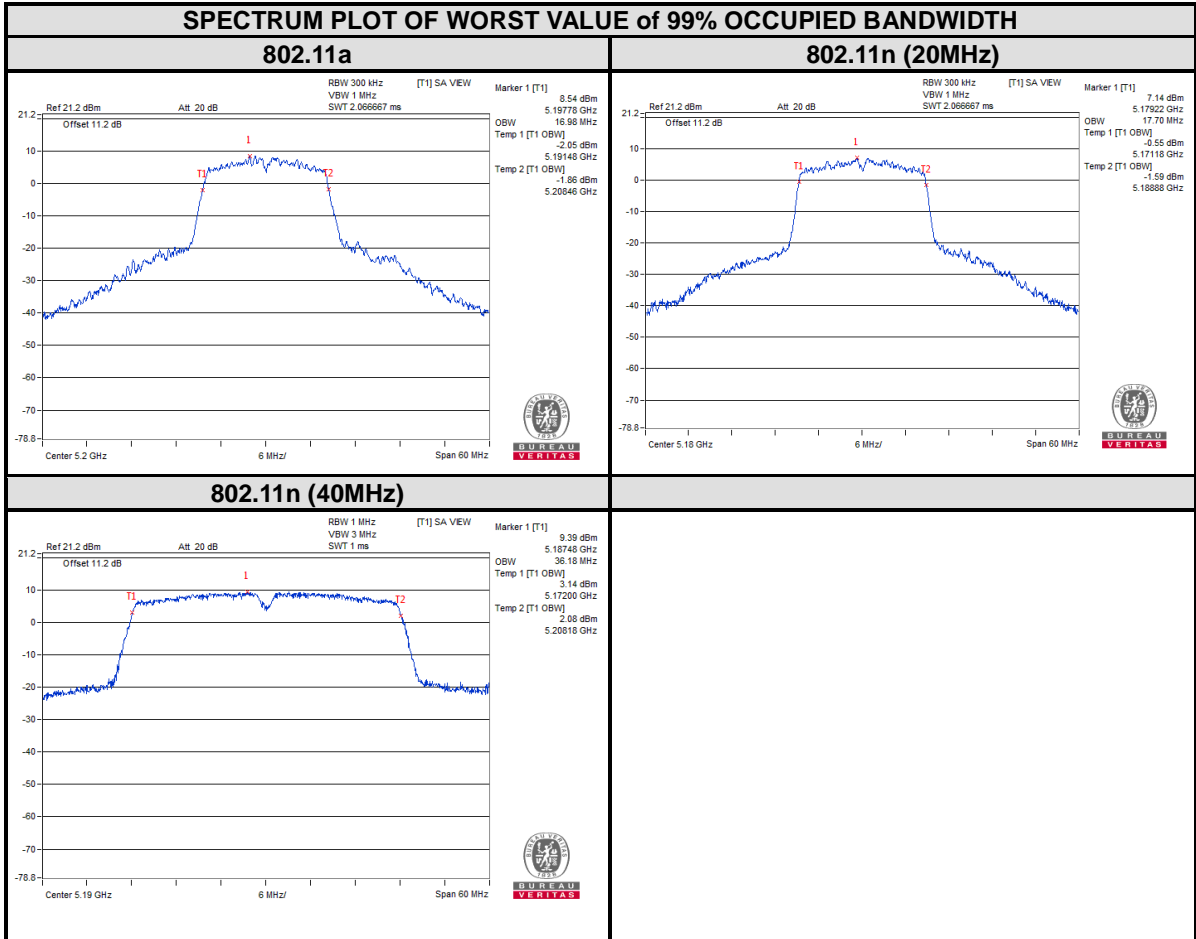



BUREAU VERITAS

Test Report No.: RF180131W003-7

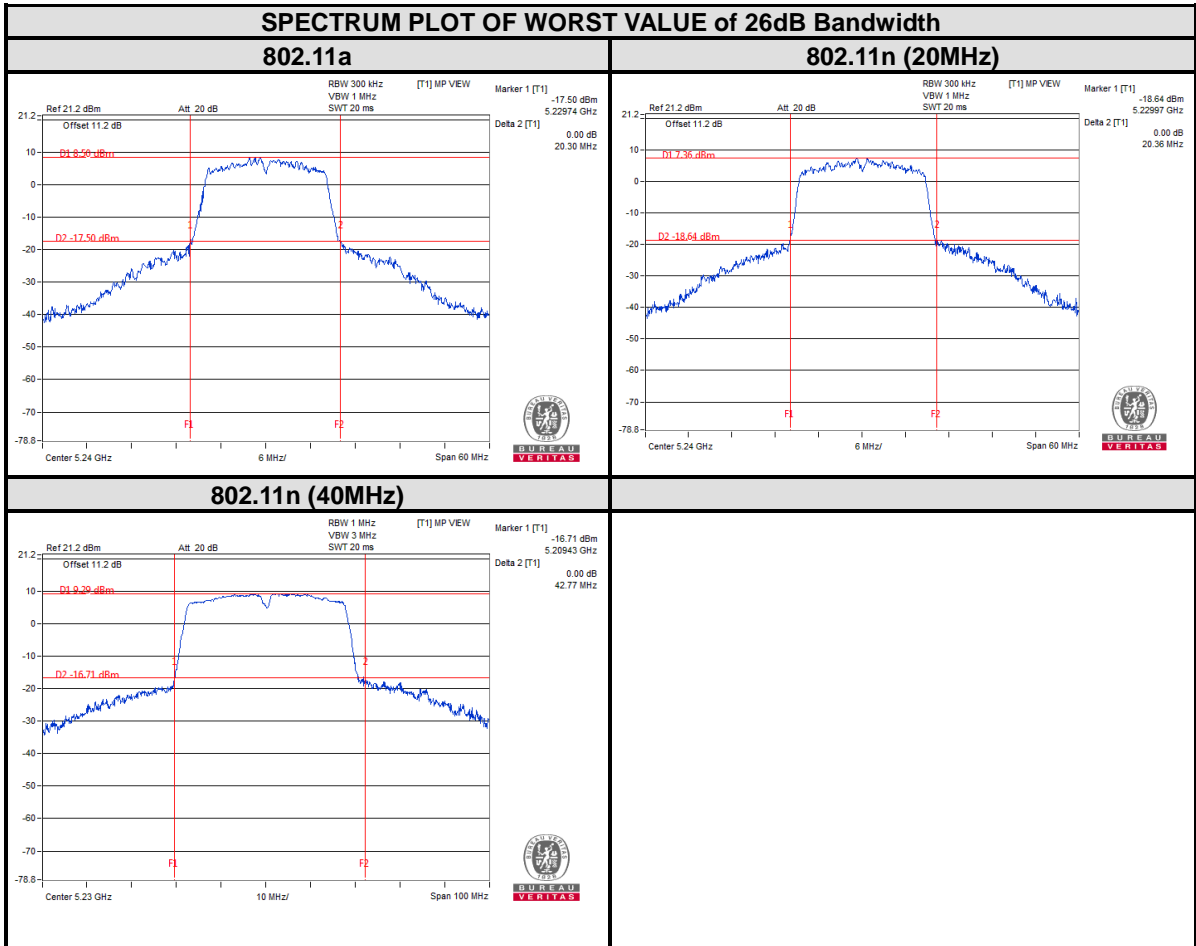



BUREAU VERITAS

Test Report No.: RF180131W003-7

For U-NII-2A:

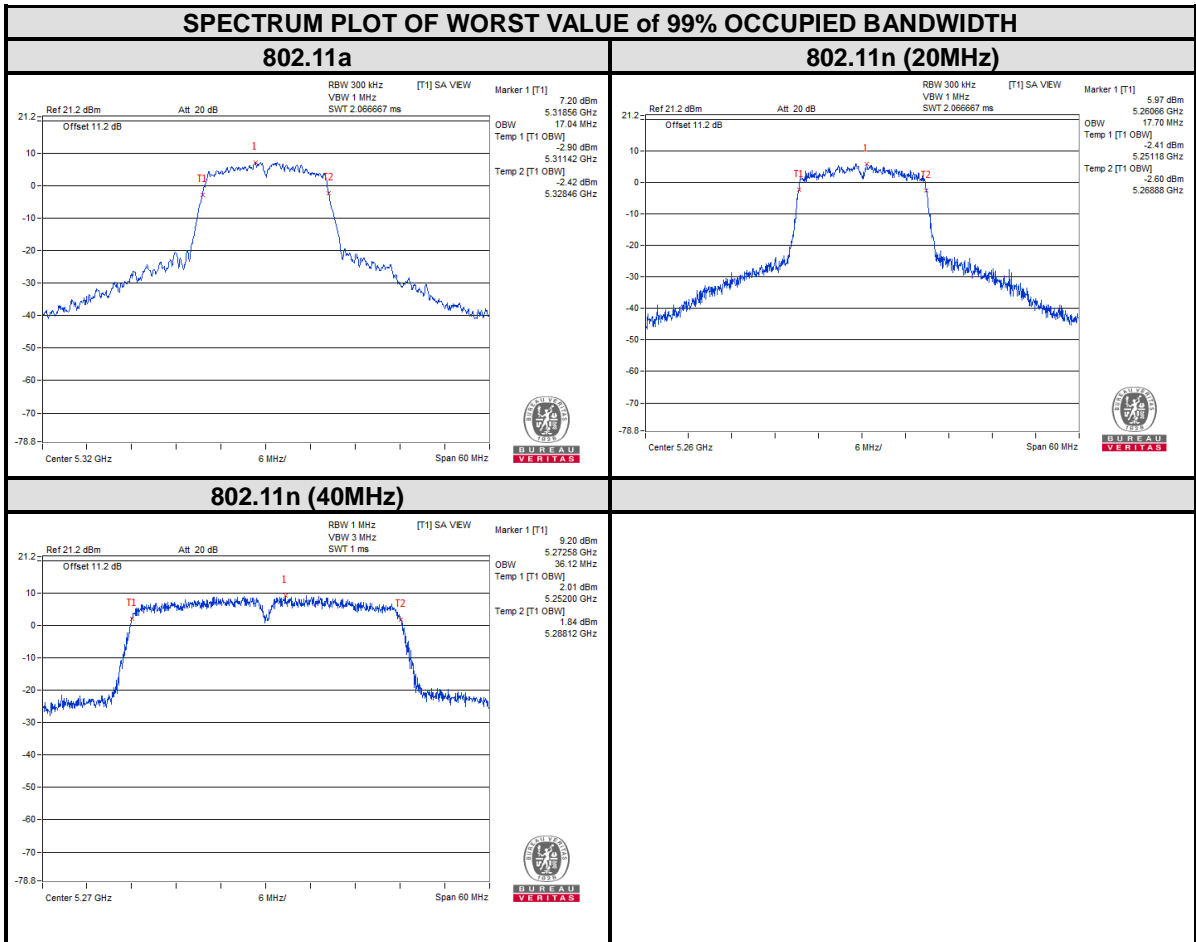



BUREAU VERITAS

Test Report No.: RF180131W003-7

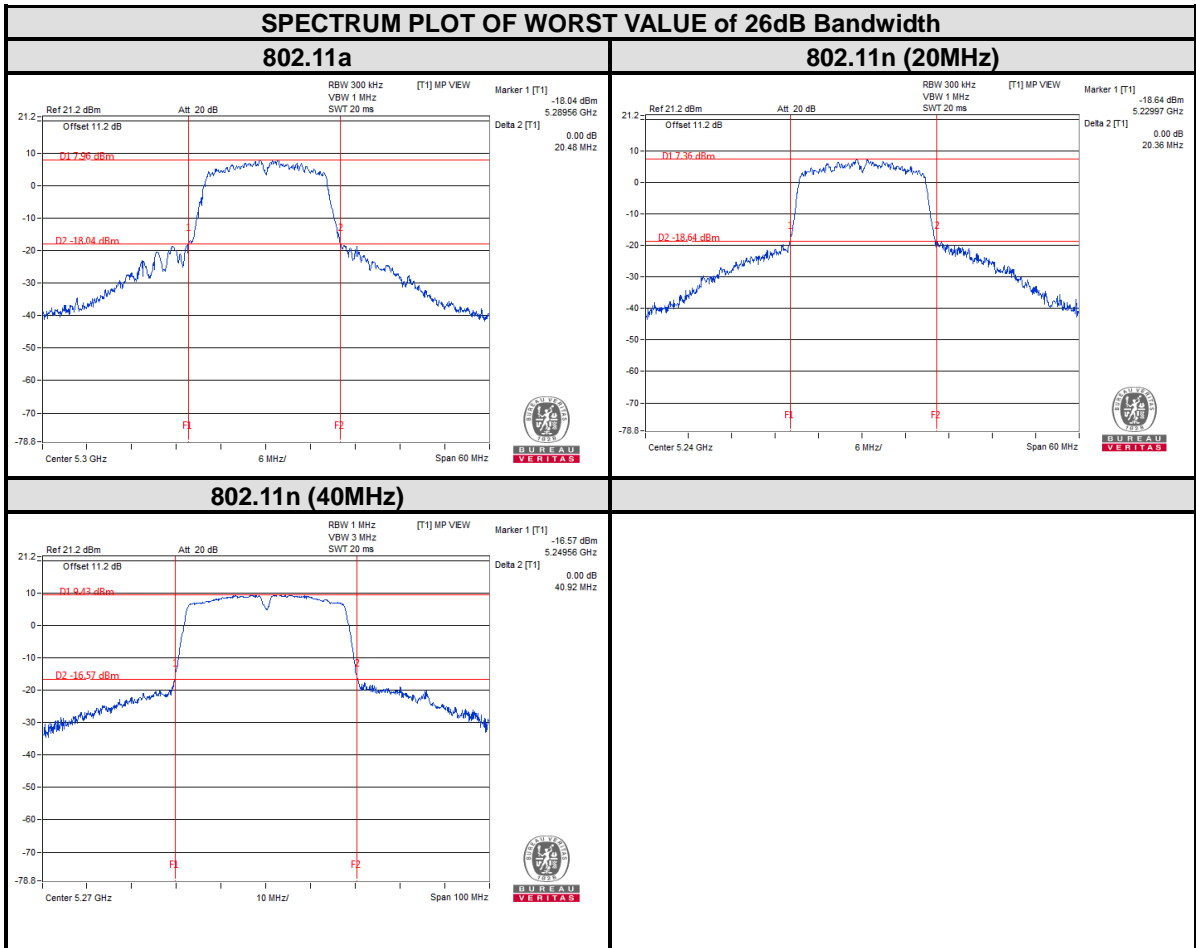



**BUREAU
VERITAS**

Test Report No.: RF180131W003-7

For U-NII-2C:

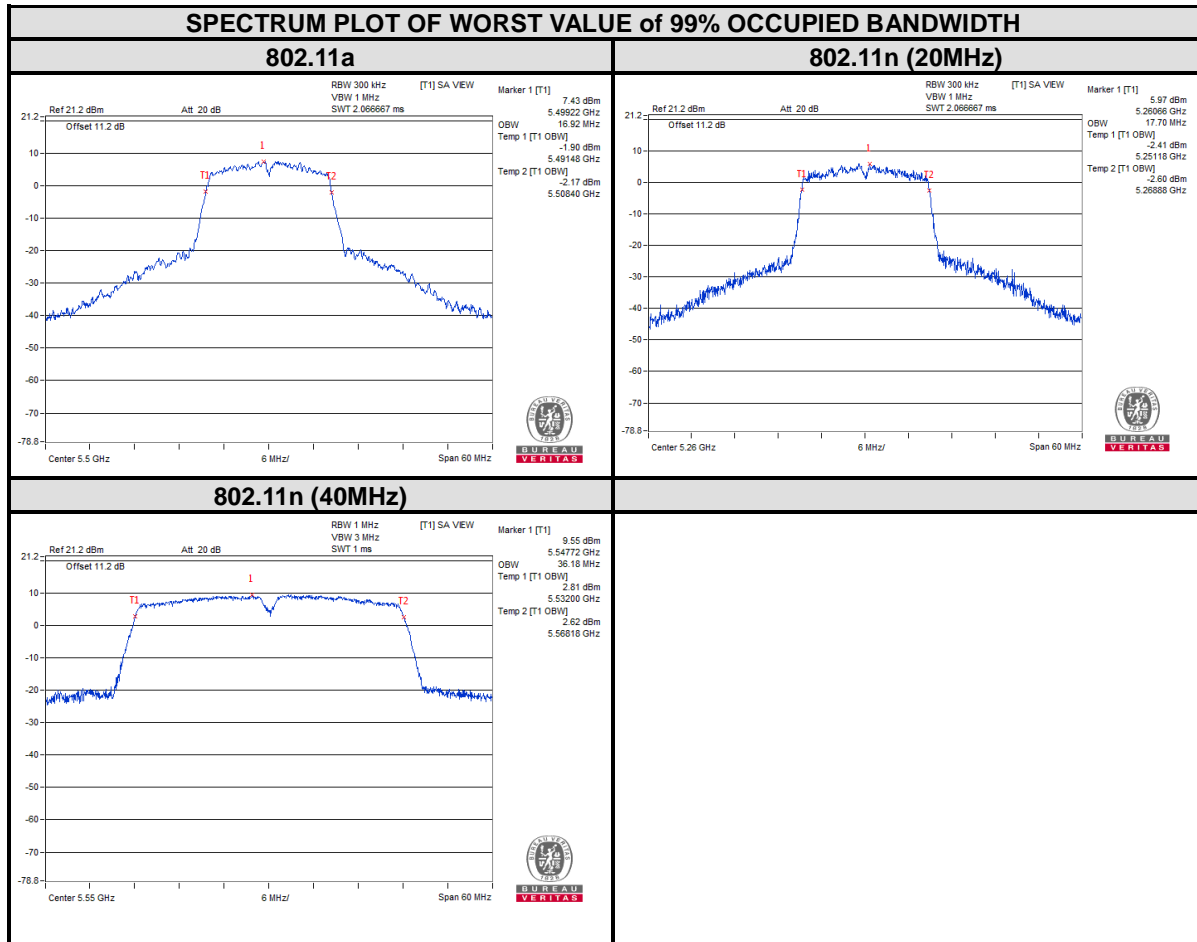



BUREAU VERITAS

Test Report No.: RF180131W003-7

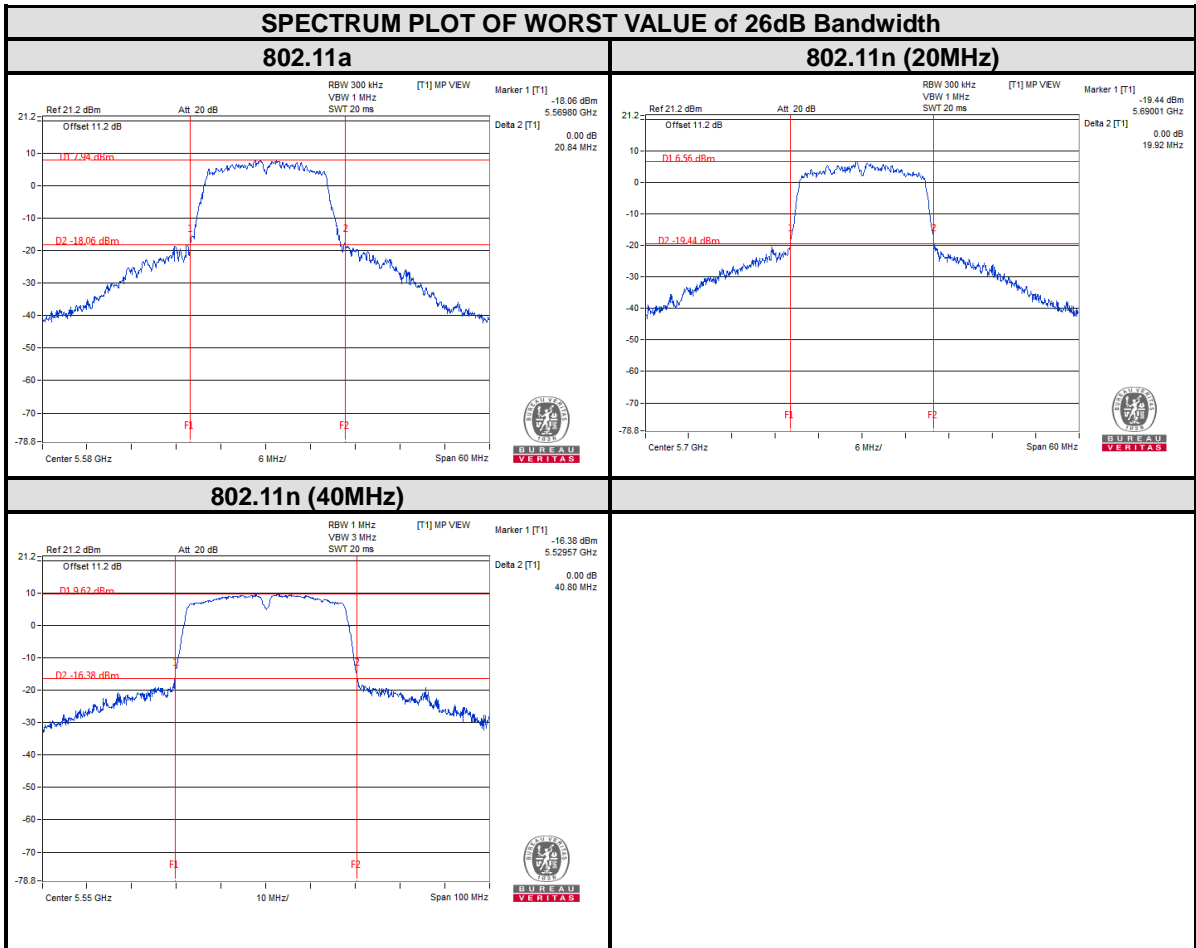



**BUREAU
VERITAS**

Test Report No.: RF180131W003-7

For U-NII-3:

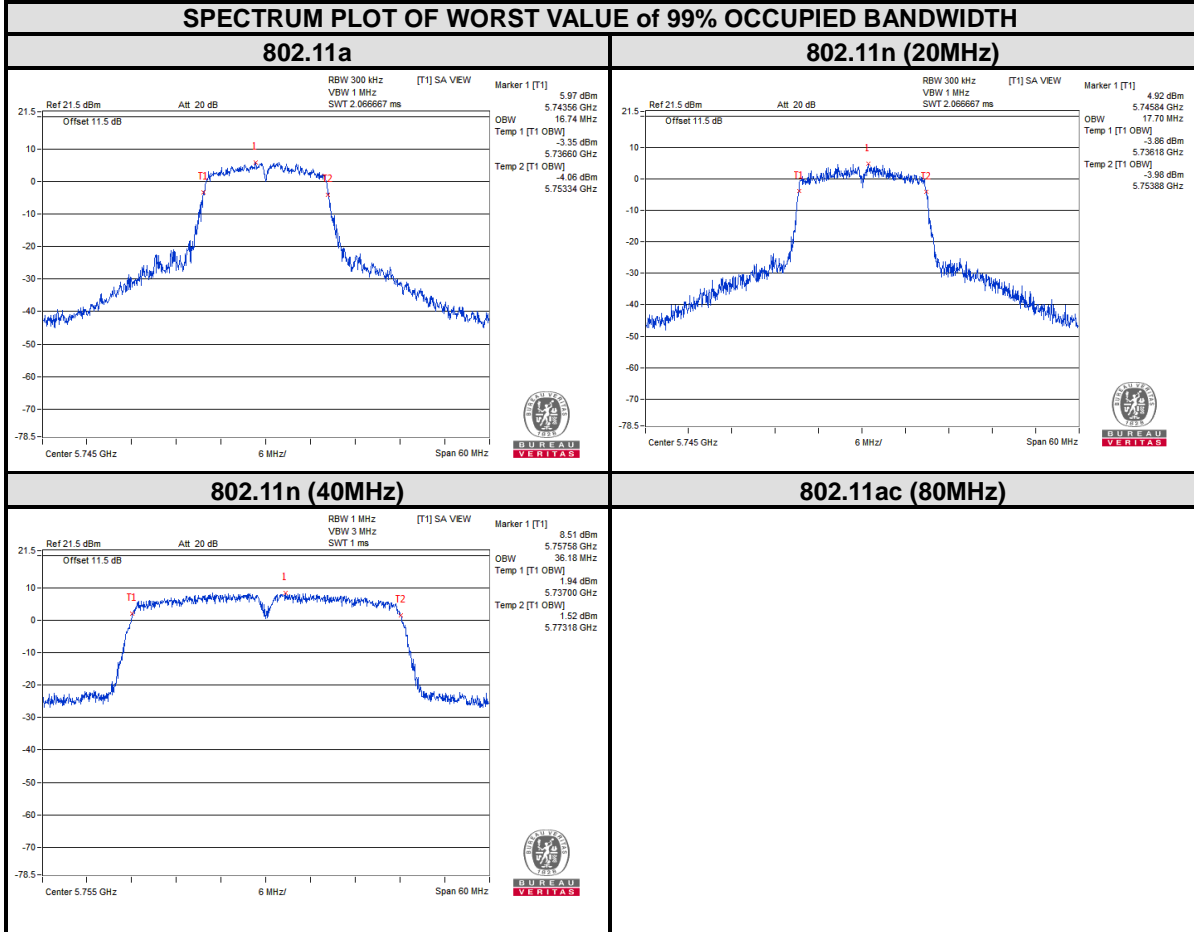



BUREAU VERITAS

Test Report No.: RF180131W003-7

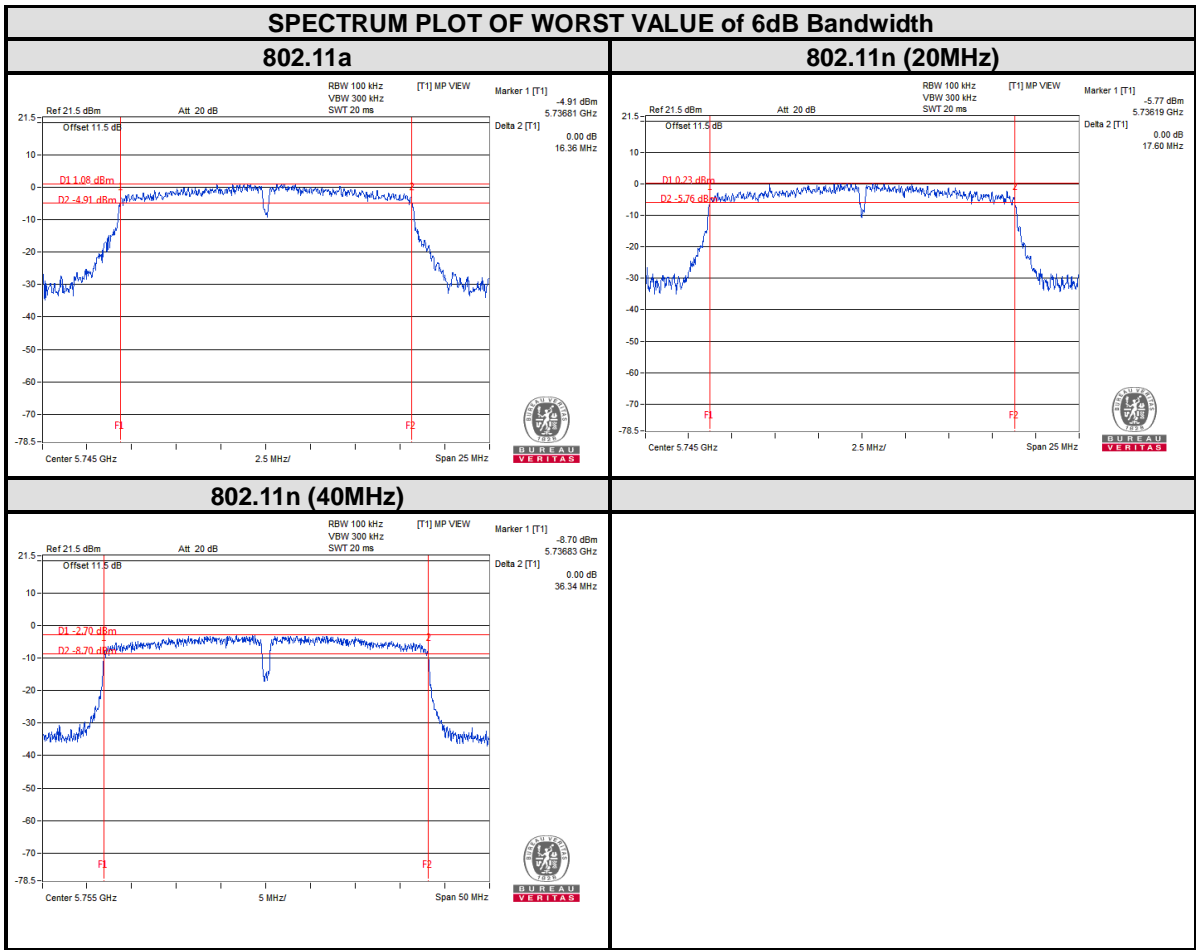



3.4 MAXIMUM POWER SPECTRAL DENSITY MEASUREMENT

3.4.1 LIMITS OF MAXIMUM POWER SPECTRAL DENSITY MEASUREMENT

Operation Band	EUT Category		LIMIT
U-NII-1		Outdoor Access Point	17dBm/ MHz
		Fixed point-to-point Access Point	
		Indoor Access Point	
	√	Client devices	11dBm/ MHz
U-NII-2A	√		11dBm/ MHz
U-NII-2C	√		11dBm/ MHz
U-NII-3	√		30dBm/ 500kHz

3.4.2 TEST SETUP

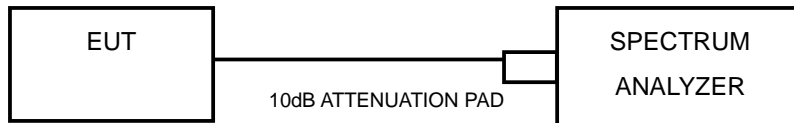

3.4.3 TEST INSTRUMENTS

Refer to section 3.3.3 to get information of above instrument.



3.4.4 TEST PROCEDURES

Using method SA-2

- 1) Set span to encompass the entire emission bandwidth (EBW) of the signal.
- 2) Set RBW = 1 MHz, Set VBW \geq 3 MHz, Detector = RMS
- 3) Set Channel power measure = 1MHz
- 4) Sweep time = auto, trigger set to "free run".
- 5) Trace average at least 100 traces in power averaging mode.
- 6) Add $10 \log (1/x)$, where x is the duty cycle, to the measured power in order to compute the average power during the actual transmission times (because the measurement represents an average over both the on and off times of the transmission).
- 7) Record the max value

3.4.5 DEVIATION FROM TEST STANDARD

No deviation.

3.4.6 EUT OPERATING CONDITIONS

Same as 3.1.6.



3.4.7 TEST RESULTS

For U-NII-1 & U-NII-2A:

802.11a

CHANNEL	FREQUENCY (MHz)	PSD w/o Duty Factor (dBm/MHz)	Duty Factor	PSD with Duty Factor (dBm/MHz)	MAXIMUM LIMIT (dBm/MHz)	PASS/FAIL
36	5180	4.95	0.15	5.10	11	PASS
40	5200	5.23	0.15	5.38	11	PASS
48	5240	4.99	0.15	5.14	11	PASS
52	5260	5.09	0.15	5.24	11	PASS
60	5300	4.78	0.15	4.93	11	PASS
64	5320	4.42	0.15	4.57	11	PASS
100	5500	4.65	0.15	4.80	11	PASS
116	5580	5.01	0.15	5.16	11	PASS
140	5700	3.93	0.15	4.08	11	PASS

802.11n (20MHz)

CHANNEL	FREQUENCY (MHz)	PSD w/o Duty Factor (dBm/MHz)	Duty Factor	PSD with Duty Factor (dBm/MHz)	MAXIMUM LIMIT (dBm/MHz)	PASS/FAIL
36	5180	3.71	0.20	3.91	11	PASS
40	5200	3.41	0.20	3.61	11	PASS
48	5240	4.06	0.20	4.26	11	PASS
52	5260	3.54	0.20	3.74	11	PASS
60	5300	3.19	0.20	3.39	11	PASS
64	5320	3.19	0.20	3.39	11	PASS
100	5500	3.54	0.20	3.74	11	PASS
116	5580	3.29	0.20	3.49	11	PASS
140	5700	3.05	0.20	3.25	11	PASS



802.11n (40MHz)

CHANNEL	FREQUENCY (MHz)	PSD w/o Duty Factor (dBm/MHz)	Duty Factor	PSD with Duty Factor (dBm/MHz)	MAXIMUM LIMIT (dBm/MHz)	PASS/FAIL
38	5190	0.49	0.29	0.78	11	PASS
46	5230	0.28	0.29	0.57	11	PASS
54	5270	0.45	0.29	0.74	11	PASS
62	5310	-0.13	0.29	0.16	11	PASS
102	5510	0.11	0.29	0.40	11	PASS
110	5550	0.51	0.29	0.80	11	PASS
134	5670	-0.94	0.29	-0.65	11	PASS



For U-NII-3:

802.11a

CHANNEL	FREQUENCY (MHz)	PSD w/o Duty Factor (dBm/MHz)	PSD w/o Duty Factor (dBm/500kHz)	Duty Factor	PSD with Duty Factor (dBm/500kHz)	LIMIT (dBm/500kHz)	PASS /FAIL
149	5745	12.16	9.15	0.15	9.30	30	PASS
157	5785	12.34	9.33	0.15	9.48	30	PASS
165	5825	11.72	8.71	0.15	8.86	30	PASS

802.11n (20MHz)

CHANNEL	FREQUENCY (MHz)	PSD w/o Duty Factor (dBm/MHz)	PSD w/o Duty Factor (dBm/500kHz)	Duty Factor	PSD with Duty Factor (dBm/500kHz)	LIMIT (dBm/500kHz)	PASS /FAIL
149	5745	11.17	8.16	0.20	8.36	30	PASS
157	5785	10.68	7.67	0.20	7.87	30	PASS
165	5825	10.31	7.30	0.20	7.50	30	PASS

802.11n (40MHz)

CHANNEL	FREQUENCY (MHz)	PSD w/o Duty Factor (dBm/MHz)	PSD w/o Duty Factor (dBm/500kHz)	Duty Factor	PSD with Duty Factor (dBm/500kHz)	LIMIT (dBm/500kHz)	PASS /FAIL
151	5755	8.13	5.12	0.29	5.41	30	PASS
159	5795	7.73	4.72	0.29	5.01	30	PASS



BUREAU VERITAS

Test Report No.: RF180131W003-7

For 5150~5250MHz

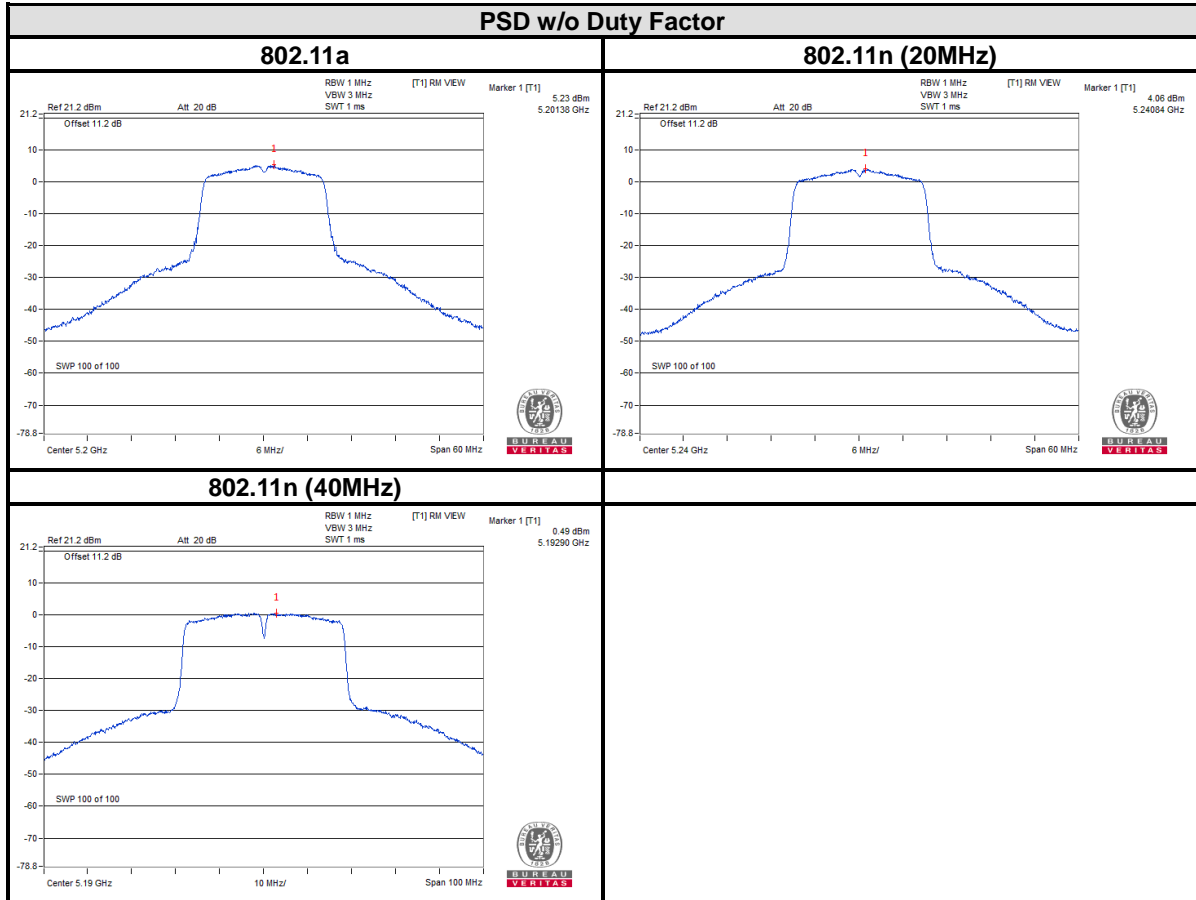



**BUREAU
VERITAS**

Test Report No.: RF180131W003-7

For 5250~5350MHz

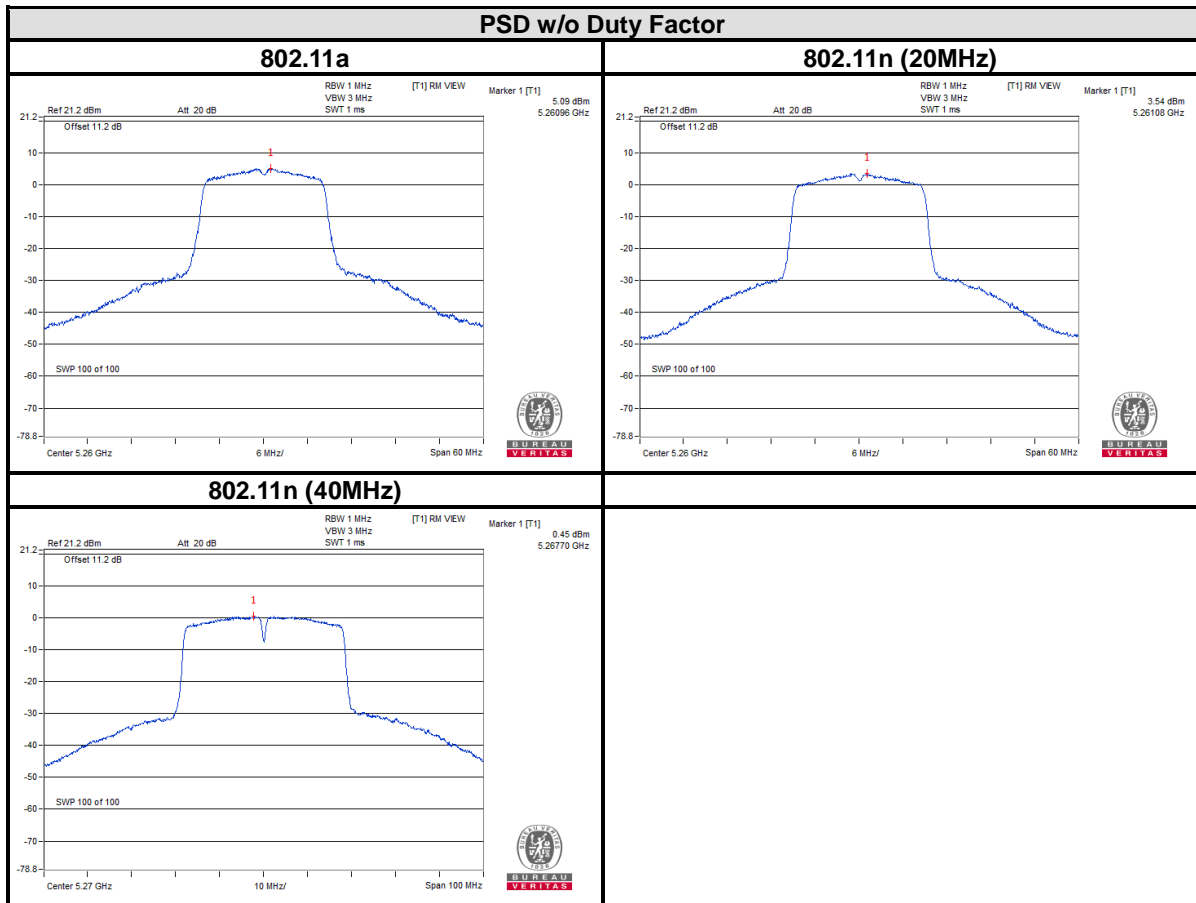



**BUREAU
VERITAS**

Test Report No.: RF180131W003-7

For 5470~5725MHz

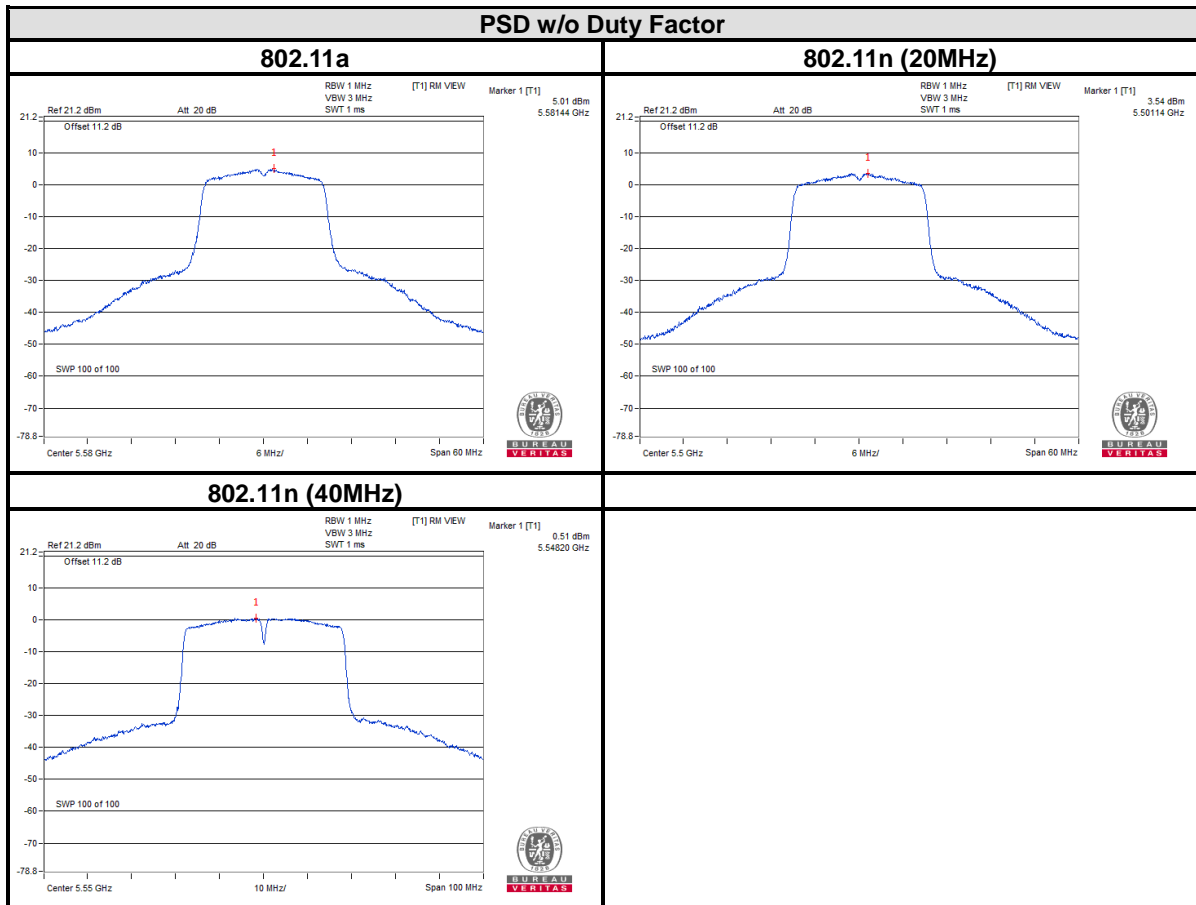



**BUREAU
VERITAS**

Test Report No.: RF180131W003-7

For 5725~5850MHz

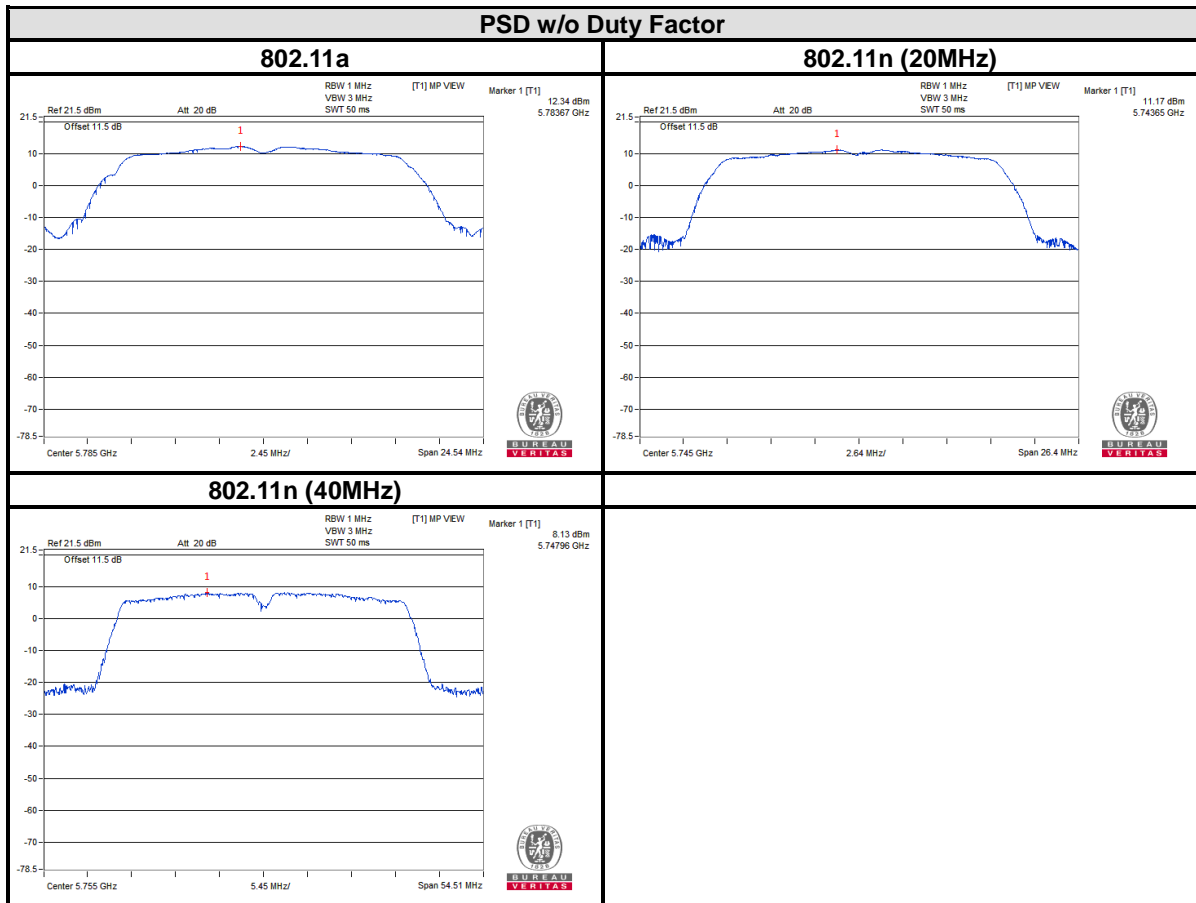



3.5 FREQUENCY STABILITY

3.5.1 LIMITS OF FREQUENCY STABILITY MEASUREMENT

The frequency of the carrier signal shall be maintained within band of operation

3.5.2 TEST SETUP

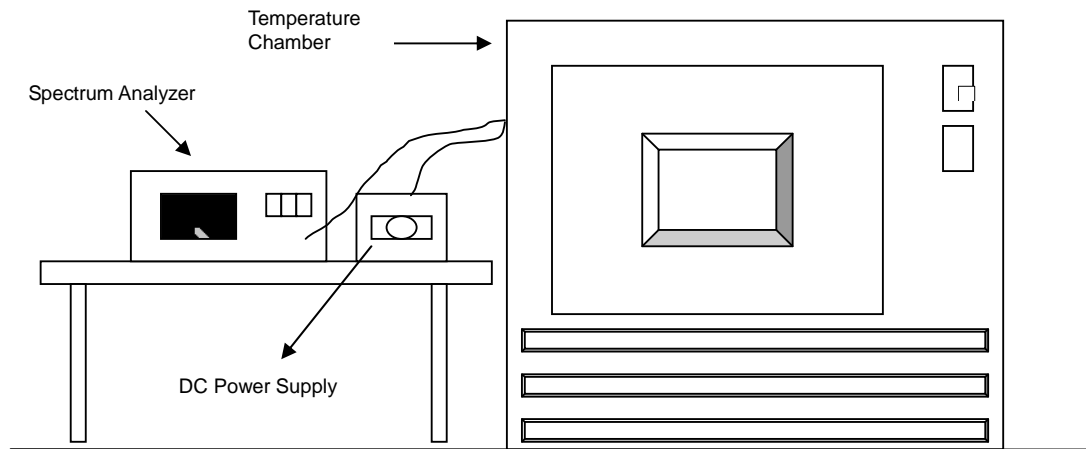

3.5.3 TEST INSTRUMENTS

Refer to section 3.3.3 to get information of above instrument.



3.5.4 TEST PROCEDURE

- a. The EUT was placed inside the environmental test chamber and powered by nominal DC voltage.
- b. Turn the EUT on and couple its output to a spectrum analyzer.
- c. Turn the EUT off and set the chamber to the highest temperature specified.
- d. Allow sufficient time (approximately 30 min) for the temperature of the chamber to stabilize, turn the EUT on and measure the operating frequency after 2, 5, and 10 minutes.
- e. Repeat step 2 and 3 with the temperature chamber set to the lowest temperature.
- f. The test chamber was allowed to stabilize at +20 degree C for a minimum of 30 minutes. The supply voltage was then adjusted on the EUT from 85% to 115% and the frequency record.

3.5.5 DEVIATION FROM TEST STANDARD

No deviation.

3.5.6 EUT OPERATING CONDITION

Set the EUT transmit at un-modulation mode to test frequency stability.



3.5.7 TEST RESULTS

FREQUENCY STABILITY VERSUS TEMP.										
OPERATING FREQUENCY: 5180MHz										
TEMP. (°C)	Power Supply (Vdc)	0 MINUTE		2 MINUTES		5 MINUTES		10 MINUTE		RESULT
		Measured Frequency (MHz)	Frequency Drift (ppm)	Measured Frequency (MHz)	Frequency Drift (ppm)	Measured Frequency (MHz)	Frequency Drift (ppm)	Measured Frequency (MHz)	Frequency Drift (ppm)	
50	120	5180.0247	4.7683	5180.0255	4.9228	5180.0244	4.7104	5180.0222	4.2857	PASS
40	120	5180.0026	0.5019	5180.0057	1.1004	5179.9983	-0.3282	5179.9992	-0.1544	PASS
30	120	5179.987	-2.5097	5179.9832	-3.2432	5179.9847	-2.9537	5179.9853	-2.8378	PASS
20	120	5179.9871	-2.4903	5179.988	-2.3166	5179.9849	-2.9151	5179.9943	-1.1004	PASS
10	120	5180.0139	2.6834	5180.0198	3.8224	5180.0176	3.3977	5180.0114	2.2008	PASS
0	120	5179.9977	-0.4440	5180.008	1.5444	5180.0022	0.4247	5180.0072	1.3900	PASS
-10	120	5179.9875	-2.4131	5179.9795	-3.9575	5179.98	-3.8610	5179.9829	-3.3012	PASS
-20	120	5180.0049	0.9459	5180.0067	1.2934	5179.9985	-0.2896	5180.0079	1.5251	PASS
-30	120	5179.9889	-2.1429	5179.9912	-1.6988	5179.9882	-2.2780	5179.9933	-1.2934	PASS

FREQUENCY STABILITY VERSUS VOLTAGE										
OPERATING FREQUENCY: 5180MHz										
TEMP. (°C)	Power Supply (Vdc)	0 MINUTE		2 MINUTE		5 MINUTE		10 MINUTE		RESULT
		Measured Frequency (MHz)	Frequency Drift (ppm)	Measured Frequency (MHz)	Frequency Drift (ppm)	Measured Frequency (MHz)	Frequency Drift (ppm)	Measured Frequency (MHz)	Frequency Drift (ppm)	
20	138	5179.9864	-2.6255	5179.9894	-2.0463	5179.9851	-2.8764	5179.9938	-1.1969	PASS
	120	5179.9871	-2.4903	5179.988	-2.3166	5179.9849	-2.9151	5179.9943	-1.1004	PASS
	102	5179.9866	-2.5869	5179.9876	-2.3938	5179.985	-2.8958	5179.994	-1.1583	PASS



FREQUENCY STABILITY VERSUS TEMP.										
OPERATING FREQUENCY: 5825MHz										
TEMP. (°C)	Power Supply (Vdc)	0 MINUTE		2 MINUTES		5 MINUTES		10 MINUTE		RESULT
		Measured Frequency (MHz)	Frequency Drift (ppm)	Measured Frequency (MHz)	Frequency Drift (ppm)	Measured Frequency (MHz)	Frequency Drift (ppm)	Measured Frequency (MHz)	Frequency Drift (ppm)	
50	120	5824.9772	-3.914	5824.9744	-4.395	5824.9809	-3.279	5824.9766	-4.017	PASS
40	120	5824.988	-2.060	5824.9823	-3.039	5824.9845	-2.661	5824.9828	-2.953	PASS
30	120	5824.9764	-4.052	5824.9794	-3.536	5824.9835	-2.833	5824.9793	-3.554	PASS
20	120	5824.9888	-1.923	5824.9829	-2.936	5824.99	-1.717	5824.9883	-2.009	PASS
10	120	5824.9764	-4.052	5824.9676	-5.562	5824.9772	-3.914	5824.9658	-5.871	PASS
0	120	5824.9986	-0.240	5824.9997	-0.052	5825.0022	0.378	5825.0038	0.652	PASS
-10	120	5825.0116	1.991	5825.0167	2.867	5825.0146	2.506	5825.0081	1.391	PASS
-20	120	5824.9765	-4.034	5824.9771	-3.931	5824.9814	-3.193	5824.9854	-2.506	PASS
-30	120	5825.0245	4.206	5825.016	2.747	5825.0221	3.794	5825.0254	4.361	PASS

FREQUENCY STABILITY VERSUS VOLTAGE										
OPERATING FREQUENCY: 5825MHz										
TEMP. (°C)	Power Supply (Vdc)	0 MINUTE		2 MINUTE		5 MINUTE		10 MINUTE		RESULT
		Measured Frequency (MHz)	Frequency Drift (ppm)	Measured Frequency (MHz)	Frequency Drift (ppm)	Measured Frequency (MHz)	Frequency Drift (ppm)	Measured Frequency (MHz)	Frequency Drift (ppm)	
20	138	5824.9875	-2.146	5824.9839	-2.764	5824.99	-1.717	5824.9887	-1.940	PASS
	120	5824.9888	-1.923	5824.9829	-2.936	5824.99	-1.717	5824.9883	-2.009	PASS
	102	5824.9867	-2.283	5824.9829	-2.936	5824.9895	-1.803	5824.9884	-1.991	PASS



BUREAU Test Report No.: RF180131W003-7
VERITAS

4 PHOTOGRAPHS OF THE TEST CONFIGURATION

Please refer to the attached file (Test Setup Photo).



**BUREAU
VERITAS**

Test Report No.: RF180131W003-7

5 APPENDIX A – MODIFICATIONS RECORDERS FOR ENGINEERING CHANGES TO THE EUT BY THE LAB

No modifications were made to the EUT by the lab during the test.

---END---