



FCC RF Test Report

APPLICANT : HMD Global Oy
EQUIPMENT : Smart Phone
BRAND NAME : Nokia
MODEL NAME : TA-1046
FCC ID : 2AJOTTA-1046
STANDARD : 47 CFR Part 2, 22(H), 24(E), 27
CLASSIFICATION : PCS Licensed Transmitter Held to Ear (PCE)

The product was received on Dec, 07, 2017 and completely tested on Mar. 10, 2018. We, SPORTON INTERNATIONAL Inc., would like to declare that the tested sample has been evaluated in accordance with the test procedures given in ANSI / TIA-603-E and the testing has shown the tested sample to be in compliance with the applicable technical standards.

The test results in this report apply exclusively to the tested model / sample. Without written approval of SPORTON INTERNATIONAL INC., the test report shall not be reproduced except in full.

Reviewed by: Joseph Lin / Supervisor

Approved by: Jones Tsai / Manager



SPORTON INTERNATIONAL INC.

No. 52, Hwa Ya 1st Rd., Hwa Ya Technology Park, Kwei-Shan District, Tao Yuan City, Taiwan, R.O.C.

SPORTON INTERNATIONAL INC.

TEL : 886-3-327-3456

FAX : 886-3-328-4978

FCC ID: 2AJOTTA-1046

Page Number : 1 of 21

Report Issued Date : Mar. 15, 2018

Report Version : Rev. 01

Report Template No.: BU5-FGLTE Version 2.0



TABLE OF CONTENTS

REVISION HISTORY.....3

SUMMARY OF TEST RESULT4

1 GENERAL DESCRIPTION5

 1.1 Applicant5

 1.2 Manufacturer.....5

 1.3 Product Feature of Equipment Under Test.....5

 1.4 Modification of EUT5

 1.5 Testing Location6

 1.6 Applicable Standards.....6

2 TEST CONFIGURATION OF EQUIPMENT UNDER TEST7

 2.1 Test Mode.....7

 2.2 Connection Diagram of Test System.....8

 2.3 Support Unit used in test configuration and system9

 2.4 Measurement Results Explanation Example.....9

 2.5 Frequency List of Low/Middle/High Channels9

3 CONDUCTED TEST ITEMS11

 3.1 Measuring Instruments11

 3.2 Test Setup11

 3.3 Test Result of Conducted Test11

 3.4 Conducted Output Power and ERP/EIRP12

 3.5 Peak-to-Average Ratio13

 3.6 Occupied Bandwidth.....14

 3.7 Conducted Band Edge15

 3.8 Conducted Spurious Emission16

 3.9 Frequency Stability17

4 RADIATED TEST ITEMS18

 4.1 Measuring Instruments18

 4.2 Test Setup18

 4.3 Test Result of Radiated Test18

 4.4 Radiated Spurious Emission19

5 LIST OF MEASURING EQUIPMENT20

6 UNCERTAINTY OF EVALUATION.....21

APPENDIX A. TEST RESULTS OF CONDUCTED TEST

APPENDIX B. TEST RESULTS OF ERP/EIRP AND RADIATED TEST

APPENDIX C. TEST SETUP PHOTOGRAPHS



SUMMARY OF TEST RESULT

Report Section	FCC Rule	Description	Limit	Result	Remark
3.4	§2.1046	Conducted Output Power	Reporting Only	PASS	-
	§22.913(a)(2)	Effective Radiated Power (Band 5)	ERP < 7 Watt		
	§27.50(h)(2)	Equivalent Isotropic Radiated Power (Band 7) (Band 38) (Band 41)	EIRP < 2Watt		
3.5	§24.232(d)	Peak-to-Average Ratio	<13 dB	PASS	-
3.6	§2.1049	Occupied Bandwidth	Reporting Only	PASS	-
3.7	§2.1051 §22.917(a)	Conducted Band Edge Measurement (Band 5)	< 43+10log ₁₀ (P[Watts])	PASS	-
	§27.53(m)(4)	Conducted Band Edge Measurement (Band 7) (Band 38) (Band 41)	§27.53(m)(4)		
3.8	§2.1051 §22.917(a)	Conducted Spurious Emission (Band 5)	< 43+10log ₁₀ (P[Watts])	PASS	-
	§2.1051 §27.53(m)(4)	Conducted Spurious Emission (Band 7) (Band 38) (Band 41)	< 55+10log ₁₀ (P[Watts])		
3.9	§2.1055 §22.355	Frequency Stability Temperature & Voltage	< 2.5 ppm for Part 22	PASS	-
	§2.1055 §24.235 §27.54		Within Authorized Band		
4.4	§2.1053 §22.917(a)	Radiated Spurious Emission (Band 5)	< 43+10log ₁₀ (P[Watts])	PASS	Under limit 16.86 dB at 2520.000 MHz
	§2.1053 §27.53(m)(4)	Radiated Spurious Emission (Band 7) (Band 38) (Band 41)	< 55+10log ₁₀ (P[Watts])		



1 General Description

1.1 Applicant

HMD Global Oy
Karaportti 2, 02610 Espoo, Finland

1.2 Manufacturer

HMD Global Oy
Karaportti 2, 02610 Espoo, Finland

1.3 Product Feature of Equipment Under Test

GSM/WCDMA/LTE, Bluetooth, Wi-Fi 2.4GHz 802.11b/g/n, Wi-Fi 5GHz 802.11a/n/ac, NFC, and GNSS

Product specification subjective to this standard	
Antenna Type	WWAN: PIFA Antenna WLAN: PIFA Antenna Bluetooth: PIFA Antenna NFC: Single Loop Antenna GPS/GLONASS/BDS: PIFA Antenna

1.4 Modification of EUT

No modifications are made to the EUT during all test items.



1.5 Testing Location

Sporton Lab is accredited to ISO 17025 by Taiwan Accreditation Foundation (TAF code : 1190) and the FCC designation No. TW1190 and TW0007 under the FCC 2.948(e) by Mutual Recognition Agreement (MRA) in FCC Test.

Test Site	SPORTON INTERNATIONAL INC.
Test Site Location	No. 52, Hwa Ya 1 st Rd., Hwa Ya Technology Park, Kwei-Shan District, Tao Yuan City, Taiwan, R.O.C. TEL: +886-3-327-3456 FAX: +886-3-328-4978
Test Site No.	Sporton Site No.
	TH05-HY

Note: The test site complies with ANSI C63.4 2014 requirement.

Test Site	SPORTON INTERNATIONAL INC.
Test Site Location	No.58, Aly. 75, Ln. 564, Wenhua 3rd Rd. Guishan Dist, Taoyuan City, Taiwan (R.O.C.) TEL: +886-3-327-0868 FAX: +886-3-327-0855
Test Site No.	Sporton Site No.
	03CH12-HY

Note: The test site complies with ANSI C63.4 2014 requirement.

1.6 Applicable Standards

According to the specifications of the manufacturer, the EUT must comply with the requirements of the following standards:

- ♦ 47 CFR Part 2, 22(H), 24(E), 27
- ♦ ANSI / TIA-603-E
- ♦ FCC KDB 971168 D01 Power Meas. License Digital Systems v03
- ♦ FCC KDB 412172 D01 Determining ERP and EIRP v01r01

Remark:

1. All test items were verified and recorded according to the standards and without any deviation during the test.
2. This EUT has also been tested and complied with the requirements of FCC Part 15, Subpart B, Subpart B, recorded in a separate test report.



2 Test Configuration of Equipment Under Test

2.1 Test Mode

Antenna port conducted and radiated test items listed below are performed according to KDB 971168 D01 Power Meas. License Digital Systems v03 with maximum output power.

Radiated measurements are performed by rotating the EUT in three different orthogonal test planes to find the maximum emission.

Test Items	Band	Bandwidth (MHz)						Modulation			RB #			Test Channel		
		1.4	3	5	10	15	20	QPSK	16QAM	64QAM	1	Half	Full	L	M	H
Max. Output Power	5	v	v	v	v	-	-	v	v	v	v	v	v	v	v	v
	7	-	-	v	v	v	v	v	v	v	v	v	v	v	v	v
	38	-	-	v	v	v	v	v	v	v	v	v	v	v	v	v
	41	-	-	v	v	v	v	v	v	v	v	v	v	v	v	v
Peak-to-Average Ratio	5				v	-	-	v	v	v	v		v	v	v	v
	7	-	-				v	v	v	v	v		v	v	v	v
	38	Cover by LTE Band 41														
	41	-	-				v	v	v	v	v	v		v	v	v
26dB and 99% Bandwidth	5	v	v	v	v	-	-	v	v	v	v		v	v	v	v
	7	-	-	v	v	v	v	v	v	v	v		v	v	v	v
	38	Cover by LTE Band 41														
	41	-	-	v	v	v	v	v	v	v	v	v		v	v	v
Conducted Band Edge	5	v	v	v	v	-	-	v	v	v	v		v	v		v
	7	-	-	v	v	v	v	v	v	v	v		v	v		v
	38	Cover by LTE Band 41														
	41	-	-	v	v	v	v	v	v	v	v	v		v	v	
Conducted Spurious Emission	5	v	v	v	v	-	-	v	v	v	v			v	v	v
	7	-	-	v	v	v	v	v	v	v	v			v	v	v
	38	Cover by LTE Band 41														
	41	-	-	v	v	v	v	v	v	v	v	v			v	v
Frequency Stability	5				v	-	-	v					v		v	
	7	-	-		v			v					v		v	
	38	Cover by LTE Band 41														
	41	-	-		v			v						v		v

Test Items	Band	Bandwidth (MHz)						Modulation			RB #			Test Channel		
		1.4	3	5	10	15	20	QPSK	16QAM	64QAM	1	Half	Full	L	M	H
E.R.P / E.I.R.P	5	v	v	v	v	-	-	v	v	v	v			v	v	v
	7	-	-	v	v	v	v	v	v	v	v			v	v	v
	38	-	-	v	v	v	v	v	v	v	v			v	v	v
	41	-	-	v	v	v	v	v	v	v	v			v	v	v
Emission	5	Worst Case											v	v	v	
	7	Worst Case											v	v	v	
	38	Cover by LTE Band 41														
	41	Worst Case											v	v	v	
Note	1. The mark "v " means that this configuration is chosen for testing 2. The mark "- " means that this bandwidth is not supported. 3. The device is investigated from 30MHz to 10 times of fundamental signal for radiated spurious emission test under different RB size/offset and modulations in exploratory test. Subsequently, only the worst case emissions are reported.															

2.2 Connection Diagram of Test System

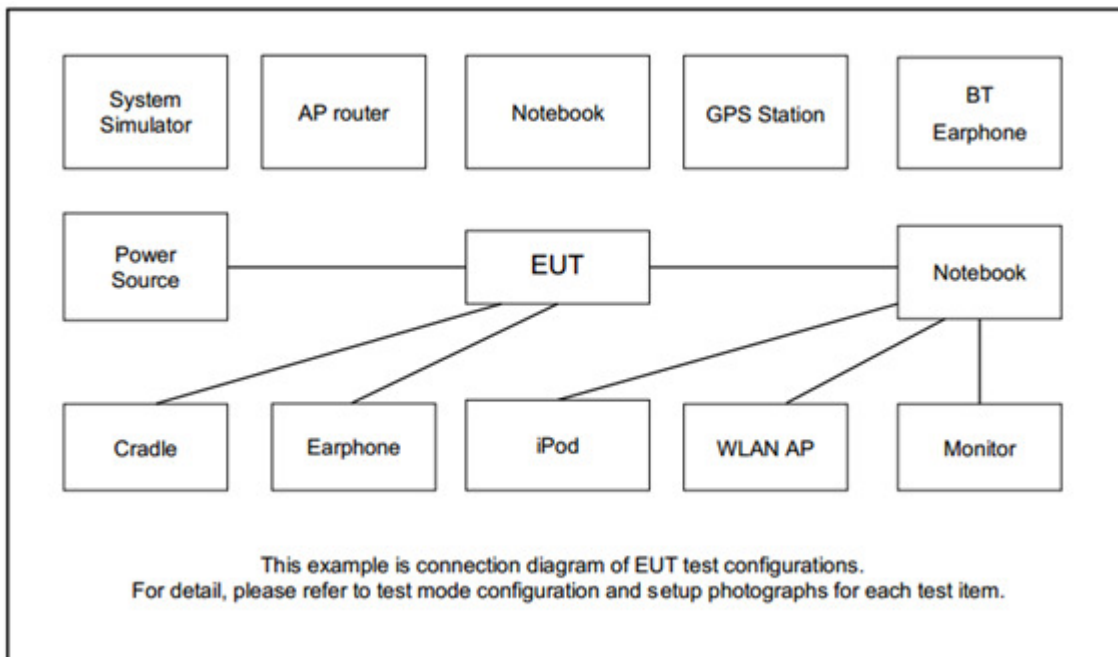



2.3 Support Unit used in test configuration and system

Item	Equipment	Trade Name	Model No.	FCC ID	Data Cable	Power Cord
1.	System Simulator	Anritsu	MT8820C	N/A	N/A	Unshielded, 1.8 m

2.4 Measurement Results Explanation Example

For all conducted test items:

The offset level is set in the spectrum analyzer to compensate the RF cable loss and attenuator factor between EUT conducted output port and spectrum analyzer. With the offset compensation, the spectrum analyzer reading level is exactly the EUT RF output level.

The spectrum analyzer offset is derived from RF cable loss and attenuator factor.

Offset = RF cable loss + attenuator factor.

Following shows an offset computation example with cable loss 4.2 dB and 10dB attenuator.

Example :

$$\begin{aligned}
 \text{Offset(dB)} &= \text{RF cable loss(dB)} + \text{attenuator factor(dB)}. \\
 &= 4.2 + 10 = 14.2 \text{ (dB)}
 \end{aligned}$$

2.5 Frequency List of Low/Middle/High Channels

LTE Band 5 Channel and Frequency List				
BW [MHz]	Channel/Frequency(MHz)	Lowest	Middle	Highest
10	Channel	20450	20525	20600
	Frequency	829	836.5	844
5	Channel	20425	20525	20625
	Frequency	826.5	836.5	846.5
3	Channel	20415	20525	20635
	Frequency	825.5	836.5	847.5
1.4	Channel	20407	20525	20643
	Frequency	824.7	836.5	848.3



LTE Band 7 Channel and Frequency List				
BW [MHz]	Channel/Frequency(MHz)	Lowest	Middle	Highest
20	Channel	20850	21100	21350
	Frequency	2510	2535	2560
15	Channel	20825	21100	21375
	Frequency	2507.5	2535	2562.5
10	Channel	20800	21100	21400
	Frequency	2505	2535	2565
5	Channel	20775	21100	21425
	Frequency	2502.5	2535	2567.5

LTE Band 38 Channel and Frequency List				
BW [MHz]	Channel/Frequency(MHz)	Lowest	Middle	Highest
20	Channel	37850	38000	38150
	Frequency	2580	2595	2610
15	Channel	37825	38000	38175
	Frequency	2577.5	2595	2612.5
10	Channel	37800	38000	38200
	Frequency	2575	2595	2615
5	Channel	37775	38000	38225
	Frequency	2572.5	2595	2617.5

LTE Band 41 Channel and Frequency List				
BW [MHz]	Channel/Frequency(MHz)	Lowest	Middle	Highest
20	Channel	39750	40620	41490
	Frequency	2506	2593	2680
15	Channel	39725	40620	41515
	Frequency	2503.5	2593	2682.5
10	Channel	39700	40620	41540
	Frequency	2501	2593	2685
5	Channel	39675	40620	41565
	Frequency	2498.5	2593	2687.5

3 Conducted Test Items

3.1 Measuring Instruments

See list of measuring instruments of this test report.

3.2 Test Setup

3.2.1 Conducted Output Power

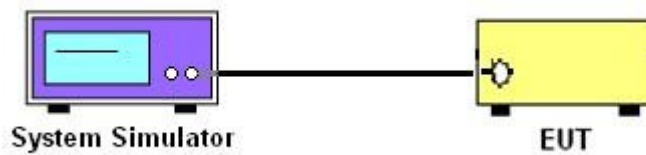

3.2.2 Peak-to-Average Ratio, Occupied Bandwidth ,Conducted Band-Edge and Conducted Spurious Emission

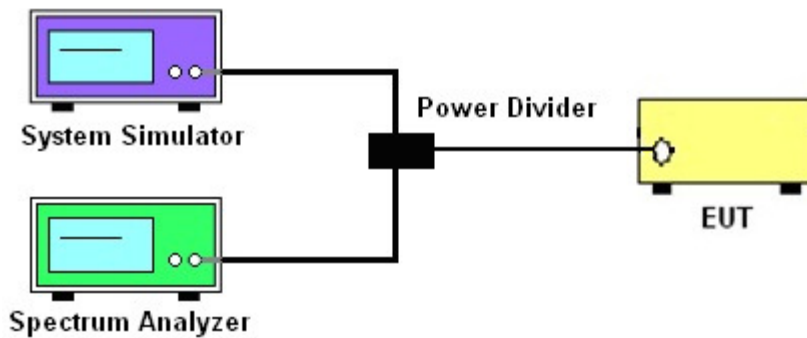

3.2.3 Frequency Stability

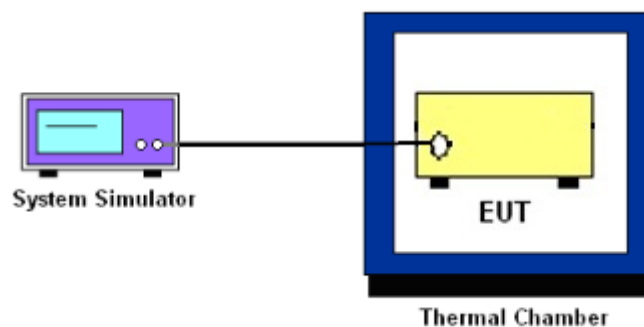

3.3 Test Result of Conducted Test

Please refer to Appendix A.



3.4 Conducted Output Power and ERP/EIRP

3.4.1 Description of the Conducted Output Power Measurement and ERP/EIRP Measurement

A system simulator was used to establish communication with the EUT. Its parameters were set to force the EUT transmitting at maximum output power. The measured power in the radio frequency on the transmitter output terminals shall be reported.

The ERP of mobile transmitters must not exceed 7 Watts for LTE Band 5.

The EIRP of mobile transmitters must not exceed 2 Watts for LTE Band 7 and Band 38 and Band 41.

According to KDB 412172 D01 Power Approach,

$EIRP = P_T + G_T - L_C$, $ERP = EIRP - 2.15$, where

P_T = transmitter output power in dBm

G_T = gain of the transmitting antenna in dBi

L_C = signal attenuation in the connecting cable between the transmitter and antenna in dB

3.4.2 Test Procedures

1. The transmitter output port was connected to the system simulator.
2. Set EUT at maximum power through the system simulator.
3. Select lowest, middle, and highest channels for each band and different modulation.
4. Measure and record the power level from the system simulator.



3.5 Peak-to-Average Ratio

3.5.1 Description of the PAR Measurement

Power Complementary Cumulative Distribution Function (CCDF) curves provide a means for characterizing the power peaks of a digitally modulated signal on a statistical basis. A CCDF curve depicts the probability of the peak signal amplitude exceeding the average power level. Most contemporary measurement instrumentation include the capability to produce CCDF curves for an input signal provided that the instrument's resolution bandwidth can be set wide enough to accommodate the entire input signal bandwidth. In measuring transmissions in this band using an average power technique, the peak-to-average ratio (PAR) of the transmission may not exceed 13 dB.

3.5.2 Test Procedures

The testing follows FCC KDB 971168 v03 Section 5.7.1

1. The EUT was connected to spectrum and system simulator via a power divider.
2. Set the CCDF (Complementary Cumulative Distribution Function) option in spectrum analyzer.
3. The highest RF powers were measured and recorded the maximum PAPR level associated with a probability of 0.1 %.
4. Record the deviation as Peak to Average Ratio.



3.6 Occupied Bandwidth

3.6.1 Description of Occupied Bandwidth Measurement

The occupied bandwidth is the width of a frequency band such that, below the lower and above the upper frequency limits, the mean powers emitted are each equal to a specified percentage 0.5% of the total mean transmitted power.

The 26 dB emission bandwidth is defined as the frequency range between two points, one above and one below the carrier frequency, at which the spectral density of the emission is attenuated 26 dB below the maximum in-band spectral density of the modulated signal. Spectral density (power per unit bandwidth) is to be measured with a detector of resolution bandwidth equal to approximately 1.0% of the emission bandwidth.

3.6.2 Test Procedures

The testing follows FCC KDB 971168 v03 Section 4.2

1. The EUT was connected to spectrum analyzer and system simulator via a power divider.
2. The spectrum analyzer center frequency is set to the nominal EUT channel center frequency. The span range for the spectrum analyzer shall be between two and five times the anticipated OBW.
3. The nominal resolution bandwidth (RBW) shall be in the range of 1 to 5 % of the anticipated OBW, and the VBW shall be at least 3 times the RBW.
4. Set the detection mode to peak, and the trace mode to max hold.
5. Determine the reference value: Set the EUT to transmit a modulated signal. Allow the trace to stabilize. Set the spectrum analyzer marker to the highest level of the displayed trace.
(this is the reference value)
6. Determine the “-26 dB down amplitude” as equal to (Reference Value – X).
7. Place two markers, one at the lowest and the other at the highest frequency of the envelope of the spectral display such that each marker is at or slightly below the “-X dB down amplitude” determined in step 6. If a marker is below this “-X dB down amplitude” value it shall be placed as close as possible to this value. The OBW is the positive frequency difference between the two markers.
8. Use the 99 % power bandwidth function of the spectrum analyzer and report the measured bandwidth.



3.7 Conducted Band Edge

3.7.1 Description of Conducted Band Edge Measurement

22.917(a)

For operations in the 824 – 849 MHz band, the FCC limit is $43 + 10\log_{10}(P[\text{Watts}])$ dB below the transmitter power $P(\text{Watts})$ in a 100kHz bandwidth. However, in the 1MHz bands immediately outside and adjacent to the licensee's frequency block, a resolution bandwidth of at least one percent of the emission bandwidth of the fundamental emission of the transmitter may be employed.

27.53(m)(4)

For mobile digital stations, the attenuation factor shall be not less than $40 + 10 \log (P)$ dB on all frequencies between the channel edge and 5 megahertz from the channel edge, $43 + 10 \log (P)$ dB on all frequencies between 5 megahertz and X megahertz from the channel edge, and $55 + 10 \log (P)$ dB on all frequencies more than X megahertz from the channel edge, where X is the greater of 6 megahertz or the actual emission bandwidth as defined in paragraph (m)(6) of this section. In addition, the attenuation factor shall not be less than $43 + 10 \log (P)$ dB on all frequencies between 2490.5 MHz and 2496 MHz and $55 + 10 \log (P)$ dB at or below 2490.5 MHz. Mobile Satellite Service licensees operating on frequencies below 2495 MHz may also submit a documented interference complaint against BRS licensees operating on channel BRS Channel 1 on the same terms and conditions as adjacent channel BRS or EBS licensees.

3.7.2 Test Procedures

The testing follows FCC KDB 971168 v03 Section 6.0.

1. The EUT was connected to spectrum analyzer and system simulator via a power divider.
2. The band edges of low and high channels for the highest RF powers were measured.
3. Set RBW \geq 1% EBW in the 1MHz band immediately outside and adjacent to the band edge.
4. Beyond the 1 MHz band from the band edge, RBW=1MHz was used.
5. Set spectrum analyzer with RMS detector.
6. The RF fundamental frequency should be excluded against the limit line in the operating frequency band.
7. Checked that all the results comply with the emission limit line.

The limit line is derived from $43 + 10\log(P)$ dB below the transmitter power $P(\text{Watts})$

8. For LTE Band 7, 38, 41, the other 40 dB, and 55 dB have additionally applied same calculation above.



3.8 Conducted Spurious Emission

3.8.1 Description of Conducted Spurious Emission Measurement

The power of any emission outside of the authorized operating frequency ranges must be lower than the transmitter power (P) by a factor of at least $43 + 10 \log (P)$ dB.

For Band 7,38,41:

The power of any emission outside of the authorized operating frequency ranges must be lower than the transmitter power (P) by a factor of at least $55 + 10 \log (P)$ dB.

It is measured by means of a calibrated spectrum analyzer and scanned from 30 MHz up to a frequency including its 10th harmonic.

3.8.2 Test Procedures

The testing follows FCC KDB 971168 v03 Section 6.0.

1. The EUT was connected to spectrum analyzer and system simulator via a power divider.
2. The RF output of EUT was connected to the spectrum analyzer by RF cable and attenuator.
The path loss was compensated to the results for each measurement.
3. The middle channel for the highest RF power within the transmitting frequency was measured.
4. The conducted spurious emission for the whole frequency range was taken.
5. Make the measurement with the spectrum analyzer's RBW = 1MHz, VBW = 3MHz.
6. Set spectrum analyzer with RMS detector.
7. Taking the record of maximum spurious emission.
8. The RF fundamental frequency should be excluded against the limit line in the operating frequency band.
9. The limit line is derived from $43 + 10\log(P)$ dB below the transmitter power P(Watts)
10. For Band 7, 38, 41
The limit line is derived from $55 + 10\log(P)$ dB below the transmitter power P(Watts)



3.9 Frequency Stability

3.9.1 Description of Frequency Stability Measurement

The frequency stability shall be measured by variation of ambient temperature and variation of primary supply voltage to ensure that the fundamental emission stays within the authorized frequency block. The frequency stability of the transmitter shall be maintained within $\pm 0.00025\%$ ($\pm 2.5\text{ppm}$) of the center frequency.

3.9.2 Test Procedures for Temperature Variation

The testing follows FCC KDB 971168 v03 Section 9.0.

1. The EUT was set up in the thermal chamber and connected with the system simulator.
2. With power OFF, the temperature was decreased to -30°C and the EUT was stabilized before testing. Power was applied and the maximum change in frequency was recorded within one minute.
3. With power OFF, the temperature was raised in 10°C step up to 50°C . The EUT was stabilized at each step for at least half an hour. Power was applied and the maximum frequency change was recorded within one minute.

3.9.3 Test Procedures for Voltage Variation

The testing follows FCC KDB 971168 v03 Section 9.0.

1. The EUT was placed in a temperature chamber at $20\pm 5^{\circ}\text{C}$ and connected with the system simulator.
2. The power supply voltage to the EUT was varied from 85% to 115% of the nominal value measured at the input to the EUT.
3. The variation in frequency was measured for the worst case.

4 Radiated Test Items

4.1 Measuring Instruments

See list of measuring instruments of this test report.

4.2 Test Setup

4.2.1 For radiated test from 30MHz to 1GHz

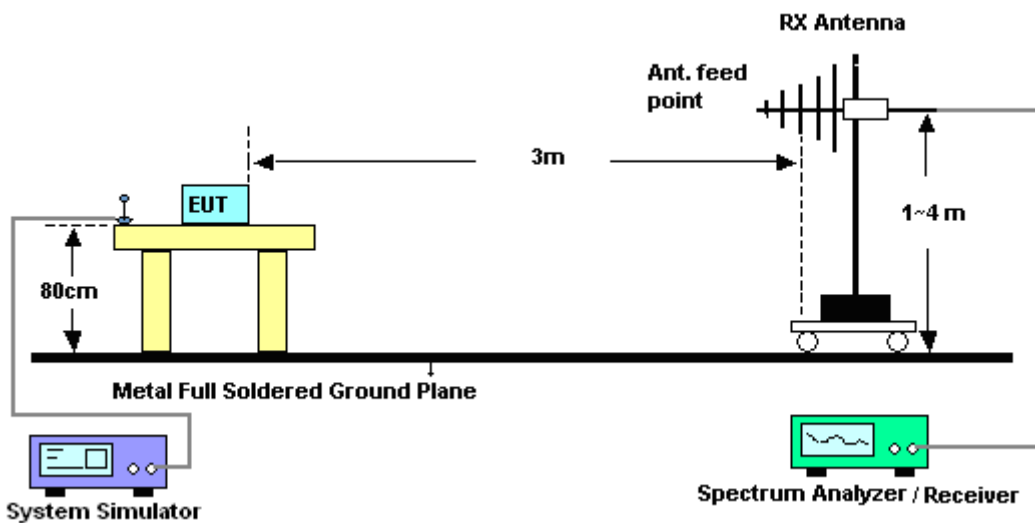

4.2.2 For radiated test above 1GHz

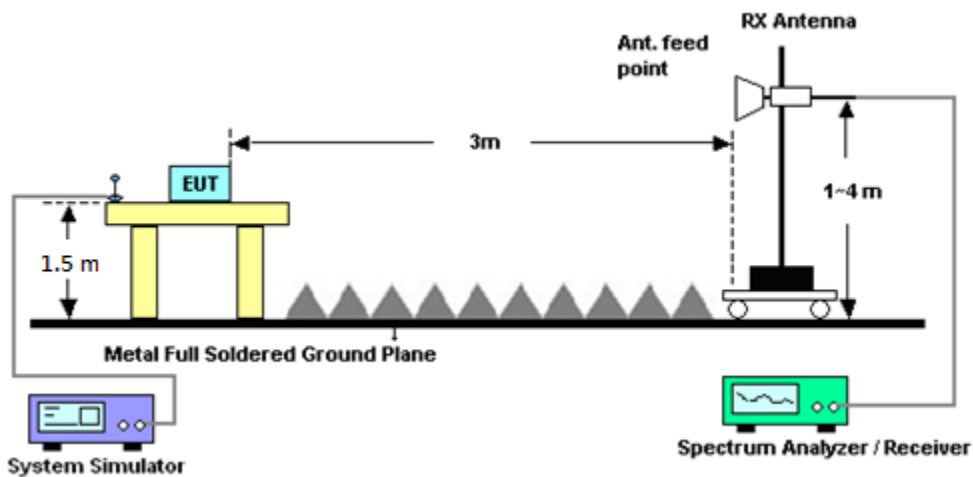

4.3 Test Result of Radiated Test

Please refer to Appendix B.



4.4 Radiated Spurious Emission

4.4.1 Description of Radiated Spurious Emission

The radiated spurious emission was measured by substitution method according to ANSI / TIA-603-E. The power of any emission outside of the authorized operating frequency ranges must be attenuated below the transmitter power (P) by a factor of at least $43 + 10 \log (P)$ dB.

For Band 7, 38, 41

The power of any emission outside of the authorized operating frequency ranges must be attenuated below the transmitter power (P) by a factor of at least $55 + 10 \log (P)$ dB.

The spectrum is scanned from 30 MHz up to a frequency including its 10th harmonic.

4.4.2 Test Procedures

The testing follows FCC KDB 971168 v03 Section 5.8 and ANSI / TIA-603-E Section 2.2.12.

1. The EUT was placed on a turntable with 0.8 meter for frequency below 1GHz and 1.5 meter for frequency above 1GHz respectively above ground.
2. The EUT was set 3 meters from the receiving antenna, which was mounted on the antenna tower.
3. The table was rotated 360 degrees to determine the position of the highest spurious emission.
4. The height of the receiving antenna is varied between one meter and four meters to search the maximum spurious emission for both horizontal and vertical polarizations.
5. Make the measurement with the spectrum analyzer's RBW = 1MHz, VBW = 3MHz, taking the record of maximum spurious emission.
6. A horn antenna was substituted in place of the EUT and was driven by a signal generator.
7. Tune the output power of signal generator to the same emission level with EUT maximum spurious emission.
8. Taking the record of output power at antenna port.
9. Repeat step 7 to step 8 for another polarization.
10. The RF fundamental frequency should be excluded against the limit line in the operating frequency band.

The limit line is derived from $43 + 10\log(P)$ dB below the transmitter power P(Watts)

11. For Band 7, 38, 41:

The limit line is derived from $55 + 10\log(P)$ dB below the transmitter power P(Watts)

EIRP (dBm) = S.G. Power – Tx Cable Loss + Tx Antenna Gain

ERP (dBm) = EIRP - 2.15



5 List of Measuring Equipment

Instrument	Manufacturer	Model No.	Serial No.	Characteristics	Calibration Date	Test Date	Due Date	Remark
LTE Base Station	Anritsu	MT8820C	6201432821	GSM/GPRS /WCDMA/LTE	Oct. 13, 2017	Feb. 07, 2018~ Feb. 26, 2018	Oct. 12, 2018	Conducted (TH05-HY)
Spectrum Analyzer	Rohde & Schwarz	FSV40	101397	10Hz~40GHz	Nov. 09, 2017	Feb. 07, 2018~ Feb. 26, 2018	Nov. 08, 2018	Conducted (TH05-HY)
Temperature Chamber	ESPEC	SH-641	92013720	-30°C~70°C	Aug. 28, 2017	Feb. 07, 2018~ Feb. 26, 2018	Aug. 27, 2018	Conducted (TH05-HY)
Programmable Power Supply	GW Instek	PSS-2005	EL890001	1V~20V 0.5A~5A	Oct. 06, 2017	Feb. 07, 2018~ Feb. 26, 2018	Oct. 05, 2018	Conducted (TH05-HY)
Amplifier	MITEQ	TTA1840-35-HG	1871923	18GHz~40GHz, V SWR : 2.5:1 max	Jul. 18, 2017	Feb. 08, 2018 ~ Mar. 10, 2018	Jul. 17, 2018	Radiation (03CH12-HY)
Bilog Antenna	TESEQ	CBL 6111D&N-6-06	35414&AT-N0602	30MHz~1GHz	Oct. 14, 2017	Feb. 08, 2018 ~ Mar. 10, 2018	Oct. 13, 2018	Radiation (03CH12-HY)
Loop Antenna	Rohde & Schwarz	HFH2-Z2	100488	9 kHz~30 MHz	Nov. 23, 2017	Feb. 08, 2018 ~ Mar. 10, 2018	Nov. 22, 2019	Radiation (03CH12-HY)
EMI Test Receiver	Rohde & Schwarz	ESU26	100390	20Hz~26.5GHz	Dec. 25, 2017	Feb. 08, 2018 ~ Mar. 10, 2018	Dec. 24, 2018	Radiation (03CH12-HY)
Horn Antenna	SCHWARZBECK	BBHA 9120D	9120D-1328	1GHz ~ 18GHz	Oct. 20, 2017	Feb. 08, 2018 ~ Mar. 10, 2018	Oct. 19, 2018	Radiation (03CH12-HY)
Preamplifier	COM-POWER	PA-103	161075	10MHz~1GHz	Mar. 23, 2017	Feb. 08, 2018 ~ Mar. 10, 2018	Mar. 22, 2018	Radiation (03CH12-HY)
Preamplifier	Keysight	83017A	MY53270148	1GHz~26.5GHz	Jan. 15, 2018	Feb. 08, 2018 ~ Mar. 10, 2018	Jan. 14, 2019	Radiation (03CH12-HY)
Preamplifier	MITEQ	AMF-7D-00101800	2025787	1GHZ~18GHZ	Feb. 13, 2017	Feb. 08, 2018 ~ Mar. 10, 2018	Feb. 12, 2019	Radiation (03CH12-HY)
Filter	Wainwright	WHKX12-1080-1200-15000-60ST	SN1	1.2 GHz High Pass	Jul. 17, 2017	Feb. 08, 2018 ~ Mar. 10, 2018	Jul. 16, 2018	Radiation (03CH12-HY)
Filter	Wainwright	WLKS1200-12SS	SN2	1.2G Low Pass	Mar. 24, 2017	Feb. 08, 2018 ~ Mar. 10, 2018	Mar. 23, 2018	Radiation (03CH12-HY)
Controller	EMEC	EM1000	N/A	Control Turn table & Ant Mast	N/A	Feb. 08, 2018 ~ Mar. 10, 2018	N/A	Radiation (03CH12-HY)
Antenna Mast	EMEC	AM-BS-4500-B	N/A	1m~4m	N/A	Feb. 08, 2018 ~ Mar. 10, 2018	N/A	Radiation (03CH12-HY)
Turn Table	EMEC	TT2000	N/A	0~360 Degree	N/A	Feb. 08, 2018 ~ Mar. 10, 2018	N/A	Radiation (03CH12-HY)
SHF-EHF Horn Antenna	SCHWARZBECK	BBHA 9170	BBHA9170576	18GHz ~ 40GHz	Apr. 27, 2017	Feb. 08, 2018 ~ Mar. 10, 2018	Apr. 26, 2018	Radiation (03CH12-HY)
Spectrum Analyzer	Keysight	N9010A	MY55370526	10Hz~44GHz	Mar. 15, 2017	Feb. 08, 2018 ~ Mar. 10, 2018	Mar. 14, 2018	Radiation (03CH12-HY)
Horn Antenna	SCHWARZBECK	BBHA 9120 D	BBHA 9120 D 1212	1GHz ~ 18GHz	Mar. 17, 2017	Feb. 08, 2018 ~ Mar. 10, 2018	Mar. 16, 2018	Radiation (03CH12-HY)
Signal Generator	Anritsu	MG3694C	163401	0.1Hz~40GHz	Jan. 15, 2018	Feb. 08, 2018 ~ Mar. 10, 2018	Jan. 14, 2019	Radiation (03CH12-HY)
SHF-EHF Horn Antenna	SCHWARZBECK	BBHA 9170	BBHA9170584	18GHz- 40GHz	Nov. 27, 2017	Feb. 08, 2018 ~ Mar. 10, 2018	Nov. 26, 2018	Radiation (03CH12-HY)
Test Software	Audix	E3 6.2009-8-24	RK-001042	N/A	N/A	Feb. 08, 2018 ~ Mar. 10, 2018	N/A	Radiation (03CH12-HY)



6 Uncertainty of Evaluation

Uncertainty of Radiated Emission Measurement (30 MHz ~ 1000 MHz)

Measuring Uncertainty for a Level of Confidence of 95% ($U = 2Uc(y)$)	3.36
---	------

Uncertainty of Radiated Emission Measurement (1 GHz ~ 18 GHz)

Measuring Uncertainty for a Level of Confidence of 95% ($U = 2Uc(y)$)	3.70
---	------

Uncertainty of Radiated Emission Measurement (18 GHz ~ 40 GHz)

Measuring Uncertainty for a Level of Confidence of 95% ($U = 2Uc(y)$)	3.98
---	------



Appendix A. Test Results of Conducted Test

Conducted Output Power(Average power)

LTE Band 5 Maximum Average Power [dBm]						
BW [MHz]	RB Size	RB Offset	Mod	Lowest	Middle	Highest
10	1	0	QPSK	23.69	23.75	23.95
10	1	25		23.67	23.73	23.92
10	1	49		23.61	23.84	23.88
10	25	0		22.74	22.89	22.99
10	25	12		22.71	22.85	22.98
10	25	25		22.67	22.86	22.93
10	50	0		22.69	22.83	22.97
10	1	0	16-QAM	22.94	23.00	22.94
10	1	25		22.92	22.95	22.93
10	1	49		22.93	22.97	22.96
10	25	0		21.61	21.83	21.96
10	25	12		21.72	21.82	21.97
10	25	25		21.67	21.87	21.99
10	50	0		21.71	21.81	21.98
10	1	0	64-QAM	21.79	21.94	21.91
10	1	25		21.87	21.98	21.92
10	1	49		21.85	21.93	21.95
10	25	0		20.62	20.83	20.97
10	25	12		20.73	20.84	20.98
10	25	25		20.67	20.89	20.92
10	50	0		20.71	20.84	20.95
5	1	0	QPSK	23.70	23.86	23.90
5	1	12		23.67	23.89	23.89
5	1	24		23.75	23.84	23.86
5	12	0		22.74	22.92	22.93
5	12	7		22.76	22.94	22.97
5	12	13		22.80	22.91	23.00
5	25	0		22.75	22.95	22.95
5	1	0	16-QAM	22.97	22.91	22.90
5	1	12		22.94	22.94	22.91
5	1	24		22.95	22.93	22.98
5	12	0		21.74	21.91	21.94
5	12	7		21.80	21.93	21.88
5	12	13		21.84	22.00	21.82
5	25	0		21.72	21.88	21.86
5	1	0	64-QAM	21.96	21.94	21.97
5	1	12		21.89	21.93	21.92
5	1	24		21.91	21.97	21.94
5	12	0		20.75	20.94	20.96
5	12	7		20.77	20.98	20.99
5	12	13		20.79	20.94	20.96
5	25	0		20.71	20.90	21.00



LTE Band 5 Maximum Average Power [dBm]						
BW [MHz]	RB Size	RB Offset	Mod	Lowest	Middle	Highest
3	1	0	QPSK	23.55	23.74	23.89
3	1	8		23.56	23.73	23.85
3	1	14		23.54	23.84	23.80
3	8	0		22.62	22.80	22.92
3	8	4		22.66	22.83	22.93
3	8	7		22.61	22.79	22.94
3	15	0		22.64	22.78	22.96
3	1	0	16-QAM	22.90	23.00	22.93
3	1	8		22.97	22.92	22.94
3	1	14		22.94	22.94	22.87
3	8	0		21.70	21.74	21.75
3	8	4		21.72	21.76	21.78
3	8	7		21.66	21.72	21.75
3	15	0		21.65	21.71	21.72
3	1	0	64-QAM	21.74	21.79	21.87
3	1	8		21.75	21.80	21.85
3	1	14		21.72	21.94	21.80
3	8	0		20.68	20.71	20.72
3	8	4		20.69	20.74	20.77
3	8	7		20.66	20.71	20.72
3	15	0		20.62	20.70	20.73
1.4	1	0	QPSK	23.51	23.64	23.87
1.4	1	3		23.59	23.70	23.82
1.4	1	5		23.50	23.63	23.77
1.4	3	0		23.56	23.73	23.83
1.4	3	1		23.59	23.76	23.88
1.4	3	3		23.56	23.70	23.84
1.4	6	0		22.55	22.72	22.82
1.4	1	0	16-QAM	22.84	22.92	23.03
1.4	1	3		22.91	23.00	23.07
1.4	1	5		22.88	22.90	23.00
1.4	3	0		22.60	22.71	22.85
1.4	3	1		22.63	22.78	22.89
1.4	3	3		22.59	22.72	22.81
1.4	6	0		21.63	21.79	21.88
1.4	1	0	64-QAM	21.69	21.84	21.97
1.4	1	3		21.75	21.91	21.95
1.4	1	5		21.61	21.84	21.99
1.4	3	0		21.66	21.85	21.96
1.4	3	1		21.73	21.86	21.91
1.4	3	3		21.71	21.84	21.97
1.4	6	0		20.56	20.73	20.80



LTE Band 7 Maximum Average Power [dBm]						
BW [MHz]	RB Size	RB Offset	Mod	Lowest	Middle	Highest
20	1	0	QPSK	22.88	22.67	22.74
20	1	49		22.73	22.62	22.67
20	1	99		22.71	22.65	22.69
20	50	0		21.74	21.72	21.70
20	50	24		21.80	21.69	21.75
20	50	50		21.73	21.66	21.69
20	100	0		21.80	21.67	21.71
20	1	0	16-QAM	21.92	21.75	21.92
20	1	49		21.98	21.82	21.92
20	1	99		21.93	21.93	21.90
20	50	0		20.77	20.73	20.65
20	50	24		20.84	20.70	20.75
20	50	50		20.75	20.66	20.69
20	100	0		20.80	20.69	20.70
20	1	0	64-QAM	20.91	20.76	20.84
20	1	49		20.93	20.80	20.88
20	1	99		20.89	20.89	20.88
20	50	0		19.75	19.70	19.65
20	50	24		19.80	19.71	19.72
20	50	50		19.77	19.66	19.69
20	100	0		19.77	19.68	19.74
15	1	0	QPSK	22.68	22.56	22.58
15	1	37		22.66	22.58	22.51
15	1	74		22.69	22.67	22.65
15	36	0		21.83	21.64	21.67
15	36	20		21.77	21.73	21.65
15	36	39		21.80	21.72	21.68
15	75	0		21.76	21.68	21.62
15	1	0	16-QAM	21.98	21.81	21.86
15	1	37		22.00	21.84	21.81
15	1	74		21.94	21.98	21.93
15	36	0		20.86	20.63	20.68
15	36	20		20.84	20.70	20.67
15	36	39		20.80	20.75	20.66
15	75	0		20.78	20.69	20.62
15	1	0	64-QAM	20.95	20.80	20.81
15	1	37		20.89	20.79	20.75
15	1	74		20.89	20.86	20.89
15	36	0		19.85	19.66	19.69
15	36	20		19.83	19.73	19.66
15	36	39		19.81	19.76	19.71
15	75	0		19.77	19.67	19.62



LTE Band 7 Maximum Average Power [dBm]						
BW [MHz]	RB Size	RB Offset	Mod	Lowest	Middle	Highest
10	1	0	QPSK	22.79	22.64	22.67
10	1	25		22.70	22.60	22.59
10	1	49		22.80	22.61	22.71
10	25	0		21.80	21.62	21.59
10	25	12		21.78	21.67	21.65
10	25	25		21.78	21.70	21.67
10	50	0		21.74	21.65	21.62
10	1	0	16-QAM	21.97	21.82	21.88
10	1	25		21.96	21.82	21.81
10	1	49		21.93	21.87	21.89
10	25	0		20.80	20.61	20.57
10	25	12		20.76	20.70	20.66
10	25	25		20.77	20.70	20.66
10	50	0		20.77	20.66	20.63
10	1	0	64-QAM	20.94	20.81	20.80
10	1	25		20.87	20.77	20.75
10	1	49		20.94	20.77	20.82
10	25	0		19.84	19.63	19.59
10	25	12		19.77	19.68	19.65
10	25	25		19.76	19.70	19.66
10	50	0		19.75	19.67	19.65
5	1	0	QPSK	22.82	22.60	22.64
5	1	12		22.84	22.65	22.59
5	1	24		22.75	22.68	22.66
5	12	0		21.81	21.61	21.60
5	12	7		21.87	21.65	21.66
5	12	13		21.87	21.67	21.65
5	25	0		21.83	21.66	21.62
5	1	0	16-QAM	21.95	21.78	21.75
5	1	12		21.92	21.87	21.82
5	1	24		21.97	21.87	21.83
5	12	0		20.81	20.62	20.61
5	12	7		20.89	20.70	20.66
5	12	13		20.87	20.69	20.67
5	25	0		20.82	20.65	20.62
5	1	0	64-QAM	20.93	20.74	20.71
5	1	12		20.97	20.77	20.76
5	1	24		20.92	20.81	20.78
5	12	0		19.85	19.65	19.66
5	12	7		19.90	19.72	19.71
5	12	13		19.89	19.72	19.70
5	25	0		19.85	19.63	19.62



LTE Band 38 Maximum Average Power [dBm]						
BW [MHz]	RB Size	RB Offset	Mod	Lowest	Middle	Highest
20	1	0	QPSK	23.69	23.42	23.21
20	1	49		23.58	23.43	23.14
20	1	99		23.57	23.27	22.95
20	50	0		22.69	22.44	22.21
20	50	24		22.68	22.50	22.09
20	50	50		22.54	22.34	22.03
20	100	0		22.60	22.48	22.15
20	1	0	16-QAM	22.70	22.52	22.29
20	1	49		22.62	22.51	22.17
20	1	99		22.59	22.28	22.04
20	50	0		21.69	21.43	21.24
20	50	24		21.75	21.54	21.10
20	50	50		21.55	21.34	21.06
20	100	0		21.62	21.50	21.17
20	1	0	64-QAM	21.50	21.23	20.98
20	1	49		21.34	21.22	20.84
20	1	99		21.32	21.01	20.70
20	50	0		20.66	20.42	20.20
20	50	24		20.71	20.50	20.09
20	50	50		20.54	20.32	20.01
20	100	0		20.59	20.48	20.16
15	1	0	QPSK	23.55	23.36	23.07
15	1	37		23.46	23.30	22.95
15	1	74		23.52	23.24	22.89
15	36	0		22.54	22.36	22.06
15	36	20		22.62	22.42	22.02
15	36	39		22.54	22.35	21.96
15	75	0		22.59	22.38	22.01
15	1	0	16-QAM	22.65	22.46	22.18
15	1	37		22.58	22.41	22.07
15	1	74		22.59	22.33	22.00
15	36	0		21.52	21.31	21.01
15	36	20		21.57	21.37	20.99
15	36	39		21.47	21.29	20.90
15	75	0		21.62	21.40	21.04
15	1	0	64-QAM	21.42	21.20	20.88
15	1	37		21.35	21.11	20.80
15	1	74		21.37	21.06	20.65
15	36	0		20.50	20.32	20.00
15	36	20		20.58	20.38	20.00
15	36	39		20.50	20.29	19.90
15	75	0		20.59	20.39	20.00



LTE Band 38 Maximum Average Power [dBm]						
BW [MHz]	RB Size	RB Offset	Mod	Lowest	Middle	Highest
10	1	0	QPSK	23.64	23.32	22.94
10	1	25		23.51	23.37	22.91
10	1	49		23.51	23.25	22.91
10	25	0		22.60	22.38	21.99
10	25	12		22.58	22.41	21.94
10	25	25		22.62	22.35	21.96
10	50	0		22.53	22.38	21.89
10	1	0	16-QAM	22.65	22.37	22.03
10	1	25		22.55	22.40	22.00
10	1	49		22.53	22.29	21.95
10	25	0		21.62	21.36	20.99
10	25	12		21.59	21.42	20.95
10	25	25		21.58	21.28	20.94
10	50	0		21.57	21.39	20.96
10	1	0	64-QAM	21.45	21.13	20.70
10	1	25		21.33	21.15	20.66
10	1	49		21.32	21.03	20.58
10	25	0		20.64	20.37	19.98
10	25	12		20.61	20.43	19.98
10	25	25		20.61	20.35	19.99
10	50	0		20.56	20.38	19.95
5	1	0	QPSK	23.61	23.37	22.89
5	1	12		23.63	23.35	22.90
5	1	24		23.52	23.28	22.85
5	12	0		22.58	22.33	21.88
5	12	7		22.66	22.38	21.94
5	12	13		22.59	22.31	21.87
5	25	0		22.61	22.36	21.95
5	1	0	16-QAM	22.61	22.35	21.89
5	1	12		22.70	22.43	22.00
5	1	24		22.57	22.36	21.94
5	12	0		21.55	21.35	20.90
5	12	7		21.63	21.42	20.92
5	12	13		21.55	21.28	20.86
5	25	0		21.61	21.39	20.92
5	1	0	64-QAM	21.40	21.09	20.60
5	1	12		21.45	21.14	20.62
5	1	24		21.37	21.08	20.61
5	12	0		20.60	20.36	19.90
5	12	7		20.66	20.40	19.96
5	12	13		20.57	20.28	19.86
5	25	0		20.63	20.37	19.92



LTE Band 41 Maximum Average Power [dBm]						
BW [MHz]	RB Size	RB Offset	Mod	Lowest	Middle	Highest
20	1	0	QPSK	23.63	23.39	22.89
20	1	49		23.56	23.38	22.84
20	1	99		23.58	23.37	22.88
20	50	0		22.68	22.38	21.89
20	50	24		22.67	22.37	21.88
20	50	50		22.60	22.32	21.80
20	100	0		22.61	22.35	21.88
20	1	0	16-QAM	22.61	22.43	21.88
20	1	49		22.64	22.58	21.94
20	1	99		22.66	22.47	21.96
20	50	0		21.64	21.34	20.84
20	50	24		21.69	21.43	20.91
20	50	50		21.60	21.32	20.84
20	100	0		21.59	21.39	20.88
20	1	0	64-QAM	21.41	21.09	20.70
20	1	49		21.37	21.09	20.69
20	1	99		21.41	21.14	20.72
20	50	0		20.61	20.31	19.80
20	50	24		20.65	20.37	19.85
20	50	50		20.62	20.30	19.84
20	100	0		20.60	20.39	19.89
15	1	0	QPSK	23.45	23.20	22.70
15	1	37		23.47	23.17	22.68
15	1	74		23.50	23.27	22.80
15	36	0		22.53	22.27	21.83
15	36	20		22.59	22.30	21.79
15	36	39		22.51	22.28	21.81
15	75	0		22.56	22.34	21.73
15	1	0	16-QAM	22.58	22.33	21.80
15	1	37		22.68	22.46	21.84
15	1	74		22.64	22.40	21.97
15	36	0		21.52	21.20	20.76
15	36	20		21.58	21.26	20.79
15	36	39		21.44	21.21	20.78
15	75	0		21.60	21.32	20.76
15	1	0	64-QAM	21.39	21.02	20.62
15	1	37		21.44	21.08	20.61
15	1	74		21.39	21.15	20.76
15	36	0		20.51	20.20	19.77
15	36	20		20.56	20.30	19.75
15	36	39		20.48	20.24	19.79
15	75	0		20.58	20.32	19.76



LTE Band 41 Maximum Average Power [dBm]						
BW [MHz]	RB Size	RB Offset	Mod	Lowest	Middle	Highest
10	1	0	QPSK	23.56	23.24	22.87
10	1	25		23.54	23.29	22.80
10	1	49		23.59	23.28	22.93
10	25	0		22.50	22.31	21.77
10	25	12		22.56	22.30	21.80
10	25	25		22.58	22.27	21.89
10	50	0		22.53	22.28	21.78
10	1	0	16-QAM	22.62	22.34	21.95
10	1	25		22.63	22.42	21.89
10	1	49		22.66	22.34	21.92
10	25	0		21.54	21.29	20.76
10	25	12		21.58	21.31	20.84
10	25	25		21.57	21.21	20.81
10	50	0		21.56	21.36	20.87
10	1	0	64-QAM	21.43	21.09	20.76
10	1	25		21.43	21.09	20.63
10	1	49		21.48	21.12	20.77
10	25	0		20.54	20.28	19.80
10	25	12		20.60	20.38	19.85
10	25	25		20.59	20.27	19.86
10	50	0		20.53	20.30	19.81
5	1	0	QPSK	23.55	23.21	22.83
5	1	12		23.57	23.27	22.85
5	1	24		23.59	23.20	22.84
5	12	0		22.49	22.26	21.80
5	12	7		22.52	22.32	21.85
5	12	13		22.54	22.28	21.88
5	25	0		22.51	22.27	21.87
5	1	0	16-QAM	22.53	22.33	21.89
5	1	12		22.64	22.52	21.93
5	1	24		22.61	22.35	21.97
5	12	0		21.47	21.27	20.82
5	12	7		21.56	21.31	20.85
5	12	13		21.53	21.28	20.85
5	25	0		21.51	21.27	20.80
5	1	0	64-QAM	21.34	21.08	20.68
5	1	12		21.37	21.17	20.75
5	1	24		21.40	21.03	20.76
5	12	0		20.49	20.27	19.80
5	12	7		20.57	20.30	19.84
5	12	13		20.51	20.30	19.81
5	25	0		20.53	20.30	19.82



LTE Band 5

Peak-to-Average Ratio

Mode	LTE Band 5 / 10MHz				
Mod.	QPSK		16QAM		Limit: 13dB
RB Size	1RB	Full RB	1RB	Full RB	Result
Lowest CH	5.25	5.54	5.91	6.46	PASS
Middle CH	4.49	5.3	5.3	6.17	
Highest CH	4.9	5.28	5.59	6.52	
Mode	LTE Band 5 / 10MHz				
Mod.	64QAM				Limit: 13dB
RB Size	1RB	Full RB			Result
Lowest CH	6.64	7.07	-	-	PASS
Middle CH	6.41	6.81	-	-	
Highest CH	6.49	6.78	-	-	



LTE Band 5 / 10MHz / QPSK

Lowest Channel / 1RB

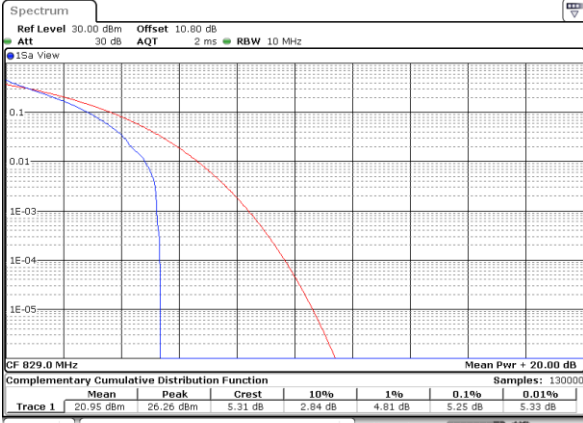

Date: 7.FEB.2018 22:36:09

Lowest Channel / Full RB

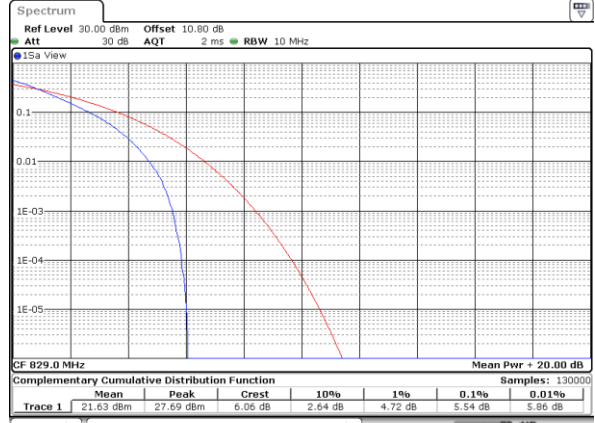

Date: 7.FEB.2018 22:36:23

Middle Channel / 1RB

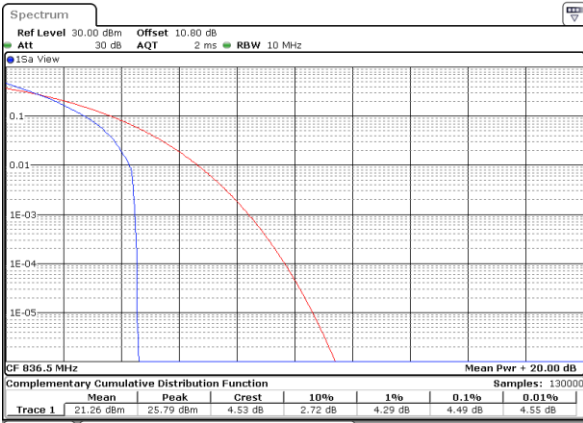

Date: 7.FEB.2018 22:36:32

Middle Channel / Full RB

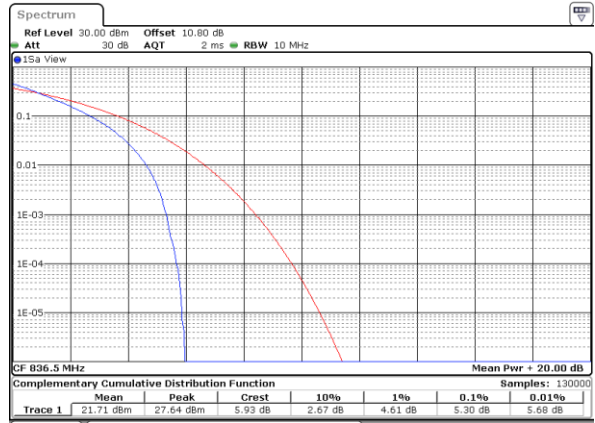

Date: 7.FEB.2018 22:36:50

Highest Channel / 1RB

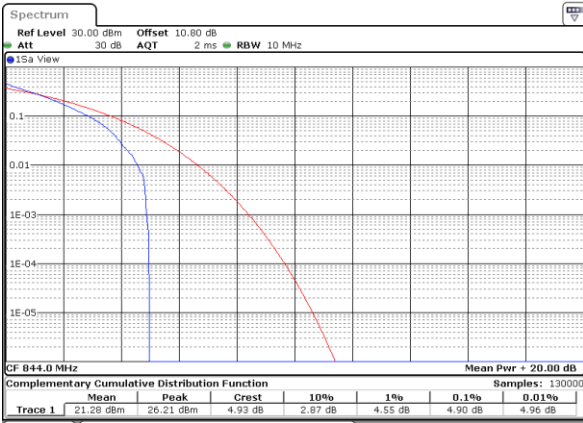

Date: 7.FEB.2018 22:37:00

Highest Channel / Full RB

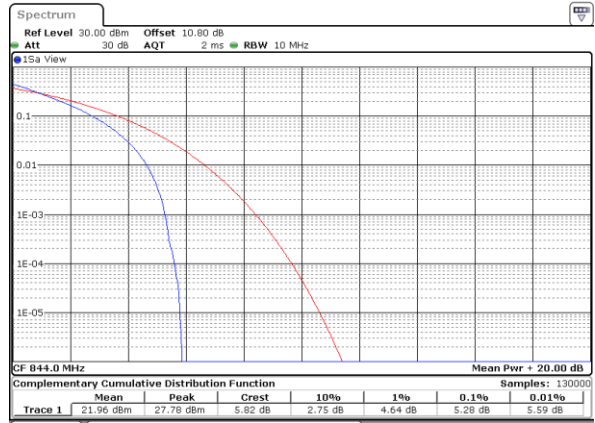

Date: 7.FEB.2018 22:37:22



LTE Band 5 / 10MHz / 16QAM

Lowest Channel / 1RB

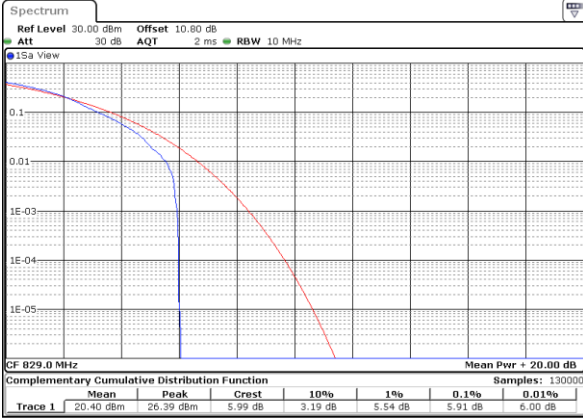

Date: 7.FEB.2018 22:33:45

Lowest Channel / Full RB

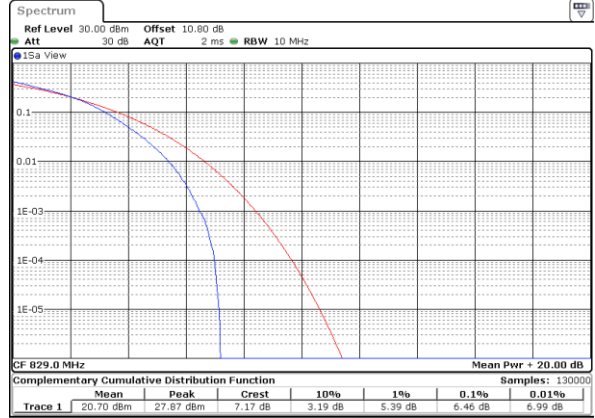

Date: 7.FEB.2018 22:33:57

Middle Channel / 1RB

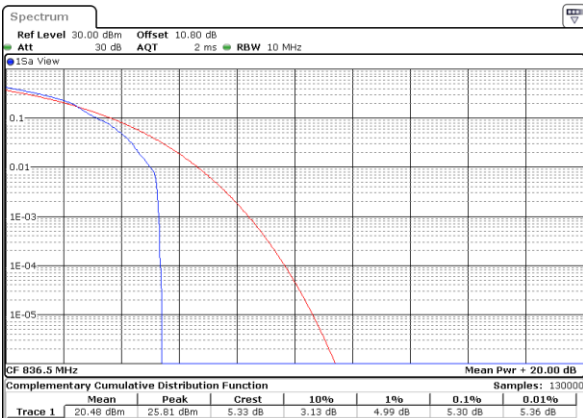

Date: 7.FEB.2018 22:34:26

Middle Channel / Full RB

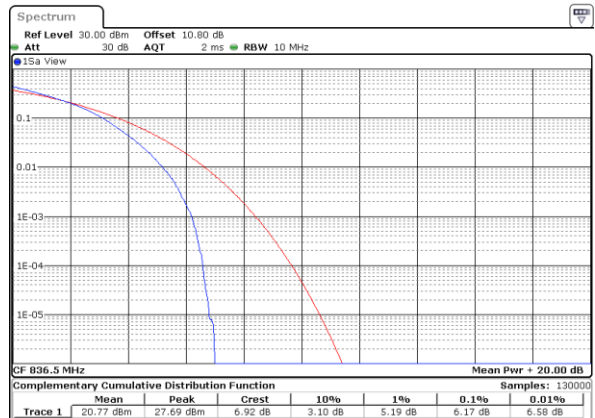

Date: 7.FEB.2018 22:34:57

Highest Channel / 1RB



Date: 7.FEB.2018 22:35:44

Highest Channel / Full RB



Date: 7.FEB.2018 22:35:56



LTE Band 5 / 10MHz / 64QAM

Lowest Channel / 1RB

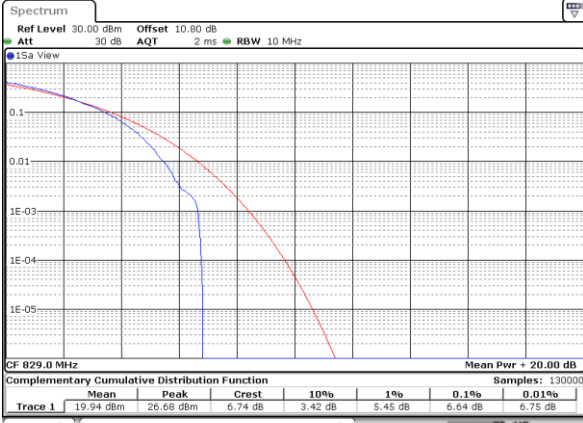

Date: 12 FEB 2018 13:48:50

Lowest Channel / Full RB

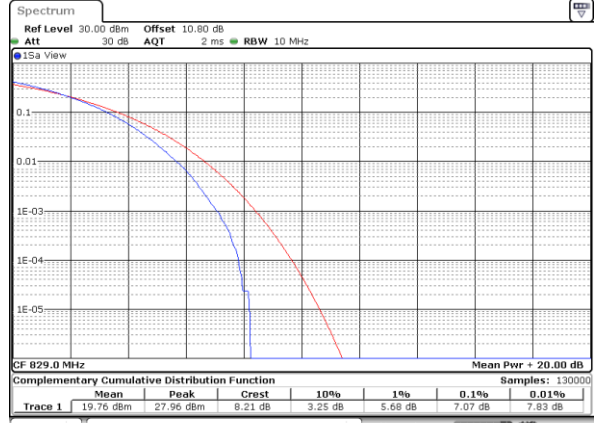

Date: 12 FEB 2018 13:49:01

Middle Channel / 1RB

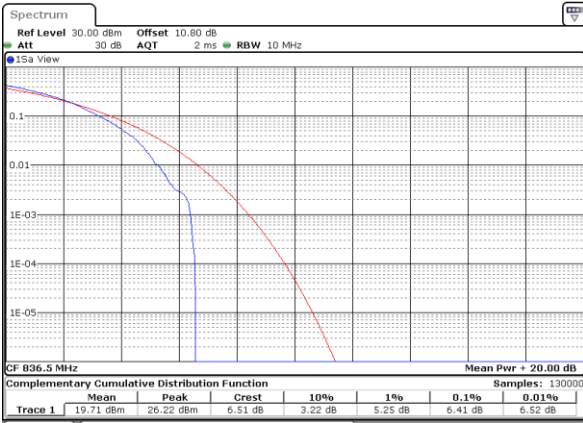

Date: 12 FEB 2018 13:49:15

Middle Channel / Full RB

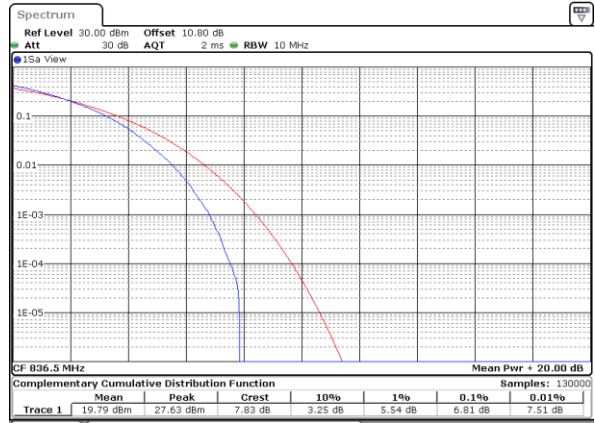

Date: 12 FEB 2018 13:49:25

Highest Channel / 1RB

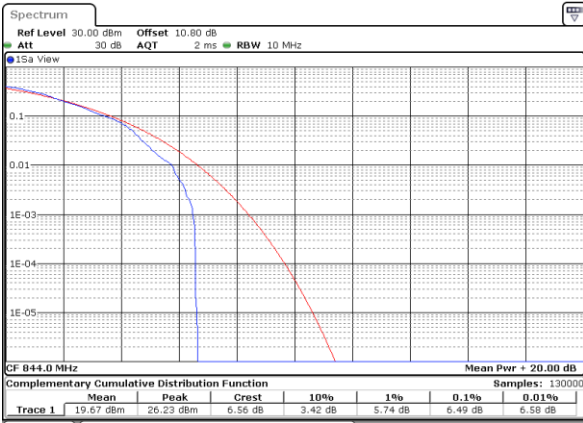

Date: 12 FEB 2018 13:49:34

Highest Channel / Full RB

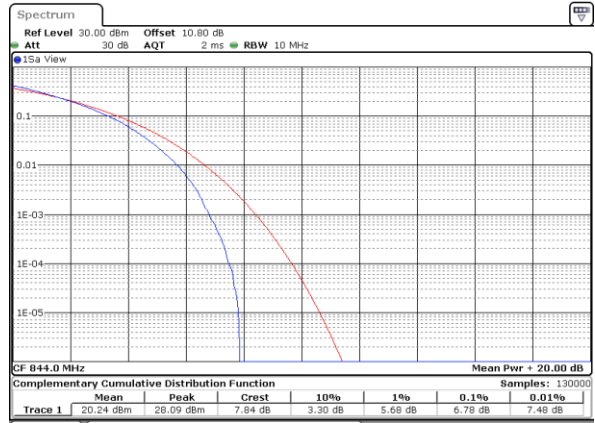

Date: 12 FEB 2018 13:50:18



26dB Bandwidth

Mode	LTE Band 5 : 26dB BW(MHz)											
BW	1.4MHz		3MHz		5MHz		10MHz		15MHz		20MHz	
Mod.	QPSK	16QAM	QPSK	16QAM	QPSK	16QAM	QPSK	16QAM	QPSK	16QAM	QPSK	16QAM
Lowest CH	1.23	1.24	3.06	3.09	4.93	4.97	9.73	9.83	-	-	-	-
Middle CH	1.24	1.23	3.02	3.02	4.87	4.88	9.77	9.75	-	-	-	-
Highest CH	1.24	1.24	3.03	2.94	4.80	4.83	9.69	9.91	-	-	-	-
Mode	LTE Band 5 : 26dB BW(MHz)											
BW	1.4MHz		3MHz		5MHz		10MHz		15MHz		20MHz	
Mod.	64QAM		64QAM		64QAM		64QAM		64QAM		64QAM	
Lowest CH	1.22	-	3.07	-	5.01	-	9.85	-	-	-	-	-
Middle CH	1.21	-	3.02	-	4.89	-	9.83	-	-	-	-	-
Highest CH	1.22	-	3.00	-	4.88	-	9.77	-	-	-	-	-



LTE Band 5

Lowest Channel / 1.4MHz / QPSK

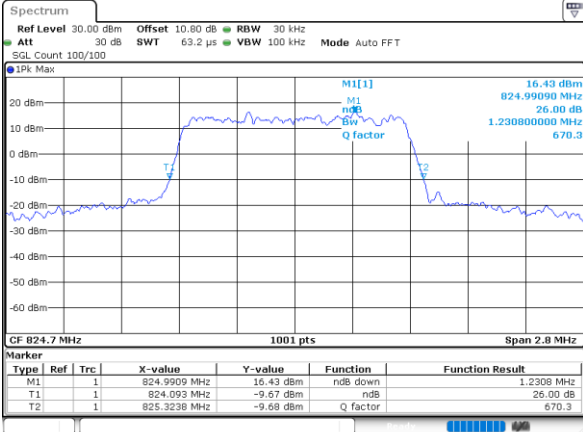

Date: 7.FEB.2018 22:10:47

Lowest Channel / 1.4MHz / 16QAM

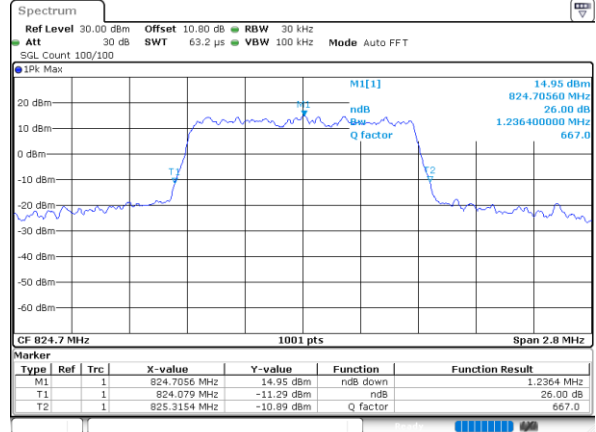

Date: 7.FEB.2018 22:10:37

Middle Channel / 1.4MHz / QPSK

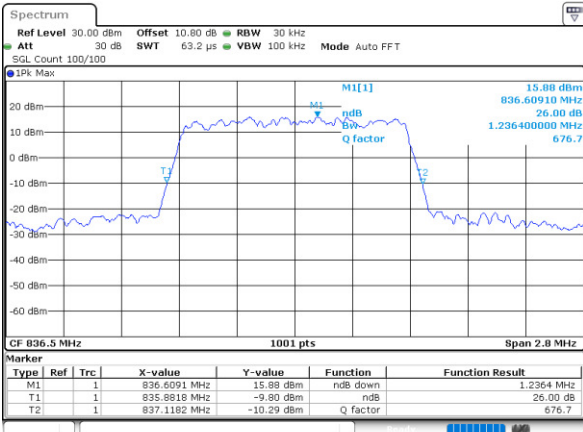

Date: 7.FEB.2018 22:19:34

Middle Channel / 1.4MHz / 16QAM

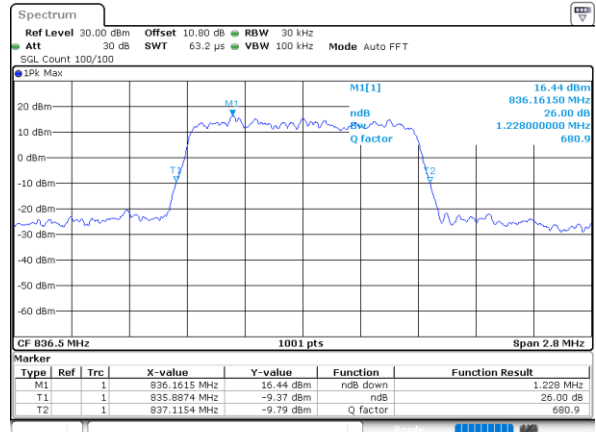

Date: 7.FEB.2018 22:19:44

Highest Channel / 1.4MHz / QPSK

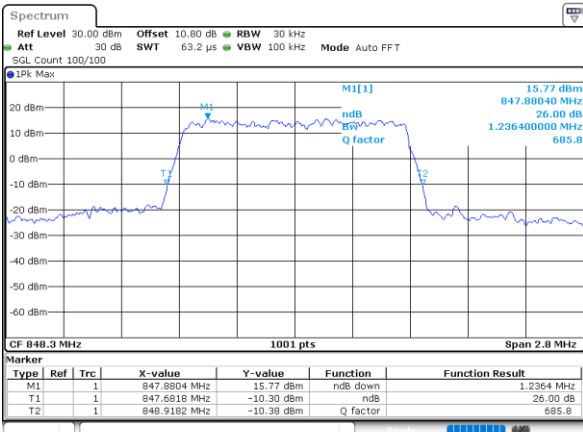

Date: 7.FEB.2018 22:22:00

Highest Channel / 1.4MHz / 16QAM

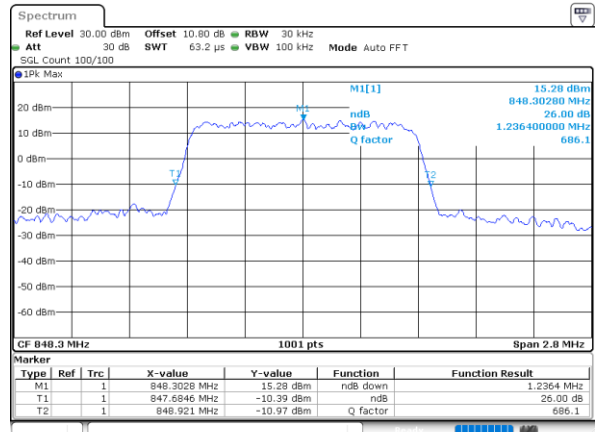

Date: 7.FEB.2018 22:22:10



LTE Band 5

Lowest Channel / 3MHz / QPSK

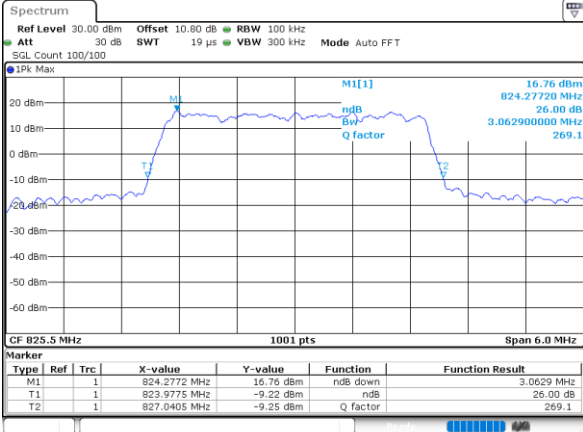

Date: 7.FEB.2018 21:09:34

Lowest Channel / 3MHz / 16QAM

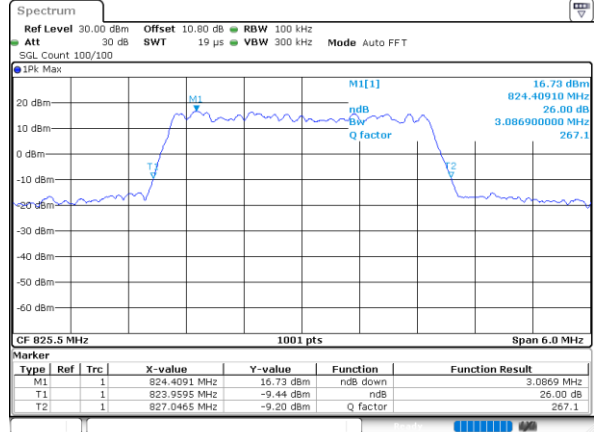

Date: 7.FEB.2018 21:09:44

Middle Channel / 3MHz / QPSK

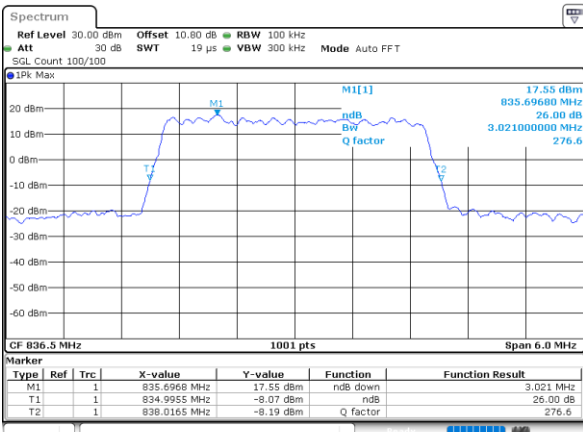

Date: 7.FEB.2018 21:18:32

Middle Channel / 3MHz / 16QAM

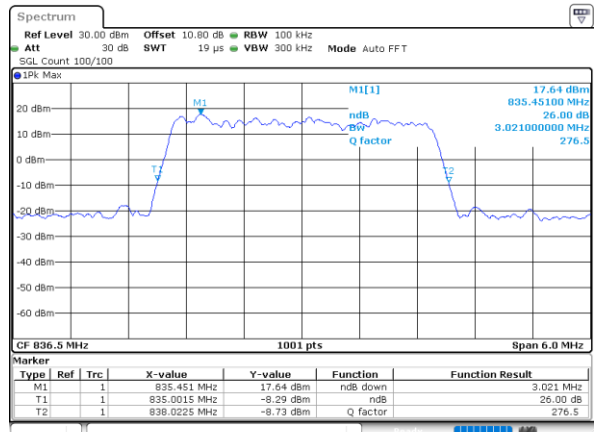

Date: 7.FEB.2018 21:18:41

Highest Channel / 3MHz / QPSK

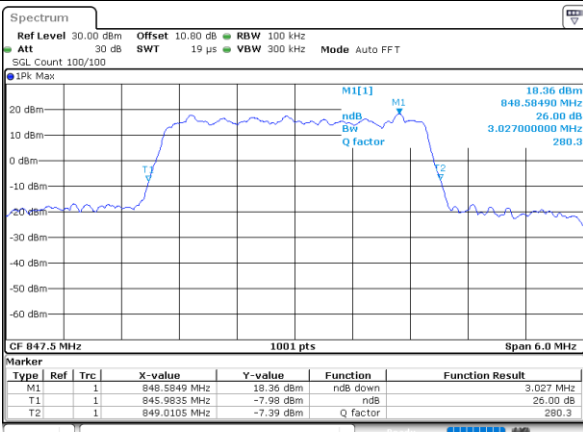

Date: 7.FEB.2018 21:20:57

Highest Channel / 3MHz / 16QAM

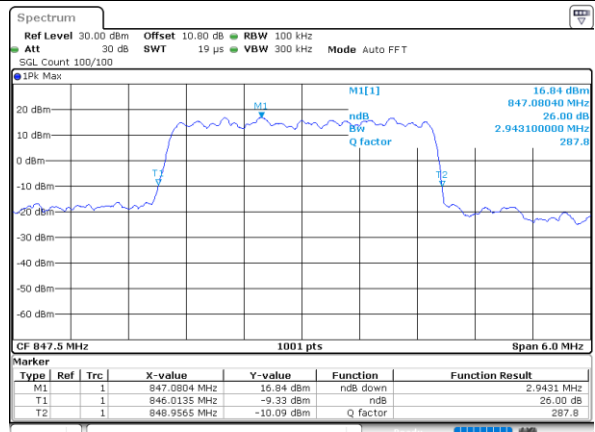

Date: 7.FEB.2018 21:21:07



LTE Band 5

Lowest Channel / 5MHz / QPSK

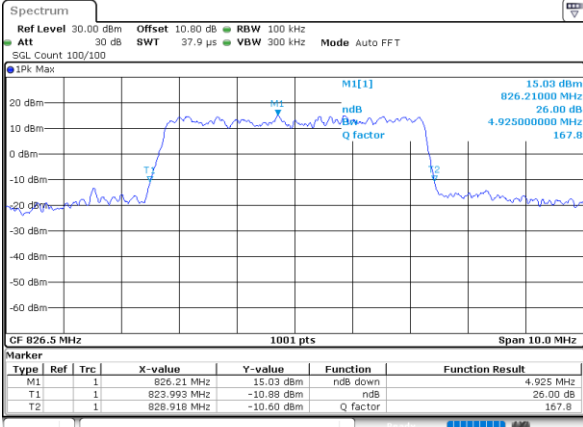

Date: 7.FEB.2018 21:29:55

Lowest Channel / 5MHz / 16QAM

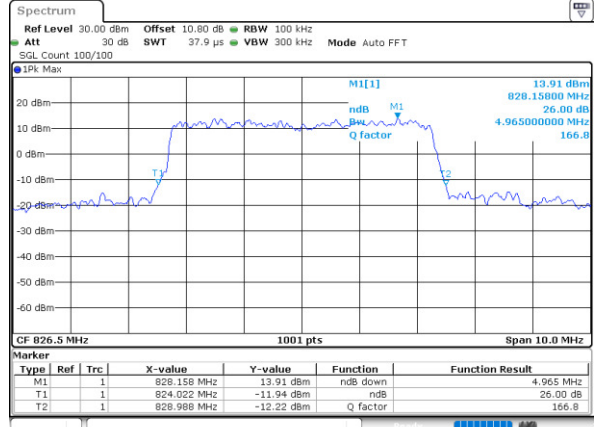

Date: 7.FEB.2018 21:30:05

Middle Channel / 5MHz / QPSK

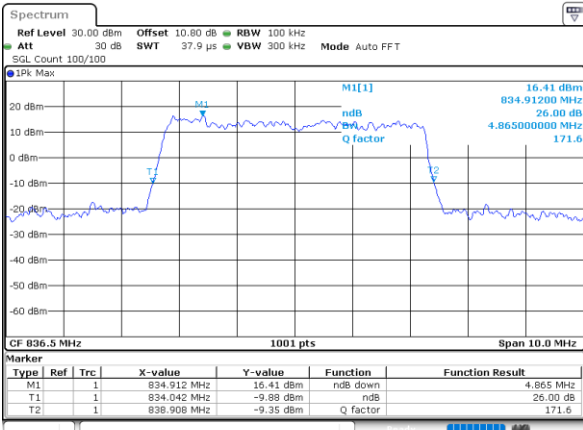

Date: 7.FEB.2018 21:38:52

Middle Channel / 5MHz / 16QAM

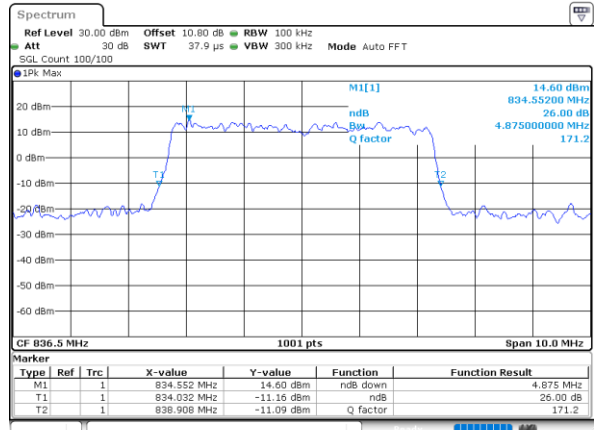

Date: 7.FEB.2018 21:39:02

Highest Channel / 5MHz / QPSK

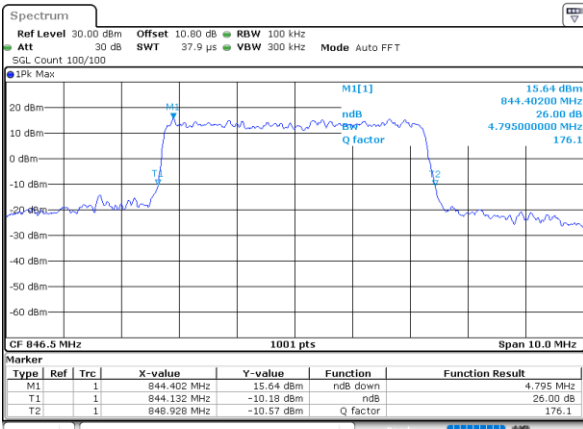

Date: 7.FEB.2018 21:41:18

Highest Channel / 5MHz / 16QAM

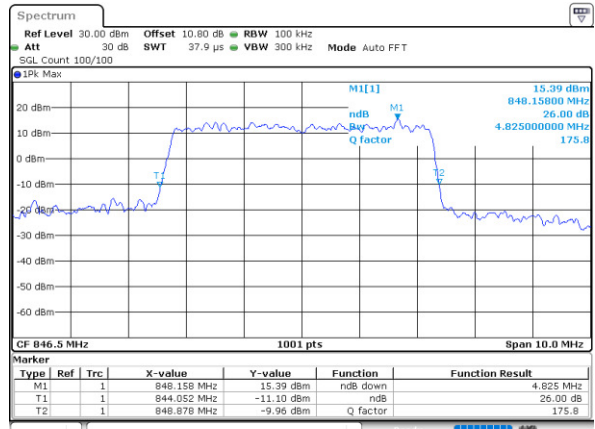

Date: 7.FEB.2018 21:41:28



LTE Band 5

Lowest Channel / 10MHz / QPSK

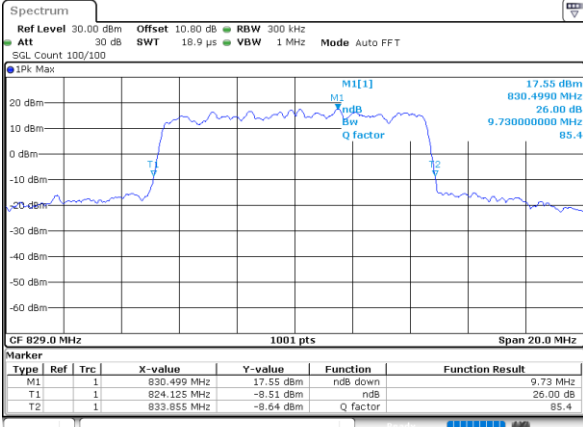

Date: 7.FEB.2018 21:50:16

Lowest Channel / 10MHz / 16QAM

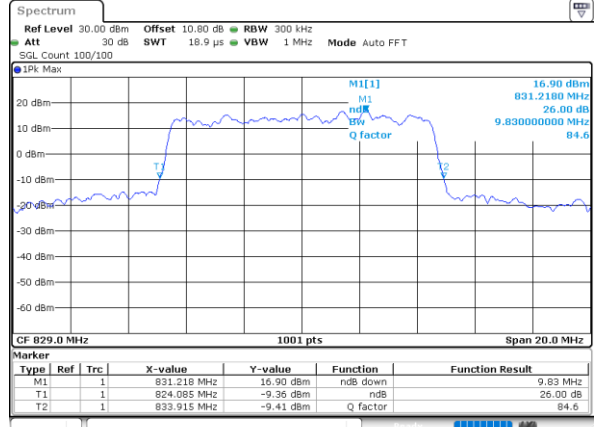

Date: 7.FEB.2018 21:50:26

Middle Channel / 10MHz / QPSK

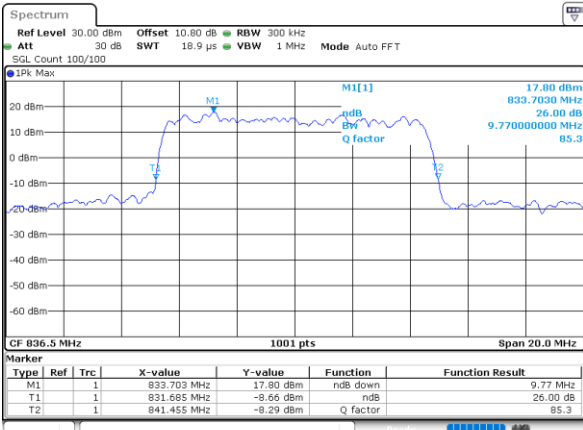

Date: 7.FEB.2018 21:59:13

Middle Channel / 10MHz / 16QAM

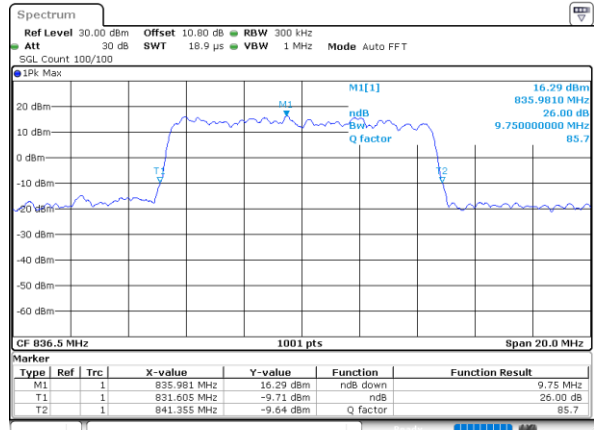

Date: 7.FEB.2018 21:59:23

Highest Channel / 10MHz / QPSK

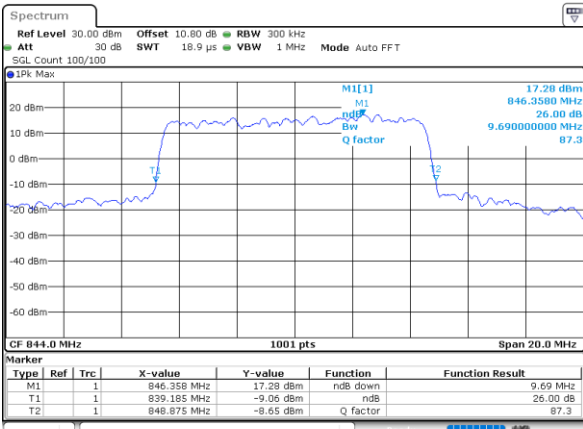

Date: 7.FEB.2018 22:01:39

Highest Channel / 10MHz / 16QAM

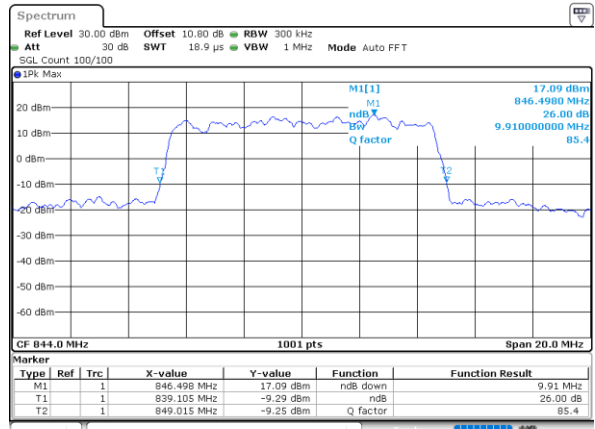

Date: 7.FEB.2018 22:01:49



LTE Band 5

Lowest Channel / 1.4MHz / 64QAM

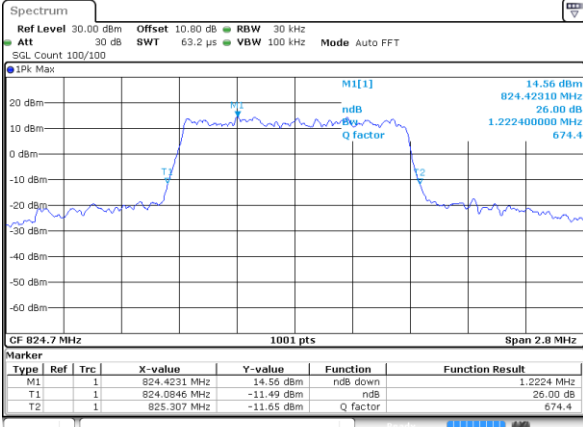

Date: 12 FEB 2018 13:33:14

Lowest Channel / 3MHz / 64QAM

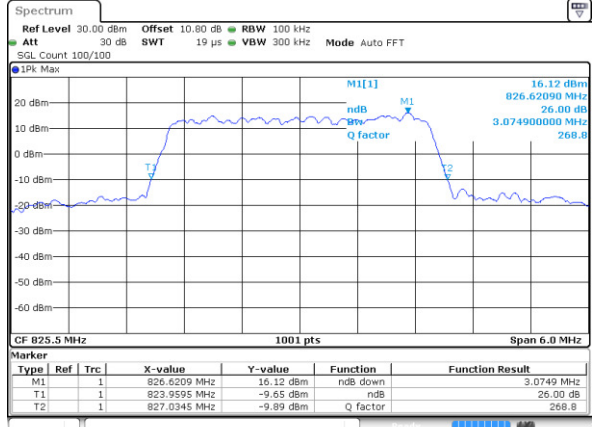

Date: 12 FEB 2018 13:02:46

Middle Channel / 1.4MHz / 64QAM

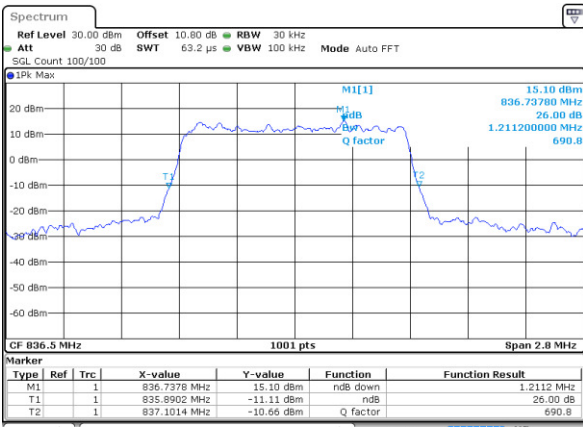

Date: 12 FEB 2018 13:37:42

Middle Channel / 3MHz / 64QAM

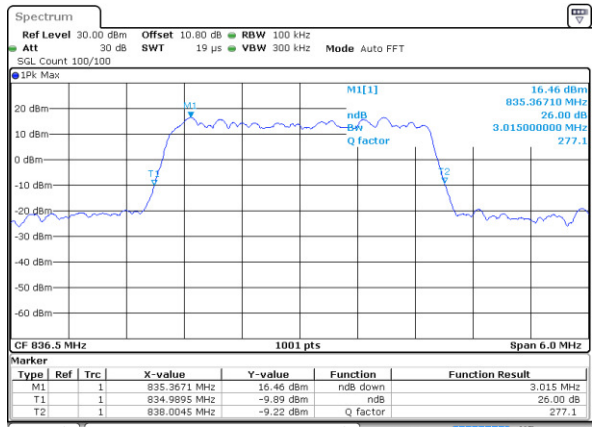

Date: 12 FEB 2018 13:07:14

Highest Channel / 1.4MHz / 64QAM

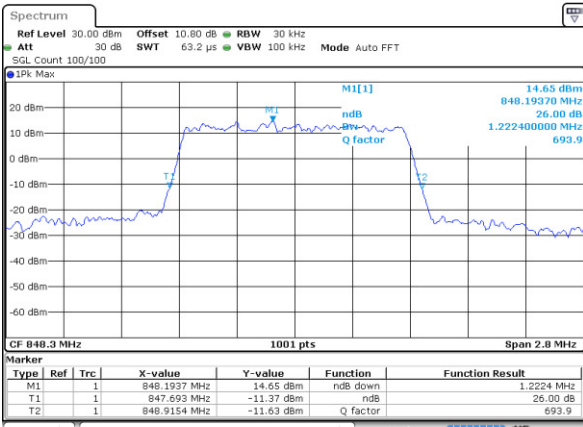

Date: 12 FEB 2018 13:38:55

Highest Channel / 3MHz / 64QAM

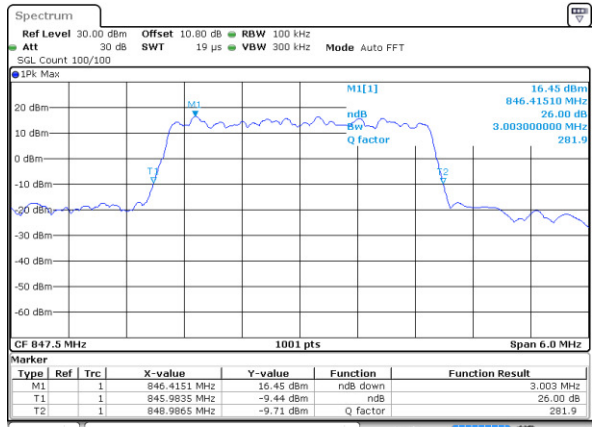

Date: 12 FEB 2018 13:08:27



LTE Band 5

Lowest Channel / 5MHz / 64QAM

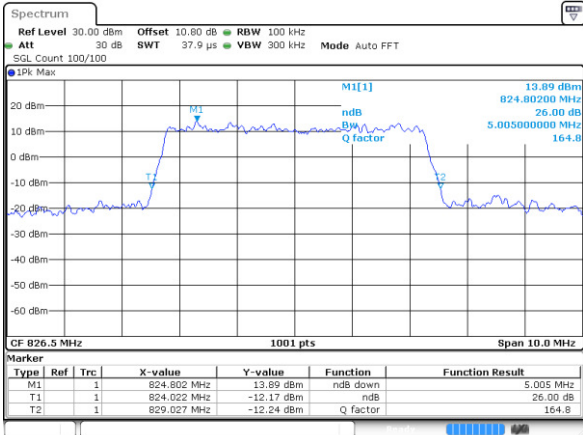

Date: 12 FEB 2018 13:12:55

Lowest Channel / 10MHz / 64QAM

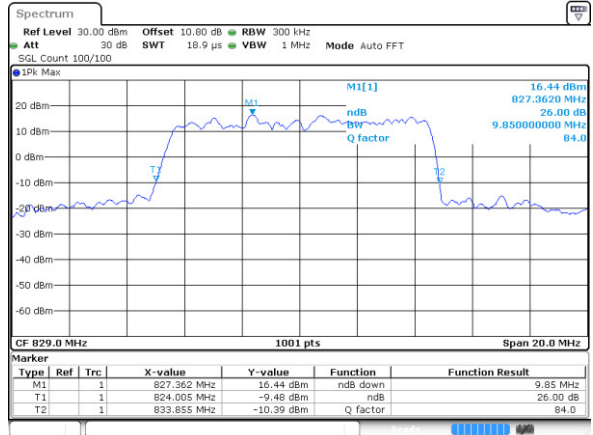

Date: 12 FEB 2018 13:23:05

Middle Channel / 5MHz / 64QAM

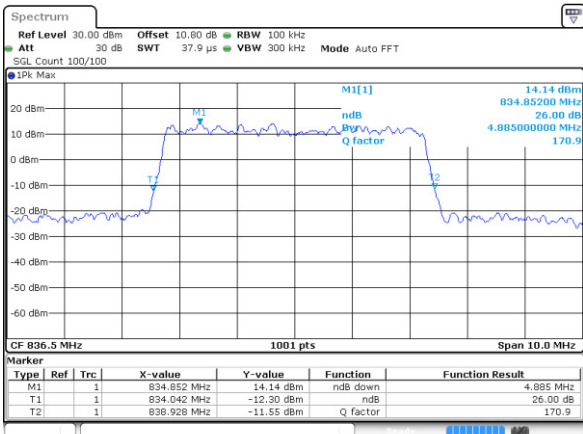

Date: 12 FEB 2018 13:17:23

Middle Channel / 10MHz / 64QAM

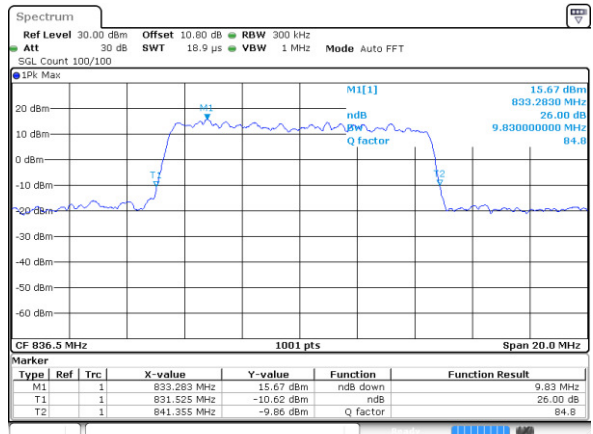

Date: 12 FEB 2018 13:27:33

Highest Channel / 5MHz / 64QAM

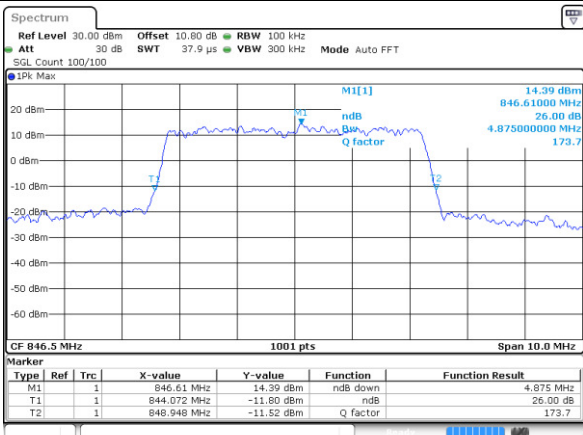

Date: 12 FEB 2018 13:18:37

Highest Channel / 10MHz / 64QAM

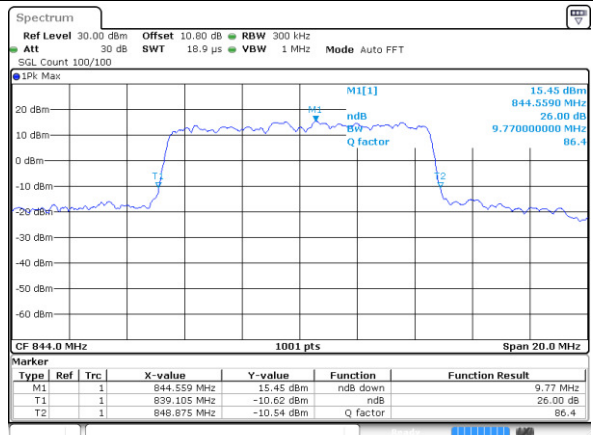

Date: 12 FEB 2018 13:28:46



Occupied Bandwidth

Mode	LTE Band 5 : 99%OBW(MHz)											
BW	1.4MHz		3MHz		5MHz		10MHz		15MHz		20MHz	
Mod.	QPSK	16QAM	QPSK	16QAM	QPSK	16QAM	QPSK	16QAM	QPSK	16QAM	QPSK	16QAM
Lowest CH	1.09	1.09	2.73	2.74	4.53	4.51	9.07	9.01	-	-	-	-
Middle CH	1.09	1.1	2.72	2.72	4.51	4.48	8.99	8.99	-	-	-	-
Highest CH	1.09	1.09	2.72	2.72	4.48	4.5	9.09	9.05	-	-	-	-
Mode	LTE Band 5 : 99%OBW(MHz)											
BW	1.4MHz		3MHz		5MHz		10MHz		15MHz		20MHz	
Mod.	64QAM		64QAM		64QAM		64QAM		64QAM		64QAM	
Lowest CH	1.10	-	2.73	-	4.50	-	9.03	-	-	-	-	-
Middle CH	1.09	-	2.70	-	4.51	-	9.07	-	-	-	-	-
Highest CH	1.10	-	2.71	-	4.49	-	9.09	-	-	-	-	-



LTE Band 5

Lowest Channel / 1.4MHz / QPSK

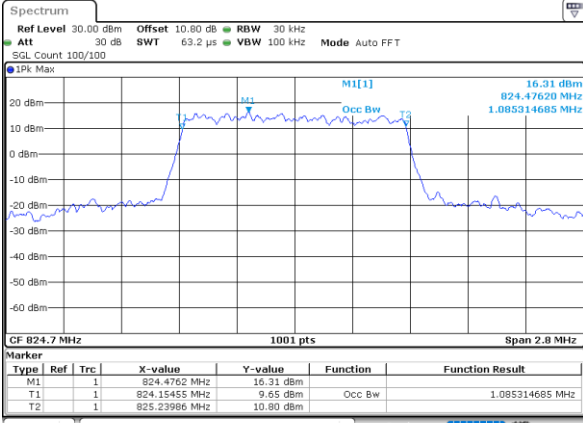

Date: 7.FEB.2018 22:10:17

Lowest Channel / 1.4MHz / 16QAM

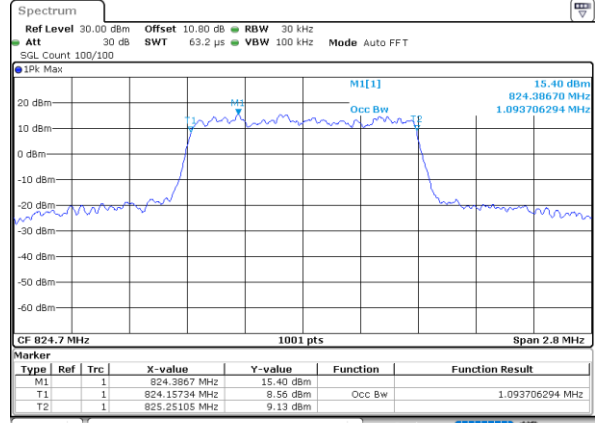

Date: 7.FEB.2018 22:10:27

Middle Channel / 1.4MHz / QPSK

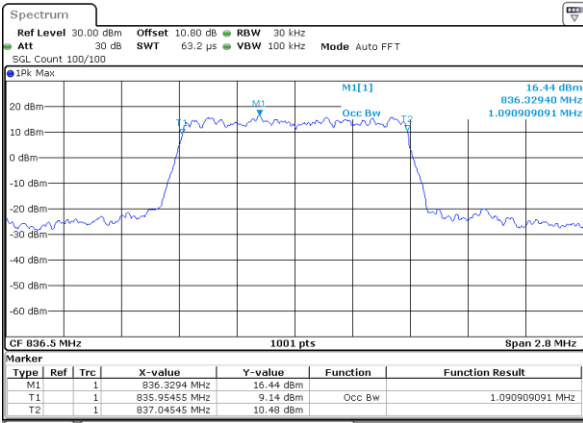

Date: 7.FEB.2018 22:19:15

Middle Channel / 1.4MHz / 16QAM

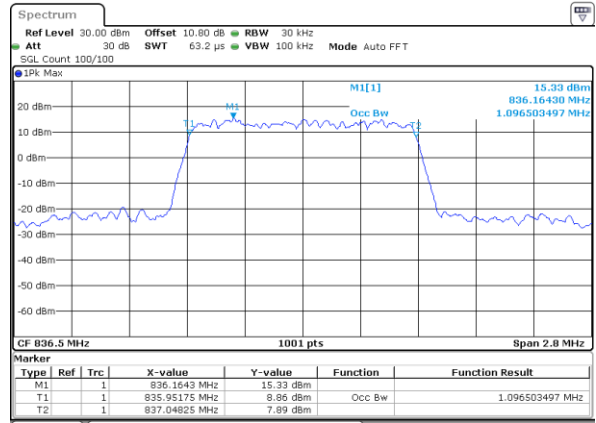

Date: 7.FEB.2018 22:19:24

Highest Channel / 1.4MHz / QPSK

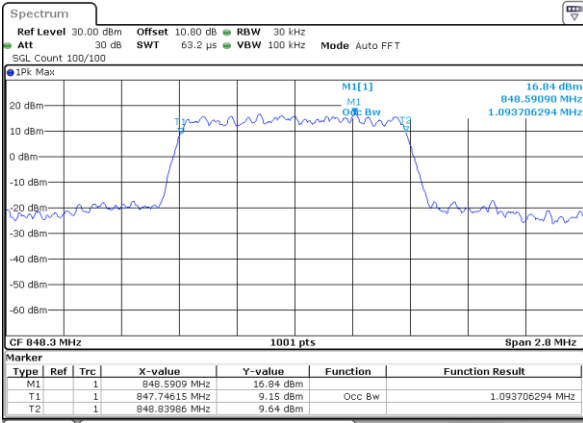

Date: 7.FEB.2018 22:21:40

Highest Channel / 1.4MHz / 16QAM

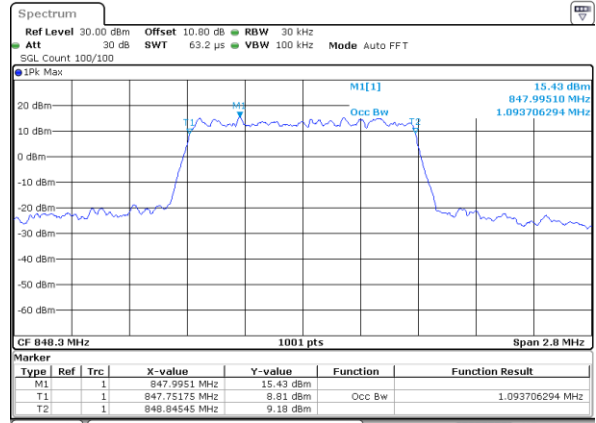

Date: 7.FEB.2018 22:21:50



LTE Band 5

Lowest Channel / 3MHz / QPSK

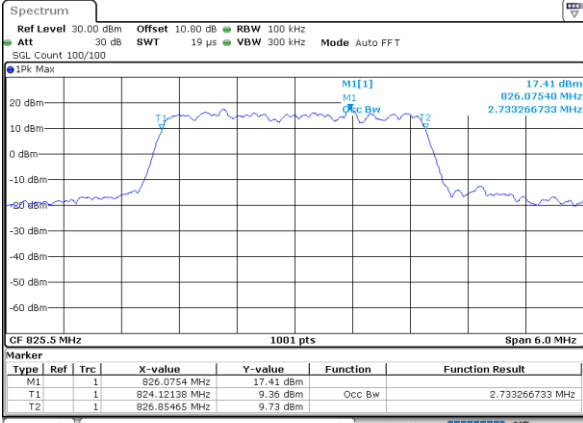

Date: 7.FEB.2018 21:09:14

Lowest Channel / 3MHz / 16QAM

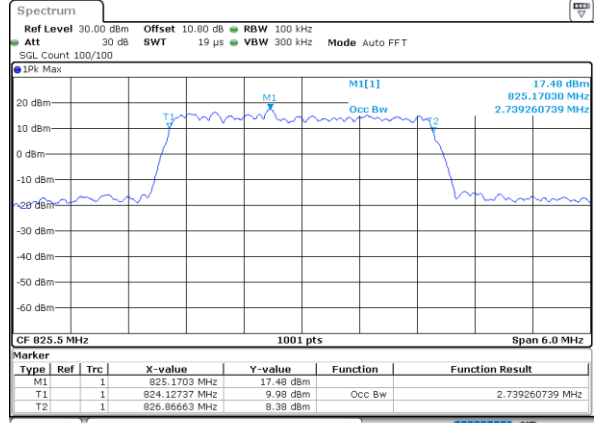

Date: 7.FEB.2018 21:09:24

Middle Channel / 3MHz / QPSK

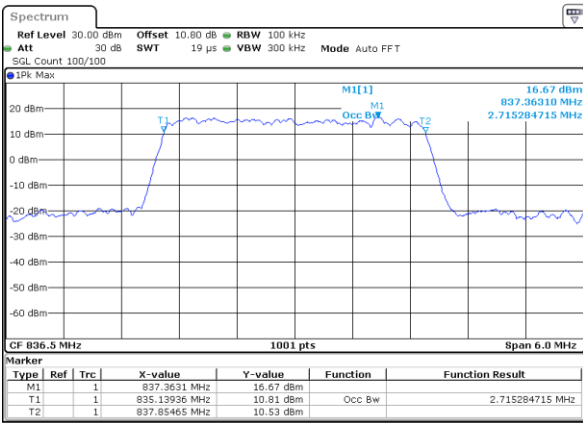

Date: 7.FEB.2018 21:18:12

Middle Channel / 3MHz / 16QAM

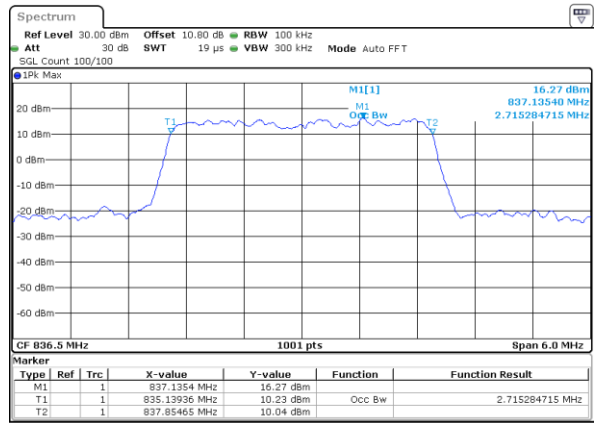

Date: 7.FEB.2018 21:18:22

Highest Channel / 3MHz / QPSK

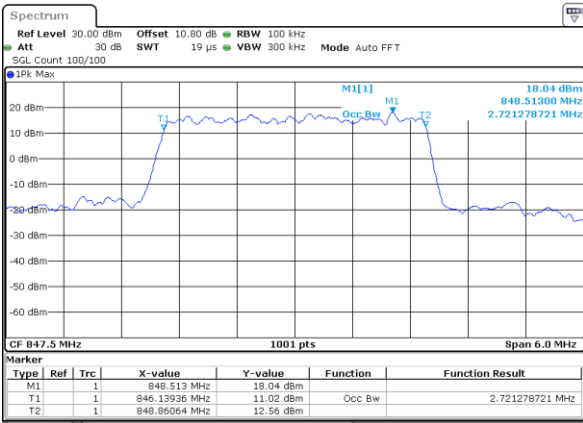

Date: 7.FEB.2018 21:20:38

Highest Channel / 3MHz / 16QAM

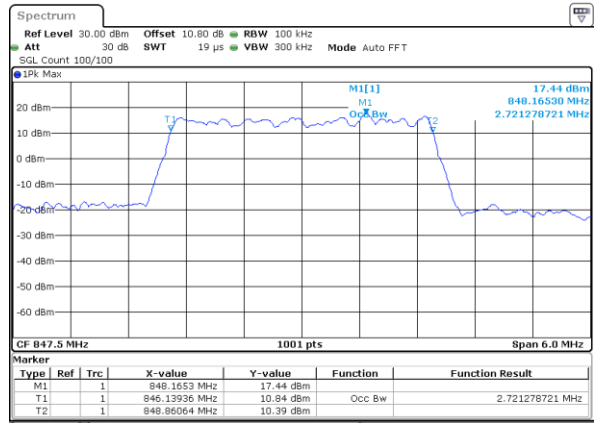

Date: 7.FEB.2018 21:20:47



LTE Band 5

Lowest Channel / 5MHz / QPSK

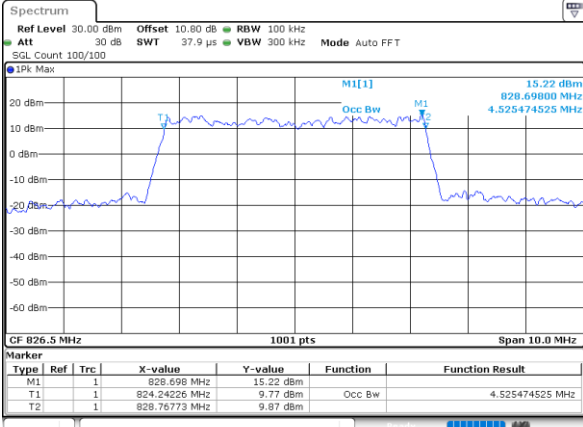

Date: 7.FEB.2018 21:29:35

Lowest Channel / 5MHz / 16QAM

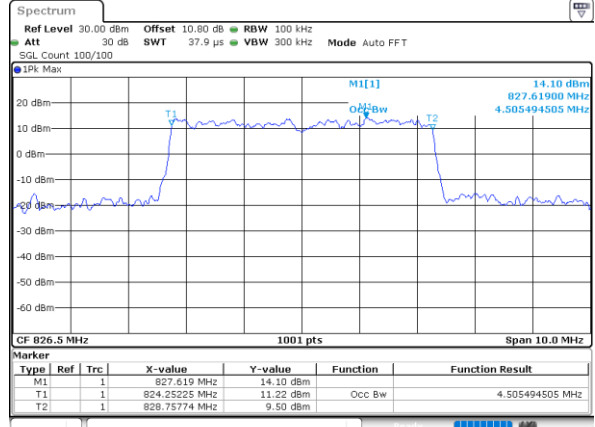

Date: 7.FEB.2018 21:29:45

Middle Channel / 5MHz / QPSK

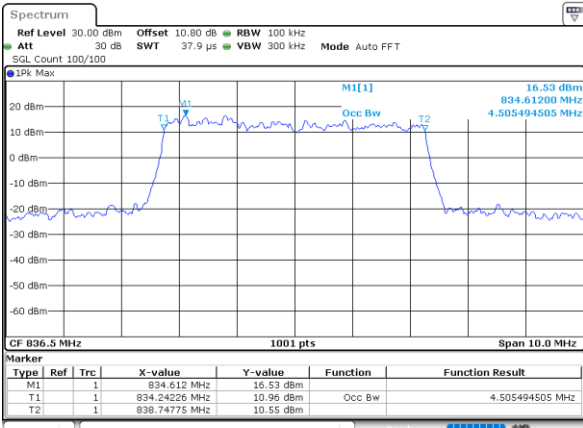

Date: 7.FEB.2018 21:38:33

Middle Channel / 5MHz / 16QAM

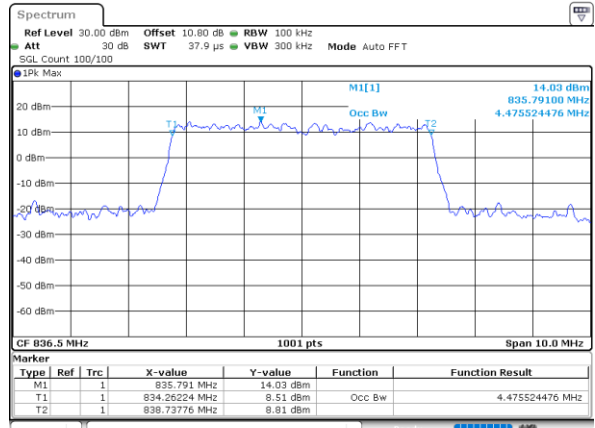

Date: 7.FEB.2018 21:38:43

Highest Channel / 5MHz / QPSK

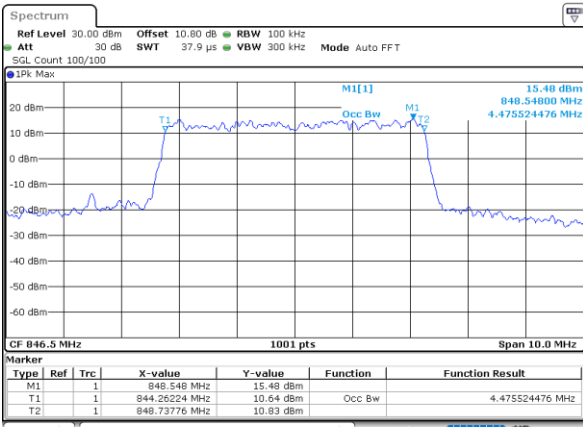

Date: 7.FEB.2018 21:40:59

Highest Channel / 5MHz / 16QAM

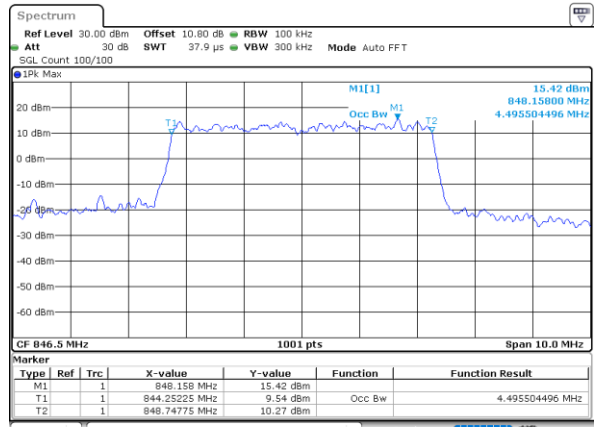

Date: 7.FEB.2018 21:41:08



LTE Band 5

Lowest Channel / 10MHz / QPSK

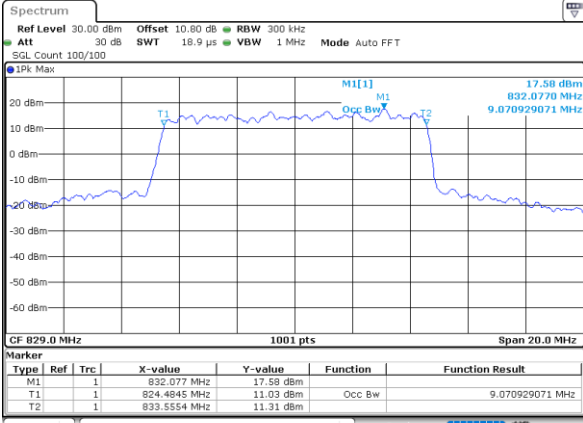

Date: 7.FEB.2018 21:49:56

Lowest Channel / 10MHz / 16QAM

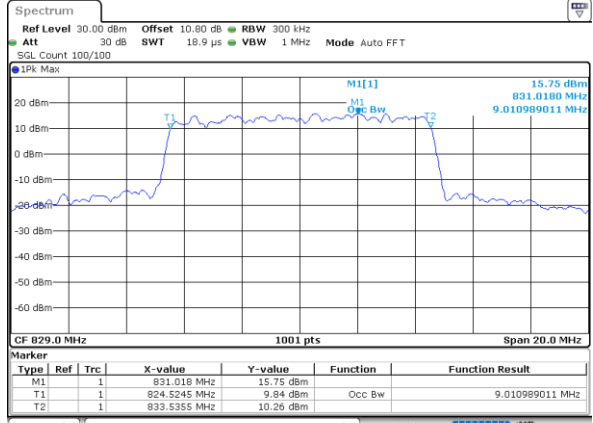

Date: 7.FEB.2018 21:50:06

Middle Channel / 10MHz / QPSK

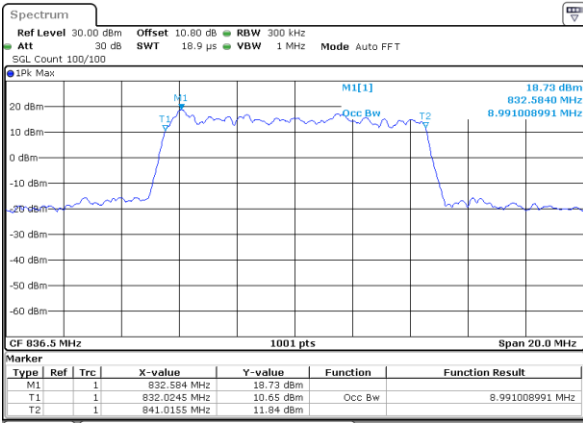

Date: 7.FEB.2018 21:58:54

Middle Channel / 10MHz / 16QAM

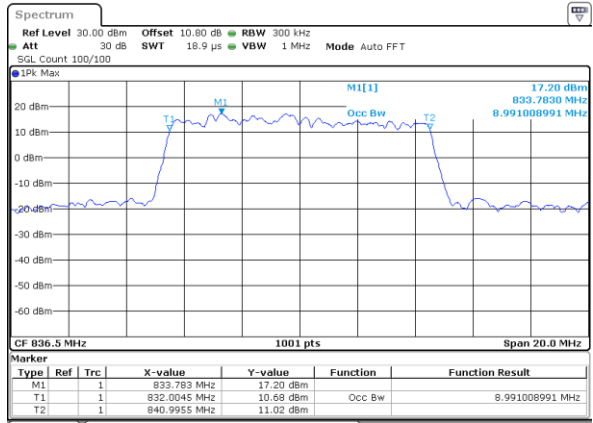

Date: 7.FEB.2018 21:59:03

Highest Channel / 10MHz / QPSK

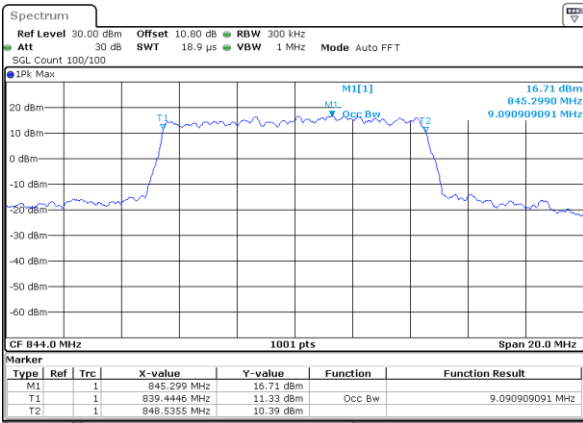

Date: 7.FEB.2018 22:01:19

Highest Channel / 10MHz / 16QAM

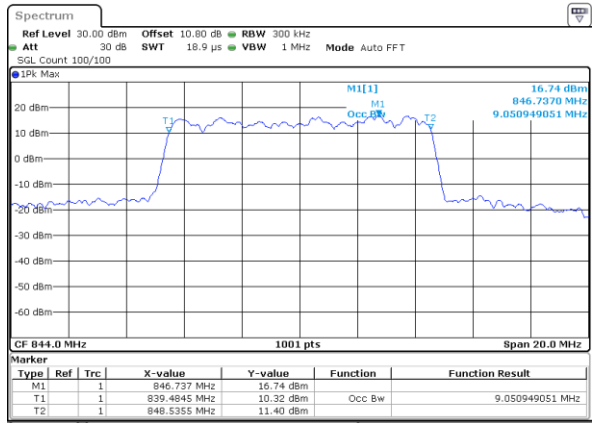

Date: 7.FEB.2018 22:01:29



LTE Band 5

Lowest Channel / 1.4MHz / 64QAM

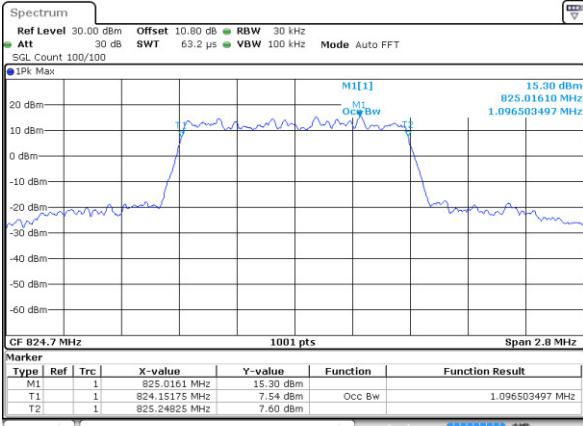

Date: 12.FEB.2018 13:33:04

Lowest Channel / 3MHz / 64QAM

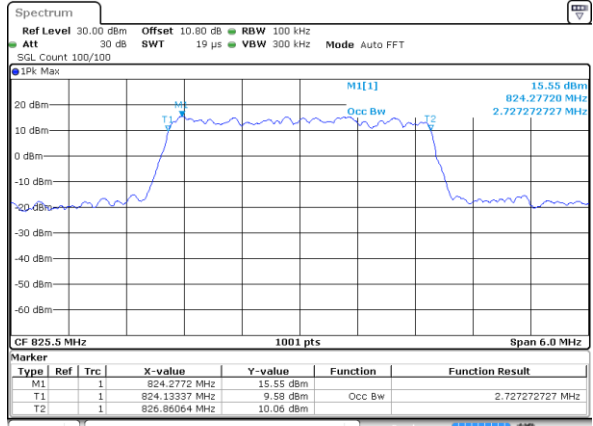

Date: 12.FEB.2018 13:02:36

Middle Channel / 1.4MHz / 64QAM

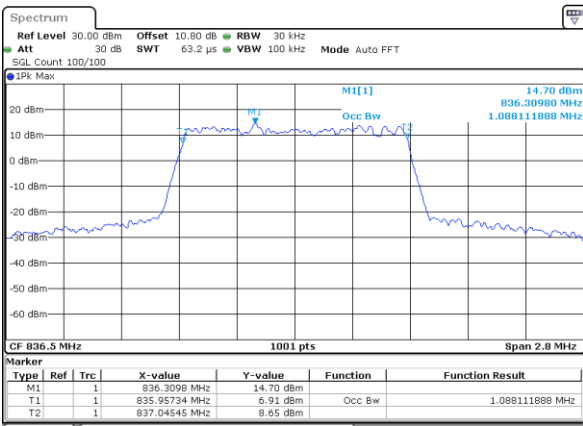

Date: 12.FEB.2018 13:37:32

Middle Channel / 3MHz / 64QAM

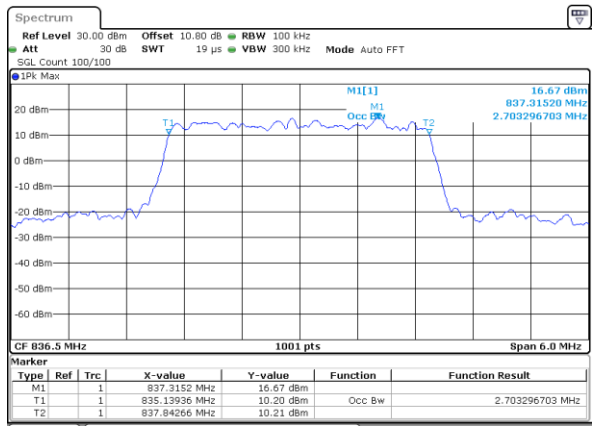

Date: 12.FEB.2018 13:07:04

Highest Channel / 1.4MHz / 64QAM

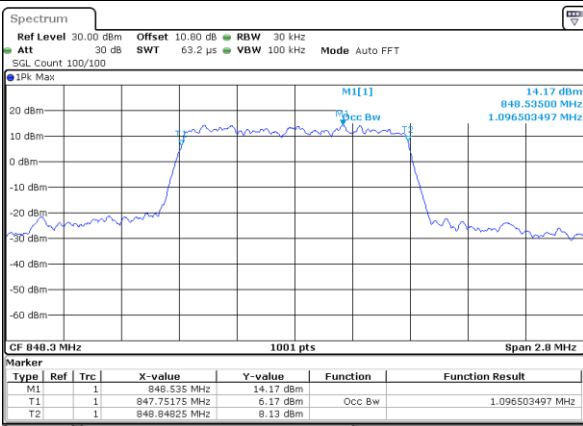

Date: 12.FEB.2018 13:38:45

Highest Channel / 3MHz / 64QAM

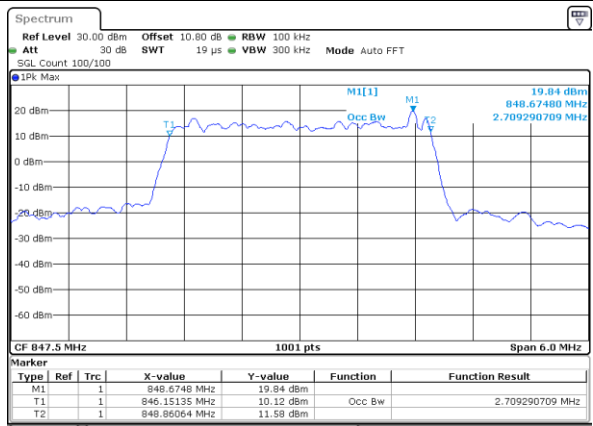

Date: 12.FEB.2018 13:08:17



LTE Band 5

Lowest Channel / 5MHz / 64QAM

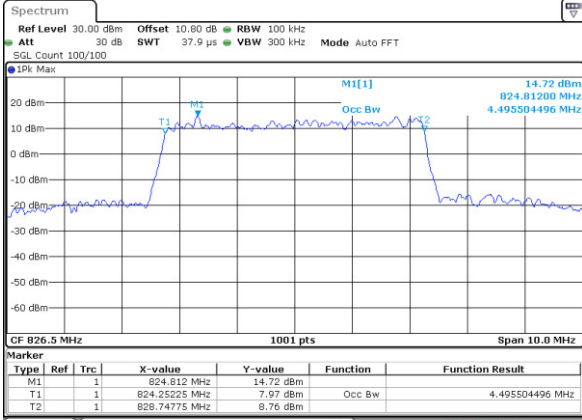

Date: 12 FEB 2018 13:12:45

Lowest Channel / 10MHz / 64QAM

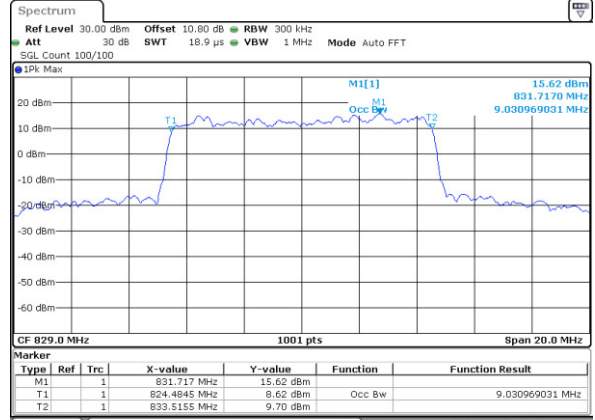

Date: 12 FEB 2018 13:22:55

Middle Channel / 5MHz / 64QAM

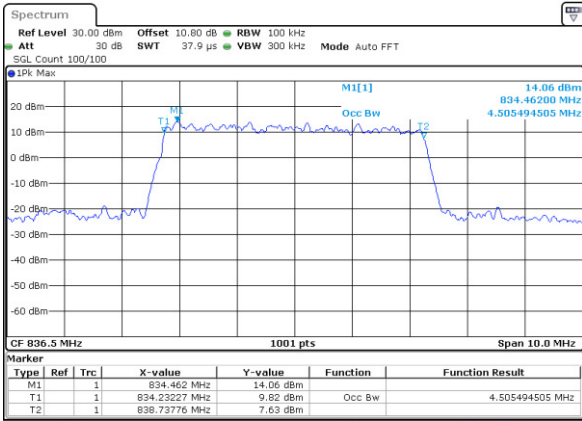

Date: 12 FEB 2018 13:17:13

Middle Channel / 10MHz / 64QAM

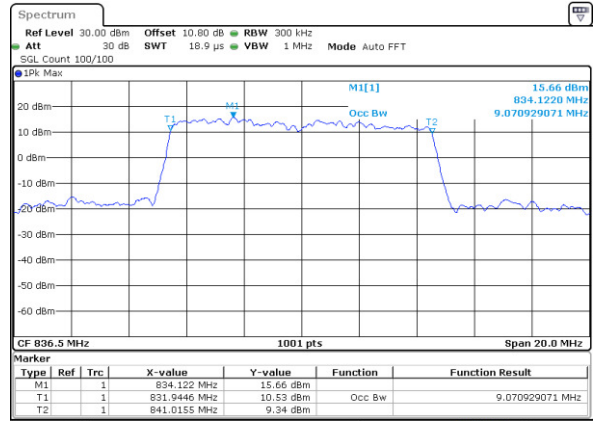

Date: 12 FEB 2018 13:27:23

Highest Channel / 5MHz / 64QAM

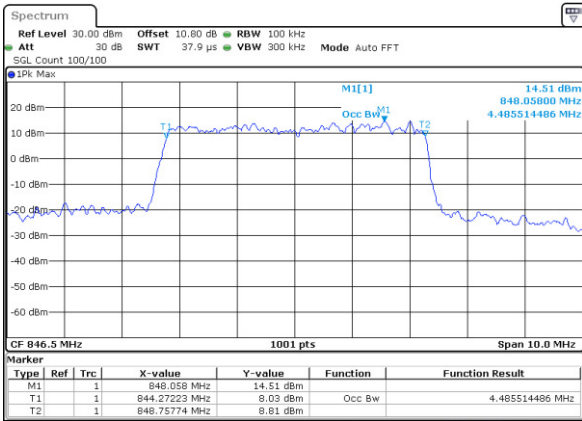

Date: 12 FEB 2018 13:18:27

Highest Channel / 10MHz / 64QAM

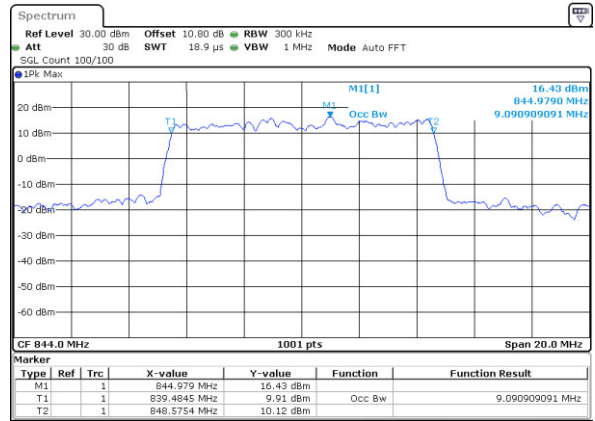

Date: 12 FEB 2018 13:28:36



Conducted Band Edge

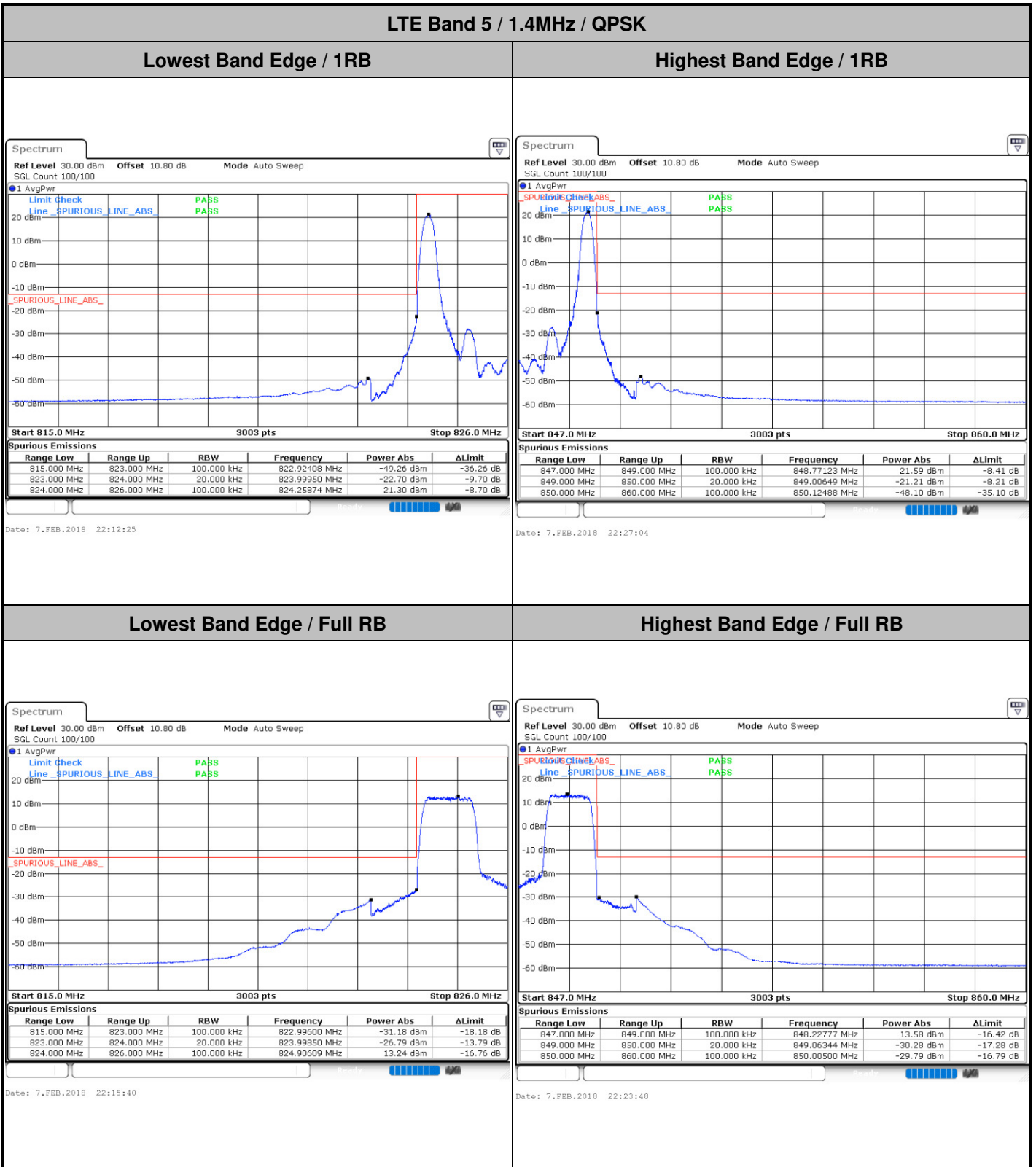



LTE Band 5 / 1.4MHz / 16QAM

Lowest Band Edge / 1 RB

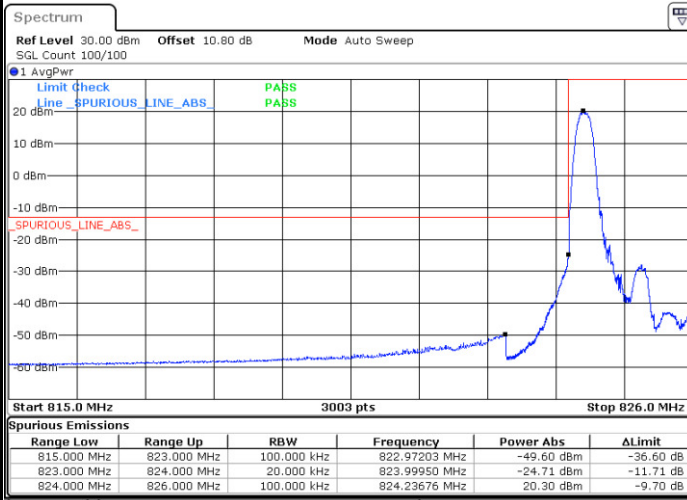

Date: 7.FEB.2018 22:14:02

Highest Band Edge / 1 RB

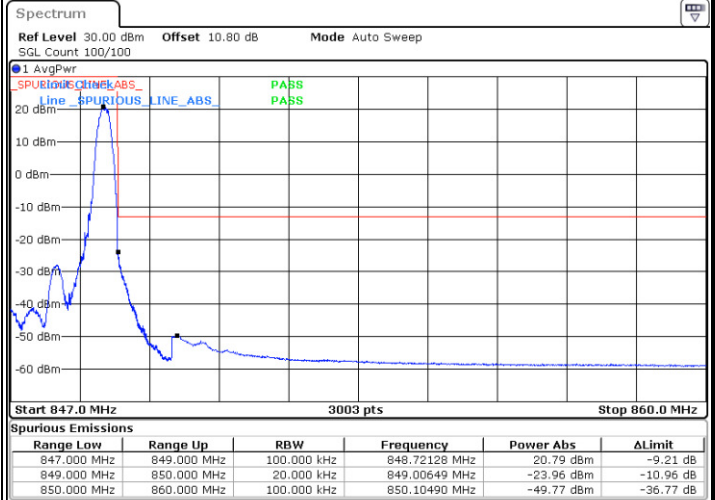

Date: 7.FEB.2018 22:28:42

Lowest Band Edge / Full RB

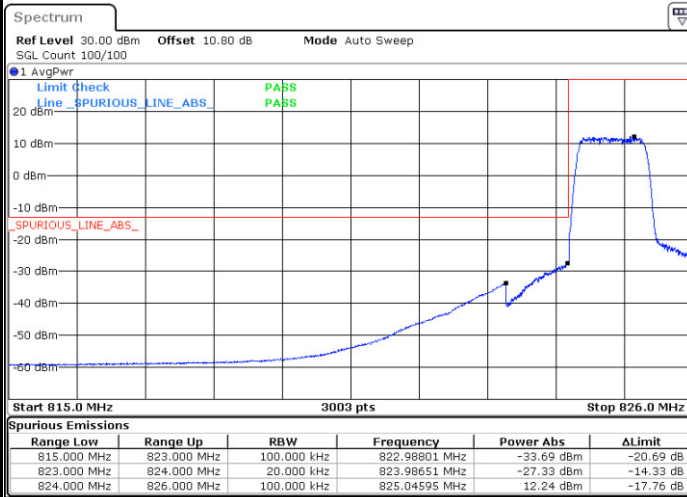

Date: 7.FEB.2018 22:17:18

Highest Band Edge / Full RB



Date: 7.FEB.2018 22:25:26



LTE Band 5 / 1.4MHz / 64QAM

Lowest Band Edge / 1 RB

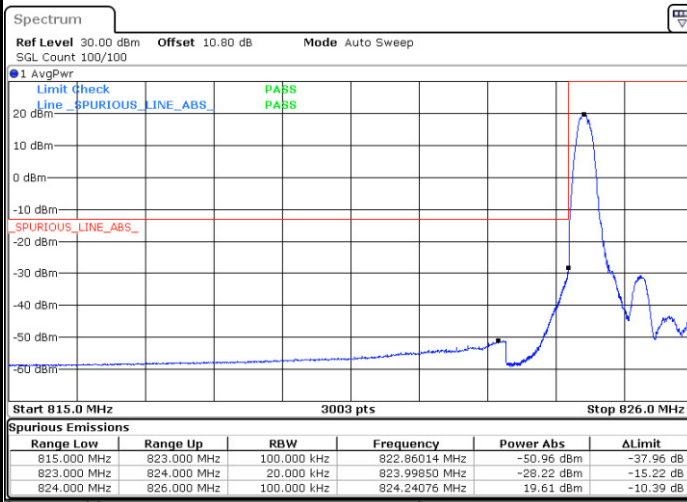

Date: 12.FEB.2018 13:34:51

Highest Band Edge / 1 RB

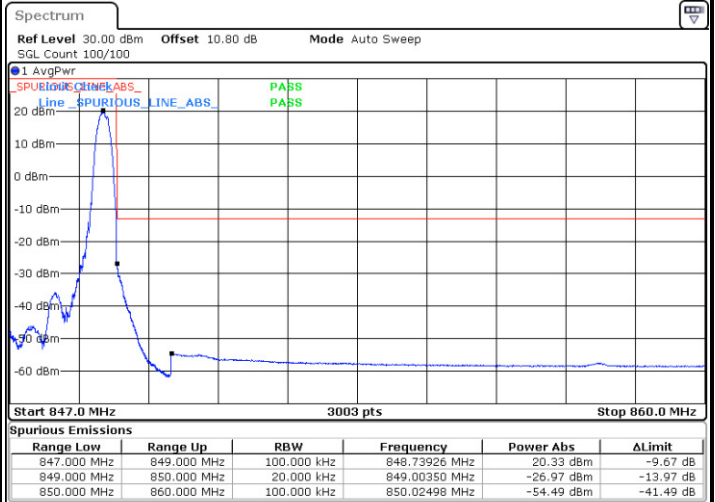

Date: 12.FEB.2018 13:42:10

Lowest Band Edge / Full RB

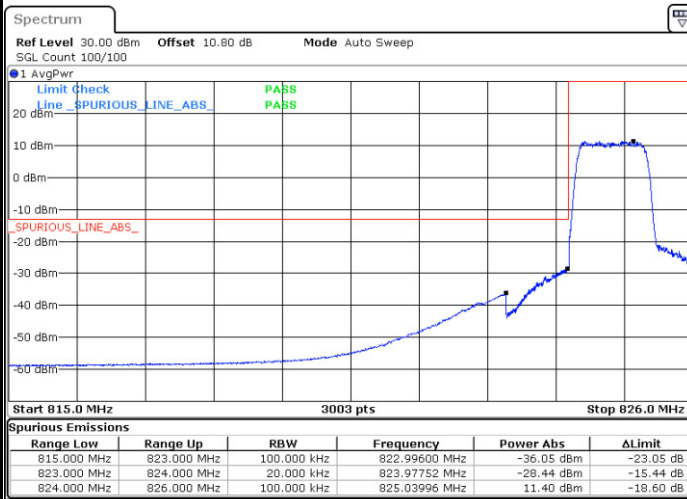

Date: 12.FEB.2018 13:36:29

Highest Band Edge / Full RB

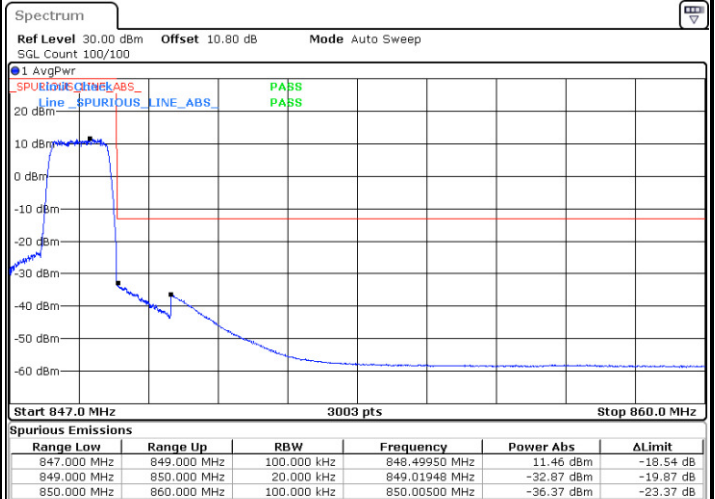

Date: 12.FEB.2018 13:40:33



LTE Band 5 / 3MHz / QPSK

Lowest Band Edge / 1RB

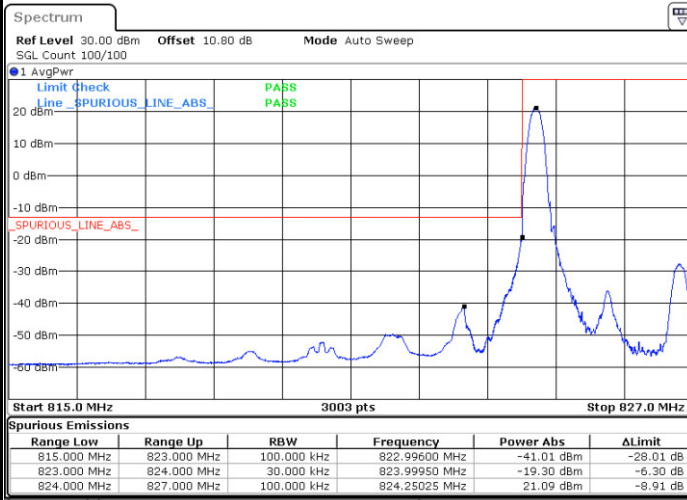

Date: 7.FEB.2018 21:11:22

Highest Band Edge / 1 RB

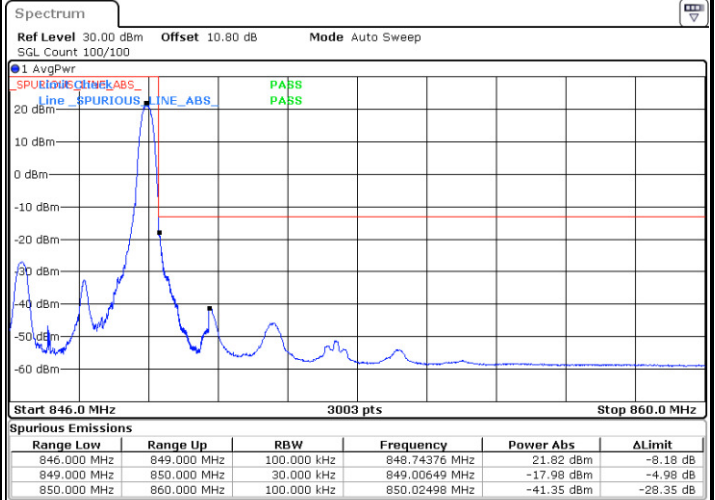

Date: 7.FEB.2018 21:22:45

Lowest Band Edge / Full RB

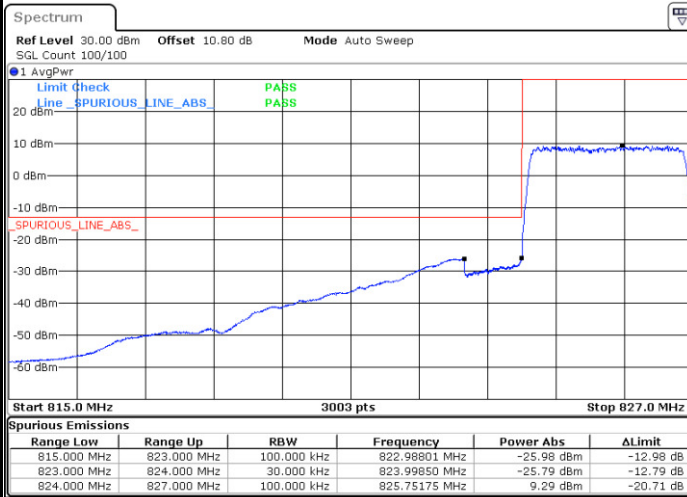

Date: 7.FEB.2018 21:14:37

Highest Band Edge / Full RB



Date: 7.FEB.2018 21:26:01