

FCC SAR Test Report

APPLICANT : HMD Global Oy
EQUIPMENT : Smart Phone
BRAND NAME : NOKIA
MODEL NAME : TA-1038
FCC ID : 2AJOTTA-1038
STANDARD : FCC 47 CFR Part 2 (2.1093)
ANSI/IEEE C95.1-1992
IEEE 1528-2013

We, SPORTON INTERNATIONAL (KUNSHAN) INC., would like to declare that the tested sample has been evaluated in accordance with the procedures and had been in compliance with the applicable technical standards.

The test results in this report apply exclusively to the tested model / sample. Without written approval of SPORTON INTERNATIONAL (KUNSHAN) INC., the test report shall not be reproduced except in full.



Prepared by: Mark Qu / Manager



Approved by: Jones Tsai / Manager



Sporton International (KunShan) INC.
No.3-2, Pingxiang Road, Kunshan Development Zone, Jiangsu, China



Table of Contents

1. Statement of Compliance 4

2. Administration Data 5

3. Guidance Applied..... 5

4. Equipment Under Test (EUT) Information 6

 4.1 General Information 6

 4.2 General LTE SAR Test and Reporting Considerations 8

5. RF Exposure Limits.....10

 5.1 Uncontrolled Environment.....10

 5.2 Controlled Environment.....10

6. Specific Absorption Rate (SAR).....11

 6.1 Introduction 11

 6.2 SAR Definition..... 11

7. System Description and Setup12

 7.1 E-Field Probe 13

 7.2 Data Acquisition Electronics (DAE) 13

 7.3 Phantom..... 14

 7.4 Device Holder..... 15

8. Measurement Procedures16

 8.1 Spatial Peak SAR Evaluation 16

 8.2 Power Reference Measurement..... 17

 8.3 Area Scan 17

 8.4 Zoom Scan..... 18

 8.5 Volume Scan Procedures..... 18

 8.6 Power Drift Monitoring..... 18

9. Test Equipment List19

10. System Verification20

 10.1 Tissue Simulating Liquids..... 20

 10.2 Tissue Verification 21

 10.3 System Performance Check Results..... 23

11. RF Exposure Positions24

 11.1 Ear and handset reference point 24

 11.2 Definition of the cheek position..... 25

 11.3 Definition of the tilt position..... 26

 11.4 Body Worn Accessory 27

 11.5 Wireless Router..... 27

12. Conducted RF Output Power (Unit: dBm).....28

13. Bluetooth Exclusions Applied63

14. Antenna Location64

15. SAR Test Results65

 15.1 Head SAR 67

 15.2 Hotspot SAR 70

 15.3 Body Worn Accessory SAR..... 74

 15.4 Repeated SAR Measurement 77

16. Simultaneous Transmission Analysis78

 16.1 Head Exposure Conditions 79

 16.2 Hotspot Exposure Conditions..... 81

 16.3 Body-Worn Accessory Exposure Conditions 83

17. Uncertainty Assessment84

18. References87

Appendix A. Plots of System Performance Check

Appendix B. Plots of High SAR Measurement

Appendix C. DASYS Calibration Certificate

Appendix D. Test Setup Photos

1. Statement of Compliance

The maximum results of Specific Absorption Rate (SAR) found during testing for **HMD Global Oy, Smart Phone, TA-1038** are as follows.

| Equipment Class | Frequency Band | | Highest SAR Summary | | | Highest Simultaneous Transmission 1g SAR (W/kg) |
|------------------|----------------|-------------|-----------------------|-----------------------------|---------------------------|---|
| | | | Head (Separation 0mm) | Body-worn (Separation 15mm) | Hotspot (Separation 10mm) | |
| | | | 1g SAR (W/kg) | | | |
| Licensed | GSM | GSM850 | 0.48 | 0.68 | 1.17 | 1.34 |
| | | GSM1900 | 0.15 | 0.63 | 1.19 | |
| | WCDMA | Band V | 0.35 | 0.47 | 0.70 | |
| | | Band IV | 0.35 | 1.15 | 1.11 | |
| | | Band II | 0.22 | 0.94 | 1.03 | |
| | LTE | Band 12 | 0.27 | 0.51 | 0.54 | |
| | | Band 4 | 0.32 | 1.02 | 1.14 | |
| | | Band 2 | 0.26 | 0.82 | 0.99 | |
| | | Band 7 | 0.14 | 0.56 | 0.66 | |
| | | Band 38 | <0.10 | 0.28 | 1.04 | |
| DTS | WLAN | 2.4GHz WLAN | 0.76 | <0.10 | 0.17 | 1.34 |
| NII | | 5GHz WLAN | <0.10 | <0.10 | | 1.16 |
| Date of Testing: | | | 2017/1/24 ~ 2017/2/16 | | | |

This device is in compliance with Specific Absorption Rate (SAR) for general population/uncontrolled exposure limits (1.6 W/kg) specified in FCC 47 CFR part 2 (2.1093) and ANSI/IEEE C95.1-1992, and had been tested in accordance with the measurement methods and procedures specified in IEEE 1528-2013 and FCC KDB publications.



2. Administration Data

| Testing Site | |
|--------------------|--|
| Test Site | Sporton International (KunShan) INC. |
| Test Site Location | No.3-2, Pingxiang Road, Kunshan Development Zone, Jiangsu, China TEL: +86-0512-5790-0158 FAX: +86-0512-5790-0958 |

| Applicant | |
|--------------|------------------------------------|
| Company Name | HMD Global Oy |
| Address | Karaportti 2, 02610 Espoo, Finland |

| Manufacturer | |
|--------------|------------------------------------|
| Company Name | HMD Global Oy |
| Address | Karaportti 2, 02610 Espoo, Finland |

3. Guidance Applied

The Specific Absorption Rate (SAR) testing specification, method, and procedure for this device is in accordance with the following standards:

- FCC 47 CFR Part 2 (2.1093)
- ANSI/IEEE C95.1-1992
- IEEE 1528-2013
- FCC KDB 865664 D01 SAR Measurement 100 MHz to 6 GHz v01r04
- FCC KDB 865664 D02 SAR Reporting v01r02
- FCC KDB 447498 D01 General RF Exposure Guidance v06
- FCC KDB 648474 D04 SAR Evaluation Considerations for Wireless Handsets v01r03
- FCC KDB 248227 D01 802.11 Wi-Fi SAR v02r02
- FCC KDB 941225 D01 3G SAR Procedures v03r01
- FCC KDB 941225 D05 SAR for LTE Devices v02r05
- FCC KDB 941225 D06 Hotspot Mode SAR v02r01



4. Equipment Under Test (EUT) Information

4.1 General Information

| Product Feature & Specification | |
|---|---|
| Equipment Name | Smart Phone |
| Brand Name | NOKIA |
| Model Name | TA-1038 |
| FCC ID | 2AJOTTA-1038 |
| IMEI Code | For WWAN Sample: 356805080000765 356805080000773 For WLAN Sample: 356805080001680 356805080001698 |
| Wireless Technology and Frequency Range | GSM850: 824.2 MHz ~ 848.8 MHz GSM1900: 1850.2 MHz ~ 1909.8 MHz WCDMA Band II: 1852.4 MHz ~ 1907.6 MHz WCDMA Band IV: 1712.4 MHz ~ 1752.6 MHz WCDMA Band V: 826.4 MHz ~ 846.6 MHz LTE Band 2: 1850.7 MHz ~ 1909.3 MHz LTE Band 4: 1710.7 MHz ~ 1754.3 MHz LTE Band 7: 2502.5 MHz ~ 2567.5 MHz LTE Band 12: 699.7 MHz ~ 715.3 MHz LTE Band 17: 706.5 MHz ~ 713.5 MHz LTE Band 38: 2572.5 MHz ~ 2617.5 MHz WLAN 2.4GHz Band: 2412 MHz ~ 2462 MHz WLAN 5.2GHz Band: 5180 MHz ~ 5240 MHz WLAN 5.3GHz Band: 5260 MHz ~ 5320 MHz WLAN 5.5GHz Band: 5500 MHz ~ 5700 MHz WLAN 5.8GHz Band: 5745 MHz ~ 5825 MHz Bluetooth: 2402 MHz ~ 2480 MHz NFC : 13.56 MHz |
| Mode | <ul style="list-style-type: none"> · GSM/GPRS/EGPRS · RMC/AMR 12.2Kbps · HSDPA · HSUPA · DC-HSDPA · HSPA+(16QAM uplink) · LTE: QPSK, 16QAM · 802.11b/g/n HT20 · 802.11a/n HT20/HT40 · Bluetooth v3.0 + EDR, Bluetooth v4.0 LE, Bluetooth v4.1 LE, Bluetooth v4.2 LE · NFC:ASK |
| HW Version | DVT1.5 |
| SW Version | 000C_1_26A |
| GSM / (E)GPRS Transfer mode | Class B – EUT cannot support Packet Switched and Circuit Switched Network simultaneously but can automatically switch between Packet and Circuit Switched Network. |
| EUT Stage | Production Unit |
| Remark: | <ol style="list-style-type: none"> 1. 802.11n-HT40 is not supported in 2.4GHz WLAN. 2. This device supports VoIP in GPRS, EGPRS, WCDMA and LTE (e.g. for 3rd-party VoIP), LTE supports VoLTE operation. 3. This device 2.4GHz WLAN support hotspot operation. 4. This device 5GHz WLAN not support hotspot operation, and 5.2GHz WLAN/5.8GHz WLAN supports WiFi Direct (GC/GO), and 5.3GHz / 5.5GHz supports WiFi Direct (GC only). 5. This device does not support DTM operation. 6. This device supports GRPS/EGRPS mode up to multi-slot class 12. 7. When hotspot mode is enabled, power reduction will be activated and limited to GSM1900, WCDMA Band IV/II, LTE |



Band 2/4/7.

8. This device has 2 SIM slots and supports dual SIM dual standby. The WWAN radio transmission will be enabled by either one SIM at a time (Single active). After pre-scan two SIM cards power, we found test result of the SIM1 was the worse, so we chose SIM1 slot to perform all tests.
9. 5600~5650MHz is notched.



4.2 General LTE SAR Test and Reporting Considerations

| Summarized necessary items addressed in KDB 941225 D05 v02r05 | | | | | | | | | | | | | | | | | | | | | | | | | | | | | | | | | | | | | | | |
|---|---|------------|---|--------|--------|--------|----------|--|----------|---------|---------|-------|--------|--------|--------|------|-----|-----|-----|------|------|------|-----|--------|-----|-----|-----|------|------|------|-----|--------|-----|-----|-----|------|------|------|-----|
| FCC ID | 2AJOTTA-1038 | | | | | | | | | | | | | | | | | | | | | | | | | | | | | | | | | | | | | | |
| Equipment Name | Smart Phone | | | | | | | | | | | | | | | | | | | | | | | | | | | | | | | | | | | | | | |
| Operating Frequency Range of each LTE transmission band | LTE Band 2: 1850.7 MHz ~ 1909.3 MHz LTE Band 4: 1710.7 MHz ~ 1754.3 MHz LTE Band 7: 2502.5 MHz ~ 2567.5 MHz LTE Band 12: 699.7 MHz ~ 715.3 MHz LTE Band 17: 706.5 MHz ~ 713.5 MHz LTE Band 38: 2572.5 MHz ~ 2617.5 MHz | | | | | | | | | | | | | | | | | | | | | | | | | | | | | | | | | | | | | | |
| Channel Bandwidth | LTE Band 2: 1.4MHz, 3MHz, 5MHz, 10MHz, 15MHz, 20MHz LTE Band 4: 1.4MHz, 3MHz, 5MHz, 10MHz, 15MHz, 20MHz LTE Band 7: 5MHz, 10MHz, 15MHz, 20MHz LTE Band 12: 1.4MHz, 3MHz, 5MHz, 10MHz LTE Band 17: 5MHz, 10MHz LTE Band 38: 5MHz, 10MHz, 15MHz, 20MHz | | | | | | | | | | | | | | | | | | | | | | | | | | | | | | | | | | | | | | |
| uplink modulations used | QPSK, and 16QAM | | | | | | | | | | | | | | | | | | | | | | | | | | | | | | | | | | | | | | |
| LTE Voice / Data requirements | Voice and Data | | | | | | | | | | | | | | | | | | | | | | | | | | | | | | | | | | | | | | |
| LTE MPR permanently built-in by design | <p style="text-align: center;">Table 6.2.3-1: Maximum Power Reduction (MPR) for Power Class 3</p> <table border="1"> <thead> <tr> <th rowspan="2">Modulation</th> <th colspan="6">Channel bandwidth / Transmission bandwidth (RB)</th> <th rowspan="2">MPR (dB)</th> </tr> <tr> <th>1.4 MHz</th> <th>3.0 MHz</th> <th>5 MHz</th> <th>10 MHz</th> <th>15 MHz</th> <th>20 MHz</th> </tr> </thead> <tbody> <tr> <td>QPSK</td> <td>> 5</td> <td>> 4</td> <td>> 8</td> <td>> 12</td> <td>> 16</td> <td>> 18</td> <td>≤ 1</td> </tr> <tr> <td>16 QAM</td> <td>≤ 5</td> <td>≤ 4</td> <td>≤ 8</td> <td>≤ 12</td> <td>≤ 16</td> <td>≤ 18</td> <td>≤ 1</td> </tr> <tr> <td>16 QAM</td> <td>> 5</td> <td>> 4</td> <td>> 8</td> <td>> 12</td> <td>> 16</td> <td>> 18</td> <td>≤ 2</td> </tr> </tbody> </table> | Modulation | Channel bandwidth / Transmission bandwidth (RB) | | | | | | MPR (dB) | 1.4 MHz | 3.0 MHz | 5 MHz | 10 MHz | 15 MHz | 20 MHz | QPSK | > 5 | > 4 | > 8 | > 12 | > 16 | > 18 | ≤ 1 | 16 QAM | ≤ 5 | ≤ 4 | ≤ 8 | ≤ 12 | ≤ 16 | ≤ 18 | ≤ 1 | 16 QAM | > 5 | > 4 | > 8 | > 12 | > 16 | > 18 | ≤ 2 |
| Modulation | Channel bandwidth / Transmission bandwidth (RB) | | | | | | MPR (dB) | | | | | | | | | | | | | | | | | | | | | | | | | | | | | | | | |
| | 1.4 MHz | 3.0 MHz | 5 MHz | 10 MHz | 15 MHz | 20 MHz | | | | | | | | | | | | | | | | | | | | | | | | | | | | | | | | | |
| QPSK | > 5 | > 4 | > 8 | > 12 | > 16 | > 18 | ≤ 1 | | | | | | | | | | | | | | | | | | | | | | | | | | | | | | | | |
| 16 QAM | ≤ 5 | ≤ 4 | ≤ 8 | ≤ 12 | ≤ 16 | ≤ 18 | ≤ 1 | | | | | | | | | | | | | | | | | | | | | | | | | | | | | | | | |
| 16 QAM | > 5 | > 4 | > 8 | > 12 | > 16 | > 18 | ≤ 2 | | | | | | | | | | | | | | | | | | | | | | | | | | | | | | | | |
| LTE A-MPR | In the base station simulator configuration, Network Setting value is set to NS_01 to disable A-MPR during SAR testing and the LTE SAR tests was transmitting on all TTI frames (Maximum TTI) | | | | | | | | | | | | | | | | | | | | | | | | | | | | | | | | | | | | | | |
| Spectrum plots for RB configuration | A properly configured base station simulator was used for the SAR and power measurement; therefore, spectrum plots for each RB allocation and offset configuration are not included in the SAR report. | | | | | | | | | | | | | | | | | | | | | | | | | | | | | | | | | | | | | | |
| Power reduction applied to satisfy SAR compliance | Yes, when operating in hotspot mode that GSM1900, WCDMA Band IV/II, LTE Band 2/4/7 power reduction applied to satisfy SAR compliance. | | | | | | | | | | | | | | | | | | | | | | | | | | | | | | | | | | | | | | |
| LTE Release Version | R9, Cat 3 | | | | | | | | | | | | | | | | | | | | | | | | | | | | | | | | | | | | | | |
| CA Support | No | | | | | | | | | | | | | | | | | | | | | | | | | | | | | | | | | | | | | | |



| Transmission (H, M, L) channel numbers and frequencies in each LTE band | | | | | | | | | | | | |
|---|-------------------|-------------|------------------|-------------|------------------|-------------|------------------|-------------|------------------|-------------|------------------|-------------|
| LTE Band 2 | | | | | | | | | | | | |
| | Bandwidth 1.4 MHz | | Bandwidth 3 MHz | | Bandwidth 5 MHz | | Bandwidth 10 MHz | | Bandwidth 15 MHz | | Bandwidth 20 MHz | |
| | Ch. # | Freq. (MHz) | Ch. # | Freq. (MHz) | Ch. # | Freq. (MHz) | Ch. # | Freq. (MHz) | Ch. # | Freq. (MHz) | Ch. # | Freq. (MHz) |
| L | 18607 | 1850.7 | 18615 | 1851.5 | 18625 | 1852.5 | 18650 | 1855 | 18675 | 1857.5 | 18700 | 1860 |
| M | 18900 | 1880 | 18900 | 1880 | 18900 | 1880 | 18900 | 1880 | 18900 | 1880 | 18900 | 1880 |
| H | 19193 | 1909.3 | 19185 | 1908.5 | 19175 | 1907.5 | 19150 | 1905 | 19125 | 1902.5 | 19100 | 1900 |
| LTE Band 4 | | | | | | | | | | | | |
| | Bandwidth 1.4 MHz | | Bandwidth 3 MHz | | Bandwidth 5 MHz | | Bandwidth 10 MHz | | Bandwidth 15 MHz | | Bandwidth 20 MHz | |
| | Ch. # | Freq. (MHz) | Ch. # | Freq. (MHz) | Ch. # | Freq. (MHz) | Ch. # | Freq. (MHz) | Ch. # | Freq. (MHz) | Ch. # | Freq. (MHz) |
| L | 19957 | 1710.7 | 19965 | 1711.5 | 19975 | 1712.5 | 20000 | 1715 | 20025 | 1717.5 | 20050 | 1720 |
| M | 20175 | 1732.5 | 20175 | 1732.5 | 20175 | 1732.5 | 20175 | 1732.5 | 20175 | 1732.5 | 20175 | 1732.5 |
| H | 20393 | 1754.3 | 20385 | 1753.5 | 20375 | 1752.5 | 20350 | 1750 | 20325 | 1747.5 | 20300 | 1745 |
| LTE Band 7 | | | | | | | | | | | | |
| | Bandwidth 5 MHz | | Bandwidth 10 MHz | | Bandwidth 15 MHz | | Bandwidth 20 MHz | | | | | |
| | Ch. # | Freq. (MHz) | Ch. # | Freq. (MHz) | Ch. # | Freq. (MHz) | Ch. # | Freq. (MHz) | | | | |
| L | 20775 | 2502.5 | 20800 | 2505 | 20825 | 2507.5 | 20850 | 2510 | | | | |
| M | 21100 | 2535 | 21100 | 2535 | 21100 | 2535 | 21100 | 2535 | | | | |
| H | 21425 | 2567.5 | 21400 | 2565 | 21375 | 2562.5 | 21350 | 2560 | | | | |
| LTE Band 12 | | | | | | | | | | | | |
| | Bandwidth 1.4 MHz | | Bandwidth 3 MHz | | Bandwidth 5 MHz | | Bandwidth 10 MHz | | | | | |
| | Ch. # | Freq. (MHz) | Ch. # | Freq. (MHz) | Ch. # | Freq. (MHz) | Ch. # | Freq. (MHz) | | | | |
| L | 23017 | 699.7 | 23025 | 700.5 | 23035 | 701.5 | 23060 | 704 | | | | |
| M | 23095 | 707.5 | 23095 | 707.5 | 23095 | 707.5 | 23095 | 707.5 | | | | |
| H | 23173 | 715.3 | 23165 | 714.5 | 23155 | 713.5 | 23130 | 711 | | | | |
| LTE Band 17 | | | | | | | | | | | | |
| | Bandwidth 5 MHz | | | | Bandwidth 10 MHz | | | | | | | |
| | Channel # | | Freq. (MHz) | | Channel # | | Freq. (MHz) | | | | | |
| L | 23755 | | 706.5 | | 23780 | | 709 | | | | | |
| M | 23790 | | 710 | | 23790 | | 710 | | | | | |
| H | 23825 | | 713.5 | | 23800 | | 711 | | | | | |
| LTE Band 38 | | | | | | | | | | | | |
| | Bandwidth 5 MHz | | Bandwidth 10 MHz | | Bandwidth 15 MHz | | Bandwidth 20 MHz | | | | | |
| | Ch. # | Freq. (MHz) | Ch. # | Freq. (MHz) | Ch. # | Freq. (MHz) | Ch. # | Freq. (MHz) | | | | |
| L | 37775 | 2572.5 | 37800 | 2575 | 37825 | 2577.5 | 37850 | 2580 | | | | |
| M | 38000 | 2595 | 38000 | 2595 | 38000 | 2595 | 38000 | 2595 | | | | |
| H | 38225 | 2617.5 | 38200 | 2615 | 38175 | 2612.5 | 38150 | 2610 | | | | |

5. RF Exposure Limits

5.1 Uncontrolled Environment

Uncontrolled Environments are defined as locations where there is the exposure of individuals who have no knowledge or control of their exposure. The general population/uncontrolled exposure limits are applicable to situations in which the general public may be exposed or in which persons who are exposed as a consequence of their employment may not be made fully aware of the potential for exposure or cannot exercise control over their exposure. Members of the general public would come under this category when exposure is not employment-related; for example, in the case of a wireless transmitter that exposes persons in its vicinity.

5.2 Controlled Environment

Controlled Environments are defined as locations where there is exposure that may be incurred by persons who are aware of the potential for exposure, (i.e. as a result of employment or occupation). In general, occupational/controlled exposure limits are applicable to situations in which persons are exposed as a consequence of their employment, who have been made fully aware of the potential for exposure and can exercise control over their exposure. The exposure category is also applicable when the exposure is of a transient nature due to incidental passage through a location where the exposure levels may be higher than the general population/uncontrolled limits, but the exposed person is fully aware of the potential for exposure and can exercise control over his or her exposure by leaving the area or by some other appropriate means.

Limits for Occupational/Controlled Exposure (W/kg)

| Whole-Body | Partial-Body | Hands, Wrists, Feet and Ankles |
|------------|--------------|--------------------------------|
| 0.4 | 8.0 | 20.0 |

Limits for General Population/Uncontrolled Exposure (W/kg)

| Whole-Body | Partial-Body | Hands, Wrists, Feet and Ankles |
|------------|--------------|--------------------------------|
| 0.08 | 1.6 | 4.0 |

Whole-Body SAR is averaged over the entire body, partial-body SAR is averaged over any 1gram of tissue defined as a tissue volume in the shape of a cube. SAR for hands, wrists, feet and ankles is averaged over any 10 grams of tissue defined as a tissue volume in the shape of a cube.

6. Specific Absorption Rate (SAR)

6.1 Introduction

SAR is related to the rate at which energy is absorbed per unit mass in an object exposed to a radio field. The SAR distribution in a biological body is complicated and is usually carried out by experimental techniques or numerical modeling. The standard recommends limits for two tiers of groups, occupational/controlled and general population/uncontrolled, based on a person's awareness and ability to exercise control over his or her exposure. In general, occupational/controlled exposure limits are higher than the limits for general population/uncontrolled.

6.2 SAR Definition

The SAR definition is the time derivative (rate) of the incremental energy (dW) absorbed by (dissipated in) an incremental mass (dm) contained in a volume element (dv) of a given density (ρ). The equation description is as below:

$$SAR = \frac{d}{dt} \left(\frac{dW}{dm} \right) = \frac{d}{dt} \left(\frac{dW}{\rho dv} \right)$$

SAR is expressed in units of Watts per kilogram (W/kg)

$$SAR = \frac{\sigma |E|^2}{\rho}$$

Where: σ is the conductivity of the tissue, ρ is the mass density of the tissue and E is the RMS electrical field strength.

7.1 E-Field Probe

The SAR measurement is conducted with the dosimetric probe (manufactured by SPEAG).The probe is specially designed and calibrated for use in liquid with high permittivity. The dosimetric probe has special calibration in liquid at different frequency. This probe has a built in optical surface detection system to prevent from collision with phantom.

<EX3DV4 Probe>

| | | |
|----------------------|---|--|
| Construction | Symmetric design with triangular core Built-in shielding against static charges PEEK enclosure material (resistant to organic solvents, e.g., DGBE) |  |
| Frequency | 10 MHz – >6 GHz Linearity: ±0.2 dB (30 MHz – 6 GHz) | |
| Directivity | ±0.3 dB in TSL (rotation around probe axis) ±0.5 dB in TSL (rotation normal to probe axis) | |
| Dynamic Range | 10 µW/g – >100 mW/g Linearity: ±0.2 dB (noise: typically <1 µW/g) | |
| Dimensions | Overall length: 337 mm (tip: 20 mm) Tip diameter: 2.5 mm (body: 12 mm) Typical distance from probe tip to dipole centers: 1 mm | |

7.2 Data Acquisition Electronics (DAE)

The data acquisition electronics (DAE) consists of a highly sensitive electrometer-grade preamplifier with auto-zeroing, a channel and gain-switching multiplexer, a fast 16 bit AD-converter and a command decoder and control logic unit. Transmission to the measurement server is accomplished through an optical downlink for data and status information as well as an optical uplink for commands and the clock.

The input impedance of the DAE is 200 MOhm; the inputs are symmetrical and floating. Common mode rejection is above 80 dB.



Fig 5.1 Photo of DAE

7.3 Phantom

<SAM Twin Phantom>

| | | |
|--------------------------|---|--|
| Shell Thickness | 2 ± 0.2 mm; Center ear point: 6 ± 0.2 mm |  |
| Filling Volume | Approx. 25 liters | |
| Dimensions | Length: 1000 mm; Width: 500 mm; Height: adjustable feet | |
| Measurement Areas | Left Hand, Right Hand, Flat Phantom | |

The bottom plate contains three pair of bolts for locking the device holder. The device holder positions are adjusted to the standard measurement positions in the three sections. A white cover is provided to tap the phantom during off-periods to prevent water evaporation and changes in the liquid parameters. On the phantom top, three reference markers are provided to identify the phantom position with respect to the robot.

<ELI Phantom>

| | | |
|------------------------|--|---|
| Shell Thickness | 2 ± 0.2 mm (sagging: <1%) |  |
| Filling Volume | Approx. 30 liters | |
| Dimensions | Major ellipse axis: 600 mm Minor axis: 400 mm | |

The ELI phantom is intended for compliance testing of handheld and body-mounted wireless devices in the frequency range of 30 MHz to 6 GHz. ELI4 is fully compatible with standard and all known tissue simulating liquids.

7.4 Device Holder

<Mounting Device for Hand-Held Transmitter>

In combination with the Twin SAM V5.0/V5.0c or ELI phantoms, the Mounting Device for Hand-Held Transmitters enables rotation of the mounted transmitter device to specified spherical coordinates. At the heads, the rotation axis is at the ear opening. Transmitter devices can be easily and accurately positioned according to IEC 62209-1, IEEE 1528, FCC, or other specifications. The device holder can be locked for positioning at different phantom sections (left head, right head, flat). And upgrade kit to Mounting Device to enable easy mounting of wider devices like big smart-phones, e-books, small tablets, etc. It holds devices with width up to 140 mm.



Mounting Device for Hand-Held Transmitters



Mounting Device Adaptor for Wide-Phones

<Mounting Device for Laptops and other Body-Worn Transmitters>

The extension is lightweight and made of POM, acrylic glass and foam. It fits easily on the upper part of the mounting device in place of the phone positioned. The extension is fully compatible with the SAM Twin and ELI phantoms.



Mounting Device for Laptops

8. Measurement Procedures

The measurement procedures are as follows:

<Conducted power measurement>

- (a) For WWAN power measurement, use base station simulator to configure EUT WWAN transmission in conducted connection with RF cable, at maximum power in each supported wireless interface and frequency band.
- (b) Read the WWAN RF power level from the base station simulator.
- (c) For WLAN/BT power measurement, use engineering software to configure EUT WLAN/BT continuously transmission, at maximum RF power in each supported wireless interface and frequency band
- (d) Connect EUT RF port through RF cable to the power meter, and measure WLAN/BT output power

<SAR measurement>

- (a) Use base station simulator to configure EUT WWAN transmission in radiated connection, and engineering software to configure EUT WLAN/BT continuously transmission, at maximum RF power, in the highest power channel.
- (b) Place the EUT in the positions as Appendix D demonstrates.
- (c) Set scan area, grid size and other setting on the DASY software.
- (d) Measure SAR results for the highest power channel on each testing position.
- (e) Find out the largest SAR result on these testing positions of each band
- (f) Measure SAR results for other channels in worst SAR testing position if the reported SAR of highest power channel is larger than 0.8 W/kg

According to the test standard, the recommended procedure for assessing the peak spatial-average SAR value consists of the following steps:

- (a) Power reference measurement
- (b) Area scan
- (c) Zoom scan
- (d) Power drift measurement

8.1 Spatial Peak SAR Evaluation

The procedure for spatial peak SAR evaluation has been implemented according to the test standard. It can be conducted for 1g and 10g, as well as for user-specific masses. The DASY software includes all numerical procedures necessary to evaluate the spatial peak SAR value.

The base for the evaluation is a "cube" measurement. The measured volume must include the 1g and 10g cubes with the highest averaged SAR values. For that purpose, the center of the measured volume is aligned to the interpolated peak SAR value of a previously performed area scan.

The entire evaluation of the spatial peak values is performed within the post-processing engine (SEMCAD). The system always gives the maximum values for the 1g and 10g cubes. The algorithm to find the cube with highest averaged SAR is divided into the following stages:

- (a) Extraction of the measured data (grid and values) from the Zoom Scan
- (b) Calculation of the SAR value at every measurement point based on all stored data (A/D values and measurement parameters)
- (c) Generation of a high-resolution mesh within the measured volume
- (d) Interpolation of all measured values from the measurement grid to the high-resolution grid
- (e) Extrapolation of the entire 3-D field distribution to the phantom surface over the distance from sensor to surface
- (f) Calculation of the averaged SAR within masses of 1g and 10g

8.2 Power Reference Measurement

The Power Reference Measurement and Power Drift Measurements are for monitoring the power drift of the device under test in the batch process. The minimum distance of probe sensors to surface determines the closest measurement point to phantom surface. This distance cannot be smaller than the distance of sensor calibration points to probe tip as defined in the probe properties.

8.3 Area Scan

The area scan is used as a fast scan in two dimensions to find the area of high field values, before doing a fine measurement around the hot spot. The sophisticated interpolation routines implemented in DASY software can find the maximum found in the scanned area, within a range of the global maximum. The range (in dB0 is specified in the standards for compliance testing. For example, a 2 dB range is required in IEEE standard 1528 and IEC 62209 standards, whereby 3 dB is a requirement when compliance is assessed in accordance with the ARIB standard (Japan), if only one zoom scan follows the area scan, then only the absolute maximum will be taken as reference. For cases where multiple maximums are detected, the number of zoom scans has to be increased accordingly.

Area scan parameters extracted from FCC KDB 865664 D01v01r04 SAR measurement 100 MHz to 6 GHz.

| | ≤ 3 GHz | > 3 GHz |
|--|---|--|
| Maximum distance from closest measurement point (geometric center of probe sensors) to phantom surface | 5 ± 1 mm | $\frac{1}{2} \cdot \delta \cdot \ln(2) \pm 0.5$ mm |
| Maximum probe angle from probe axis to phantom surface normal at the measurement location | 30° ± 1° | 20° ± 1° |
| Maximum area scan spatial resolution: $\Delta x_{Area}, \Delta y_{Area}$ | ≤ 2 GHz: ≤ 15 mm 2 – 3 GHz: ≤ 12 mm | 3 – 4 GHz: ≤ 12 mm 4 – 6 GHz: ≤ 10 mm |
| | When the x or y dimension of the test device, in the measurement plane orientation, is smaller than the above, the measurement resolution must be ≤ the corresponding x or y dimension of the test device with at least one measurement point on the test device. | |

8.4 Zoom Scan

Zoom scans are used assess the peak spatial SAR values within a cubic averaging volume containing 1 gram and 10 gram of simulated tissue. The zoom scan measures points (refer to table below) within a cube shoes base faces are centered on the maxima found in a preceding area scan job within the same procedure. When the measurement is done, the zoom scan evaluates the averaged SAR for 1 gram and 10 gram and displays these values next to the job's label.

Zoom scan parameters extracted from FCC KDB 865664 D01v01r04 SAR measurement 100 MHz to 6 GHz.

| | | ≤ 3 GHz | > 3 GHz | |
|--|------------------------------------|--|---|--|
| Maximum zoom scan spatial resolution: $\Delta x_{Zoom}, \Delta y_{Zoom}$ | | ≤ 2 GHz: ≤ 8 mm 2 – 3 GHz: ≤ 5 mm* | 3 – 4 GHz: ≤ 5 mm* 4 – 6 GHz: ≤ 4 mm* | |
| Maximum zoom scan spatial resolution, normal to phantom surface | uniform grid: $\Delta z_{Zoom}(n)$ | ≤ 5 mm | 3 – 4 GHz: ≤ 4 mm 4 – 5 GHz: ≤ 3 mm 5 – 6 GHz: ≤ 2 mm | |
| | graded grid | $\Delta z_{Zoom}(1)$: between 1 st two points closest to phantom surface | ≤ 4 mm | 3 – 4 GHz: ≤ 3 mm 4 – 5 GHz: ≤ 2.5 mm 5 – 6 GHz: ≤ 2 mm |
| | | $\Delta z_{Zoom}(n>1)$: between subsequent points | $\leq 1.5 \cdot \Delta z_{Zoom}(n-1)$ | |
| Minimum zoom scan volume | x, y, z | ≥ 30 mm | 3 – 4 GHz: ≥ 28 mm 4 – 5 GHz: ≥ 25 mm 5 – 6 GHz: ≥ 22 mm | |
| Note: δ is the penetration depth of a plane-wave at normal incidence to the tissue medium; see draft standard IEEE P1528-2011 for details. * When zoom scan is required and the <i>reported</i> SAR from the <i>area scan based 1-g SAR estimation</i> procedures of KDB 447498 is ≤ 1.4 W/kg, ≤ 8 mm, ≤ 7 mm and ≤ 5 mm zoom scan resolution may be applied, respectively, for 2 GHz to 3 GHz, 3 GHz to 4 GHz and 4 GHz to 6 GHz. | | | | |

8.5 Volume Scan Procedures

The volume scan is used for assess overlapping SAR distributions for antennas transmitting in different frequency bands. It is equivalent to an oversized zoom scan used in standalone measurements. The measurement volume will be used to enclose all the simultaneous transmitting antennas. For antennas transmitting simultaneously in different frequency bands, the volume scan is measured separately in each frequency band. In order to sum correctly to compute the 1g aggregate SAR, the EUT remain in the same test position for all measurements and all volume scan use the same spatial resolution and grid spacing. When all volume scan were completed, the software, SEMCAD postprocessor can combine and subsequently superpose these measurement data to calculating the multiband SAR.

8.6 Power Drift Monitoring

All SAR testing is under the EUT install full charged battery and transmit maximum output power. In DASy measurement software, the power reference measurement and power drift measurement procedures are used for monitoring the power drift of EUT during SAR test. Both these procedures measure the field at a specified reference position before and after the SAR testing. The software will calculate the field difference in dB. If the power drifts more than 5%, the SAR will be retested.



9. Test Equipment List

| Manufacturer | Name of Equipment | Type/Model | Serial Number | Calibration | |
|---------------|---------------------------------|---------------|---------------|-------------|------------|
| | | | | Last Cal. | Due Date |
| SPEAG | 750MHz System Validation Kit | D750V3 | 1065 | 2016/11/21 | 2017/11/20 |
| SPEAG | 835MHz System Validation Kit | D835V2 | 4d151 | 2016/3/16 | 2017/3/15 |
| SPEAG | 1750MHz System Validation Kit | D1750V2 | 1069 | 2016/11/23 | 2017/11/22 |
| SPEAG | 1900MHz System Validation Kit | D1900V2 | 5d118 | 2016/11/24 | 2017/11/23 |
| SPEAG | 2450MHz System Validation Kit | D2450V2 | 840 | 2016/11/25 | 2017/11/24 |
| SPEAG | 2600MHz System Validation Kit | D2600V2 | 1061 | 2016/11/24 | 2017/11/23 |
| SPEAG | 5000MHz System Validation Kit | D5GHZV2 | 1113 | 2016/12/13 | 2017/12/12 |
| SPEAG | Data Acquisition Electronics | DAE4 | 1279 | 2016/4/4 | 2017/4/3 |
| SPEAG | Data Acquisition Electronics | DAE4 | 1210 | 2016/5/18 | 2017/5/17 |
| SPEAG | Dosimetric E-Field Probe | EX3DV4 | 3954 | 2016/11/28 | 2017/11/27 |
| SPEAG | Dosimetric E-Field Probe | EX3DV4 | 3857 | 2016/5/25 | 2017/5/24 |
| SPEAG | SAM Twin Phantom | QD 000 P40 CB | TP-1477 | NCR | NCR |
| SPEAG | SAM Twin Phantom | QD 000 P40 CB | TP-1479 | NCR | NCR |
| SPEAG | SAM Twin Phantom | QD 000 P40 CB | TP-1644 | NCR | NCR |
| SPEAG | SAM Twin Phantom | QD 000 P40 CB | TP-1542 | NCR | NCR |
| SPEAG | Phone Positioner | N/A | N/A | NCR | NCR |
| Anritsu | Radio communication analyzer | MT8820C | 6201563814 | 2016/3/21 | 2017/3/20 |
| Agilent | Wireless Communication Test Set | E5515C | MY52102706 | 2016/4/22 | 2017/4/21 |
| Agilent | ENA Series Network Analyzer | E5071C | MY46111157 | 2016/4/22 | 2017/4/21 |
| SPEAG | DAK Kit | DAK3.5 | 1144 | 2016/11/23 | 2017/11/22 |
| R&S | Signal Generator | SMR40 | 100455 | 2017/1/19 | 2018/1/18 |
| Anritsu | Power Sensor | MA2411B | 1644003 | 2016/12/23 | 2017/12/22 |
| Anritsu | Power Meter | ML2495A | 1531197 | 2016/12/23 | 2017/12/22 |
| Anritsu | Power Sensor | MA2411B | 1644004 | 2016/12/23 | 2017/12/22 |
| Anritsu | Power Meter | ML2495A | 1531198 | 2016/12/23 | 2017/12/22 |
| R&S | CBT BLUETOOTH TESTER | CBT | 101137 | 2016/8/9 | 2017/8/8 |
| R&S | Spectrum Analyzer | FSV7 | 101631 | 2016/8/8 | 2017/8/7 |
| ARRA | Power Divider | A3200-2 | N/A | Note1 | |
| Agilent | Dual Directional Coupler | 778D | 50422 | Note1 | |
| PASTERNAK | Dual Directional Coupler | PE2214-10 | N/A | Note1 | |
| AR | Amplifier | 5S1G4 | 333096 | Note1 | |
| mini-circuits | Amplifier | ZVE-3W-83+ | 162601250 | Note1 | |
| MCL | Attenuation1 | BW-S10W5+ | N/A | Note1 | |
| MCL | Attenuation2 | BW-S10W5+ | N/A | Note1 | |
| MCL | Attenuation3 | BW-S10W5+ | N/A | Note1 | |

General Note:

1. Prior to system verification and validation, the path loss from the signal generator to the system check source and the power meter, which includes the amplifier, cable, attenuator and directional coupler, was measured by the network analyzer. The reading of the power meter was offset by the path loss difference between the path to the power meter and the path to the system check source to monitor the actual power level fed to the system check source.

10. System Verification

10.1 Tissue Simulating Liquids

For the measurement of the field distribution inside the SAM phantom with DASYS, the phantom must be filled with around 25 liters of homogeneous body tissue simulating liquid. For head SAR testing, the liquid height from the ear reference point (ERP) of the phantom to the liquid top surface is larger than 15 cm, which is shown in Fig. 10.1. For body SAR testing, the liquid height from the center of the flat phantom to the liquid top surface is larger than 15 cm, which is shown in Fig. 10.2.

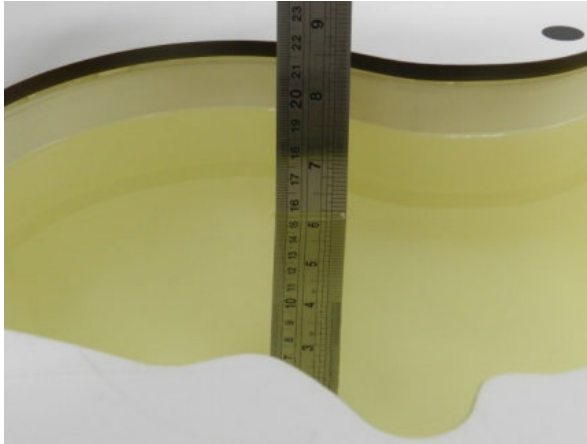

Fig 10.1 Photo of Liquid Height for Head SAR

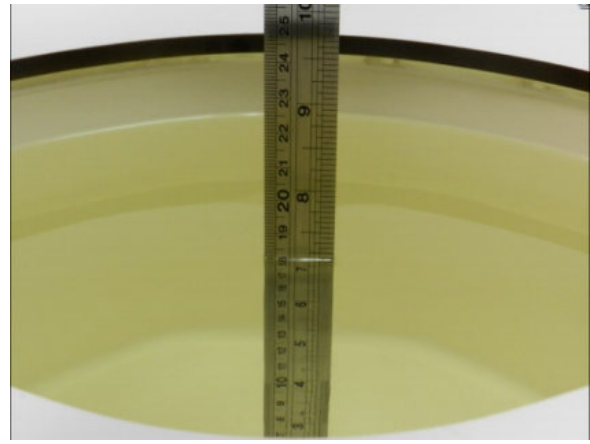

Fig 10.2 Photo of Liquid Height for Body SAR

10.2 Tissue Verification

The following tissue formulations are provided for reference only as some of the parameters have not been thoroughly verified. The composition of ingredients may be modified accordingly to achieve the desired target tissue parameters required for routine SAR evaluation.

| Frequency (MHz) | Water (%) | Sugar (%) | Cellulose (%) | Salt (%) | Preventol (%) | DGBE (%) | Conductivity (σ) | Permittivity (ϵ_r) |
|------------------|-----------|-----------|---------------|----------|---------------|----------|---------------------------|-------------------------------|
| For Head | | | | | | | | |
| 750 | 41.1 | 57.0 | 0.2 | 1.4 | 0.2 | 0 | 0.89 | 41.9 |
| 835 | 40.3 | 57.9 | 0.2 | 1.4 | 0.2 | 0 | 0.90 | 41.5 |
| 1800, 1900, 2000 | 55.2 | 0 | 0 | 0.3 | 0 | 44.5 | 1.40 | 40.0 |
| 2450 | 55.0 | 0 | 0 | 0 | 0 | 45.0 | 1.80 | 39.2 |
| 2600 | 54.8 | 0 | 0 | 0.1 | 0 | 45.1 | 1.96 | 39.0 |
| For Body | | | | | | | | |
| 750 | 51.7 | 47.2 | 0 | 0.9 | 0.1 | 0 | 0.96 | 55.5 |
| 835 | 50.8 | 48.2 | 0 | 0.9 | 0.1 | 0 | 0.97 | 55.2 |
| 1800, 1900, 2000 | 70.2 | 0 | 0 | 0.4 | 0 | 29.4 | 1.52 | 53.3 |
| 2450 | 68.6 | 0 | 0 | 0 | 0 | 31.4 | 1.95 | 52.7 |
| 2600 | 68.1 | 0 | 0 | 0.1 | 0 | 31.8 | 2.16 | 52.5 |

Simulating Liquid for 5GHz, Manufactured by SPEAG

| Ingredients | (% by weight) |
|--------------------|---------------|
| Water | 64~78% |
| Mineral oil | 11~18% |
| Emulsifiers | 9~15% |
| Additives and Salt | 2~3% |

<Tissue Dielectric Parameter Check Results>

| Frequency (MHz) | Tissue Type | Liquid Temp. (°C) | Conductivity (σ) | Permittivity (ϵ_r) | Conductivity Target (σ) | Permittivity Target (ϵ_r) | Delta (σ) (%) | Delta (ϵ_r) (%) | Limit (%) | Date |
|-----------------|-------------|-------------------|---------------------------|-------------------------------|----------------------------------|--------------------------------------|------------------------|----------------------------|-----------|-----------|
| 750 | Head | 22.9 | 0.906 | 42.230 | 0.89 | 41.90 | 1.80 | 0.79 | ±5 | 2017.2.8 |
| 835 | Head | 22.9 | 0.887 | 40.927 | 0.90 | 41.50 | -1.44 | -1.38 | ±5 | 2017.2.8 |
| 1750 | Head | 22.7 | 1.404 | 39.054 | 1.37 | 40.10 | 2.48 | -2.61 | ±5 | 2017.2.9 |
| 1900 | Head | 22.7 | 1.429 | 40.027 | 1.40 | 40.00 | 2.07 | 0.07 | ±5 | 2017.2.9 |
| 2450 | Head | 22.9 | 1.838 | 38.374 | 1.80 | 39.20 | 2.11 | -2.11 | ±5 | 2017.2.6 |
| 2600 | Head | 22.9 | 2.008 | 37.794 | 1.96 | 39.00 | 2.45 | -3.09 | ±5 | 2017.2.6 |
| 5250 | Head | 22.5 | 4.612 | 36.277 | 4.71 | 35.90 | -2.08 | 1.05 | ±5 | 2017.2.4 |
| 5600 | Head | 22.5 | 4.969 | 35.787 | 5.07 | 35.50 | -1.99 | 0.81 | ±5 | 2017.2.4 |
| 5750 | Head | 22.5 | 5.123 | 35.569 | 5.22 | 35.40 | -1.86 | 0.48 | ±5 | 2017.2.4 |
| 750 | Body | 22.8 | 0.963 | 55.234 | 0.96 | 55.50 | 0.31 | -0.48 | ±5 | 2017.1.24 |
| 835 | Body | 22.8 | 0.989 | 56.278 | 0.97 | 55.20 | 1.96 | 1.95 | ±5 | 2017.1.24 |
| 1750 | Body | 22.9 | 1.503 | 53.427 | 1.49 | 53.40 | 0.87 | 0.05 | ±5 | 2017.2.14 |
| 1900 | Body | 22.9 | 1.539 | 53.343 | 1.52 | 53.30 | 1.25 | 0.08 | ±5 | 2017.2.14 |
| 2450 | Body | 22.7 | 2.026 | 52.877 | 1.95 | 52.70 | 3.90 | 0.34 | ±5 | 2017.2.16 |
| 2600 | Body | 22.7 | 2.173 | 52.211 | 2.16 | 52.50 | 0.60 | -0.55 | ±5 | 2017.2.16 |
| 5250 | Body | 22.6 | 5.412 | 48.572 | 5.36 | 48.90 | 0.97 | -0.67 | ±5 | 2017.2.6 |
| 5600 | Body | 22.6 | 5.851 | 47.711 | 5.77 | 48.50 | 1.40 | -1.63 | ±5 | 2017.2.6 |
| 5750 | Body | 22.6 | 6.062 | 47.493 | 5.94 | 48.30 | 2.05 | -1.67 | ±5 | 2017.2.6 |

10.3 System Performance Check Results

Comparing to the original SAR value provided by SPEAG, the verification data should be within its specification of 10 %. Below table shows the target SAR and measured SAR after normalized to 1W input power. The table below indicates the system performance check can meet the variation criterion and the plots can be referred to Appendix A of this report.

| Date | Frequency (MHz) | Tissue Type | Input Power (mW) | Dipole S/N | Probe S/N | DAE S/N | Measured 1g SAR (W/kg) | Targeted 1g SAR (W/kg) | Normalized 1g SAR (W/kg) | Deviation (%) |
|-----------|-----------------|-------------|------------------|------------|-----------|---------|------------------------|------------------------|--------------------------|---------------|
| 2017.2.8 | 750 | Head | 250 | 1065 | 3954 | 1279 | 2.07 | 8.32 | 8.28 | -0.48 |
| 2017.2.8 | 835 | Head | 250 | 4d151 | 3954 | 1279 | 2.22 | 9.26 | 8.88 | -4.10 |
| 2017.2.9 | 1750 | Head | 250 | 1069 | 3857 | 1210 | 9.68 | 37.50 | 38.72 | 3.25 |
| 2017.2.9 | 1900 | Head | 250 | 5d118 | 3857 | 1210 | 9.87 | 40.40 | 39.48 | -2.28 |
| 2017.2.6 | 2450 | Head | 250 | 840 | 3857 | 1210 | 13.30 | 54.00 | 53.2 | -1.48 |
| 2017.2.6 | 2600 | Head | 250 | 1061 | 3857 | 1210 | 13.90 | 56.00 | 55.6 | -0.71 |
| 2017.2.4 | 5250 | Head | 100 | 1113 | 3954 | 1279 | 7.88 | 76.40 | 78.8 | 3.14 |
| 2017.2.4 | 5600 | Head | 100 | 1113 | 3954 | 1279 | 8.26 | 80.80 | 82.6 | 2.23 |
| 2017.2.4 | 5750 | Head | 100 | 1113 | 3954 | 1279 | 7.66 | 80.30 | 76.6 | -4.61 |
| 2017.1.24 | 750 | Body | 250 | 1065 | 3954 | 1279 | 2.22 | 8.71 | 8.88 | 1.95 |
| 2017.1.24 | 835 | Body | 250 | 4d151 | 3954 | 1279 | 2.54 | 9.52 | 10.16 | 6.72 |
| 2017.2.14 | 1750 | Body | 250 | 1069 | 3857 | 1210 | 9.61 | 37.70 | 38.44 | 1.96 |
| 2017.2.14 | 1900 | Body | 250 | 5d118 | 3857 | 1210 | 9.85 | 40.80 | 39.4 | -3.43 |
| 2017.2.16 | 2450 | Body | 250 | 840 | 3857 | 1210 | 13.30 | 50.90 | 53.2 | 4.52 |
| 2017.2.16 | 2600 | Body | 250 | 1061 | 3857 | 1210 | 13.60 | 55.40 | 54.4 | -1.81 |
| 2017.2.6 | 5250 | Body | 100 | 1113 | 3954 | 1279 | 7.58 | 76.10 | 75.8 | -0.39 |
| 2017.2.6 | 5600 | Body | 100 | 1113 | 3954 | 1279 | 7.88 | 79.80 | 78.8 | -1.25 |
| 2017.2.6 | 5750 | Body | 100 | 1113 | 3954 | 1279 | 7.12 | 75.20 | 71.2 | -5.32 |

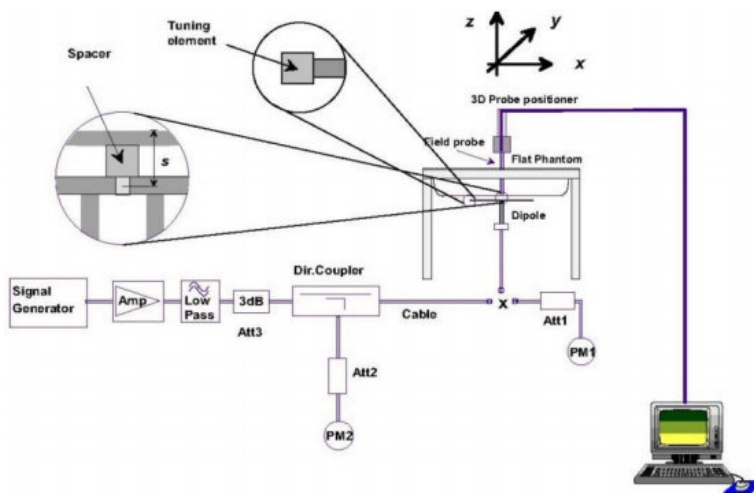

Fig 8.3.1 System Performance Check Setup



Fig 8.3.2 Setup Photo

11. RF Exposure Positions

11.1 Ear and handset reference point

Figure 9.1.1 shows the front, back, and side views of the SAM phantom. The center-of-mouth reference point is labeled “M,” the left ear reference point (ERP) is marked “LE,” and the right ERP is marked “RE.” Each ERP is 15 mm along the B-M (back-mouth) line behind the entrance-to-ear-canal (EEC) point, as shown in Figure 9.1.2 The Reference Plane is defined as passing through the two ear reference points and point M. The line N-F (neck-front), also called the reference pivoting line, is normal to the Reference Plane and perpendicular to both a line passing through RE and LE and the B-M line (see Figure 9.1.3). Both N-F and B-M lines should be marked on the exterior of the phantom shell to facilitate handset positioning. Posterior to the N-F line the ear shape is a flat surface with 6 mm thickness at each ERP, and forward of the N-F line the ear is truncated, as illustrated in Figure 9.1.2. The ear truncation is introduced to preclude the ear lobe from interfering with handset tilt, which could lead to unstable positioning at the cheek.

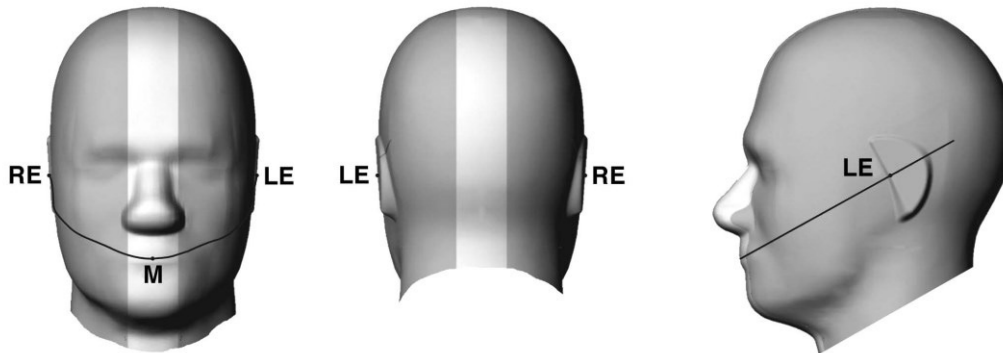

Fig 9.1.1 Front, back, and side views of SAM twin phantom

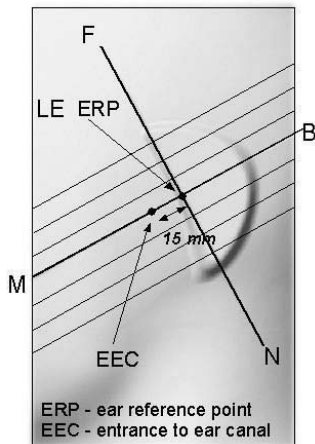

Fig 9.1.2 Close-up side view of phantom showing the ear region.

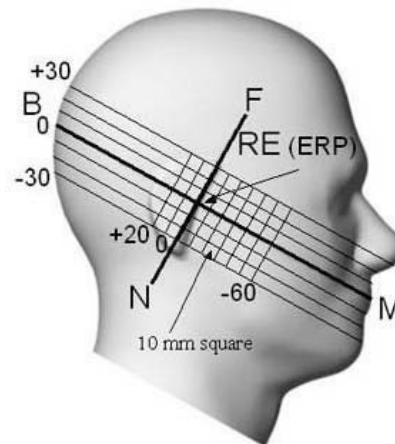

Fig 9.1.3 Side view of the phantom showing relevant markings and seven cross-sectional plane locations

11.2 Definition of the cheek position

1. Ready the handset for talk operation, if necessary. For example, for handsets with a cover piece (flip cover), open the cover. If the handset can transmit with the cover closed, both configurations must be tested.
2. Define two imaginary lines on the handset—the vertical centerline and the horizontal line. The vertical centerline passes through two points on the front side of the handset—the midpoint of the width w_t of the handset at the level of the acoustic output (point A in Figure 9.2.1 and Figure 9.2.2), and the midpoint of the width w_b of the bottom of the handset (point B). The horizontal line is perpendicular to the vertical centerline and passes through the center of the acoustic output (see Figure 9.2.1). The two lines intersect at point A. Note that for many handsets, point A coincides with the center of the acoustic output; however, the acoustic output may be located elsewhere on the horizontal line. Also note that the vertical centerline is not necessarily parallel to the front face of the handset (see Figure 9.2.2), especially for clamshell handsets, handsets with flip covers, and other irregularly-shaped handsets.
3. Position the handset close to the surface of the phantom such that point A is on the (virtual) extension of the line passing through points RE and LE on the phantom (see Figure 9.2.3), such that the plane defined by the vertical centerline and the horizontal line of the handset is approximately parallel to the sagittal plane of the phantom.
4. Translate the handset towards the phantom along the line passing through RE and LE until handset point A touches the pinna at the ERP.
5. While maintaining the handset in this plane, rotate it around the LE-RE line until the vertical centerline is in the plane normal to the plane containing B-M and N-F lines, i.e., the Reference Plane.
6. Rotate the handset around the vertical centerline until the handset (horizontal line) is parallel to the N-F line.
7. While maintaining the vertical centerline in the Reference Plane, keeping point A on the line passing through RE and LE, and maintaining the handset contact with the pinna, rotate the handset about the N-F line until any point on the handset is in contact with a phantom point below the pinna on the cheek. See Figure 9.2.3. The actual rotation angles should be documented in the test report.

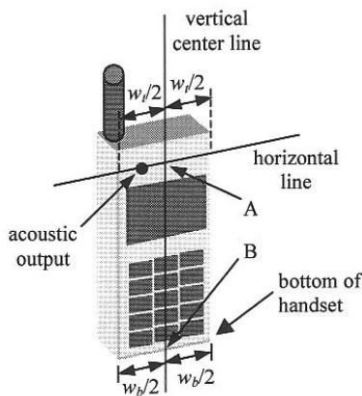

Fig 9.2.1 Handset vertical and horizontal reference lines—"fixed case"

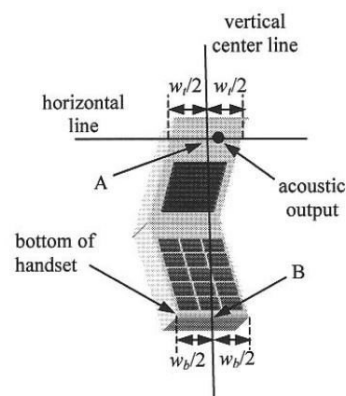

Fig 9.2.2 Handset vertical and horizontal reference lines—"clam-shell case"

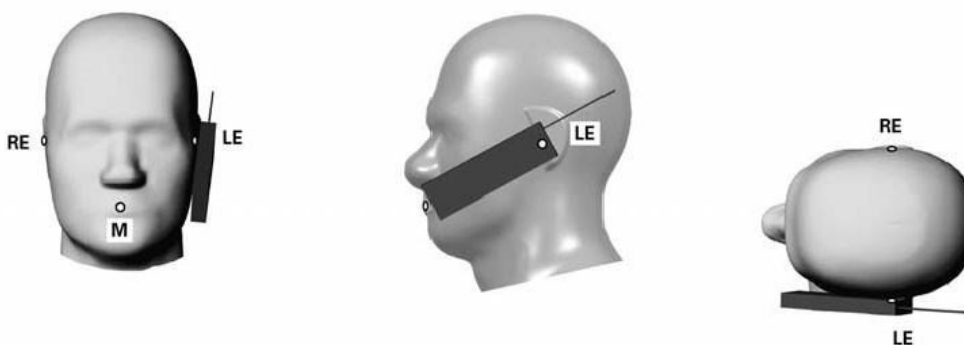

Fig 9.2.3 cheek or touch position. The reference points for the right ear (RE), left ear (LE), and mouth (M), which establish the Reference Plane for handset positioning, are indicated.

11.3 Definition of the tilt position

1. Ready the handset for talk operation, if necessary. For example, for handsets with a cover piece (flip cover), open the cover. If the handset can transmit with the cover closed, both configurations must be tested.
2. While maintaining the orientation of the handset, move the handset away from the pinna along the line passing through RE and LE far enough to allow a rotation of the handset away from the cheek by 15°.
3. Rotate the handset around the horizontal line by 15°.
4. While maintaining the orientation of the handset, move the handset towards the phantom on the line passing through RE and LE until any part of the handset touches the ear. The tilt position is obtained when the contact point is on the pinna. See Figure 9.3.1. If contact occurs at any location other than the pinna, e.g., the antenna at the back of the phantom head, the angle of the handset should be reduced. In this case, the tilt position is obtained if any point on the handset is in contact with the pinna and a second point

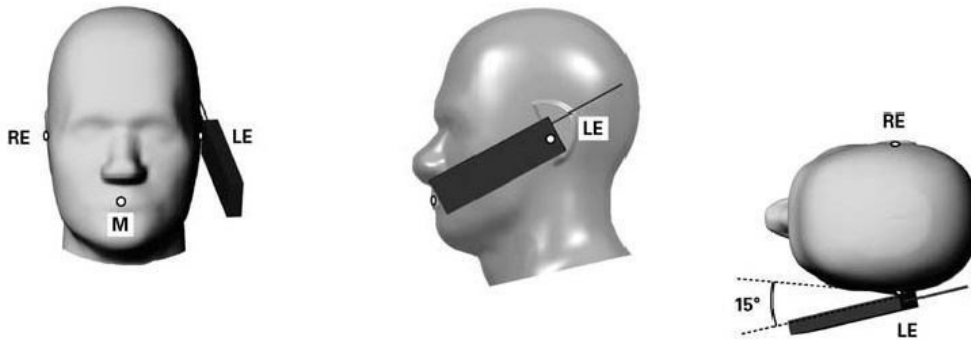

Fig 9.3.1 Tilt position. The reference points for the right ear (RE), left ear (LE), and mouth (M), which define the Reference Plane for handset positioning, are indicated.

11.4 Body Worn Accessory

Body-worn operating configurations are tested with the belt-clips and holsters attached to the device and positioned against a flat phantom in a normal use configuration (see Figure 9.4). Per KDB648474 D04v01r03, body-worn accessory exposure is typically related to voice mode operations when handsets are carried in body-worn accessories. The body-worn accessory procedures in FCC KDB 447498 D01v06 should be used to test for body-worn accessory SAR compliance, without a headset connected to it. This enables the test results for such configuration to be compatible with that required for hotspot mode when the body-worn accessory test separation distance is greater than or equal to that required for hotspot mode, when applicable. When the reported SAR for body-worn accessory, measured without a headset connected to the handset is $< 1.2 \text{ W/kg}$, the highest reported SAR configuration for that wireless mode and frequency band should be repeated for that body-worn accessory with a headset attached to the handset.

Accessories for body-worn operation configurations are divided into two categories: those that do not contain metallic components and those that do contain metallic components. When multiple accessories that do not contain metallic components are supplied with the device, the device is tested with only the accessory that dictates the closest spacing to the body. Then multiple accessories that contain metallic components are tested with the device with each accessory. If multiple accessories share an identical metallic component (i.e. the same metallic belt-clip used with different holsters with no other metallic components) only the accessory that dictates the closest spacing to the body is tested.

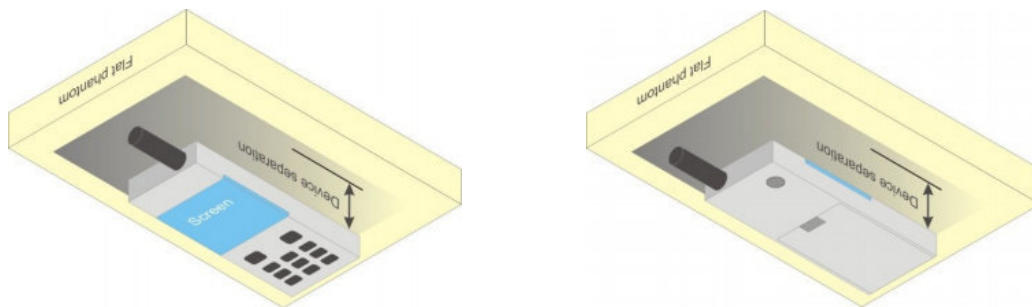

Fig 9.4 Body Worn Position

11.5 Wireless Router

Some battery-operated handsets have the capability to transmit and receive user through simultaneous transmission of WIFI simultaneously with a separate licensed transmitter. The FCC has provided guidance in FCC KDB Publication 941225 D06 v02r01 where SAR test considerations for handsets ($L \times W \geq 9 \text{ cm} \times 5 \text{ cm}$) are based on a composite test separation distance of 10mm from the front, back and edges of the device containing transmitting antennas within 2.5cm of their edges, determined from general mixed use conditions for this type of devices. Since the hotspot SAR results may overlap with the body-worn accessory SAR requirements, the more conservative configurations can be considered, thus excluding some body-worn accessory SAR tests.

When the user enables the personal wireless router functions for the handset, actual operations include simultaneous transmission of both the WIFI transmitter and another licensed transmitter. Both transmitters often do not transmit at the same transmitting frequency and thus cannot be evaluated for SAR under actual use conditions due to the limitations of the SAR assessment probes. Therefore, SAR must be evaluated for each frequency transmission and mode separately and spatially summed with the WIFI transmitter according to FCC KDB Publication 447498 D01v06 publication procedures. The "Portable Hotspot" feature on the handset was NOT activated during SAR assessments, to ensure the SAR measurements were evaluated for a single transmission frequency RF signal at a time.

12. Conducted RF Output Power (Unit: dBm)

<GSM Conducted Power>

1. Per KDB 447498 D01v06, the maximum output power channel is used for SAR testing and for further SAR test reduction.
2. Per KDB 941225 D01v03r01, for SAR test reduction for GSM / GPRS / EDGE modes is determined by the source-based time-averaged output power including tune-up tolerance. The mode with highest specified time-averaged output power should be tested for SAR compliance in the applicable exposure conditions. For modes with the same specified maximum output power and tolerance, the higher number time-slot configuration should be tested. Therefore, the GPRS (4Tx slots) for GSM850/GSM1900 is considered as the primary mode.
3. Other configurations of GSM / GPRS / EDGE are considered as secondary modes. The 3G SAR test reduction procedure is applied, when the maximum output power and tune-up tolerance specified for production units in a secondary mode is $\leq \frac{1}{4}$ dB higher than the primary mode, SAR measurement is not required for the secondary mode.
4. Power reduction which is triggered by hotspot mode is implemented in GSM1900 band, for hotspot mode SAR testing EUT was set in reduced power mode and GPRS (3Tx slots) due to its highest frame-average power.

<Full Power Mode>

| GSM850 TX Channel | Burst Average Power (dBm) | | | Tune-up Limit (dBm) | Frame-Average Power (dBm) | | | Tune-up Limit (dBm) |
|----------------------|---------------------------|--------------|-------|---------------------------|---------------------------|--------------|-------|---------------------------|
| | 128 | 189 | 251 | | 128 | 189 | 251 | |
| Frequency (MHz) | 824.2 | 836.4 | 848.8 | | 824.2 | 836.4 | 848.8 | |
| GSM 1 Tx slot | 33.20 | 33.27 | 33.26 | 33.50 | 24.20 | 24.27 | 24.26 | 24.50 |
| GPRS 1 Tx slot | 33.18 | 33.25 | 33.24 | 33.50 | 24.18 | 24.25 | 24.24 | 24.50 |
| GPRS 2 Tx slots | 32.41 | 32.54 | 32.54 | 33.00 | 26.41 | 26.54 | 26.54 | 27.00 |
| GPRS 3 Tx slots | 30.56 | 30.68 | 30.69 | 31.00 | 26.30 | 26.42 | 26.43 | 26.74 |
| GPRS 4 Tx slots | 29.42 | 29.59 | 29.58 | 30.00 | 26.42 | 26.59 | 26.58 | 27.00 |
| EDGE 1 Tx slot | 27.21 | 27.26 | 27.19 | 28.00 | 18.21 | 18.26 | 18.19 | 19.00 |
| EDGE 2 Tx slots | 26.28 | 26.33 | 26.28 | 27.00 | 20.28 | 20.33 | 20.28 | 21.00 |
| EDGE 3 Tx slots | 24.36 | 24.43 | 24.39 | 25.00 | 20.10 | 20.17 | 20.13 | 20.74 |
| EDGE 4 Tx slots | 23.32 | 23.29 | 23.21 | 24.00 | 20.32 | 20.29 | 20.21 | 21.00 |

Remark: The frame-averaged power is linearly scaled the maximum burst averaged power over 8 time slots.

The calculated method are shown as below:

Frame-averaged power = Maximum burst averaged power (1 Tx Slot) - 9 dB
 Frame-averaged power = Maximum burst averaged power (2 Tx Slots) - 6 dB
 Frame-averaged power = Maximum burst averaged power (3 Tx Slots) - 4.26 dB
 Frame-averaged power = Maximum burst averaged power (4 Tx Slots) - 3 dB

| GSM1900 TX Channel | Burst Average Power (dBm) | | | Tune-up Limit (dBm) | Frame-Average Power (dBm) | | | Tune-up Limit (dBm) |
|-----------------------|---------------------------|-------|--------------|---------------------------|---------------------------|-------|--------------|---------------------------|
| | 512 | 661 | 810 | | 512 | 661 | 810 | |
| Frequency (MHz) | 1850.2 | 1880 | 1909.8 | | 1850.2 | 1880 | 1909.8 | |
| GSM 1 Tx slot | 29.74 | 29.88 | 29.95 | 31.00 | 20.74 | 20.88 | 20.95 | 22.00 |
| GPRS 1 Tx slot | 29.73 | 29.85 | 29.94 | 31.00 | 20.73 | 20.85 | 20.94 | 22.00 |
| GPRS 2 Tx slots | 29.55 | 29.72 | 29.86 | 30.00 | 23.55 | 23.72 | 23.86 | 24.00 |
| GPRS 3 Tx slots | 27.63 | 27.83 | 28.08 | 28.50 | 23.37 | 23.57 | 23.82 | 24.24 |
| GPRS 4 Tx slots | 26.46 | 26.72 | 27.01 | 27.50 | 23.46 | 23.72 | 24.01 | 24.50 |
| EDGE 1 Tx slot | 26.54 | 26.64 | 26.71 | 27.00 | 17.54 | 17.64 | 17.71 | 18.00 |
| EDGE 2 Tx slots | 25.57 | 25.64 | 25.69 | 26.00 | 19.57 | 19.64 | 19.69 | 20.00 |
| EDGE 3 Tx slots | 23.55 | 23.62 | 23.65 | 24.00 | 19.29 | 19.36 | 19.39 | 19.74 |
| EDGE 4 Tx slots | 22.43 | 22.51 | 22.54 | 23.00 | 19.43 | 19.51 | 19.54 | 20.00 |

Remark: The frame-averaged power is linearly scaled the maximum burst averaged power over 8 time slots.

The calculated method are shown as below:

Frame-averaged power = Maximum burst averaged power (1 Tx Slot) - 9 dB
 Frame-averaged power = Maximum burst averaged power (2 Tx Slots) - 6 dB
 Frame-averaged power = Maximum burst averaged power (3 Tx Slots) - 4.26 dB
 Frame-averaged power = Maximum burst averaged power (4 Tx Slots) - 3 dB



<Reduced Power Mode>

| GSM1900 TX Channel | Burst Average Power (dBm) | | | Tune-up Limit (dBm) | Frame-Average Power (dBm) | | | Tune-up Limit (dBm) |
|-----------------------|---------------------------|-------|--------|---------------------------|---------------------------|-------|--------|---------------------------|
| | 512 | 661 | 810 | | 512 | 661 | 810 | |
| Frequency (MHz) | 1850.2 | 1880 | 1909.8 | | 1850.2 | 1880 | 1909.8 | |
| GSM 1 Tx slot | 29.74 | 29.88 | 29.95 | 31.00 | 21.37 | 21.49 | 21.56 | 22.00 |
| GPRS 1 Tx slot | 29.73 | 29.85 | 29.94 | 31.00 | 21.35 | 21.48 | 21.55 | 22.00 |
| GPRS 2 Tx slots | 27.83 | 27.99 | 28.27 | 28.50 | 21.83 | 21.99 | 22.27 | 22.50 |
| GPRS 3 Tx slots | 26.10 | 26.17 | 26.52 | 27.00 | 21.84 | 21.91 | 22.26 | 22.74 |
| GPRS 4 Tx slots | 24.62 | 24.84 | 25.16 | 25.50 | 21.62 | 21.84 | 22.16 | 22.50 |
| EDGE 1 Tx slot | 26.79 | 26.88 | 26.88 | 27.00 | 17.79 | 17.88 | 17.88 | 18.00 |
| EDGE 2 Tx slots | 23.95 | 24.00 | 24.04 | 24.50 | 17.95 | 18.00 | 18.04 | 18.50 |
| EDGE 3 Tx slots | 22.12 | 22.17 | 22.16 | 22.50 | 17.86 | 17.91 | 17.90 | 18.00 |
| EDGE 4 Tx slots | 17.70 | 17.71 | 17.60 | 18.00 | 14.70 | 14.71 | 14.60 | 15.00 |

Remark: The frame-averaged power is linearly scaled the maximum burst averaged power over 8 time slots.
 The calculated method are shown as below:
 Frame-averaged power = Maximum burst averaged power (1 Tx Slot) - 9 dB
 Frame-averaged power = Maximum burst averaged power (2 Tx Slots) - 6 dB
 Frame-averaged power = Maximum burst averaged power (3 Tx Slots) - 4.26 dB
 Frame-averaged power = Maximum burst averaged power (4 Tx Slots) - 3 dB

<WCDMA Conducted Power>

1. The following tests were conducted according to the test requirements outlines in 3GPP TS 34.121 specification.
2. The procedures in KDB 941225 D01v03r01 are applied for 3GPP Rel. 6 HSPA to configure the device in the required sub-test mode(s) to determine SAR test exclusion.
3. For HSPA+ devices supporting 16 QAM in the uplink, power measurements procedure is according to the configurations in Table C.11.1.4 of 3GPP TS 34.121-1.
4. For DC-HSDPA, the device was configured according to the H-Set 12, Fixed Reference Channel (FRC) configuration in Table C.8.1.12 of 3GPP TS 34.121-1, with the primary and the secondary serving HS-DSCH Cell enabled during the power measurement.

A summary of these settings are illustrated below:

HSDPA Setup Configuration:

- a. The EUT was connected to Base Station Agilent E5515C referred to the Setup Configuration.
- b. The RF path losses were compensated into the measurements.
- c. A call was established between EUT and Base Station with following setting:
 - i. Set Gain Factors (β_c and β_d) and parameters were set according to each
 - ii. Specific sub-test in the following table, C10.1.4, quoted from the TS 34.121
 - iii. Set RMC 12.2Kbps + HSDPA mode.
 - iv. Set Cell Power = -86 dBm
 - v. Set HS-DSCH Configuration Type to FRC (H-set 1, QPSK)
 - vi. Select HSDPA Uplink Parameters
 - vii. Set Delta ACK, Delta NACK and Delta CQI = 8
 - viii. Set Ack-Nack Repetition Factor to 3
 - ix. Set CQI Feedback Cycle (k) to 4 ms
 - x. Set CQI Repetition Factor to 2
 - xi. Power Ctrl Mode = All Up bits
- d. The transmitted maximum output power was recorded.

Table C.10.1.4: β values for transmitter characteristics tests with HS-DPCCH

| Sub-test | β_c | β_d | β_d (SF) | β_c/β_d | β_{HS} (Note 1, Note 2) | CM (dB) (Note 3) | MPR (dB) (Note 3) |
|----------|-------------------|-------------------|-------------------|-------------------|-------------------------------------|---------------------|----------------------|
| 1 | 2/15 | 15/15 | 64 | 2/15 | 4/15 | 0.0 | 0.0 |
| 2 | 12/15 (Note 4) | 15/15 (Note 4) | 64 | 12/15 (Note 4) | 24/15 | 1.0 | 0.0 |
| 3 | 15/15 | 8/15 | 64 | 15/8 | 30/15 | 1.5 | 0.5 |
| 4 | 15/15 | 4/15 | 64 | 15/4 | 30/15 | 1.5 | 0.5 |

Note 1: $\Delta_{ACK}, \Delta_{NACK}$ and $\Delta_{CQI} = 30/15$ with $\beta_{HS} = 30/15 * \beta_c$.

Note 2: For the HS-DPCCH power mask requirement test in clause 5.2C, 5.7A, and the Error Vector Magnitude (EVM) with HS-DPCCH test in clause 5.13.1A, and HSDPA EVM with phase discontinuity in clause 5.13.1AA, Δ_{ACK} and $\Delta_{NACK} = 30/15$ with $\beta_{HS} = 30/15 * \beta_c$, and $\Delta_{CQI} = 24/15$ with $\beta_{HS} = 24/15 * \beta_c$.

Note 3: CM = 1 for $\beta_c/\beta_d = 12/15, \beta_{HS}/\beta_c = 24/15$. For all other combinations of DPDCCH, DPCCH and HS-DPCCH the MPR is based on the relative CM difference. This is applicable for only UEs that support HSDPA in release 6 and later releases.

Note 4: For subtest 2 the β_c/β_d ratio of 12/15 for the TFC during the measurement period (TF1, TF0) is achieved by setting the signalled gain factors for the reference TFC (TF1, TF1) to $\beta_c = 11/15$ and $\beta_d = 15/15$.

Setup Configuration

HSUPA Setup Configuration:

- a. The EUT was connected to Base Station Agilent E5515C referred to the Setup Configuration.
- b. The RF path losses were compensated into the measurements.
- c. A call was established between EUT and Base Station with following setting * :
 - i. Call Configs = 5.2B, 5.9B, 5.10B, and 5.13.2B with QPSK
 - ii. Set the Gain Factors (β_c and β_d) and parameters (AG Index) were set according to each specific sub-test in the following table, C11.1.3, quoted from the TS 34.121
 - iii. Set Cell Power = -86 dBm
 - iv. Set Channel Type = 12.2k + HSPA
 - v. Set UE Target Power
 - vi. Power Ctrl Mode= Alternating bits
 - vii. Set and observe the E-TFCl
 - viii. Confirm that E-TFCl is equal to the target E-TFCl of 75 for sub-test 1, and other subtest's E-TFCl
- d. The transmitted maximum output power was recorded.

Table C.11.1.3: β values for transmitter characteristics tests with HS-DPCCH and E-DCH

| Sub-test | β_c | β_d | β_d (SF) | β_c/β_d | β_{HS} (Note 1) | β_{ec} | β_{ed} (Note 5) (Note 6) | β_{ed} (SF) | β_{ed} (Codes) | CM (dB) (Note 2) | MPR (dB) (Note 2) | AG Index (Note 6) | E-TFCl |
|----------|----------------|----------------|----------------|-------------------|-----------------------|--------------|--|-------------------|----------------------|------------------|-------------------|-------------------|--------|
| 1 | 11/15 (Note 3) | 15/15 (Note 3) | 64 | 11/15 (Note 3) | 22/15 | 209/25 | 1309/225 | 4 | 1 | 1.0 | 0.0 | 20 | 75 |
| 2 | 6/15 | 15/15 | 64 | 6/15 | 12/15 | 12/15 | 94/75 | 4 | 1 | 3.0 | 2.0 | 12 | 67 |
| 3 | 15/15 | 9/15 | 64 | 15/9 | 30/15 | 30/15 | $\beta_{ed1}: 47/15$ $\beta_{ed2}: 47/15$ | 4 4 | 2 | 2.0 | 1.0 | 15 | 92 |
| 4 | 2/15 | 15/15 | 64 | 2/15 | 4/15 | 2/15 | 56/75 | 4 | 1 | 3.0 | 2.0 | 17 | 71 |
| 5 | 15/15 (Note 4) | 15/15 (Note 4) | 64 | 15/15 (Note 4) | 30/15 | 24/15 | 134/15 | 4 | 1 | 1.0 | 0.0 | 21 | 81 |

Note 1: $\Delta_{ACK}, \Delta_{NACK}$ and $\Delta_{CQI} = 30/15$ with $\beta_{hs} = 30/15 * \beta_c$.

Note 2: CM = 1 for $\beta_c/\beta_d = 12/15, \beta_{hs}/\beta_c = 24/15$. For all other combinations of DPDCH, DPCCH, HS-DPCCH, E-DPDCH and E-DPCCH the MPR is based on the relative CM difference.

Note 3: For subtest 1 the β_c/β_d ratio of 11/15 for the TFC during the measurement period (TF1, TF0) is achieved by setting the signalled gain factors for the reference TFC (TF1, TF1) to $\beta_c = 10/15$ and $\beta_d = 15/15$.

Note 4: For subtest 5 the β_c/β_d ratio of 15/15 for the TFC during the measurement period (TF1, TF0) is achieved by setting the signalled gain factors for the reference TFC (TF1, TF1) to $\beta_c = 14/15$ and $\beta_d = 15/15$.

Note 5: In case of testing by UE using E-DPDCH Physical Layer category 1, Sub-test 3 is omitted according to TS25.306 Table 5.1g.

Note 6: β_{ed} can not be set directly, it is set by Absolute Grant Value.

Setup Configuration

DC-HSDPA 3GPP release 8 Setup Configuration:

- a. The EUT was connected to Base Station Agilent E5515C referred to the Setup Configuration below
- b. The RF path losses were compensated into the measurements.
- c. A call was established between EUT and Base Station with following setting:
 - i. Set RMC 12.2Kbps + HSDPA mode.
 - ii. Set Cell Power = -25 dBm
 - iii. Set HS-DSCH Configuration Type to FRC (H-set 12, QPSK)
 - iv. Select HSDPA Uplink Parameters
 - v. Set Gain Factors (β_c and β_d) and parameters were set according to each Specific sub-test in the following table, C10.1.4, quoted from the TS 34.121
 - a). Subtest 1: $\beta_c/\beta_d=2/15$
 - b). Subtest 2: $\beta_c/\beta_d=12/15$
 - c). Subtest 3: $\beta_c/\beta_d=15/8$
 - d). Subtest 4: $\beta_c/\beta_d=15/4$
 - vi. Set Delta ACK, Delta NACK and Delta CQI = 8
 - vii. Set Ack-Nack Repetition Factor to 3
 - viii. Set CQI Feedback Cycle (k) to 4 ms
 - ix. Set CQI Repetition Factor to 2
 - x. Power Ctrl Mode = All Up bits
- d. The transmitted maximum output power was recorded.

The following tests were conducted according to the test requirements outlines in 3GPP TS 34.121 specification. A summary of these settings are illustrated below:

C.8.1.12 Fixed Reference Channel Definition H-Set 12

Table C.8.1.12: Fixed Reference Channel H-Set 12

| Parameter | Unit | Value |
|--|-----------|-------|
| Nominal Avg. Inf. Bit Rate | kbps | 60 |
| Inter-TTI Distance | TTI's | 1 |
| Number of HARQ Processes | Processes | 6 |
| Information Bit Payload (N_{INF}) | Bits | 120 |
| Number Code Blocks | Blocks | 1 |
| Binary Channel Bits Per TTI | Bits | 960 |
| Total Available SML's in UE | SML's | 19200 |
| Number of SML's per HARQ Proc. | SML's | 3200 |
| Coding Rate | | 0.15 |
| Number of Physical Channel Codes | Codes | 1 |
| Modulation | | QPSK |
| Note 1: The RMC is intended to be used for DC-HSDPA mode and both cells shall transmit with identical parameters as listed in the table. Note 2: Maximum number of transmission is limited to 1, i.e., retransmission is not allowed. The redundancy and constellation version 0 shall be used. | | |

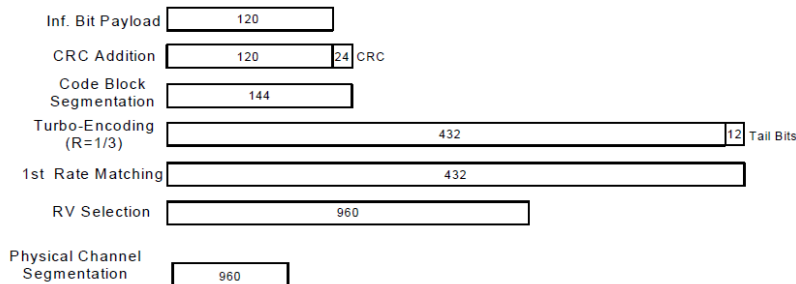

Figure C.8.19: Coding rate for Fixed reference Channel H-Set 12 (QPSK)

Setup Configuration

HSPA+ 3GPP release 7 (uplink category 7) 16QAM, Setup Configuration:

- a. The EUT was connected to Base Station Agilent E5515C referred to the Setup Configuration.
- b. The RF path losses were compensated into the measurements.
- c. A call was established between EUT and Base Station with following setting * :
 - i. Call Configs = 5.2E:HSPA+:UL with 16QAM
 - ii. Set the Gain Factors (β_c and β_d) and parameters (AG Index) were set according to each specific sub-test in the following table, C11.1.4, quoted from the TS 34.121-1 s5.2E
 - iii. Set Channel Parm
 - iv. Set Cell Power = -86 dBm
 - v. Set Channel Type = HSPA
 - vi. Set UE Target Power =21 dBm
 - vii. Power Ctrl Mode= All Up Bits
 - viii. Set Manual Uplink DPCH Bc/Bd = Manual
 - ix. Set Manual Uplink DPCH Bc and Bd=15,15(for 34.121-1 v8.10.0 table C11.1.4 sub-test 1)
 - x. Set HSPA Conn DL Channel Levels
 - xi. Set HS-SCCH Configs
 - xii. Set RB Test Mode Setup
 - xiii. Set Common HSUPA Parameters
 - xiv. Set Serving Grant
 - xv. Confirm that E-TFCI is equal to the target E-TFCI of 105 for sub-test 1, and other subtest's E-TFCI
- d. The transmitted maximum output power was recorded.

Table C.11.1.4: β values for transmitter characteristics tests with HS-DPCCH and E-DCH with 16QAM

| Sub-test | β_c (Note 3) | β_d | β_{HS} (Note 1) | β_{ec} | β_{ed} (2xSF2) (Note 4) | β_{ed} (2xSF4) (Note 4) | CM (dB) (Note 2) | MPR (dB) (Note 2) | AG Index (Note 4) | E-TFCI (Note 5) | E-TFCI (boost) |
|----------|-----------------------|-----------|--------------------------|--------------|--|--|------------------------|-------------------------|-------------------------|--------------------|-------------------|
| 1 | 1 | 0 | 30/15 | 30/15 | β_{ed1} : 30/15 β_{ed2} : 30/15 | β_{ed3} : 24/15 β_{ed4} : 24/15 | 3.5 | 2.5 | 14 | 105 | 105 |

Note 1: $\Delta_{ACK}, \Delta_{NACK}$ and $\Delta_{CQI} = 30/15$ with $\beta_{HS} = 30/15 * \beta_c$.

Note 2: CM = 3.5 and the MPR is based on the relative CM difference, MPR = MAX(CM-1,0).

Note 3: DPDCH is not configured, therefore the β_c is set to 1 and $\beta_d = 0$ by default.

Note 4: β_{ed} can not be set directly; it is set by Absolute Grant Value.

Note 5: All the sub-tests require the UE to transmit 2SF2+2SF4 16QAM EDCH and they apply for UE using E-DPDCH category 7. E-DCH TTI is set to 2ms TTI and E-DCH table index = 2. To support these E-DCH configurations DPDCH is not allocated. The UE is signaled to use the extrapolation algorithm.

Setup Configuration



<WCDMA Conducted Power>

General Note:

- Per KDB 941225 D01v03r01, for SAR testing is measured using a 12.2 kbps RMC with TPC bits configured to all "1's".
- Per KDB 941225 D01v03r01, RMC 12.2kbps setting is used to evaluate SAR. If the maximum output power and tune-up tolerance specified for production units in HSDPA / HSUPA / DC-HSDPA / HSPA+ is $\leq \frac{1}{4}$ dB higher than RMC 12.2Kbps or when the highest reported SAR of the RMC12.2Kbps is scaled by the ratio of specified maximum output power and tune-up tolerance of HSDPA / HSUPA / DC-HSDPA / HSPA+ to RMC12.2Kbps and the adjusted SAR is ≤ 1.2 W/kg, SAR measurement is not required for HSDPA / HSUPA / DC-HSDPA / HSPA+.

<Full Power Mode>

| Band | | WCDMA Band II | | | Tune-up Limit (dBm) | WCDMA Band IV | | | Tune-up Limit (dBm) | WCDMA Band V | | | Tune-up Limit (dBm) |
|-----------------|-------------------------|---------------|-------|--------|---------------------|---------------|--------|--------|---------------------|--------------|-------|-------|---------------------|
| Tx Channel | | 9262 | 9400 | 9538 | | 1312 | 1413 | 1513 | | 4132 | 4182 | 4233 | |
| Rx Channel | | 9662 | 9800 | 9938 | | 1537 | 1638 | 1738 | | 4357 | 4407 | 4458 | |
| Frequency (MHz) | | 1852.4 | 1880 | 1907.6 | | 1712.4 | 1732.6 | 1752.6 | | 826.4 | 836.4 | 846.6 | |
| 3GPP Rel 99 | AMR 12.2Kbps | 24.36 | 24.25 | 24.41 | 25.00 | 23.82 | 23.80 | 23.81 | 24.50 | 24.09 | 24.05 | 24.16 | 24.50 |
| 3GPP Rel 99 | RMC 12.2Kbps | 24.38 | 24.27 | 24.43 | 25.00 | 23.84 | 23.80 | 23.83 | 24.50 | 24.11 | 24.07 | 24.18 | 24.50 |
| 3GPP Rel 6 | HSDPA Subtest-1 | 23.42 | 23.43 | 23.51 | 24.00 | 22.96 | 22.90 | 22.80 | 23.50 | 23.12 | 23.02 | 23.14 | 23.50 |
| 3GPP Rel 6 | HSDPA Subtest-2 | 23.43 | 23.45 | 23.54 | 24.00 | 22.96 | 22.86 | 22.85 | 23.50 | 23.07 | 23.07 | 23.19 | 23.50 |
| 3GPP Rel 6 | HSDPA Subtest-3 | 22.95 | 22.98 | 23.05 | 23.50 | 22.49 | 22.41 | 22.36 | 23.00 | 22.59 | 22.60 | 22.73 | 23.00 |
| 3GPP Rel 6 | HSDPA Subtest-4 | 22.95 | 22.95 | 23.06 | 23.50 | 22.50 | 22.38 | 22.34 | 23.00 | 22.57 | 22.58 | 22.67 | 23.00 |
| 3GPP Rel 8 | DC-HSDPA Subtest-1 | 22.49 | 22.45 | 22.63 | 23.00 | 21.90 | 21.84 | 21.87 | 22.00 | 22.57 | 22.55 | 22.66 | 23.00 |
| 3GPP Rel 8 | DC-HSDPA Subtest-2 | 22.47 | 22.37 | 22.56 | 23.00 | 21.85 | 21.81 | 21.80 | 22.00 | 22.56 | 22.49 | 22.61 | 23.00 |
| 3GPP Rel 8 | DC-HSDPA Subtest-3 | 22.07 | 21.93 | 22.10 | 22.50 | 21.36 | 21.33 | 21.30 | 22.00 | 22.08 | 22.02 | 22.12 | 22.50 |
| 3GPP Rel 8 | DC-HSDPA Subtest-4 | 21.98 | 21.91 | 22.09 | 22.50 | 21.39 | 21.31 | 21.32 | 22.00 | 22.07 | 22.05 | 22.17 | 22.50 |
| 3GPP Rel 6 | HSUPA Subtest-1 | 21.42 | 21.46 | 21.54 | 22.00 | 21.04 | 20.96 | 20.89 | 21.50 | 21.07 | 21.10 | 21.21 | 21.50 |
| 3GPP Rel 6 | HSUPA Subtest-2 | 21.42 | 21.44 | 21.55 | 22.00 | 20.97 | 20.86 | 20.81 | 21.50 | 21.05 | 21.09 | 21.17 | 21.50 |
| 3GPP Rel 6 | HSUPA Subtest-3 | 22.41 | 22.46 | 22.53 | 23.00 | 21.95 | 21.87 | 21.82 | 22.50 | 22.04 | 22.09 | 22.18 | 22.50 |
| 3GPP Rel 6 | HSUPA Subtest-4 | 20.90 | 20.90 | 20.99 | 22.00 | 20.51 | 20.43 | 20.35 | 21.50 | 20.49 | 20.51 | 20.63 | 21.50 |
| 3GPP Rel 6 | HSUPA Subtest-5 | 23.40 | 23.40 | 23.50 | 24.00 | 23.00 | 22.90 | 22.80 | 23.50 | 22.80 | 23.00 | 23.10 | 23.50 |
| 3GPP Rel 7 | HSPA+ (16QAM) Subtest-1 | 20.93 | 20.84 | 21.09 | 21.50 | 20.28 | 20.28 | 20.25 | 21.00 | 21.13 | 20.96 | 21.11 | 21.50 |

<Reduced Power Mode>

| Band | | WCDMA Band II | | | Tune-up Limit (dBm) | WCDMA Band IV | | | Tune-up Limit (dBm) |
|-----------------|-------------------------|---------------|-------|--------|---------------------|---------------|--------|--------|---------------------|
| Tx Channel | | 9262 | 9400 | 9538 | | 1312 | 1413 | 1513 | |
| Rx Channel | | 9662 | 9800 | 9938 | | 1537 | 1638 | 1738 | |
| Frequency (MHz) | | 1852.4 | 1880 | 1907.6 | | 1712.4 | 1732.6 | 1752.6 | |
| 3GPP Rel 99 | AMR 12.2Kbps | 19.64 | 19.63 | 19.75 | 20.50 | 18.96 | 18.95 | 18.94 | 20.00 |
| 3GPP Rel 99 | RMC 12.2Kbps | 19.66 | 19.64 | 19.76 | 20.50 | 18.97 | 18.96 | 18.95 | 20.00 |
| 3GPP Rel 6 | HSDPA Subtest-1 | 18.69 | 18.78 | 18.83 | 19.50 | 18.14 | 18.08 | 17.91 | 19.00 |
| 3GPP Rel 6 | HSDPA Subtest-2 | 18.67 | 18.79 | 18.85 | 19.50 | 18.13 | 18.00 | 17.98 | 19.00 |
| 3GPP Rel 6 | HSDPA Subtest-3 | 18.24 | 18.36 | 18.43 | 19.00 | 17.69 | 17.57 | 17.51 | 18.50 |
| 3GPP Rel 6 | HSDPA Subtest-4 | 18.22 | 18.30 | 18.38 | 19.00 | 17.68 | 17.56 | 17.45 | 18.50 |
| 3GPP Rel 8 | DC-HSDPA Subtest-1 | 17.76 | 17.85 | 17.90 | 18.00 | 17.10 | 17.01 | 17.07 | 17.50 |
| 3GPP Rel 8 | DC-HSDPA Subtest-2 | 17.78 | 17.76 | 17.87 | 18.00 | 17.03 | 16.99 | 16.98 | 17.50 |
| 3GPP Rel 8 | DC-HSDPA Subtest-3 | 17.37 | 17.33 | 17.40 | 18.00 | 16.56 | 16.48 | 16.50 | 17.00 |
| 3GPP Rel 8 | DC-HSDPA Subtest-4 | 17.25 | 17.31 | 17.36 | 18.00 | 16.59 | 16.48 | 16.52 | 17.00 |
| 3GPP Rel 6 | HSUPA Subtest-1 | 16.71 | 16.84 | 16.92 | 17.50 | 16.24 | 16.12 | 16.04 | 17.00 |
| 3GPP Rel 6 | HSUPA Subtest-2 | 16.69 | 16.79 | 16.87 | 17.50 | 16.15 | 16.04 | 15.92 | 17.00 |
| 3GPP Rel 6 | HSUPA Subtest-3 | 17.65 | 17.80 | 17.84 | 18.50 | 17.12 | 17.01 | 16.95 | 18.00 |
| 3GPP Rel 6 | HSUPA Subtest-4 | 16.19 | 16.28 | 16.37 | 17.50 | 15.71 | 15.59 | 15.50 | 17.00 |
| 3GPP Rel 6 | HSUPA Subtest-5 | 18.67 | 18.75 | 18.82 | 19.50 | 18.18 | 18.08 | 17.91 | 19.00 |
| 3GPP Rel 7 | HSPA+ (16QAM) Subtest-1 | 16.24 | 16.23 | 16.40 | 17.00 | 15.48 | 15.45 | 15.45 | 16.50 |



<FDD LTE Conducted Power>

General Note:

1. Anritsu MT8820C base station simulator was used to setup the connection with EUT; the frequency band, channel bandwidth, RB allocation configuration, modulation type are set in the base station simulator to configure EUT transmitting at maximum power and at different configurations which are requested to be reported to FCC, for conducted power measurement and SAR testing.
2. Per KDB 941225 D05v02r05, when a properly configured base station simulator is used for the SAR and power measurements, spectrum plots for each RB allocation and offset configuration is not required.
3. Per KDB 941225 D05v02r05, start with the largest channel bandwidth and measure SAR for QPSK with 1 RB allocation, using the RB offset and required test channel combination with the highest maximum output power for RB offsets at the upper edge, middle and lower edge of each required test channel.
4. Per KDB 941225 D05v02r05, 50% RB allocation for QPSK SAR testing follows 1RB QPSK allocation procedure.
5. Per KDB 941225 D05v02r05, For QPSK with 100% RB allocation, SAR is not required when the highest maximum output power for 100 % RB allocation is less than the highest maximum output power in 50% and 1 RB allocations and the highest reported SAR for 1 RB and 50% RB allocation are ≤ 0.8 W/kg. Otherwise, SAR is measured for the highest output power channel; and if the reported SAR is > 1.45 W/kg, the remaining required test channels must also be tested.
6. Per KDB 941225 D05v02r05, 16QAM output power for each RB allocation configuration is $>$ not $\frac{1}{2}$ dB higher than the same configuration in QPSK and the reported SAR for the QPSK configuration is ≤ 1.45 W/kg; Per KDB 941225 D05v02r05, 16QAM SAR testing is not required.
7. Per KDB 941225 D05v02r05, Smaller bandwidth output power for each RB allocation configuration is $>$ not $\frac{1}{2}$ dB higher than the same configuration in the largest supported bandwidth, and the reported SAR for the largest supported bandwidth is ≤ 1.45 W/kg; Per KDB 941225 D05v02r05, smaller bandwidth SAR testing is not required.
8. For LTE B4 / B12 / / B38 the maximum bandwidth does not support three non-overlapping channels, per KDB 941225 D05v02r05, when a device supports overlapping channel assignment in a channel bandwidth configuration, the middle channel of the group of overlapping channels should be selected for testing.
9. LTE band 17 SAR test was covered by Band 12; according to April 2015 TCB workshop, SAR test for overlapping LTE bands can be reduced if
 - a. the maximum output power, including tolerance, for the smaller band is \leq the larger band to qualify for the SAR test exclusion
 - b. the channel bandwidth and other operating parameters for the smaller band are fully supported by the larger band



<Full Power Mode>

<LTE Band 2>

| BW [MHz] | Modulation | RB Size | RB Offset | Power Low Ch. / Freq. | Power Middle Ch. / Freq. | Power High Ch. / Freq. | Tune-up limit (dBm) | MPR (dB) |
|-----------------|------------|---------|-----------|-----------------------|--------------------------|------------------------|---------------------|----------|
| Channel | | | | 18700 | 18900 | 19100 | | |
| Frequency (MHz) | | | | 1860 | 1880 | 1900 | | |
| 20 | QPSK | 1 | 0 | 23.47 | 23.41 | 23.36 | 24.50 | 0 |
| 20 | QPSK | 1 | 49 | 23.23 | 23.29 | 23.30 | | |
| 20 | QPSK | 1 | 99 | 23.22 | 23.28 | 23.31 | | |
| 20 | QPSK | 50 | 0 | 22.50 | 22.44 | 22.48 | 23.50 | 1 |
| 20 | QPSK | 50 | 24 | 22.41 | 22.37 | 22.42 | | |
| 20 | QPSK | 50 | 50 | 22.38 | 22.42 | 22.40 | | |
| 20 | QPSK | 100 | 0 | 22.43 | 22.39 | 22.41 | 23.50 | 1 |
| 20 | 16QAM | 1 | 0 | 22.66 | 22.53 | 22.54 | | |
| 20 | 16QAM | 1 | 49 | 22.45 | 22.47 | 22.42 | | |
| 20 | 16QAM | 1 | 99 | 22.37 | 22.49 | 22.52 | 22.50 | 2 |
| 20 | 16QAM | 50 | 0 | 21.41 | 21.34 | 21.34 | | |
| 20 | 16QAM | 50 | 24 | 21.28 | 21.30 | 21.37 | | |
| 20 | 16QAM | 50 | 50 | 21.24 | 21.29 | 21.42 | 22.50 | 2 |
| 20 | 16QAM | 100 | 0 | 21.27 | 21.28 | 21.36 | | |
| Channel | | | | 18675 | 18900 | 19125 | | |
| Frequency (MHz) | | | | 1857.5 | 1880 | 1902.5 | | |
| 15 | QPSK | 1 | 0 | 23.43 | 23.36 | 23.30 | 24.50 | 0 |
| 15 | QPSK | 1 | 37 | 23.29 | 23.34 | 23.39 | | |
| 15 | QPSK | 1 | 74 | 23.22 | 23.28 | 23.37 | | |
| 15 | QPSK | 36 | 0 | 22.48 | 22.44 | 22.42 | 23.50 | 1 |
| 15 | QPSK | 36 | 20 | 22.42 | 22.40 | 22.45 | | |
| 15 | QPSK | 36 | 39 | 22.38 | 22.40 | 22.48 | | |
| 15 | QPSK | 75 | 0 | 22.40 | 22.41 | 22.46 | 23.50 | 1 |
| 15 | 16QAM | 1 | 0 | 22.62 | 22.50 | 22.47 | | |
| 15 | 16QAM | 1 | 37 | 22.48 | 22.52 | 22.50 | | |
| 15 | 16QAM | 1 | 74 | 22.36 | 22.50 | 22.52 | 22.50 | 2 |
| 15 | 16QAM | 36 | 0 | 21.40 | 21.32 | 21.31 | | |
| 15 | 16QAM | 36 | 20 | 21.33 | 21.31 | 21.41 | | |
| 15 | 16QAM | 36 | 39 | 21.24 | 21.30 | 21.43 | 22.50 | 2 |
| 15 | 16QAM | 75 | 0 | 21.32 | 21.31 | 21.40 | | |



| Channel | | | | 18650 | 18900 | 19150 | Tune-up limit (dBm) | MPR (dB) |
|-----------------|-------|----|----|--------|-------|--------|---------------------|----------|
| Frequency (MHz) | | | | 1855 | 1880 | 1905 | | |
| 10 | QPSK | 1 | 0 | 23.43 | 23.31 | 23.32 | 24.50 | 0 |
| 10 | QPSK | 1 | 25 | 23.30 | 23.28 | 23.33 | | |
| 10 | QPSK | 1 | 49 | 23.21 | 23.24 | 23.33 | | |
| 10 | QPSK | 25 | 0 | 22.42 | 22.37 | 22.44 | 23.50 | 1 |
| 10 | QPSK | 25 | 12 | 22.37 | 22.36 | 22.49 | | |
| 10 | QPSK | 25 | 25 | 22.35 | 22.35 | 22.49 | | |
| 10 | QPSK | 50 | 0 | 22.41 | 22.40 | 22.53 | 23.50 | 1 |
| 10 | 16QAM | 1 | 0 | 22.58 | 22.48 | 22.48 | | |
| 10 | 16QAM | 1 | 25 | 22.48 | 22.47 | 22.52 | | |
| 10 | 16QAM | 1 | 49 | 22.36 | 22.45 | 22.48 | 22.50 | 2 |
| 10 | 16QAM | 25 | 0 | 21.38 | 21.29 | 21.39 | | |
| 10 | 16QAM | 25 | 12 | 21.33 | 21.28 | 21.41 | | |
| 10 | 16QAM | 25 | 25 | 21.26 | 21.29 | 21.42 | 22.50 | 2 |
| 10 | 16QAM | 50 | 0 | 21.36 | 21.31 | 21.43 | | |
| Channel | | | | 18625 | 18900 | 19175 | Tune-up limit (dBm) | MPR (dB) |
| Frequency (MHz) | | | | 1852.5 | 1880 | 1907.5 | | |
| 5 | QPSK | 1 | 0 | 23.40 | 23.29 | 23.36 | 24.50 | 0 |
| 5 | QPSK | 1 | 12 | 23.40 | 23.32 | 23.45 | | |
| 5 | QPSK | 1 | 24 | 23.24 | 23.22 | 23.32 | | |
| 5 | QPSK | 12 | 0 | 22.46 | 22.38 | 22.47 | 23.50 | 1 |
| 5 | QPSK | 12 | 7 | 22.43 | 22.37 | 22.46 | | |
| 5 | QPSK | 12 | 13 | 22.43 | 22.37 | 22.45 | | |
| 5 | QPSK | 25 | 0 | 22.42 | 22.35 | 22.43 | 23.50 | 1 |
| 5 | 16QAM | 1 | 0 | 22.58 | 22.46 | 22.49 | | |
| 5 | 16QAM | 1 | 12 | 22.54 | 22.47 | 22.55 | | |
| 5 | 16QAM | 1 | 24 | 22.40 | 22.39 | 22.46 | 22.50 | 2 |
| 5 | 16QAM | 12 | 0 | 21.41 | 21.31 | 21.44 | | |
| 5 | 16QAM | 12 | 7 | 21.39 | 21.30 | 21.44 | | |
| 5 | 16QAM | 12 | 13 | 21.38 | 21.31 | 21.44 | 22.50 | 2 |
| 5 | 16QAM | 25 | 0 | 21.36 | 21.28 | 21.40 | | |



| Channel | | | | 18615 | 18900 | 19185 | Tune-up limit (dBm) | MPR (dB) |
|-----------------|-------|----|----|--------|-------|--------|---------------------|----------|
| Frequency (MHz) | | | | 1851.5 | 1880 | 1908.5 | | |
| 3 | QPSK | 1 | 0 | 23.34 | 23.25 | 23.30 | 24.50 | 0 |
| 3 | QPSK | 1 | 8 | 23.33 | 23.27 | 23.34 | | |
| 3 | QPSK | 1 | 14 | 23.25 | 23.19 | 23.29 | | |
| 3 | QPSK | 8 | 0 | 22.44 | 22.37 | 22.44 | 23.50 | 1 |
| 3 | QPSK | 8 | 4 | 22.44 | 22.34 | 22.44 | | |
| 3 | QPSK | 8 | 7 | 22.43 | 22.33 | 22.44 | | |
| 3 | QPSK | 15 | 0 | 22.45 | 22.35 | 22.47 | 23.50 | 1 |
| 3 | 16QAM | 1 | 0 | 22.52 | 22.39 | 22.44 | | |
| 3 | 16QAM | 1 | 8 | 22.50 | 22.41 | 22.50 | | |
| 3 | 16QAM | 1 | 14 | 22.43 | 22.41 | 22.44 | 22.50 | 2 |
| 3 | 16QAM | 8 | 0 | 21.45 | 21.32 | 21.45 | | |
| 3 | 16QAM | 8 | 4 | 21.43 | 21.32 | 21.46 | | |
| 3 | 16QAM | 8 | 7 | 21.42 | 21.31 | 21.46 | 22.50 | 2 |
| 3 | 16QAM | 15 | 0 | 21.38 | 21.30 | 21.45 | | |
| Channel | | | | 18607 | 18900 | 19193 | Tune-up limit (dBm) | MPR (dB) |
| Frequency (MHz) | | | | 1850.7 | 1880 | 1909.3 | | |
| 1.4 | QPSK | 1 | 0 | 23.37 | 23.26 | 23.33 | 24.50 | 0 |
| 1.4 | QPSK | 1 | 3 | 23.44 | 23.35 | 23.41 | | |
| 1.4 | QPSK | 1 | 5 | 23.32 | 23.25 | 23.34 | | |
| 1.4 | QPSK | 3 | 0 | 23.45 | 23.37 | 23.46 | | |
| 1.4 | QPSK | 3 | 1 | 23.42 | 23.32 | 23.44 | | |
| 1.4 | QPSK | 3 | 3 | 23.41 | 23.32 | 23.41 | 23.50 | 1 |
| 1.4 | QPSK | 6 | 0 | 22.46 | 22.38 | 22.45 | | |
| 1.4 | 16QAM | 1 | 0 | 22.52 | 22.40 | 22.51 | 23.50 | 1 |
| 1.4 | 16QAM | 1 | 3 | 22.62 | 22.49 | 22.57 | | |
| 1.4 | 16QAM | 1 | 5 | 22.46 | 22.42 | 22.46 | | |
| 1.4 | 16QAM | 3 | 0 | 22.40 | 22.31 | 22.38 | | |
| 1.4 | 16QAM | 3 | 1 | 22.38 | 22.30 | 22.37 | | |
| 1.4 | 16QAM | 3 | 3 | 22.36 | 22.27 | 22.35 | | |
| 1.4 | 16QAM | 6 | 0 | 21.47 | 21.36 | 21.49 | 22.50 | 2 |



<LTE Band 4>

| BW [MHz] | Modulation | RB Size | RB Offset | Power Low Ch. / Freq. | Power Middle Ch. / Freq. | Power High Ch. / Freq. | Tune-up limit (dBm) | MPR (dB) |
|-----------------|------------|---------|-----------|-----------------------|--------------------------|------------------------|---------------------|----------|
| Channel | | | | 20050 | 20175 | 20300 | | |
| Frequency (MHz) | | | | 1720 | 1732.5 | 1745 | | |
| 20 | QPSK | 1 | 0 | 24.15 | 24.16 | 24.18 | 24.50 | 0 |
| 20 | QPSK | 1 | 49 | 24.02 | 24.04 | 24.04 | | |
| 20 | QPSK | 1 | 99 | 23.99 | 23.97 | 23.91 | | |
| 20 | QPSK | 50 | 0 | 23.20 | 23.21 | 23.22 | 23.50 | 1 |
| 20 | QPSK | 50 | 24 | 23.13 | 23.15 | 23.13 | | |
| 20 | QPSK | 50 | 50 | 23.10 | 23.10 | 23.07 | | |
| 20 | QPSK | 100 | 0 | 23.13 | 23.12 | 23.14 | 23.50 | 1 |
| 20 | 16QAM | 1 | 0 | 23.30 | 23.29 | 23.36 | | |
| 20 | 16QAM | 1 | 49 | 23.18 | 23.22 | 23.25 | | |
| 20 | 16QAM | 1 | 99 | 23.14 | 23.15 | 23.06 | 22.50 | 2 |
| 20 | 16QAM | 50 | 0 | 22.14 | 22.16 | 22.20 | | |
| 20 | 16QAM | 50 | 24 | 22.08 | 22.11 | 22.12 | | |
| 20 | 16QAM | 50 | 50 | 22.05 | 22.06 | 22.04 | 22.50 | 2 |
| 20 | 16QAM | 100 | 0 | 22.09 | 22.09 | 22.10 | | |
| Channel | | | | 20025 | 20175 | 20325 | | |
| Frequency (MHz) | | | | 1717.5 | 1732.5 | 1747.5 | | |
| 15 | QPSK | 1 | 0 | 24.10 | 24.10 | 24.13 | 24.50 | 0 |
| 15 | QPSK | 1 | 37 | 24.08 | 24.10 | 24.07 | | |
| 15 | QPSK | 1 | 74 | 23.96 | 23.97 | 23.91 | | |
| 15 | QPSK | 36 | 0 | 23.14 | 23.17 | 23.17 | 23.50 | 1 |
| 15 | QPSK | 36 | 20 | 23.10 | 23.14 | 23.10 | | |
| 15 | QPSK | 36 | 39 | 23.10 | 23.12 | 23.06 | | |
| 15 | QPSK | 75 | 0 | 23.13 | 23.13 | 23.13 | 23.50 | 1 |
| 15 | 16QAM | 1 | 0 | 23.26 | 23.23 | 23.31 | | |
| 15 | 16QAM | 1 | 37 | 23.21 | 23.25 | 23.25 | | |
| 15 | 16QAM | 1 | 74 | 23.13 | 23.17 | 23.06 | 22.50 | 2 |
| 15 | 16QAM | 36 | 0 | 22.10 | 22.12 | 22.15 | | |
| 15 | 16QAM | 36 | 20 | 22.07 | 22.10 | 22.10 | | |
| 15 | 16QAM | 36 | 39 | 22.05 | 22.08 | 22.03 | 22.50 | 2 |
| 15 | 16QAM | 75 | 0 | 22.09 | 22.09 | 22.10 | | |



| Channel | | | | 20000 | 20175 | 20350 | Tune-up limit (dBm) | MPR (dB) |
|-----------------|-------|----|----|--------|--------|--------|---------------------|----------|
| Frequency (MHz) | | | | 1715 | 1732.5 | 1750 | | |
| 10 | QPSK | 1 | 0 | 24.08 | 24.08 | 24.06 | 24.50 | 0 |
| 10 | QPSK | 1 | 25 | 24.02 | 24.01 | 23.98 | | |
| 10 | QPSK | 1 | 49 | 23.96 | 23.97 | 23.91 | | |
| 10 | QPSK | 25 | 0 | 23.10 | 23.13 | 23.09 | 23.50 | 1 |
| 10 | QPSK | 25 | 12 | 23.08 | 23.09 | 23.05 | | |
| 10 | QPSK | 25 | 25 | 23.07 | 23.09 | 23.05 | | |
| 10 | QPSK | 50 | 0 | 23.13 | 23.15 | 23.11 | 23.50 | 1 |
| 10 | 16QAM | 1 | 0 | 23.23 | 23.21 | 23.29 | | |
| 10 | 16QAM | 1 | 25 | 23.18 | 23.18 | 23.17 | | |
| 10 | 16QAM | 1 | 49 | 23.10 | 23.12 | 23.05 | 22.50 | 2 |
| 10 | 16QAM | 25 | 0 | 22.07 | 22.07 | 22.06 | | |
| 10 | 16QAM | 25 | 12 | 22.03 | 22.05 | 22.02 | | |
| 10 | 16QAM | 25 | 25 | 22.01 | 22.05 | 22.01 | 22.50 | 2 |
| 10 | 16QAM | 50 | 0 | 22.07 | 22.09 | 22.07 | | |
| Channel | | | | 19975 | 20175 | 20375 | Tune-up limit (dBm) | MPR (dB) |
| Frequency (MHz) | | | | 1712.5 | 1732.5 | 1752.5 | | |
| 5 | QPSK | 1 | 0 | 24.02 | 24.04 | 23.96 | 24.50 | 0 |
| 5 | QPSK | 1 | 12 | 24.04 | 24.07 | 24.02 | | |
| 5 | QPSK | 1 | 24 | 23.90 | 23.94 | 23.87 | | |
| 5 | QPSK | 12 | 0 | 23.12 | 23.14 | 23.08 | 23.50 | 1 |
| 5 | QPSK | 12 | 7 | 23.10 | 23.11 | 23.06 | | |
| 5 | QPSK | 12 | 13 | 23.08 | 23.11 | 23.05 | | |
| 5 | QPSK | 25 | 0 | 23.06 | 23.09 | 23.03 | 23.50 | 1 |
| 5 | 16QAM | 1 | 0 | 23.18 | 23.17 | 23.15 | | |
| 5 | 16QAM | 1 | 12 | 23.19 | 23.19 | 23.16 | | |
| 5 | 16QAM | 1 | 24 | 23.08 | 23.09 | 23.00 | 22.50 | 2 |
| 5 | 16QAM | 12 | 0 | 22.09 | 22.10 | 22.06 | | |
| 5 | 16QAM | 12 | 7 | 22.08 | 22.07 | 22.04 | | |
| 5 | 16QAM | 12 | 13 | 22.05 | 22.07 | 22.02 | 22.50 | 2 |
| 5 | 16QAM | 25 | 0 | 22.03 | 22.04 | 21.99 | | |



| Channel | | | | 19965 | 20175 | 20385 | Tune-up limit (dBm) | MPR (dB) |
|-----------------|-------|----|----|--------|--------|--------|---------------------|----------|
| Frequency (MHz) | | | | 1711.5 | 1732.5 | 1753.5 | | |
| 3 | QPSK | 1 | 0 | 23.95 | 23.95 | 23.89 | 24.50 | 0 |
| 3 | QPSK | 1 | 8 | 23.96 | 23.99 | 23.91 | | |
| 3 | QPSK | 1 | 14 | 23.90 | 23.92 | 23.86 | | |
| 3 | QPSK | 8 | 0 | 23.09 | 23.09 | 23.05 | 23.50 | 1 |
| 3 | QPSK | 8 | 4 | 23.08 | 23.07 | 23.03 | | |
| 3 | QPSK | 8 | 7 | 23.07 | 23.08 | 23.01 | | |
| 3 | QPSK | 15 | 0 | 23.08 | 23.09 | 23.04 | 23.50 | 1 |
| 3 | 16QAM | 1 | 0 | 23.12 | 23.12 | 23.07 | | |
| 3 | 16QAM | 1 | 8 | 23.13 | 23.15 | 23.07 | | |
| 3 | 16QAM | 1 | 14 | 23.06 | 23.09 | 23.01 | 22.50 | 2 |
| 3 | 16QAM | 8 | 0 | 22.11 | 22.09 | 22.06 | | |
| 3 | 16QAM | 8 | 4 | 22.08 | 22.09 | 22.03 | | |
| 3 | 16QAM | 8 | 7 | 22.08 | 22.08 | 22.01 | 22.50 | 2 |
| 3 | 16QAM | 15 | 0 | 22.06 | 22.05 | 22.01 | | |
| Channel | | | | 19957 | 20175 | 20393 | Tune-up limit (dBm) | MPR (dB) |
| Frequency (MHz) | | | | 1710.7 | 1732.5 | 1754.3 | | |
| 1.4 | QPSK | 1 | 0 | 23.96 | 23.99 | 23.91 | 24.50 | 0 |
| 1.4 | QPSK | 1 | 3 | 24.05 | 24.07 | 24.00 | | |
| 1.4 | QPSK | 1 | 5 | 23.95 | 23.96 | 23.89 | | |
| 1.4 | QPSK | 3 | 0 | 24.07 | 24.08 | 24.03 | | |
| 1.4 | QPSK | 3 | 1 | 24.04 | 24.05 | 24.00 | | |
| 1.4 | QPSK | 3 | 3 | 24.03 | 24.04 | 23.98 | 23.50 | 1 |
| 1.4 | QPSK | 6 | 0 | 23.08 | 23.09 | 23.04 | | |
| 1.4 | 16QAM | 1 | 0 | 23.14 | 23.13 | 23.03 | 23.50 | 1 |
| 1.4 | 16QAM | 1 | 3 | 23.23 | 23.19 | 23.17 | | |
| 1.4 | 16QAM | 1 | 5 | 23.11 | 23.09 | 23.03 | | |
| 1.4 | 16QAM | 3 | 0 | 23.02 | 23.03 | 22.95 | | |
| 1.4 | 16QAM | 3 | 1 | 23.00 | 22.99 | 22.93 | | |
| 1.4 | 16QAM | 3 | 3 | 22.97 | 22.96 | 22.91 | | |
| 1.4 | 16QAM | 6 | 0 | 22.11 | 22.13 | 22.05 | 22.50 | 2 |



<LTE Band 7>

| BW [MHz] | Modulation | RB Size | RB Offset | Power Low Ch. / Freq. | Power Middle Ch. / Freq. | Power High Ch. / Freq. | Tune-up limit (dBm) | MPR (dB) |
|-----------------|------------|---------|-----------|-----------------------|--------------------------|------------------------|---------------------|----------|
| Channel | | | | 20850 | 21100 | 21350 | | |
| Frequency (MHz) | | | | 2510 | 2535 | 2560 | | |
| 20 | QPSK | 1 | 0 | 24.09 | 24.18 | 24.05 | 24.50 | 0 |
| 20 | QPSK | 1 | 49 | 24.01 | 23.77 | 24.01 | | |
| 20 | QPSK | 1 | 99 | 23.77 | 23.97 | 23.96 | | |
| 20 | QPSK | 50 | 0 | 23.18 | 23.20 | 23.19 | 23.50 | 1 |
| 20 | QPSK | 50 | 24 | 23.16 | 23.08 | 23.18 | | |
| 20 | QPSK | 50 | 50 | 23.05 | 23.08 | 23.14 | | |
| 20 | QPSK | 100 | 0 | 23.16 | 23.19 | 23.17 | 23.50 | 1 |
| 20 | 16QAM | 1 | 0 | 22.91 | 23.31 | 23.22 | | |
| 20 | 16QAM | 1 | 49 | 23.15 | 23.06 | 23.17 | | |
| 20 | 16QAM | 1 | 99 | 23.26 | 23.25 | 23.14 | 22.50 | 2 |
| 20 | 16QAM | 50 | 0 | 22.11 | 22.20 | 22.14 | | |
| 20 | 16QAM | 50 | 24 | 22.12 | 22.19 | 22.11 | | |
| 20 | 16QAM | 50 | 50 | 22.15 | 22.22 | 22.13 | 22.50 | 2 |
| 20 | 16QAM | 100 | 0 | 22.10 | 22.18 | 22.11 | | |
| Channel | | | | 20825 | 21100 | 21375 | | |
| Frequency (MHz) | | | | 2507.5 | 2535 | 2562.5 | | |
| 15 | QPSK | 1 | 0 | 23.46 | 23.86 | 24.05 | 24.50 | 0 |
| 15 | QPSK | 1 | 37 | 23.77 | 23.68 | 24.04 | | |
| 15 | QPSK | 1 | 74 | 24.09 | 23.89 | 23.86 | | |
| 15 | QPSK | 36 | 0 | 22.76 | 22.97 | 23.17 | 23.50 | 1 |
| 15 | QPSK | 36 | 20 | 23.01 | 22.99 | 23.14 | | |
| 15 | QPSK | 36 | 39 | 23.16 | 23.01 | 23.15 | | |
| 15 | QPSK | 75 | 0 | 23.04 | 23.06 | 23.17 | 23.50 | 1 |
| 15 | 16QAM | 1 | 0 | 22.67 | 23.13 | 23.19 | | |
| 15 | 16QAM | 1 | 37 | 23.04 | 23.01 | 23.22 | | |
| 15 | 16QAM | 1 | 74 | 23.23 | 23.25 | 23.13 | 22.50 | 2 |
| 15 | 16QAM | 36 | 0 | 21.95 | 22.20 | 22.12 | | |
| 15 | 16QAM | 36 | 20 | 22.11 | 22.18 | 22.10 | | |
| 15 | 16QAM | 36 | 39 | 22.11 | 22.19 | 22.10 | 22.50 | 2 |
| 15 | 16QAM | 75 | 0 | 22.11 | 22.19 | 22.10 | | |



| Channel | | | | 20800 | 21100 | 21400 | Tune-up limit (dBm) | MPR (dB) |
|-----------------|-------|----|----|--------|-------|--------|---------------------|----------|
| Frequency (MHz) | | | | 2505 | 2535 | 2565 | | |
| 10 | QPSK | 1 | 0 | 23.26 | 23.65 | 24.02 | 24.50 | 0 |
| 10 | QPSK | 1 | 25 | 23.53 | 23.63 | 23.97 | | |
| 10 | QPSK | 1 | 49 | 23.74 | 23.62 | 23.69 | | |
| 10 | QPSK | 25 | 0 | 22.61 | 22.91 | 23.11 | 23.50 | 1 |
| 10 | QPSK | 25 | 12 | 22.84 | 22.94 | 23.10 | | |
| 10 | QPSK | 25 | 25 | 23.00 | 22.97 | 23.10 | | |
| 10 | QPSK | 50 | 0 | 22.85 | 23.00 | 23.15 | 23.50 | 1 |
| 10 | 16QAM | 1 | 0 | 22.48 | 22.99 | 23.15 | | |
| 10 | 16QAM | 1 | 25 | 22.83 | 22.96 | 23.09 | | |
| 10 | 16QAM | 1 | 49 | 23.05 | 23.02 | 23.01 | 22.50 | 2 |
| 10 | 16QAM | 25 | 0 | 21.80 | 22.13 | 22.06 | | |
| 10 | 16QAM | 25 | 12 | 21.96 | 22.13 | 22.04 | | |
| 10 | 16QAM | 25 | 25 | 22.06 | 22.15 | 22.03 | 22.50 | 2 |
| 10 | 16QAM | 50 | 0 | 22.01 | 22.16 | 22.08 | | |
| Channel | | | | 20775 | 21100 | 21425 | Tune-up limit (dBm) | MPR (dB) |
| Frequency (MHz) | | | | 2502.5 | 2535 | 2567.5 | | |
| 5 | QPSK | 1 | 0 | 23.70 | 24.11 | 23.99 | 24.50 | 0 |
| 5 | QPSK | 1 | 12 | 23.39 | 23.67 | 23.89 | | |
| 5 | QPSK | 1 | 24 | 23.86 | 23.98 | 24.00 | | |
| 5 | QPSK | 12 | 0 | 22.68 | 23.04 | 23.08 | 23.50 | 1 |
| 5 | QPSK | 12 | 7 | 22.66 | 22.95 | 23.13 | | |
| 5 | QPSK | 12 | 13 | 22.74 | 22.96 | 23.13 | | |
| 5 | QPSK | 25 | 0 | 22.71 | 23.02 | 23.12 | 23.50 | 1 |
| 5 | 16QAM | 1 | 0 | 22.95 | 23.21 | 23.07 | | |
| 5 | 16QAM | 1 | 12 | 22.72 | 22.96 | 23.14 | | |
| 5 | 16QAM | 1 | 24 | 23.04 | 23.15 | 23.00 | 22.50 | 2 |
| 5 | 16QAM | 12 | 0 | 21.86 | 22.16 | 22.03 | | |
| 5 | 16QAM | 12 | 7 | 21.85 | 22.15 | 22.04 | | |
| 5 | 16QAM | 12 | 13 | 21.92 | 22.14 | 22.05 | 22.50 | 2 |
| 5 | 16QAM | 25 | 0 | 21.92 | 22.13 | 22.03 | | |



<LTE Band 12>

| BW [MHz] | Modulation | RB Size | RB Offset | Power Low Ch. / Freq. | Power Middle Ch. / Freq. | Power High Ch. / Freq. | Tune-up limit (dBm) | MPR (dB) |
|-----------------|------------|---------|-----------|-----------------------|--------------------------|------------------------|---------------------|----------|
| Channel | | | | 23060 | 23095 | 23130 | | |
| Frequency (MHz) | | | | 704 | 707.5 | 711 | | |
| 10 | QPSK | 1 | 0 | 22.37 | 22.38 | 22.35 | 24.00 | 0 |
| 10 | QPSK | 1 | 25 | 22.34 | 22.31 | 22.32 | | |
| 10 | QPSK | 1 | 49 | 22.33 | 22.34 | 22.25 | | |
| 10 | QPSK | 25 | 0 | 21.38 | 21.39 | 21.35 | 23.00 | 1 |
| 10 | QPSK | 25 | 12 | 21.34 | 21.36 | 21.33 | | |
| 10 | QPSK | 25 | 25 | 21.32 | 21.34 | 21.33 | | |
| 10 | QPSK | 50 | 0 | 21.33 | 21.35 | 21.33 | 23.00 | 1 |
| 10 | 16QAM | 1 | 0 | 21.81 | 21.77 | 21.78 | | |
| 10 | 16QAM | 1 | 25 | 21.79 | 21.85 | 21.85 | | |
| 10 | 16QAM | 1 | 49 | 21.88 | 21.82 | 21.69 | 22.00 | 2 |
| 10 | 16QAM | 25 | 0 | 20.36 | 20.35 | 20.37 | | |
| 10 | 16QAM | 25 | 12 | 20.36 | 20.37 | 20.39 | | |
| 10 | 16QAM | 25 | 25 | 20.40 | 20.43 | 20.35 | 22.00 | 2 |
| 10 | 16QAM | 50 | 0 | 20.38 | 20.36 | 20.37 | | |
| 10 | 16QAM | 50 | 0 | 20.38 | 20.36 | 20.37 | | |
| Channel | | | | 23035 | 23095 | 23155 | Tune-up limit (dBm) | MPR (dB) |
| Frequency (MHz) | | | | 701.5 | 707.5 | 713.5 | | |
| 5 | QPSK | 1 | 0 | 22.29 | 22.31 | 22.30 | 24.00 | 0 |
| 5 | QPSK | 1 | 12 | 22.40 | 22.38 | 22.29 | | |
| 5 | QPSK | 1 | 24 | 22.30 | 22.32 | 22.19 | | |
| 5 | QPSK | 12 | 0 | 21.42 | 21.44 | 21.38 | 23.00 | 1 |
| 5 | QPSK | 12 | 7 | 21.43 | 21.43 | 21.34 | | |
| 5 | QPSK | 12 | 13 | 21.44 | 21.44 | 21.32 | | |
| 5 | QPSK | 25 | 0 | 21.33 | 21.34 | 21.26 | 23.00 | 1 |
| 5 | 16QAM | 1 | 0 | 21.84 | 21.77 | 21.79 | | |
| 5 | 16QAM | 1 | 12 | 21.89 | 21.91 | 21.70 | | |
| 5 | 16QAM | 1 | 24 | 21.76 | 21.82 | 21.64 | 22.00 | 2 |
| 5 | 16QAM | 12 | 0 | 20.52 | 20.46 | 20.40 | | |
| 5 | 16QAM | 12 | 7 | 20.49 | 20.47 | 20.34 | | |
| 5 | 16QAM | 12 | 13 | 20.46 | 20.50 | 20.33 | 22.00 | 2 |
| 5 | 16QAM | 25 | 0 | 20.38 | 20.37 | 20.29 | | |



| Channel | | | | 23025 | 23095 | 23165 | Tune-up limit (dBm) | MPR (dB) |
|-----------------|-------|----|----|-------|-------|-------|---------------------|----------|
| Frequency (MHz) | | | | 700.5 | 707.5 | 714.5 | | |
| 3 | QPSK | 1 | 0 | 22.21 | 22.26 | 22.16 | 24.00 | 0 |
| 3 | QPSK | 1 | 8 | 22.31 | 22.32 | 22.18 | | |
| 3 | QPSK | 1 | 14 | 22.27 | 22.25 | 22.13 | | |
| 3 | QPSK | 8 | 0 | 21.42 | 21.40 | 21.29 | 23.00 | 1 |
| 3 | QPSK | 8 | 4 | 21.40 | 21.42 | 21.28 | | |
| 3 | QPSK | 8 | 7 | 21.41 | 21.41 | 21.30 | | |
| 3 | QPSK | 15 | 0 | 21.35 | 21.35 | 21.26 | 23.00 | 1 |
| 3 | 16QAM | 1 | 0 | 21.70 | 21.68 | 21.59 | | |
| 3 | 16QAM | 1 | 8 | 21.82 | 21.80 | 21.61 | | |
| 3 | 16QAM | 1 | 14 | 21.72 | 21.75 | 21.60 | 22.00 | 2 |
| 3 | 16QAM | 8 | 0 | 20.57 | 20.48 | 20.37 | | |
| 3 | 16QAM | 8 | 4 | 20.53 | 20.51 | 20.34 | | |
| 3 | 16QAM | 8 | 7 | 20.53 | 20.50 | 20.36 | 22.00 | 2 |
| 3 | 16QAM | 15 | 0 | 20.43 | 20.39 | 20.27 | | |
| Channel | | | | 23017 | 23095 | 23173 | Tune-up limit (dBm) | MPR (dB) |
| Frequency (MHz) | | | | 699.7 | 707.5 | 715.3 | | |
| 1.4 | QPSK | 1 | 0 | 22.26 | 22.27 | 22.15 | 24.00 | 0 |
| 1.4 | QPSK | 1 | 3 | 22.38 | 22.38 | 22.25 | | |
| 1.4 | QPSK | 1 | 5 | 22.29 | 22.28 | 22.14 | | |
| 1.4 | QPSK | 3 | 0 | 22.36 | 22.36 | 22.23 | | |
| 1.4 | QPSK | 3 | 1 | 22.32 | 22.32 | 22.23 | | |
| 1.4 | QPSK | 3 | 3 | 22.31 | 22.32 | 22.21 | 23.00 | 1 |
| 1.4 | QPSK | 6 | 0 | 21.37 | 21.34 | 21.25 | | |
| 1.4 | 16QAM | 1 | 0 | 21.81 | 21.75 | 21.57 | 23.00 | 1 |
| 1.4 | 16QAM | 1 | 3 | 21.87 | 21.87 | 21.67 | | |
| 1.4 | 16QAM | 1 | 5 | 21.84 | 21.78 | 21.58 | | |
| 1.4 | 16QAM | 3 | 0 | 21.55 | 21.52 | 21.36 | | |
| 1.4 | 16QAM | 3 | 1 | 21.51 | 21.49 | 21.35 | | |
| 1.4 | 16QAM | 3 | 3 | 21.50 | 21.47 | 21.33 | 22.00 | 2 |
| 1.4 | 16QAM | 6 | 0 | 20.53 | 20.48 | 20.36 | | |



<LTE Band 17>

| BW [MHz] | Modulation | RB Size | RB Offset | Power Low Ch. / Freq. | Power Middle Ch. / Freq. | Power High Ch. / Freq. | Tune-up limit (dBm) | MPR (dB) |
|-----------------|------------|---------|-----------|-----------------------|--------------------------|------------------------|---------------------|----------|
| Channel | | | | 23780 | 23790 | 23800 | | |
| Frequency (MHz) | | | | 709 | 710 | 711 | | |
| 10 | QPSK | 1 | 0 | 22.29 | 22.29 | 22.26 | 24.00 | 0 |
| 10 | QPSK | 1 | 25 | 22.34 | 22.35 | 22.32 | | |
| 10 | QPSK | 1 | 49 | 22.27 | 22.26 | 22.25 | | |
| 10 | QPSK | 25 | 0 | 21.33 | 21.37 | 21.36 | 23.00 | 1 |
| 10 | QPSK | 25 | 12 | 21.31 | 21.34 | 21.33 | | |
| 10 | QPSK | 25 | 25 | 21.31 | 21.33 | 21.32 | | |
| 10 | 16QAM | 1 | 0 | 21.75 | 21.76 | 21.74 | 23.00 | 1 |
| 10 | 16QAM | 1 | 25 | 21.84 | 21.85 | 21.88 | | |
| 10 | 16QAM | 1 | 49 | 21.72 | 21.70 | 21.71 | | |
| 10 | 16QAM | 25 | 0 | 20.33 | 20.34 | 20.36 | 22.00 | 2 |
| 10 | 16QAM | 25 | 12 | 20.37 | 20.38 | 20.39 | | |
| 10 | 16QAM | 25 | 25 | 20.42 | 20.37 | 20.39 | | |
| 10 | 16QAM | 50 | 0 | 20.37 | 20.33 | 20.34 | | |
| Channel | | | | 23755 | 23790 | 23825 | Tune-up limit (dBm) | MPR (dB) |
| Frequency (MHz) | | | | 706.5 | 710 | 713.5 | | |
| 5 | QPSK | 1 | 0 | 22.30 | 22.29 | 22.29 | 24.00 | 0 |
| 5 | QPSK | 1 | 12 | 22.38 | 22.40 | 22.32 | | |
| 5 | QPSK | 1 | 24 | 22.30 | 22.29 | 22.20 | | |
| 5 | QPSK | 12 | 0 | 21.40 | 21.41 | 21.37 | 23.00 | 1 |
| 5 | QPSK | 12 | 7 | 21.39 | 21.41 | 21.35 | | |
| 5 | QPSK | 12 | 13 | 21.41 | 21.43 | 21.34 | | |
| 5 | QPSK | 25 | 0 | 21.33 | 21.33 | 21.28 | 23.00 | 1 |
| 5 | 16QAM | 1 | 0 | 21.75 | 21.79 | 21.79 | | |
| 5 | 16QAM | 1 | 12 | 21.86 | 21.90 | 21.70 | | |
| 5 | 16QAM | 1 | 24 | 21.81 | 21.77 | 21.66 | 22.00 | 2 |
| 5 | 16QAM | 12 | 0 | 20.42 | 20.47 | 20.39 | | |
| 5 | 16QAM | 12 | 7 | 20.40 | 20.47 | 20.38 | | |
| 5 | 16QAM | 12 | 13 | 20.45 | 20.48 | 20.36 | | |
| 5 | 16QAM | 25 | 0 | 20.33 | 20.36 | 20.30 | | |

<Reduced Power Mode>

<LTE Band 2>

| BW [MHz] | Modulation | RB Size | RB Offset | Power Low Ch. / Freq. | Power Middle Ch. / Freq. | Power High Ch. / Freq. | Tune-up limit (dBm) | MPR (dB) |
|-----------------|------------|---------|-----------|-----------------------|--------------------------|------------------------|---------------------|----------|
| Channel | | | | 18700 | 18900 | 19100 | | |
| Frequency (MHz) | | | | 1860 | 1880 | 1900 | | |
| 20 | QPSK | 1 | 0 | 19.93 | 19.90 | 19.80 | 20.50 | 0 |
| 20 | QPSK | 1 | 49 | 19.77 | 19.82 | 19.75 | | |
| 20 | QPSK | 1 | 99 | 19.70 | 19.77 | 19.73 | | |
| 20 | QPSK | 50 | 0 | 19.92 | 19.91 | 19.91 | 20.50 | 0 |
| 20 | QPSK | 50 | 24 | 19.85 | 19.88 | 19.88 | | |
| 20 | QPSK | 50 | 50 | 19.86 | 19.90 | 19.86 | | |
| 20 | QPSK | 100 | 0 | 19.91 | 19.85 | 19.85 | 20.50 | 0 |
| 20 | 16QAM | 1 | 0 | 20.04 | 20.02 | 19.97 | | |
| 20 | 16QAM | 1 | 49 | 19.93 | 19.97 | 19.89 | | |
| 20 | 16QAM | 1 | 99 | 19.82 | 19.97 | 19.91 | 20.50 | 0 |
| 20 | 16QAM | 50 | 0 | 19.83 | 19.86 | 19.79 | | |
| 20 | 16QAM | 50 | 24 | 19.77 | 19.82 | 19.79 | | |
| 20 | 16QAM | 50 | 50 | 19.75 | 19.86 | 19.81 | 20.50 | 0 |
| 20 | 16QAM | 100 | 0 | 19.76 | 19.84 | 19.77 | | |
| Channel | | | | 18675 | 18900 | 19125 | | |
| Frequency (MHz) | | | | 1857.5 | 1880 | 1902.5 | | |
| 15 | QPSK | 1 | 0 | 19.91 | 19.84 | 19.71 | 20.50 | 0 |
| 15 | QPSK | 1 | 37 | 19.76 | 19.77 | 19.78 | | |
| 15 | QPSK | 1 | 74 | 19.72 | 19.74 | 19.74 | | |
| 15 | QPSK | 36 | 0 | 19.90 | 19.86 | 19.83 | 20.50 | 0 |
| 15 | QPSK | 36 | 20 | 19.83 | 19.84 | 19.86 | | |
| 15 | QPSK | 36 | 39 | 19.80 | 19.83 | 19.88 | | |
| 15 | QPSK | 75 | 0 | 19.84 | 19.83 | 19.87 | 20.50 | 0 |
| 15 | 16QAM | 1 | 0 | 19.98 | 19.97 | 19.83 | | |
| 15 | 16QAM | 1 | 37 | 19.91 | 19.92 | 19.87 | | |
| 15 | 16QAM | 1 | 74 | 19.83 | 19.91 | 19.86 | 20.50 | 0 |
| 15 | 16QAM | 36 | 0 | 19.83 | 19.79 | 19.73 | | |
| 15 | 16QAM | 36 | 20 | 19.76 | 19.78 | 19.78 | | |
| 15 | 16QAM | 36 | 39 | 19.69 | 19.78 | 19.79 | 20.50 | 0 |
| 15 | 16QAM | 75 | 0 | 19.76 | 19.78 | 19.78 | | |



| Channel | | | | 18650 | 18900 | 19150 | Tune-up limit (dBm) | MPR (dB) |
|-----------------|-------|----|----|--------|-------|--------|---------------------|----------|
| Frequency (MHz) | | | | 1855 | 1880 | 1905 | | |
| 10 | QPSK | 1 | 0 | 19.82 | 19.76 | 19.74 | 20.50 | 0 |
| 10 | QPSK | 1 | 25 | 19.75 | 19.79 | 19.76 | | |
| 10 | QPSK | 1 | 49 | 19.69 | 19.70 | 19.69 | | |
| 10 | QPSK | 25 | 0 | 19.88 | 19.84 | 19.81 | 20.50 | 0 |
| 10 | QPSK | 25 | 12 | 19.82 | 19.84 | 19.83 | | |
| 10 | QPSK | 25 | 25 | 19.78 | 19.81 | 19.80 | | |
| 10 | QPSK | 50 | 0 | 19.84 | 19.87 | 19.85 | 20.50 | 0 |
| 10 | 16QAM | 1 | 0 | 19.95 | 19.90 | 19.85 | | |
| 10 | 16QAM | 1 | 25 | 19.88 | 19.94 | 19.87 | | |
| 10 | 16QAM | 1 | 49 | 19.81 | 19.88 | 19.85 | 20.50 | 0 |
| 10 | 16QAM | 25 | 0 | 19.78 | 19.77 | 19.72 | | |
| 10 | 16QAM | 25 | 12 | 19.74 | 19.78 | 19.74 | | |
| 10 | 16QAM | 25 | 25 | 19.70 | 19.76 | 19.74 | 20.50 | 0 |
| 10 | 16QAM | 50 | 0 | 19.77 | 19.81 | 19.76 | | |
| Channel | | | | 18625 | 18900 | 19175 | Tune-up limit (dBm) | MPR (dB) |
| Frequency (MHz) | | | | 1852.5 | 1880 | 1907.5 | | |
| 5 | QPSK | 1 | 0 | 19.82 | 19.76 | 19.74 | 20.50 | 0 |
| 5 | QPSK | 1 | 12 | 19.80 | 19.74 | 19.74 | | |
| 5 | QPSK | 1 | 24 | 19.70 | 19.68 | 19.68 | | |
| 5 | QPSK | 12 | 0 | 19.90 | 19.86 | 19.82 | 20.50 | 0 |
| 5 | QPSK | 12 | 7 | 19.87 | 19.81 | 19.82 | | |
| 5 | QPSK | 12 | 13 | 19.86 | 19.83 | 19.81 | | |
| 5 | QPSK | 25 | 0 | 19.85 | 19.84 | 19.78 | 20.50 | 0 |
| 5 | 16QAM | 1 | 0 | 19.94 | 19.92 | 19.84 | | |
| 5 | 16QAM | 1 | 12 | 19.92 | 19.91 | 19.88 | | |
| 5 | 16QAM | 1 | 24 | 19.84 | 19.86 | 19.81 | 20.50 | 0 |
| 5 | 16QAM | 12 | 0 | 19.81 | 19.79 | 19.73 | | |
| 5 | 16QAM | 12 | 7 | 19.78 | 19.75 | 19.73 | | |
| 5 | 16QAM | 12 | 13 | 19.77 | 19.77 | 19.75 | 20.50 | 0 |
| 5 | 16QAM | 25 | 0 | 19.76 | 19.76 | 19.71 | | |



| Channel | | | | 18615 | 18900 | 19185 | Tune-up limit (dBm) | MPR (dB) |
|-----------------|-------|----|----|--------|-------|--------|---------------------|----------|
| Frequency (MHz) | | | | 1851.5 | 1880 | 1908.5 | | |
| 3 | QPSK | 1 | 0 | 19.77 | 19.69 | 19.68 | 20.50 | 0 |
| 3 | QPSK | 1 | 8 | 19.79 | 19.74 | 19.74 | | |
| 3 | QPSK | 1 | 14 | 19.71 | 19.67 | 19.67 | | |
| 3 | QPSK | 8 | 0 | 19.86 | 19.80 | 19.81 | 20.50 | 0 |
| 3 | QPSK | 8 | 4 | 19.85 | 19.80 | 19.81 | | |
| 3 | QPSK | 8 | 7 | 19.85 | 19.79 | 19.80 | | |
| 3 | QPSK | 15 | 0 | 19.85 | 19.82 | 19.82 | 20.50 | 0 |
| 3 | 16QAM | 1 | 0 | 19.89 | 19.83 | 19.78 | | |
| 3 | 16QAM | 1 | 8 | 19.93 | 19.85 | 19.84 | | |
| 3 | 16QAM | 1 | 14 | 19.86 | 19.83 | 19.78 | 20.50 | 0 |
| 3 | 16QAM | 8 | 0 | 19.82 | 19.78 | 19.78 | | |
| 3 | 16QAM | 8 | 4 | 19.81 | 19.77 | 19.77 | | |
| 3 | 16QAM | 8 | 7 | 19.80 | 19.77 | 19.77 | 20.50 | 0 |
| 3 | 16QAM | 15 | 0 | 19.80 | 19.76 | 19.76 | | |
| Channel | | | | 18607 | 18900 | 19193 | Tune-up limit (dBm) | MPR (dB) |
| Frequency (MHz) | | | | 1850.7 | 1880 | 1909.3 | | |
| 1.4 | QPSK | 1 | 0 | 19.77 | 19.71 | 19.68 | 20.50 | 0 |
| 1.4 | QPSK | 1 | 3 | 19.87 | 19.81 | 19.78 | | |
| 1.4 | QPSK | 1 | 5 | 19.75 | 19.70 | 19.69 | | |
| 1.4 | QPSK | 3 | 0 | 19.88 | 19.82 | 19.80 | | |
| 1.4 | QPSK | 3 | 1 | 19.83 | 19.77 | 19.77 | | |
| 1.4 | QPSK | 3 | 3 | 19.81 | 19.76 | 19.76 | | |
| 1.4 | QPSK | 6 | 0 | 19.87 | 19.79 | 19.79 | 20.50 | 0 |
| 1.4 | 16QAM | 1 | 0 | 19.86 | 19.86 | 19.83 | 20.50 | 0 |
| 1.4 | 16QAM | 1 | 3 | 19.97 | 19.96 | 19.92 | | |
| 1.4 | 16QAM | 1 | 5 | 19.85 | 19.83 | 19.81 | | |
| 1.4 | 16QAM | 3 | 0 | 19.79 | 19.75 | 19.73 | | |
| 1.4 | 16QAM | 3 | 1 | 19.75 | 19.70 | 19.69 | | |
| 1.4 | 16QAM | 3 | 3 | 19.74 | 19.68 | 19.70 | | |
| 1.4 | 16QAM | 6 | 0 | 19.83 | 19.77 | 19.79 | 20.50 | 0 |



<LTE Band 4>

| BW [MHz] | Modulation | RB Size | RB Offset | Power Low Ch. / Freq. | Power Middle Ch. / Freq. | Power High Ch. / Freq. | Tune-up limit (dBm) | MPR (dB) |
|-----------------|------------|---------|-----------|-----------------------|--------------------------|------------------------|---------------------|----------|
| Channel | | | | 20050 | 20175 | 20300 | 20.00 | 0 |
| Frequency (MHz) | | | | 1720 | 1732.5 | 1745 | | |
| 20 | QPSK | 1 | 0 | 19.17 | 19.17 | 19.22 | | |
| 20 | QPSK | 1 | 49 | 19.06 | 19.08 | 19.12 | 20.00 | 0 |
| 20 | QPSK | 1 | 99 | 18.97 | 19.00 | 18.96 | | |
| 20 | QPSK | 50 | 0 | 19.22 | 19.22 | 19.25 | | |
| 20 | QPSK | 50 | 24 | 19.20 | 19.19 | 19.19 | 20.00 | 0 |
| 20 | QPSK | 50 | 50 | 19.09 | 19.15 | 19.14 | | |
| 20 | QPSK | 100 | 0 | 19.15 | 19.16 | 19.17 | | |
| 20 | 16QAM | 1 | 0 | 19.37 | 19.32 | 19.40 | 20.00 | 0 |
| 20 | 16QAM | 1 | 49 | 19.22 | 19.24 | 19.33 | | |
| 20 | 16QAM | 1 | 99 | 19.12 | 19.22 | 19.11 | | |
| 20 | 16QAM | 50 | 0 | 19.15 | 19.16 | 19.21 | 20.00 | 0 |
| 20 | 16QAM | 50 | 24 | 19.13 | 19.12 | 19.16 | | |
| 20 | 16QAM | 50 | 50 | 19.01 | 19.12 | 19.10 | | |
| 20 | 16QAM | 100 | 0 | 19.07 | 19.09 | 19.13 | 20.00 | 0 |
| Channel | | | | 20025 | 20175 | 20325 | | |
| Frequency (MHz) | | | | 1717.5 | 1732.5 | 1747.5 | | |
| 15 | QPSK | 1 | 0 | 19.21 | 19.24 | 19.29 | 20.00 | 0 |
| 15 | QPSK | 1 | 37 | 19.14 | 19.21 | 19.21 | | |
| 15 | QPSK | 1 | 74 | 19.10 | 19.13 | 19.11 | | |
| 15 | QPSK | 36 | 0 | 19.25 | 19.32 | 19.34 | 20.00 | 0 |
| 15 | QPSK | 36 | 20 | 19.23 | 19.30 | 19.30 | | |
| 15 | QPSK | 36 | 39 | 19.21 | 19.29 | 19.26 | | |
| 15 | QPSK | 75 | 0 | 19.22 | 19.29 | 19.29 | 20.00 | 0 |
| 15 | 16QAM | 1 | 0 | 19.37 | 19.36 | 19.47 | | |
| 15 | 16QAM | 1 | 37 | 19.31 | 19.35 | 19.41 | | |
| 15 | 16QAM | 1 | 74 | 19.23 | 19.30 | 19.26 | 20.00 | 0 |
| 15 | 16QAM | 36 | 0 | 19.20 | 19.24 | 19.30 | | |
| 15 | 16QAM | 36 | 20 | 19.17 | 19.23 | 19.26 | | |
| 15 | 16QAM | 36 | 39 | 19.14 | 19.22 | 19.20 | 20.00 | 0 |
| 15 | 16QAM | 75 | 0 | 19.16 | 19.22 | 19.24 | | |



| Channel | | | | 20000 | 20175 | 20350 | Tune-up limit (dBm) | MPR (dB) |
|-----------------|-------|----|----|--------|--------|--------|---------------------|----------|
| Frequency (MHz) | | | | 1715 | 1732.5 | 1750 | | |
| 10 | QPSK | 1 | 0 | 19.19 | 19.21 | 19.25 | 20.00 | 0 |
| 10 | QPSK | 1 | 25 | 19.13 | 19.21 | 19.20 | | |
| 10 | QPSK | 1 | 49 | 19.06 | 19.14 | 19.11 | | |
| 10 | QPSK | 25 | 0 | 19.20 | 19.28 | 19.25 | 20.00 | 0 |
| 10 | QPSK | 25 | 12 | 19.19 | 19.26 | 19.23 | | |
| 10 | QPSK | 25 | 25 | 19.18 | 19.25 | 19.20 | | |
| 10 | QPSK | 50 | 0 | 19.24 | 19.29 | 19.30 | | |
| 10 | 16QAM | 1 | 0 | 19.38 | 19.37 | 19.45 | 20.00 | 0 |
| 10 | 16QAM | 1 | 25 | 19.32 | 19.34 | 19.38 | | |
| 10 | 16QAM | 1 | 49 | 19.24 | 19.30 | 19.25 | | |
| 10 | 16QAM | 25 | 0 | 19.15 | 19.20 | 19.23 | 20.00 | 0 |
| 10 | 16QAM | 25 | 12 | 19.14 | 19.18 | 19.19 | | |
| 10 | 16QAM | 25 | 25 | 19.12 | 19.18 | 19.16 | | |
| 10 | 16QAM | 50 | 0 | 19.17 | 19.24 | 19.25 | | |
| Channel | | | | 19975 | 20175 | 20375 | Tune-up limit (dBm) | MPR (dB) |
| Frequency (MHz) | | | | 1712.5 | 1732.5 | 1752.5 | | |
| 5 | QPSK | 1 | 0 | 19.14 | 19.20 | 19.18 | 20.00 | 0 |
| 5 | QPSK | 1 | 12 | 19.15 | 19.21 | 19.20 | | |
| 5 | QPSK | 1 | 24 | 19.04 | 19.12 | 19.07 | | |
| 5 | QPSK | 12 | 0 | 19.22 | 19.27 | 19.24 | 20.00 | 0 |
| 5 | QPSK | 12 | 7 | 19.18 | 19.26 | 19.22 | | |
| 5 | QPSK | 12 | 13 | 19.19 | 19.25 | 19.22 | | |
| 5 | QPSK | 25 | 0 | 19.17 | 19.25 | 19.20 | | |
| 5 | 16QAM | 1 | 0 | 19.34 | 19.38 | 19.39 | 20.00 | 0 |
| 5 | 16QAM | 1 | 12 | 19.35 | 19.40 | 19.39 | | |
| 5 | 16QAM | 1 | 24 | 19.22 | 19.30 | 19.23 | | |
| 5 | 16QAM | 12 | 0 | 19.17 | 19.20 | 19.20 | 20.00 | 0 |
| 5 | 16QAM | 12 | 7 | 19.14 | 19.20 | 19.18 | | |
| 5 | 16QAM | 12 | 13 | 19.15 | 19.20 | 19.17 | | |
| 5 | 16QAM | 25 | 0 | 19.12 | 19.18 | 19.16 | | |



| Channel | | | | 19965 | 20175 | 20385 | Tune-up limit (dBm) | MPR (dB) |
|-----------------|-------|----|----|--------|--------|--------|---------------------|----------|
| Frequency (MHz) | | | | 1711.5 | 1732.5 | 1753.5 | | |
| 3 | QPSK | 1 | 0 | 19.03 | 19.04 | 19.00 | 20.00 | 0 |
| 3 | QPSK | 1 | 8 | 19.05 | 19.07 | 19.04 | | |
| 3 | QPSK | 1 | 14 | 18.98 | 19.01 | 18.97 | | |
| 3 | QPSK | 8 | 0 | 19.16 | 19.14 | 19.12 | 20.00 | 0 |
| 3 | QPSK | 8 | 4 | 19.13 | 19.14 | 19.11 | | |
| 3 | QPSK | 8 | 7 | 19.11 | 19.13 | 19.09 | | |
| 3 | QPSK | 15 | 0 | 19.15 | 19.15 | 19.14 | 20.00 | 0 |
| 3 | 16QAM | 1 | 0 | 19.26 | 19.22 | 19.19 | | |
| 3 | 16QAM | 1 | 8 | 19.27 | 19.26 | 19.21 | | |
| 3 | 16QAM | 1 | 14 | 19.19 | 19.23 | 19.14 | 20.00 | 0 |
| 3 | 16QAM | 8 | 0 | 19.13 | 19.11 | 19.11 | | |
| 3 | 16QAM | 8 | 4 | 19.11 | 19.11 | 19.09 | | |
| 3 | 16QAM | 8 | 7 | 19.10 | 19.09 | 19.06 | 20.00 | 0 |
| 3 | 16QAM | 15 | 0 | 19.11 | 19.10 | 19.08 | | |
| Channel | | | | 19957 | 20175 | 20393 | Tune-up limit (dBm) | MPR (dB) |
| Frequency (MHz) | | | | 1710.7 | 1732.5 | 1754.3 | | |
| 1.4 | QPSK | 1 | 0 | 19.10 | 19.14 | 19.12 | 20.00 | 0 |
| 1.4 | QPSK | 1 | 3 | 19.16 | 19.23 | 19.20 | | |
| 1.4 | QPSK | 1 | 5 | 19.08 | 19.12 | 19.10 | | |
| 1.4 | QPSK | 3 | 0 | 19.19 | 19.25 | 19.23 | | |
| 1.4 | QPSK | 3 | 1 | 19.14 | 19.21 | 19.18 | | |
| 1.4 | QPSK | 3 | 3 | 19.13 | 19.19 | 19.16 | 20.00 | 0 |
| 1.4 | QPSK | 6 | 0 | 19.18 | 19.24 | 19.22 | | |
| 1.4 | 16QAM | 1 | 0 | 19.25 | 19.27 | 19.29 | 20.00 | 0 |
| 1.4 | 16QAM | 1 | 3 | 19.37 | 19.38 | 19.35 | | |
| 1.4 | 16QAM | 1 | 5 | 19.25 | 19.28 | 19.26 | | |
| 1.4 | 16QAM | 3 | 0 | 19.14 | 19.19 | 19.17 | | |
| 1.4 | 16QAM | 3 | 1 | 19.10 | 19.15 | 19.12 | | |
| 1.4 | 16QAM | 3 | 3 | 19.09 | 19.14 | 19.11 | 20.00 | 0 |
| 1.4 | 16QAM | 6 | 0 | 19.19 | 19.25 | 19.22 | | |



<LTE Band 7>

| BW [MHz] | Modulation | RB Size | RB Offset | Power Low Ch. / Freq. | Power Middle Ch. / Freq. | Power High Ch. / Freq. | Tune-up limit (dBm) | MPR (dB) |
|-----------------|------------|---------|-----------|-----------------------|--------------------------|------------------------|---------------------|----------|
| Channel | | | | 20850 | 21100 | 21350 | | |
| Frequency (MHz) | | | | 2510 | 2535 | 2560 | | |
| 20 | QPSK | 1 | 0 | 19.45 | 19.54 | 19.50 | 20.00 | 0 |
| 20 | QPSK | 1 | 49 | 19.44 | 19.52 | 19.49 | | |
| 20 | QPSK | 1 | 99 | 19.43 | 19.51 | 19.46 | | |
| 20 | QPSK | 50 | 0 | 19.52 | 19.59 | 19.53 | 20.00 | 0 |
| 20 | QPSK | 50 | 24 | 19.50 | 19.57 | 19.49 | | |
| 20 | QPSK | 50 | 50 | 19.50 | 19.53 | 19.52 | | |
| 20 | QPSK | 100 | 0 | 19.50 | 19.57 | 19.49 | 20.00 | 0 |
| 20 | 16QAM | 1 | 0 | 19.67 | 19.80 | 19.79 | | |
| 20 | 16QAM | 1 | 49 | 19.71 | 19.80 | 19.79 | | |
| 20 | 16QAM | 1 | 99 | 19.75 | 19.82 | 19.75 | 20.00 | 0 |
| 20 | 16QAM | 50 | 0 | 19.49 | 19.56 | 19.54 | | |
| 20 | 16QAM | 50 | 24 | 19.48 | 19.55 | 19.50 | | |
| 20 | 16QAM | 50 | 50 | 19.51 | 19.58 | 19.53 | 20.00 | 0 |
| 20 | 16QAM | 100 | 0 | 19.48 | 19.55 | 19.49 | | |
| Channel | | | | 20825 | 21100 | 21375 | | |
| Frequency (MHz) | | | | 2507.5 | 2535 | 2562.5 | | |
| 15 | QPSK | 1 | 0 | 19.45 | 19.54 | 19.51 | 20.00 | 0 |
| 15 | QPSK | 1 | 37 | 19.48 | 19.57 | 19.52 | | |
| 15 | QPSK | 1 | 74 | 19.48 | 19.55 | 19.47 | | |
| 15 | QPSK | 36 | 0 | 19.52 | 19.63 | 19.55 | 20.00 | 0 |
| 15 | QPSK | 36 | 20 | 19.53 | 19.62 | 19.53 | | |
| 15 | QPSK | 36 | 39 | 19.52 | 19.61 | 19.54 | | |
| 15 | QPSK | 75 | 0 | 19.52 | 19.60 | 19.54 | 20.00 | 0 |
| 15 | 16QAM | 1 | 0 | 19.67 | 19.79 | 19.82 | | |
| 15 | 16QAM | 1 | 37 | 19.74 | 19.82 | 19.81 | | |
| 15 | 16QAM | 1 | 74 | 19.75 | 19.83 | 19.77 | 20.00 | 0 |
| 15 | 16QAM | 36 | 0 | 19.49 | 19.60 | 19.55 | | |
| 15 | 16QAM | 36 | 20 | 19.51 | 19.60 | 19.53 | | |
| 15 | 16QAM | 36 | 39 | 19.50 | 19.60 | 19.54 | 20.00 | 0 |
| 15 | 16QAM | 75 | 0 | 19.51 | 19.58 | 19.54 | | |



| Channel | | | | 20800 | 21100 | 21400 | Tune-up limit (dBm) | MPR (dB) |
|-----------------|-------|----|----|--------|-------|--------|---------------------|----------|
| Frequency (MHz) | | | | 2505 | 2535 | 2565 | | |
| 10 | QPSK | 1 | 0 | 19.43 | 19.54 | 19.50 | 20.00 | 0 |
| 10 | QPSK | 1 | 25 | 19.48 | 19.56 | 19.48 | | |
| 10 | QPSK | 1 | 49 | 19.42 | 19.53 | 19.45 | | |
| 10 | QPSK | 25 | 0 | 19.50 | 19.57 | 19.52 | 20.00 | 0 |
| 10 | QPSK | 25 | 12 | 19.50 | 19.59 | 19.53 | | |
| 10 | QPSK | 25 | 25 | 19.51 | 19.61 | 19.52 | | |
| 10 | QPSK | 50 | 0 | 19.51 | 19.60 | 19.54 | 20.00 | 0 |
| 10 | 16QAM | 1 | 0 | 19.67 | 19.79 | 19.83 | | |
| 10 | 16QAM | 1 | 25 | 19.72 | 19.84 | 19.81 | | |
| 10 | 16QAM | 1 | 49 | 19.69 | 19.82 | 19.76 | 20.00 | 0 |
| 10 | 16QAM | 25 | 0 | 19.46 | 19.57 | 19.53 | | |
| 10 | 16QAM | 25 | 12 | 19.47 | 19.57 | 19.53 | | |
| 10 | 16QAM | 25 | 25 | 19.49 | 19.60 | 19.52 | 20.00 | 0 |
| 10 | 16QAM | 50 | 0 | 19.49 | 19.60 | 19.55 | | |
| Channel | | | | 20775 | 21100 | 21425 | Tune-up limit (dBm) | MPR (dB) |
| Frequency (MHz) | | | | 2502.5 | 2535 | 2567.5 | | |
| 5 | QPSK | 1 | 0 | 19.35 | 19.52 | 19.87 | 20.00 | 0 |
| 5 | QPSK | 1 | 12 | 18.97 | 19.54 | 19.31 | | |
| 5 | QPSK | 1 | 24 | 19.36 | 19.48 | 19.42 | | |
| 5 | QPSK | 12 | 0 | 19.06 | 19.62 | 19.50 | 20.00 | 0 |
| 5 | QPSK | 12 | 7 | 18.98 | 19.59 | 19.36 | | |
| 5 | QPSK | 12 | 13 | 19.09 | 19.60 | 19.38 | | |
| 5 | QPSK | 25 | 0 | 19.03 | 19.56 | 19.42 | 20.00 | 0 |
| 5 | 16QAM | 1 | 0 | 19.63 | 19.79 | 19.90 | | |
| 5 | 16QAM | 1 | 12 | 19.26 | 19.80 | 19.56 | | |
| 5 | 16QAM | 1 | 24 | 19.62 | 19.75 | 19.86 | 20.00 | 0 |
| 5 | 16QAM | 12 | 0 | 19.08 | 19.60 | 19.50 | | |
| 5 | 16QAM | 12 | 7 | 19.01 | 19.59 | 19.37 | | |
| 5 | 16QAM | 12 | 13 | 19.12 | 19.61 | 19.40 | 20.00 | 0 |
| 5 | 16QAM | 25 | 0 | 19.02 | 19.55 | 19.42 | | |

<TDD LTE SAR Measurement>

TDD LTE configuration setup for SAR measurement

SAR was tested with a fixed periodic duty factor according to the highest transmission duty factor implemented for the device and supported by 3GPP.

- a. 3GPP TS 36.211 section 4.2 for Type 2 Frame Structure and Table 4.2-2 for uplink-downlink configurations
- b. "special subframe S" contains both uplink and downlink transmissions, it has been taken into consideration to determine the transmission duty factor according to the worst case uplink and downlink cyclic prefix requirements for UpPTS
- c. Establishing connections with base station simulators ensure a consistent means for testing SAR and recommended for evaluating SAR. The Anritsu MT8820C (firmware: #22.52#004) was used for LTE output power measurements and SAR testing.

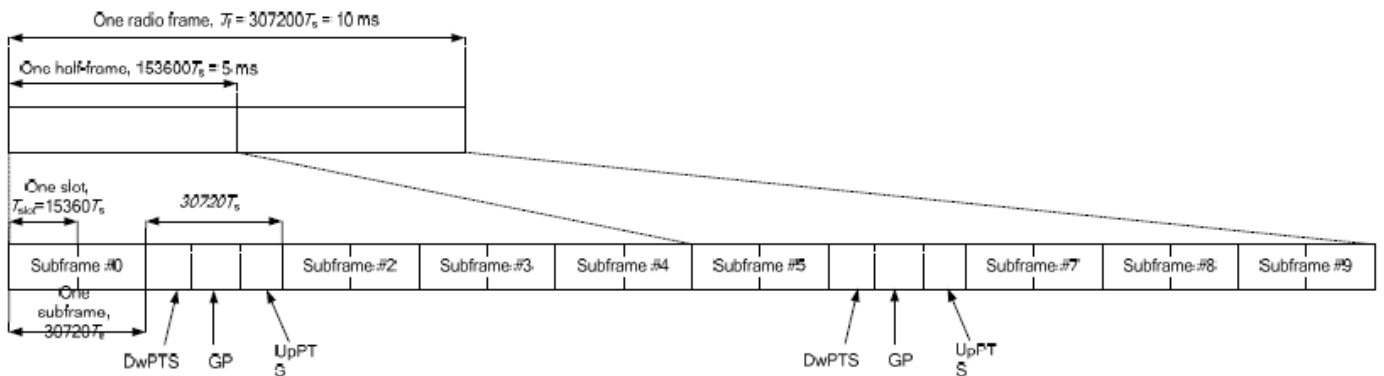

Figure 4.2-1: Frame structure type 2 (for 5 ms switch-point periodicity).

Table 4.2-2: Uplink-downlink configurations.

| Uplink-downlink configuration | Downlink-to-Uplink Switch-point periodicity | Subframe number | | | | | | | | | |
|-------------------------------|---|-----------------|---|---|---|---|---|---|---|---|---|
| | | 0 | 1 | 2 | 3 | 4 | 5 | 6 | 7 | 8 | 9 |
| 0 | 5 ms | D | S | U | U | U | D | S | U | U | U |
| 1 | 5 ms | D | S | U | U | D | D | S | U | U | D |
| 2 | 5 ms | D | S | U | D | D | D | S | U | D | D |
| 3 | 10 ms | D | S | U | U | U | D | D | D | D | D |
| 4 | 10 ms | D | S | U | U | D | D | D | D | D | D |
| 5 | 10 ms | D | S | U | D | D | D | D | D | D | D |
| 6 | 5 ms | D | S | U | U | U | D | S | U | U | D |

Table 4.2-1: Configuration of special subframe (lengths of DwPTS/GP/UpPTS).

| Special subframe configuration | Normal cyclic prefix in downlink | | | Extended cyclic prefix in downlink | | | |
|--------------------------------|----------------------------------|--------------------------------|----------------------------------|------------------------------------|--------------------------------|----------------------------------|---|
| | DwPTS | UpPTS | | DwPTS | UpPTS | | |
| | | Normal cyclic prefix in uplink | Extended cyclic prefix in uplink | | Normal cyclic prefix in uplink | Extended cyclic prefix in uplink | |
| 0 | 6592 · Ts | 2192 · Ts | 2560 · Ts | 7680 · Ts | 2192 · Ts | 2560 · Ts | |
| 1 | 19760 · Ts | | | 20480 · Ts | | | |
| 2 | 21952 · Ts | | | 23040 · Ts | | | |
| 3 | 24144 · Ts | | | 25600 · Ts | | | |
| 4 | 26336 · Ts | | | 7680 · Ts | | | |
| 5 | 6592 · Ts | 4384 · Ts | 5120 · Ts | 20480 · Ts | 4384 · Ts | 5120 · Ts | |
| 6 | 19760 · Ts | | | 23040 · Ts | | | |
| 7 | 21952 · Ts | | | 12800 · Ts | | | |
| 8 | 24144 · Ts | | | - | | | - |
| 9 | 13168 · Ts | | | - | | | - |

| Special subframe (30720·T _s): Normal cyclic prefix in downlink (UpPTS) | | | |
|--|--------------------------------|--------------------------------|----------------------------------|
| | Special subframe configuration | Normal cyclic prefix in uplink | Extended cyclic prefix in uplink |
| Uplink duty factor in one special subframe | 0~4 | 7.13% | 8.33% |
| | 5~9 | 14.3% | 16.7% |

| Special subframe(30720·T _s): Extended cyclic prefix in downlink (UpPTS) | | | |
|---|--------------------------------|--------------------------------|----------------------------------|
| | Special subframe configuration | Normal cyclic prefix in uplink | Extended cyclic prefix in uplink |
| Uplink duty factor in one special subframe | 0~3 | 7.13% | 8.33% |
| | 4~7 | 14.3% | 16.7% |

The highest duty factor is resulted from:

- i. Uplink-downlink configuration: 0. In a half-frame consisted of 5 subframes, uplink operation is in 3 uplink subframes and 1 special subframe.
- ii. special subframe configuration: 5-9 for normal cyclic prefix in downlink, 4-7 for extended cyclic prefix in downlink
- iii. for special subframe with extended cyclic prefix in uplink, the total uplink duty factor in one half-frame is: $(3+0.167)/5 = 63.3\%$
- iv. for special subframe with normal cyclic prefix in uplink, the total uplink duty factor in one half-frame is: $(3+0.143)/5 = 62.9\%$
- v. For TDD LTE SAR measurement, the duty cycle 1:1.59 (62.9 %) was used perform testing and considering the theoretical duty cycle of 63.3% for extended cyclic prefix in the uplink, and the theoretical duty cycle of 62.9% for normal cyclic prefix in uplink, a scaling factor of extended cyclic prefix $63.3\%/62.9\% = 1.006$ is applied to scale-up the measured SAR result. The scaled TDD LTE SAR = measured SAR (W/kg)* Tune-up Scaling Factor* scaling factor for extended cyclic prefix.



<Full Power Mode>

<LTE Band 38>

| BW [MHz] | Modulation | RB Size | RB Offset | Power Low Ch. / Freq. | Power Middle Ch. / Freq. | Power High Ch. / Freq. | Tune-up limit (dBm) | MPR (dB) |
|-----------------|------------|---------|-----------|-----------------------|--------------------------|------------------------|---------------------|----------|
| Channel | | | | 37850 | 38000 | 38150 | | |
| Frequency (MHz) | | | | 2580 | 2595 | 2610 | | |
| 20 | QPSK | 1 | 0 | 23.49 | 23.45 | 23.48 | 24.00 | 0 |
| 20 | QPSK | 1 | 49 | 23.41 | 23.36 | 23.38 | | |
| 20 | QPSK | 1 | 99 | 23.46 | 23.42 | 22.95 | | |
| 20 | QPSK | 50 | 0 | 22.52 | 22.49 | 22.49 | 23.00 | 1 |
| 20 | QPSK | 50 | 24 | 22.50 | 22.47 | 22.45 | | |
| 20 | QPSK | 50 | 50 | 22.49 | 22.48 | 22.28 | | |
| 20 | QPSK | 100 | 0 | 22.50 | 22.47 | 22.03 | 23.00 | 1 |
| 20 | 16QAM | 1 | 0 | 22.53 | 22.51 | 22.09 | | |
| 20 | 16QAM | 1 | 49 | 22.47 | 22.46 | 22.23 | | |
| 20 | 16QAM | 1 | 99 | 22.29 | 22.50 | 22.31 | 22.00 | 2 |
| 20 | 16QAM | 50 | 0 | 21.46 | 21.45 | 21.49 | | |
| 20 | 16QAM | 50 | 24 | 21.44 | 21.45 | 21.46 | | |
| 20 | 16QAM | 50 | 50 | 21.46 | 21.46 | 21.26 | 22.00 | 2 |
| 20 | 16QAM | 100 | 0 | 21.45 | 21.44 | 21.45 | | |
| Channel | | | | 37825 | 38000 | 38175 | | |
| Frequency (MHz) | | | | 2577.5 | 2595 | 2612.5 | | |
| 15 | QPSK | 1 | 0 | 23.44 | 23.45 | 23.46 | 24.00 | 0 |
| 15 | QPSK | 1 | 37 | 23.44 | 23.42 | 23.45 | | |
| 15 | QPSK | 1 | 74 | 23.45 | 23.42 | 23.43 | | |
| 15 | QPSK | 36 | 0 | 22.52 | 22.49 | 22.50 | 23.00 | 1 |
| 15 | QPSK | 36 | 20 | 22.52 | 22.49 | 22.50 | | |
| 15 | QPSK | 36 | 39 | 22.52 | 22.50 | 22.30 | | |
| 15 | QPSK | 75 | 0 | 22.49 | 22.48 | 22.51 | 23.00 | 1 |
| 15 | 16QAM | 1 | 0 | 22.28 | 22.48 | 22.50 | | |
| 15 | 16QAM | 1 | 37 | 22.47 | 22.50 | 22.51 | | |
| 15 | 16QAM | 1 | 74 | 22.46 | 22.46 | 22.50 | 22.00 | 2 |
| 15 | 16QAM | 36 | 0 | 21.20 | 21.39 | 21.41 | | |
| 15 | 16QAM | 36 | 20 | 21.21 | 21.41 | 21.42 | | |
| 15 | 16QAM | 36 | 39 | 21.18 | 21.40 | 21.21 | 22.00 | 2 |
| 15 | 16QAM | 75 | 0 | 21.45 | 21.44 | 21.49 | | |



| Channel | | | | 37800 | 38000 | 38200 | Tune-up limit (dBm) | MPR (dB) |
|-----------------|-------|----|----|--------|-------|--------|---------------------|----------|
| Frequency (MHz) | | | | 2575 | 2595 | 2615 | | |
| 10 | QPSK | 1 | 0 | 23.42 | 23.41 | 23.41 | 24.00 | 0 |
| 10 | QPSK | 1 | 25 | 23.19 | 23.40 | 22.96 | | |
| 10 | QPSK | 1 | 49 | 22.94 | 23.37 | 23.40 | | |
| 10 | QPSK | 25 | 0 | 22.46 | 22.45 | 22.48 | 23.00 | 1 |
| 10 | QPSK | 25 | 12 | 22.23 | 22.44 | 22.25 | | |
| 10 | QPSK | 25 | 25 | 22.23 | 22.45 | 22.07 | | |
| 10 | QPSK | 50 | 0 | 22.24 | 22.49 | 22.52 | | |
| 10 | 16QAM | 1 | 0 | 22.46 | 22.47 | 22.47 | 23.00 | 1 |
| 10 | 16QAM | 1 | 25 | 22.23 | 22.46 | 22.49 | | |
| 10 | 16QAM | 1 | 49 | 22.22 | 22.43 | 22.04 | | |
| 10 | 16QAM | 25 | 0 | 20.96 | 21.41 | 21.48 | 22.00 | 2 |
| 10 | 16QAM | 25 | 12 | 21.20 | 21.41 | 21.23 | | |
| 10 | 16QAM | 25 | 25 | 21.42 | 21.44 | 21.27 | | |
| 10 | 16QAM | 50 | 0 | 21.46 | 21.44 | 21.47 | | |
| Channel | | | | 37775 | 38000 | 38225 | Tune-up limit (dBm) | MPR (dB) |
| Frequency (MHz) | | | | 2572.5 | 2595 | 2617.5 | | |
| 5 | QPSK | 1 | 0 | 23.35 | 23.40 | 23.42 | 24.00 | 0 |
| 5 | QPSK | 1 | 12 | 23.39 | 23.40 | 23.45 | | |
| 5 | QPSK | 1 | 24 | 23.28 | 23.32 | 23.36 | | |
| 5 | QPSK | 12 | 0 | 22.45 | 22.47 | 22.51 | 23.00 | 1 |
| 5 | QPSK | 12 | 7 | 22.45 | 22.46 | 22.50 | | |
| 5 | QPSK | 12 | 13 | 22.47 | 22.47 | 22.51 | | |
| 5 | QPSK | 25 | 0 | 22.46 | 22.44 | 22.48 | 23.00 | 1 |
| 5 | 16QAM | 1 | 0 | 22.42 | 22.45 | 22.51 | | |
| 5 | 16QAM | 1 | 12 | 22.44 | 22.47 | 22.53 | | |
| 5 | 16QAM | 1 | 24 | 22.48 | 22.43 | 22.53 | 22.00 | 2 |
| 5 | 16QAM | 12 | 0 | 21.36 | 21.38 | 21.44 | | |
| 5 | 16QAM | 12 | 7 | 21.36 | 21.38 | 21.44 | | |
| 5 | 16QAM | 12 | 13 | 21.38 | 21.39 | 21.47 | | |
| 5 | 16QAM | 25 | 0 | 21.38 | 21.42 | 21.47 | | |



<WLAN Conducted Power>

General Note:

1. Per KDB 248227 D01v02r02, SAR test reduction is determined according to 802.11 transmission mode configurations and certain exposure conditions with multiple test positions. In the 2.4 GHz band, separate SAR procedures are applied to DSSS and OFDM configurations to simplify DSSS test requirements. For OFDM, in both 2.4 and 5 GHz bands, an initial test configuration must be determined for each standalone and aggregated frequency band, according to the transmission mode configuration with the highest maximum output power specified for production units to perform SAR measurements. If the same highest maximum output power applies to different combinations of channel bandwidths, modulations and data rates, additional procedures are applied to determine which test configurations require SAR measurement. When applicable, an initial test position may be applied to reduce the number of SAR measurements required for next to the ear, UMPC mini-tablet or hotspot mode configurations with multiple test positions.
2. For 2.4 GHz 802.11b DSSS, either the initial test position procedure for multiple exposure test positions or the DSSS procedure for fixed exposure position is applied; these are mutually exclusive. For 2.4 GHz and 5 GHz OFDM configurations, the initial test configuration is applied to measure SAR using either the initial test position procedure for multiple exposure test position configurations or the initial test configuration procedures for fixed exposure test conditions. Based on the reported SAR of the measured configurations and maximum output power of the transmission mode configurations that are not included in the initial test configuration, the subsequent test configuration and initial test position procedures are applied to determine if SAR measurements are required for the remaining OFDM transmission configurations. In general, the number of test channels that require SAR measurement is minimized based on maximum output power measured for the test sample(s).
3. For OFDM transmission configurations in the 2.4 GHz and 5 GHz bands, When the same maximum power is specified for multiple transmission modes in a frequency band, the largest channel bandwidth, lowest order modulation, lowest data rate and lowest order 802.11a/g/n/ac mode is used for SAR measurement, on the highest measured output power channel for each frequency band.
4. DSSS and OFDM configurations are considered separately according to the required SAR procedures. SAR is measured in the initial test position using the 802.11 transmission mode configuration required by the DSSS procedure or initial test configuration and subsequent test configuration(s) according to the OFDM procedures.18 The initial test position procedure is described in the following:
 - a. When the reported SAR of the initial test position is ≤ 0.4 W/kg, further SAR measurement is not required for the other test positions in that exposure configuration and 802.11 transmission mode combinations within the frequency band or aggregated band.
 - b. When the reported SAR of the test position is > 0.4 W/kg, SAR is repeated for the 802.11 transmission mode configuration tested in the initial test position to measure the subsequent next closet/smallest test separation distance and maximum coupling test position on the highest maximum output power channel, until the report SAR is ≤ 0.8 W/kg or all required test position are tested.
 - c. For all positions/configurations, when the reported SAR is > 0.8 W/kg, SAR is measured for these test positions/configurations on the subsequent next highest measured output power channel(s) until the reported SAR is ≤ 1.2 W/kg or all required channels are tested.



<2.4GHz WLAN>

| | Mode | Channel | Frequency (MHz) | Data Rate | Average Power (dBm) | Tune-Up Limit | Duty Cycle % |
|-------------|--------------|---------|-----------------|-----------|---------------------|---------------|--------------|
| 2.4GHz WLAN | 802.11b | CH 1 | 2412 | 1Mbps | 15.55 | 16.50 | 100.00 |
| | | CH 6 | 2437 | | 15.94 | | |
| | | CH 11 | 2462 | | 15.43 | | |
| | 802.11g | CH 1 | 2412 | 6Mbps | 12.81 | 13.00 | 97.22 |
| | | CH 6 | 2437 | | 12.84 | | |
| | | CH 11 | 2462 | | 12.44 | | |
| | 802.11n-HT20 | CH 1 | 2412 | MCS0 | 12.56 | 13.00 | 97.02 |
| | | CH 6 | 2437 | | 12.82 | | |
| | | CH 11 | 2462 | | 12.45 | | |



<5GHz WLAN>

| | Mode | Channel | Frequency (MHz) | Data Rate | Average Power (dBm) | Tune-Up Limit | Duty Cycle % |
|-------------|--------------|---------|-----------------|-----------|---------------------|---------------|--------------|
| 5.2GHz WLAN | 802.11a | CH 36 | 5180 | 6Mbps | 8.62 | 9.5 | 97.22 |
| | | CH 40 | 5200 | | 8.57 | 9.5 | |
| | | CH 44 | 5220 | | 8.58 | 9.5 | |
| | | CH 48 | 5240 | | 8.58 | 9.5 | |
| | 802.11n-HT20 | CH 36 | 5180 | MCS0 | 8.53 | 9.0 | 97.02 |
| | | CH 40 | 5200 | | 8.50 | 9.0 | |
| | | CH 44 | 5220 | | 8.43 | 9.0 | |
| | | CH 48 | 5240 | | 8.48 | 9.0 | |
| | 802.11n-HT40 | CH 38 | 5190 | MCS0 | 8.73 | 9.0 | 94.74 |
| | | CH 46 | 5230 | | 8.72 | 9.0 | |

| | Mode | Channel | Frequency (MHz) | Data Rate | Average Power (dBm) | Tune-Up Limit | Duty Cycle % |
|-------------|--------------|---------|-----------------|-----------|---------------------|---------------|--------------|
| 5.3GHz WLAN | 802.11a | CH 52 | 5260 | 6Mbps | 8.54 | 9.5 | 97.22 |
| | | CH 56 | 5280 | | 8.56 | 9.5 | |
| | | CH 60 | 5300 | | 8.62 | 9.5 | |
| | | CH 64 | 5320 | | 8.72 | 9.5 | |
| | 802.11n-HT20 | CH 52 | 5260 | MCS0 | 8.45 | 9.0 | 97.02 |
| | | CH 56 | 5280 | | 8.53 | 9.0 | |
| | | CH 60 | 5300 | | 8.58 | 9.0 | |
| | | CH 64 | 5320 | | 8.64 | 9.0 | |
| | 802.11n-HT40 | CH 54 | 5270 | MCS0 | 8.59 | 9.0 | 94.74 |
| | | CH 62 | 5310 | | 8.74 | 9.0 | |



| | Mode | Channel | Frequency (MHz) | Data Rate | Average Power (dBm) | Tune-Up Limit | Duty Cycle % |
|-------------|--------------|---------|-----------------|-----------|---------------------|---------------|--------------|
| 5.5GHz WLAN | 802.11a | CH 100 | 5500 | 6Mbps | 8.82 | 9.5 | 97.22 |
| | | CH 116 | 5580 | | 8.64 | 9.5 | |
| | | CH 132 | 5660 | | 8.41 | 9.5 | |
| | | CH 140 | 5700 | | 8.30 | 9.5 | |
| | 802.11n-HT20 | CH 100 | 5500 | MCS0 | 8.88 | 9.0 | 97.02 |
| | | CH 116 | 5580 | | 8.83 | 9.0 | |
| | | CH 132 | 5660 | | 8.40 | 9.0 | |
| | | CH 140 | 5700 | | 8.34 | 9.0 | |
| | 802.11n-HT40 | CH 102 | 5510 | MCS0 | 8.87 | 9.0 | 94.74 |
| | | CH 110 | 5550 | | 8.63 | 9.0 | |
| | | CH 134 | 5670 | | 8.78 | 9.0 | |

| | Mode | Channel | Frequency (MHz) | Data Rate | Average Power (dBm) | Tune-Up Limit | Duty Cycle % |
|-------------|--------------|---------|-----------------|-----------|---------------------|---------------|--------------|
| 5.8GHz WLAN | 802.11a | CH 149 | 5745 | MCS0 | 7.84 | 9.5 | 97.22 |
| | | CH 157 | 5785 | | 8.02 | 9.5 | |
| | | CH 165 | 5825 | | 7.95 | 9.5 | |
| | 802.11n-HT20 | CH 149 | 5745 | MCS0 | 7.82 | 9.0 | 97.02 |
| | | CH 157 | 5785 | | 8.14 | 9.0 | |
| | | CH 165 | 5825 | | 8.04 | 9.0 | |
| | 802.11n-HT40 | CH 151 | 5755 | MCS0 | 8.28 | 9.0 | 94.74 |
| | | CH 159 | 5795 | | 8.27 | 9.0 | |



13. Bluetooth Exclusions Applied

| Mode Band | Average power(dBm) | |
|------------------|--------------------|----------------------------|
| | Bluetooth v3.0+EDR | Bluetooth v4.0 /4.1/4.2 LE |
| 2.4GHz Bluetooth | 8.0 | 0 |

Note:

- Per KDB 447498 D01v06, the 1-g and 10-g SAR test exclusion thresholds for 100 MHz to 6 GHz at *test separation distances* ≤ 50 mm are determined by:

$$[(\text{max. power of channel, including tune-up tolerance, mW}) / (\text{min. test separation distance, mm})] \cdot [\sqrt{f(\text{GHz})}] \leq 3.0$$
for 1-g SAR and ≤ 7.5 for 10-g extremity SAR
 - f(GHz) is the RF channel transmit frequency in GHz
 - Power and distance are rounded to the nearest mW and mm before calculation
 - The result is rounded to one decimal place for comparison

| Bluetooth Max Power (dBm) | Separation Distance (mm) | Frequency (GHz) | exclusion thresholds |
|---------------------------|--------------------------|-----------------|----------------------|
| 8.0 | 15 | 2.48 | 0.6 |

Note:

Per KDB 447498 D01v06, the test exclusion threshold is 0.6 which is <= 3, SAR testing is not required.

14. Antenna Location

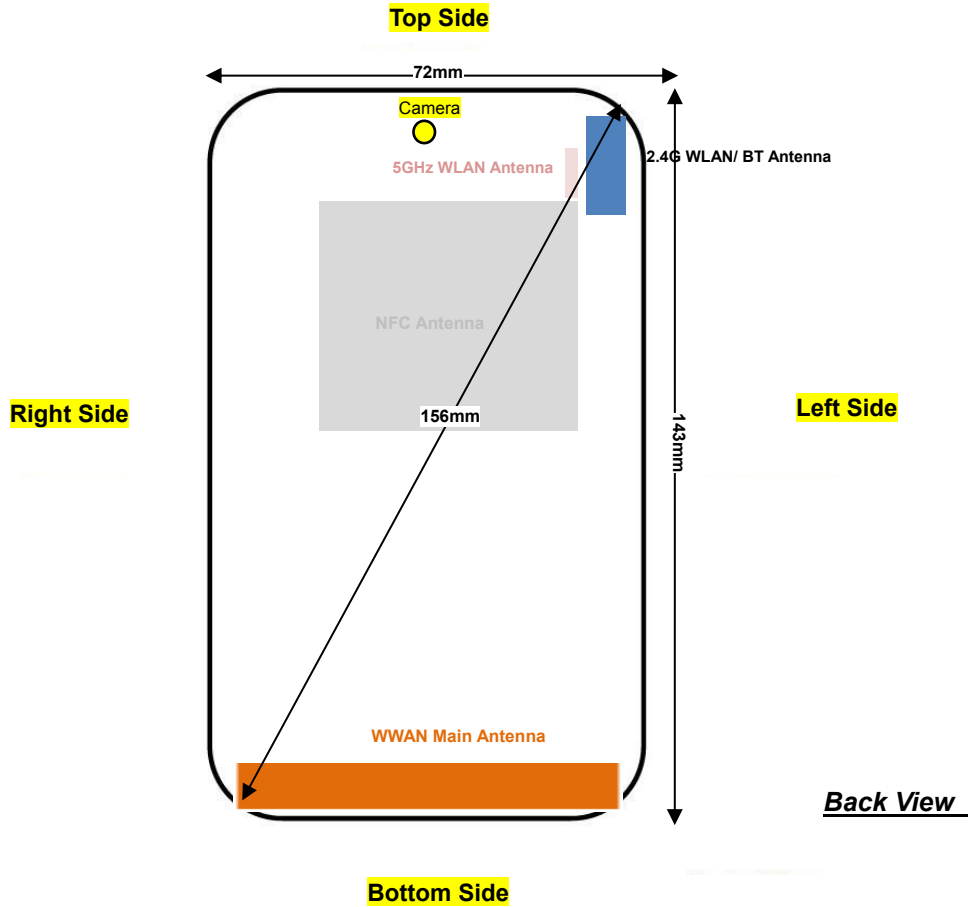

| Distance of the Antenna to the EUT surface/edge | | | | | | |
|---|--------|--------|----------|-------------|------------|-----------|
| Antennas | Back | Front | Top Side | Bottom Side | Right Side | Left Side |
| WWAN Main Antenna | ≤ 25mm | ≤ 25mm | >25mm | ≤ 25mm | ≤ 25mm | ≤ 25mm |
| 2.4GHz WLAN/BT Antenna | ≤ 25mm | ≤ 25mm | ≤ 25mm | >25mm | >25mm | ≤ 25mm |

| Positions for SAR tests; Hotspot mode | | | | | | |
|---------------------------------------|------|-------|----------|-------------|------------|-----------|
| Antennas | Back | Front | Top Side | Bottom Side | Right Side | Left Side |
| WWAN Main Antenna | Yes | Yes | No | Yes | Yes | Yes |
| 2.4GHz WLAN/BT Antenna | Yes | Yes | Yes | No | No | Yes |

General Note:

Referring to KDB 941225 D06 v02r01, when the overall device length and width are ≥ 9cm*5cm, the test distance is 10 mm. SAR must be measured for all sides and surfaces with a transmitting antenna located within 25mm from that surface or edge.



15. SAR Test Results

General Note:

1. Per KDB 447498 D01v06, the reported SAR is the measured SAR value adjusted for maximum tune-up tolerance.
 - a. Tune-up scaling Factor = tune-up limit power (mW) / EUT RF power (mW), where tune-up limit is the maximum rated power among all production units.
 - b. For SAR testing of WLAN signal with non-100% duty cycle, the measured SAR is scaled-up by the duty cycle scaling factor which is equal to "1/(duty cycle)"
 - c. For WWAN: Reported SAR(W/kg)= Measured SAR(W/kg)*Tune-up Scaling Factor
 - d. For WLAN: Reported SAR(W/kg)= Measured SAR(W/kg)* Duty Cycle scaling factor * Tune-up scaling factor
 - e. For TDD LTE SAR measurement, the duty cycle 1:1.59 (62.9 %) was used perform testing and considering the theoretical duty cycle of 63.3% for extended cyclic prefix in the uplink, and the theoretical duty cycle of 62.9% for normal cyclic prefix in uplink, a scaling factor of extended cyclic prefix 63.3%/62.9% = 1.006 is applied to scale-up the measured SAR result. The Reported TDD LTE SAR = measured SAR (W/kg)* Tune-up Scaling Factor* scaling factor for extended cyclic prefix.
2. Per KDB 447498 D01v06, for each exposure position, testing of other required channels within the operating mode of a frequency band is not required when the *reported* 1-g or 10-g SAR for the mid-band or highest output power channel is:
 - ≤ 0.8 W/kg or 2.0 W/kg, for 1-g or 10-g respectively, when the transmission band is ≤ 100 MHz
 - ≤ 0.6 W/kg or 1.5 W/kg, for 1-g or 10-g respectively, when the transmission band is between 100 MHz and 200 MHz
 - ≤ 0.4 W/kg or 1.0 W/kg, for 1-g or 10-g respectively, when the transmission band is ≥ 200 MHz
3. Per KDB 865664 D01v01r04, for each frequency band, repeated SAR measurement is required only when the measured SAR is ≥ 0.8 W/kg.
4. When hotspot mode is enabled, power reduction will be activated and limited to GSM1900, WCDMA Band IV/II, LTE Band 2/4/7.
5. Per KDB 648474 D04v01r03, when the reported SAR for a body-worn accessory measured without a headset connected to the handset is ≤ 1.2 W/kg, SAR testing with a headset connected to the handset is not required.

GSM Note:

1. Per KDB 941225 D01v03r01, for SAR test reduction for GSM / GPRS / EDGE modes is determined by the source-based time-averaged output power including tune-up tolerance. The mode with highest specified time-averaged output power should be tested for SAR compliance in the applicable exposure conditions. For modes with the same specified maximum output power and tolerance, the higher number time-slot configuration should be tested. Therefore, the GPRS (4Tx slots) for GSM850/GSM1900 is considered as the primary mode.
2. Other configurations of GSM / GPRS / EDGE are considered as secondary modes. The 3G SAR test reduction procedure is applied, when the maximum output power and tune-up tolerance specified for production units in a secondary mode is $\leq 1/4$ dB higher than the primary mode, SAR measurement is not required for the secondary mode.
3. Power reduction which is triggered by hotspot mode is implemented in GSM1900 band, for hotspot mode SAR testing EUT was set in reduced power mode and GPRS (3Tx slots) due to its highest frame-average power.

UMTS Note:

1. Per KDB 941225 D01v03r01, for SAR testing is measured using a 12.2 kbps RMC with TPC bits configured to all "1's".
2. Per KDB 941225 D01v03r01, RMC 12.2kbps setting is used to evaluate SAR. If the maximum output power and tune-up tolerance specified for production units in HSDPA / HSUPA / DC-HSDPA /HSPA+ is $\leq 1/4$ dB higher than RMC 12.2Kbps or when the highest reported SAR of the RMC12.2Kbps is scaled by the ratio of specified maximum output power and tune-up tolerance of HSDPA / HSUPA / DC-HSDPA/HSPA+ to RMC12.2Kbps and the adjusted SAR is ≤ 1.2 W/kg, SAR measurement is not required for HSDPA / HSUPA / DC-HSDPA/HSPA+.

LTE Note:

1. Per KDB 941225 D05v02r05, start with the largest channel bandwidth and measure SAR for QPSK with 1 RB allocation, using the RB offset and required test channel combination with the highest maximum output power for RB offsets at the upper edge, middle and lower edge of each required test channel.
2. Per KDB 941225 D05v02r05, 50% RB allocation for QPSK SAR testing follows 1RB QPSK allocation procedure.
3. Per KDB 941225 D05v02r05, For QPSK with 100% RB allocation, SAR is not required when the highest maximum output power for 100 % RB allocation is less than the highest maximum output power in 50% and 1 RB allocations and the highest reported SAR for 1 RB and 50% RB allocation are ≤ 0.8 W/kg. Otherwise, SAR is measured for the highest output power channel; and if the reported SAR is > 1.45 W/kg, the remaining required test channels must also be tested.
4. Per KDB 941225 D05v02r05, 16QAM output power for each RB allocation configuration is $>$ not $\frac{1}{2}$ dB higher than the same configuration in QPSK and the reported SAR for the QPSK configuration is ≤ 1.45 W/kg; Per KDB 941225 D05v02r05, 16QAM SAR testing is not required.
5. Per KDB 941225 D05v02r05, Smaller bandwidth output power for each RB allocation configuration is $>$ not $\frac{1}{2}$ dB higher than the same configuration in the largest supported bandwidth, and the reported SAR for the largest supported bandwidth is ≤ 1.45 W/kg; Per KDB 941225 D05v02r05, smaller bandwidth SAR testing is not required.
6. For LTE B4 / B12 / B38 the maximum bandwidth does not support three non-overlapping channels, per KDB 941225 D05v02r05, when a device supports overlapping channel assignment in a channel bandwidth configuration, the middle channel of the group of overlapping channels should be selected for testing.
7. LTE band 17 SAR test was covered by Band 12; according to April 2015 TCB workshop, SAR test for overlapping LTE bands can be reduced if
 - a. The maximum output power, including tolerance, for the smaller band is \leq the larger band to qualify for the SAR test exclusion.
 - b. The channel bandwidth and other operating parameters for the smaller band are fully supported by the larger band.

WLAN Note:

1. Per KDB 248227 D01v02r02, for 2.4GHz 802.11g/n SAR testing is not required when the highest reported SAR for DSSS is adjusted by the ratio of OFDM to DSSS specified maximum output power and the adjusted SAR is ≤ 1.2 W/kg.
2. Per KDB 248227 D01v02r02, U-NII-1 SAR testing is not required when the U-NII-2A band highest reported SAR for a test configuration is ≤ 1.2 W/kg, SAR is not required for U-NII-1 band.
3. When the reported SAR of the test position is > 0.4 W/kg, SAR is repeated for the 802.11 transmission mode configuration tested in the initial test position to measure the subsequent next closet/smallest test separation distance and maximum coupling test position on the highest maximum output power channel, until the report SAR is ≤ 0.8 W/kg or all required test position are tested.
4. For all positions / configurations, when the reported SAR is > 0.8 W/kg, SAR is measured for these test positions / configurations on the subsequent next highest measured output power channel(s) until the reported SAR is ≤ 1.2 W/kg or all required channels are tested.
5. During SAR testing the WLAN transmission was verified using a spectrum analyzer.



15.1 Head SAR

<GSM SAR>

| Plot No. | Band | Mode | Test Position | Ch. | Freq. (MHz) | Average Power (dBm) | Tune-Up Limit (dBm) | Tune-up Scaling Factor | Power Drift (dB) | Measured 1g SAR (W/kg) | Reported 1g SAR (W/kg) |
|----------|---------|-----------------|---------------|-----|-------------|---------------------|---------------------|------------------------|------------------|------------------------|------------------------|
| | GSM850 | GPRS 4 Tx slots | Right Cheek | 189 | 836.4 | 29.59 | 30 | 1.099 | 0.09 | 0.373 | 0.410 |
| | GSM850 | GPRS 4 Tx slots | Right Tilted | 189 | 836.4 | 29.59 | 30 | 1.099 | 0.1 | 0.397 | 0.436 |
| 01 | GSM850 | GPRS 4 Tx slots | Left Cheek | 189 | 836.4 | 29.59 | 30 | 1.099 | 0.13 | 0.439 | 0.482 |
| | GSM850 | GPRS 4 Tx slots | Left Tilted | 189 | 836.4 | 29.59 | 30 | 1.099 | 0.02 | 0.330 | 0.363 |
| | GSM1900 | GPRS 4 Tx slots | Right Cheek | 810 | 1909.8 | 27.01 | 27.50 | 1.119 | 0.18 | 0.097 | 0.109 |
| | GSM1900 | GPRS 4 Tx slots | Right Tilted | 810 | 1909.8 | 27.01 | 27.50 | 1.119 | 0.16 | 0.019 | 0.021 |
| 02 | GSM1900 | GPRS 4 Tx slots | Left Cheek | 810 | 1909.8 | 27.01 | 27.50 | 1.119 | 0.03 | 0.136 | 0.152 |
| | GSM1900 | GPRS 4 Tx slots | Left Tilted | 810 | 1909.8 | 27.01 | 27.50 | 1.119 | 0.12 | 0.049 | 0.055 |

<WCDMA SAR>

| Plot No. | Band | Mode | Test Position | Ch. | Freq. (MHz) | Average Power (dBm) | Tune-Up Limit (dBm) | Tune-up Scaling Factor | Power Drift (dB) | Measured 1g SAR (W/kg) | Reported 1g SAR (W/kg) |
|----------|---------------|--------------|---------------|------|-------------|---------------------|---------------------|------------------------|------------------|------------------------|------------------------|
| | WCDMA Band V | RMC 12.2Kbps | Right Cheek | 4233 | 846.6 | 24.18 | 24.50 | 1.076 | 0.06 | 0.231 | 0.249 |
| | WCDMA Band V | RMC 12.2Kbps | Right Tilted | 4233 | 846.6 | 24.18 | 24.50 | 1.076 | 0.08 | 0.244 | 0.263 |
| 03 | WCDMA Band V | RMC 12.2Kbps | Left Cheek | 4233 | 846.6 | 24.18 | 24.50 | 1.076 | 0.07 | 0.329 | 0.354 |
| | WCDMA Band V | RMC 12.2Kbps | Left Tilted | 4233 | 846.6 | 24.18 | 24.50 | 1.076 | -0.02 | 0.270 | 0.291 |
| 04 | WCDMA Band IV | RMC 12.2Kbps | Right Cheek | 1312 | 1712.4 | 23.84 | 24.50 | 1.164 | -0.02 | 0.297 | 0.346 |
| | WCDMA Band IV | RMC 12.2Kbps | Right Tilted | 1312 | 1712.4 | 23.84 | 24.50 | 1.164 | 0.03 | 0.087 | 0.101 |
| | WCDMA Band IV | RMC 12.2Kbps | Left Cheek | 1312 | 1712.4 | 23.84 | 24.50 | 1.164 | 0.19 | 0.260 | 0.303 |
| | WCDMA Band IV | RMC 12.2Kbps | Left Tilted | 1312 | 1712.4 | 23.84 | 24.50 | 1.164 | 0.11 | 0.151 | 0.176 |
| | WCDMA Band II | RMC 12.2Kbps | Right Cheek | 9538 | 1907.6 | 24.43 | 25.00 | 1.140 | 0.04 | 0.141 | 0.161 |
| | WCDMA Band II | RMC 12.2Kbps | Right Tilted | 9538 | 1907.6 | 24.43 | 25.00 | 1.140 | 0.07 | 0.030 | 0.034 |
| 05 | WCDMA Band II | RMC 12.2Kbps | Left Cheek | 9538 | 1907.6 | 24.43 | 25.00 | 1.140 | 0.14 | 0.193 | 0.220 |
| | WCDMA Band II | RMC 12.2Kbps | Left Tilted | 9538 | 1907.6 | 24.43 | 25.00 | 1.140 | 0.02 | 0.073 | 0.083 |



<LTE SAR>

| Plot No. | Band | BW (MHz) | Modulation | RB Size | RB offset | Test Position | Ch. | Freq. (MHz) | Average Power (dBm) | Tune-Up Limit (dBm) | Tune-up Scaling Factor | Power Drift (dB) | Measured 1g SAR (W/kg) | Reported 1g SAR (W/kg) |
|----------|-------------|----------|------------|---------|-----------|---------------|-------|-------------|---------------------|---------------------|------------------------|------------------|------------------------|------------------------|
| 06 | LTE Band 12 | 10M | QPSK | 1RB | 0Offset | Right Cheek | 23095 | 707.5 | 22.38 | 24.00 | 1.452 | 0.19 | 0.185 | 0.269 |
| | LTE Band 12 | 10M | QPSK | 25RB | 0Offset | Right Cheek | 23095 | 707.5 | 21.39 | 23.00 | 1.449 | 0.11 | 0.146 | 0.212 |
| | LTE Band 12 | 10M | QPSK | 1RB | 0Offset | Right Tilted | 23095 | 707.5 | 22.38 | 24.00 | 1.452 | 0.14 | 0.153 | 0.222 |
| | LTE Band 12 | 10M | QPSK | 25RB | 0Offset | Right Tilted | 23095 | 707.5 | 21.39 | 23.00 | 1.449 | 0.14 | 0.125 | 0.181 |
| | LTE Band 12 | 10M | QPSK | 1RB | 0Offset | Left Cheek | 23095 | 707.5 | 22.38 | 24.00 | 1.452 | 0.16 | 0.158 | 0.229 |
| | LTE Band 12 | 10M | QPSK | 25RB | 0Offset | Left Cheek | 23095 | 707.5 | 21.39 | 23.00 | 1.449 | 0.12 | 0.125 | 0.181 |
| | LTE Band 12 | 10M | QPSK | 1RB | 0Offset | Left Tilted | 23095 | 707.5 | 22.38 | 24.00 | 1.452 | 0.11 | 0.108 | 0.157 |
| | LTE Band 12 | 10M | QPSK | 25RB | 0Offset | Left Tilted | 23095 | 707.5 | 21.39 | 23.00 | 1.449 | -0.06 | 0.086 | 0.125 |
| 07 | LTE Band 4 | 20M | QPSK | 1RB | 0Offset | Right Cheek | 20175 | 1732.5 | 24.16 | 24.5 | 1.081 | -0.06 | 0.291 | 0.315 |
| | LTE Band 4 | 20M | QPSK | 50RB | 0Offset | Right Cheek | 20175 | 1732.5 | 23.21 | 23.5 | 1.069 | 0.15 | 0.277 | 0.296 |
| | LTE Band 4 | 20M | QPSK | 1RB | 0Offset | Right Tilted | 20175 | 1732.5 | 24.16 | 24.5 | 1.081 | 0.06 | 0.142 | 0.154 |
| | LTE Band 4 | 20M | QPSK | 50RB | 0Offset | Right Tilted | 20175 | 1732.5 | 23.21 | 23.5 | 1.069 | 0.16 | 0.106 | 0.113 |
| | LTE Band 4 | 20M | QPSK | 1RB | 0Offset | Left Cheek | 20175 | 1732.5 | 24.16 | 24.5 | 1.081 | 0.11 | 0.244 | 0.264 |
| | LTE Band 4 | 20M | QPSK | 50RB | 0Offset | Left Cheek | 20175 | 1732.5 | 23.21 | 23.5 | 1.069 | -0.01 | 0.195 | 0.208 |
| | LTE Band 4 | 20M | QPSK | 1RB | 0Offset | Left Tilted | 20175 | 1732.5 | 24.16 | 24.5 | 1.081 | 0.03 | 0.161 | 0.174 |
| | LTE Band 4 | 20M | QPSK | 50RB | 0Offset | Left Tilted | 20175 | 1732.5 | 23.21 | 23.5 | 1.069 | -0.06 | 0.131 | 0.140 |
| 08 | LTE Band 2 | 20M | QPSK | 1RB | 0Offset | Right Cheek | 18700 | 1860 | 23.47 | 24.5 | 1.268 | 0.03 | 0.206 | 0.261 |
| | LTE Band 2 | 20M | QPSK | 50RB | 0Offset | Right Cheek | 18700 | 1860 | 22.5 | 23.5 | 1.259 | 0.06 | 0.159 | 0.200 |
| | LTE Band 2 | 20M | QPSK | 1RB | 0Offset | Right Tilted | 18700 | 1860 | 23.47 | 24.5 | 1.268 | 0.14 | 0.047 | 0.060 |
| | LTE Band 2 | 20M | QPSK | 50RB | 0Offset | Right Tilted | 18700 | 1860 | 22.5 | 23.5 | 1.259 | -0.04 | 0.037 | 0.047 |
| | LTE Band 2 | 20M | QPSK | 1RB | 0Offset | Left Cheek | 18700 | 1860 | 23.47 | 24.5 | 1.268 | 0.14 | 0.188 | 0.238 |
| | LTE Band 2 | 20M | QPSK | 50RB | 0Offset | Left Cheek | 18700 | 1860 | 22.5 | 23.5 | 1.259 | -0.05 | 0.152 | 0.191 |
| | LTE Band 2 | 20M | QPSK | 1RB | 0Offset | Left Tilted | 18700 | 1860 | 23.47 | 24.5 | 1.268 | 0.02 | 0.106 | 0.134 |
| | LTE Band 2 | 20M | QPSK | 50RB | 0Offset | Left Tilted | 18700 | 1860 | 22.5 | 23.5 | 1.259 | -0.14 | 0.084 | 0.106 |
| | LTE Band 7 | 20M | QPSK | 1RB | 0Offset | Right Cheek | 21100 | 2535 | 24.18 | 24.5 | 1.076 | 0.03 | 0.070 | 0.075 |
| | LTE Band 7 | 20M | QPSK | 50RB | 0Offset | Right Cheek | 21100 | 2535 | 23.20 | 23.50 | 1.072 | 0.08 | 0.056 | 0.060 |
| | LTE Band 7 | 20M | QPSK | 1RB | 0Offset | Right Tilted | 21100 | 2535 | 24.18 | 24.5 | 1.076 | 0.06 | 0.022 | 0.024 |
| | LTE Band 7 | 20M | QPSK | 50RB | 0Offset | Right Tilted | 21100 | 2535 | 23.20 | 23.50 | 1.072 | 0.04 | 0.020 | 0.021 |
| 09 | LTE Band 7 | 20M | QPSK | 1RB | 0Offset | Left Cheek | 21100 | 2535 | 24.18 | 24.5 | 1.076 | 0.02 | 0.133 | 0.143 |
| | LTE Band 7 | 20M | QPSK | 50RB | 0Offset | Left Cheek | 21100 | 2535 | 23.20 | 23.50 | 1.072 | -0.19 | 0.105 | 0.113 |
| | LTE Band 7 | 20M | QPSK | 1RB | 0Offset | Left Tilted | 21100 | 2535 | 24.18 | 24.5 | 1.076 | 0.18 | 0.036 | 0.039 |
| | LTE Band 7 | 20M | QPSK | 50RB | 0Offset | Left Tilted | 21100 | 2535 | 23.20 | 23.50 | 1.072 | 0.05 | 0.028 | 0.030 |



| Plot No. | Band | BW (MHz) | Modulation | RB Size | RB offset | Test Position | Ch. | Freq. (MHz) | Average Power (dBm) | Tune-Up Limit (dBm) | Tune-up Scaling Factor | Duty Cycle % | Duty Cycle Scaling Factor | Power Drift (dB) | Measured 1g SAR (W/kg) | Reported 1g SAR (W/kg) |
|----------|-------------|----------|------------|---------|-----------|---------------|-------|-------------|---------------------|---------------------|------------------------|--------------|---------------------------|------------------|------------------------|------------------------|
| | LTE Band 38 | 20M | QPSK | 1RB | 0Offset | Right Cheek | 38000 | 2595 | 23.45 | 24 | 1.135 | 62.9 | 1.006 | 0.09 | 0.027 | 0.031 |
| | LTE Band 38 | 20M | QPSK | 50RB | 0Offset | Right Cheek | 38000 | 2595 | 22.49 | 23 | 1.125 | 62.9 | 1.006 | 0.07 | 0.023 | 0.026 |
| | LTE Band 38 | 20M | QPSK | 1RB | 0Offset | Right Tilted | 38000 | 2595 | 23.45 | 24 | 1.135 | 62.9 | 1.006 | 0.02 | 0.011 | 0.013 |
| | LTE Band 38 | 20M | QPSK | 50RB | 0Offset | Right Tilted | 38000 | 2595 | 22.49 | 23 | 1.125 | 62.9 | 1.006 | 0.18 | 0.008 | 0.008 |
| 10 | LTE Band 38 | 20M | QPSK | 1RB | 0Offset | Left Cheek | 38000 | 2595 | 23.45 | 24 | 1.135 | 62.9 | 1.006 | 0.02 | 0.078 | 0.089 |
| | LTE Band 38 | 20M | QPSK | 50RB | 0Offset | Left Cheek | 38000 | 2595 | 22.49 | 23 | 1.125 | 62.9 | 1.006 | 0.04 | 0.063 | 0.071 |
| | LTE Band 38 | 20M | QPSK | 1RB | 0Offset | Left Tilted | 38000 | 2595 | 23.45 | 24 | 1.135 | 62.9 | 1.006 | 0 | 0.013 | 0.015 |
| | LTE Band 38 | 20M | QPSK | 50RB | 0Offset | Left Tilted | 38000 | 2595 | 22.49 | 23 | 1.125 | 62.9 | 1.006 | 0.09 | 0.010 | 0.011 |

<WLAN 2.4GHz SAR>

| Plot No. | Band | Mode | Test Position | Ch. | Freq. (MHz) | Average Power (dBm) | Tune-Up Limit (dBm) | Tune-up Scaling Factor | Duty Cycle % | Power Drift (dB) | Peak SAR | Measured 1g SAR (W/kg) | Reported 1g SAR (W/kg) |
|----------|-------------|---------------|---------------|-----|-------------|---------------------|---------------------|------------------------|--------------|------------------|----------|------------------------|------------------------|
| 11 | WLAN 2.4GHz | 802.11b 1Mbps | Right Cheek | 6 | 2437 | 15.94 | 16.50 | 1.138 | 100.00 | -0.14 | 1.190 | 0.668 | 0.760 |
| | WLAN 2.4GHz | 802.11b 1Mbps | Right Tilted | 6 | 2437 | 15.94 | 16.50 | 1.138 | 100.00 | 0.09 | 0.840 | 0.556 | 0.633 |
| | WLAN 2.4GHz | 802.11b 1Mbps | Left Cheek | 6 | 2437 | 15.94 | 16.50 | 1.138 | 100.00 | | 0.441 | | |
| | WLAN 2.4GHz | 802.11b 1Mbps | Left Tilted | 6 | 2437 | 15.94 | 16.50 | 1.138 | 100.00 | | 0.520 | | |

<WLAN 5GHz SAR>

| Plot No. | Band | Mode | Test Position | Ch. | Freq. (MHz) | Average Power (dBm) | Tune-Up Limit (dBm) | Tune-up Scaling Factor | Duty Cycle % | Duty Cycle Scaling Factor | Power Drift (dB) | Peak SAR | Measured 1g SAR (W/kg) | Reported 1g SAR (W/kg) |
|----------|-------------|---------------|---------------|-----|-------------|---------------------|---------------------|------------------------|--------------|---------------------------|------------------|----------|------------------------|------------------------|
| 12 | WLAN 5.3GHz | 802.11a 6Mbps | Right Cheek | 64 | 5320 | 8.72 | 9.5 | 1.197 | 97.22 | 1.029 | 0.04 | 0.109 | 0.026 | 0.033 |
| | WLAN 5.3GHz | 802.11a 6Mbps | Right Tilted | 64 | 5320 | 8.72 | 9.5 | 1.197 | 97.22 | 1.029 | | 0.089 | | |
| | WLAN 5.3GHz | 802.11a 6Mbps | Left Cheek | 64 | 5320 | 8.72 | 9.5 | 1.197 | 97.22 | 1.029 | | 0.062 | | |
| | WLAN 5.3GHz | 802.11a 6Mbps | Left Tilted | 64 | 5320 | 8.72 | 9.5 | 1.197 | 97.22 | 1.029 | | 0.085 | | |
| 13 | WLAN 5.5GHz | 802.11a 6Mbps | Right Cheek | 100 | 5500 | 8.82 | 9.5 | 1.265 | 97.22 | 1.029 | 0.08 | 0.180 | 0.035 | 0.042 |
| | WLAN 5.5GHz | 802.11a 6Mbps | Right Tilted | 100 | 5500 | 8.82 | 9.5 | 1.265 | 97.22 | 1.029 | | 0.143 | | |
| | WLAN 5.5GHz | 802.11a 6Mbps | Left Cheek | 100 | 5500 | 8.82 | 9.5 | 1.265 | 97.22 | 1.029 | | 0.058 | | |
| | WLAN 5.5GHz | 802.11a 6Mbps | Left Tilted | 100 | 5500 | 8.82 | 9.5 | 1.265 | 97.22 | 1.029 | | 0.036 | | |
| 14 | WLAN 5.8GHz | 802.11a 6Mbps | Right Cheek | 157 | 5785 | 8.02 | 9.5 | 1.406 | 97.22 | 1.029 | 0.18 | 0.355 | 0.064 | 0.092 |
| | WLAN 5.8GHz | 802.11a 6Mbps | Right Tilted | 157 | 5785 | 8.02 | 9.5 | 1.406 | 97.22 | 1.029 | | 0.316 | | |
| | WLAN 5.8GHz | 802.11a 6Mbps | Left Cheek | 157 | 5785 | 8.02 | 9.5 | 1.406 | 97.22 | 1.029 | | 0.135 | | |
| | WLAN 5.8GHz | 802.11a 6Mbps | Left Tilted | 157 | 5785 | 8.02 | 9.5 | 1.406 | 97.22 | 1.029 | | 0.122 | | |



15.2 Hotspot SAR

<GSM SAR>

| Plot No. | Band | Mode | Test Position | Gap (mm) | Power Reduction | Ch. | Freq. (MHz) | Average Power (dBm) | Tune-Up Limit (dBm) | Tune-up Scaling Factor | Power Drift (dB) | Measured 1g SAR (W/kg) | Reported 1g SAR (W/kg) |
|----------|---------|-----------------|---------------|----------|-----------------|-----|-------------|---------------------|---------------------|------------------------|------------------|------------------------|------------------------|
| | GSM850 | GPRS 4 Tx slots | Front | 10 | Off | 189 | 836.4 | 29.59 | 30 | 1.099 | -0.01 | 0.774 | 0.851 |
| | GSM850 | GPRS 4 Tx slots | Front | 10 | Off | 128 | 824.2 | 29.42 | 30 | 1.143 | 0.1 | 0.723 | 0.826 |
| | GSM850 | GPRS 4 Tx slots | Front | 10 | Off | 251 | 848.8 | 29.58 | 30 | 1.102 | 0.02 | 0.726 | 0.800 |
| | GSM850 | GPRS 4 Tx slots | Back | 10 | Off | 189 | 836.4 | 29.59 | 30 | 1.099 | -0.03 | 0.791 | 0.869 |
| | GSM850 | GPRS 4 Tx slots | Back | 10 | Off | 128 | 824.2 | 29.42 | 30 | 1.143 | 0.04 | 0.789 | 0.902 |
| | GSM850 | GPRS 4 Tx slots | Back | 10 | Off | 251 | 848.8 | 29.58 | 30 | 1.102 | -0.04 | 0.798 | 0.879 |
| 15 | GSM850 | GPRS 4 Tx slots | Left Side | 10 | Off | 189 | 836.4 | 29.59 | 30 | 1.099 | 0.03 | 1.060 | 1.165 |
| | GSM850 | GPRS 4 Tx slots | Left Side | 10 | Off | 128 | 824.2 | 29.42 | 30 | 1.143 | 0.06 | 1.010 | 1.154 |
| | GSM850 | GPRS 4 Tx slots | Left Side | 10 | Off | 251 | 848.8 | 29.58 | 30 | 1.102 | 0.06 | 1.040 | 1.146 |
| | GSM850 | GPRS 4 Tx slots | Right Side | 10 | Off | 189 | 836.4 | 29.59 | 30 | 1.099 | 0.05 | 0.358 | 0.393 |
| | GSM850 | GPRS 4 Tx slots | Bottom Side | 10 | Off | 189 | 836.4 | 29.59 | 30 | 1.099 | -0.02 | 0.345 | 0.379 |
| | GSM1900 | GPRS 3 Tx slots | Front | 10 | ON | 810 | 1909.8 | 26.52 | 27 | 1.117 | -0.07 | 0.830 | 0.927 |
| | GSM1900 | GPRS 3 Tx slots | Front | 10 | ON | 512 | 1850.2 | 26.1 | 27 | 1.230 | 0.11 | 0.677 | 0.833 |
| | GSM1900 | GPRS 3 Tx slots | Front | 10 | ON | 661 | 1880 | 26.17 | 27 | 1.211 | -0.06 | 0.745 | 0.902 |
| | GSM1900 | GPRS 3 Tx slots | Back | 10 | ON | 810 | 1909.8 | 26.52 | 27 | 1.117 | -0.05 | 0.764 | 0.853 |
| | GSM1900 | GPRS 3 Tx slots | Back | 10 | ON | 512 | 1850.2 | 26.1 | 27 | 1.230 | 0.02 | 0.709 | 0.872 |
| | GSM1900 | GPRS 3 Tx slots | Back | 10 | ON | 661 | 1880 | 26.17 | 27 | 1.211 | -0.05 | 0.749 | 0.907 |
| | GSM1900 | GPRS 3 Tx slots | Left Side | 10 | ON | 810 | 1909.8 | 26.52 | 27 | 1.117 | 0.12 | 0.205 | 0.229 |
| | GSM1900 | GPRS 3 Tx slots | Right Side | 10 | ON | 810 | 1909.8 | 26.52 | 27 | 1.117 | 0.14 | 0.012 | 0.013 |
| | GSM1900 | GPRS 3 Tx slots | Bottom Side | 10 | ON | 810 | 1909.8 | 26.52 | 27 | 1.117 | 0.04 | 0.885 | 0.988 |
| 16 | GSM1900 | GPRS 3 Tx slots | Bottom Side | 10 | ON | 512 | 1850.2 | 26.1 | 27 | 1.230 | 0.17 | 0.966 | 1.188 |
| | GSM1900 | GPRS 3 Tx slots | Bottom Side | 10 | ON | 661 | 1880 | 26.17 | 27 | 1.211 | 0.01 | 0.918 | 1.111 |



<WCDMA SAR>

| Plot No. | Band | Mode | Test Position | Gap (mm) | Power Reduction | Ch. | Freq. (MHz) | Average Power (dBm) | Tune-Up Limit (dBm) | Tune-up Scaling Factor | Power Drift (dB) | Measured 1g SAR (W/kg) | Reported 1g SAR (W/kg) |
|----------|---------------|--------------|---------------|----------|-----------------|------|-------------|---------------------|---------------------|------------------------|------------------|------------------------|------------------------|
| | WCDMA Band V | RMC 12.2Kbps | Front | 10 | OFF | 4233 | 846.6 | 24.18 | 24.5 | 1.076 | 0.12 | 0.525 | 0.565 |
| | WCDMA Band V | RMC 12.2Kbps | Back | 10 | OFF | 4233 | 846.6 | 24.18 | 24.5 | 1.076 | 0.06 | 0.617 | 0.664 |
| 17 | WCDMA Band V | RMC 12.2Kbps | Left Side | 10 | OFF | 4233 | 846.6 | 24.18 | 24.5 | 1.076 | 0.07 | 0.651 | 0.701 |
| | WCDMA Band V | RMC 12.2Kbps | Right Side | 10 | OFF | 4233 | 846.6 | 24.18 | 24.5 | 1.076 | 0.06 | 0.135 | 0.145 |
| | WCDMA Band V | RMC 12.2Kbps | Bottom Side | 10 | OFF | 4233 | 846.6 | 24.18 | 24.5 | 1.076 | 0.08 | 0.268 | 0.288 |
| | WCDMA Band IV | RMC 12.2Kbps | Front | 10 | ON | 1312 | 1712.4 | 18.97 | 20 | 1.268 | 0.04 | 0.525 | 0.666 |
| | WCDMA Band IV | RMC 12.2Kbps | Back | 10 | ON | 1312 | 1712.4 | 18.97 | 20 | 1.268 | -0.02 | 0.491 | 0.622 |
| | WCDMA Band IV | RMC 12.2Kbps | Left Side | 10 | ON | 1312 | 1712.4 | 18.97 | 20 | 1.268 | 0.09 | 0.100 | 0.127 |
| | WCDMA Band IV | RMC 12.2Kbps | Right Side | 10 | ON | 1312 | 1712.4 | 18.97 | 20 | 1.268 | 0.05 | 0.074 | 0.094 |
| 18 | WCDMA Band IV | RMC 12.2Kbps | Bottom Side | 10 | ON | 1312 | 1712.4 | 18.97 | 20 | 1.268 | 0.18 | 0.876 | 1.110 |
| | WCDMA Band IV | RMC 12.2Kbps | Bottom Side | 10 | ON | 1413 | 1732.6 | 18.96 | 20 | 1.271 | 0.16 | 0.861 | 1.094 |
| | WCDMA Band IV | RMC 12.2Kbps | Bottom Side | 10 | ON | 1513 | 1752.6 | 18.95 | 20 | 1.274 | -0.11 | 0.842 | 1.072 |
| | WCDMA Band II | RMC 12.2Kbps | Front | 10 | ON | 9538 | 1907.6 | 19.76 | 20.5 | 1.186 | -0.05 | 0.494 | 0.586 |
| | WCDMA Band II | RMC 12.2Kbps | Back | 10 | ON | 9538 | 1907.6 | 19.76 | 20.5 | 1.186 | -0.1 | 0.465 | 0.551 |
| | WCDMA Band II | RMC 12.2Kbps | Left Side | 10 | ON | 9538 | 1907.6 | 19.76 | 20.5 | 1.186 | -0.1 | 0.146 | 0.173 |
| | WCDMA Band II | RMC 12.2Kbps | Right Side | 10 | ON | 9538 | 1907.6 | 19.76 | 20.5 | 1.186 | -0.08 | 0.008 | 0.010 |
| | WCDMA Band II | RMC 12.2Kbps | Bottom Side | 10 | ON | 9538 | 1907.6 | 19.76 | 20.5 | 1.186 | 0.1 | 0.681 | 0.808 |
| 19 | WCDMA Band II | RMC 12.2Kbps | Bottom Side | 10 | ON | 9262 | 1852.4 | 19.66 | 20.5 | 1.213 | 0.14 | 0.845 | 1.025 |
| | WCDMA Band II | RMC 12.2Kbps | Bottom Side | 10 | ON | 9400 | 1880 | 19.64 | 20.5 | 1.219 | 0.04 | 0.713 | 0.869 |



<FDD LTE SAR>

| Plot No. | Band | BW (MHz) | Modulation | RB Size | RB offset | Test Position | Gap (mm) | Power Reduction | Ch. | Freq. (MHz) | Average Power (dBm) | Tune-Up Limit (dBm) | Tune-up Scaling Factor | Power Drift (dB) | Measured 1g SAR (W/kg) | Reported 1g SAR (W/kg) |
|------------|-------------|----------|------------|---------|-------------|---------------|----------|-----------------|-------|-------------|---------------------|---------------------|------------------------|------------------|------------------------|------------------------|
| 20 | LTE Band 12 | 10M | QPSK | 1RB | 0Offset | Front | 10 | OFF | 23095 | 707.5 | 22.38 | 24 | 1.452 | 0.09 | 0.326 | 0.473 |
| | LTE Band 12 | 10M | QPSK | 25RB | 0Offset | Front | 10 | OFF | 23095 | 707.5 | 21.39 | 23 | 1.449 | 0.02 | 0.257 | 0.372 |
| | LTE Band 12 | 10M | QPSK | 1RB | 0Offset | Back | 10 | OFF | 23095 | 707.5 | 22.38 | 24 | 1.452 | 0.06 | 0.373 | 0.542 |
| | LTE Band 12 | 10M | QPSK | 25RB | 0Offset | Back | 10 | OFF | 23095 | 707.5 | 21.39 | 23 | 1.449 | 0.03 | 0.274 | 0.397 |
| | LTE Band 12 | 10M | QPSK | 1RB | 0Offset | Left Side | 10 | OFF | 23095 | 707.5 | 22.38 | 24 | 1.452 | 0.04 | 0.284 | 0.412 |
| | LTE Band 12 | 10M | QPSK | 25RB | 0Offset | Left Side | 10 | OFF | 23095 | 707.5 | 21.39 | 23 | 1.449 | -0.01 | 0.232 | 0.336 |
| | LTE Band 12 | 10M | QPSK | 1RB | 0Offset | Right Side | 10 | OFF | 23095 | 707.5 | 22.38 | 24 | 1.452 | -0.02 | 0.290 | 0.421 |
| | LTE Band 12 | 10M | QPSK | 25RB | 0Offset | Right Side | 10 | OFF | 23095 | 707.5 | 21.39 | 23 | 1.449 | -0.01 | 0.230 | 0.333 |
| | LTE Band 12 | 10M | QPSK | 1RB | 0Offset | Bottom Side | 10 | OFF | 23095 | 707.5 | 22.38 | 24 | 1.452 | 0.16 | 0.089 | 0.129 |
| | LTE Band 12 | 10M | QPSK | 25RB | 0Offset | Bottom Side | 10 | OFF | 23095 | 707.5 | 21.39 | 23 | 1.449 | 0.19 | 0.071 | 0.103 |
| 21 | LTE Band 4 | 20M | QPSK | 1RB | 0Offset | Front | 10 | ON | 20175 | 1732.5 | 19.17 | 20 | 1.211 | -0.13 | 0.617 | 0.747 |
| | LTE Band 4 | 20M | QPSK | 50RB | 0Offset | Front | 10 | ON | 20175 | 1732.5 | 19.22 | 20 | 1.197 | -0.16 | 0.627 | 0.750 |
| | LTE Band 4 | 20M | QPSK | 1RB | 0Offset | Back | 10 | ON | 20175 | 1732.5 | 19.17 | 20 | 1.211 | -0.02 | 0.546 | 0.661 |
| | LTE Band 4 | 20M | QPSK | 50RB | 0Offset | Back | 10 | ON | 20175 | 1732.5 | 19.22 | 20 | 1.197 | 0.04 | 0.556 | 0.665 |
| | LTE Band 4 | 20M | QPSK | 1RB | 0Offset | Left Side | 10 | ON | 20175 | 1732.5 | 19.17 | 20 | 1.211 | -0.13 | 0.122 | 0.148 |
| | LTE Band 4 | 20M | QPSK | 50RB | 0Offset | Left Side | 10 | ON | 20175 | 1732.5 | 19.22 | 20 | 1.197 | 0.13 | 0.128 | 0.153 |
| | LTE Band 4 | 20M | QPSK | 1RB | 0Offset | Right Side | 10 | ON | 20175 | 1732.5 | 19.17 | 20 | 1.211 | 0.09 | 0.076 | 0.092 |
| | LTE Band 4 | 20M | QPSK | 50RB | 0Offset | Right Side | 10 | ON | 20175 | 1732.5 | 19.22 | 20 | 1.197 | 0.09 | 0.076 | 0.091 |
| | LTE Band 4 | 20M | QPSK | 1RB | 0Offset | Bottom Side | 10 | ON | 20175 | 1732.5 | 19.17 | 20 | 1.211 | 0.08 | 0.891 | 1.079 |
| | LTE Band 4 | 20M | QPSK | 50RB | 0Offset | Bottom Side | 10 | ON | 20175 | 1732.5 | 19.22 | 20 | 1.197 | 0.17 | 0.939 | 1.124 |
| | LTE Band 4 | 20M | QPSK | 100RB | 0Offset | Bottom Side | 10 | ON | 20175 | 1732.5 | 19.16 | 20 | 1.213 | 0.19 | 0.938 | 1.138 |
| | LTE Band 2 | 20M | QPSK | 1RB | 0Offset | Front | 10 | ON | 18700 | 1860 | 19.93 | 20.5 | 1.140 | -0.15 | 0.562 | 0.641 |
| | LTE Band 2 | 20M | QPSK | 50RB | 0Offset | Front | 10 | ON | 18700 | 1860 | 19.92 | 20.5 | 1.143 | 0.01 | 0.568 | 0.649 |
| | LTE Band 2 | 20M | QPSK | 1RB | 0Offset | Back | 10 | ON | 18700 | 1860 | 19.93 | 20.5 | 1.140 | -0.12 | 0.533 | 0.608 |
| LTE Band 2 | 20M | QPSK | 50RB | 0Offset | Back | 10 | ON | 18700 | 1860 | 19.92 | 20.5 | 1.143 | 0.06 | 0.538 | 0.615 | |
| 22 | LTE Band 2 | 20M | QPSK | 1RB | 0Offset | Left Side | 10 | ON | 18700 | 1860 | 19.93 | 20.5 | 1.140 | 0.04 | 0.201 | 0.229 |
| | LTE Band 2 | 20M | QPSK | 50RB | 0Offset | Left Side | 10 | ON | 18700 | 1860 | 19.92 | 20.5 | 1.143 | -0.17 | 0.203 | 0.232 |
| | LTE Band 2 | 20M | QPSK | 1RB | 0Offset | Right Side | 10 | ON | 18700 | 1860 | 19.93 | 20.5 | 1.140 | 0.09 | 0.031 | 0.035 |
| | LTE Band 2 | 20M | QPSK | 50RB | 0Offset | Right Side | 10 | ON | 18700 | 1860 | 19.92 | 20.5 | 1.143 | -0.08 | 0.030 | 0.034 |
| | LTE Band 2 | 20M | QPSK | 1RB | 0Offset | Bottom Side | 10 | ON | 18700 | 1860 | 19.93 | 20.5 | 1.140 | 0.03 | 0.864 | 0.985 |
| | LTE Band 2 | 20M | QPSK | 1RB | 0Offset | Bottom Side | 10 | ON | 18900 | 1880 | 19.9 | 20.5 | 1.148 | 0.03 | 0.784 | 0.900 |
| | LTE Band 2 | 20M | QPSK | 1RB | 0Offset | Bottom Side | 10 | ON | 19100 | 1900 | 19.8 | 20.5 | 1.175 | 0.01 | 0.720 | 0.846 |
| | LTE Band 2 | 20M | QPSK | 50RB | 0Offset | Bottom Side | 10 | ON | 18700 | 1860 | 19.92 | 20.5 | 1.143 | 0.13 | 0.841 | 0.961 |
| | LTE Band 2 | 20M | QPSK | 50RB | 0Offset | Bottom Side | 10 | ON | 18900 | 1880 | 19.91 | 20.5 | 1.146 | 0.17 | 0.763 | 0.874 |
| | LTE Band 2 | 20M | QPSK | 50RB | 0Offset | Bottom Side | 10 | ON | 19100 | 1900 | 19.91 | 20.5 | 1.146 | 0.13 | 0.723 | 0.828 |
| LTE Band 2 | 20M | QPSK | 100RB | 0Offset | Bottom Side | 10 | ON | 18700 | 1860 | 19.91 | 20.5 | 1.146 | 0.12 | 0.818 | 0.937 | |



| Plot No. | Band | BW (MHz) | Modulation | RB Size | RB offset | Test Position | Gap (mm) | Power Reduction | Ch. | Freq. (MHz) | Average Power (dBm) | Tune-Up Limit (dBm) | Tune-up Scaling Factor | Power Drift (dB) | Measured 1g SAR (W/kg) | Reported 1g SAR (W/kg) |
|----------|------------|----------|------------|---------|-----------|---------------|----------|-----------------|-------|-------------|---------------------|---------------------|------------------------|------------------|------------------------|------------------------|
| | LTE Band 7 | 20M | QPSK | 1RB | 0Offset | Front | 10 | ON | 21100 | 2535 | 19.54 | 20.00 | 1.112 | 0.08 | 0.303 | 0.337 |
| | LTE Band 7 | 20M | QPSK | 50RB | 0Offset | Front | 10 | ON | 21100 | 2535 | 19.59 | 20.00 | 1.099 | 0.08 | 0.305 | 0.335 |
| | LTE Band 7 | 20M | QPSK | 1RB | 0Offset | Back | 10 | ON | 21100 | 2535 | 19.54 | 20.00 | 1.112 | 0.1 | 0.287 | 0.319 |
| | LTE Band 7 | 20M | QPSK | 50RB | 0Offset | Back | 10 | ON | 21100 | 2535 | 19.59 | 20.00 | 1.099 | -0.02 | 0.296 | 0.325 |
| | LTE Band 7 | 20M | QPSK | 1RB | 0Offset | Left Side | 10 | ON | 21100 | 2535 | 19.54 | 20.00 | 1.112 | -0.16 | 0.044 | 0.049 |
| | LTE Band 7 | 20M | QPSK | 50RB | 0Offset | Left Side | 10 | ON | 21100 | 2535 | 19.59 | 20.00 | 1.099 | -0.15 | 0.039 | 0.043 |
| | LTE Band 7 | 20M | QPSK | 1RB | 0Offset | Right Side | 10 | ON | 21100 | 2535 | 19.54 | 20.00 | 1.112 | -0.06 | 0.108 | 0.120 |
| | LTE Band 7 | 20M | QPSK | 50RB | 0Offset | Right Side | 10 | ON | 21100 | 2535 | 19.59 | 20.00 | 1.099 | 0.05 | 0.108 | 0.119 |
| | LTE Band 7 | 20M | QPSK | 1RB | 0Offset | Bottom Side | 10 | ON | 21100 | 2535 | 19.54 | 20.00 | 1.112 | -0.03 | 0.593 | 0.659 |
| 23 | LTE Band 7 | 20M | QPSK | 50RB | 0Offset | Bottom Side | 10 | ON | 21100 | 2535 | 19.59 | 20.00 | 1.099 | -0.07 | 0.601 | 0.661 |

<TDD LTE SAR>

| Plot No. | Band | BW (MHz) | Modulation | RB Size | RB offset | Test Position | Gap (mm) | Power Reduction | Ch. | Freq. (MHz) | Average Power (dBm) | Tune-Up Limit (dBm) | Tune-up Scaling Factor | Duty Cycle % | Duty Cycle Scaling Factor | Power Drift (dB) | Measured 1g SAR (W/kg) | Reported 1g SAR (W/kg) |
|----------|-------------|----------|------------|---------|-----------|---------------|----------|-----------------|-------|-------------|---------------------|---------------------|------------------------|--------------|---------------------------|------------------|------------------------|------------------------|
| | LTE Band 38 | 20M | QPSK | 1RB | 0Offset | Front | 10 | OFF | 38000 | 2595 | 23.45 | 24 | 1.135 | 62.9 | 1.006 | 0.05 | 0.475 | 0.542 |
| | LTE Band 38 | 20M | QPSK | 50RB | 0Offset | Front | 10 | OFF | 38000 | 2595 | 22.49 | 23 | 1.125 | 62.9 | 1.006 | 0.05 | 0.379 | 0.429 |
| | LTE Band 38 | 20M | QPSK | 1RB | 0Offset | Back | 10 | OFF | 38000 | 2595 | 23.45 | 24 | 1.135 | 62.9 | 1.006 | -0.17 | 0.437 | 0.499 |
| | LTE Band 38 | 20M | QPSK | 50RB | 0Offset | Back | 10 | OFF | 38000 | 2595 | 22.49 | 23 | 1.125 | 62.9 | 1.006 | -0.01 | 0.353 | 0.399 |
| | LTE Band 38 | 20M | QPSK | 1RB | 0Offset | Left Side | 10 | OFF | 38000 | 2595 | 23.45 | 24 | 1.135 | 62.9 | 1.006 | 0.14 | 0.065 | 0.074 |
| | LTE Band 38 | 20M | QPSK | 50RB | 0Offset | Left Side | 10 | OFF | 38000 | 2595 | 22.49 | 23 | 1.125 | 62.9 | 1.006 | -0.08 | 0.052 | 0.059 |
| | LTE Band 38 | 20M | QPSK | 1RB | 0Offset | Right Side | 10 | OFF | 38000 | 2595 | 23.45 | 24 | 1.135 | 62.9 | 1.006 | 0.18 | 0.190 | 0.217 |
| | LTE Band 38 | 20M | QPSK | 50RB | 0Offset | Right Side | 10 | OFF | 38000 | 2595 | 22.49 | 23 | 1.125 | 62.9 | 1.006 | -0.04 | 0.152 | 0.172 |
| 24 | LTE Band 38 | 20M | QPSK | 1RB | 0Offset | Bottom Side | 10 | OFF | 38000 | 2595 | 23.45 | 24 | 1.135 | 62.9 | 1.006 | -0.02 | 0.907 | 1.036 |
| | LTE Band 38 | 20M | QPSK | 50RB | 0Offset | Bottom Side | 10 | OFF | 38000 | 2595 | 22.49 | 23 | 1.125 | 62.9 | 1.006 | -0.06 | 0.729 | 0.825 |
| | LTE Band 38 | 20M | QPSK | 100RB | 0Offset | Bottom Side | 10 | OFF | 38000 | 2595 | 22.47 | 23 | 1.130 | 62.9 | 1.006 | -0.04 | 0.724 | 0.823 |

<WLAN 2.4GHz SAR>

| Plot No. | Band | Mode | Test Position | Gap (mm) | Ch. | Freq. (MHz) | Average Power (dBm) | Tune-Up Limit (dBm) | Tune-up Scaling Factor | Duty Cycle % | Power Drift (dB) | Peak SAR | Measured 1g SAR (W/kg) | Reported 1g SAR (W/kg) |
|----------|-------------|---------------|---------------|----------|-----|-------------|---------------------|---------------------|------------------------|--------------|------------------|----------|------------------------|------------------------|
| | WLAN 2.4GHz | 802.11b 1Mbps | Front | 10 | 6 | 2437 | 15.94 | 16.50 | 1.138 | 100.00 | | 0.206 | | |
| | WLAN 2.4GHz | 802.11b 1Mbps | Back | 10 | 6 | 2437 | 15.94 | 16.50 | 1.138 | 100.00 | | 0.229 | | |
| | WLAN 2.4GHz | 802.11b 1Mbps | Left Side | 10 | 6 | 2437 | 15.94 | 16.50 | 1.138 | 100.00 | | 0.120 | | |
| 25 | WLAN 2.4GHz | 802.11b 1Mbps | Top Side | 10 | 6 | 2437 | 15.94 | 16.50 | 1.138 | 100.00 | 0.05 | 0.253 | 0.152 | 0.173 |



15.3 Body Worn Accessory SAR

<GSM SAR>

| Plot No. | Band | Mode | Test Position | Gap (mm) | Ch. | Freq. (MHz) | Average Power (dBm) | Tune-Up Limit (dBm) | Tune-up Scaling Factor | Power Drift (dB) | Measured 1g SAR (W/kg) | Reported 1g SAR (W/kg) |
|----------|---------|-----------------|---------------|----------|-----|-------------|---------------------|---------------------|------------------------|------------------|------------------------|------------------------|
| | GSM850 | GPRS 4 Tx slots | Front | 15 | 189 | 836.4 | 29.59 | 30 | 1.099 | -0.01 | 0.556 | 0.611 |
| 26 | GSM850 | GPRS 4 Tx slots | Back | 15 | 189 | 836.4 | 29.59 | 30 | 1.099 | -0.06 | 0.622 | 0.684 |
| 27 | GSM1900 | GPRS 4 Tx slots | Front | 15 | 810 | 1909.8 | 27.01 | 27.5 | 1.119 | -0.1 | 0.559 | 0.626 |
| | GSM1900 | GPRS 4 Tx slots | Back | 15 | 810 | 1909.8 | 27.01 | 27.5 | 1.119 | -0.12 | 0.516 | 0.578 |

<WCDMA SAR>

| Plot No. | Band | Mode | Test Position | Gap (mm) | Ch. | Freq. (MHz) | Average Power (dBm) | Tune-Up Limit (dBm) | Tune-up Scaling Factor | Power Drift (dB) | Measured 1g SAR (W/kg) | Reported 1g SAR (W/kg) |
|----------|---------------|--------------|---------------|----------|------|-------------|---------------------|---------------------|------------------------|------------------|------------------------|------------------------|
| | WCDMA Band V | RMC 12.2Kbps | Front | 15 | 4233 | 846.6 | 24.18 | 24.5 | 1.076 | 0.05 | 0.397 | 0.427 |
| 28 | WCDMA Band V | RMC 12.2Kbps | Back | 15 | 4233 | 846.6 | 24.18 | 24.5 | 1.076 | 0.04 | 0.438 | 0.471 |
| 29 | WCDMA Band IV | RMC 12.2Kbps | Front | 15 | 1312 | 1712.4 | 23.84 | 24.5 | 1.164 | -0.06 | 0.989 | 1.151 |
| | WCDMA Band IV | RMC 12.2Kbps | Front | 15 | 1413 | 1732.6 | 23.8 | 24.5 | 1.175 | 0.01 | 0.857 | 1.007 |
| | WCDMA Band IV | RMC 12.2Kbps | Front | 15 | 1513 | 1752.6 | 23.83 | 24.5 | 1.167 | -0.05 | 0.770 | 0.898 |
| | WCDMA Band IV | RMC 12.2Kbps | Back | 15 | 1312 | 1712.4 | 23.84 | 24.5 | 1.164 | -0.07 | 0.891 | 1.037 |
| | WCDMA Band IV | RMC 12.2Kbps | Back | 15 | 1413 | 1732.6 | 23.8 | 24.5 | 1.175 | 0.03 | 0.821 | 0.965 |
| | WCDMA Band IV | RMC 12.2Kbps | Back | 15 | 1513 | 1752.6 | 23.83 | 24.5 | 1.167 | -0.04 | 0.740 | 0.863 |
| | WCDMA Band II | RMC 12.2Kbps | Front | 15 | 9538 | 1907.6 | 24.43 | 25 | 1.140 | -0.03 | 0.775 | 0.884 |
| 30 | WCDMA Band II | RMC 12.2Kbps | Front | 15 | 9262 | 1852.4 | 24.38 | 25 | 1.153 | -0.17 | 0.813 | 0.938 |
| | WCDMA Band II | RMC 12.2Kbps | Front | 15 | 9400 | 1880 | 24.27 | 25 | 1.183 | 0.07 | 0.761 | 0.900 |
| | WCDMA Band II | RMC 12.2Kbps | Back | 15 | 9538 | 1907.6 | 24.43 | 25 | 1.140 | -0.01 | 0.703 | 0.802 |
| | WCDMA Band II | RMC 12.2Kbps | Back | 15 | 9262 | 1852.4 | 24.38 | 25 | 1.153 | 0.04 | 0.778 | 0.897 |
| | WCDMA Band II | RMC 12.2Kbps | Back | 15 | 9400 | 1880 | 24.27 | 25 | 1.183 | 0.02 | 0.703 | 0.832 |



<FDD LTE SAR>

| Plot No. | Band | BW (MHz) | Modulation | RB Size | RB offset | Test Position | Gap (mm) | Ch. | Freq. (MHz) | Average Power (dBm) | Tune-Up Limit (dBm) | Tune-up Scaling Factor | Power Drift (dB) | Measured 1g SAR (W/kg) | Reported 1g SAR (W/kg) |
|----------|-------------|----------|------------|---------|-----------|---------------|----------|-------|-------------|---------------------|---------------------|------------------------|------------------|------------------------|------------------------|
| | LTE Band 12 | 10M | QPSK | 1RB | 0Offset | Front | 15 | 23095 | 707.5 | 22.38 | 24 | 1.452 | 0.14 | 0.334 | 0.485 |
| | LTE Band 12 | 10M | QPSK | 25RB | 0Offset | Front | 15 | 23095 | 707.5 | 21.39 | 23 | 1.449 | 0.01 | 0.261 | 0.378 |
| 31 | LTE Band 12 | 10M | QPSK | 1RB | 0Offset | Back | 15 | 23095 | 707.5 | 22.38 | 24 | 1.452 | 0.01 | 0.353 | 0.513 |
| | LTE Band 12 | 10M | QPSK | 25RB | 0Offset | Back | 15 | 23095 | 707.5 | 21.39 | 23 | 1.449 | 0.02 | 0.281 | 0.407 |
| 32 | LTE Band 4 | 20M | QPSK | 1RB | 0Offset | Front | 15 | 20175 | 1732.5 | 24.16 | 24.5 | 1.081 | -0.05 | 0.944 | 1.021 |
| | LTE Band 4 | 20M | QPSK | 50RB | 0Offset | Front | 15 | 20175 | 1732.5 | 23.21 | 23.5 | 1.069 | -0.04 | 0.776 | 0.830 |
| | LTE Band 4 | 20M | QPSK | 100RB | 0Offset | Front | 15 | 20175 | 1732.5 | 23.12 | 23.5 | 1.091 | -0.08 | 0.749 | 0.817 |
| | LTE Band 4 | 20M | QPSK | 1RB | 0Offset | Back | 15 | 20175 | 1732.5 | 24.16 | 24.5 | 1.081 | -0.11 | 0.935 | 1.011 |
| | LTE Band 4 | 20M | QPSK | 50RB | 0Offset | Back | 15 | 20175 | 1732.5 | 23.21 | 23.5 | 1.069 | 0.07 | 0.718 | 0.768 |
| | LTE Band 4 | 20M | QPSK | 100RB | 0Offset | Back | 15 | 20175 | 1732.5 | 23.12 | 23.5 | 1.091 | -0.14 | 0.759 | 0.828 |
| 33 | LTE Band 2 | 20M | QPSK | 1RB | 0Offset | Front | 15 | 18700 | 1860 | 23.47 | 24.5 | 1.268 | -0.08 | 0.649 | 0.823 |
| | LTE Band 2 | 20M | QPSK | 1RB | 0Offset | Front | 15 | 18900 | 1880 | 23.41 | 24.5 | 1.285 | 0.03 | 0.623 | 0.801 |
| | LTE Band 2 | 20M | QPSK | 1RB | 0Offset | Front | 15 | 19100 | 1900 | 23.36 | 24.5 | 1.300 | -0.01 | 0.589 | 0.766 |
| | LTE Band 2 | 20M | QPSK | 50RB | 0Offset | Front | 15 | 18700 | 1860 | 22.5 | 23.5 | 1.259 | 0.06 | 0.536 | 0.675 |
| | LTE Band 2 | 20M | QPSK | 100RB | 0Offset | Front | 15 | 18700 | 1860 | 22.43 | 23.5 | 1.279 | 0.02 | 0.521 | 0.667 |
| | LTE Band 2 | 20M | QPSK | 1RB | 0Offset | Back | 15 | 18700 | 1860 | 23.47 | 24.5 | 1.268 | -0.05 | 0.628 | 0.796 |
| | LTE Band 2 | 20M | QPSK | 50RB | 0Offset | Back | 15 | 18700 | 1860 | 22.5 | 23.5 | 1.259 | 0.04 | 0.532 | 0.670 |
| 34 | LTE Band 7 | 20M | QPSK | 1RB | 0Offset | Front | 15 | 21100 | 2535 | 24.18 | 24.50 | 1.076 | 0.03 | 0.522 | 0.562 |
| | LTE Band 7 | 20M | QPSK | 50RB | 0Offset | Front | 15 | 21100 | 2535 | 23.20 | 23.50 | 1.072 | 0.06 | 0.437 | 0.468 |
| | LTE Band 7 | 20M | QPSK | 1RB | 0Offset | Back | 15 | 21100 | 2535 | 24.18 | 24.50 | 1.076 | 0.08 | 0.472 | 0.508 |
| | LTE Band 7 | 20M | QPSK | 50RB | 0Offset | Back | 15 | 21100 | 2535 | 23.20 | 23.50 | 1.072 | -0.07 | 0.371 | 0.398 |

<TDD LTE SAR>

| Plot No. | Band | BW (MHz) | Modulation | RB Size | RB offset | Test Position | Gap (mm) | Ch. | Freq. (MHz) | Average Power (dBm) | Tune-Up Limit (dBm) | Tune-up Scaling Factor | Duty Cycle % | Duty Cycle Scaling Factor | Power Drift (dB) | Measured 1g SAR (W/kg) | Reported 1g SAR (W/kg) |
|----------|-------------|----------|------------|---------|-----------|---------------|----------|-------|-------------|---------------------|---------------------|------------------------|--------------|---------------------------|------------------|------------------------|------------------------|
| 35 | LTE Band 38 | 20M | QPSK | 1RB | 0Offset | Front | 15 | 38000 | 2595 | 23.45 | 24 | 1.135 | 62.9 | 1.006 | 0.02 | 0.243 | 0.277 |
| | LTE Band 38 | 20M | QPSK | 50RB | 0Offset | Front | 15 | 38000 | 2595 | 22.49 | 23 | 1.125 | 62.9 | 1.006 | -0.04 | 0.195 | 0.221 |
| | LTE Band 38 | 20M | QPSK | 1RB | 0Offset | Back | 15 | 38000 | 2595 | 23.45 | 24 | 1.135 | 62.9 | 1.006 | 0.08 | 0.233 | 0.266 |
| | LTE Band 38 | 20M | QPSK | 50RB | 0Offset | Back | 15 | 38000 | 2595 | 22.49 | 23 | 1.125 | 62.9 | 1.006 | 0.05 | 0.188 | 0.213 |



<WLAN2.4GHz SAR>

| Plot No. | Band | Mode | Test Position | Gap (mm) | Ch. | Freq. (MHz) | Average Power (dBm) | Tune-Up Limit (dBm) | Tune-up Scaling Factor | Duty Cycle % | Power Drift (dB) | Peak SAR | Measured 1g SAR (W/kg) | Reported 1g SAR (W/kg) |
|----------|-------------|---------------|---------------|----------|-----|-------------|---------------------|---------------------|------------------------|--------------|------------------|----------|------------------------|------------------------|
| 36 | WLAN 2.4GHz | 802.11b 1Mbps | Front | 15 | 6 | 2437 | 15.94 | 16.50 | 1.138 | 100.00 | -0.01 | 0.107 | 0.076 | 0.086 |
| | WLAN 2.4GHz | 802.11b 1Mbps | Back | 15 | 6 | 2437 | 15.94 | 16.50 | 1.138 | 100.00 | | 0.087 | | |

<WLAN 5GHz SAR>

| Plot No. | Band | Mode | Test Position | Gap (mm) | Ch. | Freq. (MHz) | Average Power (dBm) | Tune-Up Limit (dBm) | Tune-up Scaling Factor | Duty Cycle % | Duty Cycle Scaling Factor | Power Drift (dB) | Peak SAR | Measured 1g SAR (W/kg) | Reported 1g SAR (W/kg) |
|----------|-------------|---------------|---------------|----------|-----|-------------|---------------------|---------------------|------------------------|--------------|---------------------------|------------------|----------|------------------------|------------------------|
| | WLAN 5.3GHz | 802.11a 6Mbps | Front | 15 | 64 | 5320 | 8.72 | 9.5 | 1.197 | 97.22 | 1.029 | | 0.000189 | | |
| 37 | WLAN 5.3GHz | 802.11a 6Mbps | Back | 15 | 64 | 5320 | 8.72 | 9.5 | 1.197 | 97.22 | 1.029 | 0.06 | 0.00243 | 0.00118 | 0.001 |
| | WLAN 5.5GHz | 802.11a 6Mbps | Front | 15 | 100 | 5500 | 8.82 | 9.5 | 1.169 | 97.22 | 1.029 | | 0.00887 | | |
| 38 | WLAN 5.5GHz | 802.11a 6Mbps | Back | 15 | 100 | 5500 | 8.82 | 9.5 | 1.169 | 97.22 | 1.029 | 0.01 | 0.015 | 0.0042 | 0.005 |
| | WLAN 5.8GHz | 802.11a 6Mbps | Front | 15 | 157 | 5785 | 8.02 | 9.5 | 1.406 | 97.22 | 1.029 | | 0 | | |
| 39 | WLAN 5.8GHz | 802.11a 6Mbps | Back | 15 | 157 | 5785 | 8.02 | 9.5 | 1.406 | 97.22 | 1.029 | 0.1 | 0.017 | 0.00507 | 0.007 |



15.4 Repeated SAR Measurement

| No. | Band | BW (MHz) | RB Size | RB offset | Mode | Test Position | Gap (mm) | Power Reduction | Ch. | Freq. (MHz) | Average Power (dBm) | Tune-Up Limit (dBm) | Tune-up Scaling Factor | Duty Cycle % | Duty Cycle Scaling Factor | Power Drift (dB) | Measured 1g SAR (W/kg) | Ratio | Reported 1g SAR (W/kg) |
|-----|---------------|----------|---------|-----------|-----------------|---------------|----------|-----------------|-------|-------------|---------------------|---------------------|------------------------|--------------|---------------------------|------------------|------------------------|-------|------------------------|
| 1st | GSM850 | - | - | - | GPRS 4 Tx slots | Left Side | 10 | Off | 189 | 836.4 | 29.59 | 30 | 1.099 | - | - | 0.03 | 1.060 | 1 | 1.165 |
| 2nd | GSM850 | - | - | - | GPRS 4 Tx slots | Left Side | 10 | Off | 189 | 836.4 | 29.59 | 30 | 1.099 | - | - | 0.01 | 1.040 | 1.019 | 1.143 |
| 1st | GSM1900 | - | - | - | GPRS 3 Tx slots | Bottom Side | 10 | ON | 512 | 1850.2 | 26.1 | 27 | 1.230 | - | - | 0.17 | 0.966 | 1 | 1.188 |
| 2nd | GSM1900 | - | - | - | GPRS 3 Tx slots | Bottom Side | 10 | ON | 512 | 1850.2 | 26.1 | 27 | 1.230 | - | - | 0.07 | 0.955 | 1.012 | 1.175 |
| 1st | WCDMA Band IV | - | - | - | RMC 12.2Kbps | Front | 15 | - | 1312 | 1712.4 | 23.84 | 24.5 | 1.164 | - | - | -0.06 | 0.989 | 1 | 1.151 |
| 2nd | WCDMA Band IV | - | - | - | RMC 12.2Kbps | Front | 15 | - | 1312 | 1712.4 | 23.84 | 24.5 | 1.164 | - | - | -0.05 | 0.978 | 1.011 | 1.139 |
| 1st | LTE Band 38 | 20M | 1RB | 0Offset | QPSK | Bottom Side | 10 | Off | 38000 | 2595 | 23.45 | 24 | 1.135 | 62.9 | 1.006 | -0.02 | 0.907 | 1 | 1.036 |
| 2nd | LTE Band 38 | 20M | 1RB | 0Offset | QPSK | Bottom Side | 10 | Off | 38000 | 2595 | 23.45 | 24 | 1.135 | 62.9 | 1.006 | -0.01 | 0.901 | 1.007 | 1.029 |

General Note:

1. Per KDB 865664 D01v01r04, for each frequency band, repeated SAR measurement is required only when the measured SAR is $\geq 0.8W/kg$.
2. Per KDB 865664 D01v01r04, if the ratio among the repeated measurement is ≤ 1.2 and the measured SAR $< 1.45W/kg$, only one repeated measurement is required.
3. The ratio is the difference in percentage between original and repeated *measured SAR*.
4. All measurement SAR result is scaled-up to account for tune-up tolerance and is compliant.

16. Simultaneous Transmission Analysis

| NO. | Simultaneous Transmission Configurations | Portable Handset | | | Note |
|-----|--|------------------|-----------|---------|-----------|
| | | Head | Body-worn | Hotspot | |
| 1. | GSM Voice + WLAN2.4GHz | Yes | Yes | | |
| 2. | GPRS/EDGE + WLAN2.4GHz | Yes | Yes | Yes | Hotspot |
| 3. | WCDMA + WLAN2.4GHz | Yes | Yes | Yes | Hotspot |
| 4. | LTE + WLAN2.4GHz | Yes | Yes | Yes | Hotspot |
| 5. | GSM Voice + Bluetooth | | Yes | | |
| 6. | GPRS/EDGE + Bluetooth | | Yes | | WWAN VoIP |
| 7. | WCDMA+ Bluetooth | | Yes | | WWAN VoIP |
| 8. | LTE + Bluetooth | | Yes | | WWAN VoIP |
| 9. | GSM Voice + WLAN5GHz | Yes | Yes | | |
| 10. | GPRS/EDGE + WLAN5GHz | Yes | Yes | | WWAN VoIP |
| 11. | WCDMA + WLAN5GHz | Yes | Yes | | WWAN VoIP |
| 12. | LTE + WLAN5GHz | Yes | Yes | | WWAN VoIP |

General Note:

- This device supports VoIP in GPRS, EGPRS, CDMA, WCDMA and LTE (e.g. for 3rd-party VoIP), LTE supports VoLTE operation.
- EUT will choose each GSM, WCDMA and LTE according to the network signal condition; therefore, they will not operate simultaneously at any moment.
- This device 2.4GHz WLAN supports hotspot operation.
- This device 5GHz WLAN does not support hotspot operation, and 5.2GHz WLAN/5.8GHz WLAN supports WiFi Direct (GC/GO), and 5.3GHz / 5.5GHz supports WiFi Direct (GC only).
- EUT will choose either WLAN 2.4GHz or WLAN 5GHz according to the network signal condition; therefore, 2.4GHz WLAN and 5GHz WLAN will not operate simultaneously at any moment.
- WLAN 2.4GHz and Bluetooth share the same antenna, so can't transmit simultaneously.
- According to the character of EUT, Bluetooth can't transmit with WLAN 5GHz simultaneously.
- Chose the worst zoom scan SAR of WLAN2.4GHz and WLAN 5GHz SAR correspondingly for co-located with WWAN analysis.
- The reported SAR summation is calculated based on the same configuration and test position.
- Per KDB 447498 D01v06, simultaneous transmission SAR is compliant if,
 - Scalar SAR summation < 1.6W/kg.
 - $SPLSR = (SAR1 + SAR2)^{1.5} / (\text{min. separation distance, mm})$, and the peak separation distance is determined from the square root of $[(x1-x2)^2 + (y1-y2)^2 + (z1-z2)^2]$, where (x1, y1, z1) and (x2, y2, z2) are the coordinates of the extrapolated peak SAR locations in the zoom scan.
 - If $SPLSR \leq 0.04$, simultaneously transmission SAR measurement is not necessary.
 - Simultaneously transmission SAR measurement, and the reported multi-band SAR < 1.6W/kg.
- For simultaneous transmission analysis, Bluetooth SAR is estimated per KDB 447498 D01v06 based on the formula below.
 - $(\text{max. power of channel, including tune-up tolerance, mW}) / (\text{min. test separation distance, mm}) \cdot [\sqrt{f(\text{GHz})} / x] \text{ W/kg}$ for test separation distances $\leq 50 \text{ mm}$; where $x = 7.5$ for 1-g SAR, and $x = 18.75$ for 10-g SAR.
 - When the minimum separation distance is < 5mm, the distance is used 5mm to determine SAR test exclusion.
 - 0.4 W/kg for 1-g SAR and 1.0 W/kg for 10-g SAR, when the test separation distances is > 50 mm.

| Bluetooth Max Power | Exposure Position | Body worn |
|---------------------|----------------------|------------|
| | Test separation | 15 mm |
| 8.0 dBm | Estimated SAR (W/kg) | 0.084 W/kg |

16.1 Head Exposure Conditions

| WWAN Band | | Exposure Position | 1 | 2 | 3 | 1+2 Summed 1g SAR (W/kg) | 1+3 Summed 1g SAR (W/kg) |
|-----------|---------|-------------------|------------------|------------------|------------------|-----------------------------------|-----------------------------------|
| | | | WWAN | 2.4GHz WLAN | 5GHz WLAN | | |
| | | | 1g SAR (W/kg) | 1g SAR (W/kg) | 1g SAR (W/kg) | | |
| GSM | GSM850 | Right Cheek | 0.410 | 0.760 | 0.092 | 1.17 | 0.50 |
| | | Right Tilted | 0.436 | 0.760 | 0.092 | 1.20 | 0.53 |
| | | Left Cheek | 0.482 | 0.760 | 0.092 | 1.24 | 0.57 |
| | | Left Tilted | 0.363 | 0.760 | 0.092 | 1.12 | 0.46 |
| | GSM1900 | Right Cheek | 0.109 | 0.760 | 0.092 | 0.87 | 0.20 |
| | | Right Tilted | 0.021 | 0.760 | 0.092 | 0.78 | 0.11 |
| | | Left Cheek | 0.152 | 0.760 | 0.092 | 0.91 | 0.24 |
| | | Left Tilted | 0.055 | 0.760 | 0.092 | 0.82 | 0.15 |
| WCDMA | Band V | Right Cheek | 0.249 | 0.760 | 0.092 | 1.01 | 0.34 |
| | | Right Tilted | 0.263 | 0.760 | 0.092 | 1.02 | 0.36 |
| | | Left Cheek | 0.354 | 0.760 | 0.092 | 1.11 | 0.45 |
| | | Left Tilted | 0.291 | 0.760 | 0.092 | 1.05 | 0.38 |
| | Band IV | Right Cheek | 0.346 | 0.760 | 0.092 | 1.11 | 0.44 |
| | | Right Tilted | 0.101 | 0.760 | 0.092 | 0.86 | 0.19 |
| | | Left Cheek | 0.303 | 0.760 | 0.092 | 1.06 | 0.40 |
| | | Left Tilted | 0.176 | 0.760 | 0.092 | 0.94 | 0.27 |
| | Band II | Right Cheek | 0.161 | 0.760 | 0.092 | 0.92 | 0.25 |
| | | Right Tilted | 0.034 | 0.760 | 0.092 | 0.79 | 0.13 |
| | | Left Cheek | 0.220 | 0.760 | 0.092 | 0.98 | 0.31 |
| | | Left Tilted | 0.083 | 0.760 | 0.092 | 0.84 | 0.18 |



| WWAN Band | | Exposure Position | 1 | 2 | 3 | 1+2 Summed 1g SAR (W/kg) | 1+3 Summed 1g SAR (W/kg) |
|-----------|---------|-------------------|------------------|------------------|------------------|-----------------------------------|-----------------------------------|
| | | | WWAN | 2.4GHz WLAN | 5GHz WLAN | | |
| | | | 1g SAR (W/kg) | 1g SAR (W/kg) | 1g SAR (W/kg) | | |
| LTE | Band 2 | Right Cheek | 0.261 | 0.760 | 0.092 | 1.02 | 0.35 |
| | | Right Tilted | 0.060 | 0.760 | 0.092 | 0.82 | 0.15 |
| | | Left Cheek | 0.238 | 0.760 | 0.092 | 1.00 | 0.33 |
| | | Left Tilted | 0.134 | 0.760 | 0.092 | 0.89 | 0.23 |
| | Band 4 | Right Cheek | 0.315 | 0.760 | 0.092 | 1.08 | 0.41 |
| | | Right Tilted | 0.154 | 0.760 | 0.092 | 0.91 | 0.25 |
| | | Left Cheek | 0.264 | 0.760 | 0.092 | 1.02 | 0.36 |
| | | Left Tilted | 0.174 | 0.760 | 0.092 | 0.93 | 0.27 |
| | Band 7 | Right Cheek | 0.075 | 0.760 | 0.092 | 0.84 | 0.17 |
| | | Right Tilted | 0.024 | 0.760 | 0.092 | 0.78 | 0.12 |
| | | Left Cheek | 0.143 | 0.760 | 0.092 | 0.90 | 0.24 |
| | | Left Tilted | 0.039 | 0.760 | 0.092 | 0.80 | 0.13 |
| | Band 12 | Right Cheek | 0.269 | 0.760 | 0.092 | 1.03 | 0.36 |
| | | Right Tilted | 0.222 | 0.760 | 0.092 | 0.98 | 0.31 |
| | | Left Cheek | 0.229 | 0.760 | 0.092 | 0.99 | 0.32 |
| | | Left Tilted | 0.157 | 0.760 | 0.092 | 0.92 | 0.25 |
| | Band 38 | Right Cheek | 0.031 | 0.760 | 0.092 | 0.79 | 0.12 |
| | | Right Tilted | 0.013 | 0.760 | 0.092 | 0.77 | 0.11 |
| | | Left Cheek | 0.089 | 0.760 | 0.092 | 0.85 | 0.18 |
| | | Left Tilted | 0.015 | 0.760 | 0.092 | 0.78 | 0.11 |

16.2 Hotspot Exposure Conditions

| WWAN Band | | Exposure Position | 1 | 2 | 1+2 Summed 1g SAR (W/kg) |
|-----------|---------|-------------------|---------------|---------------|--------------------------------|
| | | | WWAN | 2.4GHz WLAN | |
| | | | 1g SAR (W/kg) | 1g SAR (W/kg) | |
| GSM | GSM850 | Front | 0.851 | 0.173 | 1.02 |
| | | Back | 0.902 | 0.173 | 1.08 |
| | | Left side | 1.165 | 0.173 | 1.34 |
| | | Right side | 0.393 | | 0.39 |
| | | Top side | | 0.173 | 0.17 |
| | | Bottom side | 0.379 | | 0.38 |
| | GSM1900 | Front | 0.927 | 0.173 | 1.10 |
| | | Back | 0.907 | 0.173 | 1.08 |
| | | Left side | 0.229 | 0.173 | 0.40 |
| | | Right side | 0.013 | | 0.01 |
| | | Top side | | 0.173 | 0.17 |
| | | Bottom side | 1.188 | | 1.19 |
| WCDMA | Band V | Front | 0.565 | 0.173 | 0.74 |
| | | Back | 0.664 | 0.173 | 0.84 |
| | | Left side | 0.701 | 0.173 | 0.87 |
| | | Right side | 0.145 | | 0.15 |
| | | Top side | | 0.173 | 0.17 |
| | | Bottom side | 0.288 | | 0.29 |
| | Band IV | Front | 0.666 | 0.173 | 0.84 |
| | | Back | 0.622 | 0.173 | 0.80 |
| | | Left side | 0.127 | 0.173 | 0.30 |
| | | Right side | 0.094 | | 0.09 |
| | | Top side | | 0.173 | 0.17 |
| | | Bottom side | 1.110 | | 1.11 |
| | Band II | Front | 0.586 | 0.173 | 0.76 |
| | | Back | 0.551 | 0.173 | 0.72 |
| | | Left side | 0.173 | 0.173 | 0.35 |
| | | Right side | 0.010 | | 0.01 |
| | | Top side | | 0.173 | 0.17 |
| | | Bottom side | 1.025 | | 1.03 |



| WWAN Band | | Exposure Position | 1 | 2 | 1+2 Summed 1g SAR (W/kg) |
|-----------|-------------|-------------------|------------------|------------------|--------------------------------|
| | | | WWAN | 2.4GHz WLAN | |
| | | | 1g SAR (W/kg) | 1g SAR (W/kg) | |
| LTE | Band 2 | Front | 0.649 | 0.173 | 0.82 |
| | | Back | 0.615 | 0.173 | 0.79 |
| | | Left side | 0.232 | 0.173 | 0.41 |
| | | Right side | 0.035 | | 0.04 |
| | | Top side | | 0.173 | 0.17 |
| | | Bottom side | 0.985 | | 0.99 |
| | Band 4 | Front | 0.750 | 0.173 | 0.92 |
| | | Back | 0.665 | 0.173 | 0.84 |
| | | Left side | 0.153 | 0.173 | 0.33 |
| | | Right side | 0.092 | | 0.09 |
| | | Top side | | 0.173 | 0.17 |
| | | Bottom side | 1.138 | | 1.14 |
| | Band 7 | Front | 0.337 | 0.173 | 0.51 |
| | | Back | 0.325 | 0.173 | 0.50 |
| | | Left side | 0.049 | 0.173 | 0.22 |
| | | Right side | 0.120 | | 0.12 |
| | | Top side | | 0.173 | 0.17 |
| | | Bottom side | 0.661 | | 0.66 |
| | Band 12 | Front | 0.473 | 0.173 | 0.65 |
| | | Back | 0.542 | 0.173 | 0.72 |
| | | Left side | 0.412 | 0.173 | 0.59 |
| | | Right side | 0.421 | | 0.42 |
| | | Top side | | 0.173 | 0.17 |
| | | Bottom side | 0.129 | | 0.13 |
| Band 38 | Front | 0.542 | 0.173 | 0.72 | |
| | Back | 0.499 | 0.173 | 0.67 | |
| | Left side | 0.074 | 0.173 | 0.25 | |
| | Right side | 0.217 | | 0.22 | |
| | Top side | | 0.173 | 0.17 | |
| | Bottom side | 1.036 | | 1.04 | |



16.3 Body-Worn Accessory Exposure Conditions

| WWAN Band | | Exposure Position | 1 | 2 | 3 | 4 | 1+2 Summed 1g SAR (W/kg) | 1+3 Summed 1g SAR (W/kg) | 1+4 Summed 1g SAR (W/kg) |
|-----------|---------|-------------------|---------------|---------------|---------------|----------------------|--------------------------|--------------------------|--------------------------|
| | | | WWAN | 2.4GHz WLAN | 5GHz WLAN | Bluetooth | | | |
| | | | 1g SAR (W/kg) | 1g SAR (W/kg) | 1g SAR (W/kg) | Estimated SAR (W/kg) | | | |
| GSM | GSM850 | Front | 0.611 | 0.086 | 0.007 | 0.084 | 0.70 | 0.62 | 0.70 |
| | | Back | 0.684 | 0.086 | 0.007 | 0.084 | 0.77 | 0.69 | 0.77 |
| | GSM1900 | Front | 0.626 | 0.086 | 0.007 | 0.084 | 0.71 | 0.63 | 0.71 |
| | | Back | 0.578 | 0.086 | 0.007 | 0.084 | 0.66 | 0.59 | 0.66 |
| WCDMA | Band V | Front | 0.427 | 0.086 | 0.007 | 0.084 | 0.51 | 0.43 | 0.51 |
| | | Back | 0.471 | 0.086 | 0.007 | 0.084 | 0.56 | 0.48 | 0.56 |
| | Band IV | Front | 1.151 | 0.086 | 0.007 | 0.084 | 1.24 | 1.16 | 1.24 |
| | | Back | 1.037 | 0.086 | 0.007 | 0.084 | 1.12 | 1.04 | 1.12 |
| | Band II | Front | 0.938 | 0.086 | 0.007 | 0.084 | 1.02 | 0.95 | 1.02 |
| | | Back | 0.897 | 0.086 | 0.007 | 0.084 | 0.98 | 0.90 | 0.98 |
| LTE | Band 2 | Front | 0.823 | 0.086 | 0.007 | 0.084 | 0.91 | 0.83 | 0.91 |
| | | Back | 0.796 | 0.086 | 0.007 | 0.084 | 0.88 | 0.80 | 0.88 |
| | Band 4 | Front | 1.021 | 0.086 | 0.007 | 0.084 | 1.11 | 1.03 | 1.11 |
| | | Back | 1.011 | 0.086 | 0.007 | 0.084 | 1.10 | 1.02 | 1.10 |
| | Band 7 | Front | 0.562 | 0.086 | 0.007 | 0.084 | 0.65 | 0.57 | 0.65 |
| | | Back | 0.508 | 0.086 | 0.007 | 0.084 | 0.59 | 0.52 | 0.59 |
| | Band 38 | Front | 0.277 | 0.086 | 0.007 | 0.084 | 0.36 | 0.28 | 0.36 |
| | | Back | 0.266 | 0.086 | 0.007 | 0.084 | 0.35 | 0.27 | 0.35 |

Test Engineer : Nick Hu

17. Uncertainty Assessment

The component of uncertainty may generally be categorized according to the methods used to evaluate them. The evaluation of uncertainty by the statistical analysis of a series of observations is termed a Type A evaluation of uncertainty. The evaluation of uncertainty by means other than the statistical analysis of a series of observation is termed a Type B evaluation of uncertainty. Each component of uncertainty, however evaluated, is represented by an estimated standard deviation, termed standard uncertainty, which is determined by the positive square root of the estimated variance.

A Type A evaluation of standard uncertainty may be based on any valid statistical method for treating data. This includes calculating the standard deviation of the mean of a series of independent observations; using the method of least squares to fit a curve to the data in order to estimate the parameter of the curve and their standard deviations; or carrying out an analysis of variance in order to identify and quantify random effects in certain kinds of measurement.

A type B evaluation of standard uncertainty is typically based on scientific judgment using all of the relevant information available. These may include previous measurement data, experience, and knowledge of the behavior and properties of relevant materials and instruments, manufacture’s specification, data provided in calibration reports and uncertainties assigned to reference data taken from handbooks. Broadly speaking, the uncertainty is either obtained from an outdoor source or obtained from an assumed distribution, such as the normal distribution, rectangular or triangular distributions indicated in table below.

| Uncertainty Distributions | Normal | Rectangular | Triangular | U-Shape |
|------------------------------------|--------------------|--------------------|-------------------|----------------|
| Multi-plying Factor ^(a) | 1/k ^(b) | 1/√3 | 1/√6 | 1/√2 |

(a) standard uncertainty is determined as the product of the multiplying factor and the estimated range of variations in the measured quantity

(b) κ is the coverage factor

Table 17.1. Standard Uncertainty for Assumed Distribution

The combined standard uncertainty of the measurement result represents the estimated standard deviation of the result. It is obtained by combining the individual standard uncertainties of both Type A and Type B evaluation using the usual “root-sum-squares” (RSS) methods of combining standard deviations by taking the positive square root of the estimated variances.

Expanded uncertainty is a measure of uncertainty that defines an interval about the measurement result within which the measured value is confidently believed to lie. It is obtained by multiplying the combined standard uncertainty by a coverage factor. Typically, the coverage factor ranges from 2 to 3. Using a coverage factor allows the true value of a measured quantity to be specified with a defined probability within the specified uncertainty range. For purpose of this document, a coverage factor two is used, which corresponds to confidence interval of about 95 %. The DASY uncertainty Budget is shown in the following tables.

| Error Description | Uncertainty Value (±%) | Probability | Divisor | (Ci) 1g | (Ci) 10g | Standard Uncertainty (1g) (±%) | Standard Uncertainty (10g) (±%) |
|-----------------------------------|------------------------|-------------|---------|---------|----------|--------------------------------|---------------------------------|
| Measurement System | | | | | | | |
| Probe Calibration | 6.0 | N | 1 | 1 | 1 | 6.0 | 6.0 |
| Axial Isotropy | 4.7 | R | 1.732 | 0.7 | 0.7 | 1.9 | 1.9 |
| Hemispherical Isotropy | 9.6 | R | 1.732 | 0.7 | 0.7 | 3.9 | 3.9 |
| Boundary Effects | 1.0 | R | 1.732 | 1 | 1 | 0.6 | 0.6 |
| Linearity | 4.7 | R | 1.732 | 1 | 1 | 2.7 | 2.7 |
| System Detection Limits | 1.0 | R | 1.732 | 1 | 1 | 0.6 | 0.6 |
| Modulation Response | 3.2 | R | 1.732 | 1 | 1 | 1.8 | 1.8 |
| Readout Electronics | 0.3 | N | 1 | 1 | 1 | 0.3 | 0.3 |
| Response Time | 0.0 | R | 1.732 | 1 | 1 | 0.0 | 0.0 |
| Integration Time | 2.6 | R | 1.732 | 1 | 1 | 1.5 | 1.5 |
| RF Ambient Noise | 3.0 | R | 1.732 | 1 | 1 | 1.7 | 1.7 |
| RF Ambient Reflections | 3.0 | R | 1.732 | 1 | 1 | 1.7 | 1.7 |
| Probe Positioner | 0.4 | R | 1.732 | 1 | 1 | 0.2 | 0.2 |
| Probe Positioning | 2.9 | R | 1.732 | 1 | 1 | 1.7 | 1.7 |
| Max. SAR Eval. | 2.0 | R | 1.732 | 1 | 1 | 1.2 | 1.2 |
| Test Sample Related | | | | | | | |
| Device Positioning | 3.0 | N | 1 | 1 | 1 | 3.0 | 3.0 |
| Device Holder | 3.6 | N | 1 | 1 | 1 | 3.6 | 3.6 |
| Power Drift | 5.0 | R | 1.732 | 1 | 1 | 2.9 | 2.9 |
| Power Scaling | 0.0 | R | 1.732 | 1 | 1 | 0.0 | 0.0 |
| Phantom and Setup | | | | | | | |
| Phantom Uncertainty | 6.1 | R | 1.732 | 1 | 1 | 3.5 | 3.5 |
| SAR correction | 0.0 | R | 1.732 | 1 | 0.84 | 0.0 | 0.0 |
| Liquid Conductivity Repeatability | 0.2 | N | 1 | 0.78 | 0.71 | 0.1 | 0.1 |
| Liquid Conductivity (target) | 5.0 | R | 1.732 | 0.78 | 0.71 | 2.3 | 2.0 |
| Liquid Conductivity (mea.) | 2.5 | R | 1.732 | 0.78 | 0.71 | 1.1 | 1.0 |
| Temp. unc. - Conductivity | 3.4 | R | 1.732 | 0.78 | 0.71 | 1.5 | 1.4 |
| Liquid Permittivity Repeatability | 0.15 | N | 1 | 0.23 | 0.26 | 0.0 | 0.0 |
| Liquid Permittivity (target) | 5.0 | R | 1.732 | 0.23 | 0.26 | 0.7 | 0.8 |
| Liquid Permittivity (mea.) | 2.5 | R | 1.732 | 0.23 | 0.26 | 0.3 | 0.4 |
| Temp. unc. - Permittivity | 0.83 | R | 1.732 | 0.23 | 0.26 | 0.1 | 0.1 |
| Combined Std. Uncertainty | | | | | | 11.4% | 11.4% |
| Coverage Factor for 95 % | | | | | | K=2 | K=2 |
| Expanded STD Uncertainty | | | | | | 22.9% | 22.7% |

Table 17.2. Uncertainty Budget for frequency range 300 MHz to 3 GHz

| Error Description | Uncertainty Value (±%) | Probability | Divisor | (Ci) 1g | (Ci) 10g | Standard Uncertainty (1g) (±%) | Standard Uncertainty (10g) (±%) |
|-----------------------------------|------------------------|-------------|---------|---------|----------|--------------------------------|---------------------------------|
| Measurement System | | | | | | | |
| Probe Calibration | 6.55 | N | 1 | 1 | 1 | 6.6 | 6.6 |
| Axial Isotropy | 4.7 | R | 1.732 | 0.7 | 0.7 | 1.9 | 1.9 |
| Hemispherical Isotropy | 9.6 | R | 1.732 | 0.7 | 0.7 | 3.9 | 3.9 |
| Boundary Effects | 2.0 | R | 1.732 | 1 | 1 | 1.2 | 1.2 |
| Linearity | 4.7 | R | 1.732 | 1 | 1 | 2.7 | 2.7 |
| System Detection Limits | 1.0 | R | 1.732 | 1 | 1 | 0.6 | 0.6 |
| Modulation Response | 3.2 | R | 1.732 | 1 | 1 | 1.8 | 1.8 |
| Readout Electronics | 0.3 | N | 1 | 1 | 1 | 0.3 | 0.3 |
| Response Time | 0.0 | R | 1.732 | 1 | 1 | 0.0 | 0.0 |
| Integration Time | 2.6 | R | 1.732 | 1 | 1 | 1.5 | 1.5 |
| RF Ambient Noise | 3.0 | R | 1.732 | 1 | 1 | 1.7 | 1.7 |
| RF Ambient Reflections | 3.0 | R | 1.732 | 1 | 1 | 1.7 | 1.7 |
| Probe Positioner | 0.4 | R | 1.732 | 1 | 1 | 0.2 | 0.2 |
| Probe Positioning | 6.7 | R | 1.732 | 1 | 1 | 3.9 | 3.9 |
| Max. SAR Eval. | 4.0 | R | 1.732 | 1 | 1 | 2.3 | 2.3 |
| Test Sample Related | | | | | | | |
| Device Positioning | 3.0 | N | 1 | 1 | 1 | 3.0 | 3.0 |
| Device Holder | 3.6 | N | 1 | 1 | 1 | 3.6 | 3.6 |
| Power Drift | 5.0 | R | 1.732 | 1 | 1 | 2.9 | 2.9 |
| Power Scaling | 0.0 | R | 1.732 | 1 | 1 | 0.0 | 0.0 |
| Phantom and Setup | | | | | | | |
| Phantom Uncertainty | 6.6 | R | 1.732 | 1 | 1 | 3.8 | 3.8 |
| SAR correction | 0.0 | R | 1.732 | 1 | 0.84 | 0.0 | 0.0 |
| Liquid Conductivity Repeatability | 0.2 | N | 1 | 0.78 | 0.71 | 0.1 | 0.1 |
| Liquid Conductivity (target) | 5.0 | R | 1.732 | 0.78 | 0.71 | 2.3 | 2.0 |
| Liquid Conductivity (mea.) | 2.5 | R | 1.732 | 0.78 | 0.71 | 1.1 | 1.0 |
| Temp. unc. - Conductivity | 3.4 | R | 1.732 | 0.78 | 0.71 | 1.5 | 1.4 |
| Liquid Permittivity Repeatability | 0.15 | N | 1 | 0.23 | 0.26 | 0.0 | 0.0 |
| Liquid Permittivity (target) | 5.0 | R | 1.732 | 0.23 | 0.26 | 0.7 | 0.8 |
| Liquid Permittivity (mea.) | 2.5 | R | 1.732 | 0.23 | 0.26 | 0.3 | 0.4 |
| Temp. unc. - Permittivity | 0.83 | R | 1.732 | 0.23 | 0.26 | 0.1 | 0.1 |
| Combined Std. Uncertainty | | | | | | 12.5% | 12.5% |
| Coverage Factor for 95 % | | | | | | K=2 | K=2 |
| Expanded STD Uncertainty | | | | | | 25.1% | 25.0% |

Table 17.3. Uncertainty Budget for frequency range 3 GHz to 6 GHz



18. References

- [1] FCC 47 CFR Part 2 "Frequency Allocations and Radio Treaty Matters; General Rules and Regulations"
- [2] ANSI/IEEE Std. C95.1-1992, "IEEE Standard for Safety Levels with Respect to Human Exposure to Radio Frequency Electromagnetic Fields, 3 kHz to 300 GHz", September 1992
- [3] IEEE Std. 1528-2013, "IEEE Recommended Practice for Determining the Peak Spatial-Average Specific Absorption Rate (SAR) in the Human Head from Wireless Communications Devices: Measurement Techniques", Sep 2013
- [4] SPEAG DASY System Handbook
- [5] FCC KDB 248227 D01 v02r02, "SAR Guidance for IEEE 802.11 (WiFi) Transmitters", Oct 2015.
- [6] FCC KDB 447498 D01 v06, "Mobile and Portable Device RF Exposure Procedures and Equipment Authorization Policies", Oct 2015
- [7] FCC KDB 648474 D04 v01r03, "SAR Evaluation Considerations for Wireless Handsets", Oct 2015.
- [8] FCC KDB 941225 D01 v03r01, "3G SAR MEAUREMENT PROCEDURES", Oct 2015
- [9] FCC KDB 941225 D05 v02r05, "SAR Evaluation Considerations for LTE Devices", Dec 2015
- [10] FCC KDB 941225 D06 v02r01, "SAR Evaluation Procedures for Portable Devices with Wireless Router Capabilities", Oct 2015.
- [11] FCC KDB 865664 D01 v01r04, "SAR Measurement Requirements for 100 MHz to 6 GHz", Aug 2015.
- [12] FCC KDB 865664 D02 v01r02, "RF Exposure Compliance Reporting and Documentation Considerations" Oct 2015.



Appendix A. Plots of System Performance Check

The plots are shown as follows.

System Check_Head_750MHz

DUT: D750V3 - SN:1065

Communication System: UID 0, CW (0); Frequency: 750 MHz; Duty Cycle: 1:1

Medium: HSL_750 Medium parameters used: $f = 750$ MHz; $\sigma = 0.906$ S/m; $\epsilon_r = 42.23$; $\rho = 1000$ kg/m³

Ambient Temperature : 23.2 °C ; Liquid Temperature : 22.9 °C

DASY5 Configuration:

- Probe: EX3DV4 - SN3954; ConvF(10.98, 10.98, 10.98); Calibrated: 2016.11.28;
- Sensor-Surface: 2mm (Mechanical Surface Detection)
- Electronics: DAE4 Sn1279; Calibrated: 2016.4.4
- Phantom: SAM2; Type: SAM; Serial: TP-1542
- Measurement SW: DASY52, Version 52.8 (8); SEMCAD X Version 14.6.10 (7331)

Pin=250mW/Area Scan (61x61x1): Interpolated grid: dx=1.500 mm, dy=1.500 mm

Maximum value of SAR (interpolated) = 2.60 W/kg

Pin=250mW/Zoom Scan (5x5x7)/Cube 0: Measurement grid: dx=8mm, dy=8mm, dz=5mm

Reference Value = 47.37 V/m; Power Drift = -0.03 dB

Peak SAR (extrapolated) = 3.08 W/kg

SAR(1 g) = 2.07 W/kg; SAR(10 g) = 1.38 W/kg

Maximum value of SAR (measured) = 2.62 W/kg

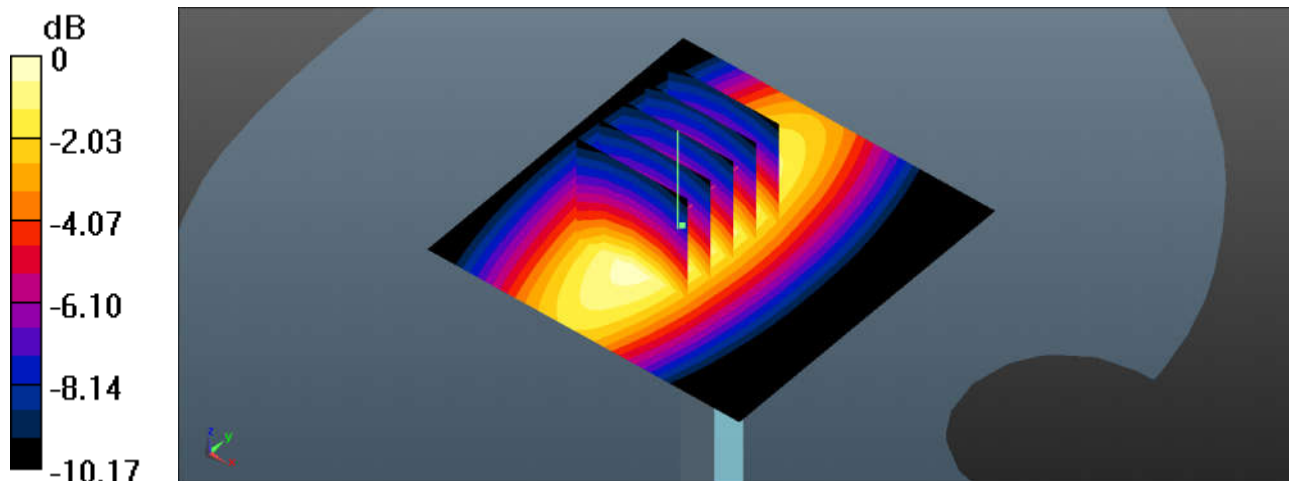

0 dB = 2.62 W/kg = 4.18 dBW/kg

System Check_Head_835MHz

DUT: D835V2 - SN:4d151

Communication System: UID 0, CW (0); Frequency: 835 MHz; Duty Cycle: 1:1

Medium: HSL_835 Medium parameters used: $f = 835 \text{ MHz}$; $\sigma = 0.887 \text{ S/m}$; $\epsilon_r = 40.927$; $\rho = 1000 \text{ kg/m}^3$

Ambient Temperature : $23.2 \text{ }^\circ\text{C}$; Liquid Temperature : $22.9 \text{ }^\circ\text{C}$

DASY5 Configuration:

- Probe: EX3DV4 - SN3954; ConvF(10.52, 10.52, 10.52); Calibrated: 2016.11.28;
- Sensor-Surface: 2mm (Mechanical Surface Detection)
- Electronics: DAE4 Sn1279; Calibrated: 2016.4.4
- Phantom: SAM2; Type: SAM; Serial: TP-1542
- Measurement SW: DASY52, Version 52.8 (8); SEMCAD X Version 14.6.10 (7331)

Pin=250mW/Area Scan (61x61x1): Interpolated grid: $dx=1.500 \text{ mm}$, $dy=1.500 \text{ mm}$

Maximum value of SAR (interpolated) = 2.79 W/kg

Pin=250mW/Zoom Scan (5x5x7)/Cube 0: Measurement grid: $dx=8\text{mm}$, $dy=8\text{mm}$, $dz=5\text{mm}$

Reference Value = 49.75 V/m ; Power Drift = -0.06 dB

Peak SAR (extrapolated) = 2.91 W/kg

SAR(1 g) = 2.22 W/kg ; SAR(10 g) = 1.54 W/kg

Maximum value of SAR (measured) = 2.64 W/kg

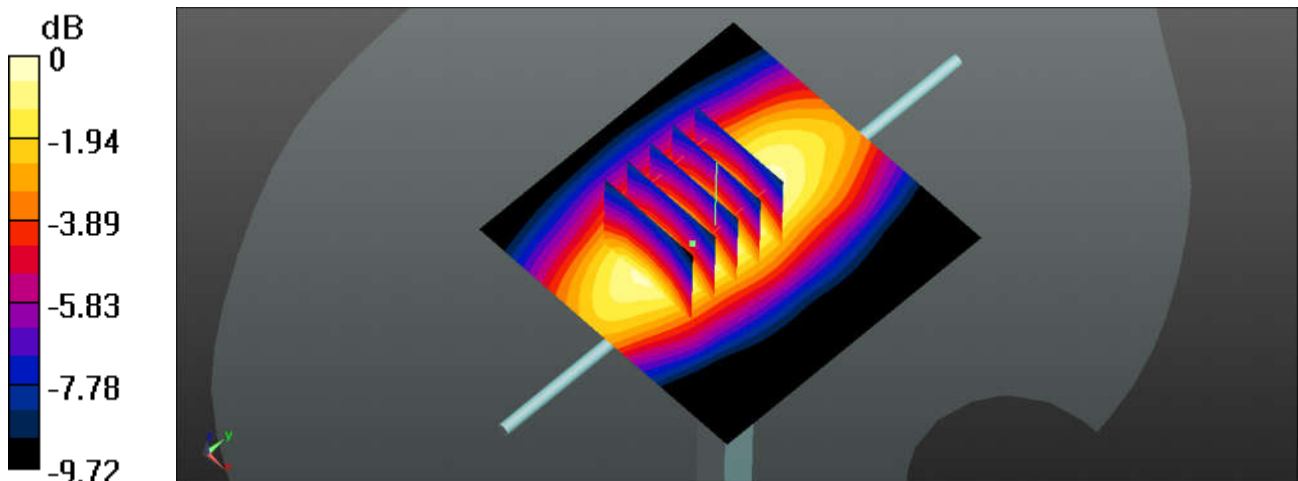

0 dB = $2.64 \text{ W/kg} = 4.22 \text{ dBW/kg}$

System Check_Head_1750MHz

DUT: D1750V2 - SN:1069

Communication System: UID 0, CW; Frequency: 1750 MHz; Duty Cycle: 1:1

Medium: HSL_1750 Medium parameters used: $f = 1750$ MHz; $\sigma = 1.404$ S/m; $\epsilon_r = 39.054$; $\rho = 1000$

kg/m³

Ambient Temperature : 23.4 °C; Liquid Temperature : 22.7 °C

DASY5 Configuration:

- Probe: EX3DV4 - SN3857; ConvF(8, 8, 8); Calibrated: 2016.5.25;
- Sensor-Surface: 2mm (Mechanical Surface Detection)
- Electronics: DAE4 Sn1210; Calibrated: 2016.5.18
- Phantom: SAM1; Type: SAM; Serial: TP-1479
- Measurement SW: DASY52, Version 52.8 (8); SEMCAD X Version 14.6.10 (7331)

Pin=250mW/Area Scan (61x61x1): Interpolated grid: dx=1.500 mm, dy=1.500 mm

Maximum value of SAR (interpolated) = 13.6 W/kg

Pin=250mW/Zoom Scan (5x5x7)/Cube 0: Measurement grid: dx=8mm, dy=8mm, dz=5mm

Reference Value = 87.54 V/m; Power Drift = 0.03 dB

Peak SAR (extrapolated) = 17.1 W/kg

SAR(1 g) = 9.68 W/kg; SAR(10 g) = 5.24 W/kg

Maximum value of SAR (measured) = 13.6 W/kg

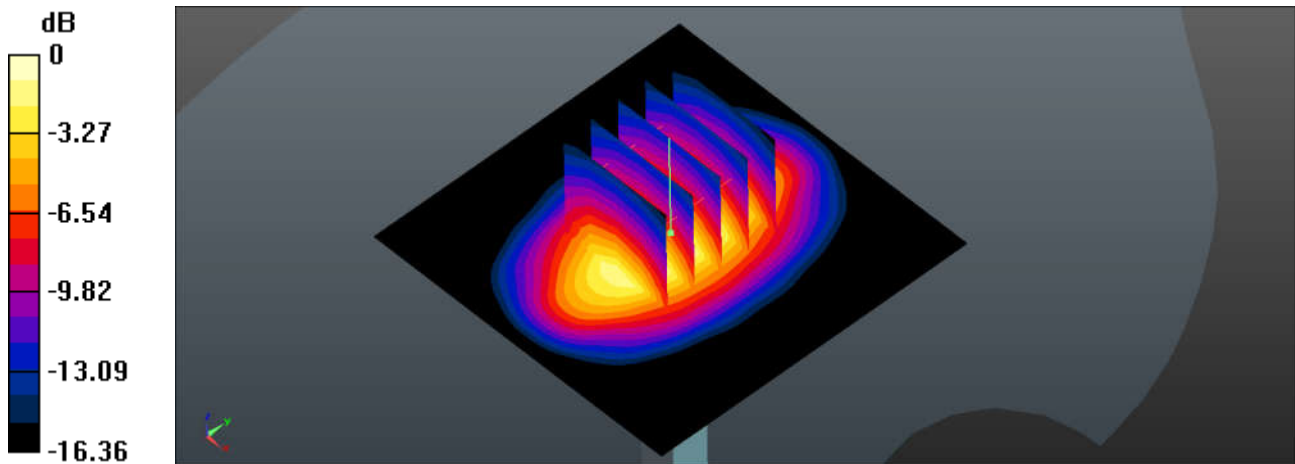

System Check_Head_1900MHz

DUT: D1900V2 - SN:5d118

Communication System: UID 0, CW; Frequency: 1900 MHz; Duty Cycle: 1:1
Medium: HSL_1900 Medium parameters used: $f = 1900$ MHz; $\sigma = 1.429$ S/m; $\epsilon_r = 40.027$; $\rho = 1000$ kg/m³
Ambient Temperature : 23.4 °C; Liquid Temperature : 22.7 °C

DASY5 Configuration:

- Probe: EX3DV4 - SN3857; ConvF(7.85, 7.85, 7.85); Calibrated: 2016.5.25;
- Sensor-Surface: 2mm (Mechanical Surface Detection)
- Electronics: DAE4 Sn1210; Calibrated: 2016.5.18
- Phantom: SAM1; Type: SAM; Serial: TP-1479
- Measurement SW: DASY52, Version 52.8 (8); SEMCAD X Version 14.6.10 (7331)

Pin=250mW/Area Scan (61x61x1): Interpolated grid: dx=1.500 mm, dy=1.500 mm
Maximum value of SAR (interpolated) = 14.6 W/kg

Pin=250mW/Zoom Scan (5x5x7)/Cube 0: Measurement grid: dx=8mm, dy=8mm, dz=5mm
Reference Value = 88.23 V/m; Power Drift = -0.03 dB
Peak SAR (extrapolated) = 18.8 W/kg
SAR(1 g) = 9.87 W/kg; SAR(10 g) = 5.02 W/kg
Maximum value of SAR (measured) = 14.4 W/kg

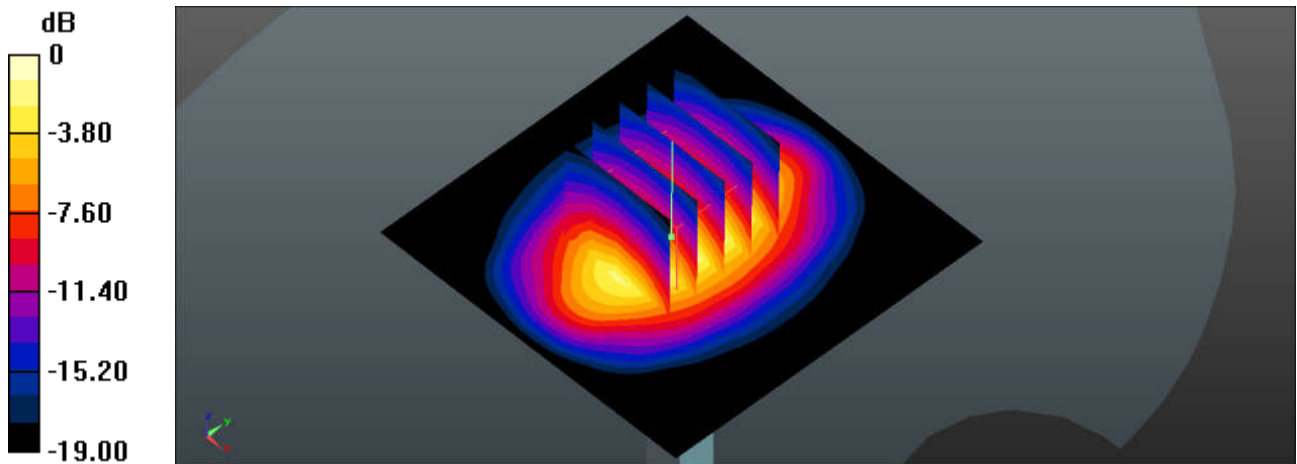

0 dB = 14.4 W/kg = 11.58 dBW/kg

System Check_Head_2450MHz

DUT: D2450V2 - SN:840

Communication System: UID 0, CW (0); Frequency: 2450 MHz; Duty Cycle: 1:1

Medium: HSL_2450 Medium parameters used: $f = 2450$ MHz; $\sigma = 1.838$ S/m; $\epsilon_r = 38.374$; $\rho = 1000$ kg/m³

Ambient Temperature : 23.4 °C; Liquid Temperature : 22.9 °C

DASY5 Configuration:

- Probe: EX3DV4 - SN3857; ConvF(7.19, 7.19, 7.19); Calibrated: 2016.5.25;
- Sensor-Surface: 2mm (Mechanical Surface Detection)
- Electronics: DAE4 Sn1210; Calibrated: 2016.5.18
- Phantom: SAM2; Type: SAM; Serial: TP-1477
- Measurement SW: DASY52, Version 52.8 (8); SEMCAD X Version 14.6.10 (7331)

Pin=250mW/Area Scan (71x71x1): Interpolated grid: dx=1.200 mm, dy=1.200 mm
Maximum value of SAR (interpolated) = 20.9 W/kg

Pin=250mW/Zoom Scan (7x7x7)/Cube 0: Measurement grid: dx=5mm, dy=5mm, dz=5mm
Reference Value = 87.78 V/m; Power Drift = 0.15 dB
Peak SAR (extrapolated) = 28.3 W/kg
SAR(1 g) = 13.3 W/kg; SAR(10 g) = 6.08 W/kg
Maximum value of SAR (measured) = 20.7 W/kg

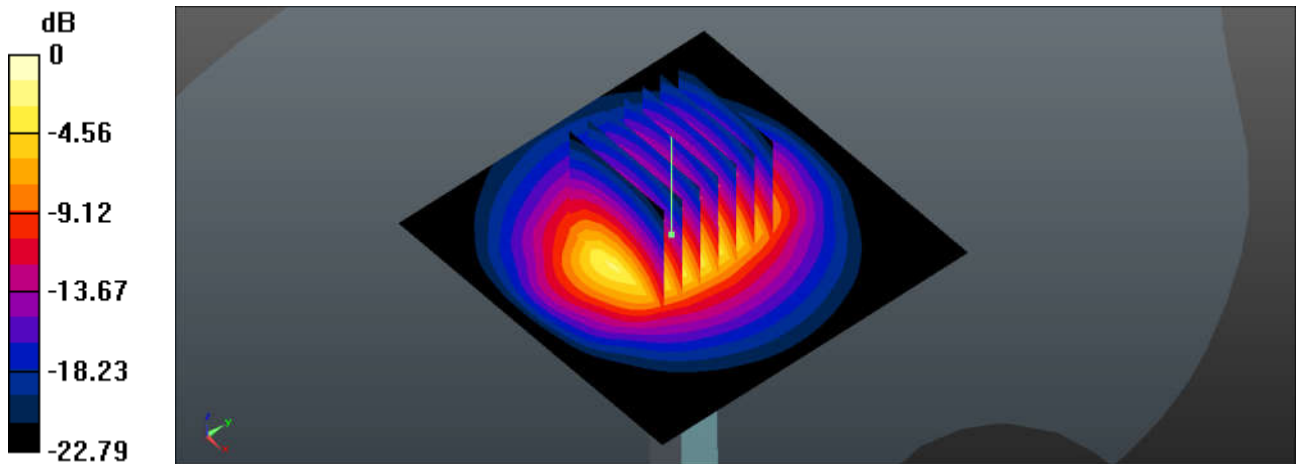

System Check_Head_2600MHz

DUT: D2600V2 - SN:1061

Communication System: UID 0, CW; Frequency: 2600 MHz; Duty Cycle: 1:1
Medium: HSL_2600 Medium parameters used: $f = 2600$ MHz; $\sigma = 2.008$ S/m; $\epsilon_r = 37.794$; $\rho = 1000$ kg/m³
Ambient Temperature : 23.4 °C; Liquid Temperature : 22.9 °C

DASY5 Configuration:

- Probe: EX3DV4 - SN3857; ConvF(7.08, 7.08, 7.08); Calibrated: 2016.5.25;
- Sensor-Surface: 2mm (Mechanical Surface Detection)
- Electronics: DAE4 Sn1210; Calibrated: 2016.5.18
- Phantom: SAM2; Type: SAM; Serial: TP-1477
- Measurement SW: DASY52, Version 52.8 (8); SEMCAD X Version 14.6.10 (7331)

Pin=250mW/Area Scan (71x71x1): Interpolated grid: dx=1.200 mm, dy=1.200 mm
Maximum value of SAR (interpolated) = 22.6 W/kg

Pin=250mW/Zoom Scan (7x7x7)/Cube 0: Measurement grid: dx=5mm, dy=5mm, dz=5mm
Reference Value = 87.81 V/m; Power Drift = 0.14 dB
Peak SAR (extrapolated) = 30.2 W/kg
SAR(1 g) = 13.9 W/kg; SAR(10 g) = 6.13 W/kg
Maximum value of SAR (measured) = 21.9 W/kg

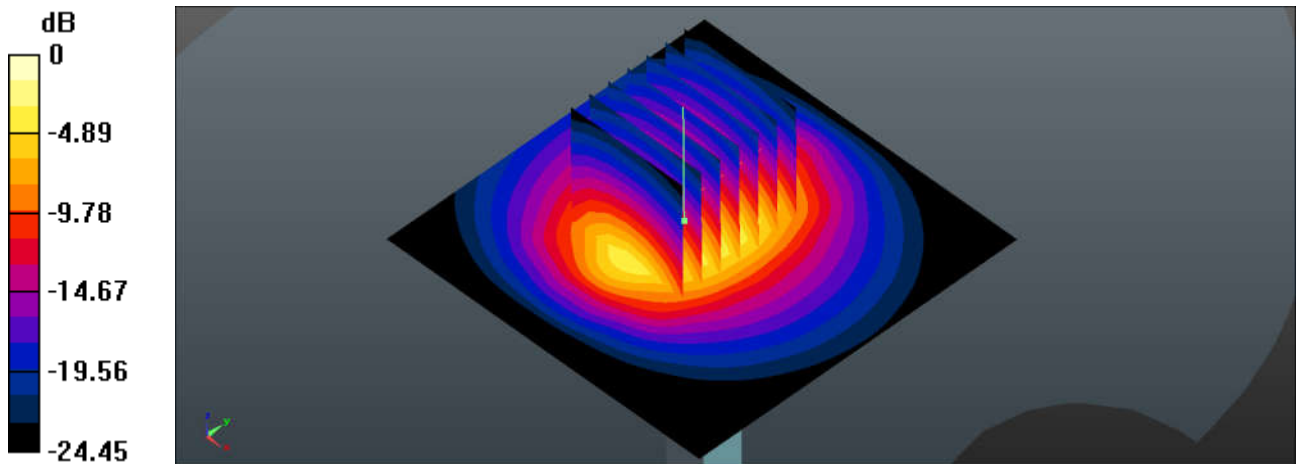

0 dB = 21.9 W/kg = 13.40 dBW/kg

System Check_Head_5250MHz

DUT: D5GHzV2 - SN:1113

Communication System: UID 0, CW (0); Frequency: 5250 MHz; Duty Cycle: 1:1

Medium: HSL_5000 Medium parameters used: $f = 5250$ MHz; $\sigma = 4.612$ S/m; $\epsilon_r = 36.277$; $\rho = 1000$ kg/m³

Ambient Temperature : 23.5 °C ; Liquid Temperature : 22.5 °C

DASY5 Configuration:

- Probe: EX3DV4 - SN3954; ConvF(5.08, 5.08, 5.08); Calibrated: 2016.11.28;
- Sensor-Surface: 1.4mm (Mechanical Surface Detection)
- Electronics: DAE4 Sn1279; Calibrated: 2016.4.4
- Phantom: SAM2; Type: SAM; Serial: TP-1542
- Measurement SW: DASY52, Version 52.8 (8); SEMCAD X Version 14.6.10 (7331)

Pin=100mW/Area Scan (91x91x1): Interpolated grid: dx=1.000 mm, dy=1.000 mm

Maximum value of SAR (interpolated) = 15.6 W/kg

Pin=100mW/Zoom Scan (8x8x7)/Cube 0: Measurement grid: dx=4mm, dy=4mm, dz=1.4mm

Reference Value = 40.45 V/m; Power Drift = -0.03 dB

Peak SAR (extrapolated) = 31.2 W/kg

SAR(1 g) = 7.88 W/kg; SAR(10 g) = 2.32 W/kg

Maximum value of SAR (measured) = 19.0 W/kg

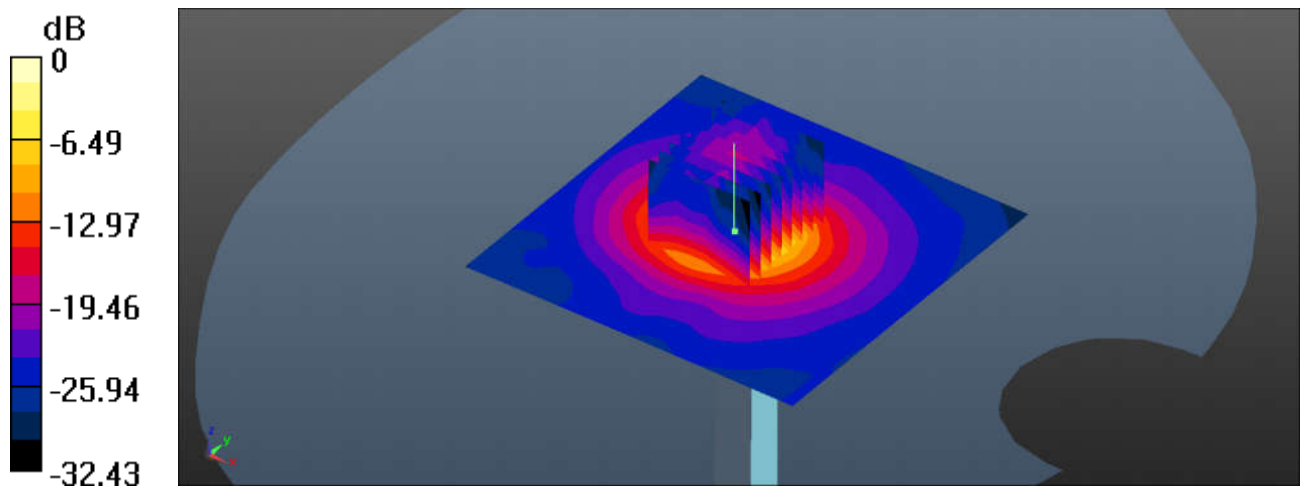

0 dB = 19.0 W/kg = 12.79 dBW/kg

System Check_Head_5600MHz

DUT: D5GHzV2 - SN:1113

Communication System: UID 0, CW (0); Frequency: 5600 MHz; Duty Cycle: 1:1
Medium: HSL_5000 Medium parameters used: $f = 5600$ MHz; $\sigma = 4.969$ S/m; $\epsilon_r = 35.787$; $\rho = 1000$ kg/m³
Ambient Temperature : 23.5 °C ; Liquid Temperature : 22.5 °C

DASY5 Configuration:

- Probe: EX3DV4 - SN3954; ConvF(4.7, 4.7, 4.7); Calibrated: 2016.11.28;
- Sensor-Surface: 1.4mm (Mechanical Surface Detection)
- Electronics: DAE4 Sn1279; Calibrated: 2016.4.4
- Phantom: SAM2; Type: SAM; Serial: TP-1542
- Measurement SW: DASY52, Version 52.8 (8); SEMCAD X Version 14.6.10 (7331)

Pin=100mW/Area Scan (91x91x1): Interpolated grid: dx=1.000 mm, dy=1.000 mm
Maximum value of SAR (interpolated) = 20.3 W/kg

Pin=100mW/Zoom Scan (8x8x7)/Cube 0: Measurement grid: dx=4mm, dy=4mm, dz=1.4mm
Reference Value = 40.70 V/m; Power Drift = -0.04 dB
Peak SAR (extrapolated) = 33.5 W/kg
SAR(1 g) = 8.26 W/kg; SAR(10 g) = 2.44 W/kg
Maximum value of SAR (measured) = 20.1 W/kg

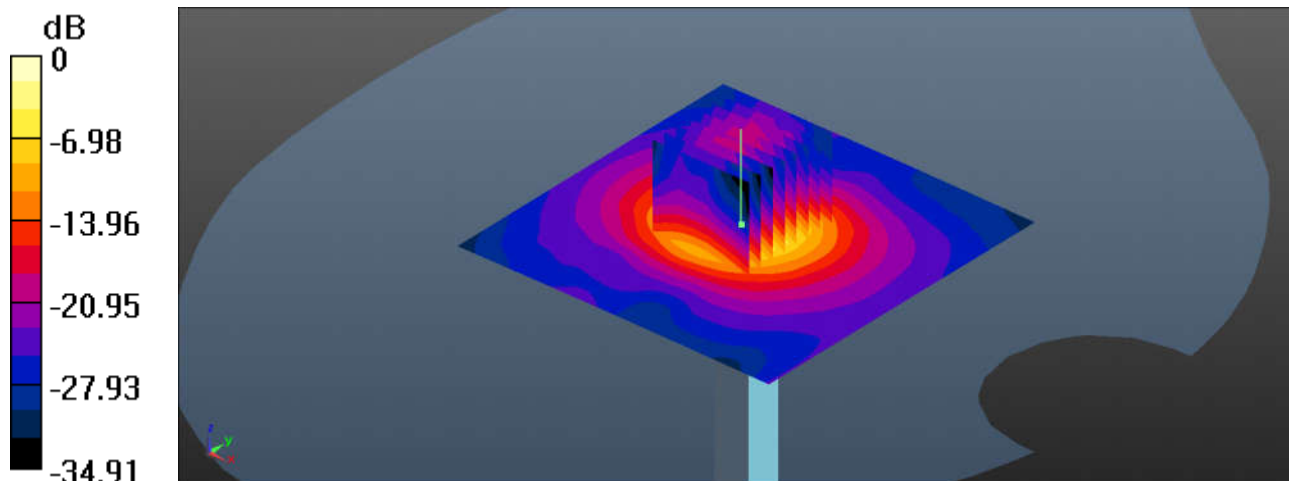

0 dB = 20.1 W/kg = 13.03 dBW/kg

System Check_Head_5750MHz

DUT: D5GHzV2 - SN:1113

Communication System: UID 0, CW (0); Frequency: 5750 MHz; Duty Cycle: 1:1

Medium: HSL_5000 Medium parameters used: $f = 5750$ MHz; $\sigma = 5.123$ S/m; $\epsilon_r = 35.569$; $\rho = 1000$ kg/m³

Ambient Temperature : 23.5 °C ; Liquid Temperature : 22.5 °C

DASY5 Configuration:

- Probe: EX3DV4 - SN3954; ConvF(4.69, 4.69, 4.69); Calibrated: 2016.11.28;
- Sensor-Surface: 1.4mm (Mechanical Surface Detection)
- Electronics: DAE4 Sn1279; Calibrated: 2016.4.4
- Phantom: SAM2; Type: SAM; Serial: TP-1542
- Measurement SW: DASY52, Version 52.8 (8); SEMCAD X Version 14.6.10 (7331)

Pin=100mW/Area Scan (91x91x1): Interpolated grid: dx=1.000 mm, dy=1.000 mm

Maximum value of SAR (interpolated) = 17.8 W/kg

Pin=100mW/Zoom Scan (8x8x7)/Cube 0: Measurement grid: dx=4mm, dy=4mm, dz=1.4mm

Reference Value = 37.94 V/m; Power Drift = -0.11 dB

Peak SAR (extrapolated) = 30.7 W/kg

SAR(1 g) = 7.66 W/kg; SAR(10 g) = 2.26 W/kg

Maximum value of SAR (measured) = 17.7 W/kg

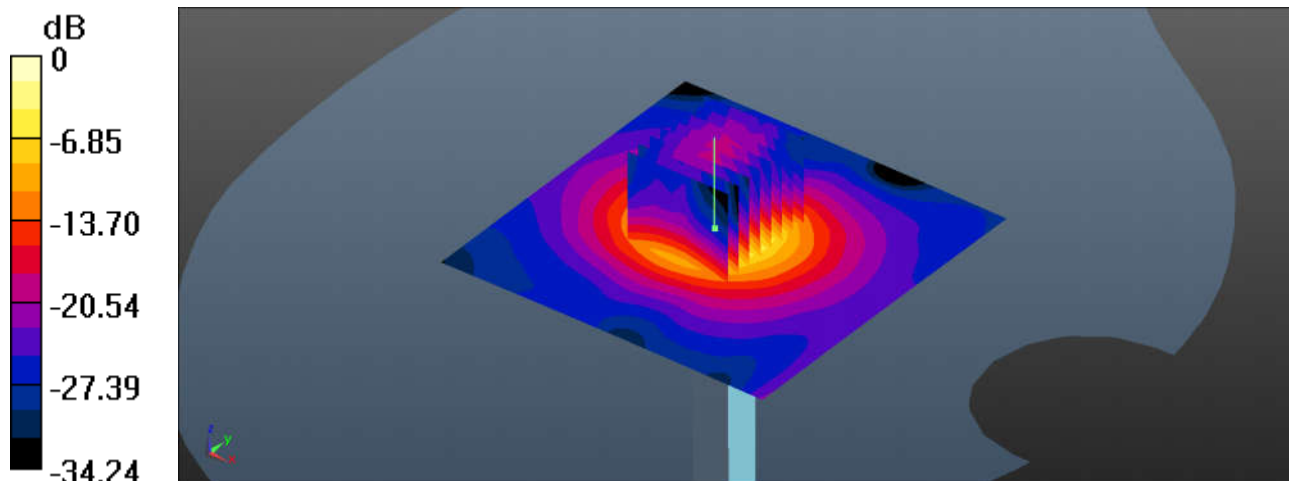

0 dB = 17.7 W/kg = 12.48 dBW/kg

System Check_Body_750MHz

DUT: D750V3 - SN:1065

Communication System: UID 0, CW (0); Frequency: 750 MHz; Duty Cycle: 1:1
Medium: MSL_735 Medium parameters used: $f = 750$ MHz; $\sigma = 0.963$ S/m; $\epsilon_r = 55.234$; $\rho = 1000$ kg/m³
Ambient Temperature : 23.3 °C ; Liquid Temperature : 22.8 °C

DASY5 Configuration:

- Probe: EX3DV4 - SN3954; ConvF(10.54, 10.54, 10.54); Calibrated: 2016.11.28;
- Sensor-Surface: 2mm (Mechanical Surface Detection)
- Electronics: DAE4 Sn1279; Calibrated: 2016.4.4
- Phantom: SAM2; Type: SAM; Serial: TP-1542
- Measurement SW: DASY52, Version 52.8 (8); SEMCAD X Version 14.6.10 (7331)

Pin=250mW/Area Scan (61x61x1): Interpolated grid: dx=1.500 mm, dy=1.500 mm
Maximum value of SAR (interpolated) = 2.82 W/kg

Pin=250mW/Zoom Scan (5x5x7)/Cube 0: Measurement grid: dx=8mm, dy=8mm, dz=5mm
Reference Value = 49.85 V/m; Power Drift = -0.13 dB
Peak SAR (extrapolated) = 3.29 W/kg
SAR(1 g) = 2.22 W/kg; SAR(10 g) = 1.48 W/kg
Maximum value of SAR (measured) = 2.79 W/kg

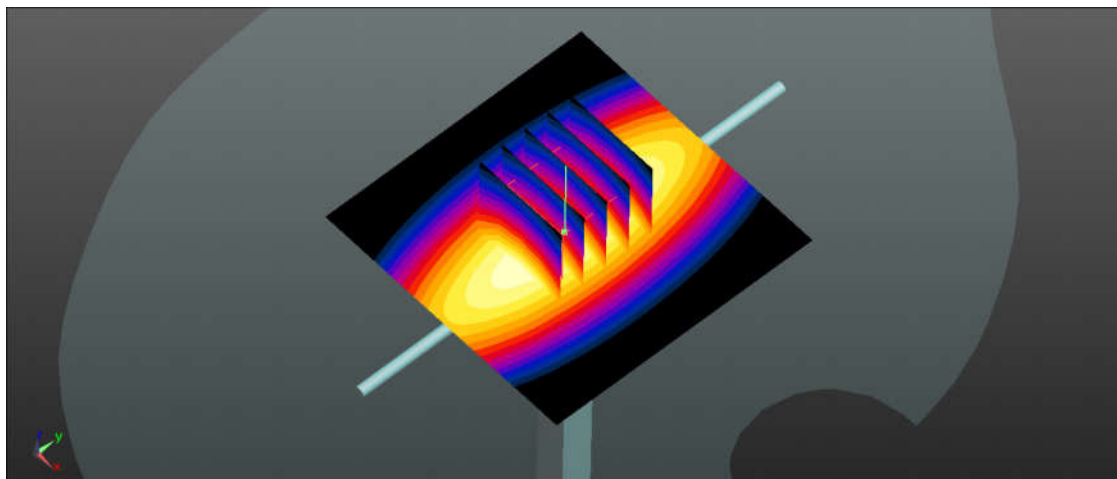
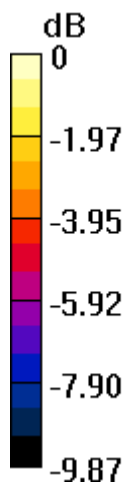

0 dB = 2.79 W/kg = 4.46 dBW/kg

System Check_Body_835MHz

DUT: D835V2 - SN:4d151

Communication System: UID 0, CW (0); Frequency: 835 MHz; Duty Cycle: 1:1
 Medium: MSL_835 Medium parameters used: $f = 835 \text{ MHz}$; $\sigma = 0.989 \text{ S/m}$; $\epsilon_r = 56.278$; $\rho = 1000 \text{ kg/m}^3$
 Ambient Temperature : $23.3 \text{ }^\circ\text{C}$; Liquid Temperature : $22.8 \text{ }^\circ\text{C}$

DASY5 Configuration:

- Probe: EX3DV4 - SN3954; ConvF(10.32, 10.32, 10.32); Calibrated: 2016.11.28;
- Sensor-Surface: 2mm (Mechanical Surface Detection)
- Electronics: DAE4 Sn1279; Calibrated: 2016.4.4
- Phantom: SAM2; Type: SAM; Serial: TP-1542
- Measurement SW: DASY52, Version 52.8 (8); SEMCAD X Version 14.6.10 (7331)

Pin=250mW/Area Scan (61x61x1): Interpolated grid: $dx=1.500 \text{ mm}$, $dy=1.500 \text{ mm}$
 Maximum value of SAR (interpolated) = 3.23 W/kg

Pin=250mW/Zoom Scan (5x5x7)/Cube 0: Measurement grid: $dx=8\text{mm}$, $dy=8\text{mm}$, $dz=5\text{mm}$
 Reference Value = 52.15 V/m ; Power Drift = -0.14 dB
 Peak SAR (extrapolated) = 3.74 W/kg
SAR(1 g) = 2.54 W/kg ; SAR(10 g) = 1.67 W/kg
 Maximum value of SAR (measured) = 3.21 W/kg

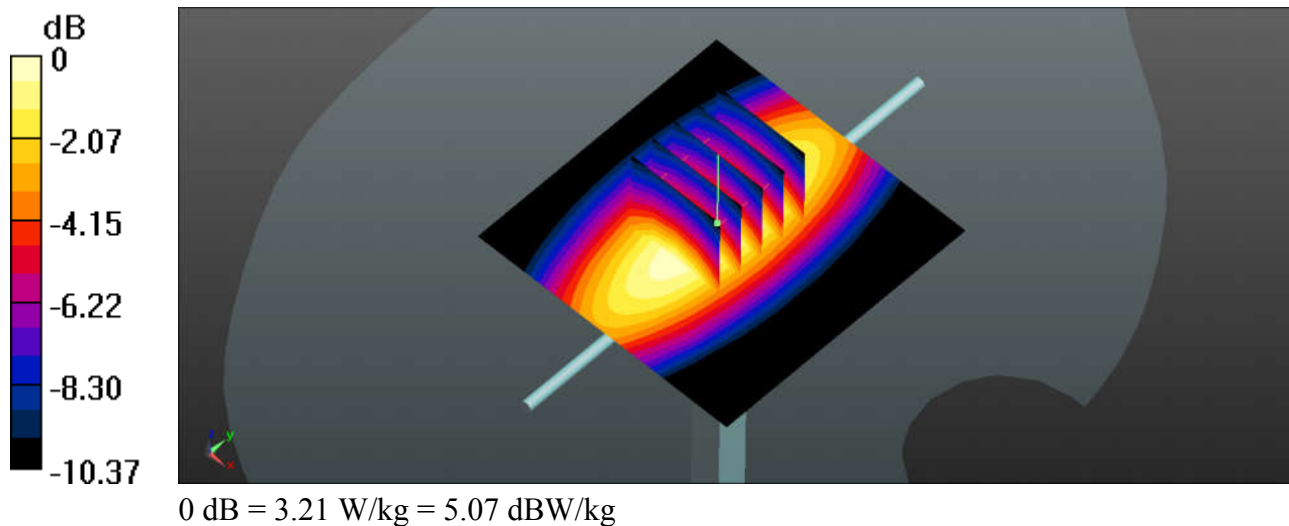

System Check_Body_1750MHz

DUT: D1750V2 - SN:1069

Communication System: UID 0, CW (0); Frequency: 1750 MHz; Duty Cycle: 1:1
Medium: MSL_1750 Medium parameters used: $f = 1750$ MHz; $\sigma = 1.503$ S/m; $\epsilon_r = 53.427$; $\rho = 1000$ kg/m³
Ambient Temperature : 23.3 °C; Liquid Temperature : 22.9 °C

DASY5 Configuration:

- Probe: EX3DV4 - SN3857; ConvF(7.81, 7.81, 7.81); Calibrated: 2016.5.25;
- Sensor-Surface: 2mm (Mechanical Surface Detection)
- Electronics: DAE4 Sn1210; Calibrated: 2016.5.18
- Phantom: SAM2; Type: SAM; Serial: TP-1477
- Measurement SW: DASY52, Version 52.8 (8); SEMCAD X Version 14.6.10 (7331)

Pin=250mW/Area Scan (61x61x1): Interpolated grid: dx=1.500 mm, dy=1.500 mm
Maximum value of SAR (interpolated) = 13.5 W/kg

Pin=250mW/Zoom Scan (5x5x7)/Cube 0: Measurement grid: dx=8mm, dy=8mm, dz=5mm
Reference Value = 81.92 V/m; Power Drift = 0.10 dB
Peak SAR (extrapolated) = 16.6 W/kg
SAR(1 g) = 9.61 W/kg; SAR(10 g) = 5.22 W/kg
Maximum value of SAR (measured) = 13.4 W/kg

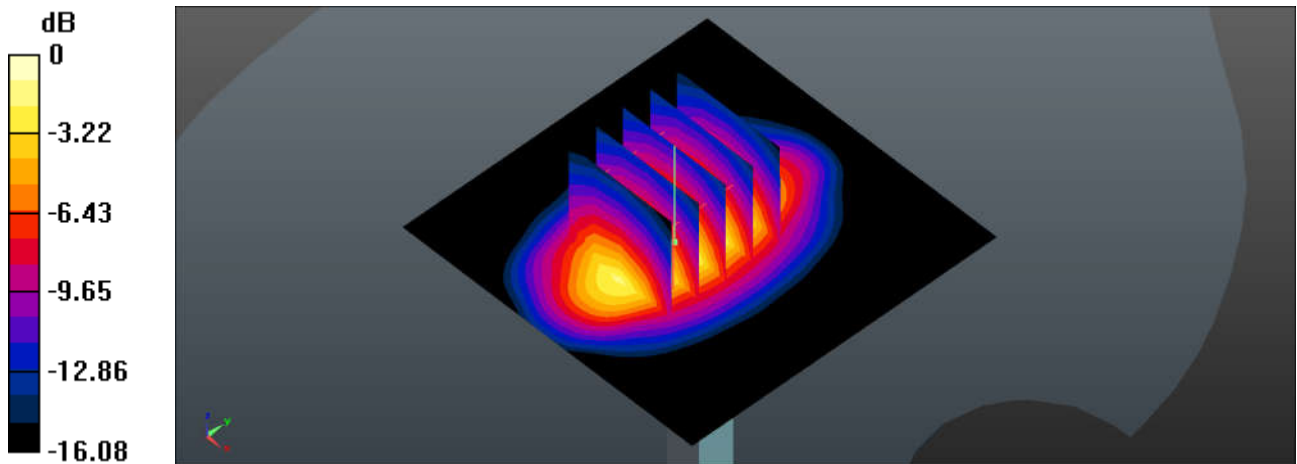

0 dB = 13.4 W/kg = 11.27 dBW/kg

System Check_Body_1900MHz

DUT: D1900V2 - SN:5d118

Communication System: UID 0, CW; Frequency: 1900 MHz; Duty Cycle: 1:1
Medium: MSL_1900 Medium parameters used: $f = 1900$ MHz; $\sigma = 1.539$ S/m; $\epsilon_r = 53.343$; $\rho = 1000$ kg/m³
Ambient Temperature : 23.3 °C ; Liquid Temperature : 22.9 °C

DASY5 Configuration:

- Probe: EX3DV4 - SN3857; ConvF(7.55, 7.55, 7.55); Calibrated: 2016.5.25;
- Sensor-Surface: 2mm (Mechanical Surface Detection)
- Electronics: DAE4 Sn1210; Calibrated: 2016.5.18
- Phantom: SAM2; Type: SAM; Serial: TP-1477
- Measurement SW: DASY52, Version 52.8 (8); SEMCAD X Version 14.6.10 (7331)

Pin=250mW/Area Scan (61x61x1): Interpolated grid: dx=1.500 mm, dy=1.500 mm
Maximum value of SAR (interpolated) = 14.1 W/kg

Pin=250mW/Zoom Scan (5x5x7)/Cube 0: Measurement grid: dx=8mm, dy=8mm, dz=5mm
Reference Value = 84.86 V/m; Power Drift = 0.02 dB
Peak SAR (extrapolated) = 17.7 W/kg
SAR(1 g) = 9.85 W/kg; SAR(10 g) = 5.13 W/kg
Maximum value of SAR (measured) = 14.1 W/kg

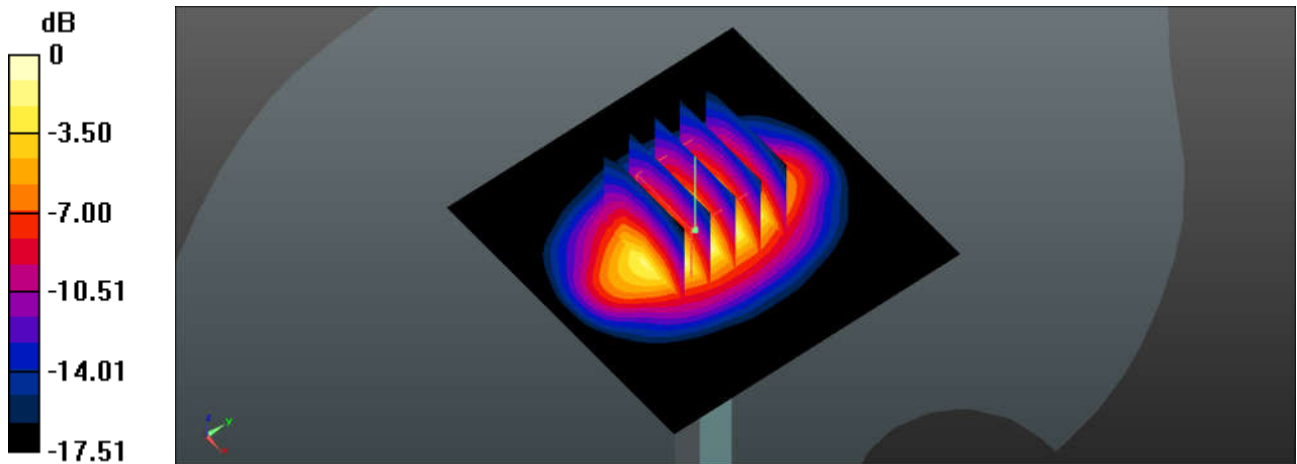

0 dB = 14.1 W/kg = 11.49 dBW/kg

System Check_Body_2450MHz

DUT: D2450V2 - SN:840

Communication System: UID 0, CW (0); Frequency: 2450 MHz; Duty Cycle: 1:1

Medium: MSL_2450 Medium parameters used: $f = 2450$ MHz; $\sigma = 2.026$ S/m; $\epsilon_r = 52.877$; $\rho = 1000$ kg/m³

Ambient Temperature : 23.4 °C ; Liquid Temperature : 22.7 °C

DASY5 Configuration:

- Probe: EX3DV4 - SN3857; ConvF(7.23, 7.23, 7.23); Calibrated: 2016.5.25;
- Sensor-Surface: 2mm (Mechanical Surface Detection)
- Electronics: DAE4 Sn1210; Calibrated: 2016.5.18
- Phantom: SAM1; Type: SAM; Serial: TP-1479
- Measurement SW: DASY52, Version 52.8 (8); SEMCAD X Version 14.6.10 (7331)

Pin=250mW/Area Scan (71x71x1): Interpolated grid: dx=1.200 mm, dy=1.200 mm

Maximum value of SAR (interpolated) = 20.7 W/kg

Pin=250mW/Zoom Scan (7x7x7)/Cube 0: Measurement grid: dx=5mm, dy=5mm, dz=5mm

Reference Value = 72.47 V/m; Power Drift = 0.01 dB

Peak SAR (extrapolated) = 27.3 W/kg

SAR(1 g) = 13.3 W/kg; SAR(10 g) = 6.13 W/kg

Maximum value of SAR (measured) = 20.3 W/kg

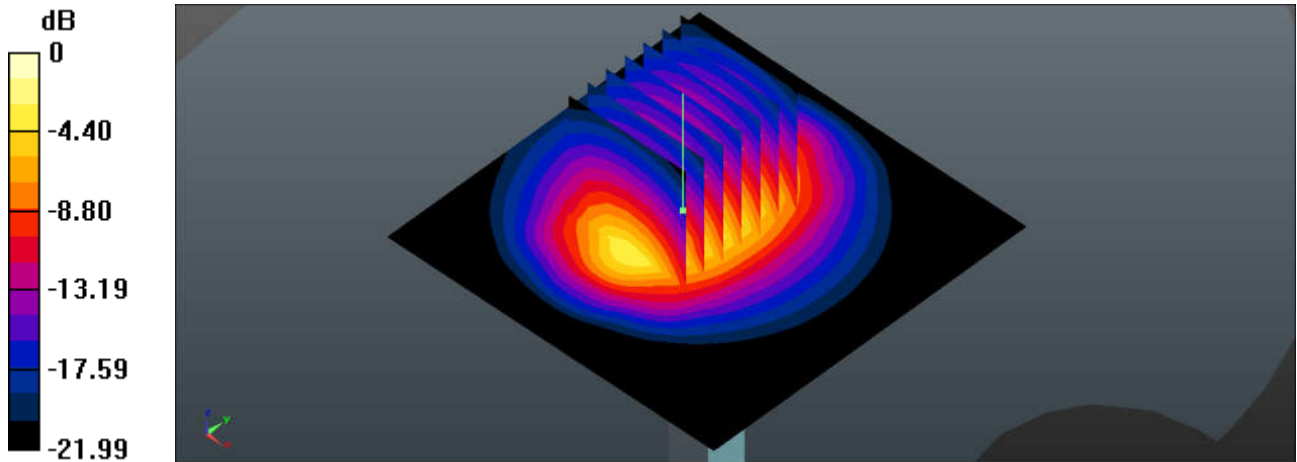

System Check_Body_2600MHz

DUT: D2600V2 - SN:1061

Communication System: UID 0, CW (0); Frequency: 2600 MHz; Duty Cycle: 1:1

Medium: MSL_2600 Medium parameters used: $f = 2600$ MHz; $\sigma = 2.173$ S/m; $\epsilon_r = 52.211$; $\rho = 1000$ kg/m³

Ambient Temperature : 23.4 °C; Liquid Temperature : 22.7 °C

DASY5 Configuration:

- Probe: EX3DV4 - SN3857; ConvF(7.13, 7.13, 7.13); Calibrated: 2016.5.25;
- Sensor-Surface: 2mm (Mechanical Surface Detection)
- Electronics: DAE4 Sn1210; Calibrated: 2016.5.18
- Phantom: SAM1; Type: SAM; Serial: TP-1479
- Measurement SW: DASY52, Version 52.8 (8); SEMCAD X Version 14.6.10 (7331)

Pin=250mW/Area Scan (71x71x1): Interpolated grid: dx=1.200 mm, dy=1.200 mm

Maximum value of SAR (interpolated) = 21.5 W/kg

Pin=250mW/Zoom Scan (7x7x7)/Cube 0: Measurement grid: dx=5mm, dy=5mm, dz=5mm

Reference Value = 71.21 V/m; Power Drift = 0.02 dB

Peak SAR (extrapolated) = 29.6 W/kg

SAR(1 g) = 13.6 W/kg; SAR(10 g) = 6.03 W/kg

Maximum value of SAR (measured) = 21.4 W/kg

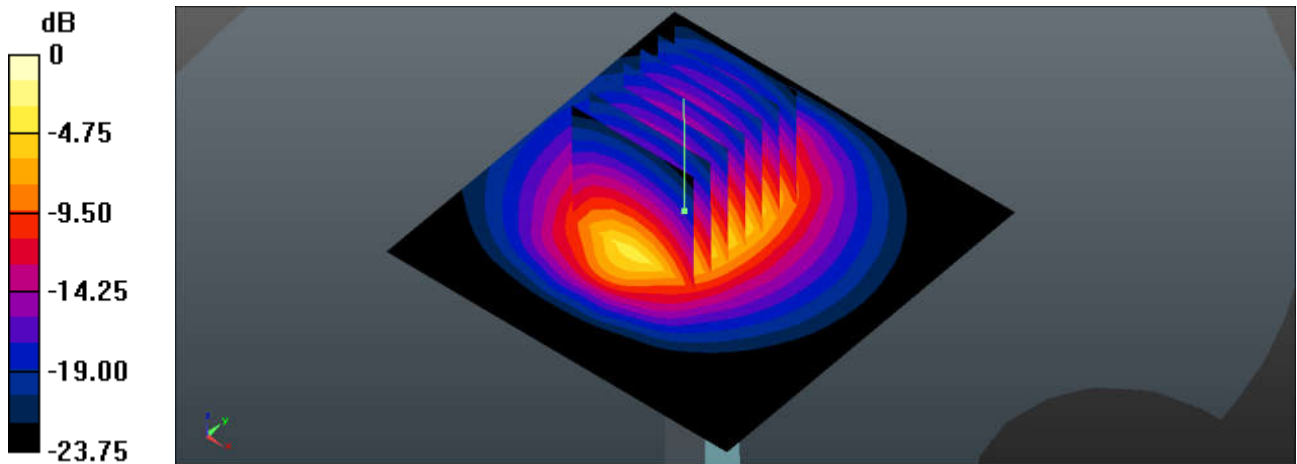

0 dB = 21.4 W/kg = 13.30 dBW/kg

System Check_Body_5250MHz

DUT: D5GHzV2 - SN:1113

Communication System: UID 0, CW (0); Frequency: 5250 MHz;Duty Cycle: 1:1
Medium: MSL_5000 Medium parameters used: $f = 5250$ MHz; $\sigma = 5.412$ S/m; $\epsilon_r = 48.572$; $\rho = 1000$ kg/m³
Ambient Temperature : 23.4 °C ; Liquid Temperature : 22.6 °C

DASY5 Configuration:

- Probe: EX3DV4 - SN3954; ConvF(4.5, 4.5, 4.5); Calibrated: 2016.11.28;
- Sensor-Surface: 1.4mm (Mechanical Surface Detection)
- Electronics: DAE4 Sn1279; Calibrated: 2016.4.4
- Phantom: SAM1; Type: SAM; Serial: TP-1644
- Measurement SW: DASY52, Version 52.8 (8); SEMCAD X Version 14.6.10 (7331)

Pin=100mW/Area Scan (91x91x1): Interpolated grid: dx=1.000 mm, dy=1.000 mm
Maximum value of SAR (interpolated) = 15.8 W/kg

Pin=100mW/Zoom Scan (8x8x7)/Cube 0: Measurement grid: dx=4mm, dy=4mm, dz=1.4mm
Reference Value = 32.52 V/m; Power Drift = -0.15 dB
Peak SAR (extrapolated) = 28.4 W/kg
SAR(1 g) = 7.58 W/kg; SAR(10 g) = 2.23 W/kg
Maximum value of SAR (measured) = 18.1 W/kg

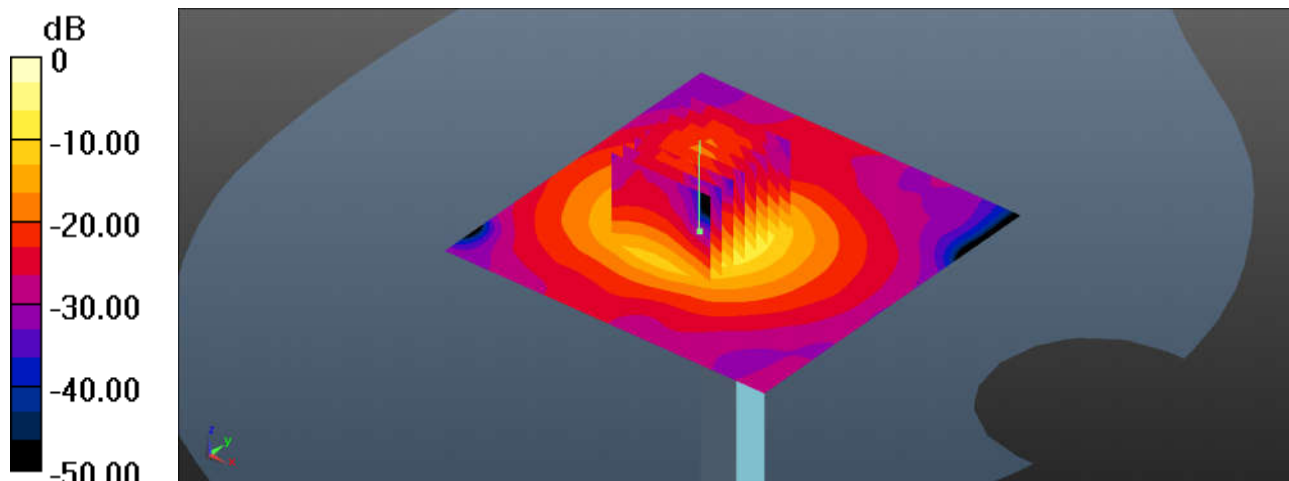

0 dB = 18.1 W/kg = 12.58 dBW/kg

System Check_Body_5600MHz

DUT: D5GHzV2 - SN:1113

Communication System: UID 0, CW (0); Frequency: 5600 MHz; Duty Cycle: 1:1
Medium: MSL_5000 Medium parameters used: $f = 5600$ MHz; $\sigma = 5.851$ S/m; $\epsilon_r = 47.711$; $\rho = 1000$ kg/m³
Ambient Temperature : 23.4 °C ; Liquid Temperature : 22.6 °C

DASY5 Configuration:

- Probe: EX3DV4 - SN3954; ConvF(3.92, 3.92, 3.92); Calibrated: 2016.11.28;
- Sensor-Surface: 1.4mm (Mechanical Surface Detection)
- Electronics: DAE4 Sn1279; Calibrated: 2016.4.4
- Phantom: SAM1; Type: SAM; Serial: TP-1644
- Measurement SW: DASY52, Version 52.8 (8); SEMCAD X Version 14.6.10 (7331)

Pin=100mW/Area Scan (91x91x1): Interpolated grid: dx=1.000 mm, dy=1.000 mm
Maximum value of SAR (interpolated) = 16.5 W/kg

Pin=100mW/Zoom Scan (8x8x7)/Cube 0: Measurement grid: dx=4mm, dy=4mm, dz=1.4mm
Reference Value = 32.14 V/m; Power Drift = -0.07 dB
Peak SAR (extrapolated) = 31.7 W/kg
SAR(1 g) = 7.88 W/kg; SAR(10 g) = 2.28 W/kg
Maximum value of SAR (measured) = 20.0 W/kg

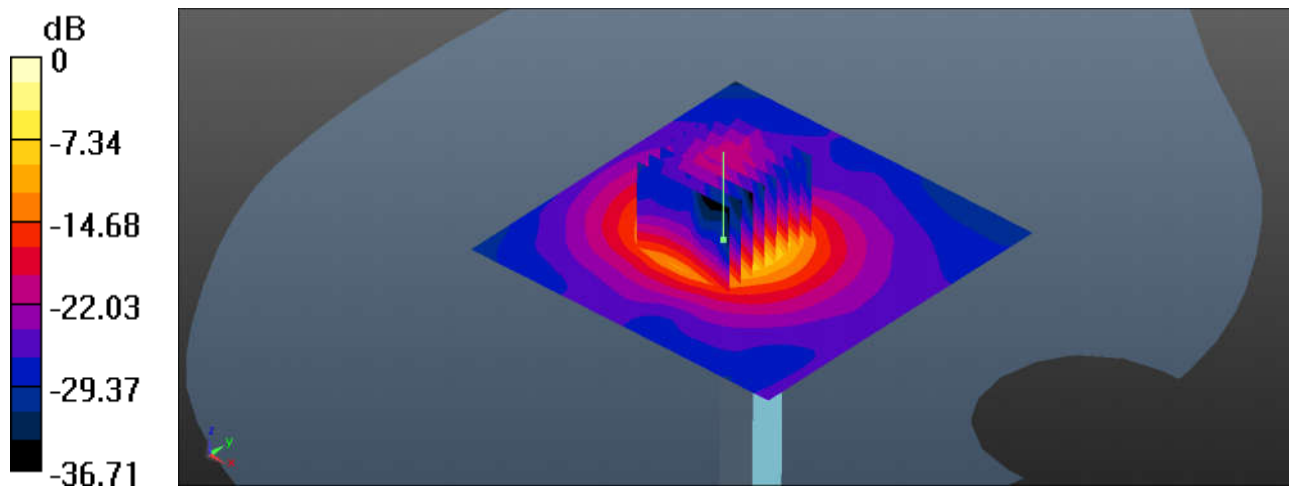

0 dB = 20.0 W/kg = 13.01 dBW/kg

System Check_Body_5750MHz

DUT: D5GHzV2 - SN:1113

Communication System: UID 0, CW (0); Frequency: 5750 MHz; Duty Cycle: 1:1
Medium: MSL_5000 Medium parameters used: $f = 5750$ MHz; $\sigma = 6.062$ S/m; $\epsilon_r = 47.493$; $\rho = 1000$ kg/m³
Ambient Temperature : 23.4 °C ; Liquid Temperature : 22.6 °C

DASY5 Configuration:

- Probe: EX3DV4 - SN3954; ConvF(4.05, 4.05, 4.05); Calibrated: 2016.11.28;
- Sensor-Surface: 1.4mm (Mechanical Surface Detection)
- Electronics: DAE4 Sn1279; Calibrated: 2016.4.4
- Phantom: SAM1; Type: SAM; Serial: TP-1644
- Measurement SW: DASY52, Version 52.8 (8); SEMCAD X Version 14.6.10 (7331)

Pin=100mW/Area Scan (91x91x1): Interpolated grid: dx=1.000 mm, dy=1.000 mm
Maximum value of SAR (interpolated) = 14.9 W/kg

Pin=100mW/Zoom Scan (8x8x7)/Cube 0: Measurement grid: dx=4mm, dy=4mm, dz=1.4mm
Reference Value = 30.06 V/m; Power Drift = -0.04 dB
Peak SAR (extrapolated) = 29.3 W/kg
SAR(1 g) = 7.12 W/kg; SAR(10 g) = 2.06 W/kg
Maximum value of SAR (measured) = 18.3 W/kg

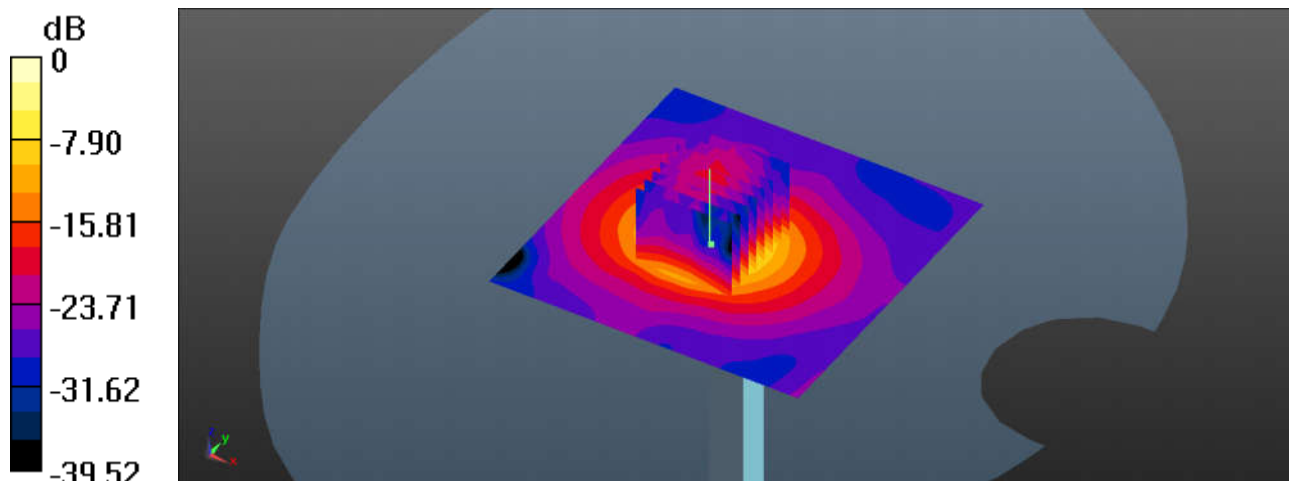

0 dB = 18.3 W/kg = 12.62 dBW/kg



Appendix B. Plots of High SAR Measurement

The plots are shown as follows.

01_GSM850_GPRS 4 Tx slots_Left Cheek_0mm_Ch189

Communication System: UID 0, GPRS/EDGE (4 Tx slots) (0); Frequency: 836.4 MHz; Duty Cycle: 1:2.08

Medium: HSL_835 Medium parameters used: $f = 836.4$ MHz; $\sigma = 0.889$ S/m; $\epsilon_r = 40.907$; $\rho = 1000$ kg/m³

Ambient Temperature : 23.2 °C ; Liquid Temperature : 22.9 °C

DASY5 Configuration:

- Probe: EX3DV4 - SN3954; ConvF(10.52, 10.52, 10.52); Calibrated: 2016.11.28;
- Sensor-Surface: 2mm (Mechanical Surface Detection)
- Electronics: DAE4 Sn1279; Calibrated: 2016.4.4
- Phantom: SAM2; Type: SAM; Serial: TP-1542
- Measurement SW: DASY52, Version 52.8 (8); SEMCAD X Version 14.6.10 (7331)

Ch189/Area Scan (71x111x1): Interpolated grid: dx=1.500 mm, dy=1.500 mm

Maximum value of SAR (interpolated) = 0.521 W/kg

Ch189/Zoom Scan (5x5x7)/Cube 0: Measurement grid: dx=8mm, dy=8mm, dz=5mm

Reference Value = 14.81 V/m; Power Drift = 0.13 dB

Peak SAR (extrapolated) = 0.559 W/kg

SAR(1 g) = 0.439 W/kg; SAR(10 g) = 0.336 W/kg

Maximum value of SAR (measured) = 0.499 W/kg

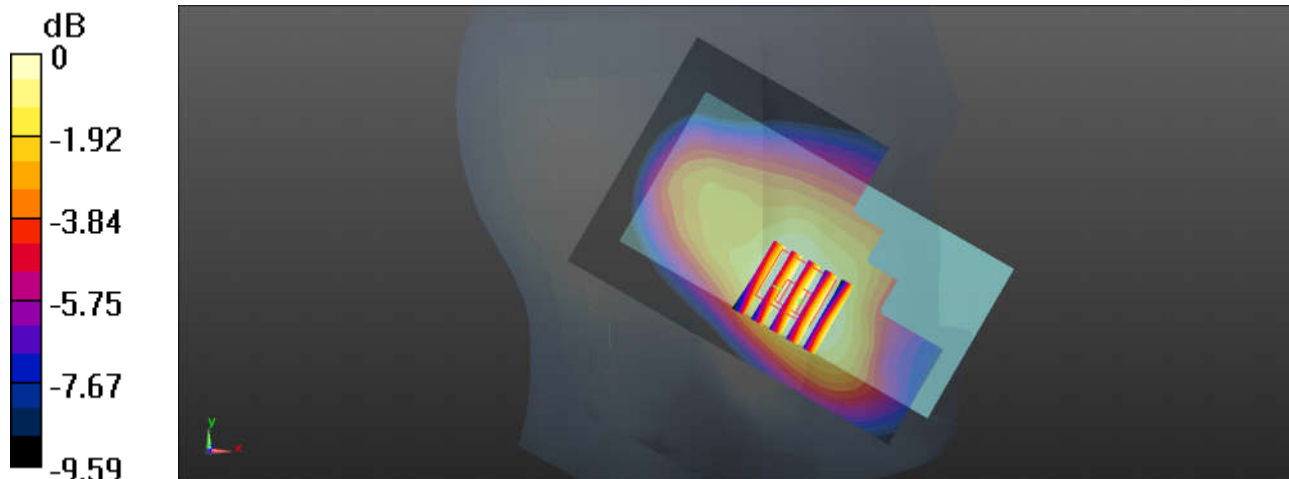

0 dB = 0.499 W/kg = -3.02 dBW/kg

02_GSM 1900_GPRS 4 Tx slots_Left Cheek_0mm_Ch810

Communication System: UID 0, GPRS/EDGE (4 Tx slots) (0); Frequency: 1909.8 MHz; Duty Cycle: 1:2.08

Medium: HSL_1900 Medium parameters used: $f = 1909.8$ MHz; $\sigma = 1.44$ S/m; $\epsilon_r = 39.983$; $\rho = 1000$

kg/m³

Ambient Temperature : 23.4 °C; Liquid Temperature : 22.7 °C

DASY5 Configuration:

- Probe: EX3DV4 - SN3857; ConvF(7.85, 7.85, 7.85); Calibrated: 2016.5.25;
- Sensor-Surface: 2mm (Mechanical Surface Detection)
- Electronics: DAE4 Sn1210; Calibrated: 2016.5.18
- Phantom: SAM1; Type: SAM; Serial: TP-1479
- Measurement SW: DASY52, Version 52.8 (8); SEMCAD X Version 14.6.10 (7331)

Ch810/Area Scan (61x111x1): Interpolated grid: dx=1.500 mm, dy=1.500 mm

Maximum value of SAR (interpolated) = 0.196 W/kg

Ch810/Zoom Scan (5x5x7)/Cube 0: Measurement grid: dx=8mm, dy=8mm, dz=5mm

Reference Value = 5.418 V/m; Power Drift = 0.03 dB

Peak SAR (extrapolated) = 0.245 W/kg

SAR(1 g) = 0.136 W/kg; SAR(10 g) = 0.068 W/kg

Maximum value of SAR (measured) = 0.190 W/kg

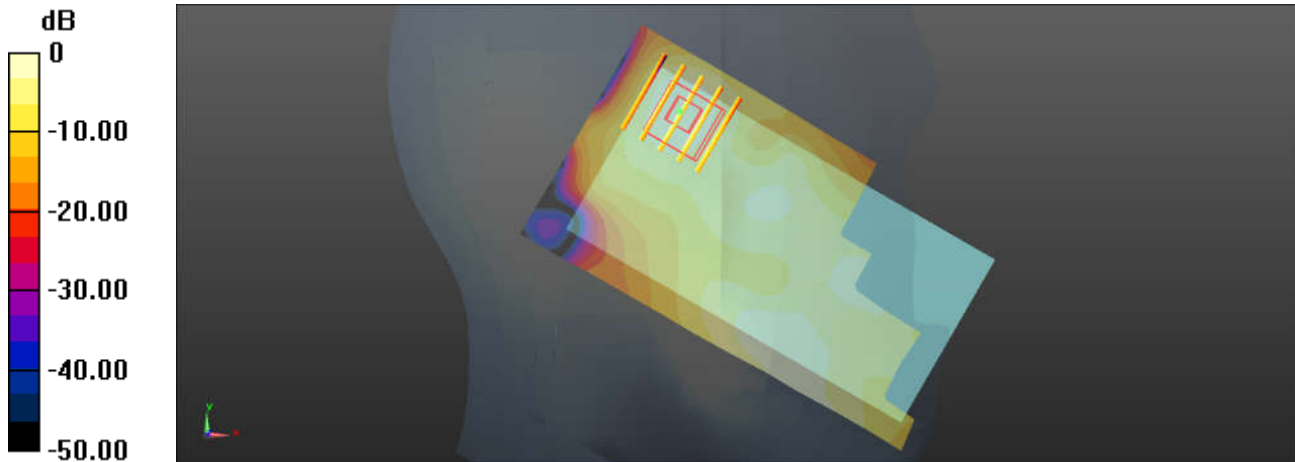

0 dB = 0.190 W/kg = -7.21 dBW/kg

03_WCDMA Band V_RMC 12.2Kbps_Left Cheek_0mm_Ch4233

Communication System: UID 0, UMTS (0); Frequency: 846.6 MHz; Duty Cycle: 1:1
Medium: HSL_835 Medium parameters used: $f = 846.6$ MHz; $\sigma = 0.899$ S/m; $\epsilon_r = 40.779$; $\rho = 1000$ kg/m³
Ambient Temperature : 23.2 °C ; Liquid Temperature : 22.9 °C

DASY5 Configuration:

- Probe: EX3DV4 - SN3954; ConvF(10.52, 10.52, 10.52); Calibrated: 2016.11.28;
- Sensor-Surface: 2mm (Mechanical Surface Detection)
- Electronics: DAE4 Sn1279; Calibrated: 2016.4.4
- Phantom: SAM2; Type: SAM; Serial: TP-1542
- Measurement SW: DASY52, Version 52.8 (8); SEMCAD X Version 14.6.10 (7331)

Ch4233/Area Scan (71x111x1): Interpolated grid: dx=1.500 mm, dy=1.500 mm
Maximum value of SAR (interpolated) = 0.393 W/kg

Ch4233/Zoom Scan (5x5x7)/Cube 0: Measurement grid: dx=8mm, dy=8mm, dz=5mm
Reference Value = 11.95 V/m; Power Drift = 0.07 dB
Peak SAR (extrapolated) = 0.425 W/kg
SAR(1 g) = 0.329 W/kg; SAR(10 g) = 0.252 W/kg
Maximum value of SAR (measured) = 0.377 W/kg

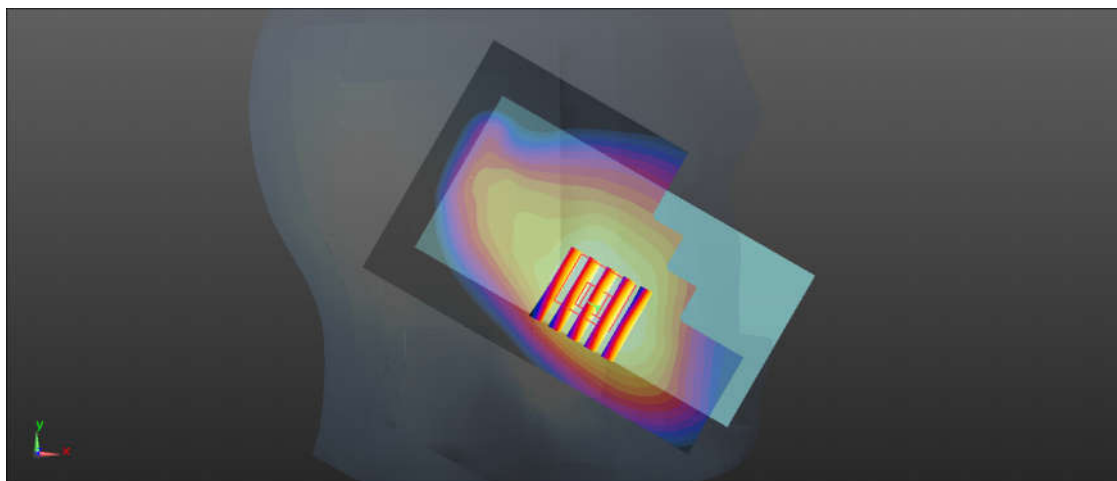
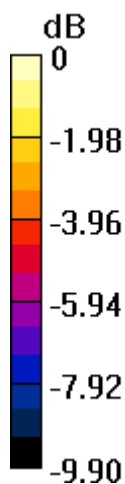

0 dB = 0.377 W/kg = -4.24 dBW/kg

04_WCDMA Band IV_RMC 12.2Kbps_Right Cheek_0mm_Ch1312

Communication System: UID 0, UMTS (0); Frequency: 1712.4 MHz; Duty Cycle: 1:1

Medium: HSL_1750 Medium parameters used: $f = 1712.4$ MHz; $\sigma = 1.363$ S/m; $\epsilon_r = 39.215$; $\rho = 1000$ kg/m³

Ambient Temperature : 23.4 °C; Liquid Temperature : 22.7 °C

DASY5 Configuration:

- Probe: EX3DV4 - SN3857; ConvF(8, 8, 8); Calibrated: 2016.5.25;
- Sensor-Surface: 2mm (Mechanical Surface Detection)
- Electronics: DAE4 Sn1210; Calibrated: 2016.5.18
- Phantom: SAM1; Type: SAM; Serial: TP-1479
- Measurement SW: DASY52, Version 52.8 (8); SEMCAD X Version 14.6.10 (7331)

Ch1312/Area Scan (61x111x1): Interpolated grid: dx=1.500 mm, dy=1.500 mm

Maximum value of SAR (interpolated) = 0.397 W/kg

Ch1312/Zoom Scan (5x5x7)/Cube 0: Measurement grid: dx=8mm, dy=8mm, dz=5mm

Reference Value = 9.100 V/m; Power Drift = -0.02 dB

Peak SAR (extrapolated) = 0.445 W/kg

SAR(1 g) = 0.297 W/kg; SAR(10 g) = 0.192 W/kg

Maximum value of SAR (measured) = 0.367 W/kg

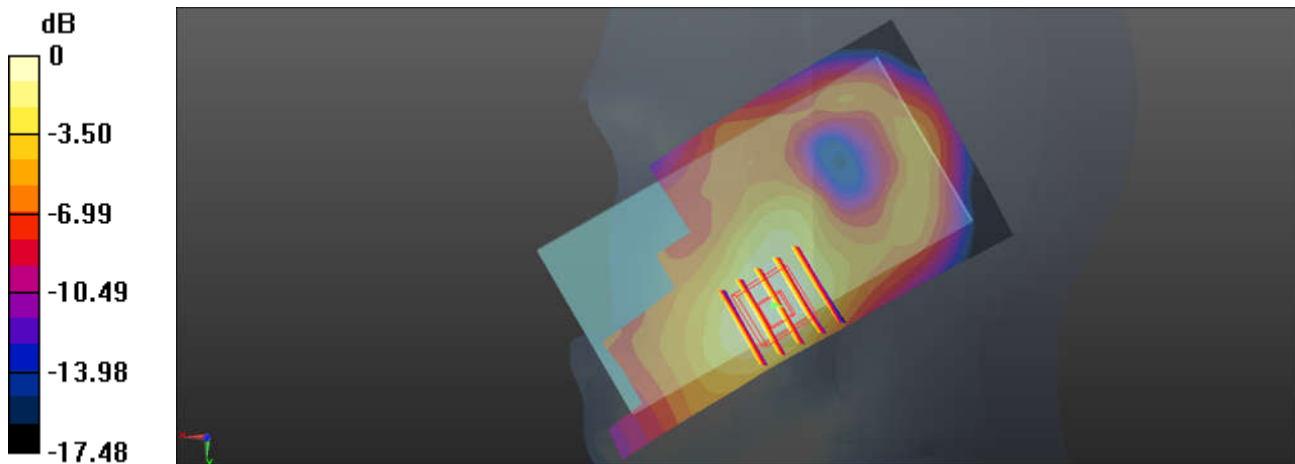

0 dB = 0.367 W/kg = -4.35 dBW/kg

05_WCDMA Band II_RMC 12.2Kbps_Left Cheek_0mm_Ch9538

Communication System: UID 0, UMTS (0); Frequency: 1907.6 MHz; Duty Cycle: 1:1
 Medium: HSL_1900 Medium parameters used: $f = 1907.6 \text{ MHz}$; $\sigma = 1.438 \text{ S/m}$; $\epsilon_r = 39.992$; $\rho = 1000 \text{ kg/m}^3$
 Ambient Temperature : $23.4 \text{ }^\circ\text{C}$; Liquid Temperature : $22.7 \text{ }^\circ\text{C}$

DASY5 Configuration:

- Probe: EX3DV4 - SN3857; ConvF(7.85, 7.85, 7.85); Calibrated: 2016.5.25;
- Sensor-Surface: 2mm (Mechanical Surface Detection)
- Electronics: DAE4 Sn1210; Calibrated: 2016.5.18
- Phantom: SAM1; Type: SAM; Serial: TP-1479
- Measurement SW: DASY52, Version 52.8 (8); SEMCAD X Version 14.6.10 (7331)

Ch9538/Area Scan (61x111x1): Interpolated grid: $dx=1.500 \text{ mm}$, $dy=1.500 \text{ mm}$
 Maximum value of SAR (interpolated) = 0.276 W/kg

Ch9538/Zoom Scan (5x5x7)/Cube 0: Measurement grid: $dx=8\text{mm}$, $dy=8\text{mm}$, $dz=5\text{mm}$
 Reference Value = 6.567 V/m ; Power Drift = 0.14 dB
 Peak SAR (extrapolated) = 0.348 W/kg
SAR(1 g) = 0.193 W/kg ; SAR(10 g) = 0.098 W/kg
 Maximum value of SAR (measured) = 0.268 W/kg

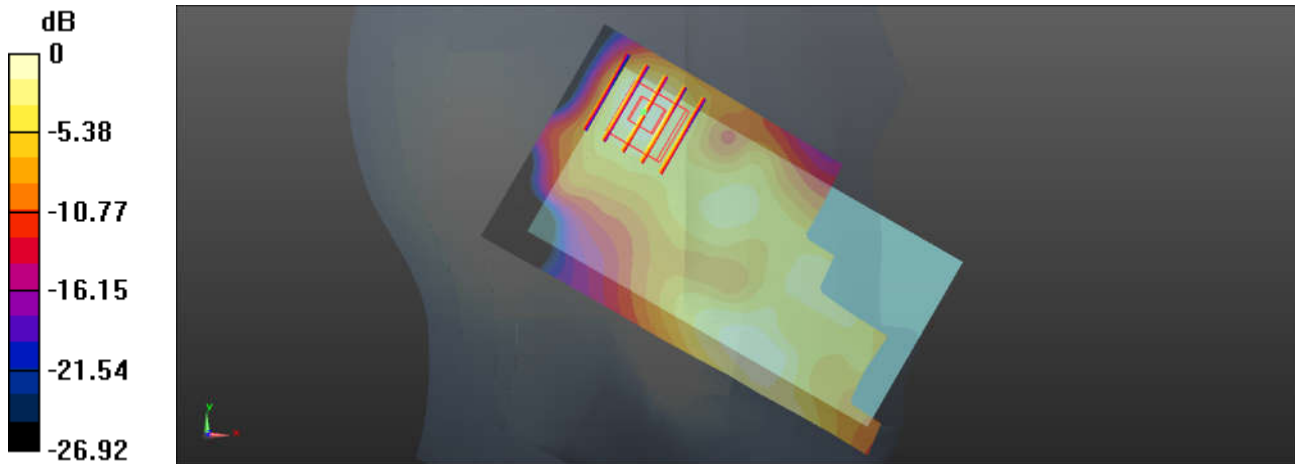

0 dB = $0.268 \text{ W/kg} = -5.72 \text{ dBW/kg}$

06_LTE Band 12_10M_QPSK_1RB_0Offset_Right Cheek_0mm_Ch23095

Communication System: UID 0, FDD_LTE (0); Frequency: 707.5 MHz; Duty Cycle: 1:1
Medium: HSL_750 Medium parameters used: $f = 707.5$ MHz; $\sigma = 0.866$ S/m; $\epsilon_r = 42.823$; $\rho = 1000$

kg/m³

Ambient Temperature : 23.2 °C ; Liquid Temperature : 22.9 °C

DASY5 Configuration:

- Probe: EX3DV4 - SN3954; ConvF(10.98, 10.98, 10.98); Calibrated: 2016.11.28;
- Sensor-Surface: 2mm (Mechanical Surface Detection)
- Electronics: DAE4 Sn1279; Calibrated: 2016.4.4
- Phantom: SAM2; Type: SAM; Serial: TP-1542
- Measurement SW: DASY52, Version 52.8 (8); SEMCAD X Version 14.6.10 (7331)

Ch23095/Area Scan (71x111x1): Interpolated grid: dx=1.500 mm, dy=1.500 mm

Maximum value of SAR (interpolated) = 0.209 W/kg

Ch23095/Zoom Scan (5x5x7)/Cube 0: Measurement grid: dx=8mm, dy=8mm, dz=5mm

Reference Value = 6.412 V/m; Power Drift = 0.19 dB

Peak SAR (extrapolated) = 0.222 W/kg

SAR(1 g) = 0.185 W/kg; SAR(10 g) = 0.146 W/kg

Maximum value of SAR (measured) = 0.205 W/kg

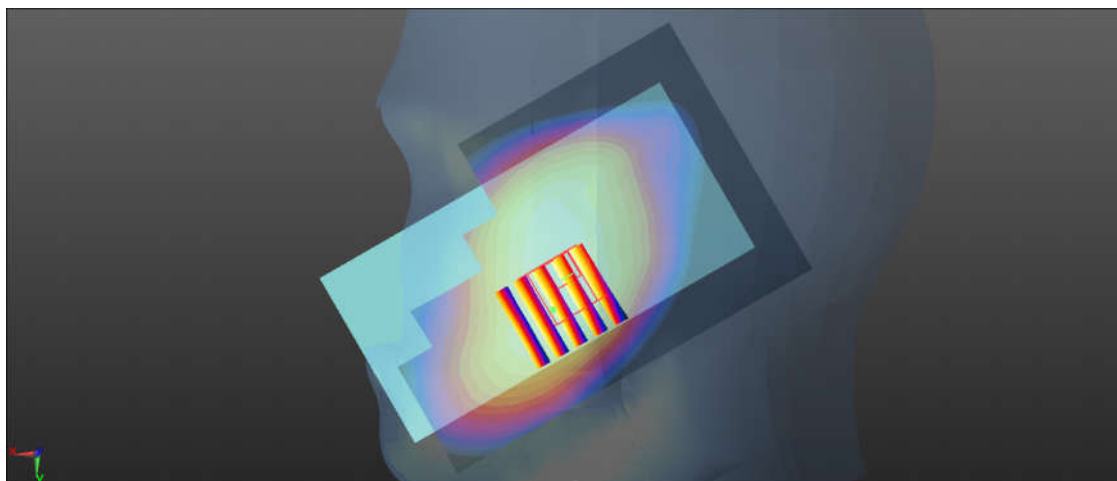
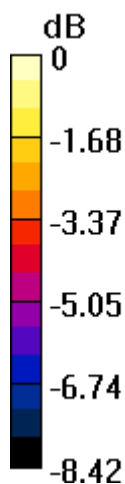

0 dB = 0.205 W/kg = -6.88 dBW/kg

07_LTE Band 4_20M_QPSK_1RB_0Offset_Right Cheek_0mm_Ch20175

Communication System: UID 0, FDD_LTE (0); Frequency: 1732.5 MHz; Duty Cycle: 1:1
Medium: HSL_1750 Medium parameters used: $f = 1732.5$ MHz; $\sigma = 1.385$ S/m; $\epsilon_r = 39.135$; $\rho = 1000$ kg/m³
Ambient Temperature : 23.4 °C; Liquid Temperature : 22.7 °C

DASY5 Configuration:

- Probe: EX3DV4 - SN3857; ConvF(8, 8, 8); Calibrated: 2016.5.25;
- Sensor-Surface: 2mm (Mechanical Surface Detection)
- Electronics: DAE4 Sn1210; Calibrated: 2016.5.18
- Phantom: SAM1; Type: SAM; Serial: TP-1479
- Measurement SW: DASY52, Version 52.8 (8); SEMCAD X Version 14.6.10 (7331)

Ch20175/Area Scan (61x111x1): Interpolated grid: dx=1.500 mm, dy=1.500 mm
Maximum value of SAR (interpolated) = 0.383 W/kg

Ch20175/Zoom Scan (5x5x7)/Cube 0: Measurement grid: dx=8mm, dy=8mm, dz=5mm
Reference Value = 11.36 V/m; Power Drift = -0.06 dB
Peak SAR (extrapolated) = 0.418 W/kg
SAR(1 g) = 0.291 W/kg; SAR(10 g) = 0.194 W/kg
Maximum value of SAR (measured) = 0.352 W/kg

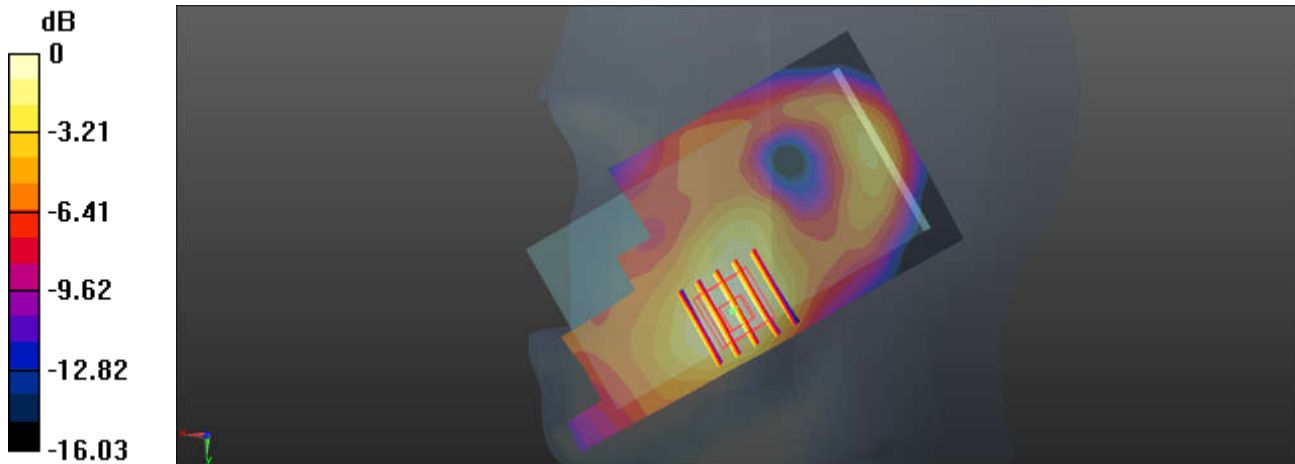

0 dB = 0.352 W/kg = -4.53 dBW/kg

08_LTE Band 2_20M_QPSK_1RB_0Offset_Right Cheek_0mm_Ch18700

Communication System: UID 0, FDD_LTE (0); Frequency: 1860 MHz; Duty Cycle: 1:1
Medium: HSL_1900 Medium parameters used: $f = 1860$ MHz; $\sigma = 1.386$ S/m; $\epsilon_r = 40.177$; $\rho = 1000$ kg/m³
Ambient Temperature : 23.4 °C; Liquid Temperature : 22.7 °C

DASY5 Configuration:

- Probe: EX3DV4 - SN3857; ConvF(7.85, 7.85, 7.85); Calibrated: 2016.5.25;
- Sensor-Surface: 2mm (Mechanical Surface Detection)
- Electronics: DAE4 Sn1210; Calibrated: 2016.5.18
- Phantom: SAM1; Type: SAM; Serial: TP-1479
- Measurement SW: DASY52, Version 52.8 (8); SEMCAD X Version 14.6.10 (7331)

Ch18700/Area Scan (61x111x1): Interpolated grid: dx=1.500 mm, dy=1.500 mm
Maximum value of SAR (interpolated) = 0.257 W/kg

Ch18700/Zoom Scan (5x5x7)/Cube 0: Measurement grid: dx=8mm, dy=8mm, dz=5mm
Reference Value = 6.089 V/m; Power Drift = 0.03 dB
Peak SAR (extrapolated) = 0.314 W/kg
SAR(1 g) = 0.206 W/kg; SAR(10 g) = 0.126 W/kg
Maximum value of SAR (measured) = 0.265 W/kg

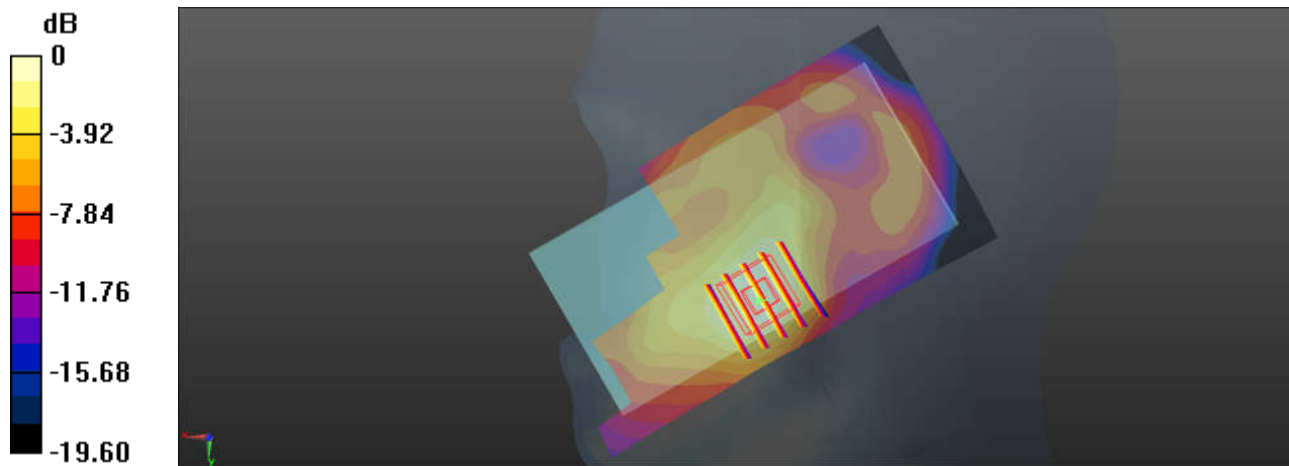

0 dB = 0.265 W/kg = -5.77 dBW/kg

09_LTE Band 7_20M_QPSK_1RB_0Offset_Left Cheek_0mm_Ch21100

Communication System: UID 0, FDD_LTE (0); Frequency: 2535 MHz; Duty Cycle: 1:1
Medium: HSL_2600 Medium parameters used: $f = 2535$ MHz; $\sigma = 1.934$ S/m; $\epsilon_r = 38.042$; $\rho = 1000$ kg/m³
Ambient Temperature : 23.4 °C; Liquid Temperature : 22.9 °C

DASY5 Configuration:

- Probe: EX3DV4 - SN3857; ConvF(7.08, 7.08, 7.08); Calibrated: 2016.5.25;
- Sensor-Surface: 2mm (Mechanical Surface Detection)
- Electronics: DAE4 Sn1210; Calibrated: 2016.5.18
- Phantom: SAM2; Type: SAM; Serial: TP-1477
- Measurement SW: DASY52, Version 52.8 (8); SEMCAD X Version 14.6.10 (7331)

Ch21100/Area Scan (81x141x1): Interpolated grid: dx=1.200 mm, dy=1.200 mm
Maximum value of SAR (interpolated) = 0.216 W/kg

Ch21100/Zoom Scan (7x7x7)/Cube 0: Measurement grid: dx=5mm, dy=5mm, dz=5mm
Reference Value = 1.858 V/m; Power Drift = 0.02 dB
Peak SAR (extrapolated) = 0.250 W/kg
SAR(1 g) = 0.133 W/kg; SAR(10 g) = 0.067 W/kg
Maximum value of SAR (measured) = 0.191 W/kg

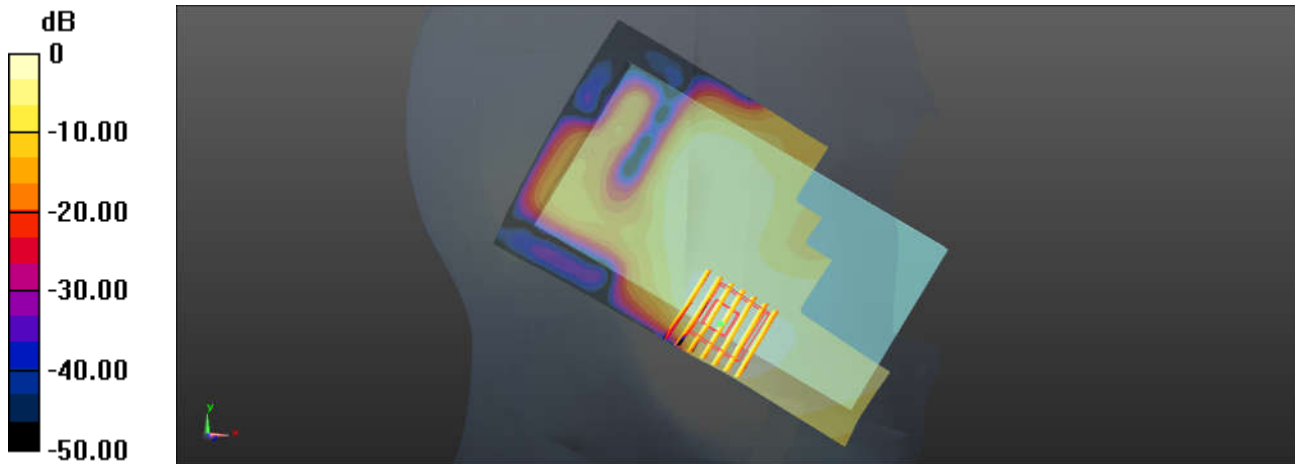

0 dB = 0.191 W/kg = -7.19 dBW/kg

10_LTE Band 38_20M_QPSK_1RB_0Offset_Left Cheek_0mm_Ch38000

Communication System: UID 0, TDD_LTE (0); Frequency: 2595 MHz; Duty Cycle: 1:1.59
Medium: HSL_2600 Medium parameters used: $f = 2595$ MHz; $\sigma = 2.001$ S/m; $\epsilon_r = 37.809$; $\rho = 1000$ kg/m³
Ambient Temperature : 23.4 °C; Liquid Temperature : 22.9 °C

DASY5 Configuration:

- Probe: EX3DV4 - SN3857; ConvF(7.08, 7.08, 7.08); Calibrated: 2016.5.25;
- Sensor-Surface: 2mm (Mechanical Surface Detection)
- Electronics: DAE4 Sn1210; Calibrated: 2016.5.18
- Phantom: SAM2; Type: SAM; Serial: TP-1477
- Measurement SW: DASY52, Version 52.8 (8); SEMCAD X Version 14.6.10 (7331)

Ch38000/Area Scan (81x141x1): Interpolated grid: dx=1.200 mm, dy=1.200 mm
Maximum value of SAR (interpolated) = 0.122 W/kg

Ch38000/Zoom Scan (7x7x7)/Cube 0: Measurement grid: dx=5mm, dy=5mm, dz=5mm
Reference Value = 1.154 V/m; Power Drift = 0.02 dB
Peak SAR (extrapolated) = 0.158 W/kg
SAR(1 g) = 0.078 W/kg; SAR(10 g) = 0.036 W/kg
Maximum value of SAR (measured) = 0.114 W/kg

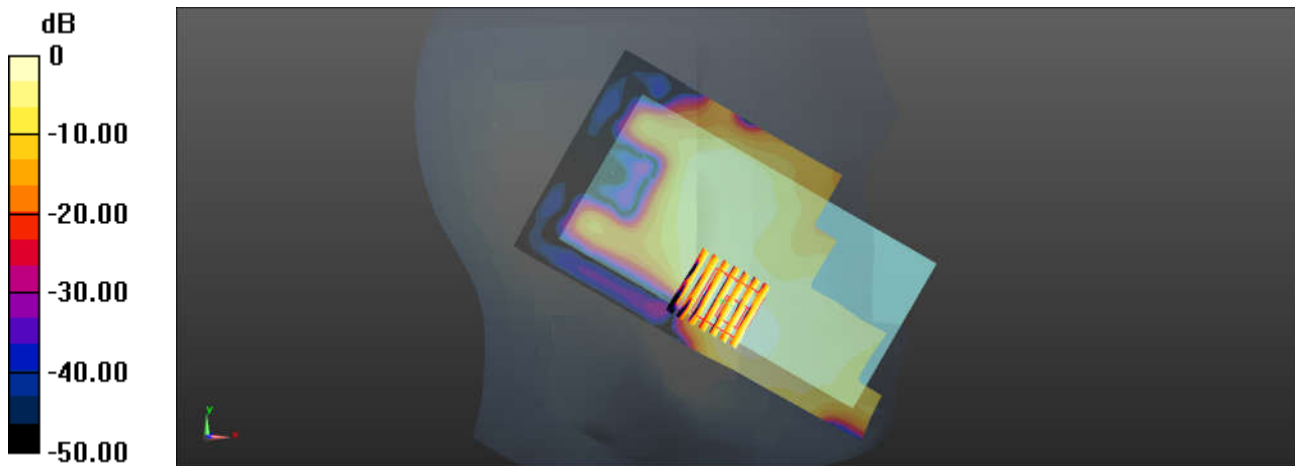

0 dB = 0.114 W/kg = -9.43 dBW/kg

11_WLAN2.4GHz_802.11b 1Mbps_Right Cheek_10mm_Ch6

Communication System: UID 0, WIFI (0); Frequency: 2437 MHz; Duty Cycle: 1:1

Medium: HSL_2450 Medium parameters used: $f = 2437$ MHz; $\sigma = 1.824$ S/m; $\epsilon_r = 38.429$; $\rho = 1000$ kg/m³

Ambient Temperature : 23.4 °C; Liquid Temperature : 22.9 °C

DASY5 Configuration:

- Probe: EX3DV4 - SN3857; ConvF(7.19, 7.19, 7.19); Calibrated: 2016.5.25;
- Sensor-Surface: 2mm (Mechanical Surface Detection)
- Electronics: DAE4 Sn1210; Calibrated: 2016.5.18
- Phantom: SAM2; Type: SAM; Serial: TP-1477
- Measurement SW: DASY52, Version 52.8 (8); SEMCAD X Version 14.6.10 (7331)

Ch6/Area Scan (81x151x1): Interpolated grid: dx=1.200 mm, dy=1.200 mm

Maximum value of SAR (interpolated) = 1.09 W/kg

Ch6/Zoom Scan (7x7x7)/Cube 0: Measurement grid: dx=5mm, dy=5mm, dz=5mm

Reference Value = 11.71 V/m; Power Drift = -0.14 dB

Peak SAR (extrapolated) = 1.73 W/kg

SAR(1 g) = 0.668 W/kg; SAR(10 g) = 0.283 W/kg

Maximum value of SAR (measured) = 1.15 W/kg

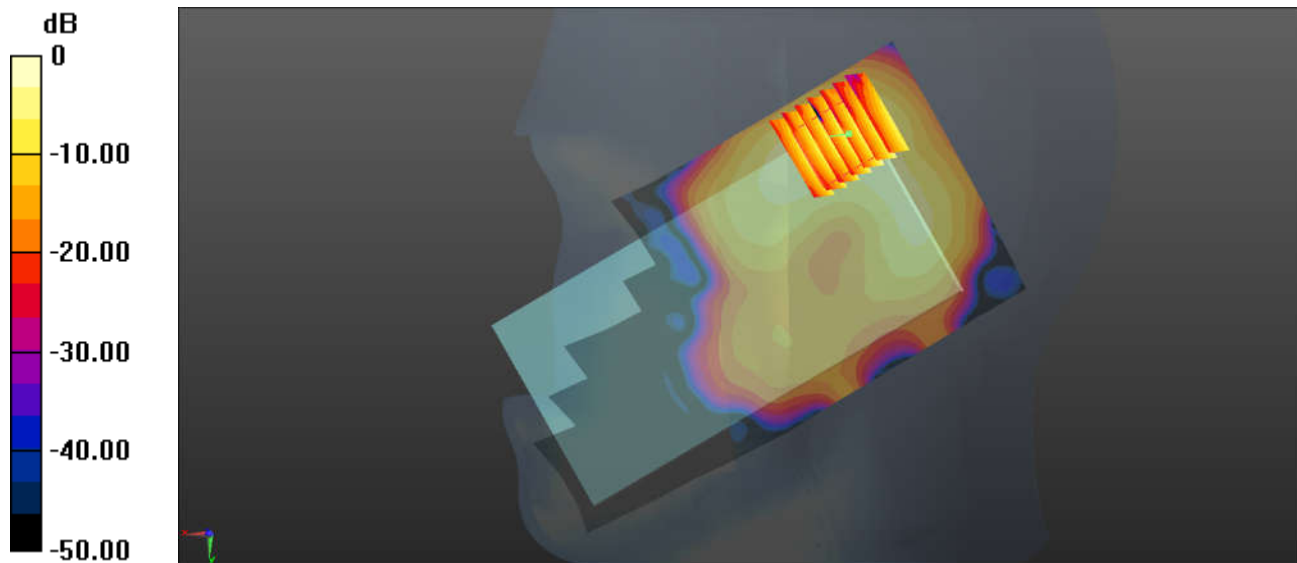

0 dB = 1.15 W/kg = 0.61 dBW/kg

12_WLAN 5.3GHz_802.11a 6Mbps_Right Cheek_0mm_Ch64

Communication System: UID 0, WIFI (0); Frequency: 5320 MHz; Duty Cycle: 1:1.029
Medium: HSL_5000 Medium parameters used: $f = 5320$ MHz; $\sigma = 4.681$ S/m; $\epsilon_r = 36.165$; $\rho = 1000$ kg/m³
Ambient Temperature : 23.5 °C; Liquid Temperature : 22.5 °C

DASY5 Configuration:

- Probe: EX3DV4 - SN3954; ConvF(5.08, 5.08, 5.08); Calibrated: 2016.11.28;
- Sensor-Surface: 1.4mm (Mechanical Surface Detection)
- Electronics: DAE4 Sn1279; Calibrated: 2016.4.4
- Phantom: SAM2; Type: SAM; Serial: TP-1542
- Measurement SW: DASY52, Version 52.8 (8); SEMCAD X Version 14.6.10 (7331)

Ch64/Area Scan (91x161x1): Interpolated grid: dx=1.000 mm, dy=1.000 mm
Maximum value of SAR (interpolated) = 0.109 W/kg

Ch64/Zoom Scan (8x8x7)/Cube 0: Measurement grid: dx=4mm, dy=4mm, dz=1.4mm
Reference Value = 0.7510 V/m; Power Drift = 0.04 dB
Peak SAR (extrapolated) = 0.342 W/kg
SAR(1 g) = 0.026 W/kg; SAR(10 g) = 0.00512 W/kg
Maximum value of SAR (measured) = 0.124 W/kg

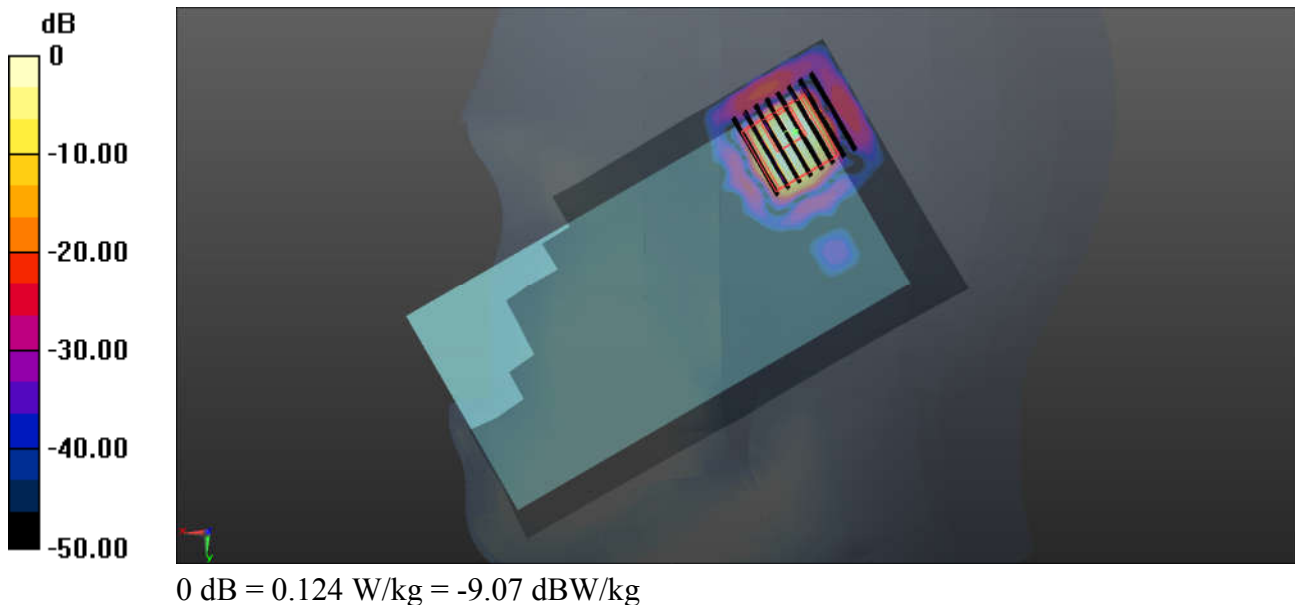

13_WLAN 5.5GHz_802.11a 6Mbps_Right Cheek_0mm_Ch100

Communication System: UID 0, WIFI (0); Frequency: 5500 MHz; Duty Cycle: 1:1.029
Medium: HSL_5000 Medium parameters used: $f = 5500$ MHz; $\sigma = 4.86$ S/m; $\epsilon_r = 35.928$; $\rho = 1000$ kg/m³
Ambient Temperature : 23.5 °C ; Liquid Temperature : 22.5 °C

DASY5 Configuration:

- Probe: EX3DV4 - SN3954; ConvF(4.7, 4.7, 4.7); Calibrated: 2016.11.28;
- Sensor-Surface: 1.4mm (Mechanical Surface Detection)
- Electronics: DAE4 Sn1279; Calibrated: 2016.4.4
- Phantom: SAM2; Type: SAM; Serial: TP-1542
- Measurement SW: DASY52, Version 52.8 (8); SEMCAD X Version 14.6.10 (7331)

Ch100/Area Scan (91x161x1): Interpolated grid: dx=1.000 mm, dy=1.000 mm
Maximum value of SAR (interpolated) = 0.180 W/kg

Ch100/Zoom Scan (8x8x7)/Cube 0: Measurement grid: dx=4mm, dy=4mm, dz=1.4mm
Reference Value = 0 V/m; Power Drift = 0.00 dB
Peak SAR (extrapolated) = 0.326 W/kg
SAR(1 g) = 0.035 W/kg; SAR(10 g) = 0.0055 W/kg
Maximum value of SAR (measured) = 0.183 W/kg

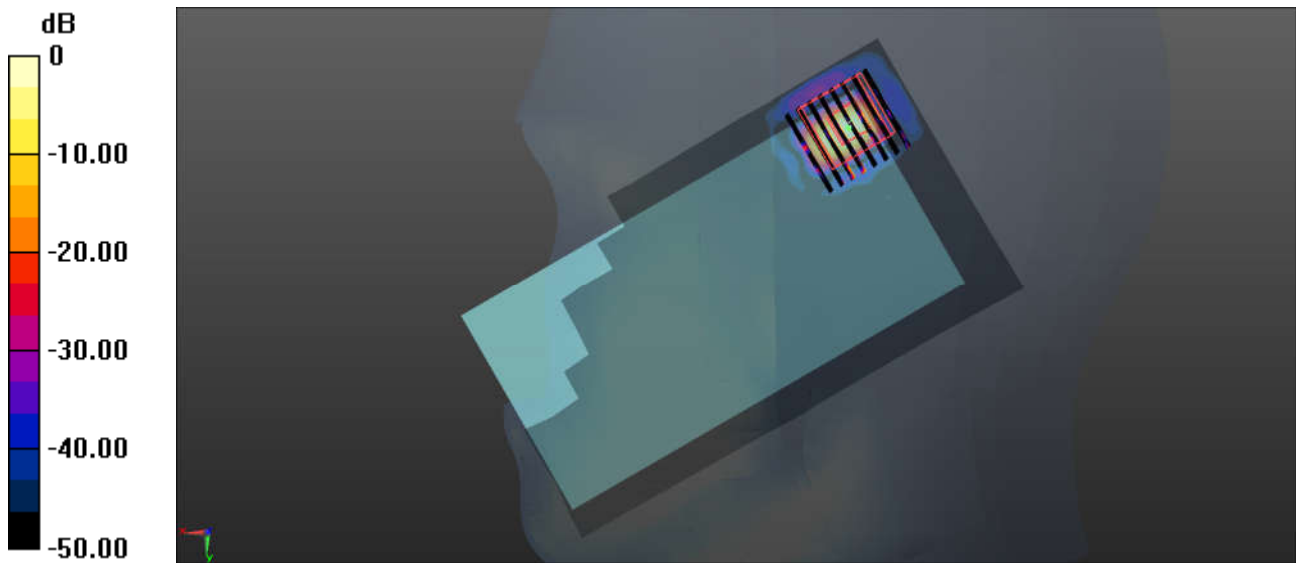

0 dB = 0.183 W/kg = -7.38 dBW/kg

14_WLAN 5.8GHz_802.11a 6Mbps_Right Cheek_0mm_Ch157

Communication System: UID 0, WIFI (0); Frequency: 5785 MHz; Duty Cycle: 1:1.029
Medium: HSL_5000 Medium parameters used: $f = 5785$ MHz; $\sigma = 5.162$ S/m; $\epsilon_r = 35.535$; $\rho = 1000$ kg/m³
Ambient Temperature : 23.5 °C; Liquid Temperature : 22.5 °C

DASY5 Configuration:

- Probe: EX3DV4 - SN3954; ConvF(4.69, 4.69, 4.69); Calibrated: 2016.11.28;
- Sensor-Surface: 1.4mm (Mechanical Surface Detection)
- Electronics: DAE4 Sn1279; Calibrated: 2016.4.4
- Phantom: SAM2; Type: SAM; Serial: TP-1542
- Measurement SW: DASY52, Version 52.8 (8); SEMCAD X Version 14.6.10 (7331)

Ch157/Area Scan (91x161x1): Interpolated grid: dx=1.000 mm, dy=1.000 mm
Maximum value of SAR (interpolated) = 0.355 W/kg

Ch157/Zoom Scan (8x8x7)/Cube 0: Measurement grid: dx=4mm, dy=4mm, dz=1.4mm
Reference Value = 0 V/m; Power Drift = 0.18dB
Peak SAR (extrapolated) = 0.497 W/kg
SAR(1 g) = 0.064 W/kg; SAR(10 g) = 0.011 W/kg
Maximum value of SAR (measured) = 0.240 W/kg

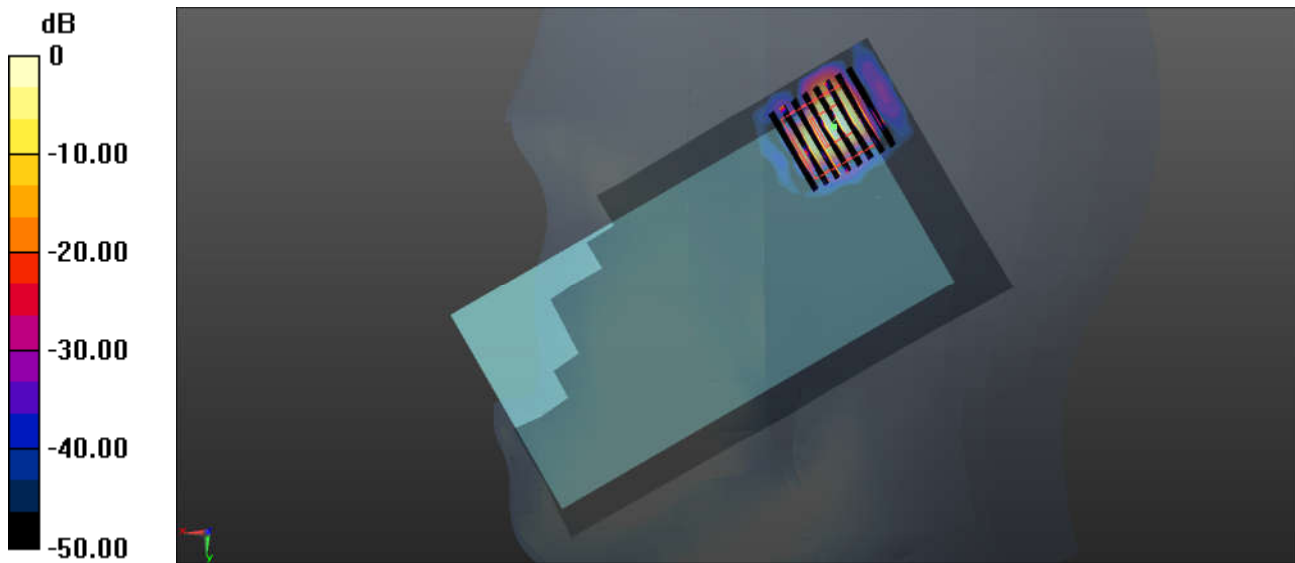

0 dB = 0.240 W/kg = -6.20 dBW/kg

15_GSM 850_GPRS 4 Tx slots_Left Side_10mm_Ch189

Communication System: UID 0, GPRS/EDGE (4 Tx slots) (0); Frequency: 836.4 MHz; Duty Cycle: 1:2.08

Medium: MSL_835 Medium parameters used: $f = 836.4$ MHz; $\sigma = 0.99$ S/m; $\epsilon_r = 56.263$; $\rho = 1000$ kg/m³

Ambient Temperature : 23.3 °C ; Liquid Temperature : 22.8 °C

DASY5 Configuration:

- Probe: EX3DV4 - SN3954; ConvF(10.32, 10.32, 10.32); Calibrated: 2016.11.28;
- Sensor-Surface: 2mm (Mechanical Surface Detection)
- Electronics: DAE4 Sn1279; Calibrated: 2016.4.4
- Phantom: SAM2; Type: SAM; Serial: TP-1542
- Measurement SW: DASY52, Version 52.8 (8); SEMCAD X Version 14.6.10 (7331)

Ch189/Area Scan (41x121x1): Interpolated grid: dx=1.500 mm, dy=1.500 mm

Maximum value of SAR (interpolated) = 1.28 W/kg

Ch189/Zoom Scan (5x5x7)/Cube 0: Measurement grid: dx=8mm, dy=8mm, dz=5mm

Reference Value = 36.12 V/m; Power Drift = 0.03 dB

Peak SAR (extrapolated) = 1.52 W/kg

SAR(1 g) = 1.05 W/kg; SAR(10 g) = 0.723 W/kg

Maximum value of SAR (measured) = 1.30 W/kg

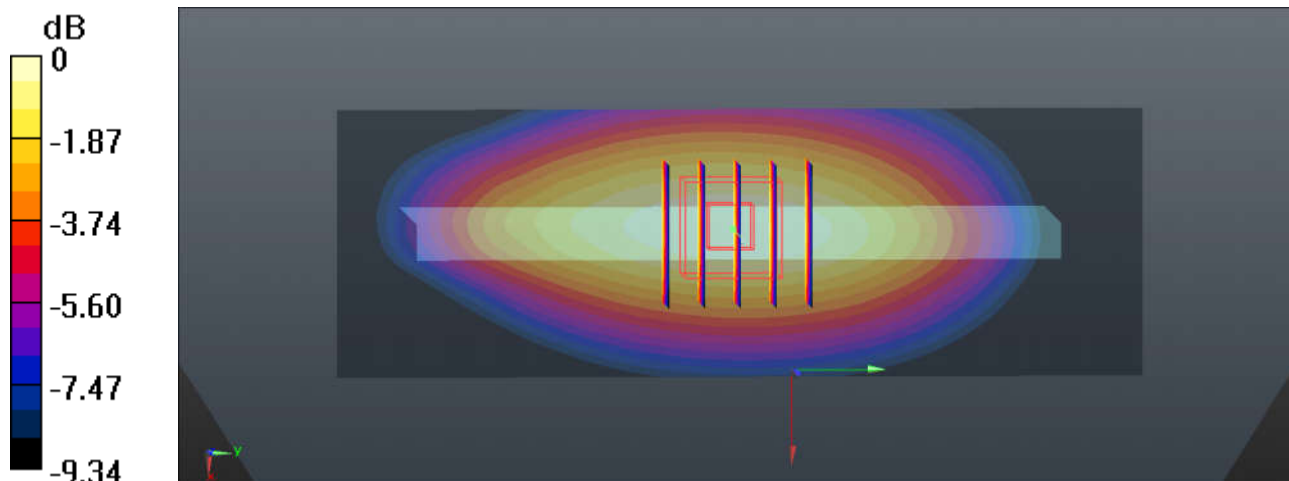

0 dB = 1.30 W/kg = 1.14 dBW/kg