



# FCC RF Test Report

**APPLICANT** : HMD Global Oy  
**EQUIPMENT** : Smart Phone  
**BRAND NAME** : NOKIA  
**MODEL NAME** : TA-1038  
**FCC ID** : 2AJOTTA-1038  
**STANDARD** : FCC 47 CFR Part 2, 22(H), 24(E), 27(L)  
**CLASSIFICATION** : PCS Licensed Transmitter Held to Ear (PCE)

The product was received on Jan. 18, 2017 and testing was completed on Jan. 23, 2017. We, SPORTON INTERNATIONAL (KUNSHAN) INC., would like to declare that the tested sample has been evaluated in accordance with the test procedures given in ANSI / TIA / EIA-603-D-2010 and has been in compliance with the applicable technical standards.

The test results in this report apply exclusively to the tested model / sample. Without written approval of SPORTON INTERNATIONAL (KUNSHAN) INC., the test report shall not be reproduced except in full.

Prepared by: James Huang / Manager

Approved by: Jones Tsai / Manager



**SPORTON INTERNATIONAL (KUNSHAN) INC.**  
**No. 3-2, PingXiang Road, Kunshan, Jiangsu Province, P. R. China**



# TABLE OF CONTENTS

- 1 GENERAL DESCRIPTION ..... 5**
  - 1.1 Applicant..... 5
  - 1.2 Manufacturer ..... 5
  - 1.3 Product Feature of Equipment Under Test ..... 5
  - 1.4 Product Specification of Equipment Under Test ..... 6
  - 1.5 Modification of EUT ..... 6
  - 1.6 Maximum ERP/EIRP Power, Frequency Tolerance, and Emission Designator ..... 7
  - 1.7 Testing Location ..... 7
  - 1.8 Applicable Standards ..... 7
- 2 TEST CONFIGURATION OF EQUIPMENT UNDER TEST ..... 8**
  - 2.1 Test Mode..... 8
  - 2.2 Connection Diagram of Test System ..... 9
  - 2.3 Support Unit used in test configuration ..... 9
  - 2.4 Measurement Results Explanation Example ..... 9
- 3 CONDUCTED TEST RESULT ..... 10**
  - 3.1 Measuring Instruments..... 10
  - 3.2 Test Setup ..... 10
  - 3.3 Test Result of Conducted Test..... 10
  - 3.4 Conducted Output Power and ERP/EIRP ..... 11
  - 3.5 Peak-to-Average Ratio ..... 12
  - 3.6 99% Occupied Bandwidth and 26dB Bandwidth Measurement..... 13
  - 3.7 Conducted Band Edge ..... 14
  - 3.8 Conducted Spurious Emission ..... 15
  - 3.9 Frequency Stability..... 16
- 4 RADIATED TEST ITEMS ..... 17**
  - 4.1 Measuring Instruments..... 17
  - 4.2 Test Setup ..... 17
  - 4.3 Test Result of Radiated Test..... 17
  - 4.4 Field Strength of Spurious Radiation Measurement ..... 18
- 5 LIST OF MEASURING EQUIPMENT ..... 19**
- 6 UNCERTAINTY OF EVALUATION ..... 20**

**APPENDIX A. TEST RESULTS OF CONDUCTED TEST**

**APPENDIX B. TEST RESULTS OF RADIATED TEST**

**APPENDIX C. TEST SETUP PHOTOGRAPHS**



### REVISION HISTORY

REPORT NO.	VERSION	DESCRIPTION	ISSUED DATE
FG711304-01A	Rev. 01	Initial issue of report	Mar. 10, 2017



### SUMMARY OF TEST RESULT

Report Section	FCC Rule	Description	Limit	Result	Remark
3.4	§2.1046	Conducted Output Power	Reporting Only	PASS	-
	§22.913(a)(2)	Effective Radiated Power	< 7 Watts	PASS	-
	§24.232(c)	Equivalent Isotropic Radiated Power	< 2 Watts	PASS	-
	§27.50(d)(4)	Equivalent Isotropic Radiated Power	< 1 Watts	PASS	-
3.5	§24.232(d)	Peak-to-Average Ratio	< 13 dB	PASS	-
3.6	§2.1049 §22.917(b) §24.238(b) §27.53(g)	Occupied Bandwidth	Reporting Only	PASS	-
3.7	§2.1051 §22.917(a) §24.238(a) §27.53(h)	Band Edge Measurement	< 43+10log10(P[Watts])	PASS	-
3.8	§2.1051 §22.917(a) §24.238(a) §27.53(h)	Conducted Emission	< 43+10log10(P[Watts])	PASS	-
3.9	§2.1055 §22.355	Frequency Stability for Temperature & Voltage	< 2.5 ppm for Part 22H	PASS	-
	§2.1055 §24.235 §27.54		Within Authorized Band		
4.4	§2.1053 §22.917(a) §24.238(a) §27.53(h)	Field Strength of Spurious Radiation	< 43+10log10(P[Watts])	PASS	Under limit 13.26 dB at 1672.000 MHz



# 1 General Description

## 1.1 Applicant

HMD Global Oy  
Karaportti 2, 02610 Espoo, Finland

## 1.2 Manufacturer

HMD Global Oy  
Karaportti 2, 02610 Espoo, Finland

## 1.3 Product Feature of Equipment Under Test

Product Feature	
Equipment	Smart Phone
Brand Name	NOKIA
Model Name	TA-1038
FCC ID	2AJOTTA-1038
EUT supports Radios application	GSM/GPRS/EGPRS/WCDMA/HSPA/DC-HSDPA/ HSPA+/LTE/NFC WLAN 2.4GHz 802.11b/g/n HT20/ WLAN 5GHz 802.11a/n HT20/HT40 Bluetooth v3.0 + EDR/ Bluetooth v 4.0 LE/ Bluetooth v4.1 LE / Bluetooth v4.2 LE
IMEI Code	Conducted: 356805080001425/356805080001433 Radiation: 356805080001268/356805080001276
HW Version	DVT1.5
SW Version	000C_1_26A
EUT Stage	Production Unit

**Remark:**

1. The above EUT's information was declared by manufacturer. Please refer to the specifications or user's manual for more detailed description.
2. After pre-scan two SIM cards power, we found test result of the SIM1 was the worse, so we chose dual SIM1 card to perform all tests.



### 1.4 Product Specification of Equipment Under Test

Standards-related Product Specification	
<b>Tx Frequency</b>	<b>GSM/GPRS/EDGE:</b> 850: 824.2 MHz ~ 848.8 MHz 1900: 1850.2 MHz ~ 1909.8MHz <b>WCDMA:</b> Band V: 826.4 MHz ~ 846.6 MHz Band II: 1852.4 MHz ~ 1907.6 MHz Band IV: 1712.4 MHz ~ 1752.6 MHz
<b>Rx Frequency</b>	<b>GSM/GPRS/EDGE:</b> 850: 869.2 MHz ~ 893.8 MHz 1900: 1930.2 MHz ~ 1989.8 MHz <b>WCDMA:</b> Band V: 871.4 MHz ~ 891.6 MHz Band II: 1932.4 MHz ~ 1987.6 MHz Band IV: 2112.4 MHz ~ 2152.6 MHz
<b>Maximum Output Power to Antenna</b>	<b>GSM/GPRS/EDGE:</b> 850: 33.27 dBm 1900: 29.95 dBm <b>WCDMA:</b> Band V: 24.18 dBm Band II: 24.43 dBm Band IV: 23.84 dBm
<b>Antenna Type</b>	IFA Antenna
<b>Antenna Gain</b>	Cellular Band: -0.63 dBi PCS Band: 3.04 dBi AWS Band: 2.65 dBi
<b>Type of Modulation</b>	GSM: GMSK GPRS: GMSK EDGE: GMSK / 8PSK WCDMA : BPSK (Uplink) HSDPA/DC-HSDPA: QPSK (Uplink) HSUPA : QPSK (Uplink) HSPA+ : 16QAM (Uplink) DC-HSDPA : 64QAM

### 1.5 Modification of EUT

No modifications are made to the EUT during all test items.



### 1.6 Maximum ERP/EIRP Power, Frequency Tolerance, and Emission Designator

FCC Rule	System	Type of Modulation	Maximum ERP/EIRP (W)	Frequency Tolerance (ppm)	Emission Designator
Part 22H	GSM850 GSM	GMSK	1.1194	0.0096 ppm	244KGXW
Part 22H	GSM850 EDGE class 8	8PSK	0.2805	0.0395 ppm	248KG7W
Part 22H	WCDMA Band V RMC 12.2Kbps	BPSK	0.1380	0.0239 ppm	4M21F9W
Part 24E	GSM1900 GSM	GMSK	1.9907	0.0191 ppm	244KGXW
Part 24E	GSM1900 EDGE class 8	8PSK	0.9441	0.0218 ppm	248KG7W
Part 24E	WCDMA Band II RMC 12.2Kbps	BPSK	0.5585	0.0064 ppm	4M22F9W
Part 27L	WCDMA Band IV RMC 12.2Kbps	BPSK	0.4457	0.0139 ppm	4M21F9W

### 1.7 Testing Location

<b>Test Site</b>	SPORTON INTERNATIONAL (KUNSHAN) INC.		
<b>Test Site Location</b>	No. 3-2, PingXiang Road, Kunshan, Jiangsu Province, P. R. China TEL: +86-0512-5790-0158 FAX: +86-0512-5790-0958		
<b>Test Site No.</b>	<b>Sporton Site No.</b>		<b>FCC Registration No.</b>
	TH01-KS	03CH03-KS	306251

### 1.8 Applicable Standards

According to the specifications of the manufacturer, the EUT must comply with the requirements of the following standards:

- ♦ 47 CFR Part 2, 22(H), 24(E), 27(L)
- ♦ ANSI / TIA / EIA-603-D-2010
- ♦ FCC KDB 971168 D01 Power Meas. License Digital Systems v02r02
- ♦ FCC KDB 412172 D01 Determining ERP and EIRP v01r01

**Remark:**

1. All test items were verified and recorded according to the standards and without any deviation during the test.
2. This EUT has also been tested and complied with the requirements of FCC Part 15, Subpart B, recorded in a separate test report.



## 2 Test Configuration of Equipment Under Test

### 2.1 Test Mode

Antenna port conducted and radiated test items were performed according to KDB 971168 D01 Power Meas. License Digital Systems v02r02 with maximum output power.

Radiated measurements were performed with rotating EUT in different three orthogonal test planes to find the maximum emission.

Radiated emissions were investigated as following frequency range:

1. 30 MHz to 10th harmonic for GSM850 and WCDMA Band V.
2. 30 MHz to 10th harmonic for WCDMA Band IV.
3. 30 MHz to 10th harmonic for GSM1900 and WCDMA Band II.

All modes and data rates and positions were investigated.

Test modes are chosen to be reported as the worst case configuration below:

Test Modes		
Band	Radiated TCs	Conducted TCs
GSM 850	<ul style="list-style-type: none"> <li>■ GSM Link</li> <li>■ EDGE class 8 Link</li> </ul>	<ul style="list-style-type: none"> <li>■ GSM Link</li> <li>■ EDGE class 8 Link</li> </ul>
GSM 1900	<ul style="list-style-type: none"> <li>■ GSM Link</li> <li>■ EDGE class 8 Link</li> </ul>	<ul style="list-style-type: none"> <li>■ GSM Link</li> <li>■ EDGE class 8 Link</li> </ul>
WCDMA Band V	<ul style="list-style-type: none"> <li>■ RMC 12.2Kbps Link</li> </ul>	<ul style="list-style-type: none"> <li>■ RMC 12.2Kbps Link</li> </ul>
WCDMA Band II	<ul style="list-style-type: none"> <li>■ RMC 12.2Kbps Link</li> </ul>	<ul style="list-style-type: none"> <li>■ RMC 12.2Kbps Link</li> </ul>
WCDMA Band IV	<ul style="list-style-type: none"> <li>■ RMC 12.2Kbps Link</li> </ul>	<ul style="list-style-type: none"> <li>■ RMC 12.2Kbps Link</li> </ul>



## 2.2 Connection Diagram of Test System

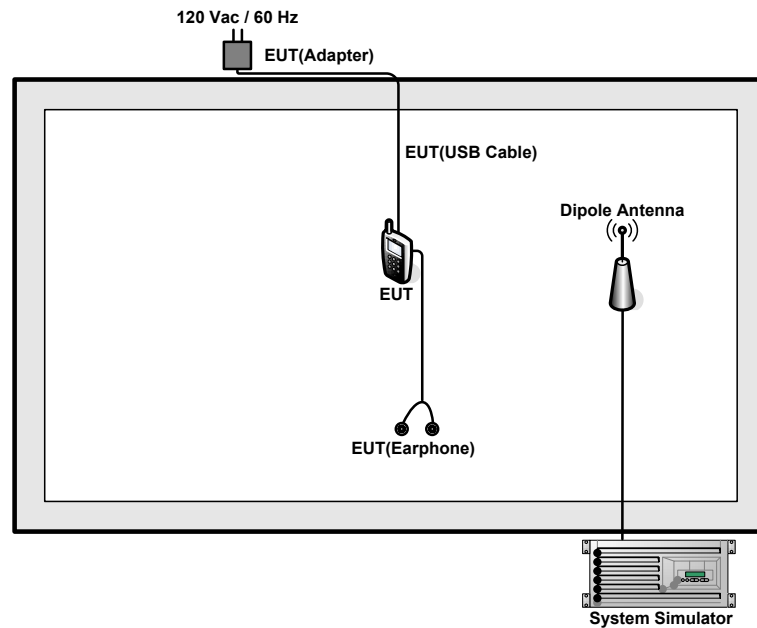

## 2.3 Support Unit used in test configuration

Item	Equipment	Trade Name	Model No.	FCC ID	Data Cable	Power Cord
1.	System Simulator	R&S	CMU 200	N/A	N/A	Unshielded, 1.8 m
2.	DC Power Supply	GW INSTRON	GPS-3030D	N/A	N/A	Unshielded, 1.8 m

## 2.4 Measurement Results Explanation Example

### For all conducted test items:

The offset level is set in the spectrum analyzer to compensate the RF cable loss and attenuator factor between RF conducted output port and spectrum analyzer. With the offset compensation, the spectrum analyzer reading level will be exactly the RF output level.

The spectrum analyzer offset is derived from RF cable loss and attenuator factor.

*Offset = RF cable loss + attenuator factor.*

The following shows an offset computation example with RF cable loss 4.21 dB and a 10dB attenuator.

Example :

*Offset(dB) = RF cable loss(dB) + attenuator factor(dB).*

$$= 4.21 + 10 = 14.21 \text{ (dB)}$$

### 3 Conducted Test Result

#### 3.1 Measuring Instruments

See list of measuring instruments of this test report.

#### 3.2 Test Setup

##### 3.2.1 Conducted Output Power

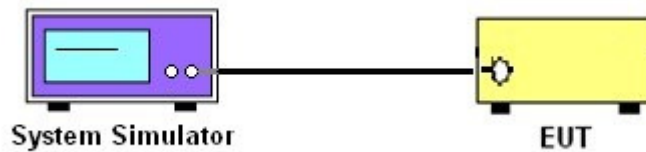

##### 3.2.2 Peak-to-Average Ratio, Occupied Bandwidth, Conducted Band-Edge and Conducted Spurious Emission

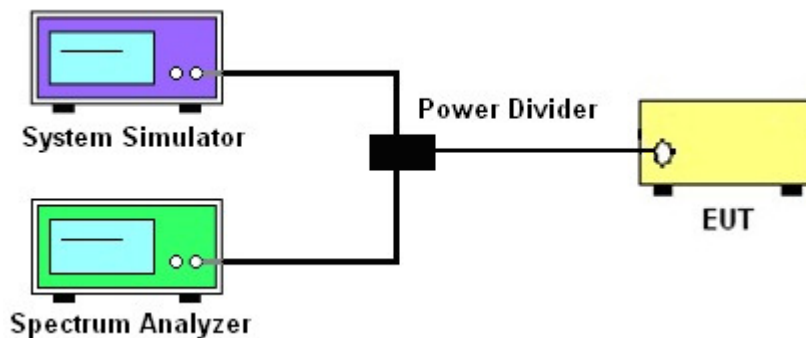

##### 3.2.3 Frequency Stability

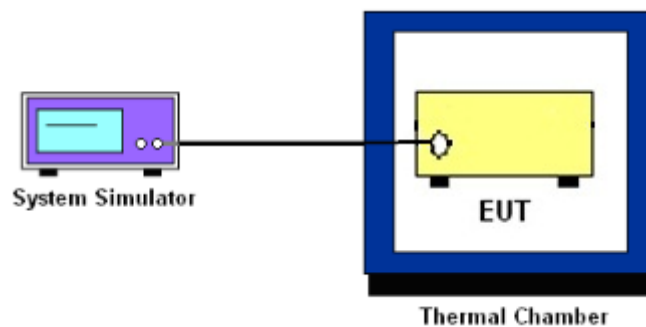

### 3.3 Test Result of Conducted Test

Please refer to Appendix A.



### 3.4 Conducted Output Power and ERP/EIRP

#### 3.4.1 Description of the Conducted Output Power and ERP/EIRP

A system simulator was used to establish communication with the EUT. Its parameters were set to enforce EUT transmitting at the maximum power. The measured power in the radio frequency on the transmitter output terminals shall be reported.

The ERP of mobile transmitters must not exceed 7 Watts for GSM850 and WCDMA Band V.

The EIRP of mobile transmitters must not exceed 2 Watts for GSM1900 and WCDMA Band II.

The EIRP of mobile transmitters must not exceed 1 Watts for WCDMA Band IV.

According to KDB 412172 D01 Power Approach,

$EIRP = P_T + G_T - L_C$ ,  $ERP = EIRP - 2.15$ , where

$P_T$  = transmitter output power in dBm

$G_T$  = gain of the transmitting antenna in dBi

$L_C$  = signal attenuation in the connecting cable between the transmitter and antenna in dB

#### 3.4.2 Test Procedures

1. The transmitter output port was connected to the system simulator.
2. Set EUT at maximum power through system simulator.
3. Select lowest, middle, and highest channels for each band and different modulation.
4. Measure the maximum burst average power for GSM and maximum average power for other modulation signal.



## **3.5 Peak-to-Average Ratio**

### **3.5.1 Description of the PAR Measurement**

The peak-to-average ratio (PAR) of the transmission may not exceed 13 dB.

### **3.5.2 Test Procedures**

1. The testing follows FCC KDB 971168 D01 v02r02 Section 5.7.1.
2. The EUT was connected to spectrum analyzer and system simulator via a power divider.
3. Set EUT to transmit at maximum output power.
4. When the duty cycle is less than 98%, then signal gating will be implemented on the spectrum analyzer by triggering from the system simulator.
5. Set the CCDF (Complementary Cumulative Distribution Function) option of the spectrum analyzer.  
Record the maximum PAPR level associated with a probability of 0.1%.



### 3.6 99% Occupied Bandwidth and 26dB Bandwidth Measurement

#### 3.6.1 Description of 99% Occupied Bandwidth and 26dB Bandwidth Measurement

The occupied bandwidth is the width of a frequency band such that, below the lower and above the upper frequency limits, the mean powers emitted are each equal to a specified percentage 0.5% of the total mean transmitted power.

The 26 dB emission bandwidth is defined as the frequency range between two points, one above and one below the carrier frequency, at which the spectral density of the emission is attenuated 26 dB below the maximum in-band spectral density of the modulated signal. Spectral density (power per unit bandwidth) is to be measured with a detector of resolution bandwidth equal to approximately 1.0% of the emission bandwidth.

#### 3.6.2 Test Procedures

1. The testing follows FCC KDB 971168 v02r02 Section 4.2.
2. The EUT was connected to spectrum analyzer and system simulator via a power divider.
3. The spectrum analyzer center frequency is set to the nominal EUT channel center frequency. The span range for the spectrum analyzer shall be between two and five times the anticipated OBW.
4. The nominal resolution bandwidth (RBW) shall be in the range of 1 to 5 % of the anticipated OBW, and the VBW shall be at least 3 times the RBW.
5. Set the detection mode to peak, and the trace mode to max hold.
6. Determine the reference value: Set the EUT to transmit a modulated signal. Allow the trace to stabilize. Set the spectrum analyzer marker to the highest level of the displayed trace.  
(this is the reference value)
7. Determine the “-26 dB down amplitude” as equal to (Reference Value – X).
8. Place two markers, one at the lowest and the other at the highest frequency of the envelope of the spectral display such that each marker is at or slightly below the “-X dB down amplitude” determined in step 6. If a marker is below this “-X dB down amplitude” value it shall be placed as close as possible to this value. The OBW is the positive frequency difference between the two markers.
9. Use the 99 % power bandwidth function of the spectrum analyzer and report the measured bandwidth.



### 3.7 Conducted Band Edge

#### 3.7.1 Description of Conducted Band Edge Measurement

The power of any emission outside of the authorized operating frequency ranges must be lower than the transmitter power (P) by a factor of at least  $43 + 10 \log (P)$  dB.

#### 3.7.2 Test Procedures

1. The testing follows FCC KDB 971168 D01 v02r02 Section 6.0.
2. The EUT was connected to the spectrum analyzer and system simulator via a power divider.
3. The RF output of EUT was connected to the spectrum analyzer by an RF cable and attenuator. The path loss was compensated to the results for each measurement.
4. The band edges of low and high channels for the highest RF powers were measured.
5. The RF fundamental frequency should be excluded against the limit line in the operating frequency band.
6. The limit line is derived from  $43 + 10\log(P)$  dB below the transmitter power P(Watts)  
=  $P(W) - [43 + 10\log(P)]$  (dB)  
=  $[30 + 10\log(P)]$  (dBm) -  $[43 + 10\log(P)]$  (dB)  
= -13dBm.



### 3.8 Conducted Spurious Emission

#### 3.8.1 Description of Conducted Spurious Emission Measurement

The power of any emission outside of the authorized operating frequency ranges must be lower than the transmitter power (P) by a factor of at least  $43 + 10 \log (P)$  dB.

It is measured by means of a calibrated spectrum analyzer and scanned from 30 MHz up to a frequency including its 10<sup>th</sup> harmonic.

#### 3.8.2 Test Procedures

1. The testing follows FCC KDB 971168 D01 v02r02 Section 6.0.
2. The EUT was connected to the spectrum analyzer and system simulator via a power divider.
3. The RF output of EUT was connected to the spectrum analyzer by an RF cable and attenuator. The path loss was compensated to the results for each measurement.
4. The middle channel for the highest RF power within the transmitting frequency was measured.
5. The conducted spurious emission for the whole frequency range was taken.
6. The RF fundamental frequency should be excluded against the limit line in the operating frequency band.
7. The limit line is derived from  $43 + 10\log(P)$  dB below the transmitter power P(Watts)  
=  $P(W) - [43 + 10\log(P)]$  (dB)  
=  $[30 + 10\log(P)]$  (dBm) -  $[43 + 10\log(P)]$  (dB)  
= -13dBm.



### 3.9 Frequency Stability

#### 3.9.1 Description of Frequency Stability Measurement

The frequency stability shall be measured by variation of ambient temperature and variation of primary supply voltage to ensure that the fundamental emission stays within the authorized frequency block. The frequency stability of the transmitter shall be maintained within  $\pm 0.00025\%$  ( $\pm 2.5\text{ppm}$ ) of the center frequency.

#### 3.9.2 Test Procedures for Temperature Variation

1. The testing follows FCC KDB 971168 D01 v02r02 Section 9.0.
2. The EUT was set up in the thermal chamber and connected with the system simulator.
3. With power OFF, the temperature was decreased to  $-30^{\circ}\text{C}$  and the EUT was stabilized before testing. Power was applied and the maximum change in frequency was recorded within one minute.
4. With power OFF, the temperature was raised in  $10^{\circ}\text{C}$  steps up to  $50^{\circ}\text{C}$ . The EUT was stabilized at each step for at least half an hour. Power was applied and the maximum frequency change was recorded within one minute.

#### 3.9.3 Test Procedures for Voltage Variation

1. The testing follows FCC KDB 971168 D01 v02r02 Section 9.0.
2. The EUT was placed in a temperature chamber at  $20\pm 5^{\circ}\text{C}$  and connected with the system simulator.
3. The power supply voltage to the EUT was varied from 85% to 115% of the nominal value measured at the input to the EUT.
4. The variation in frequency was measured for the worst case.



## 4 Radiated Test Items

### 4.1 Measuring Instruments

See list of measuring instruments of this test report.

### 4.2 Test Setup

#### 4.2.1 For radiated test from 30MHz to 1GHz

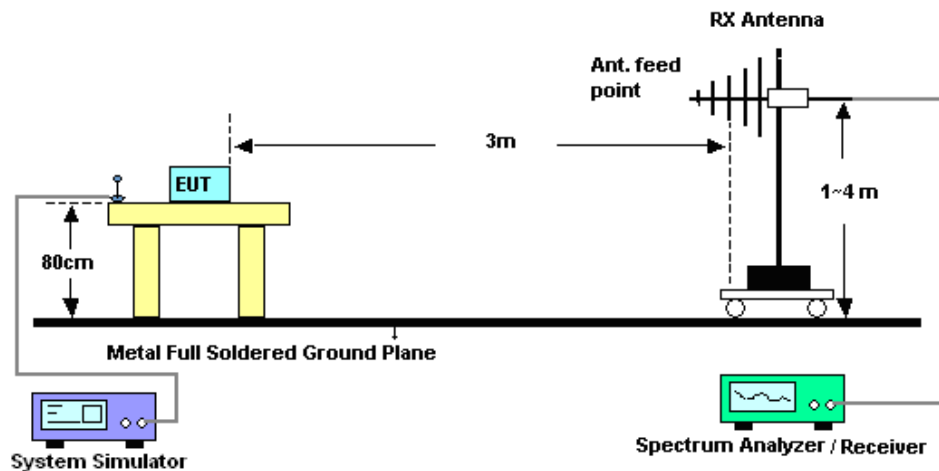

#### 4.2.2 For radiated test above 1GHz

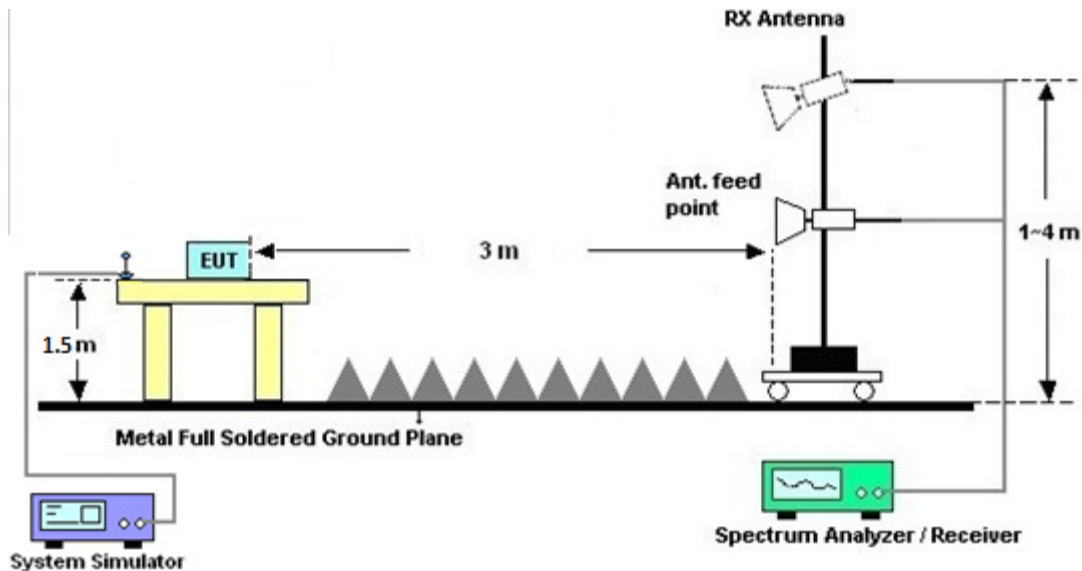

### 4.3 Test Result of Radiated Test

Please refer to Appendix B.



## 4.4 Field Strength of Spurious Radiation Measurement

### 4.4.1 Description of Field Strength of Spurious Radiated Measurement

The power of any emission outside of the authorized operating frequency ranges must be attenuated below the transmitter power (P) by a factor of at least  $43 + 10 \log (P)$  dB. The spectrum is scanned from 30 MHz up to a frequency including its 10th harmonic.

### 4.4.2 Test Procedures

1. The testing follows FCC KDB 971168 D01 v02r02 Section 5.8 and ANSI / TIA-603-D-2010 Section 2.2.12.
2. The EUT was placed on a rotatable wooden table 0.8 meters for frequency below 1GHz and 1.5 meter for frequency above 1GHz above the ground.
3. The EUT was set 3 meters from the receiving antenna, which was mounted on the antenna tower.
4. The table was rotated 360 degrees to determine the position of the highest spurious emission.
5. The height of the receiving antenna is varied between one meter and four meters to search for the maximum spurious emission for both horizontal and vertical polarizations.
6. Make the measurement with the spectrum analyzer's RBW = 1MHz, VBW = 3MHz, taking record of maximum spurious emission.
7. A horn antenna was substituted in place of the EUT and was driven by a signal generator.
8. Tune the output power of signal generator to the same emission level with EUT maximum spurious emission.
9. Taking the record of output power at antenna port.
10. Repeat step 7 to step 8 for another polarization.
11.  $EIRP \text{ (dBm)} = S.G. \text{ Power} - Tx \text{ Cable Loss} + Tx \text{ Antenna Gain}$
12.  $ERP \text{ (dBm)} = EIRP - 2.15$
13. The RF fundamental frequency should be excluded against the limit line in the operating frequency band.
14. The limit line is derived from  $43 + 10\log(P)$  dB below the transmitter power P(Watts)  
=  $P(W) - [43 + 10\log(P)] \text{ (dB)}$   
=  $[30 + 10\log(P)] \text{ (dBm)} - [43 + 10\log(P)] \text{ (dB)}$   
= -13dBm.



## 5 List of Measuring Equipment

Instrument	Manufacturer	Model No.	Serial No.	Characteristics	Calibration Date	Test Date	Due Date	Remark
Spectrum Analyzer	R&S	FSV40	101040	10Hz~40GHz	Aug. 09, 2016	Jan. 23, 2017	Aug. 08, 2017	Conducted (TH01-KS)
Radio Communication Analyzer	Anritsu	MT8820C	6201300652	2G/3G/4G/CDMA	Aug. 08, 2016	Jan. 23, 2017	Aug. 07, 2017	Conducted (TH01-KS)
Thermal Chamber	Ten Billion	TTC-B3S	TBN-960502	-40~+150°C	Oct. 13, 2016	Jan. 23, 2017	Oct. 12, 2017	Conducted (TH01-KS)
EXA Spectrum Analyzer	Keysight	N9010A	MY55150244	10Hz~44GHz	Apr. 22, 2016	Jan. 23, 2017	Apr. 21, 2017	Radiation (03CH03-KS)
Bilog Antenna	TeseQ	CBL6112D	35406	25MHz~2GHz	Apr. 16, 2016	Jan. 23, 2017	Apr. 15, 2017	Radiation (03CH03-KS)
Horn Antenna	Schwarzbeck	BBHA9120D	9120D-1356	1GHz~18GHz	Apr. 16, 2016	Jan. 23, 2017	Apr. 15, 2017	Radiation (03CH03-KS)
SHF-EHF Horn	Schwarzbeck	BBHA 9170	BBHA170249	15GHz~40GHz	Mar. 03, 2016	Jan. 23, 2017	Mar. 02, 2017	Radiation (03CH03-KS)
Amplifier	SONOMA	310N	187289	9kHz~1GHz	Aug. 09, 2016	Jan. 23, 2017	Aug. 08, 2017	Radiation (03CH03-KS)
high gain Amplifier	MITEQ	AMF-7D-00 101800-30-1	1943529	1GHz~18GHz	Jan. 19, 2017	Jan. 23, 2017	Jan. 18, 2018	Radiation (03CH03-KS)
Amplifier	MITEQ	TTA1840-35 -HG	1887435	18GHz~40GHz	Oct. 13, 2016	Jan. 23, 2017	Oct. 12, 2017	Radiation (03CH03-KS)
AC Power Source	Chroma	61601	F104090004	N/A	NCR	Jan. 23, 2017	NCR	Radiation (03CH03-KS)
Turn Table	ChamPro	EM 1000-T	060762-T	0~360 degree	NCR	Jan. 23, 2017	NCR	Radiation (03CH03-KS)
Antenna Mast	ChamPro	EM 1000-A	060762-A	1 m~4 m	NCR	Jan. 23, 2017	NCR	Radiation (03CH03-KS)

NCR: No Calibration Required



## 6 Uncertainty of Evaluation

### Uncertainty of Radiated Emission Measurement (30 MHz ~ 1000 MHz)

Measuring Uncertainty for a Level of Confidence of 95% ( $U = 2Uc(y)$ )	2.8dB
---	-------

### Uncertainty of Radiated Emission Measurement (1GHz ~ 40GHz)

Measuring Uncertainty for a Level of Confidence of 95% ( $U = 2Uc(y)$ )	3.3dB
---	-------



## Appendix A. Test Results of Conducted Test

### Conducted Output Power(Average power)

Conducted Power (*Unit: dBm)						
Band	GSM850			GSM1900		
Channel	128	189	251	512	661	810
Frequency	824.2	836.4	848.8	1850.2	1880.0	1909.8
GSM	33.20	33.27	33.26	29.74	29.88	29.95
GPRS class 8	33.18	33.25	33.24	29.73	29.85	29.94
GPRS class 10	32.41	32.54	32.54	29.55	29.72	29.86
GPRS class 11	30.56	30.68	30.69	27.63	27.83	28.08
GPRS class 12	29.42	29.59	29.58	26.46	26.72	27.01
EGPRS class 8	27.21	27.26	27.19	26.54	26.64	26.71
EGPRS class 10	26.28	26.33	26.28	25.57	25.64	25.69
EGPRS class 11	24.36	24.43	24.39	23.55	23.62	23.65
EGPRS class 12	23.32	23.29	23.21	22.43	22.51	22.54

Conducted Power (*Unit: dBm)									
Band	WCDMA Band V			WCDMA Band II			WCDMA Band IV		
Channel	4132	4182	4233	9262	9400	9538	1312	1413	1513
Frequency	826.4	836.4	846.6	1852.4	1880	1907.6	1712.4	1732.6	1752.6
AMR 12.2K	24.09	24.05	24.16	24.36	24.25	24.41	23.82	23.80	23.81
RMC 12.2K	24.11	24.07	24.18	24.38	24.27	24.43	23.84	23.80	23.83
HSDPA Subtest-1	23.12	23.02	23.14	23.42	23.43	23.51	22.96	22.90	22.80
HSDPA Subtest-2	23.07	23.07	23.19	23.43	23.45	23.54	22.96	22.86	22.85
HSDPA Subtest-3	22.59	22.60	22.73	22.95	22.98	23.05	22.49	22.41	22.36
HSDPA Subtest-4	22.57	22.58	22.67	22.95	22.95	23.06	22.50	22.38	22.34
DC-HSDPA Subtest-1	22.57	22.55	22.66	22.49	22.45	22.63	21.90	21.84	21.87
DC-HSDPA Subtest-2	22.56	22.49	22.61	22.47	22.37	22.56	21.85	21.81	21.80
DC-HSDPA Subtest-3	22.08	22.02	22.12	22.07	21.93	22.10	21.36	21.33	21.30
DC-HSDPA Subtest-4	22.07	22.05	22.17	21.98	21.91	22.09	21.39	21.31	21.32
HSUPA Subtest-1	21.07	21.10	21.21	21.42	21.46	21.54	21.04	20.96	20.89
HSUPA Subtest-2	21.05	21.09	21.17	21.42	21.44	21.55	20.97	20.86	20.81
HSUPA Subtest-3	22.04	22.09	22.18	22.41	22.46	22.53	21.95	21.87	21.82
HSUPA Subtest-4	20.49	20.51	20.63	20.90	20.90	20.99	20.51	20.43	20.35
HSUPA Subtest-5	22.80	23.00	23.10	23.40	23.40	23.50	23.00	22.90	22.80
HSPA+ (16QAM) Subtest-1	21.13	20.96	21.11	20.93	20.84	21.09	20.28	20.28	20.25



**ERP/EIRP**

<b>GSM850 (<math>G_T - L_C = -0.63\text{dB}</math>)</b>			
<b>Channel</b>	<b>128</b>	<b>189</b>	<b>251</b>
	<b>(Low)</b>	<b>(Mid)</b>	<b>(High)</b>
<b>Frequency</b>	<b>824.2</b>	<b>836.4</b>	<b>848.8</b>
<b>(MHz)</b>			
<b>Conducted Power (dBm)</b>	33.20	33.27	33.26
<b>Conducted Power (Watts)</b>	2.0893	2.1232	2.1184
<b>ERP(dBm)</b>	30.42	30.49	30.48
<b>ERP(Watts)</b>	1.1015	1.1194	1.1169

<b>EDGE850 (<math>G_T - L_C = -0.63\text{dB}</math>)</b>			
<b>Channel</b>	<b>128</b>	<b>189</b>	<b>251</b>
	<b>(Low)</b>	<b>(Mid)</b>	<b>(High)</b>
<b>Frequency</b>	<b>824.2</b>	<b>836.4</b>	<b>848.8</b>
<b>(MHz)</b>			
<b>Conducted Power (dBm)</b>	27.21	27.26	27.19
<b>Conducted Power (Watts)</b>	0.5260	0.5321	0.5236
<b>ERP(dBm)</b>	24.43	24.48	24.41
<b>ERP(Watts)</b>	0.2773	0.2805	0.2761



GSM1900 ( $G_T - L_C = 3.04\text{dB}$ )			
Channel	512	661	810
	(Low)	(Mid)	(High)
Frequency	1850.2	1880	1909.8
(MHz)			
Conducted Power (dBm)	29.74	29.88	29.95
Conducted Power (Watts)	0.9419	0.9727	0.9886
EIRP(dBm)	32.78	32.92	32.99
EIRP(Watts)	1.8967	1.9588	1.9907

EDGE1900 ( $G_T - L_C = 3.04\text{dB}$ )			
Channel	512	661	810
	(Low)	(Mid)	(High)
Frequency	1850.2	1880	1909.8
(MHz)			
Conducted Power (dBm)	26.54	26.64	26.71
Conducted Power (Watts)	0.4508	0.4613	0.4688
EIRP(dBm)	29.58	29.68	29.75
EIRP(Watts)	0.9078	0.9290	0.9441



WCDMA Band V ( $G_T - L_C = -0.63\text{dB}$ )			
Channel	4132	4182	4233
	(Low)	(Mid)	(High)
Frequency	826.4	836.4	846.6
(MHz)			
Conducted Power (dBm)	24.11	24.07	24.18
Conducted Power (Watts)	0.2576	0.2553	0.2618
ERP(dBm)	21.33	21.29	21.40
ERP(Watts)	0.1358	0.1346	0.1380

WCDMA Band II ( $G_T - L_C = 3.04\text{dB}$ )			
Channel	9262	9400	9538
	(Low)	(Mid)	(High)
Frequency	1852.4	1880	1907.6
(MHz)			
Conducted Power (dBm)	24.38	24.27	24.43
Conducted Power (Watts)	0.2742	0.2673	0.2773
EIRP(dBm)	27.42	27.31	27.47
EIRP(Watts)	0.5521	0.5383	0.5585

WCDMA Band IV ( $G_T - L_C = 2.65\text{dB}$ )			
Channel	1312	1413	1513
	(Low)	(Mid)	(High)
Frequency	1712.4	1732.6	1752.6
(MHz)			
Conducted Power (dBm)	23.84	23.80	23.83
Conducted Power (Watts)	0.2421	0.2399	0.2415
EIRP(dBm)	26.49	26.45	26.48
EIRP(Watts)	0.4457	0.4416	0.4446





**Peak-to-Average Ratio**

Mode	GSM850(dB)		Limit: 13dB
Mod.	GSM	EDGE class 8	Result
Lowest CH	0.14	3.13	PASS
Middle CH	0.17	3.01	
Highest CH	0.14	3.33	

Mode	GSM1900(dB)		Limit: 13dB
Mod.	GSM	EDGE class 8	Result
Lowest CH	0.14	3.22	PASS
Middle CH	0.17	3.13	
Highest CH	0.12	3.45	

Mode	WCDMA Band V(dB)	WCDMA Band II(dB)	WCDMA Band IV(dB)	Limit: 13dB
Mod.	RMC 12.2Kbps	RMC 12.2Kbps	RMC 12.2Kbps	Result
Lowest CH	2.72	2.35	2.72	PASS
Middle CH	3.10	2.49	2.55	
Highest CH	2.67	2.52	2.78	

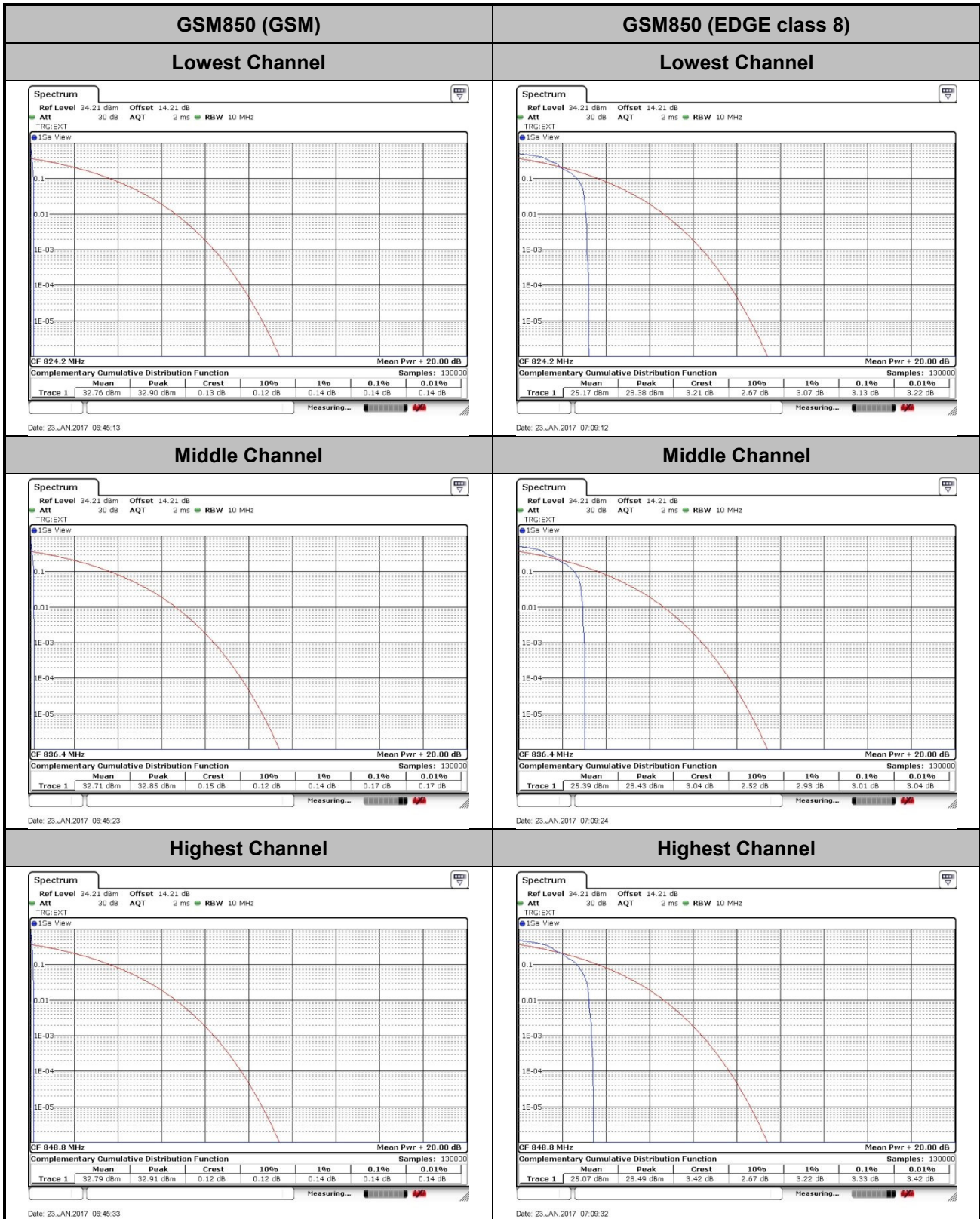

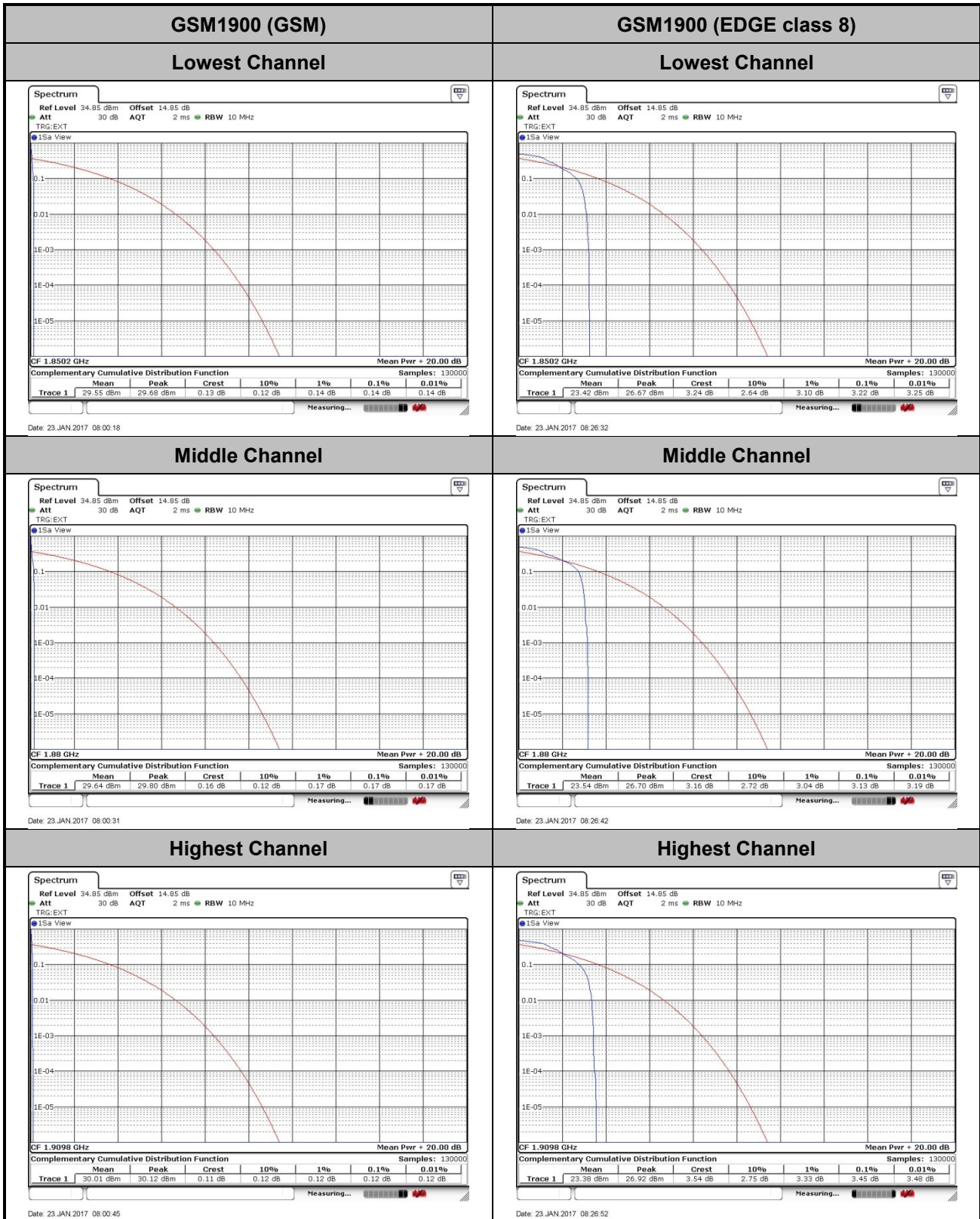



WCDMA Band V (RMC 12.2Kbps)

Lowest Channel

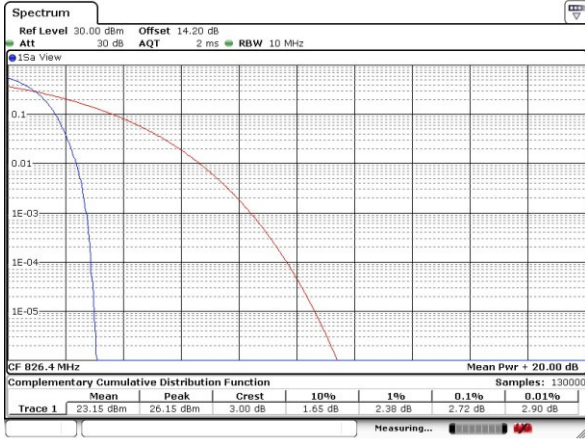

Date: 23 JAN 2017 06:13:54

WCDMA Band II (RMC 12.2Kbps)

Lowest Channel

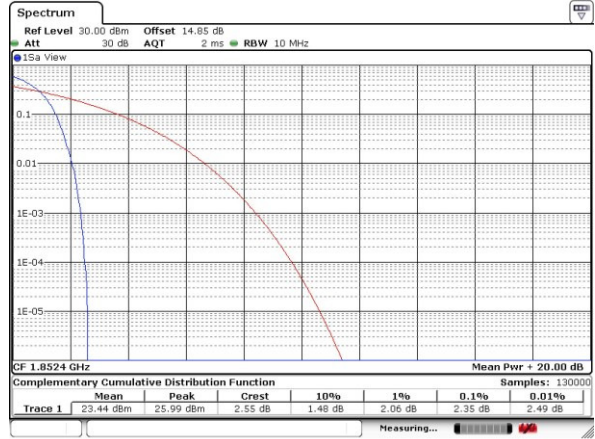

Date: 23 JAN 2017 05:22:04

Middle Channel

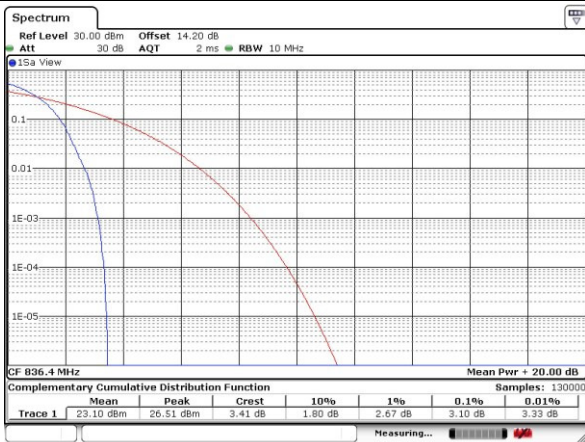

Date: 23 JAN 2017 06:14:06

Middle Channel



Date: 23 JAN 2017 05:22:16

Highest Channel

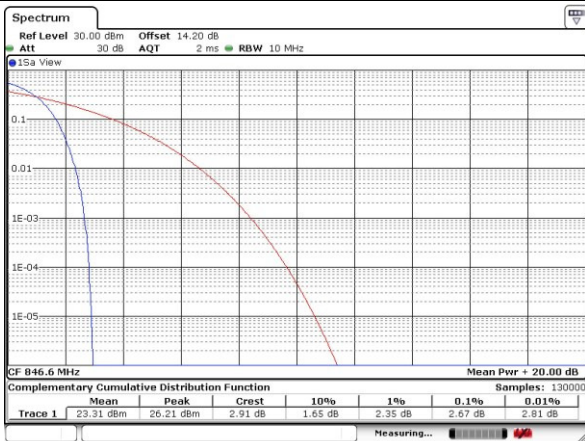

Date: 23 JAN 2017 06:14:16

Highest Channel

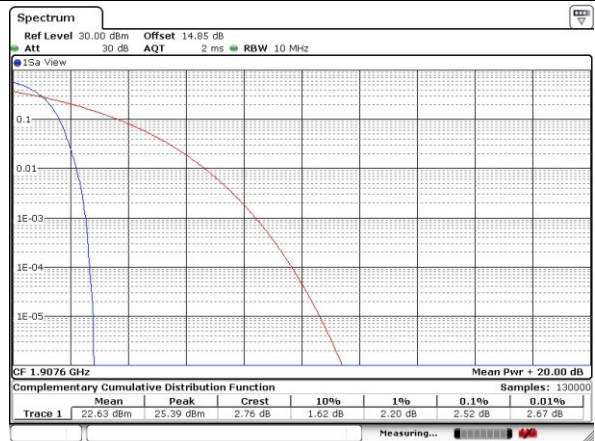

Date: 23 JAN 2017 05:22:30





WCDMA Band IV (RMC 12.2Kbps)

Lowest Channel

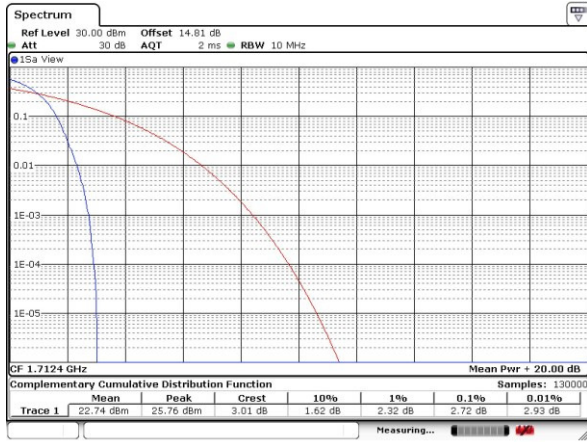

Date: 23 JAN 2017 05:50:31

Middle Channel

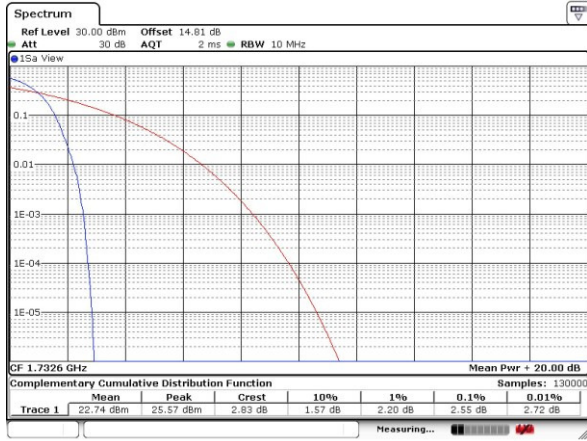

Date: 23 JAN 2017 05:50:46

Highest Channel

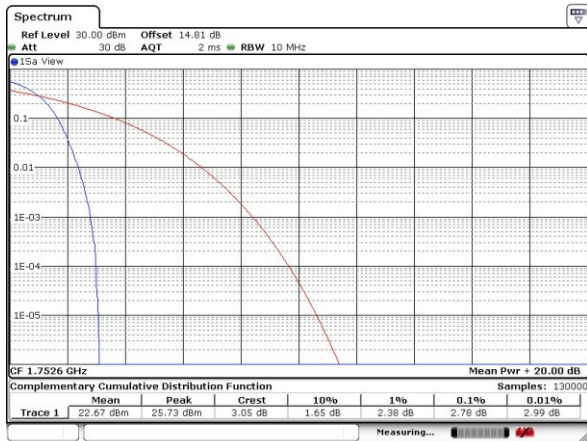

Date: 23 JAN 2017 05:50:57



**26dB Bandwidth**

Mode	GSM850(MHz)	
Mod.	GSM	EDGE class 8
Lowest CH	0.318	0.314
Middle CH	0.319	0.313
Highest CH	0.317	0.313

Mode	GSM1900(MHz)	
Mod.	GSM	EDGE class 8
Lowest CH	0.316	0.318
Middle CH	0.314	0.313
Highest CH	0.319	0.316

Mode	WCDMA Band V(MHz)	WCDMA Band II(MHz)	WCDMA Band IV(MHz)
Mod.	RMC 12.2Kbps	RMC 12.2Kbps	RMC 12.2Kbps
Lowest CH	4.87	4.90	4.87
Middle CH	4.86	4.88	4.88
Highest CH	4.87	4.92	4.87



GSM850 (GSM)

Lowest Channel

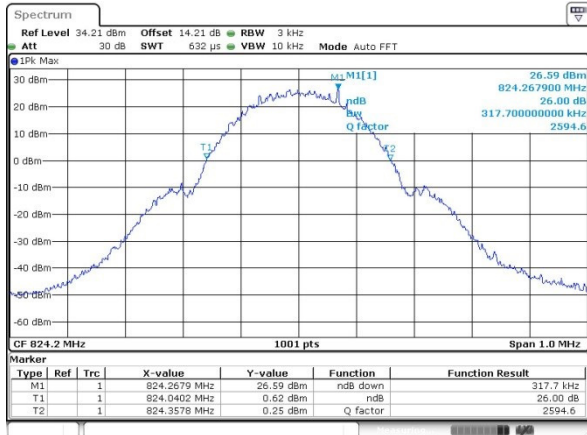

Date: 23 JAN 2017 06:21:34

GSM850 (EDGE class 8)

Lowest Channel

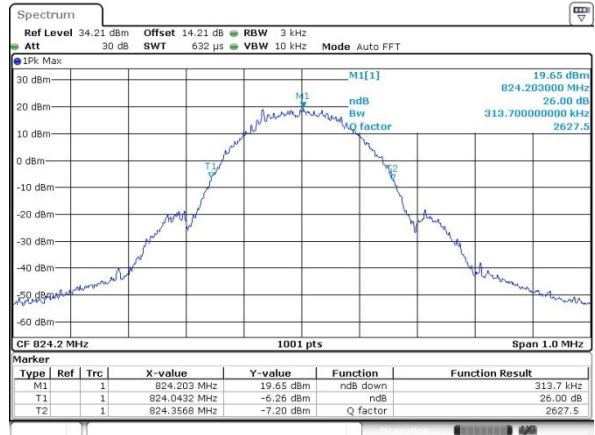

Date: 23 JAN 2017 06:52:46

Middle Channel

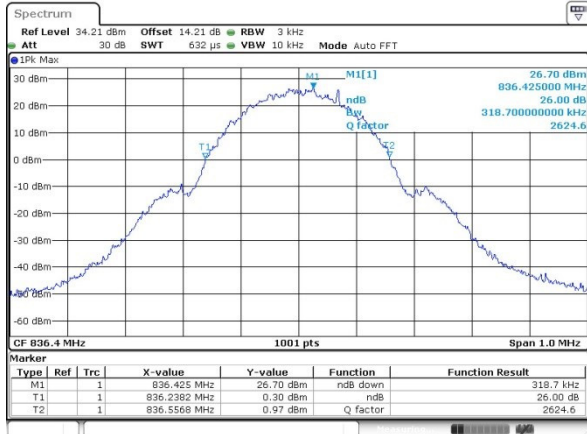

Date: 23 JAN 2017 06:22:25

Middle Channel

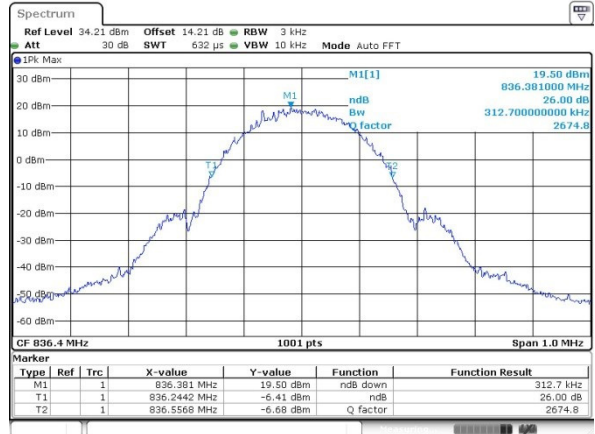

Date: 23 JAN 2017 06:53:35

Highest Channel

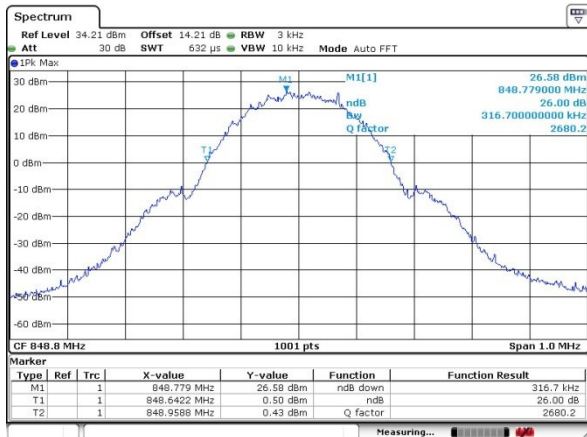

Date: 23 JAN 2017 06:24:13

Highest Channel

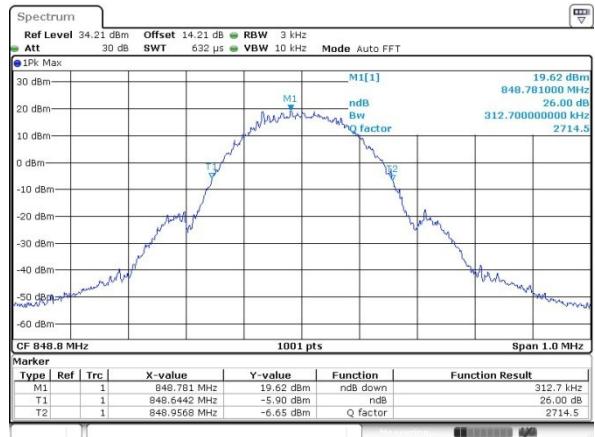

Date: 23 JAN 2017 06:54:26



**GSM1900 (GSM)**

**Lowest Channel**

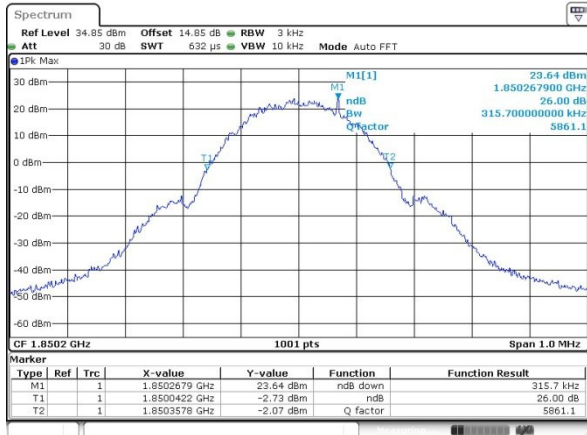

Date: 23 JAN 2017 07:46:55

**GSM1900 (EDGE class 8)**

**Lowest Channel**

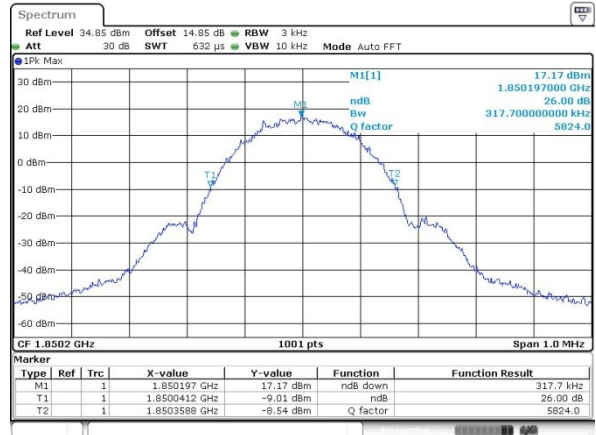

Date: 23 JAN 2017 08:04:45

**Middle Channel**

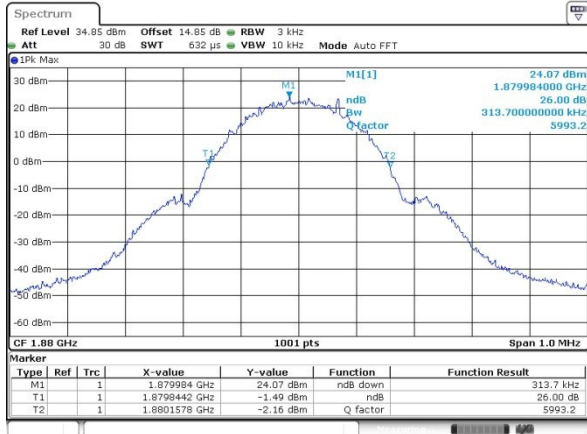

Date: 23 JAN 2017 07:47:47

**Middle Channel**

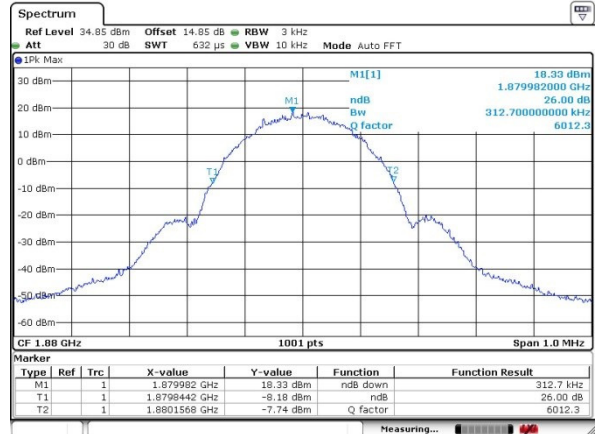

Date: 23 JAN 2017 08:10:07

**Highest Channel**

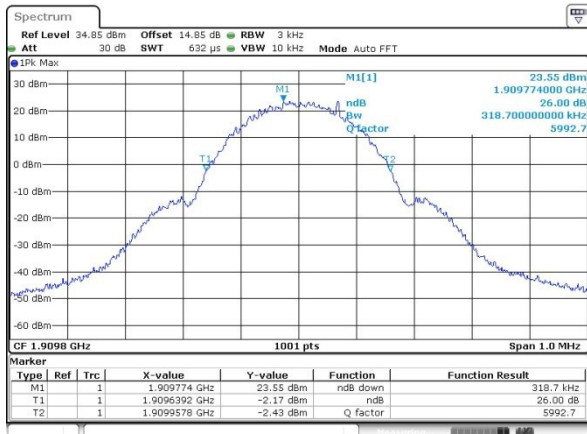

Date: 23 JAN 2017 07:48:22

**Highest Channel**

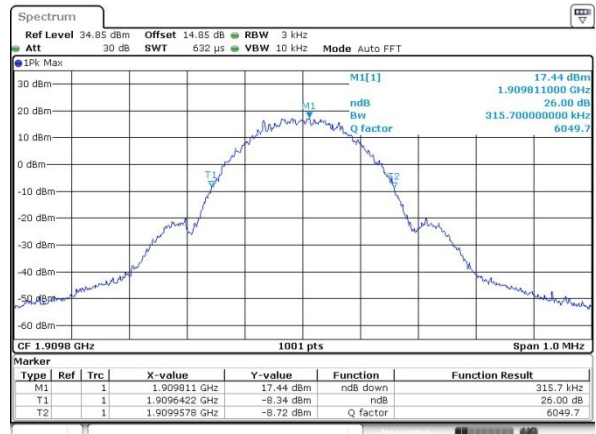

Date: 23 JAN 2017 08:06:27





WCDMA Band V (RMC 12.2Kbps)

Lowest Channel

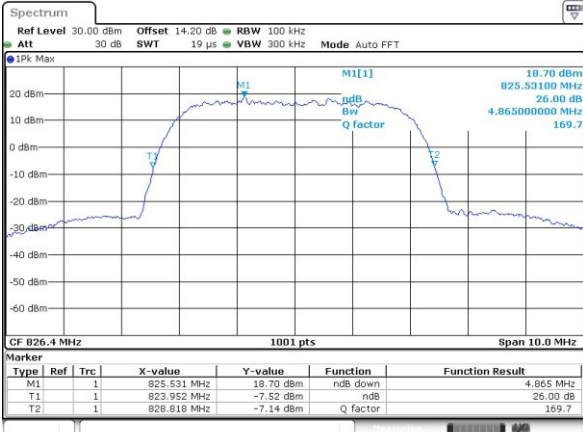

Date: 23 JAN 2017 05:53:35

WCDMA Band II (RMC 12.2Kbps)

Lowest Channel

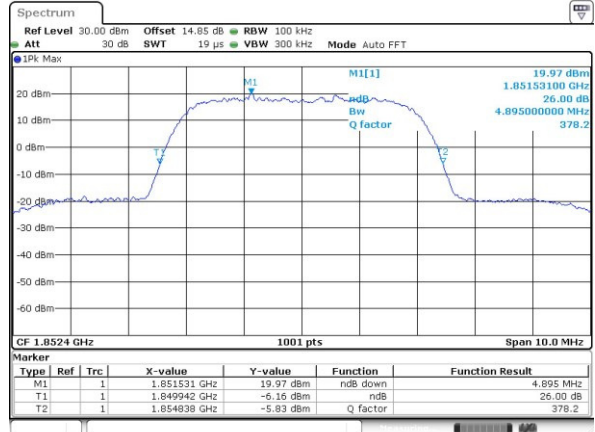

Date: 23 JAN 2017 04:59:37

Middle Channel

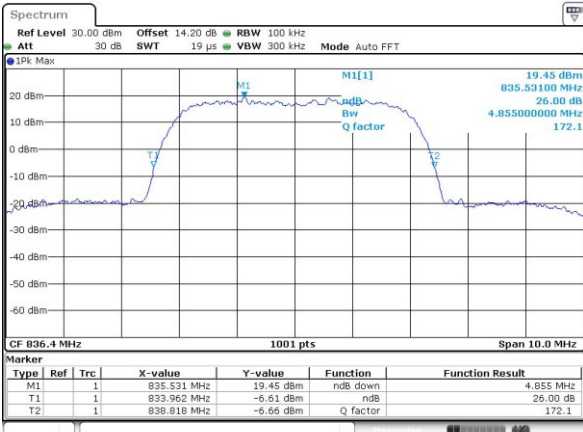

Date: 23 JAN 2017 05:54:17

Middle Channel

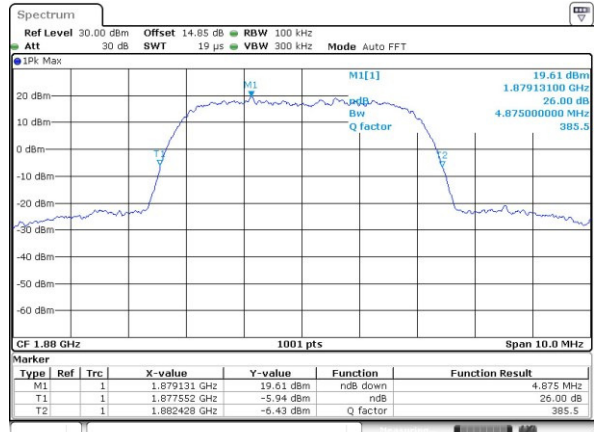

Date: 23 JAN 2017 05:01:15

Highest Channel

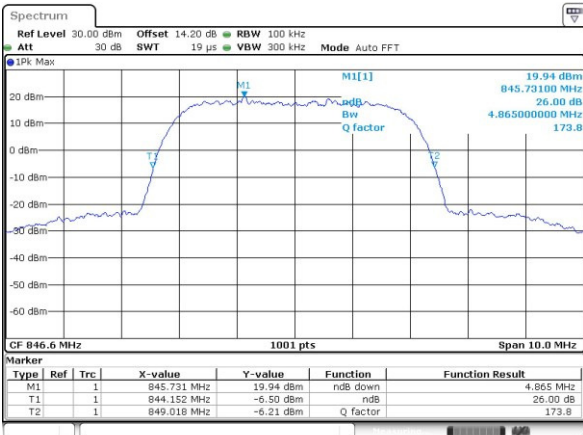

Date: 23 JAN 2017 05:54:55

Highest Channel

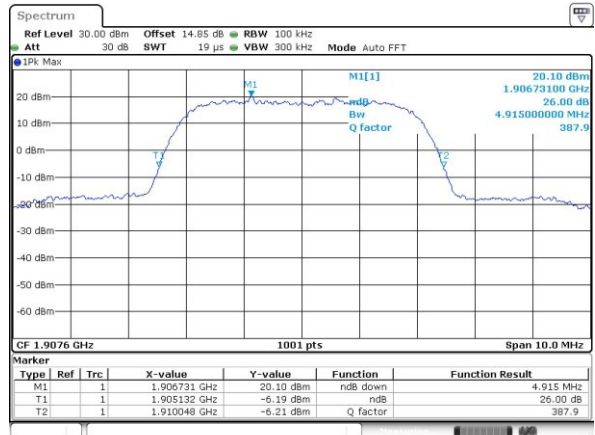

Date: 23 JAN 2017 05:01:56



WCDMA Band IV (RMC 12.2Kbps)

Lowest Channel

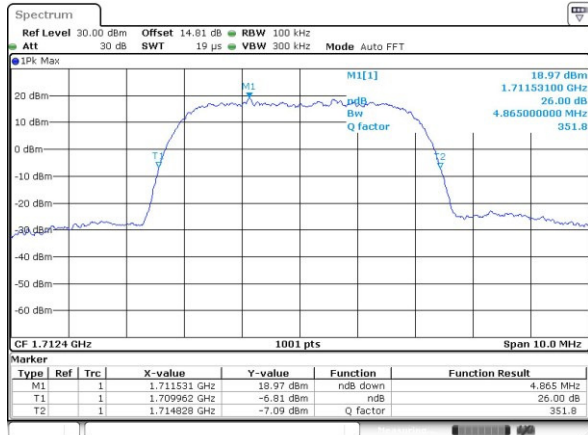

Date: 23 JAN 2017 05:29:42

Middle Channel

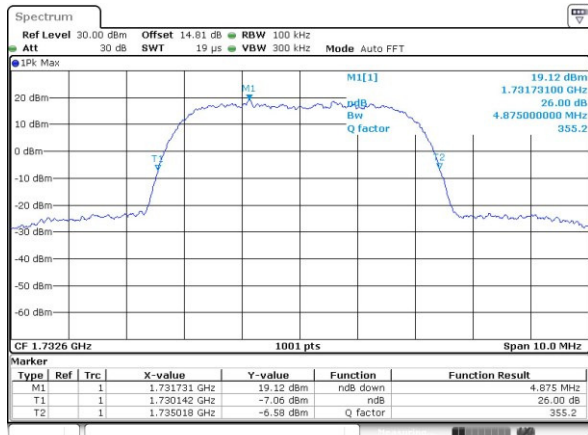

Date: 23 JAN 2017 05:30:21

Highest Channel

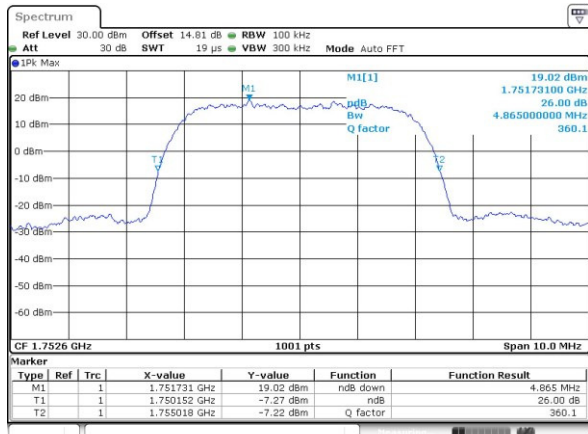

Date: 23 JAN 2017 05:30:58



### Occupied Bandwidth

Mode	GSM850(MHz)	
Mod.	GSM	EDGE class 8
Lowest CH	0.244	0.248
Middle CH	0.241	0.246
Highest CH	0.244	0.244

Mode	GSM1900(MHz)	
Mod.	GSM	EDGE class 8
Lowest CH	0.243	0.246
Middle CH	0.244	0.248
Highest CH	0.243	0.246

Mode	WCDMA Band V(MHz)	WCDMA Band II(MHz)	WCDMA Band IV(MHz)
Mod.	RMC 12.2Kbps	RMC 12.2Kbps	RMC 12.2Kbps
Lowest CH	4.20	4.21	4.20
Middle CH	4.21	4.21	4.21
Highest CH	4.21	4.22	4.20



GSM850 (GSM)

Lowest Channel

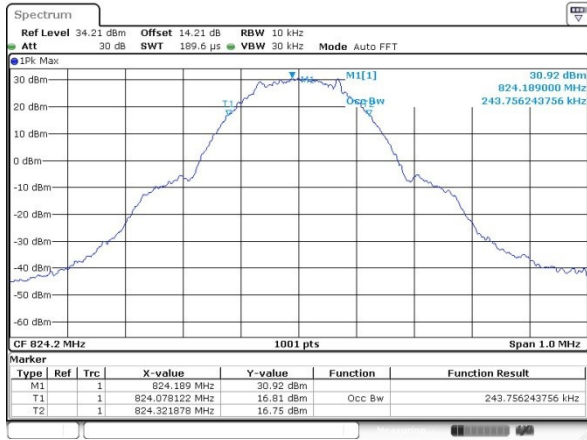

Date: 23 JAN 2017 06:26:44

GSM850 (EDGE class 8)

Lowest Channel

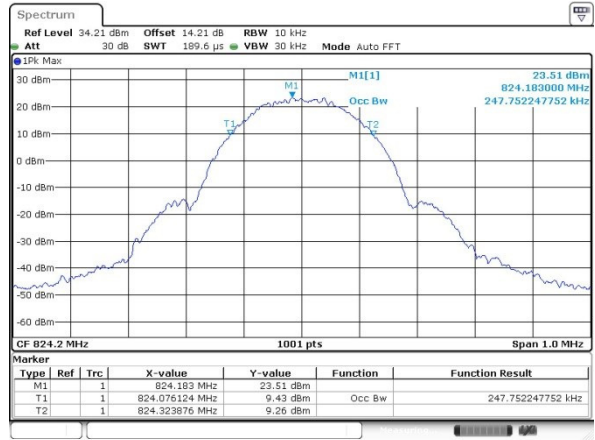

Date: 23 JAN 2017 06:57:58

Middle Channel

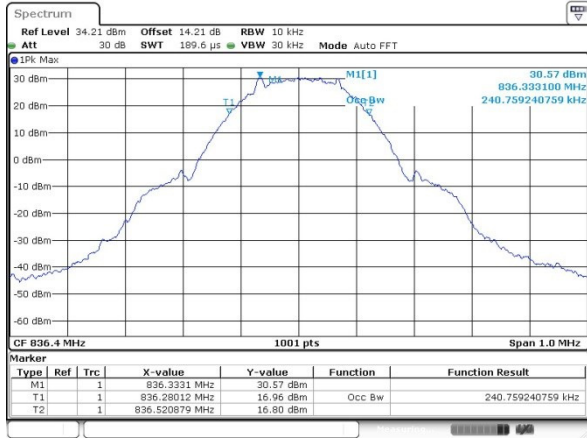

Date: 23 JAN 2017 06:27:28

Middle Channel

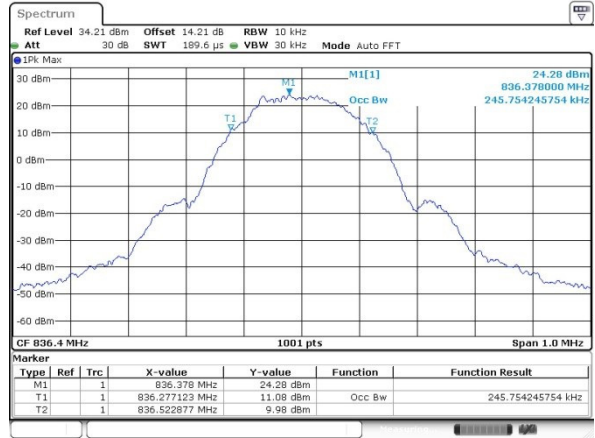

Date: 23 JAN 2017 06:58:42

Highest Channel

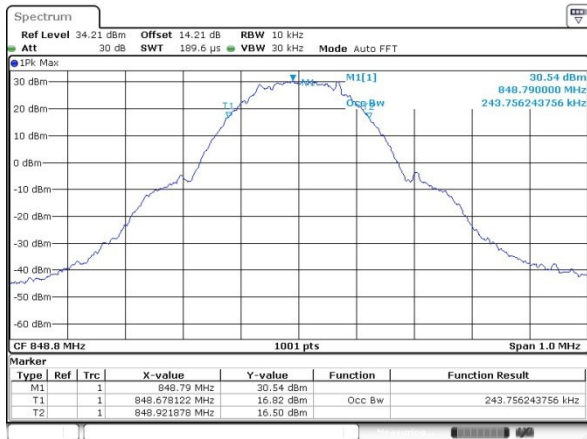

Date: 23 JAN 2017 06:28:09

Highest Channel

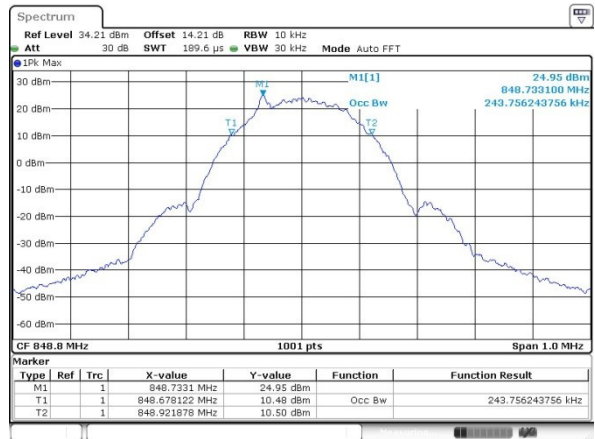

Date: 23 JAN 2017 06:59:20



GSM1900 (GSM)

Lowest Channel

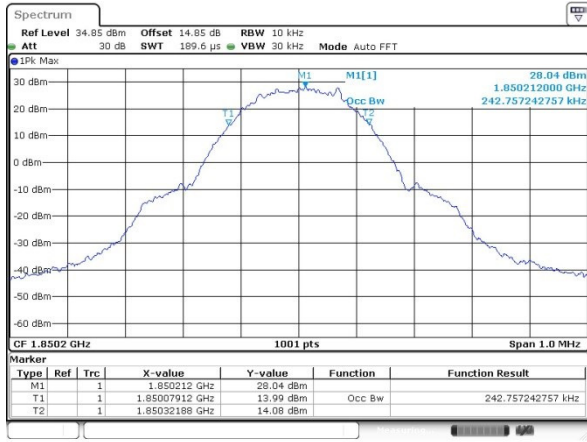

Date: 23 JAN 2017 07:49:00

GSM1900 (EDGE class 8)

Lowest Channel

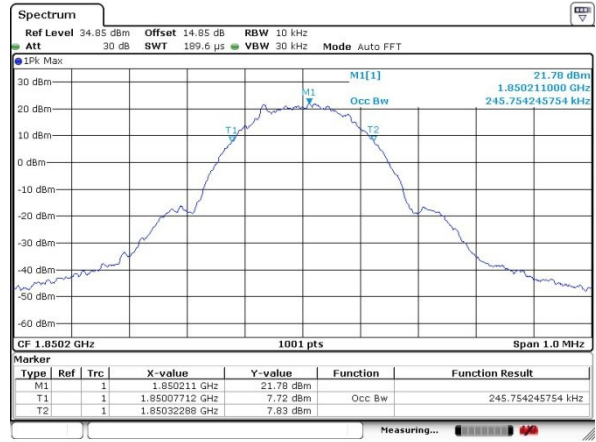

Date: 23 JAN 2017 08:13:32

Middle Channel

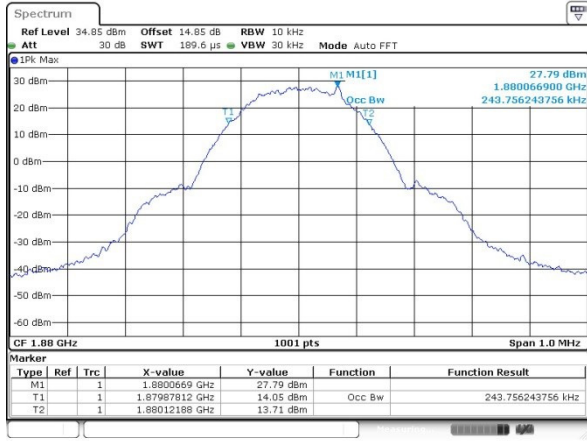

Date: 23 JAN 2017 07:49:36

Middle Channel

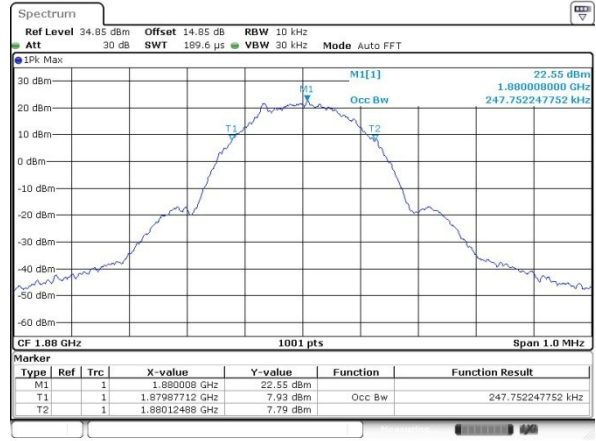

Date: 23 JAN 2017 08:12:12

Highest Channel

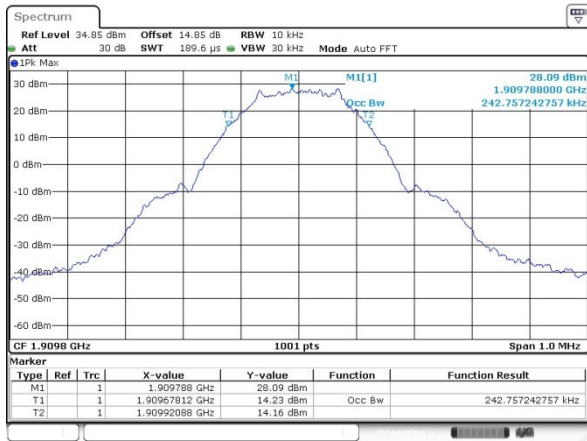

Date: 23 JAN 2017 07:50:09

Highest Channel

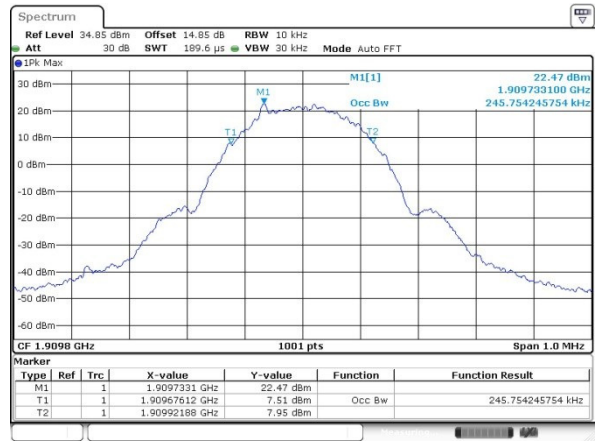

Date: 23 JAN 2017 08:12:47