



FCC RF Test Report

APPLICANT : HMD Global Oy
EQUIPMENT : Smart Phone
BRAND NAME : NOKIA
MODEL NAME : TA-1038
FCC ID : 2AJOTTA-1038
STANDARD : FCC Part 15 Subpart E §15.407
CLASSIFICATION : (NII) Unlicensed National Information Infrastructure

The product was received on Jan. 18, 2017 and testing was completed on Mar. 02, 2017. We, SPORTON INTERNATIONAL INC., would like to declare that the tested sample has been evaluated in accordance with the test procedures and has been in compliance with the applicable technical standards.

The test results in this report apply exclusively to the tested model / sample. Without written approval of SPORTON INTERNATIONAL INC., the test report shall not be reproduced except in full.

Reviewed by: Joseph Lin / Supervisor

Approved by: Jones Tsai / Manager



SPORTON INTERNATIONAL INC.

No. 52, Hwa Ya 1st Rd., Hwa Ya Technology Park, Kwei-Shan District, Tao Yuan City, Taiwan, R.O.C.



TABLE OF CONTENTS

REVISION HISTORY..... 3

SUMMARY OF TEST RESULT 4

1 GENERAL DESCRIPTION 5

 1.1 Applicant 5

 1.2 Manufacturer 5

 1.3 Product Feature of Equipment Under Test..... 5

 1.4 Product Specification of Equipment Under Test..... 6

 1.5 Modification of EUT 6

 1.6 Testing Location 7

 1.7 Applicable Standards..... 7

2 TEST CONFIGURATION OF EQUIPMENT UNDER TEST 8

 2.1 Carrier Frequency and Channel 8

 2.2 Test Mode 9

 2.3 Connection Diagram of Test System 10

 2.4 Support Unit used in test configuration and system 11

 2.5 EUT Operation Test Setup 11

 2.6 Measurement Results Explanation Example..... 11

3 TEST RESULT 12

 3.1 6dB and 26dB and 99% Occupied Bandwidth Measurement 12

 3.2 Maximum Conducted Output Power Measurement 15

 3.3 Power Spectral Density Measurement 16

 3.4 Unwanted Emissions Measurement..... 19

 3.5 AC Conducted Emission Measurement..... 24

 3.6 Frequency Stability Measurement 28

 3.7 Automatically Discontinue Transmission 29

 3.8 Antenna Requirements 30

4 LIST OF MEASURING EQUIPMENT 31

5 UNCERTAINTY OF EVALUATION 33

APPENDIX A. CONDUCTED TEST RESULTS

APPENDIX B. RADIATED SPURIOUS EMISSION

APPENDIX C. DUTY CYCLE PLOTS

APPENDIX D. SETUP PHOTOGRAPHS



SUMMARY OF TEST RESULT

Report Section	FCC Rule	Description	Limit	Result	Remark
3.1	15.403(i)	6dB, 26dB and 99% Occupied Bandwidth	$\geq 500\text{kHz}$	Pass	-
3.2	15.407(a)	Maximum Conducted Output Power	$\leq 30\text{ dBm}$	Pass	-
3.3	15.407(a)	Power Spectral Density	$\leq 30\text{ dBm}/500\text{kHz}$	Pass	-
3.4	15.407(b)	Unwanted Emissions	15.407(b)(4)(i) & 15.209(a)	Pass	Under limit 4.23 dB at 17235.000 MHz
3.5	15.207	AC Conducted Emission	15.207(a)	Pass	Under limit 13.4 dB at 13.558 MHz
3.6	15.407(g)	Frequency Stability	Within Operation Band	Pass	-
3.7	15.407(c)	Automatically Discontinue Transmission	Discontinue Transmission	Pass	-
3.8	15.203 & 15.407(a)	Antenna Requirement	N/A	Pass	-



1 General Description

1.1 Applicant

HMD Global Oy
Karaportti 2, 02610 Espoo, Finland

1.2 Manufacturer

HMD Global Oy
Karaportti 2, 02610 Espoo, Finland

1.3 Product Feature of Equipment Under Test

Product Feature	
Equipment	Smart Phone
Brand Name	NOKIA
Model Name	TA-1038
FCC ID	2AJOTTA-1038
EUT supports Radios application	GSM/GPRS/EGPRS/WCDMA/HSPA/DC-HSDPA/ HSPA+/LTE/NFC WLAN 2.4GHz 802.11b/g/n HT20/ WLAN 5GHz 802.11a/n HT20/HT40 Bluetooth v3.0 + EDR/ Bluetooth v 4.0 LE/ Bluetooth v4.1 LE / Bluetooth v4.2 LE
IMEI Code	Conducted: 356805080006838/356805080006820 Conduction: 356805080006838/356805080006820 Radiation: 356802080000358
HW Version	DVT1.5
SW Version	000C_1_26A
EUT Stage	Production Unit

Remark: The above EUT's information was declared by manufacturer. Please refer to the specifications or user's manual for more detailed description.



1.4 Product Specification of Equipment Under Test

Standards-related Product Specification	
Tx/Rx Channel Frequency Range	5745 MHz ~ 5825 MHz
Maximum Output Power	<5745 MHz ~ 5825 MHz> 802.11a : 8.02 dBm / 0.0063 W 802.11n HT20 : 8.14 dBm / 0.0065 W 802.11n HT40 : 8.28 dBm / 0.0067 W
99% Occupied Bandwidth	802.11a : 17.95 MHz 802.11n HT20 : 18.50 MHz 802.11n HT40 : 36.50 MHz
Type of Modulation	802.11a/n : OFDM (BPSK / QPSK / 16QAM / 64QAM)
Antenna Type / Gain	Loop Antenna with gain -2.30 dBi

1.5 Modification of EUT

No modifications are made to the EUT during all test items.



1.6 Testing Location

Sporton Lab is accredited to ISO 17025 by Taiwan Accreditation Foundation (TAF code : 1190) and the FCC designation No. TW1022 under the FCC 2.948(e) by Mutual Recognition Agreement (MRA) in FCC Test.

Test Site	SPORTON INTERNATIONAL INC.		
Test Site Location	No. 52, Hwa Ya 1 st Rd., Hwa Ya Technology Park, Kwei-Shan District, Tao Yuan City, Taiwan, R.O.C. TEL: +886-3-327-3456 FAX: +886-3-328-4978		
Test Site No.	Sporton Site No.		
	TH05-HY	CO05-HY	03CH12-HY

Note: The test site complies with ANSI C63.4 2014 requirement.

1.7 Applicable Standards

According to the specifications of the manufacturer, the EUT must comply with the requirements of the following standards:

- ♦ FCC Part 15 Subpart E
- ♦ FCC KDB 789033 D02 General UNII Test Procedures New Rules v01r03
- ♦ ANSI C63.10-2013

Remark:

1. All test items were verified and recorded according to the standards and without any deviation during the test.
2. This EUT has also been tested and complied with the requirements of FCC Part 15, Subpart B, recorded in a separate test report.



2 Test Configuration of Equipment Under Test

The EUT has been associated with peripherals and configuration operated in a manner tended to maximize its emission characteristics in a typical application. Frequency range investigated: conducted emission (150 kHz to 30 MHz) and radiated emission (9 kHz to the 10th harmonic of the highest fundamental frequency or to 40 GHz, whichever is lower). For radiated measurement, pre-scanned in three orthogonal panels, X, Y, Z. The worst cases (X plane) were recorded in this report.

2.1 Carrier Frequency and Channel

Frequency Band	Channel	Freq. (MHz)	Channel	Freq. (MHz)
5745-5825 MHz Band 4 (U-NII-3)	149	5745	157	5785
	151*	5755	159*	5795
	153	5765	161	5805
	-	-	165	5825

Note: The above Frequency and Channel in "*" were 802.11n HT40.



2.2 Test Mode

Final test mode of conducted test items and radiated spurious emissions are considering the modulation and worse data rates from the power table described in section 2.2.

Modulation	Data Rate
802.11a	6 Mbps
802.11n HT20	MCS0
802.11n HT40	MCS0

Test Cases	
AC Conducted Emission	Mode 1 : WCDMA Band II Link + Bluetooth Link + WLAN Link(5G) + USB Cable (Charging from Adapter) + Earphone + Camera(Front) + SIM1
	Mode 2 : GSM850 Idle + Bluetooth Idle + WLAN Idle + USB Cable (Charging from Adapter) + Earphone + NFC On + SIM2
Remark: The worst case of conducted emission is mode 2; only the test data of it was reported.	

Ch. #	Band IV : 5725-5850 MHz		
	802.11a	802.11n HT20	802.11n HT40
L Low	149	149	151
M Middle	157	157	-
H High	165	165	159

2.3 Connection Diagram of Test System

<WLAN Tx Mode>

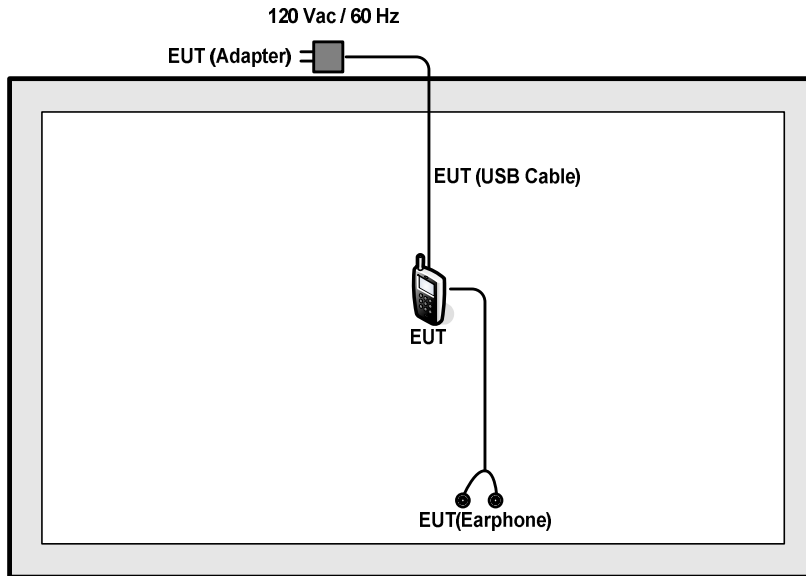

<AC Conducted Emission Mode>

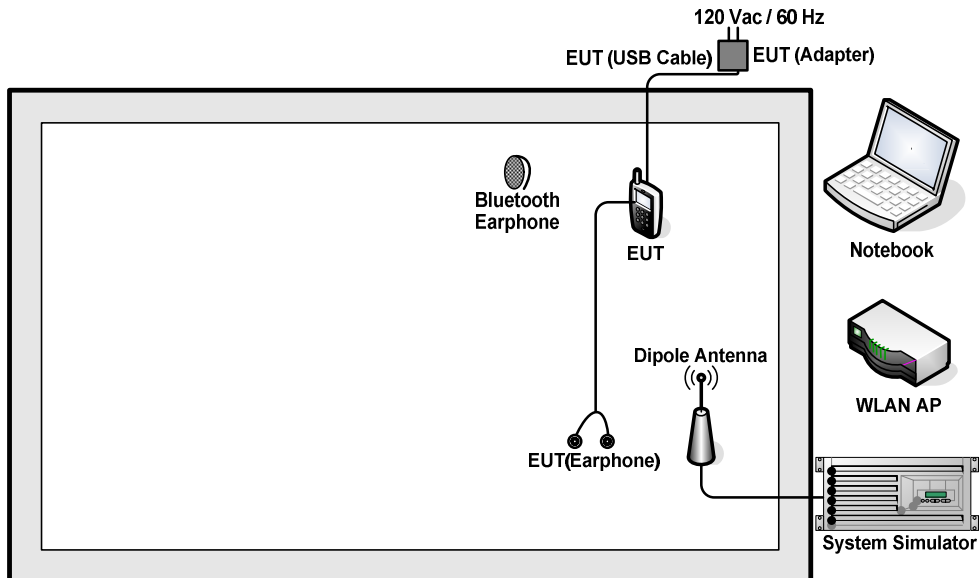



2.4 Support Unit used in test configuration and system

Item	Equipment	Trade Name	Model Name	FCC ID	Data Cable	Power Cord
1.	System Simulator	Anritsu	MT8820C	N/A	N/A	Unshielded, 1.8 m
2.	WLAN AP	ASUS	RT-AC66U	MSQ-RTAC66U	N/A	Unshielded, 1.8m
3.	Notebook	Dell	Latitude E6320	FCC DoC	N/A	AC I/P: Unshielded, 1.2 m DC O/P: Shielded, 1.8 m
4.	Bluetooth Earphone	SonyEricsson	MW600	PY700A2029	N/A	N/A
5.	SD Card	SanDisk	MicroSD HC	FCC DoC	N/A	N/A

2.5 EUT Operation Test Setup

For WLAN RF test items, an engineering test program was provided and enabled to make EUT continuously transmit/receive.

For AC power line conducted emissions, the EUT was set to connect with the Notebook under large package sizes transmission.

2.6 Measurement Results Explanation Example

For all conducted test items:

The offset level is set in the spectrum analyzer to compensate the RF cable loss and attenuator factor between EUT conducted output port and spectrum analyzer. With the offset compensation, the spectrum analyzer reading level is exactly the EUT RF output level.

Example :

The spectrum analyzer offset is derived from RF cable loss and attenuator factor.

Offset = RF cable loss + attenuator factor.

Following shows an offset computation example with cable loss 0.3 dB and 24dB attenuator.

$$\begin{aligned} \text{Offset(dB)} &= \text{RF cable loss(dB)} + \text{attenuator factor(dB)}. \\ &= 0.3 + 24 = 24.3 \text{ (dB)} \end{aligned}$$

3 Test Result

3.1 6dB and 26dB and 99% Occupied Bandwidth Measurement

3.1.1 Description of 6dB and 26dB and 99% Occupied Bandwidth

The minimum 6 dB bandwidth shall be at least 500 kHz.

26dB and 99% Occupied bandwidth are reporting only.

3.1.2 Measuring Instruments

The measuring equipment is listed in the section 4 of this test report.

3.1.3 Test Procedures

1. The testing follows FCC KDB 789033 D02 General UNII Test Procedures New Rules v01r03.
Section C) Emission bandwidth for the band 5.725-5.85GHz
2. Set RBW = 100kHz.
3. Set the VBW $\geq 3 \times$ RBW.
4. Detector = Peak.
5. Trace mode = max hold
6. Measure the maximum width of the emission that is 6 dB down from the peak of the emission.
7. Measure and record the results in the test report.

3.1.4 Test Setup

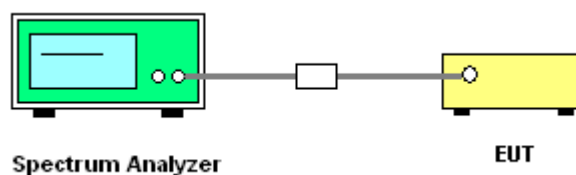



3.1.5 Test Result of 6dB Bandwidth

Please refer to Appendix A.

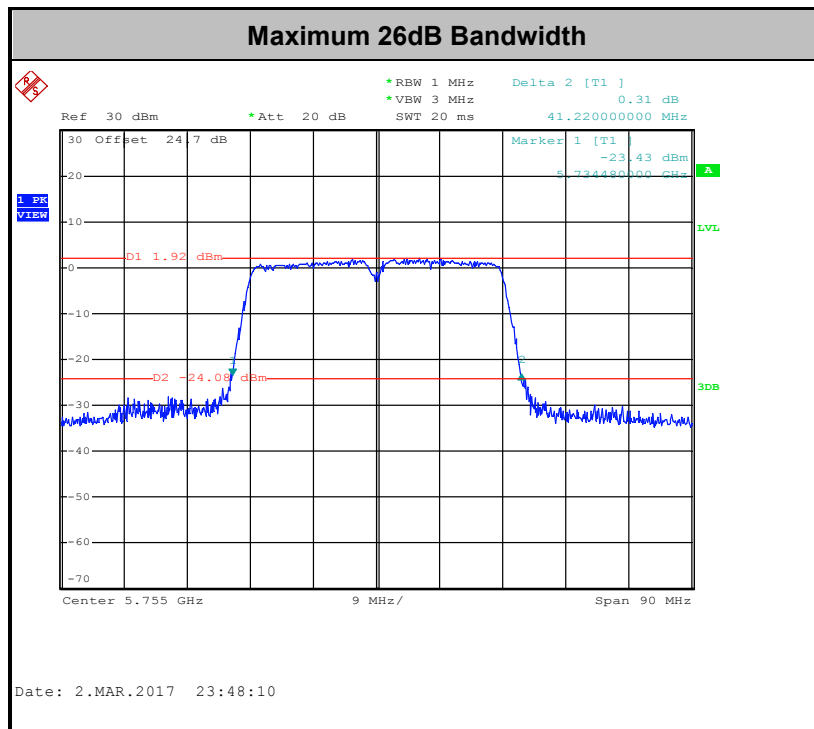
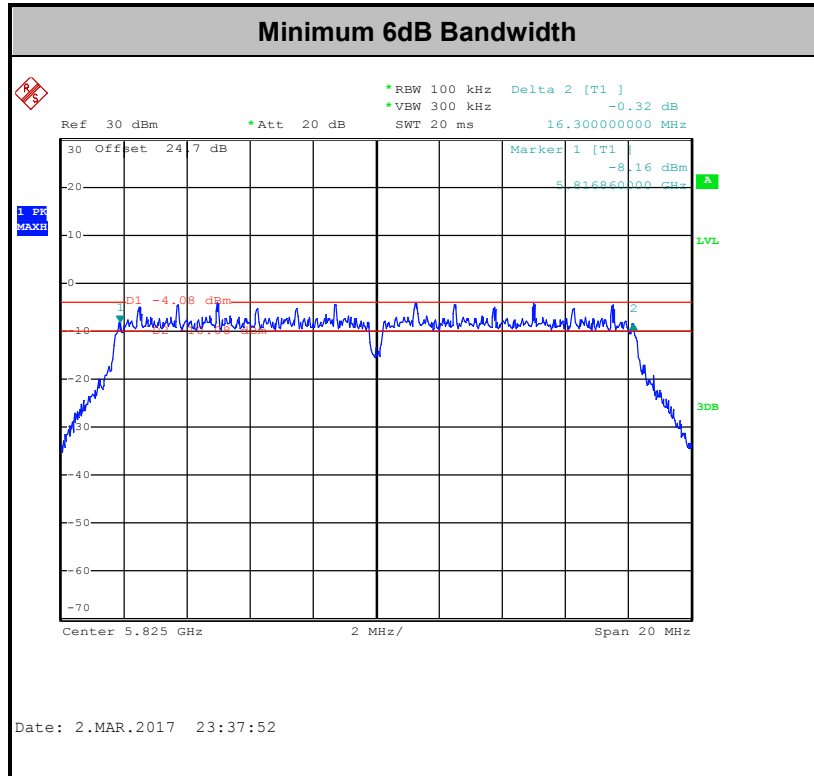

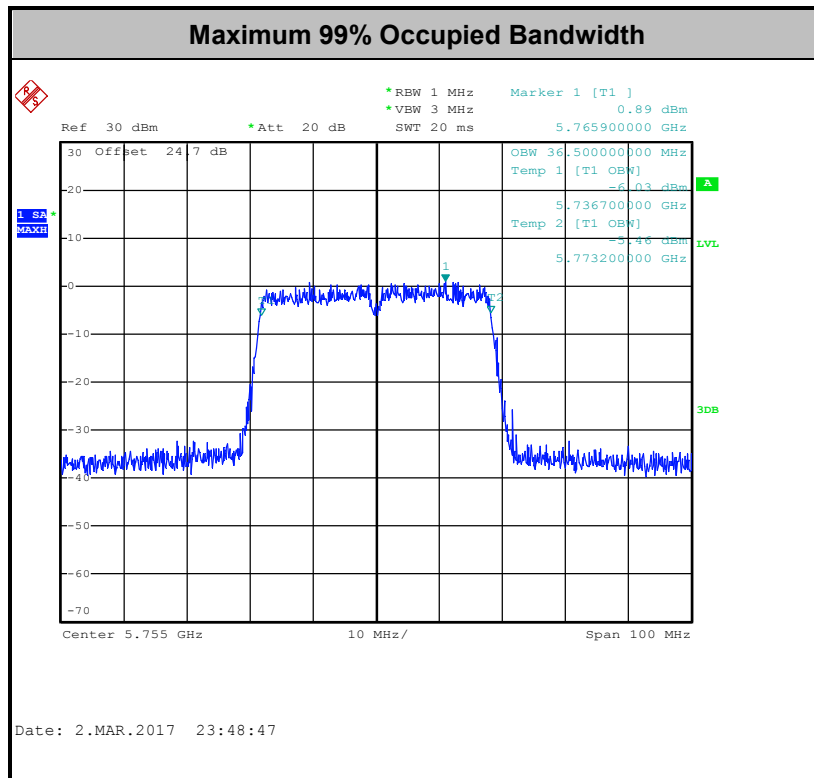

Note: The occupied channel bandwidth is maintained within the band of operation for all of the modulations.

3.2 Maximum Conducted Output Power Measurement

3.2.1 Limit of Maximum Conducted Output Power

For the band 5.725–5.85 GHz, the maximum conducted output power over the frequency band of operation shall not exceed 1 W.

If transmitting antennas of directional gain greater than 6 dBi are used, the peak output power shall be reduced by the amount in dB that the directional gain of the antenna exceeds 6 dBi.

3.2.2 Measuring Instruments

The measuring equipment is listed in the section 4 of this test report.

3.2.3 Test Procedures

The testing follows Method PM of FCC KDB 789033 D02 General UNII Test Procedures New Rules v01r03.

Method PM (Measurement using an RF average power meter):

1. Measurement is performed using a wideband RF power meter.
2. The EUT is configured to transmit continuously with a consistent duty cycle at its maximum power control level.
3. Measure the average power of the transmitter, and the average power is corrected with duty factor, $10 \log(1/x)$, where x is the duty cycle.

3.2.4 Test Setup

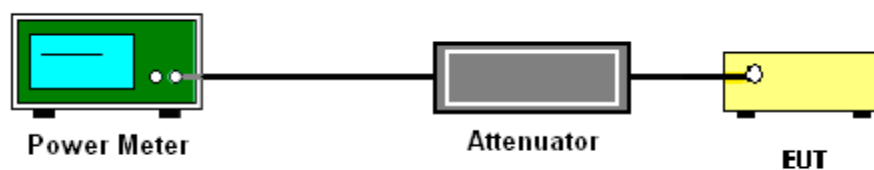

3.2.5 Test Result of Maximum Conducted Output Power

Please refer to Appendix A.



3.3 Power Spectral Density Measurement

3.3.1 Limit of Power Spectral Density

For the band 5.725–5.85 GHz, the maximum power spectral density shall not exceed 30 dBm in any 500-kHz band.

If transmitting antennas of directional gain greater than 6 dBi are used, the peak output power shall be reduced by the amount in dB that the directional gain of the antenna exceeds 6 dBi.

3.3.2 Measuring Instruments

The measuring equipment is listed in the section 4 of this test report.

3.3.3 Test Procedures

The testing follows FCC KDB 789033 D02 General UNII Test Procedures New Rules v01r03. Section F) Maximum power spectral density.

Method SA-2

(trace averaging across on and off times of the EUT transmissions, followed by duty cycle correction).

- Measure the duty cycle.
- Set span to encompass the entire emission bandwidth (EBW) of the signal.
- Set RBW = 300 kHz.
- Set VBW \geq 1 MHz.
- Number of points in sweep \geq 2 Span / RBW.
- Sweep time = auto.
- Detector = RMS
- Trace average at least 100 traces in power averaging mode.
- Add $10 \log(500\text{kHz}/\text{RBW})$ to the test result.
- Add $10 \log(1/x)$, where x is the duty cycle, to the measured power in order to compute the average power during the actual transmission times. For example, add $10 \log(1/0.25) = 6$ dB if the duty cycle is 25 percent.

1. The RF output of EUT was connected to the spectrum analyzer by a low loss cable.
2. Each plot has already offset with cable loss, and attenuator loss. Measure the PPSD and record it.

3.3.4 Test Setup

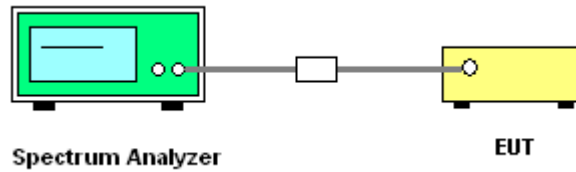



3.3.5 Test Result of Power Spectral Density

Please refer to Appendix A.

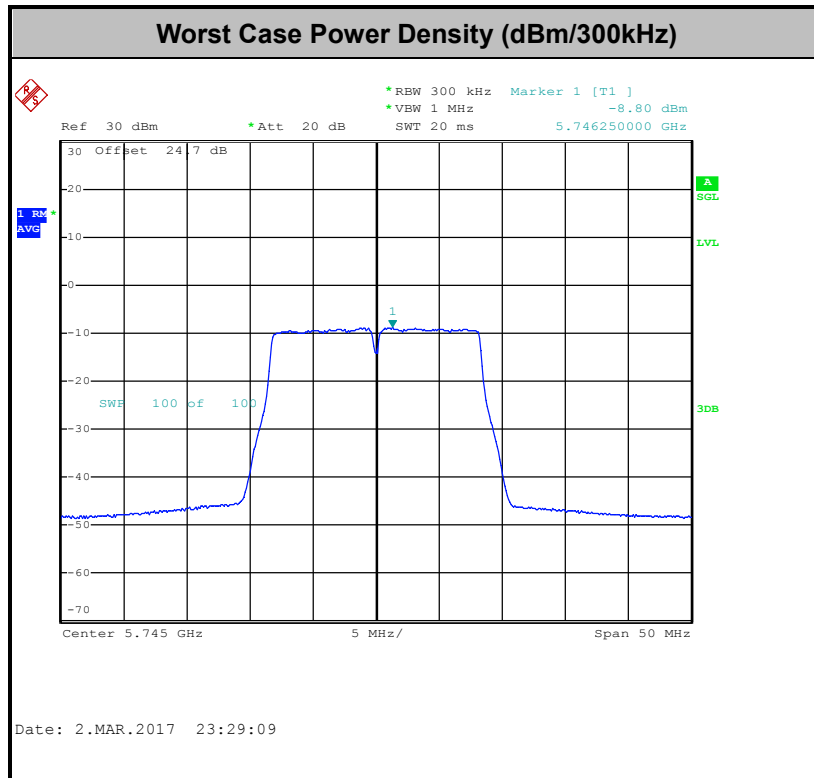



3.4 Unwanted Emissions Measurement

This section as specified in FCC Part 15.407(b) is to measure unwanted emissions through radiated measurement for band edge spurious emissions and out of band emissions measurement. The unwanted emissions shall comply with 15.407(b)(1) to (6), and restricted bands per FCC Part15.205.

3.4.1 Limit of Unwanted Emissions

(1) For transmitters operating in the 5.725-5.85 GHz band:

15.407(b)(4)(i) All emissions shall be limited to a level of -27 dBm/MHz at 75 MHz or more above or below the band edge increasing linearly to 10 dBm/MHz at 25 MHz above or below the band edge, and from 25 MHz above or below the band edge increasing linearly to a level of 15.6 dBm/MHz at 5 MHz above or below the band edge, and from 5 MHz above or below the band edge increasing linearly to a level of 27 dBm/MHz at the band edge.

(2) Unwanted spurious emissions fallen in restricted bands per FCC Part15.205 shall comply with the general field strength limits set forth in § 15.209 as below table,

Frequency (MHz)	Field Strength (microvolts/meter)	Measurement Distance (meters)
0.009 – 0.490	2400/F(kHz)	300
0.490 – 1.705	24000/F(kHz)	30
1.705 – 30.0	30	30
30 – 88	100	3
88 – 216	150	3
216 - 960	200	3
Above 960	500	3

Note: The following formula is used to convert the EIRP to field strength.

$$E = \frac{1000000\sqrt{30P}}{3} \mu\text{V/m, where P is the eirp (Watts)}$$



EIRP (dBm)	Field Strength at 3m (dBµV/m)
-17	78.3
- 27	68.3

(3) KDB 789033 D02 General UNII Test Procedures New Rules v01r03 G)2)c) As specified in 15.407(b), emissions above 1000 MHz that are outside of the restricted bands are subject to a peak emission limit of -27 dBm/MHz (or -17 dBm/MHz as specified in 15.407(b)(4)). However, an out-of-band emission that complies with both the average and peak limits of 15.209 is not required to satisfy the -27 dBm/MHz or -17 dBm/MHz peak emission limit.

3.4.2 Measuring Instruments

The measuring equipment is listed in the section 4 of this test report.

3.4.3 Test Procedures

1. The testing follows FCC KDB 789033 D02 General UNII Test Procedures New Rules v01r03. Section G) Unwanted emissions measurement.

(1) Procedure for Unwanted Emissions Measurements Below 1000MHz

- RBW = 120 kHz
- VBW = 300 kHz
- Detector = Peak
- Trace mode = max hold

(2) Procedure for Peak Unwanted Emissions Measurements Above 1000 MHz

- RBW = 1 MHz
- VBW ≥ 3 MHz
- Detector = Peak
- Sweep time = auto
- Trace mode = max hold

(3) Procedures for Average Unwanted Emissions Measurements Above 1000MHz

- RBW = 1 MHz
- VBW = 10 Hz, when duty cycle is no less than 98 percent.
- VBW ≥ 1/T, when duty cycle is less than 98 percent where T is the minimum transmission duration over which the transmitter is on and is transmitting at its maximum power control level for the tested mode of operation.

2. The EUT was placed on a turntable with 0.8 meter for frequency below 1GHz and 1.5 meter for frequency above 1GHz respectively above ground.
3. The EUT was set 3 meters from the interference receiving antenna which was mounted on the top of a variable height antenna tower.
4. The antenna is a broadband antenna and its height is adjusted between one meter and four meters above ground to find the maximum value of the field strength for both horizontal polarization and vertical polarization of the antenna.
5. For each suspected emission, the EUT was arranged to its worst case and then adjust the antenna tower (from 1 m to 4 m) and turntable (from 0 degree to 360 degrees) to find the maximum reading.
6. For testing below 1GHz, if the emission level of the EUT in peak mode was 3 dB lower than the limit specified, then peak values of EUT will be reported, otherwise, the emissions will be repeated one by one using the CISPR quasi-peak method and reported.
7. For testing above 1GHz, the emission level of the EUT in peak mode was 20dB lower than average limit (that means the emission level in average mode also complies with the limit in average mode), then peak values of EUT will be reported, otherwise, the emissions will be measured in average mode again and reported.

3.4.4 Test Setup

For radiated emissions below 30MHz

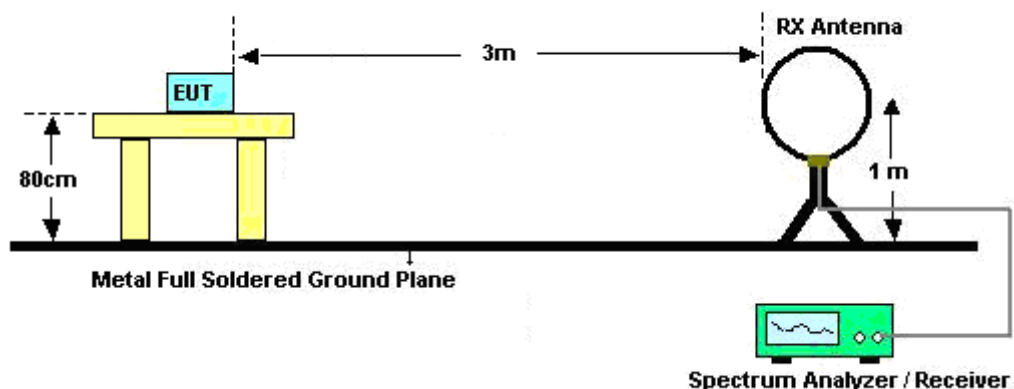

For radiated emissions from 30MHz to 1GHz

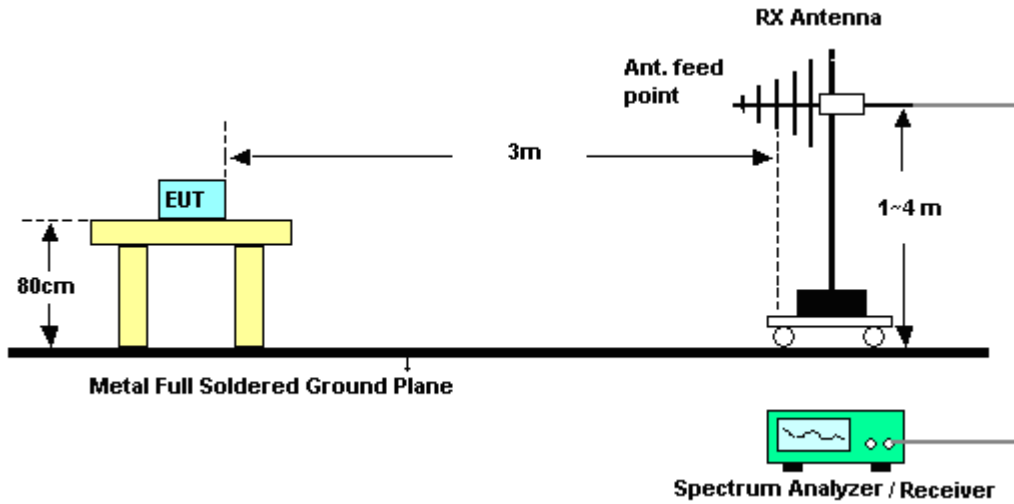

For radiated emissions above 1GHz

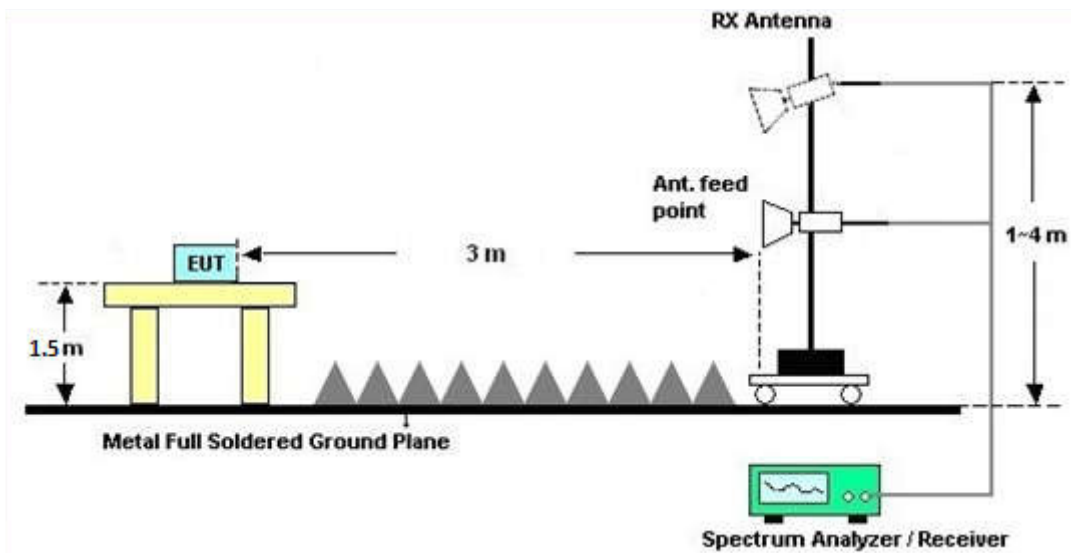



3.4.5 Test Results of Radiated Spurious Emissions (9 kHz ~ 30 MHz)

The low frequency, which started from 9 kHz to 30MHz, was pre-scanned and the result which was 20dB lower than the limit line per 15.31(o) was not reported.

3.4.6 Test Result of Radiated Spurious at Band Edges

Please refer to Appendix B.

3.4.7 Duty Cycle

Please refer to Appendix C.

3.4.8 Test Result of Radiated Spurious Emissions (30MHz ~ 10th Harmonic)

Please refer to Appendix B.



3.5 AC Conducted Emission Measurement

3.5.1 Limit of AC Conducted Emission

For equipment that is designed to be connected to the public utility (AC) power line, the radio frequency voltage that is conducted back onto the AC power line on any frequency or frequencies within the band 150 kHz to 30 MHz shall not exceed the limits in the following table.

Frequency of emission (MHz)	Conducted limit (dB μ V)	
	Quasi-peak	Average
0.15-0.5	66 to 56*	56 to 46*
0.5-5	56	46
5-30	60	50

*Decreases with the logarithm of the frequency.

3.5.2 Measuring Instruments

The measuring equipment is listed in the section 4 of this test report.

3.5.3 Test Procedures

1. The EUT was placed 0.4 meter from the conducting wall of the shielding room was kept at least 80 centimeters from any other grounded conducting surface.
2. Connect EUT to the power mains through a line impedance stabilization network (LISN).
3. All the support units are connecting to the other LISN.
4. The LISN provides 50 ohm coupling impedance for the measuring instrument.
5. The FCC states that a 50 ohm, 50 microhenry LISN should be used.
6. Both sides of AC line were checked for maximum conducted interference.
7. The frequency range from 150 kHz to 30 MHz was searched.
8. Set the test-receiver system to Peak Detect Function and specified bandwidth with Maximum Hold Mode.

3.5.4 Test Setup

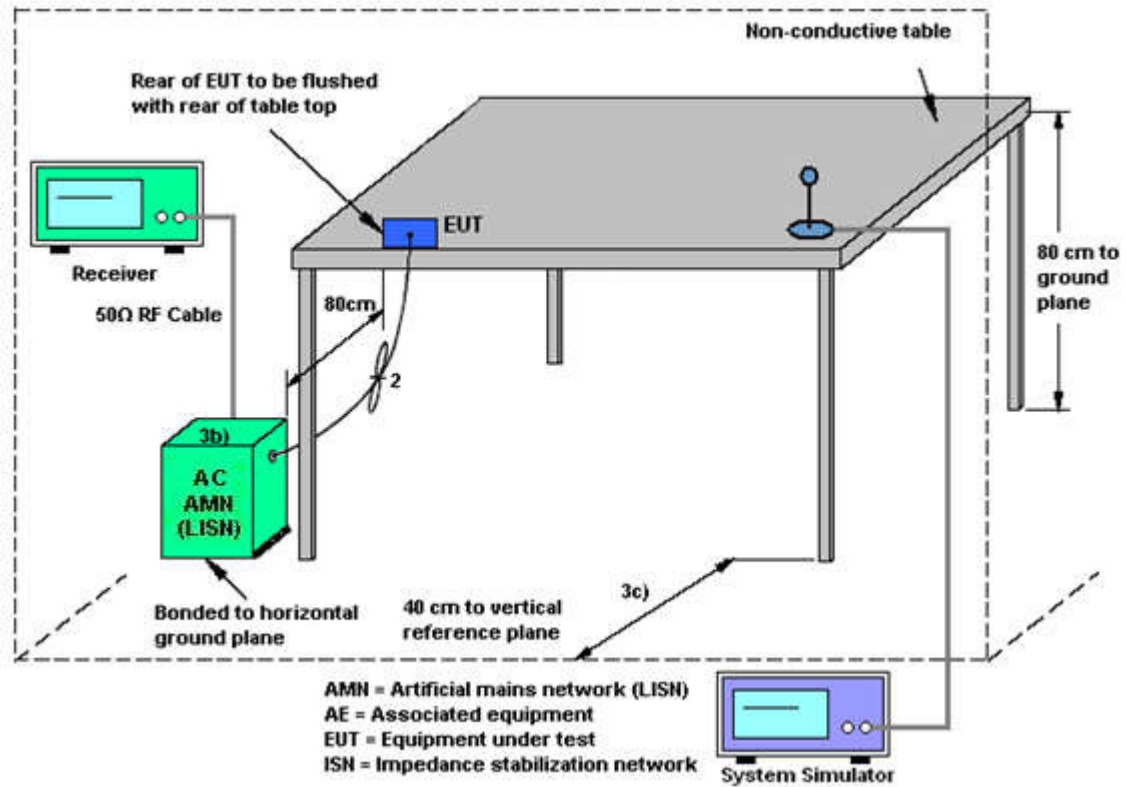



3.5.5 Test Result of AC Conducted Emission

Test Mode :	Mode 2	Temperature :	22~24°C
Test Engineer :	Kaichun Chu and Arthur Hsieh	Relative Humidity :	51~53%
Test Voltage :	120Vac / 60Hz	Phase :	Line
Function Type :	GSM850 Idle + Bluetooth Idle + WLAN Idle + USB Cable (Charging from Adapter) + Earphone + NFC On + SIM2		

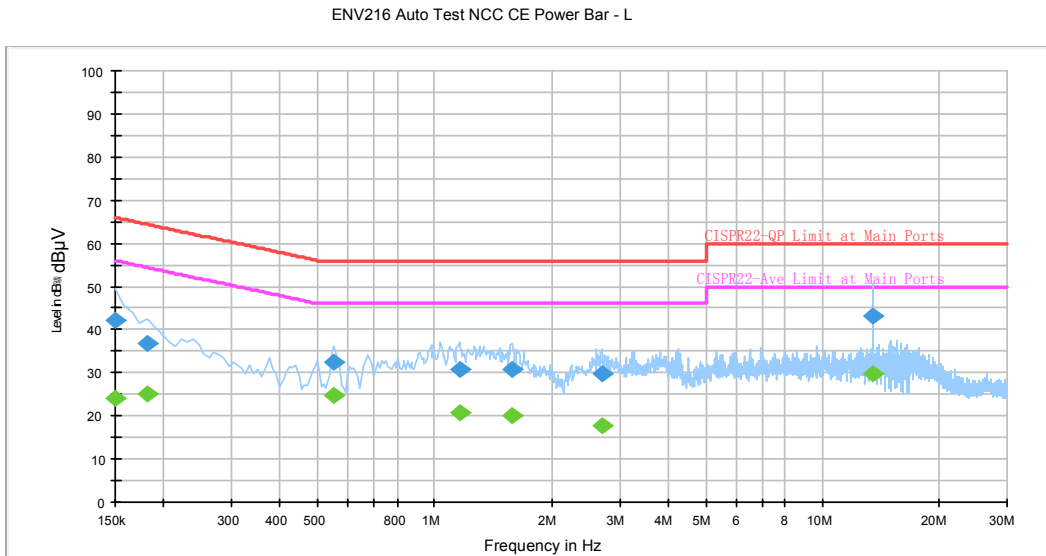

Final Result : QuasiPeak

Frequency (MHz)	QuasiPeak (dBµV)	Filter	Line	Corr. (dB)	Margin (dB)	Limit (dBµV)
0.150000	42.3	Off	L1	19.6	23.7	66.0
0.182000	36.7	Off	L1	19.6	27.7	64.4
0.550000	32.5	Off	L1	19.6	23.5	56.0
1.158000	30.9	Off	L1	19.6	25.1	56.0
1.582000	30.6	Off	L1	19.6	25.4	56.0
2.694000	29.9	Off	L1	19.3	26.1	56.0
13.558000	43.3	Off	L1	20.1	16.7	60.0

Final Result : Average

Frequency (MHz)	Average (dBµV)	Filter	Line	Corr. (dB)	Margin (dB)	Limit (dBµV)
0.150000	24.1	Off	L1	19.6	31.9	56.0
0.182000	25.0	Off	L1	19.6	29.4	54.4
0.550000	24.6	Off	L1	19.6	21.4	46.0
1.158000	20.9	Off	L1	19.6	25.1	46.0
1.582000	20.1	Off	L1	19.6	25.9	46.0
2.694000	17.6	Off	L1	19.3	28.4	46.0
13.558000	29.7	Off	L1	20.1	20.3	50.0



Test Mode :	Mode 2	Temperature :	22~24°C
Test Engineer :	Kaichun Chu and Arthur Hsieh	Relative Humidity :	51~53%
Test Voltage :	120Vac / 60Hz	Phase :	Neutral
Function Type :	GSM850 Idle + Bluetooth Idle + WLAN Idle + USB Cable (Charging from Adapter) + Earphone + NFC On + SIM2		

ENV216 Auto Test NCC CE Power Bar - N

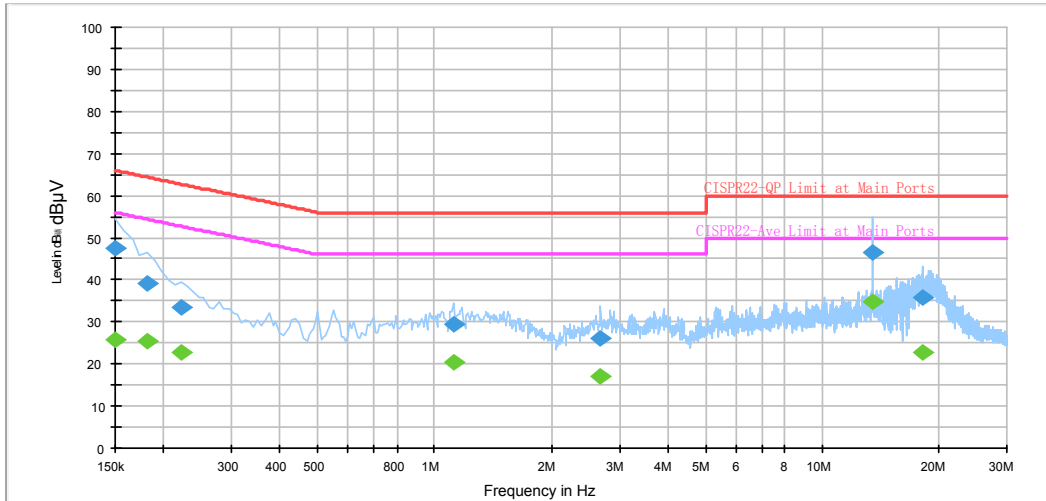

Final Result : QuasiPeak

Frequency (MHz)	QuasiPeak (dBµV)	Filter	Line	Corr. (dB)	Margin (dB)	Limit (dBµV)
0.150000	47.6	Off	N	19.6	18.4	66.0
0.182000	39.0	Off	N	19.5	25.4	64.4
0.222000	33.5	Off	N	19.5	29.2	62.7
1.118000	29.3	Off	N	19.6	26.7	56.0
2.686000	26.0	Off	N	19.4	30.0	56.0
13.558000	46.6	Off	N	20.2	13.4	60.0
18.158000	35.8	Off	N	20.4	24.2	60.0

Final Result : Average

Frequency (MHz)	Average (dBµV)	Filter	Line	Corr. (dB)	Margin (dB)	Limit (dBµV)
0.150000	25.7	Off	N	19.6	30.3	56.0
0.182000	25.6	Off	N	19.5	28.8	54.4
0.222000	22.7	Off	N	19.5	30.0	52.7
1.118000	20.4	Off	N	19.6	25.6	46.0
2.686000	16.9	Off	N	19.4	29.1	46.0
13.558000	34.8	Off	N	20.2	15.2	50.0
18.158000	22.6	Off	N	20.4	27.4	50.0

3.6 Frequency Stability Measurement

3.6.1 Limit of Frequency Stability

Manufacturers of U-NII devices are responsible for ensuring frequency stability such that an emission is maintained within the band of operation under all conditions of normal operation as specified in the user's manual.

3.6.2 Measuring Instruments

The measuring equipment is listed in the section 4 of this test report.

3.6.3 Test Procedures

1. To ensure emission at the band edge is maintained within the authorized band, those values shall be measured by radiation emissions at upper and lower frequency points, and finally compensated by frequency deviation as procedures below.
2. The EUT was operated at the maximum output power, and connected to the spectrum analyzer, which is set to maximum hold function and peak detector. The peak value of the power envelope was measured and noted. The upper and lower frequency points were respectively measured relatively 10dB lower than the measured peak value.
3. The frequency deviation was calculated by adding the upper frequency point and the lower frequency point divided by two. Those detailed values of frequency deviation are provided in table below.

3.6.4 Test Setup

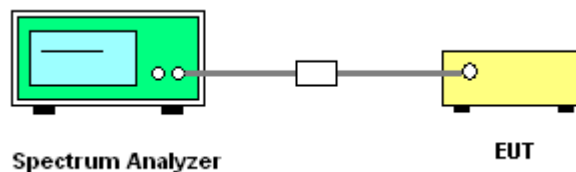

3.6.5 Test Result of Frequency Stability

Please refer to Appendix A.



3.7 Automatically Discontinue Transmission

3.7.1 Limit of Automatically Discontinue Transmission

The device shall automatically discontinue transmission in case of either absence of information to transmit or operational failure. These provisions are not intended to preclude the transmission of control or signaling information or the use of repetitive codes used by certain digital technologies to complete frame or burst intervals. Applicants shall include in their application for equipment authorization to describe how this requirement is met.

3.7.2 Measuring Instruments

The measuring equipment is listed in the section 4 of this test report.

3.7.3 Test Result of Automatically Discontinue Transmission

While the EUT is not transmitting any information, the EUT can automatically discontinue transmission and become standby mode for power saving. The EUT can detect the controlling signal of ACK message transmitting from remote device and verify whether it shall resend or discontinue transmission.



3.8 Antenna Requirements

3.8.1 Standard Applicable

According to FCC 47 CFR Section 15.407(a)(1)(2) ,if transmitting antenna directional gain is greater than 6 dBi, both the peak transmit power and the peak power spectral density shall be reduced by the amount in dB that the directional gain of the antenna exceeds 6 dBi.

3.8.2 Antenna Anti-Replacement Construction

An embedded-in antenna design is used.

3.8.3 Antenna Gain

The antenna gain is less than 6 dBi. Therefore, it is not necessary to reduce maximum peak output power limit.



4 List of Measuring Equipment

Instrument	Manufacturer	Model No.	Serial No.	Characteristics	Calibration Date	Test Date	Due Date	Remark
Hygrometer	Testo	608-H2	41410069	N/A	Aug. 28, 2016	Feb. 23, 2017~ Mar. 02, 2017	Aug. 27, 2017	Conducted (TH05-HY)
Power Meter	Anritsu	ML2495A	0932001	300MHz~40GHz	Sep. 29, 2016	Feb. 23, 2017~ Mar. 02, 2017	Sep. 28, 2017	Conducted (TH05-HY)
Power Sensor	Anritsu	MA2411B	0846202	300MHz~40GHz	Sep. 29, 2016	Feb. 23, 2017~ Mar. 02, 2017	Sep. 28, 2017	Conducted (TH05-HY)
Spectrum Analyzer	Rohde & Schwarz	FSP40	100055	9kHz-40GHz	Jul. 17, 2016	Feb. 23, 2017~ Mar. 02, 2017	Jul. 16, 2017	Conducted (TH05-HY)
Temperature Chamber	ESPEC	SH-641	92013720	-40°C ~90°C	Sep. 01, 2016	Feb. 23, 2017~ Mar. 02, 2017	Aug. 31, 2017	Conducted (TH05-HY)
Programmable Power Supply	GW Instek	PSS-2005	EL890094	1V~20V 0.5A~5A	Oct. 11, 2016	Feb. 23, 2017~ Mar. 02, 2017	Oct. 10, 2017	Conducted (TH05-HY)
AC Power Source	ChainTek	APC-1000W	N/A	N/A	N/A	Jan. 26, 2017~ Feb. 02, 2017	N/A	Conduction (CO05-HY)
EMI Test Receiver	Rohde & Schwarz	ESCI 7	100724	9kHz~7GHz	Aug. 30, 2016	Jan. 26, 2017~ Feb. 02, 2017	Aug. 29, 2017	Conduction (CO05-HY)
Hygrometer	Testo	608-H1	34913912	N/A	Apr. 19, 2016	Jan. 26, 2017~ Feb. 02, 2017	Apr. 18, 2017	Conduction (CO05-HY)
LISN	Rohde & Schwarz	ENV216	100080	9kHz~30MHz	Nov. 29, 2016	Jan. 26, 2017~ Feb. 02, 2017	Nov. 28, 2017	Conduction (CO05-HY)
LF Cable	HUBER + SUHNER	RG-214/U	LF01	N/A	Jan. 05, 2017	Jan. 26, 2017~ Feb. 02, 2017	Jan. 04, 2018	Conduction (CO05-HY)
Pulse Limiter	Rohde & Schwarz	ESH3-Z2	100851	N/A	Jan. 05, 2017	Jan. 26, 2017~ Feb. 02, 2017	Jan. 04, 2018	Conduction (CO05-HY)
Loop Antenna	Rohde & Schwarz	HFH2-Z2	100488	9 kHz~30 MHz	Oct. 20, 2016	Feb. 17, 2017~ Mar. 01, 2017	Oct. 19, 2018	Radiation (03CH12-HY)
Amplifier	SONOMA	310N	187312	9kHz~1GHz	Nov. 10, 2016	Feb. 17, 2017~ Mar. 01, 2017	Nov. 09, 2017	Radiation (03CH12-HY)
Spectrum Analyzer	Agilent	N9030A	MY52350276	3Hz~44GHz	Mar. 21, 2016	Feb. 17, 2017~ Mar. 01, 2017	Mar. 20, 2017	Radiation (03CH12-HY)
Bilog Antenna	TESEQ	CBL 6111D&00800 N1D01N-06	37059&01	30MHz~1GHz	Oct. 15, 2016	Feb. 17, 2017~ Mar. 01, 2017	Oct. 14, 2017	Radiation (03CH12-HY)
EMI Test Receiver	Rohde & Schwarz	ESU26	100390	20Hz~26.5GHz	Dec. 23, 2016	Feb. 17, 2017~ Mar. 01, 2017	Dec. 22, 2017	Radiation (03CH12-HY)
Preamplifier	MITEQ	JS44-1800400 0-33-8P	1840917	18GHz ~ 40GHz	Jun. 14, 2016	Feb. 17, 2017~ Mar. 01, 2017	Jun. 13, 2017	Radiation (03CH12-HY)
Horn Antenna	SCHWARZBECK	BBHA 9120D	9120D-1328	1GHz ~ 18GHz	Oct. 25, 2016	Feb. 17, 2017~ Mar. 01, 2017	Oct. 24, 2017	Radiation (03CH12-HY)
Hygrometer	TECPEL	DTM-303B	TP140349	N/A	Nov. 14, 2016	Feb. 17, 2017~ Mar. 01, 2017	Nov. 13, 2017	Radiation (03CH12-HY)
Preamplifier	MITEQ	AMF-7D-0010 1800-30-10P	1815698	1GHz~18GHz	Dec. 01, 2016	Feb. 17, 2017~ Mar. 01, 2017	Nov. 30, 2017	Radiation (03CH12-HY)
Preamplifier	Keysight	83017A	MY53270148	1GHz~26.5GHz	Jan. 12, 2017	Feb. 17, 2017~ Mar. 01, 2017	Jan. 11, 2018	Radiation (03CH12-HY)
RF Cable	HUBER + SUHNER	SUCOFLEX 104	MY24958/4, MY28653/4, MY9839/4PE	26GHz~40GHz	Jan. 10, 2017	Feb. 17, 2017~ Mar. 01, 2017	Jan. 09, 2018	Radiation (03CH12-HY)
RF Cable	HUBER + SUHNER	SUCOFLEX 104	MY24958/4, MY28653/4, MY9839/4PE	1GHz~26GHz	Jan. 10, 2017	Feb. 17, 2017~ Mar. 01, 2017	Jan. 09, 2018	Radiation (03CH12-HY)
RF Cable	HUBER + SUHNER	SUCOFLEX 104	MY24958/4, MY28653/4, MY9839/4PE	30MHz~1GHz	Jan. 10, 2017	Feb. 17, 2017~ Mar. 01, 2017	Jan. 09, 2018	Radiation (03CH12-HY)



RF Cable	HUBER + SUHNER	SUCOFLEX 104	MY24958/4, MY28653/4, MY9839/4PE	9K~30MHz	Jan. 10, 2017	Feb. 17, 2017~ Mar. 01, 2017	Jan. 09, 2018	Radiation (03CH12-HY)
Controller	EMEC	EM1000	N/A	Control Turn table & Ant Mast	N/A	Feb. 17, 2017~ Mar. 01, 2017	N/A	Radiation (03CH12-HY)
Antenna Mast	EMEC	AM-BS-4500-B	N/A	1m~4m	N/A	Feb. 17, 2017~ Mar. 01, 2017	N/A	Radiation (03CH12-HY)
Turn Table	EMEC	TT2000	N/A	0~360 Degree	N/A	Feb. 17, 2017~ Mar. 01, 2017	N/A	Radiation (03CH12-HY)
SHF-EHF Horn Antenna	SCHWARZBECK	BBHA 9170	BBHA9170576	18GHz ~ 40GHz	Apr. 15, 2016	Feb. 17, 2017~ Mar. 01, 2017	Apr. 14, 2017	Radiation (03CH12-HY)

NCR: No Calibration Required



5 Uncertainty of Evaluation

Uncertainty of Conducted Emission Measurement (150kHz ~ 30MHz)

Measuring Uncertainty for a Level of Confidence of 95% ($U = 2Uc(y)$)	2.7 dB
---	--------

Uncertainty of Radiated Emission Measurement (30 MHz ~ 1000 MHz)

Measuring Uncertainty for a Level of Confidence of 95% ($U = 2Uc(y)$)	5.1dB
---	-------

Uncertainty of Radiated Emission Measurement (1GHz ~ 18GHz)

Measuring Uncertainty for a Level of Confidence of 95% ($U = 2Uc(y)$)	5.2dB
---	-------

Uncertainty of Radiated Emission Measurement (18GHz ~ 40GHz)

Measuring Uncertainty for a Level of Confidence of 95% ($U = 2Uc(y)$)	4.7dB
---	-------



Appendix A. Conducted Test Results

Appendix A. Test Result of Conducted Test Items

Test Engineer:	Derek Hsu	Temperature:	21~25	°C
Test Date:	2017/2/23~2017/03/02	Relative Humidity:	51~54	%

TEST RESULTS DATA
6dB and 26dB EBW and 99% OBW

Band IV									
Mod.	Data Rate	NTX	CH.	Freq. (MHz)	99% Bandwidth (MHz)	26 dB Bandwidth (MHz)	6 dB Bandwidth (MHz)	6dB Bandwidth min. Limit (MHz)	Pass/Fail
11a	6M bps	1	149	5745	17.50	21.40	16.32	0.5	Pass
11a	6Mbps	1	157	5785	17.95	21.40	16.34	0.5	Pass
11a	6Mbps	1	165	5825	17.60	21.40	16.30	0.5	Pass
HT20	MCS 0	1	149	5745	18.50	21.90	17.52	0.5	Pass
HT20	MCS 0	1	157	5785	18.45	21.90	17.58	0.5	Pass
HT20	MCS 0	1	165	5825	18.50	21.70	17.58	0.5	Pass
HT40	MCS 0	1	151	5755	36.50	41.22	36.04	0.5	Pass
HT40	MCS 0	1	159	5795	36.50	41.13	36.28	0.5	Pass

TEST RESULTS DATA
Average Power Table

Band IV										
Mod.	Data Rate	NTX	CH.	Freq. (MHz)	Duty Factor (dB)	Average Conducted Power (dBm)	FCC Conducted Power Limit (dBm)	DG (dBi)		Pass/Fail
11a	6M bps	1	149	5745	0.12	7.84	30.00	-2.30		Pass
11a	6Mbps	1	157	5785	0.12	8.02	30.00	-2.30		Pass
11a	6Mbps	1	165	5825	0.12	7.95	30.00	-2.30		Pass
HT20	MCS 0	1	149	5745	0.13	7.82	30.00	-2.30		Pass
HT20	MCS 0	1	157	5785	0.13	8.14	30.00	-2.30		Pass
HT20	MCS 0	1	165	5825	0.13	8.04	30.00	-2.30		Pass
HT40	MCS 0	1	151	5755	0.23	8.28	30.00	-2.30		Pass
HT40	MCS 0	1	159	5795	0.23	8.27	30.00	-2.30		Pass

TEST RESULTS DATA
Power Spectral Density

Band IV										
Mod.	Data Rate	NTX	CH.	Freq. (MHz)	Duty Factor (dB)	10log (500kHz /RBW) Factor (dB)	Average Power Density (dBm/500kHz)	Average PSD Limit (dBm/500kHz)	DG (dBi)	Pass/Fail
11a	6M bps	1	149	5745	0.12	2.22	-6.46	30.00	-2.30	Pass
11a	6Mbps	1	157	5785	0.12	2.22	-6.61	30.00	-2.30	Pass
11a	6Mbps	1	165	5825	0.12	2.22	-6.70	30.00	-2.30	Pass
HT20	MCS 0	1	149	5745	0.13	2.22	-6.81	30.00	-2.30	Pass
HT20	MCS 0	1	157	5785	0.13	2.22	-6.83	30.00	-2.30	Pass
HT20	MCS 0	1	165	5825	0.13	2.22	-7.04	30.00	-2.30	Pass
HT40	MCS 0	1	151	5755	0.23	2.22	-9.53	30.00	-2.30	Pass
HT40	MCS 0	1	159	5795	0.23	2.22	-9.59	30.00	-2.30	Pass

TEST RESULTS DATA
Frequency Stability

Band IV										
Mod.	Data Rate	NTX	CH.	Freq. (MHz)	Center Frequency (MHz)	Frequency Deviation (MHz)	Frequency Stability (ppm)	Temperature (°C)	Voltage (V)	Note
11a	6M bps	1	149	5745	5745.000	0.000	0.00	55	3.85	
11a	6M bps	1	149	5745	5745.000	0.000	0.00	-30	3.85	
11a	6M bps	1	149	5745	5745.000	0.000	0.00	20	4.4	
11a	6M bps	1	149	5745	5745.000	0.000	0.00	20	3.5	
11a	6M bps	1	149	5745	5745.000	0.000	0.00	20	3.85	



Appendix B. Radiated Spurious Emission

Band 4 - 5725~5850MHz WIFI 802.11a (Band Edge @ 3m)

WIFI	Note	Frequency	Level	Over	Limit	Read	Antenna	Cable	Preamp	Ant	Table	Peak	Pol.
Ant.				Limit	Line	Level	Factor	Loss	Factor	Pos	Pos	Avg.	
1		(MHz)	(dBμV/m)	(dB)	(dBμV/m)	(dBμV)	(dB/m)	(dB)	(dB)	(cm)	(deg)	(P/A)	(H/V)
802.11a CH 149 5745MHz		5636.8	60.31	-7.89	68.2	46.74	32.78	11.79	31	102	57	P	H
		5677	60.01	-28.21	88.22	46.3	32.9	11.82	31.01	102	57	P	H
		5705.6	61.08	-45.69	106.77	47.28	32.98	11.84	31.02	102	57	P	H
		5720.6	61.48	-50.69	112.17	47.64	33.02	11.84	31.02	102	57	P	H
	*	5745	89.09	-	-	75.17	33.09	11.86	31.03	102	57	P	H
	*	5745	77.84	-	-	63.92	33.09	11.86	31.03	102	57	A	H
		5615.6	60.09	-8.11	68.2	46.59	32.72	11.77	30.99	350	110	P	V
		5684.4	60.38	-33.31	93.69	46.65	32.92	11.82	31.01	350	110	P	V
		5705	61.48	-45.12	106.6	47.69	32.97	11.84	31.02	350	110	P	V
		5723	60.46	-57.18	117.64	46.62	33.02	11.84	31.02	350	110	P	V
	*	5745	91.23	-	-	77.31	33.09	11.86	31.03	350	110	P	V
	*	5745	80.59	-	-	66.67	33.09	11.86	31.03	350	110	A	V
802.11a CH 157 5785MHz		5625	60.21	-7.99	68.2	46.66	32.75	11.79	30.99	118	59	P	H
		5679	59.95	-29.75	89.7	46.24	32.9	11.82	31.01	118	59	P	H
		5704.2	60.34	-46.04	106.38	46.54	32.97	11.84	31.01	118	59	P	H
		5723.6	59.29	-59.72	119.01	45.44	33.03	11.84	31.02	118	59	P	H
	*	5785	89.63	-	-	75.6	33.2	11.88	31.05	118	59	P	H
	*	5785	78.43	-	-	64.4	33.2	11.88	31.05	118	59	A	H
		5854.2	61.26	-51.36	112.62	46.9	33.39	12.03	31.06	118	59	P	H
		5872.4	60.57	-45.36	105.93	46.03	33.44	12.17	31.07	118	59	P	H
		5917.2	61.05	-12.9	73.95	46.26	33.57	12.31	31.09	118	59	P	H
		5933.4	61.42	-6.78	68.2	46.59	33.61	12.31	31.09	118	59	P	H
		5622.6	59.57	-8.63	68.2	46.03	32.74	11.79	30.99	339	109	P	V
		5662	59.49	-17.62	77.11	45.83	32.85	11.82	31.01	339	109	P	V
		5714.6	59.96	-49.33	109.29	46.14	33	11.84	31.02	339	109	P	V
		5721.2	59.75	-53.79	113.54	45.91	33.02	11.84	31.02	339	109	P	V
*	5785	91.14	-	-	77.11	33.2	11.88	31.05	339	109	P	V	



	*	5785	79.55	-	-	65.52	33.2	11.88	31.05	339	109	A	V
		5850.4	60.01	-61.28	121.29	45.66	33.38	12.03	31.06	339	109	P	V
		5865.8	60.77	-47	107.77	46.25	33.42	12.17	31.07	339	109	P	V
		5878.8	61.79	-40.59	102.38	47.23	33.46	12.17	31.07	339	109	P	V
		5946.6	61.25	-6.95	68.2	46.24	33.65	12.45	31.09	339	109	P	V
802.11a CH 165 5825MHz	*	5825	91.99	-	-	77.7	33.31	12.03	31.05	100	59	P	H
	*	5825	80.6	-	-	66.31	33.31	12.03	31.05	100	59	A	H
		5851.2	60.16	-59.3	119.46	45.81	33.38	12.03	31.06	100	59	P	H
		5862	60.54	-48.3	108.84	46.03	33.41	12.17	31.07	100	59	P	H
		5897.6	60.82	-27.62	88.44	46.22	33.51	12.17	31.08	100	59	P	H
		5933	62.48	-5.72	68.2	47.65	33.61	12.31	31.09	100	59	P	H
	*	5825	92.42	-	-	78.13	33.31	12.03	31.05	351	108	P	V
	*	5825	80.84	-	-	66.55	33.31	12.03	31.05	351	108	A	V
		5850.6	60.64	-60.19	120.83	46.29	33.38	12.03	31.06	351	108	P	V
		5874.6	60.89	-44.42	105.31	46.34	33.45	12.17	31.07	351	108	P	V
		5910.6	61.83	-16.99	78.82	47.06	33.55	12.31	31.09	351	108	P	V
	5943.8	62.07	-6.13	68.2	47.07	33.64	12.45	31.09	351	108	P	V	
Remark	1. No other spurious found. 2. All results are PASS against Peak and Average limit line.												



Band 4 5725~5850MHz

WIFI 802.11a (Harmonic @ 3m)

WIFI Ant. 1	Note	Frequency (MHz)	Level (dBμV/m)	Over Limit (dB)	Limit Line (dBμV/m)	Read Level (dBμV)	Antenna Factor (dB/m)	Cable Loss (dB)	Preamp Factor (dB)	Ant Pos (cm)	Table Pos (deg)	Peak Avg. (P/A)	Pol. (H/V)
802.11a CH 149 5745MHz		9192	47.86	-26.14	74	51.99	37.85	16.42	58.4	100	0	P	H
		11490	47.51	-26.49	74	46.48	40.2	18.4	57.57	100	0	P	H
		17235	63.97	-4.23	68.2	55.74	41.92	23.14	56.83	100	0	P	H
		9192	50.6	-23.4	74	54.73	37.85	16.42	58.4	100	0	P	V
		11490	50.6	-23.4	74	49.57	40.2	18.4	57.57	100	0	P	V
802.11a CH 157 5785MHz		11570	46.02	-27.98	74	45.07	40.06	18.49	57.6	100	0	P	H
		17355	57.68	-10.52	68.2	49.55	42.18	23.25	57.3	100	0	P	H
		11570	50.95	-23.05	74	50	40.06	18.49	57.6	100	0	P	V
		17355	57.19	-11.01	68.2	49.06	42.18	23.25	57.3	100	0	P	V
802.11a CH 165 5825MHz		9320	47.69	-26.31	74	51.45	38.29	16.35	58.4	100	0	P	H
		11650	46.73	-27.27	74	45.85	39.9	18.58	57.6	100	0	P	H
		17475	56.05	-12.15	68.2	48.02	42.44	23.36	57.77	100	0	P	H
		9320	50.84	-23.16	74	54.6	38.29	16.35	58.4	100	0	P	V
		11650	50.99	-23.01	74	50.11	39.9	18.58	57.6	100	0	P	V
		17475	56.71	-11.49	68.2	48.68	42.44	23.36	57.77	100	0	P	V
Remark	1. No other spurious found. 2. All results are PASS against Peak and Average limit line.												



Band 4 5725~5850MHz
WIFI 802.11n HT20 (Band Edge @ 3m)

WIFI Ant. 1	Note	Frequency (MHz)	Level (dBμV/m)	Over Limit (dB)	Limit Line (dBμV/m)	Read Level (dBμV)	Antenna Factor (dB/m)	Cable Loss (dB)	Preamp Factor (dB)	Ant Pos (cm)	Table Pos (deg)	Peak Avg. (P/A)	Pol. (H/V)
802.11n HT20 CH 149 5745MHz		5633.2	59.9	-8.3	68.2	46.34	32.77	11.79	31	125	59	P	H
		5678.4	60.69	-28.57	89.26	46.98	32.9	11.82	31.01	125	59	P	H
		5706.2	60	-46.94	106.94	46.2	32.98	11.84	31.02	125	59	P	H
		5723.6	60.24	-58.77	119.01	46.39	33.03	11.84	31.02	125	59	P	H
	*	5745	90.17	-	-	76.25	33.09	11.86	31.03	125	59	P	H
	*	5745	78.5	-	-	64.58	33.09	11.86	31.03	125	59	A	H
		5612.8	60.15	-8.05	68.2	46.65	32.72	11.77	30.99	339	107	P	V
		5653.8	60.13	-10.89	71.02	46.52	32.83	11.79	31.01	339	107	P	V
		5703.2	59.95	-46.15	106.1	46.15	32.97	11.84	31.01	339	107	P	V
		5725	60.58	-61.62	122.2	46.73	33.03	11.84	31.02	339	107	P	V
	*	5745	91.7	-	-	77.78	33.09	11.86	31.03	339	107	P	V
	*	5745	79.99	-	-	66.07	33.09	11.86	31.03	339	107	A	V
Remark	1. No other spurious found. 2. All results are PASS against Peak and Average limit line.												



WIFI Ant. 1	Note	Frequency (MHz)	Level (dBμV/m)	Over Limit (dB)	Limit Line (dBμV/m)	Read Level (dBμV)	Antenna Factor (dB/m)	Cable Loss (dB)	Preamp Factor (dB)	Ant Pos (cm)	Table Pos (deg)	Peak Avg. (P/A)	Pol. (H/V)
		5624	59.95	-8.25	68.2	46.4	32.75	11.79	30.99	132	59	P	H
		5678.2	60.42	-28.69	89.11	46.71	32.9	11.82	31.01	132	59	P	H
		5712.2	61.4	-47.22	108.62	47.59	32.99	11.84	31.02	132	59	P	H
		5721	59.45	-53.63	113.08	45.61	33.02	11.84	31.02	132	59	P	H
	*	5785	90.83	-	-	76.8	33.2	11.88	31.05	132	59	P	H
	*	5785	79.33	-	-	65.3	33.2	11.88	31.05	132	59	A	H
		5855	60.15	-50.65	110.8	45.79	33.39	12.03	31.06	132	59	P	H
		5874.6	61.34	-43.97	105.31	46.79	33.45	12.17	31.07	132	59	P	H
		5890.2	61.36	-32.56	93.92	46.78	33.49	12.17	31.08	132	59	P	H
		5938.2	62.01	-6.19	68.2	47.16	33.63	12.31	31.09	132	59	P	H
		5647.2	60.36	-7.84	68.2	46.76	32.81	11.79	31	352	108	P	V
		5696.4	60.35	-42.2	102.55	46.59	32.95	11.82	31.01	352	108	P	V
		5707.8	60.07	-47.32	107.39	46.27	32.98	11.84	31.02	352	108	P	V
		5723.2	60.2	-57.9	118.1	46.36	33.02	11.84	31.02	352	108	P	V
	*	5785	91.81	-	-	77.78	33.2	11.88	31.05	352	108	P	V
	*	5785	80.32	-	-	66.29	33.2	11.88	31.05	352	108	A	V
		5852	60.66	-56.98	117.64	46.3	33.39	12.03	31.06	352	108	P	V
		5857.4	60.86	-49.27	110.13	46.49	33.4	12.03	31.06	352	108	P	V
		5880.8	61.51	-39.38	100.89	46.94	33.47	12.17	31.07	352	108	P	V
		5937.8	61.28	-6.92	68.2	46.43	33.63	12.31	31.09	352	108	P	V
Remark	1. No other spurious found. 2. All results are PASS against Peak and Average limit line.												



WIFI Ant. 1	Note	Frequency (MHz)	Level (dBμV/m)	Over Limit (dB)	Limit Line (dBμV/m)	Read Level (dBμV)	Antenna Factor (dB/m)	Cable Loss (dB)	Preamp Factor (dB)	Ant Pos (cm)	Table Pos (deg)	Peak Avg. (P/A)	Pol. (H/V)
802.11n HT20 CH 165 5825MHz	*	5825	91.41	-	-	77.12	33.31	12.03	31.05	121	61	P	H
	*	5825	79.82	-	-	65.53	33.31	12.03	31.05	121	61	A	H
		5852.4	60.17	-56.56	116.73	45.81	33.39	12.03	31.06	121	61	P	H
		5865.2	60.45	-47.49	107.94	45.93	33.42	12.17	31.07	121	61	P	H
		5900	61.15	-25.51	86.66	46.54	33.52	12.17	31.08	121	61	P	H
		5942.8	60.88	-7.32	68.2	45.88	33.64	12.45	31.09	121	61	P	H
	*	5825	92.01	-	-	77.72	33.31	12.03	31.05	347	109	P	V
	*	5825	80.65	-	-	66.36	33.31	12.03	31.05	347	109	A	V
		5854.4	60	-52.17	112.17	45.64	33.39	12.03	31.06	347	109	P	V
		5873.6	61.62	-43.97	105.59	47.07	33.45	12.17	31.07	347	109	P	V
		5910.8	62.21	-16.47	78.68	47.44	33.55	12.31	31.09	347	109	P	V
		5949.4	61.36	-6.84	68.2	46.34	33.66	12.45	31.09	347	109	P	V
Remark	1. No other spurious found. 2. All results are PASS against Peak and Average limit line.												



Band 4 5725~5850MHz
WIFI 802.11n HT20 (Harmonic @ 3m)

WIFI Ant. 1	Note	Frequency (MHz)	Level (dBμV/m)	Over Limit (dB)	Limit Line (dBμV/m)	Read Level (dBμV)	Antenna Factor (dB/m)	Cable Loss (dB)	Preamp Factor (dB)	Ant Pos (cm)	Table Pos (deg)	Peak Avg. (P/A)	Pol. (H/V)
802.11n HT20 CH 149 5745MHz		9192	47.58	-26.42	74	51.71	37.85	16.42	58.4	100	0	P	H
		11490	46.73	-27.27	74	45.7	40.2	18.4	57.57	100	0	P	H
		17235	61.89	-6.31	68.2	53.66	41.92	23.14	56.83	100	0	P	H
		9192	50.97	-23.03	74	61.84	37.85	16.42	65.14	100	0	P	V
		11490	49.47	-24.53	74	48.44	40.2	18.4	57.57	100	0	P	V
		17235	60.68	-7.52	68.2	52.45	41.92	23.14	56.83	100	0	P	V
802.11n HT20 CH 157 5785MHz		11570	45.87	-28.13	74	44.92	40.06	18.49	57.6	100	0	P	H
		17355	59.73	-8.47	68.2	51.6	42.18	23.25	57.3	100	0	P	H
		11570	50.23	-23.77	74	49.28	40.06	18.49	57.6	100	0	P	V
		17355	57.26	-10.94	68.2	49.13	42.18	23.25	57.3	100	0	P	V
802.11n HT20 CH 165 5825MHz		9320	47.86	-26.14	74	51.62	38.29	16.35	58.4	100	0	P	H
		11650	47.13	-26.87	74	46.25	39.9	18.58	57.6	100	0	P	H
		17475	55.85	-12.35	68.2	47.82	42.44	23.36	57.77	100	0	P	H
		9320	50.09	-23.91	74	53.85	38.29	16.35	58.4	100	0	P	V
		11650	56.25	-17.75	74	63.11	39.9	18.58	65.34	196	15	P	V
		11650	42.11	-11.89	54	48.97	39.9	18.58	65.34	196	15	A	V
	17475	55.3	-12.9	68.2	47.27	42.44	23.36	57.77	100	0	P	V	
Remark	1. No other spurious found. 2. All results are PASS against Peak and Average limit line.												



Band 4 5725~5850MHz
WIFI 802.11n HT40 (Band Edge @ 3m)

WIFI Ant. 1	Note	Frequency (MHz)	Level (dBμV/m)	Over Limit (dB)	Limit Line (dBμV/m)	Read Level (dBμV)	Antenna Factor (dB/m)	Cable Loss (dB)	Preamp Factor (dB)	Ant Pos (cm)	Table Pos (deg)	Peak Avg. (P/A)	Pol. (H/V)
802.11n HT40 CH 151 5755MHz		5636.4	59.97	-8.23	68.2	46.4	32.78	11.79	31	114	59	P	H
		5653.8	60.1	-10.92	71.02	46.49	32.83	11.79	31.01	114	59	P	H
		5713.2	60.33	-48.57	108.9	46.51	33	11.84	31.02	114	59	P	H
		5721.6	60.8	-53.65	114.45	46.96	33.02	11.84	31.02	114	59	P	H
	*	5755	86.74	-	-	72.8	33.11	11.86	31.03	114	59	P	H
	*	5755	76.26	-	-	62.32	33.11	11.86	31.03	114	59	A	H
		5853.4	60.4	-54.05	114.45	46.04	33.39	12.03	31.06	114	59	P	H
		5866.2	60.23	-47.43	107.66	45.7	33.43	12.17	31.07	114	59	P	H
		5878.2	61.59	-41.23	102.82	47.03	33.46	12.17	31.07	114	59	P	H
		5949	61.31	-6.89	68.2	46.29	33.66	12.45	31.09	114	59	P	H
		5638.4	60.55	-7.65	68.2	46.97	32.79	11.79	31	355	107	P	V
		5682.8	60.48	-32.03	92.51	46.76	32.91	11.82	31.01	355	107	P	V
		5719.6	60.72	-49.97	110.69	46.89	33.01	11.84	31.02	355	107	P	V
		5723.2	61.69	-56.41	118.1	47.85	33.02	11.84	31.02	355	107	P	V
	*	5755	88.47	-	-	74.53	33.11	11.86	31.03	355	107	P	V
	*	5755	77.67	-	-	63.73	33.11	11.86	31.03	355	107	A	V
		5850.4	60.16	-61.13	121.29	45.81	33.38	12.03	31.06	355	107	P	V
		5864.4	60.51	-47.66	108.17	45.99	33.42	12.17	31.07	355	107	P	V
		5892.2	61.7	-30.74	92.44	47.11	33.5	12.17	31.08	355	107	P	V
	5939.4	61.29	-6.91	68.2	46.44	33.63	12.31	31.09	355	107	P	V	
802.11n HT40 CH 159 5795MHz		5621	60.34	-7.86	68.2	46.8	32.74	11.79	30.99	104	58	P	H
		5672	60.28	-24.24	84.52	46.59	32.88	11.82	31.01	104	58	P	H
		5713	60.17	-48.67	108.84	46.35	33	11.84	31.02	104	58	P	H
		5721.8	59.39	-55.51	114.9	45.55	33.02	11.84	31.02	104	58	P	H
	*	5795	88.1	-	-	74.04	33.23	11.88	31.05	104	58	P	H
	*	5795	76.88	-	-	62.82	33.23	11.88	31.05	104	58	A	H
		5850.2	60.35	-61.39	121.74	46	33.38	12.03	31.06	104	58	P	H
		5856.2	60.88	-49.58	110.46	46.51	33.4	12.03	31.06	104	58	P	H
		5924.4	61.43	-7.21	68.64	46.62	33.59	12.31	31.09	104	58	P	H
	5940.4	61.42	-6.78	68.2	46.43	33.63	12.45	31.09	104	58	P	H	



		5610.2	60.2	-8	68.2	46.71	32.71	11.77	30.99	333	111	P	V
		5671	60.14	-23.64	83.78	46.45	32.88	11.82	31.01	333	111	P	V
		5709.4	60.04	-47.79	107.83	46.23	32.99	11.84	31.02	333	111	P	V
		5721.4	59.81	-54.18	113.99	45.97	33.02	11.84	31.02	333	111	P	V
	*	5795	88.51	-	-	74.45	33.23	11.88	31.05	333	111	P	V
	*	5795	77.57	-	-	63.51	33.23	11.88	31.05	333	111	A	V
		5851.2	59.27	-60.19	119.46	44.92	33.38	12.03	31.06	333	111	P	V
		5860.2	61.1	-48.24	109.34	46.59	33.41	12.17	31.07	333	111	P	V
		5894	61.44	-29.66	91.1	46.85	33.5	12.17	31.08	333	111	P	V
		5945.8	61.57	-6.63	68.2	46.56	33.65	12.45	31.09	333	111	P	V

Remark	<ol style="list-style-type: none"> 1. No other spurious found. 2. All results are PASS against Peak and Average limit line.
---------------	---



Band 4 5725~5850MHz
WIFI 802.11n HT40 (Harmonic @ 3m)

WIFI Ant. 1	Note	Frequency (MHz)	Level (dBμV/m)	Over Limit (dB)	Limit Line (dBμV/m)	Read Level (dBμV)	Antenna Factor (dB/m)	Cable Loss (dB)	Preamp Factor (dB)	Ant Pos (cm)	Table Pos (deg)	Peak Avg. (P/A)	Pol. (H/V)
802.11n HT40 CH 151		11510	45.97	-28.03	74	44.94	40.18	18.45	57.6	100	0	P	H
		17265	57.02	-11.18	68.2	48.84	41.98	23.17	56.97	100	0	P	H
5755MHz		11510	48.85	-25.15	74	47.82	40.18	18.45	57.6	100	0	P	V
		17265	58.94	-9.26	68.2	50.76	41.98	23.17	56.97	100	0	P	V
802.11n HT40 CH 159		11590	45.77	-28.23	74	44.81	40.02	18.54	57.6	100	0	P	H
		17385	56.29	-11.91	68.2	48.18	42.25	23.29	57.43	100	0	P	H
5795MHz		11590	49.37	-24.63	74	48.41	40.02	18.54	57.6	100	0	P	V
		17385	55.71	-12.49	68.2	47.6	42.25	23.29	57.43	100	0	P	V
Remark	1. No other spurious found. 2. All results are PASS against Peak and Average limit line.												



Emission below 1GHz
5GHz WIFI 802.11a (LF @ 3m)

WIFI	Note	Frequency	Level	Over	Limit	Read	Antenna	Cable	Preamp	Ant	Table	Peak	Pol.
Ant.				Limit	Line	Level	Factor	Loss	Factor	Pos	Pos	Avg.	
1		(MHz)	(dBμV/m)	(dB)	(dBμV/m)	(dBμV)	(dB/m)	(dB)	(dB)	(cm)	(deg)	(P/A)	(H/V)
5GHz 802.11a LF		30	23.52	-16.48	40	29.4	25.8	0.78	32.46	-	-	P	H
		156.63	26.98	-16.52	43.5	40.5	17.15	1.75	32.42	-	-	P	H
		257.07	24.08	-21.92	46	35.36	19.2	1.83	32.31	-	-	P	H
		584.2	26.79	-19.21	46	30.58	25.11	3.5	32.4	-	-	P	H
		798.4	29.78	-16.22	46	30.05	27.79	4.14	32.2	-	-	P	H
		953.1	33.88	-12.12	46	29.98	30.25	4.75	31.1	100	0	P	H
		30.81	25.48	-14.52	40	31.9	25.26	0.78	32.46	-	-	P	V
		59.7	20.87	-19.13	40	40.74	11.8	0.78	32.45	-	-	P	V
		153.39	26.9	-16.6	43.5	40.22	17.35	1.75	32.42	-	-	P	V
		249.24	25.11	-20.89	46	37.18	18.42	1.83	32.32	-	-	P	V
		532.4	25.53	-20.47	46	30.42	24.32	3.19	32.4	-	-	P	V
		931.4	33.03	-12.97	46	29.95	29.78	4.6	31.3	100	0	P	V
Remark	1. No other spurious found. 2. All results are PASS against limit line.												



Note symbol

*	Fundamental Frequency which can be ignored. However, the level of any unwanted emissions shall not exceed the level of the fundamental frequency.
!	Test result is over limit line.
P/A	Peak or Average
H/V	Horizontal or Vertical



A calculation example for radiated spurious emission is shown as below:

WIFI	Note	Frequency	Level	Over	Limit	Read	Antenna	Cable	Preamp	Ant	Table	Peak	Pol.
Ant.				Limit	Line	Level	Factor	Loss	Factor	Pos	Pos	Avg.	
1		(MHz)	(dBμV/m)	(dB)	(dBμV/m)	(dBμV)	(dB/m)	(dB)	(dB)	(cm)	(deg)	(P/A)	(H/V)
802.11b		2390	55.45	-18.55	74	54.51	32.22	4.58	35.86	103	308	P	H
CH 01													
2412MHz		2390	43.54	-10.46	54	42.6	32.22	4.58	35.86	103	308	A	H

- Level(dBμV/m) =
Antenna Factor(dB/m) + Cable Loss(dB) + Read Level(dBμV) - Preamp Factor(dB)
- Over Limit(dB) = Level(dBμV/m) – Limit Line(dBμV/m)

For Peak Limit @ 2390MHz:

- Level(dBμV/m)
= Antenna Factor(dB/m) + Cable Loss(dB) + Read Level(dBμV) - Preamp Factor(dB)
= 32.22(dB/m) + 4.58(dB) + 54.51(dBμV) – 35.86 (dB)
= 55.45 (dBμV/m)
- Over Limit(dB)
= Level(dBμV/m) – Limit Line(dBμV/m)
= 55.45(dBμV/m) – 74(dBμV/m)
= -18.55(dB)

For Average Limit @ 2390MHz:

- Level(dBμV/m)
= Antenna Factor(dB/m) + Cable Loss(dB) + Read Level(dBμV) - Preamp Factor(dB)
= 32.22(dB/m) + 4.58(dB) + 42.6(dBμV) – 35.86 (dB)
= 43.54 (dBμV/m)
- Over Limit(dB)
= Level(dBμV/m) – Limit Line(dBμV/m)
= 43.54(dBμV/m) – 54(dBμV/m)
= -10.46(dB)

Both peak and average measured complies with the limit line, so test result is “PASS”.



Appendix C. Duty Cycle Plots

Band	Duty Cycle(%)	T(ms)	1/T(kHz)	VBW Setting
802.11a	97.22	1.400	0.714	1KHz
802.11n HT20	97.02	1.300	0.769	1KHz
802.11n HT40	94.74	0.648	1.543	3KHz

802.11a

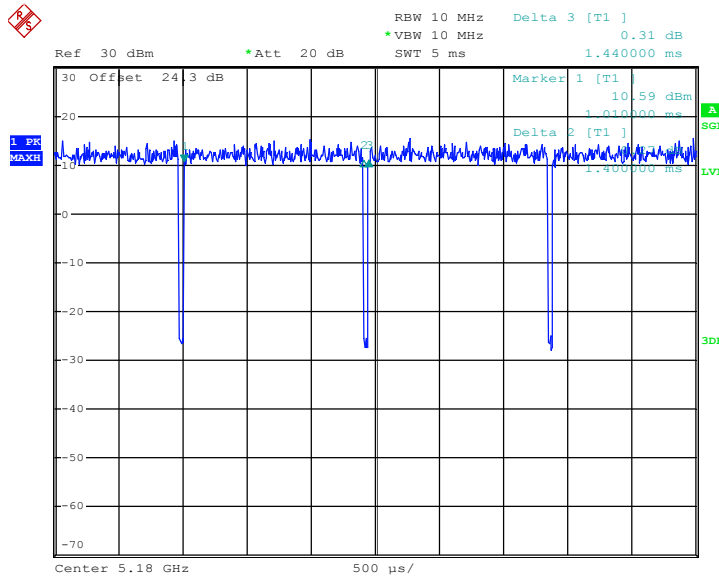

Date: 2.MAR.2017 21:09:48



802.11n HT20

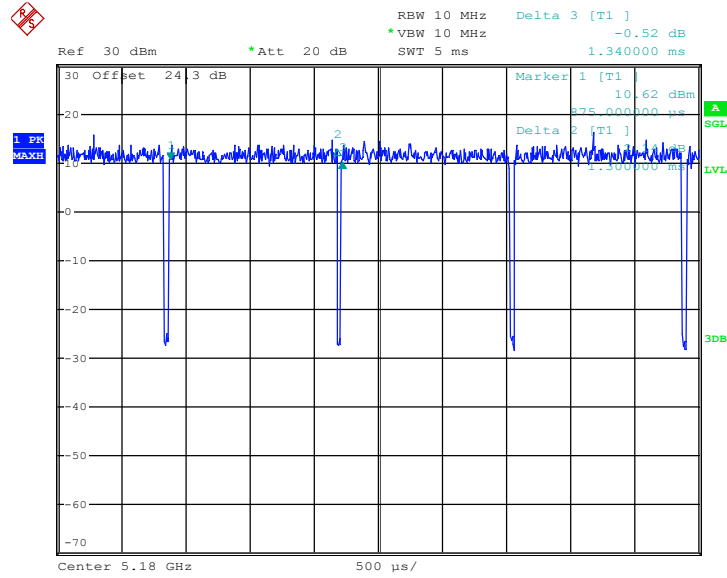

Date: 2.MAR.2017 21:38:12

802.11n HT40

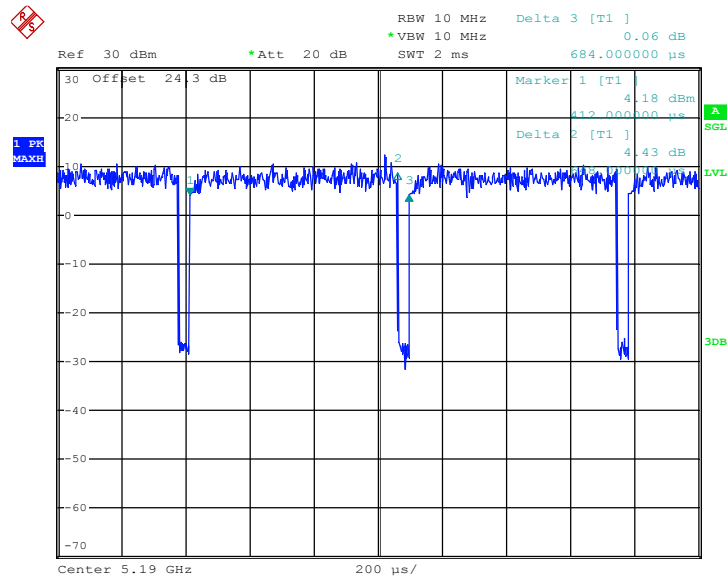

Date: 2.MAR.2017 21:48:49