



FCC RF Test Report

APPLICANT : HMD Global Oy
EQUIPMENT : Smart Phone
BRAND NAME : NOKIA
MODEL NAME : TA-1038
FCC ID : 2AJOTTA-1038
STANDARD : FCC Part 15 Subpart E §15.407
CLASSIFICATION : (NII) Unlicensed National Information Infrastructure

The product was received on Jan. 18, 2017 and testing was completed on Mar. 02, 2017. We, SPORTON INTERNATIONAL INC., would like to declare that the tested sample has been evaluated in accordance with the test procedures and has been in compliance with the applicable technical standards.

The test results in this report apply exclusively to the tested model / sample. Without written approval of SPORTON INTERNATIONAL INC., the test report shall not be reproduced except in full.

Reviewed by: Joseph Lin / Supervisor

Approved by: Jones Tsai / Manager



SPORTON INTERNATIONAL INC.

No. 52, Hwa Ya 1st Rd., Hwa Ya Technology Park, Kwei-Shan District, Tao Yuan City, Taiwan, R.O.C.



TABLE OF CONTENTS

REVISION HISTORY 3

SUMMARY OF TEST RESULT 4

1 GENERAL DESCRIPTION 5

 1.1 Applicant 5

 1.2 Manufacturer 5

 1.3 Feature of Equipment Under Test 5

 1.4 Product Specification of Equipment Under Test 6

 1.5 Modification of EUT 6

 1.6 Testing Location 7

 1.7 Applicable Standards 7

2 TEST CONFIGURATION OF EQUIPMENT UNDER TEST 8

 2.1 Carrier Frequency and Channel 8

 2.2 Test Mode 9

 2.3 Connection Diagram of Test System 11

 2.4 Support Unit used in test configuration and system 12

 2.5 EUT Operation Test Setup 12

 2.6 Measurement Results Explanation Example 12

3 TEST RESULT 13

 3.1 26dB & 99% Occupied Bandwidth Measurement 13

 3.2 Maximum Conducted Output Power Measurement 15

 3.3 Power Spectral Density Measurement 17

 3.4 Unwanted Emissions Measurement 20

 3.5 AC Conducted Emission Measurement 25

 3.6 Frequency Stability Measurement 29

 3.7 Automatically Discontinue Transmission 30

 3.8 Antenna Requirements 31

4 LIST OF MEASURING EQUIPMENT 32

5 UNCERTAINTY OF EVALUATION 34

APPENDIX A. CONDUCTED TEST RESULTS

APPENDIX B. RADIATED SPURIOUS EMISSION

APPENDIX C. DUTY CYCLE PLOTS

APPENDIX D. SETUP PHOTOGRAPHS



SUMMARY OF TEST RESULT

Report Section	FCC Rule	Description	Limit	Result	Remark
3.1	2.1049 15.403(i)	26dB & 99% Bandwidth	-	Pass	-
3.2	15.407(a)	Maximum Conducted Output Power	FCC ≤ 24 dBm (depend on band)	Pass	-
3.3	15.407(a)	Power Spectral Density	FCC ≤ 11 dBm/MHz (depend on band)	Pass	-
3.4	15.407(b)	Unwanted Emissions	≤ -17, -27 dBm (depend on band)&15.209(a)	Pass	Under limit 1.23 dB at 8416.000 MHz
3.5	15.207	AC Conducted Emission	15.207(a)	Pass	Under limit 13.4 dB at 13.558 MHz
3.6	15.407(g)	Frequency Stability	Within Operation Band	Pass	-
3.7	15.407(c)	Automatically Discontinue Transmission	Discontinue Transmission	Pass	-
3.8	15.203 & 15.407(a)	Antenna Requirement	N/A	Pass	-



1 General Description

1.1 Applicant

HMD Global Oy
Karaportti 2, 02610 Espoo, Finland

1.2 Manufacturer

HMD Global Oy
Karaportti 2, 02610 Espoo, Finland

1.3 Feature of Equipment Under Test

Product Feature	
Equipment	Smart Phone
Brand Name	NOKIA
Model Name	TA-1038
FCC ID	2AJOTTA-1038
EUT supports Radios application	GSM/GPRS/EGPRS/WCDMA/HSPA/DC-HSDPA/ HSPA+/LTE/NFC WLAN 2.4GHz 802.11b/g/n HT20/ WLAN 5GHz 802.11a/n HT20/HT40 Bluetooth v3.0 + EDR/ Bluetooth v 4.0 LE/ Bluetooth v4.1 LE / Bluetooth v4.2 LE
IMEI Code	Conducted: 356805080006838/356805080006820 Conduction: 356805080006838/356805080006820 Radiation: 356802080000358
HW Version	DVT1.5
SW Version	000C_1_26A
EUT Stage	Production Unit

Remark: The above EUT's information was declared by manufacturer. Please refer to the specifications or user's manual for more detailed description.



1.4 Product Specification of Equipment Under Test

Standards-related Product Specification	
Tx/Rx Frequency Range	5180 MHz ~ 5240 MHz 5260 MHz ~ 5320 MHz 5500 MHz ~ 5580 MHz and 5660 MHz ~ 5700 MHz
Maximum Output Power to Antenna	<5180 MHz ~ 5240 MHz> 802.11a : 8.62 dBm / 0.0073 W 802.11n HT20 : 8.53 dBm / 0.0071 W 802.11n HT40 : 8.73 dBm / 0.0075 W <5260 MHz ~ 5320 MHz> 802.11a : 8.72 dBm / 0.0074 W 802.11n HT20 : 8.64 dBm / 0.0073 W 802.11n HT40 : 8.74 dBm / 0.0075 W <5500 MHz ~ 5580 MHz and 5660 MHz ~ 5700 MHz> 802.11a : 8.82 dBm / 0.0076 W 802.11n HT20 : 8.88 dBm / 0.0077 W 802.11n HT40 : 8.87 dBm / 0.0077 W
99% Occupied Bandwidth	<5180 MHz ~ 5240 MHz> 802.11a : 17.75 MHz 802.11n HT20 : 18.55 MHz 802.11n HT40 : 36.60 MHz <5260 MHz ~ 5320 MHz> 802.11a : 17.70 MHz 802.11n HT20 : 18.50 MHz 802.11n HT40 : 36.70 MHz <5500 MHz ~ 5580 MHz and 5660 MHz ~ 5700 MHz> 802.11a : 17.80 MHz 802.11n HT20 : 18.50 MHz 802.11n HT40 : 36.60 MHz
Antenna Type / Gain	<5180 MHz ~ 5240 MHz> Loop Antenna with gain -2.10 dBi <5260 MHz ~ 5320 MHz> Loop Antenna with gain -2.10 dBi <5500 MHz ~ 5580 MHz and 5660 MHz ~ 5700 MHz> Loop Antenna with gain -2.30 dBi
Type of Modulation	802.11a/n : OFDM (BPSK / QPSK / 16QAM / 64QAM)

1.5 Modification of EUT

No modifications are made to the EUT during all test items.



1.6 Testing Location

Sporton Lab is accredited to ISO 17025 by Taiwan Accreditation Foundation (TAF code : 1190) and the FCC designation No. TW1022 under the FCC 2.948(e) by Mutual Recognition Agreement (MRA) in FCC Test.

Test Site	SPORTON INTERNATIONAL INC.		
Test Site Location	No. 52, Hwa Ya 1 st Rd., Hwa Ya Technology Park, Kwei-Shan District, Tao Yuan City, Taiwan, R.O.C. TEL: +886-3-327-3456 FAX: +886-3-328-4978		
Test Site No.	Sporton Site No.		
	TH05-HY	CO05-HY	03CH12-HY

Note: The test site complies with ANSI C63.4 2014 requirement.

1.7 Applicable Standards

According to the specifications of the manufacturer, the EUT must comply with the requirements of the following standards:

- ♦ FCC Part 15 Subpart E
- ♦ FCC KDB 789033 D02 General UNII Test Procedures New Rules v01r03
- ♦ ANSI C63.10-2013

Remark:

1. All test items were verified and recorded according to the standards and without any deviation during the test.
2. This EUT has also been tested and complied with the requirements of FCC Part 15, Subpart B, recorded in a separate test report.



2 Test Configuration of Equipment Under Test

The EUT has been associated with peripherals and configuration operated in a manner tended to maximize its emission characteristics in a typical application. Frequency range investigated: conducted emission (150 kHz to 30 MHz) and radiated emission (9 kHz to the 10th harmonic of the highest fundamental frequency or to 40 GHz, whichever is lower). For radiated measurement, pre-scanned in three orthogonal panels, X, Y, Z. The worst cases (Z plane) were recorded in this report.

2.1 Carrier Frequency and Channel

Frequency Band	Channel	Freq. (MHz)	Channel	Freq. (MHz)
5180-5240 MHz Band 1 (U-NII-1)	36	5180	44	5220
	38*	5190	46*	5230
	40	5200	48	5240
	-	-	-	-

Frequency Band	Channel	Freq. (MHz)	Channel	Freq. (MHz)
5260-5320 MHz Band 2 (U-NII-2A)	52	5260	60	5300
	54*	5270	62*	5310
	56	5280	64	5320
	-	-	-	-

Frequency Band	Channel	Freq. (MHz)	Channel	Freq. (MHz)
5500-5700 MHz Band 3 (U-NII-2C)	100	5500	112	5560
	102*	5510	116	5580
	104	5520	132	5660
	-	-	134*	5670
	108	5540	136	5680
	110*	5550	140	5700

Note: The above Frequency and Channel in "*" were 802.11n HT40.



2.2 Test Mode

Final test mode of conducted test items and radiated spurious emissions are considering the modulation and worse data rates from the power table described in section 2.2.

Modulation	Data Rate
802.11a	6 Mbps
802.11n HT20	MCS0
802.11n HT40	MCS0

Test Cases	
AC Conducted Emission	Mode 1 : WCDMA Band II Link + Bluetooth Link + WLAN Link(5G) + USB Cable (Charging from Adapter) + Earphone + Camera(Front) + SIM1
	Mode 2 : GSM850 Idle + Bluetooth Idle + WLAN Idle + USB Cable (Charging from Adapter) + Earphone + NFC On + SIM2
Remark: The worst case of conducted emission is mode 2; only the test data of it was reported.	

Ch. #		Band I : 5180-5240 MHz	Band II : 5260-5320 MHz	Band III : 5500 ~ 5580 MHz and 5660 ~ 5700 MHz
		802.11a	802.11a	802.11a
L	Low	36	52	100
M	Middle	44	60	116
H	High	48	64	140

Ch. #		Band I : 5180-5240 MHz	Band II : 5260-5320 MHz	Band III : 5500 ~ 5580 MHz and 5660 ~ 5700 MHz
		802.11n HT20	802.11n HT20	802.11n HT20
L	Low	36	52	100
M	Middle	44	60	116
H	High	48	64	140



Ch. #		Band I : 5150-5250 MHz	Band II : 5250-5350 MHz	Band III : 5500 ~ 5580 MHz and 5660 ~ 5700 MHz
		802.11n HT40	802.11n HT40	802.11n HT40
L	Low	38	54	102
M	Middle	-	-	110
H	High	46	62	134

2.3 Connection Diagram of Test System

<WLAN Tx Mode>

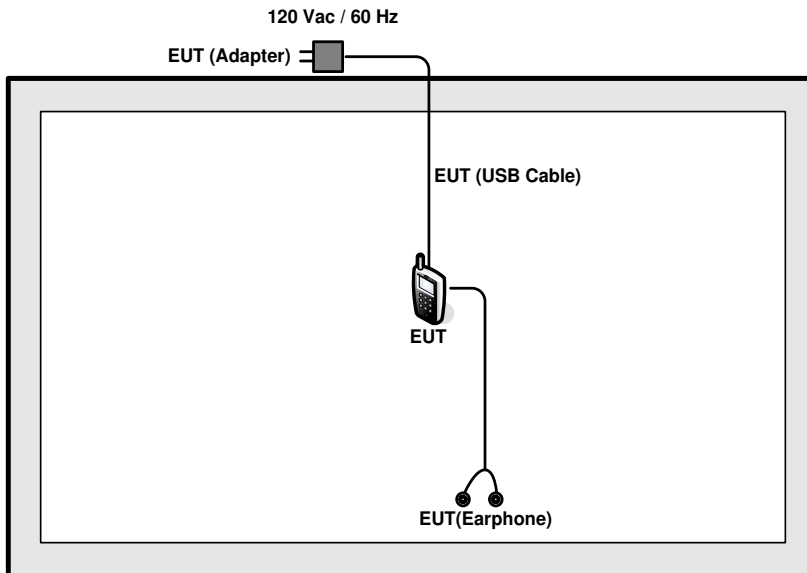

<AC Conducted Emission Mode>

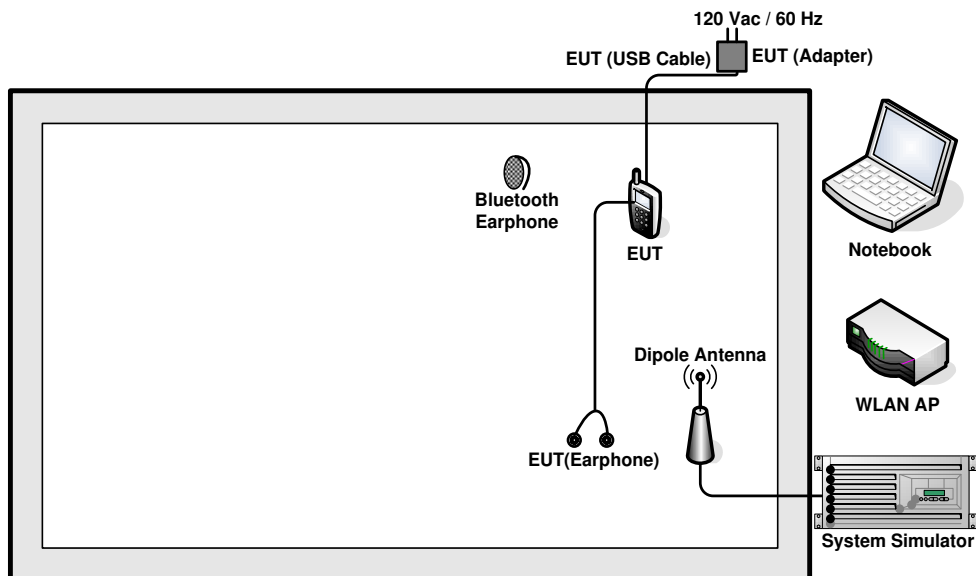



2.4 Support Unit used in test configuration and system

Item	Equipment	Trade Name	Model Name	FCC ID	Data Cable	Power Cord
1.	System Simulator	Anritsu	MT8820C	N/A	N/A	Unshielded, 1.8 m
2.	WLAN AP	ASUS	RT-AC66U	MSQ-RTAC66U	N/A	Unshielded,1.8m
3.	Notebook	Dell	Latitude E6320	FCC DoC	N/A	AC I/P: Unshielded, 1.2 m DC O/P: Shielded, 1.8 m
4.	Bluetooth Earphone	SonyEricsson	MW600	PY700A2029	N/A	N/A
5.	SD Card	SanDisk	MicroSD HC	FCC DoC	N/A	N/A

2.5 EUT Operation Test Setup

For WLAN RF test items, an engineering test program was provided and enabled to make EUT continuously transmit/receive.

For AC power line conducted emissions, the EUT was set to connect with the Notebook under large package sizes transmission.

2.6 Measurement Results Explanation Example

For all conducted test items:

The offset level is set in the spectrum analyzer to compensate the RF cable loss and attenuator factor between EUT conducted output port and spectrum analyzer. With the offset compensation, the spectrum analyzer reading level is exactly the EUT RF output level.

Example :

The spectrum analyzer offset is derived from RF cable loss and attenuator factor.

Offset = RF cable loss + attenuator factor.

Following shows an offset computation example with cable loss 0.3 dB and 24dB attenuator.

$$\begin{aligned}
\text{Offset(dB)} &= \text{RF cable loss(dB)} + \text{attenuator factor(dB)}. \\
&= 0.3 + 24 = 24.3 \text{ (dB)}
\end{aligned}$$

3 Test Result

3.1 26dB & 99% Occupied Bandwidth Measurement

3.1.1 Description of 26dB & 99% Occupied Bandwidth

This section is for reporting purpose only.

There is no restriction limits for bandwidth.

3.1.2 Measuring Instruments

The measuring equipment is listed in the section 4 of this test report.

3.1.3 Test Procedures

1. The testing follows FCC KDB 789033 D02 General UNII Test Procedures New Rules v01r03.
Section C) Emission bandwidth
2. Set RBW = approximately 1% of the emission bandwidth.
3. Set the VBW > RBW.
4. Detector = Peak.
5. Trace mode = max hold
6. Measure the maximum width of the emission that is 26 dB down from the peak of the emission.
Compare this with the RBW setting of the analyzer. Readjust RBW and repeat measurement as needed until the RBW/EBW ratio is approximately 1%.
7. For 99% Bandwidth Measurement, the spectrum analyzer's resolution bandwidth (RBW) is set 1MHz and set the Video bandwidth (VBW) $\geq 3 * RBW$.
8. Measure and record the results in the test report.

3.1.4 Test Setup

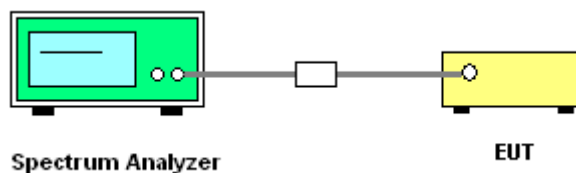



3.1.5 Test Result of 26dB & 99% Occupied Bandwidth

Please refer to Appendix A.

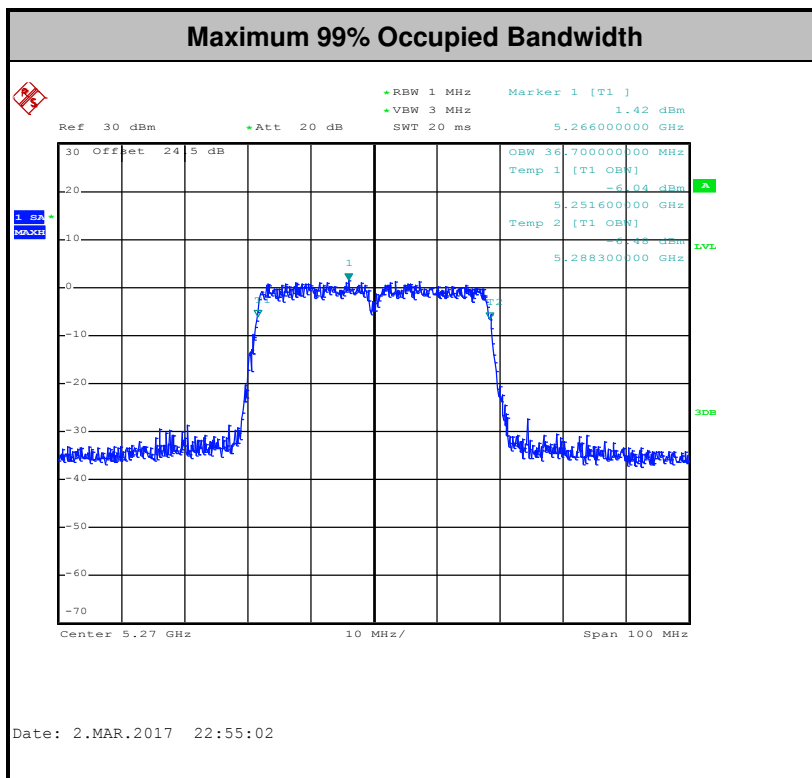
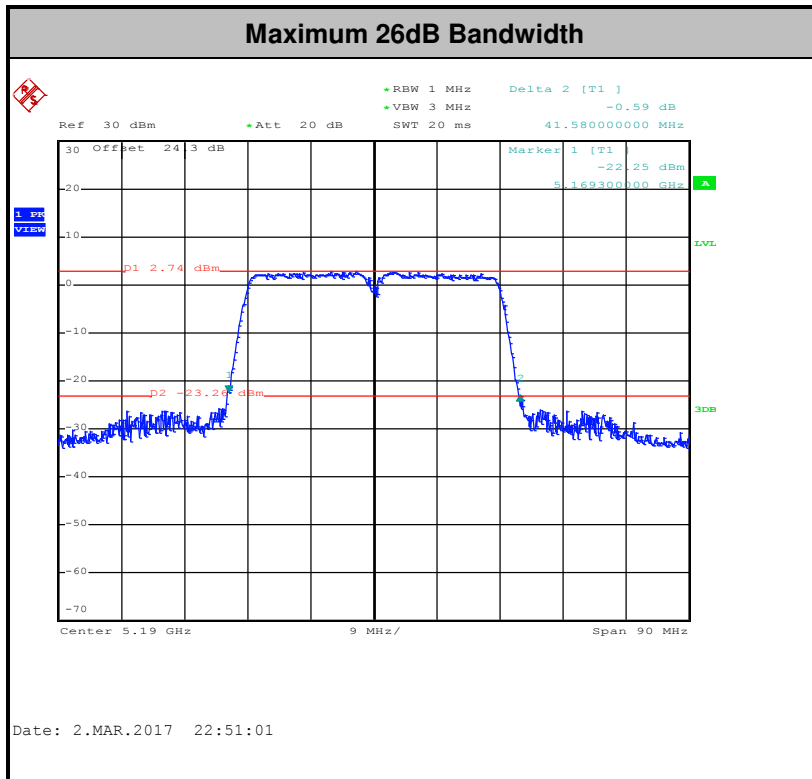

Note: The occupied channel bandwidth is maintained within the band of operation for all of the modulations.



3.2 Maximum Conducted Output Power Measurement

3.2.1 Limit of Maximum Conducted Output Power

<FCC 14-30 CFR 15.407>

For mobile and portable client devices in the 5.15–5.25 GHz band, the maximum conducted output power over the frequency band of operation shall not exceed 250 mW.

For the 5.25–5.725 GHz bands, the maximum conducted output power over the frequency bands of operation shall not exceed the lesser of 250 mW or $11 \text{ dBm} + 10 \log B$, where B is the 26 dB emission bandwidth in megahertz.

If transmitting antennas of directional gain greater than 6 dBi are used, the peak output power shall be reduced by the amount in dB that the directional gain of the antenna exceeds 6 dBi.

Note that U-NII-2 band, devices with a maximum e.i.r.p. greater than 500 mW shall implement TPC in order to have the capability to operate at least 6 dB below the maximum permitted e.i.r.p. of 1 W.

3.2.2 Measuring Instruments

The measuring equipment is listed in the section 4 of this test report.

3.2.3 Test Procedures

The testing follows Method PM of FCC KDB 789033 D02 General UNII Test Procedures New Rules v01r03.

Method PM (Measurement using an RF average power meter):

1. Measurement is performed using a wideband RF power meter.
2. The EUT is configured to transmit continuously with a consistent duty cycle at its maximum power control level.
3. Measure the average power of the transmitter, and the average power is corrected with duty factor, $10 \log(1/x)$, where x is the duty cycle.

3.2.4 Test Setup

For normal channel:

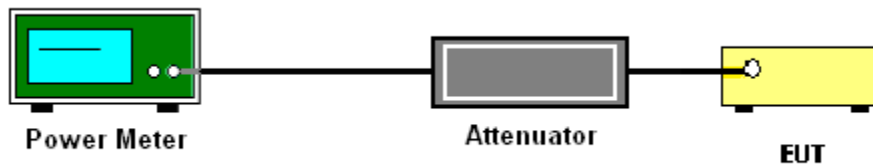

3.2.5 Test Result of Maximum Conducted Output Power

Please refer to Appendix A.



3.3 Power Spectral Density Measurement

3.3.1 Limit of Power Spectral Density

<FCC 14-30 CFR 15.407>

For mobile and portable client devices in the 5.15–5.25 GHz band, the maximum power spectral density shall not exceed 11dBm in any 1 megahertz band.

For the 5.25–5.725 GHz bands, the maximum power spectral density shall not exceed 11 dBm in any 1 megahertz band.

If transmitting antennas of directional gain greater than 6 dBi are used, the peak output power shall be reduced by the amount in dB that the directional gain of the antenna exceeds 6 dBi.

3.3.2 Measuring Instruments

The measuring equipment is listed in the section 4 of this test report.

3.3.3 Test Procedures

The testing follows FCC KDB 789033 D02 General UNII Test Procedures New Rules v01r03.
Section F) Maximum power spectral density.

Method SA-2

(trace averaging across on and off times of the EUT transmissions, followed by duty cycle correction).

1. The testing follows Method SA-2 of FCC KDB 789033 D02 General UNII Test Procedures New Rules v01r03.
 - Measure the duty cycle.
 - Set span to encompass the entire emission bandwidth (EBW) of the signal.
 - Set RBW = 1 MHz.
 - Set VBW \geq 3 MHz.
 - Number of points in sweep \geq 2 Span / RBW.
 - Sweep time = auto.
 - Detector = RMS
 - Trace average at least 100 traces in power averaging mode.
 - Add $10 \log(1/x)$, where x is the duty cycle, to the measured power in order to compute the average power during the actual transmission times. For example, add $10 \log(1/0.25) = 6$ dB if the duty cycle is 25 percent.
2. The RF output of EUT was connected to the spectrum analyzer by a low loss cable.
3. Each plot has already offset with cable loss, and attenuator loss. Measure the PPSD and record it.

3.3.4 Test Setup

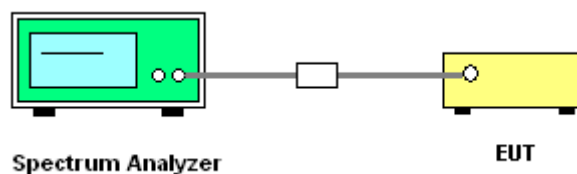



3.3.5 Test Result of Power Spectral Density

Please refer to Appendix A.

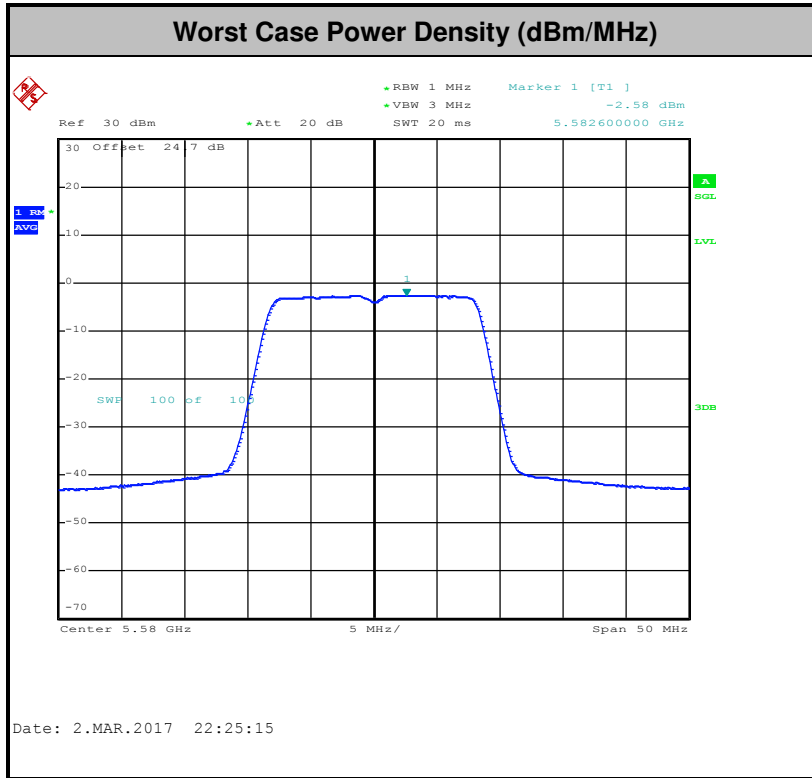

Note: Average Power Density (dB) = Measured value+ Duty Factor



3.4 Unwanted Emissions Measurement

This section as specified in FCC Part 15.407(b) is to measure unwanted emissions through radiated measurement for band edge spurious emissions and out of band emissions measurement. The unwanted emissions shall comply with 15.407(b)(1) to (6), and restricted bands per FCC Part15.205.

3.4.1 Limit of Unwanted Emissions

- (1) For transmitters operating in the 5150-5250 MHz band: all emissions outside of the 5150-5350 MHz band shall not exceed an EIRP of -27dBm/MHz.

For transmitters operating in the 5250-5350 MHz band: all emissions outside of the 5150-5350 MHz band shall not exceed an EIRP of -27 dBm/MHz. Devices operating in the 5250-5350 MHz band that generate emissions in the 5150-5250 MHz band must meet all applicable technical requirements for operation in the 5150-5250 MHz band (including indoor use) or alternatively meet an out-of-band emission EIRP limit of -27 dBm/MHz in the 5150-5250 MHz band.

For transmitters operating in the 5470-5725MHz band: all emissions outside of the 5470-5600 MHz and 5650-5725MHz band shall not exceed an EIRP of -27 dBm/MHz.

- (2) Unwanted spurious emissions fallen in restricted bands per FCC Part15.205 shall comply with the general field strength limits set forth in § 15.209 as below table,

Frequency (MHz)	Field Strength (microvolts/meter)	Measurement Distance (meters)
0.009 – 0.490	2400/F(kHz)	300
0.490 – 1.705	24000/F(kHz)	30
1.705 – 30.0	30	30
30 – 88	100	3
88 – 216	150	3
216 - 960	200	3
Above 960	500	3

Note: The following formula is used to convert the EIRP to field strength.

$$E = \frac{1000000\sqrt{30P}}{3} \mu\text{V/m, where P is the eirp (Watts)}$$



EIRP (dBm)	Field Strength at 3m (dBμV/m)
-17	78.3
- 27	68.3

(3) KDB789033 D02 v01r03 G)2)c) As specified in 15.407(b), emissions above 1000 MHz that are outside of the restricted bands are subject to a peak emission limit of -27 dBm/MHz (or -17 dBm/MHz as specified in 15.407(b)(4)). However, an out-of-band emission that complies with both the average and peak limits of 15.209 is not required to satisfy the -27 dBm/MHz or -17 dBm/MHz peak emission limit.

3.4.2 Measuring Instruments

The measuring equipment is listed in the section 4 of this test report.

3.4.3 Test Procedures

1. The testing follows FCC KDB 789033 D02 General UNII Test Procedures New Rules v01r03. Section G) Unwanted emissions measurement.

(1) Procedure for Unwanted Emissions Measurements Below 1000MHz

- RBW = 120 kHz
- VBW = 300 kHz
- Detector = Peak
- Trace mode = max hold

(2) Procedure for Peak Unwanted Emissions Measurements Above 1000 MHz

- RBW = 1 MHz
- VBW ≥ 3 MHz
- Detector = Peak
- Sweep time = auto
- Trace mode = max hold

(3) Procedures for Average Unwanted Emissions Measurements Above 1000MHz

- RBW = 1 MHz
- VBW = 10 Hz, when duty cycle is no less than 98 percent.
- VBW ≥ 1/T, when duty cycle is less than 98 percent where T is the minimum transmission duration over which the transmitter is on and is transmitting at its maximum power control level for the tested mode of operation.

2. The EUT was placed on a turntable with 0.8 meter for frequency below 1GHz and 1.5 meter for frequency above 1GHz respectively above ground.
3. The EUT was set 3 meters from the interference receiving antenna which was mounted on the top of a variable height antenna tower.
4. The antenna is a broadband antenna and its height is adjusted between one meter and four meters above ground to find the maximum value of the field strength for both horizontal polarization and vertical polarization of the antenna.
5. For each suspected emission, the EUT was arranged to its worst case and then adjust the antenna tower (from 1 m to 4 m) and turntable (from 0 degree to 360 degrees) to find the maximum reading.
6. For testing below 1GHz, if the emission level of the EUT in peak mode was 3 dB lower than the limit specified, then peak values of EUT will be reported, otherwise, the emissions will be repeated one by one using the CISPR quasi-peak method and reported.
7. For testing above 1GHz, the emission level of the EUT in peak mode was 20dB lower than average limit (that means the emission level in average mode also complies with the limit in average mode), then peak values of EUT will be reported, otherwise, the emissions will be measured in average mode again and reported.

3.4.4 Test Setup

For radiated emissions below 30MHz

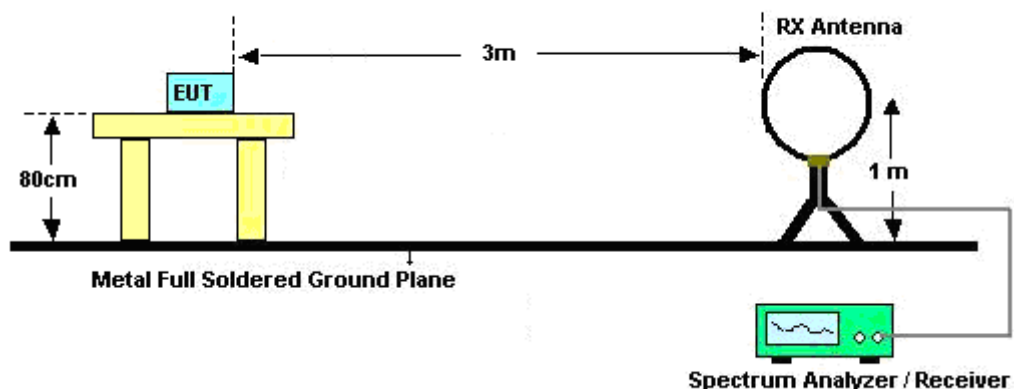

For radiated emissions from 30MHz to 1GHz

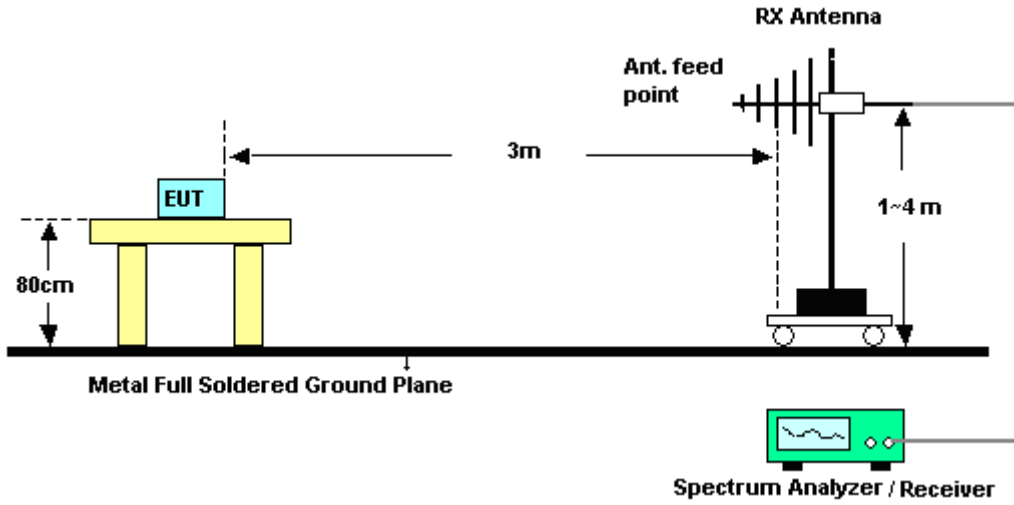

For radiated emissions above 1GHz

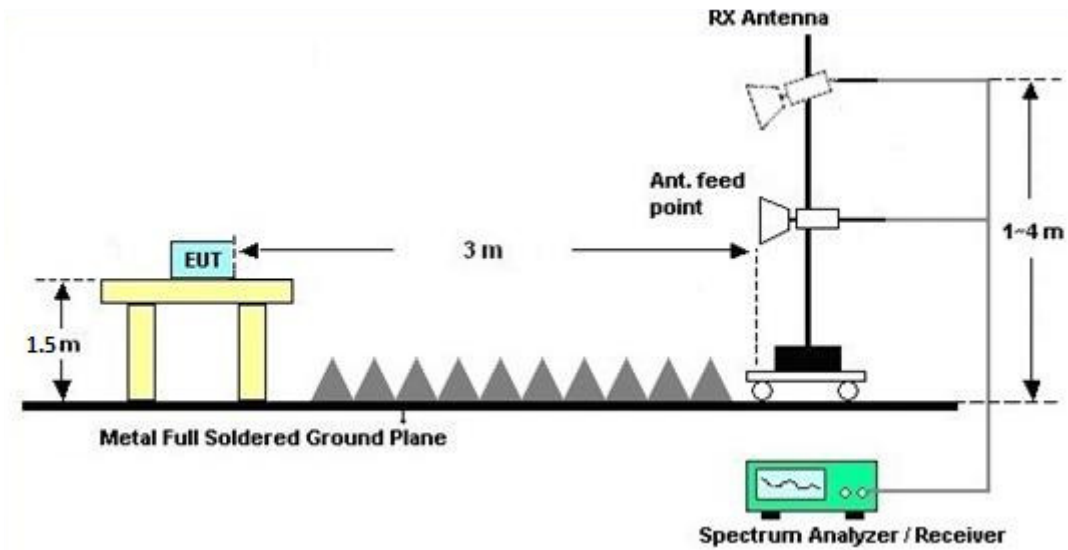



3.4.5 Test Results of Radiated Spurious Emissions (9 kHz ~ 30 MHz)

The low frequency, which started from 9 kHz to 30MHz, was pre-scanned and the result which was 20dB lower than the limit line per 15.31(o) was not reported.

3.4.6 Test Result of Radiated Spurious at Band Edges

Please refer to Appendix B.

3.4.7 Duty Cycle

Please refer to Appendix C.

3.4.8 Test Result of Radiated Spurious Emissions (30MHz ~ 10th Harmonic)

Please refer to Appendix B.



3.5 AC Conducted Emission Measurement

3.5.1 Limit of AC Conducted Emission

For equipment that is designed to be connected to the public utility (AC) power line, the radio frequency voltage that is conducted back onto the AC power line on any frequency or frequencies within the band 150 kHz to 30 MHz shall not exceed the limits in the following table.

Frequency of emission (MHz)	Conducted limit (dB μ V)	
	Quasi-peak	Average
0.15-0.5	66 to 56*	56 to 46*
0.5-5	56	46
5-30	60	50

*Decreases with the logarithm of the frequency.

3.5.2 Measuring Instruments

The measuring equipment is listed in the section 4 of this test report.

3.5.3 Test Procedures

1. The EUT was placed 0.4 meter from the conducting wall of the shielding room was kept at least 80 centimeters from any other grounded conducting surface.
2. Connect EUT to the power mains through a line impedance stabilization network (LISN).
3. All the support units are connecting to the other LISN.
4. The LISN provides 50 ohm coupling impedance for the measuring instrument.
5. The FCC states that a 50 ohm, 50 microhenry LISN should be used.
6. Both sides of AC line were checked for maximum conducted interference.
7. The frequency range from 150 kHz to 30 MHz was searched.
8. Set the test-receiver system to Peak Detect Function and specified bandwidth with Maximum Hold Mode.

3.5.4 Test Setup

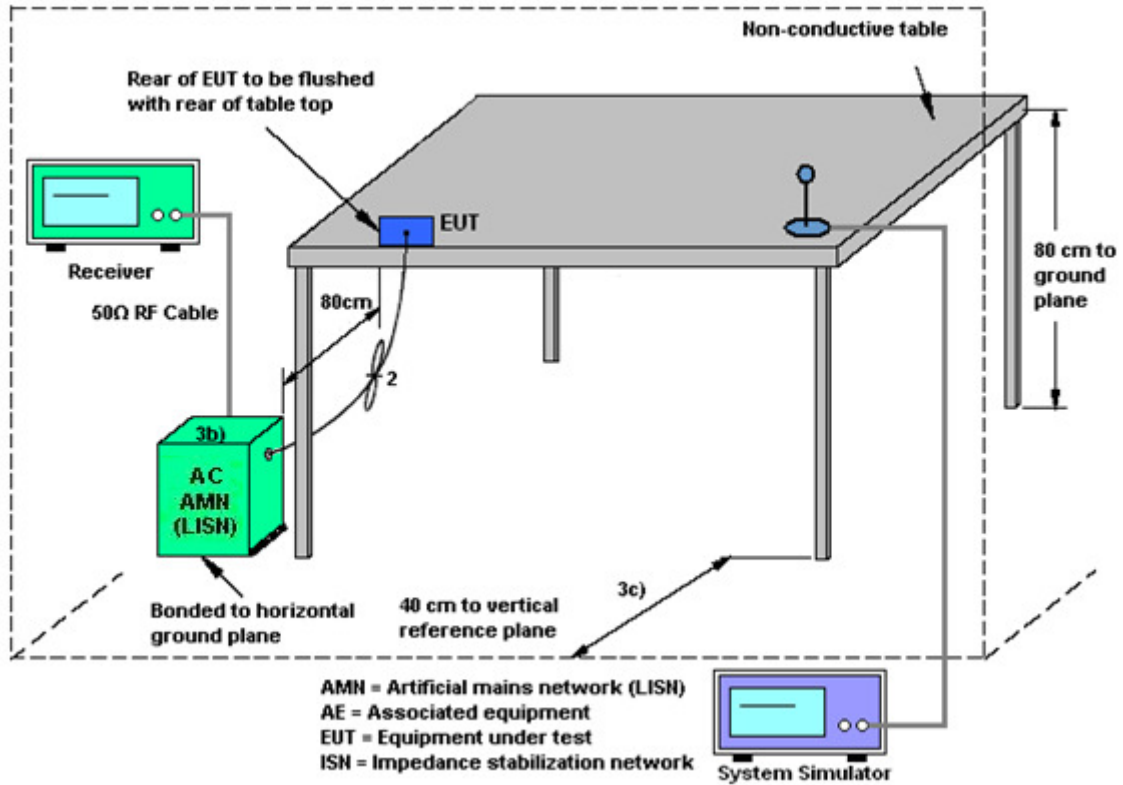



3.5.5 Test Result of AC Conducted Emission

Test Mode :	Mode 2	Temperature :	22~24°C
Test Engineer :	Kaichun Chu and Arthur Hsieh	Relative Humidity :	51~53%
Test Voltage :	120Vac / 60Hz	Phase :	Line
Function Type :	GSM850 Idle + Bluetooth Idle + WLAN Idle + USB Cable (Charging from Adapter) + Earphone + NFC On + SIM2		

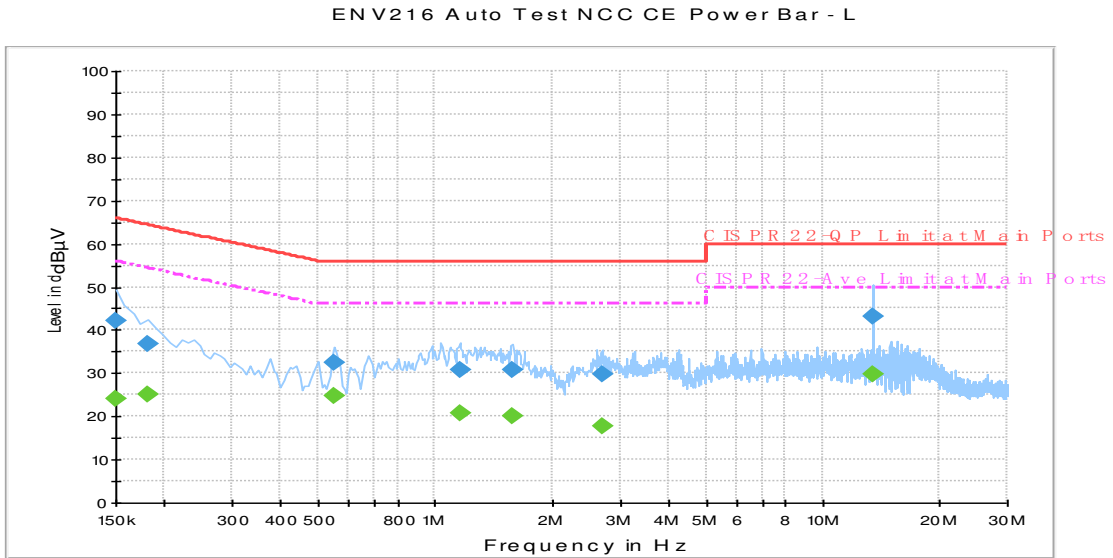

Final Result : QuasiPeak

Frequency (MHz)	QuasiPeak (dBµV)	Filter	Line	Corr. (dB)	Margin (dB)	Limit (dBµV)
0.150000	42.3	Off	L1	19.6	23.7	66.0
0.182000	36.7	Off	L1	19.6	27.7	64.4
0.550000	32.5	Off	L1	19.6	23.5	56.0
1.158000	30.9	Off	L1	19.6	25.1	56.0
1.582000	30.6	Off	L1	19.6	25.4	56.0
2.694000	29.9	Off	L1	19.3	26.1	56.0
13.558000	43.3	Off	L1	20.1	16.7	60.0

Final Result : Average

Frequency (MHz)	Average (dBµV)	Filter	Line	Corr. (dB)	Margin (dB)	Limit (dBµV)
0.150000	24.1	Off	L1	19.6	31.9	56.0
0.182000	25.0	Off	L1	19.6	29.4	54.4
0.550000	24.6	Off	L1	19.6	21.4	46.0
1.158000	20.9	Off	L1	19.6	25.1	46.0
1.582000	20.1	Off	L1	19.6	25.9	46.0
2.694000	17.6	Off	L1	19.3	28.4	46.0
13.558000	29.7	Off	L1	20.1	20.3	50.0



Test Mode :	Mode 2	Temperature :	22~24°C
Test Engineer :	Kaichun Chu and Arthur Hsieh	Relative Humidity :	51~53%
Test Voltage :	120Vac / 60Hz	Phase :	Neutral
Function Type :	GSM850 Idle + Bluetooth Idle + WLAN Idle + USB Cable (Charging from Adapter) + Earphone + NFC On + SIM2		

ENV216 Auto Test NCC CE Power Bar - N

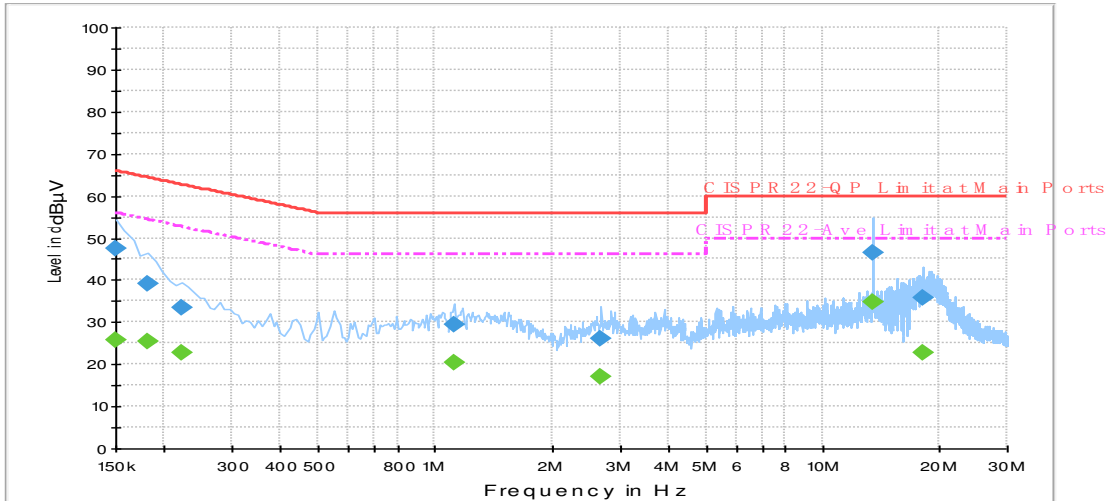

Final Result : QuasiPeak

Frequency (MHz)	QuasiPeak (dBµV)	Filter	Line	Corr. (dB)	Margin (dB)	Limit (dBµV)
0.150000	47.6	Off	N	19.6	18.4	66.0
0.182000	39.0	Off	N	19.5	25.4	64.4
0.222000	33.5	Off	N	19.5	29.2	62.7
1.118000	29.3	Off	N	19.6	26.7	56.0
2.686000	26.0	Off	N	19.4	30.0	56.0
13.558000	46.6	Off	N	20.2	13.4	60.0
18.158000	35.8	Off	N	20.4	24.2	60.0

Final Result : Average

Frequency (MHz)	Average (dBµV)	Filter	Line	Corr. (dB)	Margin (dB)	Limit (dBµV)
0.150000	25.7	Off	N	19.6	30.3	56.0
0.182000	25.6	Off	N	19.5	28.8	54.4
0.222000	22.7	Off	N	19.5	30.0	52.7
1.118000	20.4	Off	N	19.6	25.6	46.0
2.686000	16.9	Off	N	19.4	29.1	46.0
13.558000	34.8	Off	N	20.2	15.2	50.0
18.158000	22.6	Off	N	20.4	27.4	50.0

3.6 Frequency Stability Measurement

3.6.1 Limit of Frequency Stability

Manufacturers of U-NII devices are responsible for ensuring frequency stability such that an emission is maintained within the band of operation under all conditions of normal operation as specified in the user's manual.

3.6.2 Measuring Instruments

The measuring equipment is listed in the section 4 of this test report.

3.6.3 Test Procedures

1. To ensure emission at the band edge is maintained within the authorized band, those values shall be measured by radiation emissions at upper and lower frequency points, and finally compensated by frequency deviation as procedures below.
2. The EUT was operated at the maximum output power, and connected to the spectrum analyzer, which is set to maximum hold function and peak detector. The peak value of the power envelope was measured and noted. The upper and lower frequency points were respectively measured relatively 10dB lower than the measured peak value.
3. The frequency deviation was calculated by adding the upper frequency point and the lower frequency point divided by two. Those detailed values of frequency deviation are provided in table below.

3.6.4 Test Setup

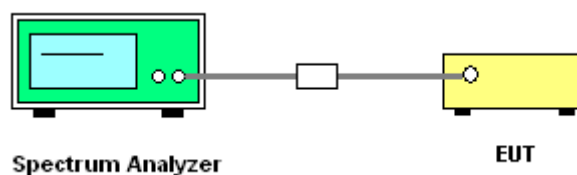

3.6.5 Test Result of Frequency Stability

Please refer to Appendix A.



3.7 Automatically Discontinue Transmission

3.7.1 Limit of Automatically Discontinue Transmission

The device shall automatically discontinue transmission in case of either absence of information to transmit or operational failure. These provisions are not intended to preclude the transmission of control or signaling information or the use of repetitive codes used by certain digital technologies to complete frame or burst intervals. Applicants shall include in their application for equipment authorization to describe how this requirement is met.

3.7.2 Measuring Instruments

The measuring equipment is listed in the section 4 of this test report.

3.7.3 Test Result of Automatically Discontinue Transmission

While the EUT is not transmitting any information, the EUT can automatically discontinue transmission and become standby mode for power saving. The EUT can detect the controlling signal of ACK message transmitting from remote device and verify whether it shall resend or discontinue transmission.



3.8 Antenna Requirements

3.8.1 Standard Applicable

According to FCC 47 CFR Section 15.407(a)(1)(2), if transmitting antenna directional gain is greater than 6 dBi, both the peak transmit power and the peak power spectral density shall be reduced by the amount in dB that the directional gain of the antenna exceeds 6 dBi.

3.8.2 Antenna Anti-Replacement Construction

An embedded-in antenna design is used.

3.8.3 Antenna Gain

The antenna gain is less than 6 dBi. Therefore, it is not necessary to reduce maximum peak output power limit.



4 List of Measuring Equipment

Instrument	Manufacturer	Model No.	Serial No.	Characteristics	Calibration Date	Test Date	Due Date	Remark
Hygrometer	Testo	608-H2	41410069	N/A	Aug. 28, 2016	Feb. 23, 2017~ Mar. 02, 2017	Aug. 27, 2017	Conducted (TH05-HY)
Power Meter	Anritsu	ML2495A	0932001	300MHz~40GHz	Sep. 29, 2016	Feb. 23, 2017~ Mar. 02, 2017	Sep. 28, 2017	Conducted (TH05-HY)
Power Sensor	Anritsu	MA2411B	0846202	300MHz~40GHz	Sep. 29, 2016	Feb. 23, 2017~ Mar. 02, 2017	Sep. 28, 2017	Conducted (TH05-HY)
Spectrum Analyzer	Rohde & Schwarz	FSP40	100055	9kHz-40GHz	Jul. 17, 2016	Feb. 23, 2017~ Mar. 02, 2017	Jul. 16, 2017	Conducted (TH05-HY)
Temperature Chamber	ESPEC	SH-641	92013720	-40℃ ~90℃	Sep. 01, 2016	Feb. 23, 2017~ Mar. 02, 2017	Aug. 31, 2017	Conducted (TH05-HY)
Programmable Power Supply	GW Instek	PSS-2005	EL890094	1V~20V 0.5A~5A	Oct. 11, 2016	Feb. 23, 2017~ Mar. 02, 2017	Oct. 10, 2017	Conducted (TH05-HY)
AC Power Source	ChainTek	APC-1000W	N/A	N/A	N/A	Jan. 26, 2017~ Feb. 02, 2017	N/A	Conduction (CO05-HY)
EMI Test Receiver	Rohde & Schwarz	ESCI 7	100724	9kHz~7GHz	Aug. 30, 2016	Jan. 26, 2017~ Feb. 02, 2017	Aug. 29, 2017	Conduction (CO05-HY)
Hygrometer	Testo	608-H1	34913912	N/A	Apr. 19, 2016	Jan. 26, 2017~ Feb. 02, 2017	Apr. 18, 2017	Conduction (CO05-HY)
LISN	Rohde & Schwarz	ENV216	100080	9kHz~30MHz	Nov. 29, 2016	Jan. 26, 2017~ Feb. 02, 2017	Nov. 28, 2017	Conduction (CO05-HY)
LF Cable	HUBER + SUHNER	RG-214/U	LF01	N/A	Jan. 05, 2017	Jan. 26, 2017~ Feb. 02, 2017	Jan. 04, 2018	Conduction (CO05-HY)
Pulse Limiter	Rohde & Schwarz	ESH3-Z2	100851	N/A	Jan. 05, 2017	Jan. 26, 2017~ Feb. 02, 2017	Jan. 04, 2018	Conduction (CO05-HY)
Loop Antenna	Rohde & Schwarz	HFH2-Z2	100488	9 kHz~30 MHz	Oct. 20, 2016	Feb. 17, 2017~ Mar. 01, 2017	Oct. 19, 2017	Radiation (03CH12-HY)
Amplifier	SONOMA	310N	187312	9kHz~1GHz	Nov. 10, 2016	Feb. 17, 2017~ Mar. 01, 2017	Nov. 09, 2017	Radiation (03CH12-HY)
Spectrum Analyzer	Agilent	N9030A	MY52350276	3Hz~44GHz	Mar. 21, 2016	Feb. 17, 2017~ Mar. 01, 2017	Mar. 20, 2017	Radiation (03CH12-HY)
Bilog Antenna	TESEQ	CBL 6111D&00800 N1D01N-06	37059&01	30MHz~1GHz	Oct. 15, 2016	Feb. 17, 2017~ Mar. 01, 2017	Oct. 14, 2017	Radiation (03CH12-HY)
EMI Test Receiver	Rohde & Schwarz	ESU26	100390	20Hz~26.5GHz	Dec. 23, 2016	Feb. 17, 2017~ Mar. 01, 2017	Dec. 22, 2017	Radiation (03CH12-HY)
Preamplifier	MITEQ	JS44-1800400 0-33-8P	1840917	18GHz ~ 40GHz	Jun. 14, 2016	Feb. 17, 2017~ Mar. 01, 2017	Jun. 13, 2017	Radiation (03CH12-HY)
Horn Antenna	SCHWARZBECK	BBHA 9120D	9120D-1328	1GHz ~ 18GHz	Oct. 25, 2016	Feb. 17, 2017~ Mar. 01, 2017	Oct. 24, 2017	Radiation (03CH12-HY)
Hygrometer	TECPEL	DTM-303B	TP140349	N/A	Nov. 14, 2016	Feb. 17, 2017~ Mar. 01, 2017	Nov. 13, 2017	Radiation (03CH12-HY)
Preamplifier	MITEQ	AMF-7D-0010 1800-30-10P	1815698	1GHz~18GHz	Dec. 01, 2016	Feb. 17, 2017~ Mar. 01, 2017	Nov. 30, 2017	Radiation (03CH12-HY)
Preamplifier	Keysight	83017A	MY53270148	1GHz~26.5GHz	Jan. 12, 2017	Feb. 17, 2017~ Mar. 01, 2017	Jan. 11, 2018	Radiation (03CH12-HY)
RF Cable	HUBER + SUHNER	SUCOFLEX 104	MY24958/4, MY28653/4, MY9839/4PE	26GHz~40GHz	Jan. 10, 2017	Feb. 17, 2017~ Mar. 01, 2017	Jan. 09, 2018	Radiation (03CH12-HY)
RF Cable	HUBER + SUHNER	SUCOFLEX 104	MY24958/4, MY28653/4, MY9839/4PE	1GHz~26GHz	Jan. 10, 2017	Feb. 17, 2017~ Mar. 01, 2017	Jan. 09, 2018	Radiation (03CH12-HY)
RF Cable	HUBER + SUHNER	SUCOFLEX 104	MY24958/4, MY28653/4, MY9839/4PE	30MHz~1GHz	Jan. 10, 2017	Feb. 17, 2017~ Mar. 01, 2017	Jan. 09, 2018	Radiation (03CH12-HY)



RF Cable	HUBER + SUHNER	SUCOFLEX 104	MY24958/4, MY28653/4, MY9839/4PE	9K~30MHz	Jan. 10, 2017	Feb. 17, 2017~ Mar. 01, 2017	Jan. 09, 2018	Radiation (03CH12-HY)
Controller	E MEC	EM1000	N/A	Control Turn table & Ant Mast	N/A	Feb. 17, 2017~ Mar. 01, 2017	N/A	Radiation (03CH12-HY)
Antenna Mast	E MEC	AM-BS-4500-B	N/A	1m~4m	N/A	Feb. 17, 2017~ Mar. 01, 2017	N/A	Radiation (03CH12-HY)
Turn Table	E MEC	TT2000	N/A	0~360 Degree	N/A	Feb. 17, 2017~ Mar. 01, 2017	N/A	Radiation (03CH12-HY)
SHF-EHF Horn Antenna	SCHWARZBECK	BBHA 9170	BBHA9170576	18GHz ~ 40GHz	Apr. 15, 2016	Feb. 17, 2017~ Mar. 01, 2017	Apr. 14, 2017	Radiation (03CH12-HY)

NCR: No Calibration Required



5 Uncertainty of Evaluation

Uncertainty of Conducted Emission Measurement (150kHz ~ 30MHz)

Measuring Uncertainty for a Level of Confidence of 95% ($U = 2Uc(y)$)	2.7 dB
---	--------

Uncertainty of Radiated Emission Measurement (30 MHz ~ 1000 MHz)

Measuring Uncertainty for a Level of Confidence of 95% ($U = 2Uc(y)$)	5.1dB
---	-------

Uncertainty of Radiated Emission Measurement (1GHz ~ 18GHz)

Measuring Uncertainty for a Level of Confidence of 95% ($U = 2Uc(y)$)	5.2dB
---	-------

Uncertainty of Radiated Emission Measurement (18GHz ~ 40GHz)

Measuring Uncertainty for a Level of Confidence of 95% ($U = 2Uc(y)$)	4.7dB
---	-------



Appendix A. Conducted Test Results

Appendix A. Test Result of Conducted Test Items

Test Engineer:	Derek Hsu	Temperature:	21~25	°C
Test Date:	2017/2/23~2017/3/2	Relative Humidity:	51~54	%

TEST RESULTS DATA
26dB and 99% OBW

Band I										
Mod.	Data Rate	NTX	CH.	Freq. (MHz)	99% Bandwidth (MHz)	26 dB Bandwidth (MHz)	IC 99% Bandwidth Power Limit (dBm)	IC 99% Bandwidth EIRP Limit (dBm)		
11a	6Mbps	1	36	5180	17.70	21.40	-	22.48		
11a	6Mbps	1	44	5220	17.75	21.30	-	22.49		
11a	6Mbps	1	48	5240	17.60	21.30	-	22.46		
HT20	MCS0	1	36	5180	18.55	21.80	-	22.68		
HT20	MCS0	1	44	5220	18.45	21.70	-	22.66		
HT20	MCS0	1	48	5240	18.50	21.70	-	22.67		
HT40	MCS0	1	38	5190	36.60	41.58	-	23.01		
HT40	MCS0	1	46	5230	36.60	41.40	-	23.01		

TEST RESULTS DATA
Average Power Table

FCC Band I										
Mod.	Data Rate	NTX	CH.	Freq. (MHz)	Duty Factor (dB)	Average Conducted Power (dBm)	FCC Conducted Power Limit (dBm)	DG (dBi)		Pass/Fail
11a	6Mbps	1	36	5180	0.12	8.62	24.00	-2.10		Pass
11a	6Mbps	1	44	5220	0.12	8.58	24.00	-2.10		Pass
11a	6Mbps	1	48	5240	0.12	8.58	24.00	-2.10		Pass
HT20	MCS0	1	36	5180	0.13	8.53	24.00	-2.10		Pass
HT20	MCS0	1	44	5220	0.13	8.43	24.00	-2.10		Pass
HT20	MCS0	1	48	5240	0.13	8.48	24.00	-2.10		Pass
HT40	MCS0	1	38	5190	0.23	8.73	24.00	-2.10		Pass
HT40	MCS0	1	46	5230	0.23	8.72	24.00	-2.10		Pass

TEST RESULTS DATA
Power Spectral Density

FCC Band I										
Mod.	Data Rate	N _{TX}	CH.	Freq. (MHz)	Duty Factor (dB)	Average Power Density (dBm/MHz)	Average PSD Limit (dBm/MHz)	DG (dBi)	-	Pass/Fail
11a	6Mbps	1	36	5180	0.12	-2.73	11.00	-2.10		Pass
11a	6Mbps	1	44	5220	0.12	-2.86	11.00	-2.10		Pass
11a	6Mbps	1	48	5240	0.12	-3.08	11.00	-2.10		Pass
HT20	MCS0	1	36	5180	0.13	-3.13	11.00	-2.10		Pass
HT20	MCS0	1	44	5220	0.13	-3.32	11.00	-2.10		Pass
HT20	MCS0	1	48	5240	0.13	-3.60	11.00	-2.10		Pass
HT40	MCS0	1	38	5190	0.23	-5.76	11.00	-2.10		Pass
HT40	MCS0	1	46	5230	0.23	-6.13	11.00	-2.10		Pass

TEST RESULTS DATA
26dB and 99% OBW

Band II										
Mod.	Data Rate	N _{TX}	CH.	Freq. (MHz)	99% Bandwidth (MHz)	26 dB Bandwidth (MHz)	IC 99% Bandwidth Power Limit (dBm)	IC 99% Bandwidth EIRP Limit (dBm)	FCC 26dB Bandwidth Power Limit (dBm)	Note
11a	6M bps	1	52	5260	17.60	21.20	23.46	29.46	23.98	
11a	6M bps	1	60	5300	17.65	21.20	23.47	29.47	23.98	
11a	6M bps	1	64	5320	17.70	21.30	23.48	29.48	23.98	
HT20	MCS 0	1	52	5260	18.50	22.00	23.67	29.67	23.98	
HT20	MCS 0	1	60	5300	18.45	21.50	23.66	29.66	23.98	
HT20	MCS 0	1	64	5320	18.45	21.50	23.66	29.66	23.98	
HT40	MCS 0	1	54	5270	36.70	41.58	23.98	30.00	23.98	
HT40	MCS 0	1	62	5310	36.60	41.40	23.98	30.00	23.98	

TEST RESULTS DATA
Average Power Table

FCC Band II										
Mod.	Data Rate	N _{TX}	CH.	Freq. (MHz)	Duty Factor (dB)	Average Conducted Power (dBm)	FCC Conducted Power Limit (dBm)	DG (dBi)	EIRP Power Limit (dBm)	Pass/Fail
11a	6M bps	1	52	5260	0.12	8.54	23.98	-2.10	26.99	Pass
11a	6M bps	1	60	5300	0.12	8.62	23.98	-2.10	26.99	Pass
11a	6M bps	1	64	5320	0.12	8.72	23.98	-2.10	26.99	Pass
HT20	MCS 0	1	52	5260	0.13	8.45	23.98	-2.10	26.99	Pass
HT20	MCS 0	1	60	5300	0.13	8.58	23.98	-2.10	26.99	Pass
HT20	MCS 0	1	64	5320	0.13	8.64	23.98	-2.10	26.99	Pass
HT40	MCS 0	1	54	5270	0.23	8.59	23.98	-2.10	26.99	Pass
HT40	MCS 0	1	62	5310	0.23	8.74	23.98	-2.10	26.99	Pass

TEST RESULTS DATA
Power Spectral Density

Band II										
Mod.	Data Rate	N _{TX}	CH.	Freq. (MHz)	Duty Factor (dB)	Average Power Density (dBm/MHz)	Average PSD Limit (dBm/MHz)	DG (dBi)		Pass/Fail
11a	6M bps	1	52	5260	0.12	-3.49	11.00	-2.10		Pass
11a	6M bps	1	60	5300	0.12	-3.15	11.00	-2.10		Pass
11a	6M bps	1	64	5320	0.12	-3.07	11.00	-2.10		Pass
HT20	MCS 0	1	52	5260	0.13	-3.77	11.00	-2.10		Pass
HT20	MCS 0	1	60	5300	0.13	-3.68	11.00	-2.10		Pass
HT20	MCS 0	1	64	5320	0.13	-3.50	11.00	-2.10		Pass
HT40	MCS 0	1	54	5270	0.23	-6.59	11.00	-2.10		Pass
HT40	MCS 0	1	62	5310	0.23	-6.22	11.00	-2.10		Pass

TEST RESULTS DATA
26dB and 99% OBW

Band III										
Mod.	Data Rate	N _{TX}	CH.	Freq. (MHz)	99% Bandwidth (MHz)	26 dB Bandwidth (MHz)	IC 99% Bandwidth Power Limit (dBm)	IC 99% Bandwidth EIRP Limit (dBm)	FCC 26dB Bandwidth Power Limit (dBm)	Note
11a	6M bps	1	100	5500	17.70	21.30	23.48	29.48	23.98	
11a	6M bps	1	116	5580	17.50	21.20	23.43	29.43	23.98	
11a	6M bps	1	140	5700	17.80	21.55	23.50	29.50	23.98	
HT20	MCS 0	1	100	5500	18.40	21.80	23.65	29.65	23.98	
HT20	MCS 0	1	116	5580	18.50	21.70	23.67	29.67	23.98	
HT20	MCS 0	1	140	5700	18.50	21.70	23.67	29.67	23.98	
HT40	MCS 0	1	102	5510	36.50	41.22	23.98	30.00	23.98	
HT40	MCS 0	1	110	5550	36.60	41.22	23.98	30.00	23.98	
HT40	MCS 0	1	134	5670	36.60	41.22	23.98	30.00	23.98	

TEST RESULTS DATA
Average Power Table

FCC Band III										
Mod.	Data Rate	N _{TX}	CH.	Freq. (MHz)	Duty Factor (dB)	Average Conducted Power (dBm)	FCC Conducted Power Limit (dBm)	DG (dBi)	EIRP Power Limit (dBm)	Pass/Fail
11a	6M bps	1	100	5500	0.12	8.82	23.98	-2.30	26.99	Pass
11a	6M bps	1	116	5580	0.12	8.64	23.98	-2.30	26.99	Pass
11a	6M bps	1	140	5700	0.12	8.30	23.98	-2.30	26.99	Pass
HT20	MCS 0	1	100	5500	0.13	8.88	23.98	-2.30	26.99	Pass
HT20	MCS 0	1	116	5580	0.13	8.83	23.98	-2.30	26.99	Pass
HT20	MCS 0	1	140	5700	0.13	8.34	23.98	-2.30	26.99	Pass
HT40	MCS 0	1	102	5510	0.23	8.87	23.98	-2.30	26.99	Pass
HT40	MCS 0	1	110	5550	0.23	8.63	23.98	-2.30	26.99	Pass
HT40	MCS 0	1	134	5670	0.23	8.78	23.98	-2.30	26.99	Pass

TEST RESULTS DATA
Power Spectral Density

Band III										
Mod.	Data Rate	N _{TX}	CH.	Freq. (MHz)	Duty Factor (dB)	Average Power Density (dBm/MHz)	Average PSD Limit (dBm/MHz)	DG (dBi)		Pass/Fail
11a	6M bps	1	100	5500	0.12	-2.60	11.00	-2.30		Pass
11a	6M bps	1	116	5580	0.12	-2.46	11.00	-2.30		Pass
11a	6M bps	1	140	5700	0.12	-3.64	11.00	-2.30		Pass
HT20	MCS 0	1	100	5500	0.13	-3.06	11.00	-2.30		Pass
HT20	MCS 0	1	116	5580	0.13	-2.69	11.00	-2.30		Pass
HT20	MCS 0	1	140	5700	0.13	-3.80	11.00	-2.30		Pass
HT40	MCS 0	1	102	5510	0.23	-5.51	11.00	-2.30		Pass
HT40	MCS 0	1	110	5550	0.23	-5.68	11.00	-2.30		Pass
HT40	MCS 0	1	134	5670	0.23	-5.97	11.00	-2.30		Pass

TEST RESULTS DATA
Frequency Stability

Band I										
Mod.	Data Rate	NTX	CH.	Freq. (MHz)	Center Frequency (MHz)	Frequency Deviation (MHz)	Frequency Stability (ppm)	Temperature (°C)	Voltage (V)	Note
11a	6Mbps	1	36	5180	5180.000	0.000	0.00	55	3.85	
11a	6Mbps	1	36	5180	5180.000	0.000	0.00	-30	3.85	
11a	6Mbps	1	36	5180	5180.000	0.000	0.00	20	4.4	
11a	6Mbps	1	36	5180	5179.975	-0.025	-4.83	20	3.5	
11a	6Mbps	1	36	5180	5179.975	-0.025	-4.83	20	3.85	

Band II										
Mod.	Data Rate	NTX	CH.	Freq. (MHz)	Center Frequency (MHz)	Frequency Deviation (MHz)	Frequency Stability (ppm)	Temperature (°C)	Voltage (V)	Note
11a	6Mbps	1	64	5320	5320.000	0.000	0.00	55	3.85	
11a	6Mbps	1	64	5320	5320.000	0.000	0.00	-30	3.85	
11a	6Mbps	1	64	5320	5320.000	0.000	0.00	20	4.4	
11a	6Mbps	1	64	5320	5320.000	0.000	0.00	20	3.5	
11a	6Mbps	1	64	5320	5320.000	0.000	0.00	20	3.85	

Band III										
Mod.	Data Rate	NTX	CH.	Freq. (MHz)	Center Frequency (MHz)	Frequency Deviation (MHz)	Frequency Stability (ppm)	Temperature (°C)	Voltage (V)	Note
11a	6Mbps	1	100	5500	5500.000	0.000	0.00	55	3.85	
11a	6Mbps	1	100	5500	5500.000	0.000	0.00	-30	3.85	
11a	6Mbps	1	100	5500	5500.000	0.000	0.00	20	4.4	
11a	6Mbps	1	100	5500	5500.000	0.000	0.00	20	3.5	
11a	6Mbps	1	100	5500	5500.000	0.000	0.00	20	3.85	



Appendix B. Radiated Spurious Emission

Band 1 - 5150~5250MHz WIFI 802.11a (Band Edge @ 3m)

WIFI Ant.	Note	Frequency	Level	Over Limit	Limit Line	Read Level	Antenna Factor	Cable Loss	Preamp Factor	Ant Pos	Table Pos	Peak Avg.	Pol.
1		(MHz)	(dBμV/m)	(dB)	(dBμV/m)	(dBμV)	(dB/m)	(dB)	(dB)	(cm)	(deg)	(P/A)	(H/V)
802.11a CH 36 5180MHz		5023.66	59.62	-14.38	74	46.76	32.5	11.31	30.95	100	60	P	H
		5030.42	48.43	-5.57	54	35.58	32.49	11.31	30.95	100	60	A	H
	*	5180	89.5	-	-	76.78	32.46	11.21	30.95	100	60	P	H
	*	5180	77.71	-	-	64.99	32.46	11.21	30.95	100	60	A	H
		5144.82	59.34	-14.66	74	46.61	32.47	11.21	30.95	319	255	P	V
		5039	48.31	-5.69	54	35.46	32.49	11.31	30.95	319	255	A	V
	*	5180	86.91	-	-	74.19	32.46	11.21	30.95	319	255	P	V
	*	5180	75.8	-	-	63.08	32.46	11.21	30.95	319	255	A	V
802.11a CH 44 5220MHz		5076.18	59.81	-14.19	74	47.01	32.48	11.27	30.95	100	60	P	H
		5140.66	48.36	-5.64	54	35.63	32.47	11.21	30.95	100	60	A	H
	*	5220	88.33	-	-	75.64	32.46	11.18	30.95	100	60	P	H
	*	5220	77.42	-	-	64.73	32.46	11.18	30.95	100	60	A	H
		5350.8	59.98	-14.02	74	46.98	32.43	11.52	30.95	100	60	P	H
		5385.84	48.55	-5.45	54	35.48	32.42	11.6	30.95	100	60	A	H
		5003.64	60.55	-13.45	74	47.66	32.5	11.34	30.95	285	256	P	V
		5130.52	48.35	-5.65	54	35.59	32.47	11.24	30.95	285	256	A	V
	*	5220	86.21	-	-	73.52	32.46	11.18	30.95	285	256	P	V
	*	5220	75.05	-	-	62.36	32.46	11.18	30.95	285	256	A	V
		5411.04	59.99	-14.01	74	46.92	32.42	11.6	30.95	285	256	P	V
	5390.4	48.56	-5.44	54	35.49	32.42	11.6	30.95	285	256	A	V	



802.11a CH 48 5240MHz		5129.74	60	-14	74	47.24	32.47	11.24	30.95	100	62	P	H
		5077.22	48.27	-5.73	54	35.47	32.48	11.27	30.95	100	62	A	H
	*	5240	89.81	-	-	77.05	32.45	11.26	30.95	100	62	P	H
	*	5240	78.42	-	-	65.66	32.45	11.26	30.95	100	62	A	H
		5441.28	60.56	-13.44	74	47.46	32.41	11.64	30.95	100	62	P	H
		5379.36	48.64	-5.36	54	35.65	32.42	11.52	30.95	100	62	A	H
		5059.02	59.3	-14.7	74	46.45	32.49	11.31	30.95	241	287	P	V
		5010.4	48.34	-5.66	54	35.45	32.5	11.34	30.95	241	287	A	V
	*	5240	87.04	-	-	74.28	32.45	11.26	30.95	241	287	P	V
	*	5240	75.34	-	-	62.58	32.45	11.26	30.95	241	287	A	V
		5420.88	60.15	-13.85	74	47.04	32.42	11.64	30.95	241	287	P	V
		5382.48	48.6	-5.4	54	35.53	32.42	11.6	30.95	241	287	A	V
Remark	1. No other spurious found. 2. All results are PASS against Peak and Average limit line.												



Band 1 5150~5250MHz
WIFI 802.11a (Harmonic @ 3m)

WIFI Ant. 1	Note	Frequency (MHz)	Level (dBμV/m)	Over Limit (dB)	Limit Line (dBμV/m)	Read Level (dBμV)	Antenna Factor (dB/m)	Cable Loss (dB)	Preamp Factor (dB)	Ant Pos (cm)	Table Pos (deg)	Peak Avg. (P/A)	Pol. (H/V)
802.11a CH 36 5180MHz		8288	55.13	-18.87	74	61.63	36.83	15.32	58.65	256	111	P	H
		8288	52.37	-1.63	54	58.87	36.83	15.32	58.65	256	111	A	H
		10360	54.75	-13.45	68.2	55.01	39.75	17.13	57.14	100	0	P	H
		15540	50.89	-23.11	74	48.12	39.38	21.61	58.22	100	0	P	H
		8288	50.27	-23.73	74	56.77	36.83	15.32	58.65	100	0	P	V
		10360	50.95	-17.25	68.2	51.21	39.75	17.13	57.14	100	0	P	V
		15540	58.37	-15.63	74	55.6	39.38	21.61	58.22	245	10	P	V
		15540	41.46	-12.54	54	38.69	39.38	21.61	58.22	245	10	A	V
802.11a CH 44 5220MHz		8352	53.8	-20.2	74	60.18	36.79	15.42	58.59	254	110	P	H
		8352	50.97	-3.03	54	57.35	36.79	15.42	58.59	254	110	A	H
		10440	56.42	-11.78	68.2	56.33	39.89	17.22	57.02	100	0	P	H
		15660	56.97	-17.03	74	54.21	39.02	21.7	57.96	335	11	P	H
		15660	40.66	-13.34	54	37.9	39.02	21.7	57.96	335	11	A	H
		8352	49.24	-24.76	74	55.62	36.79	15.42	58.59	100	0	P	V
		10440	53	-15.2	68.2	52.91	39.89	17.22	57.02	100	0	P	V
		15660	59.26	-14.74	74	56.5	39.02	21.7	57.96	248	6	P	V
802.11a CH 48 5240MHz		8384	54.88	-19.12	74	61.19	36.77	15.46	58.54	191	339	P	H
		8384	52.18	-1.82	54	58.49	36.77	15.46	58.54	191	339	A	H
		10480	53.32	-14.88	68.2	53.02	39.96	17.27	56.93	100	0	P	H
		15720	50.66	-23.34	74	47.87	38.84	21.76	57.81	100	0	P	H
		8384	49.08	-24.92	74	55.39	36.77	15.46	58.54	100	0	P	V
		10480	50.28	-17.92	68.2	49.98	39.96	17.27	56.93	100	0	P	V
		15720	60.29	-13.71	74	57.5	38.84	21.76	57.81	245	2	P	V
		15720	43.49	-10.51	54	40.7	38.84	21.76	57.81	245	2	A	V
Remark	1. No other spurious found. 2. All results are PASS against Peak and Average limit line.												



Band 1 5150~5250MHz
WIFI 802.11n HT20 (Band Edge @ 3m)

WIFI Ant. 1	Note	Frequency (MHz)	Level (dBμV/m)	Over Limit (dB)	Limit Line (dBμV/m)	Read Level (dBμV)	Antenna Factor (dB/m)	Cable Loss (dB)	Preamp Factor (dB)	Ant Pos (cm)	Table Pos (deg)	Peak Avg. (P/A)	Pol. (H/V)
802.11n HT20 CH 36 5180MHz		5066.82	60.16	-13.84	74	47.35	32.49	11.27	30.95	100	60	P	H
		5011.18	48.34	-5.66	54	35.45	32.5	11.34	30.95	100	60	A	H
	*	5180	89.02	-	-	76.3	32.46	11.21	30.95	100	60	P	H
	*	5180	77.67	-	-	64.95	32.46	11.21	30.95	100	60	A	H
		5103.48	60.96	-13.04	74	48.19	32.48	11.24	30.95	315	274	P	V
		5065	48.39	-5.61	54	35.58	32.49	11.27	30.95	315	274	A	V
	*	5180	85.95	-	-	73.23	32.46	11.21	30.95	315	274	P	V
	*	5180	74.49	-	-	61.77	32.46	11.21	30.95	315	274	A	V
802.11n HT20 CH 44 5220MHz		5020.54	59.6	-14.4	74	46.74	32.5	11.31	30.95	100	61	P	H
		5054.08	48.34	-5.66	54	35.49	32.49	11.31	30.95	100	61	A	H
	*	5220	90.84	-	-	78.15	32.46	11.18	30.95	100	61	P	H
	*	5220	78.99	-	-	66.3	32.46	11.18	30.95	100	61	A	H
		5411.04	59.53	-14.47	74	46.46	32.42	11.6	30.95	100	61	P	H
		5423.04	48.6	-5.4	54	35.49	32.42	11.64	30.95	100	61	A	H
		5017.94	60.09	-13.91	74	47.2	32.5	11.34	30.95	309	277	P	V
		5061.88	48.44	-5.56	54	35.63	32.49	11.27	30.95	309	277	A	V
	*	5220	85.74	-	-	73.05	32.46	11.18	30.95	309	277	P	V
	*	5220	74.42	-	-	61.73	32.46	11.18	30.95	309	277	A	V
		5433.6	60.2	-13.8	74	47.1	32.41	11.64	30.95	309	277	P	V
	5398.08	48.58	-5.42	54	35.51	32.42	11.6	30.95	309	277	A	V	



802.11n HT20 CH 48 5240MHz		5024.18	60.11	-13.89	74	47.25	32.5	11.31	30.95	100	63	P	H
		5006.5	48.33	-5.67	54	35.44	32.5	11.34	30.95	100	63	A	H
	*	5240	90.62	-	-	77.86	32.45	11.26	30.95	100	63	P	H
	*	5240	79.02	-	-	66.26	32.45	11.26	30.95	100	63	A	H
		5423.76	59.98	-14.02	74	46.87	32.42	11.64	30.95	100	63	P	H
		5396.4	48.65	-5.35	54	35.58	32.42	11.6	30.95	100	63	A	H
		5027.3	59.35	-14.65	74	46.5	32.49	11.31	30.95	306	246	P	V
		5006.24	48.28	-5.72	54	35.39	32.5	11.34	30.95	306	246	A	V
	*	5240	85.63	-	-	72.87	32.45	11.26	30.95	306	246	P	V
	*	5240	74.13	-	-	61.37	32.45	11.26	30.95	306	246	A	V
		5378.88	60.05	-13.95	74	47.06	32.42	11.52	30.95	306	246	P	V
		5400	48.67	-5.33	54	35.6	32.42	11.6	30.95	306	246	A	V
Remark	1. No other spurious found. 2. All results are PASS against Peak and Average limit line.												



Band 1 5150~5250MHz
WIFI 802.11n HT20 (Harmonic @ 3m)

WIFI Ant. 1	Note	Frequency (MHz)	Level (dBμV/m)	Over Limit (dB)	Limit Line (dBμV/m)	Read Level (dBμV)	Antenna Factor (dB/m)	Cable Loss (dB)	Preamp Factor (dB)	Ant Pos (cm)	Table Pos (deg)	Peak Avg. (P/A)	Pol. (H/V)
802.11n HT20 CH 36 5180MHz		8288	53.92	-20.08	74	60.42	36.83	15.32	58.65	190	111	P	H
		8288	51.42	-2.58	54	57.92	36.83	15.32	58.65	190	111	A	H
		10360	55.38	-12.82	68.2	55.64	39.75	17.13	57.14	100	0	P	H
		15540	49.95	-24.05	74	47.18	39.38	21.61	58.22	100	0	P	H
		8288	49.17	-24.83	74	55.67	36.83	15.32	58.65	100	0	P	V
		10360	51.31	-16.89	68.2	51.57	39.75	17.13	57.14	100	0	P	V
802.11n HT20 CH 44 5220MHz		8352	54.3	-19.7	74	60.68	36.79	15.42	58.59	195	114	P	H
		8352	51.85	-2.15	54	58.23	36.79	15.42	58.59	195	114	A	H
		10440	55.4	-12.8	68.2	55.31	39.89	17.22	57.02	100	0	P	H
		15660	54.57	-19.43	74	51.81	39.02	21.7	57.96	328	9	P	H
		15660	38.38	-15.62	54	35.62	39.02	21.7	57.96	328	9	A	H
		8352	49.1	-24.9	74	55.48	36.79	15.42	58.59	100	0	P	V
		10440	51.63	-16.57	68.2	51.54	39.89	17.22	57.02	100	0	P	V
		15660	56.54	-17.46	74	53.78	39.02	21.7	57.96	251	8	P	V
802.11n HT20 CH 48 5240MHz		8384	54.85	-19.15	74	61.16	36.77	15.46	58.54	208	340	P	H
		8384	52.29	-1.71	54	58.6	36.77	15.46	58.54	208	340	A	H
		10480	53.17	-15.03	68.2	52.87	39.96	17.27	56.93	100	0	P	H
		15720	50.98	-23.02	74	48.19	38.84	21.76	57.81	100	0	P	H
		8384	49.5	-24.5	74	55.81	36.77	15.46	58.54	100	0	P	V
		10480	49.45	-18.75	68.2	49.15	39.96	17.27	56.93	100	0	P	V
		15720	59.18	-14.82	74	56.39	38.84	21.76	57.81	201	1	P	V
		15720	41.9	-12.1	54	39.11	38.84	21.76	57.81	201	1	A	V
Remark	1. No other spurious found. 2. All results are PASS against Peak and Average limit line.												



Band 1 5150~5250MHz
WIFI 802.11n HT40 (Band Edge @ 3m)

WIFI Ant. 1	Note	Frequency (MHz)	Level (dBμV/m)	Over Limit (dB)	Limit Line (dBμV/m)	Read Level (dBμV)	Antenna Factor (dB/m)	Cable Loss (dB)	Preamp Factor (dB)	Ant Pos (cm)	Table Pos (deg)	Peak Avg. (P/A)	Pol. (H/V)
802.11n HT40 CH 38 5190MHz		5048.36	59.51	-14.49	74	46.66	32.49	11.31	30.95	222	60	P	H
		5109.2	49.05	-4.95	54	36.28	32.48	11.24	30.95	222	60	A	H
	*	5190	85.64	-	-	72.95	32.46	11.18	30.95	222	60	P	H
	*	5190	74.55	-	-	61.86	32.46	11.18	30.95	222	60	A	H
		5381.52	60.33	-13.67	74	47.26	32.42	11.6	30.95	222	60	P	H
		5424	49.26	-4.74	54	36.15	32.42	11.64	30.95	222	60	A	H
		5063.44	60.17	-13.83	74	47.36	32.49	11.27	30.95	303	295	P	V
		5140.4	49.02	-4.98	54	36.29	32.47	11.21	30.95	303	295	A	V
	*	5190	86.09	-	-	73.4	32.46	11.18	30.95	303	295	P	V
	*	5190	74.81	-	-	62.12	32.46	11.18	30.95	303	295	A	V
		5400	59.17	-14.83	74	46.1	32.42	11.6	30.95	303	295	P	V
		5428.08	49.43	-4.57	54	36.33	32.41	11.64	30.95	303	295	A	V
	802.11n HT40 CH 46 5230MHz		5085.02	59.17	-14.83	74	46.37	32.48	11.27	30.95	229	60	P
		5017.16	48.94	-5.06	54	36.05	32.5	11.34	30.95	229	60	A	H
*		5230	84.71	-	-	71.95	32.45	11.26	30.95	229	60	P	H
*		5230	73.98	-	-	61.22	32.45	11.26	30.95	229	60	A	H
		5424.96	60.12	-13.88	74	47.01	32.42	11.64	30.95	229	60	P	H
		5412.48	49.32	-4.68	54	36.25	32.42	11.6	30.95	229	60	A	H
		5035.1	60.47	-13.53	74	47.62	32.49	11.31	30.95	336	280	P	V
		5019.24	48.97	-5.03	54	36.08	32.5	11.34	30.95	336	280	A	V
*		5230	84.21	-	-	71.45	32.45	11.26	30.95	336	280	P	V
*		5230	73.35	-	-	60.59	32.45	11.26	30.95	336	280	A	V
	5370.96	60.02	-13.98	74	47.02	32.43	11.52	30.95	336	280	P	V	
	5442	49.38	-4.62	54	36.28	32.41	11.64	30.95	336	280	A	V	
Remark	1. No other spurious found. 2. All results are PASS against Peak and Average limit line.												



Band 1 5150~5250MHz
WIFI 802.11n HT40 (Harmonic @ 3m)

WIFI Ant. 1	Note	Frequency (MHz)	Level (dBμV/m)	Over Limit (dB)	Limit Line (dBμV/m)	Read Level (dBμV)	Antenna Factor (dB/m)	Cable Loss (dB)	Preamp Factor (dB)	Ant Pos (cm)	Table Pos (deg)	Peak Avg. (P/A)	Pol. (H/V)
802.11n HT40 CH 38 5190MHz		8304	53.93	-20.07	74	60.37	36.82	15.37	58.63	256	114	P	H
		8304	51.29	-2.71	54	57.73	36.82	15.37	58.63	256	114	A	H
		10380	54.55	-13.65	68.2	54.75	39.78	17.13	57.11	100	0	P	H
		15570	46.13	-27.87	74	43.35	39.29	21.64	58.15	100	0	P	H
		8304	48.45	-25.55	74	54.89	36.82	15.37	58.63	100	0	P	V
		10380	49.95	-18.25	68.2	50.15	39.78	17.13	57.11	100	0	P	V
802.11n HT40 CH 46 5230MHz		15570	48.84	-25.16	74	46.06	39.29	21.64	58.15	100	0	P	V
		8368	54.44	-19.56	74	60.81	36.78	15.42	58.57	262	151	P	H
		8368	51.73	-2.27	54	58.1	36.78	15.42	58.57	262	151	A	H
		10460	52.8	-15.4	68.2	52.64	39.93	17.22	56.99	100	0	P	H
		15690	47.55	-26.45	74	44.77	38.93	21.73	57.88	100	0	P	H
		8368	49.29	-24.71	74	55.66	36.78	15.42	58.57	100	0	P	V
		10460	49.79	-18.41	68.2	49.63	39.93	17.22	56.99	100	0	P	V
Remark		15690	55.33	-18.67	74	52.55	38.93	21.73	57.88	206	0	P	V
		15690	40.95	-13.05	54	38.17	38.93	21.73	57.88	206	0	A	V
Remark		1. No other spurious found. 2. All results are PASS against Peak and Average limit line.											



Band 2 - 5250~5350MHz
WIFI 802.11a (Band Edge @ 3m)

WIFI	Note	Frequency	Level	Over	Limit	Read	Antenna	Cable	Preamp	Ant	Table	Peak	Pol.
Ant.				Limit	Line	Level	Factor	Loss	Factor	Pos	Pos	Avg.	
1		(MHz)	(dBμV/m)	(dB)	(dBμV/m)	(dBμV)	(dB/m)	(dB)	(dB)	(cm)	(deg)	(P/A)	(H/V)
802.11a CH 52 5260MHz		5106.86	59.64	-14.36	74	46.87	32.48	11.24	30.95	100	61	P	H
		5059.8	48.46	-5.54	54	35.61	32.49	11.31	30.95	100	61	A	H
	*	5260	88.85	-	-	76.09	32.45	11.26	30.95	100	61	P	H
	*	5260	77.25	-	-	64.49	32.45	11.26	30.95	100	61	A	H
		5388.96	60.49	-13.51	74	47.42	32.42	11.6	30.95	100	61	P	H
		5432.16	48.64	-5.36	54	35.54	32.41	11.64	30.95	100	61	A	H
		5146.64	59.63	-14.37	74	46.9	32.47	11.21	30.95	229	287	P	V
		5022.62	48.39	-5.61	54	35.53	32.5	11.31	30.95	229	287	A	V
	*	5260	85.06	-	-	72.3	32.45	11.26	30.95	229	287	P	V
	*	5260	74.21	-	-	61.45	32.45	11.26	30.95	229	287	A	V
		5457.36	61.08	-12.92	74	47.98	32.41	11.64	30.95	229	287	P	V
		5434.32	48.6	-5.4	54	35.5	32.41	11.64	30.95	229	287	A	V
802.11a CH 60 5300MHz		5054.6	59.79	-14.21	74	46.94	32.49	11.31	30.95	100	63	P	H
		5117.26	48.27	-5.73	54	35.5	32.48	11.24	30.95	100	63	A	H
	*	5300	87.86	-	-	75.02	32.44	11.35	30.95	100	63	P	H
	*	5300	76.88	-	-	64.04	32.44	11.35	30.95	100	63	A	H
		5352.48	60.06	-13.94	74	47.06	32.43	11.52	30.95	100	63	P	H
		5432.64	48.71	-5.29	54	35.61	32.41	11.64	30.95	100	63	A	H
		5110.5	60.47	-13.53	74	47.7	32.48	11.24	30.95	317	249	P	V
		5056.42	48.33	-5.67	54	35.48	32.49	11.31	30.95	317	249	A	V
	*	5300	84.12	-	-	71.28	32.44	11.35	30.95	317	249	P	V
	*	5300	72.86	-	-	60.02	32.44	11.35	30.95	317	249	A	V
		5441.52	60.41	-13.59	74	47.31	32.41	11.64	30.95	317	249	P	V
		5359.68	48.53	-5.47	54	35.53	32.43	11.52	30.95	317	249	A	V



802.11a CH 64 5320MHz	*	5320	89.81	-	-	76.89	32.44	11.43	30.95	205	56	P	H
	*	5320	77.52	-	-	64.6	32.44	11.43	30.95	205	56	A	H
		5459.52	60.52	-13.48	74	47.42	32.41	11.64	30.95	205	56	P	H
		5439.68	48.62	-5.38	54	35.52	32.41	11.64	30.95	205	56	A	H
	*	5320	85.85	-	-	72.93	32.44	11.43	30.95	238	280	P	V
	*	5320	74.3	-	-	61.38	32.44	11.43	30.95	238	280	A	V
		5419.2	60.22	-13.78	74	47.15	32.42	11.6	30.95	238	280	P	V
		5395.04	48.58	-5.42	54	35.51	32.42	11.6	30.95	238	280	A	V
Remark	1. No other spurious found. 2. All results are PASS against Peak and Average limit line.												



Band 2 5250~5350MHz
WIFI 802.11a (Harmonic @ 3m)

WIFI Ant. 1	Note	Frequency (MHz)	Level (dBμV/m)	Over Limit (dB)	Limit Line (dBμV/m)	Read Level (dBμV)	Antenna Factor (dB/m)	Cable Loss (dB)	Preamp Factor (dB)	Ant Pos (cm)	Table Pos (deg)	Peak Avg. (P/A)	Pol. (H/V)
802.11a CH 52 5260MHz		8416	55.33	-18.67	74	61.62	36.75	15.46	58.5	205	340	P	H
		8416	52.77	-1.23	54	59.06	36.75	15.46	58.5	205	340	A	H
		10520	52.93	-15.27	68.2	52.51	40.01	17.31	56.9	100	0	P	H
		15780	50.65	-23.35	74	47.89	38.66	21.79	57.69	100	0	P	H
		8416	50.03	-23.97	74	56.32	36.75	15.46	58.5	100	0	P	V
		10520	50.93	-17.27	68.2	50.51	40.01	17.31	56.9	100	0	P	V
		15780	60.89	-13.11	74	58.13	38.66	21.79	57.69	203	4	P	V
		15780	43.8	-10.2	54	41.04	38.66	21.79	57.69	203	4	A	V
802.11a CH 60 5300MHz		8480	54.17	-19.83	74	60.35	36.71	15.53	58.42	195	341	P	H
		8480	51.6	-2.4	54	57.78	36.71	15.53	58.42	195	341	A	H
		10600	56.23	-17.77	74	55.67	40.04	17.4	56.88	187	175	P	H
		10600	42.73	-11.27	54	42.17	40.04	17.4	56.88	187	175	A	H
		15900	49.85	-24.15	74	47.1	38.3	21.88	57.43	100	0	P	H
		8480	48.81	-25.19	74	61.58	36.71	15.53	65.01	100	0	P	V
		10600	50.39	-23.61	74	58.13	40.04	17.4	65.18	100	0	P	V
		15900	60.74	-13.26	74	65.33	38.3	21.88	64.77	205	4	P	V
802.11a CH 64 5320MHz		15900	43.38	-10.62	54	40.63	38.3	21.88	57.43	205	4	A	V
		10640	54.28	-19.72	74	53.64	40.06	17.45	56.87	178	178	P	H
		10640	40.46	-13.54	54	39.82	40.06	17.45	56.87	178	178	A	H
		15960	50.29	-23.71	74	47.51	38.12	21.94	57.28	100	0	P	H
		10640	48.93	-25.07	74	48.29	40.06	17.45	56.87	100	0	P	V
		15960	62.93	-11.07	74	67.79	38.12	21.94	64.92	235	4	P	V
		15960	44.91	-9.09	54	42.13	38.12	21.94	57.28	235	4	A	V
Remark	1. No other spurious found. 2. All results are PASS against Peak and Average limit line.												



Band 2 5250~5350MHz
WIFI 802.11n HT20 (Band Edge @ 3m)

Table with 14 columns: WIFI Ant. 1, Note, Frequency (MHz), Level (dBµV/m), Over Limit (dB), Limit Line (dBµV/m), Read Level (dBµV), Antenna Factor (dB/m), Cable Loss (dB), Preamp Factor (dB), Ant Pos (cm), Table Pos (deg), Peak Avg. (P/A), Pol. (H/V). Rows include data for 802.11n HT20 CH 52 (5260MHz) and 802.11n HT20 CH 60 (5300MHz).



802.11n HT20 CH 64 5320MHz	*	5320	90.43	-	-	77.51	32.44	11.43	30.95	100	60	P	H
	*	5320	78.61	-	-	65.69	32.44	11.43	30.95	100	60	A	H
		5417.6	59.47	-14.53	74	46.4	32.42	11.6	30.95	100	60	P	H
		5436	48.6	-5.4	54	35.5	32.41	11.64	30.95	100	60	A	H
	*	5320	85.15	-	-	72.23	32.44	11.43	30.95	312	272	P	V
	*	5320	73.85	-	-	60.93	32.44	11.43	30.95	312	272	A	V
		5362.56	60.06	-13.94	74	47.06	32.43	11.52	30.95	312	272	P	V
		5418.08	48.75	-5.25	54	35.68	32.42	11.6	30.95	312	272	A	V
Remark	1. No other spurious found. 2. All results are PASS against Peak and Average limit line.												



Band 2 5250~5350MHz
WIFI 802.11n HT20 (Harmonic @ 3m)

WIFI Ant. 1	Note	Frequency (MHz)	Level (dBμV/m)	Over Limit (dB)	Limit Line (dBμV/m)	Read Level (dBμV)	Antenna Factor (dB/m)	Cable Loss (dB)	Preamp Factor (dB)	Ant Pos (cm)	Table Pos (deg)	Peak Avg. (P/A)	Pol. (H/V)
802.11n HT20 CH 52 5260MHz		8416	54.89	-19.11	74	61.18	36.75	15.46	58.5	195	336	P	H
		8416	52.16	-1.84	54	58.45	36.75	15.46	58.5	195	336	A	H
		10520	50.91	-17.29	68.2	50.49	40.01	17.31	56.9	100	0	P	H
		15780	55.97	-18.03	74	53.21	38.66	21.79	57.69	329	13	P	H
		15780	39.74	-14.26	54	36.98	38.66	21.79	57.69	329	13	A	H
		8416	49.46	-24.54	74	55.75	36.75	15.46	58.5	100	0	P	V
		10520	49.48	-18.72	68.2	49.06	40.01	17.31	56.9	100	0	P	V
		15780	60.58	-13.42	74	64.64	38.66	21.79	64.51	202	3	P	V
		15780	42.74	-11.26	54	46.8	38.66	21.79	64.51	202	3	A	V
802.11n HT20 CH 60 5300MHz		8480	53.51	-20.49	74	59.69	36.71	15.53	58.42	217	347	P	H
		8480	50.59	-3.41	54	56.77	36.71	15.53	58.42	217	347	A	H
		10600	57.63	-16.37	74	57.07	40.04	17.4	56.88	169	176	P	H
		10600	41.94	-12.06	54	41.38	40.04	17.4	56.88	169	176	A	H
		15900	50.79	-23.21	74	48.04	38.3	21.88	57.43	100	0	P	H
		8480	48.26	-25.74	74	54.44	36.71	15.53	58.42	100	0	P	V
		10600	50.61	-23.39	74	50.05	40.04	17.4	56.88	100	0	P	V
		15900	60.26	-13.74	74	57.51	38.3	21.88	57.43	205	4	P	V
		15900	43.06	-10.94	54	40.31	38.3	21.88	57.43	205	4	A	V
802.11n HT20 CH 64 5320MHz		10640	50.03	-23.97	74	49.39	40.06	17.45	56.87	100	0	P	H
		15960	56.17	-17.83	74	53.39	38.12	21.94	57.28	100	135	P	H
		15960	42.24	-11.76	54	39.46	38.12	21.94	57.28	100	135	A	H
		10640	49.09	-24.91	74	48.45	40.06	17.45	56.87	100	0	P	V
		15960	60.02	-13.98	74	57.24	38.12	21.94	57.28	204	4	P	V
		15960	44.58	-9.42	54	41.8	38.12	21.94	57.28	204	4	A	V
Remark	1. No other spurious found. 2. All results are PASS against Peak and Average limit line.												



Band 2 5250~5350MHz
WIFI 802.11n HT40 (Band Edge @ 3m)

WIFI Ant. 1	Note	Frequency (MHz)	Level (dBμV/m)	Over Limit (dB)	Limit Line (dBμV/m)	Read Level (dBμV)	Antenna Factor (dB/m)	Cable Loss (dB)	Preamp Factor (dB)	Ant Pos (cm)	Table Pos (deg)	Peak Avg. (P/A)	Pol. (H/V)
802.11n HT40 CH 54 5270MHz		5057.98	59.98	-14.02	74	47.13	32.49	11.31	30.95	100	60	P	H
		5015.34	49.13	-4.87	54	36.24	32.5	11.34	30.95	100	60	A	H
	*	5270	86.12	-	-	73.27	32.45	11.35	30.95	100	60	P	H
	*	5270	75.09	-	-	62.24	32.45	11.35	30.95	100	60	A	H
		5448.48	59.96	-14.04	74	46.86	32.41	11.64	30.95	100	60	P	H
		5440.8	49.53	-4.47	54	36.43	32.41	11.64	30.95	100	60	A	H
		5122.98	60.41	-13.59	74	47.64	32.48	11.24	30.95	313	289	P	V
		5038.48	49.08	-4.92	54	36.23	32.49	11.31	30.95	313	289	A	V
	*	5270	83.39	-	-	70.54	32.45	11.35	30.95	313	289	P	V
	*	5270	72.26	-	-	59.41	32.45	11.35	30.95	313	289	A	V
		5351.76	60.86	-13.14	74	47.86	32.43	11.52	30.95	313	289	P	V
		5434.56	49.22	-4.78	54	36.12	32.41	11.64	30.95	313	289	A	V
802.11n HT40 CH 62 5310MHz		5002.6	60.25	-13.75	74	47.36	32.5	11.34	30.95	225	59	P	H
		5046.8	49.23	-4.77	54	36.38	32.49	11.31	30.95	225	59	A	H
	*	5310	85.99	-	-	73.07	32.44	11.43	30.95	225	59	P	H
	*	5310	75.19	-	-	62.27	32.44	11.43	30.95	225	59	A	H
		5400.96	60.14	-13.86	74	47.07	32.42	11.6	30.95	225	59	P	H
		5386.56	49.59	-4.41	54	36.52	32.42	11.6	30.95	225	59	A	H
		5061.1	59.26	-14.74	74	46.45	32.49	11.27	30.95	275	264	P	V
		5122.98	49.05	-4.95	54	36.28	32.48	11.24	30.95	275	264	A	V
	*	5310	82.54	-	-	69.62	32.44	11.43	30.95	275	264	P	V
	*	5310	71.81	-	-	58.89	32.44	11.43	30.95	275	264	A	V
	5390.64	59.97	-14.03	74	46.9	32.42	11.6	30.95	275	264	P	V	
	5421.36	49.22	-4.78	54	36.11	32.42	11.64	30.95	275	264	A	V	
Remark	1. No other spurious found. 2. All results are PASS against Peak and Average limit line.												



Band 2 5250~5350MHz
WIFI 802.11n HT40 (Harmonic @ 3m)

Table with 14 columns: WIFI Ant. 1, Note, Frequency (MHz), Level (dBµV/m), Over Limit (dB), Limit Line (dBµV/m), Read Level (dBµV), Antenna Factor (dB/m), Cable Loss (dB), Preamp Factor (dB), Ant Pos (cm), Table Pos (deg), Peak Avg. (P/A), Pol. (H/V). Rows include test data for 802.11n HT40 CH 54 at 5270MHz and 802.11n HT40 CH 62 at 5310MHz.



**Band 3 - 5470~5725MHz
WIFI 802.11a (Band Edge @ 3m)**

WIFI Ant. 1	Note	Frequency (MHz)	Level (dBμV/m)	Over Limit (dB)	Limit Line (dBμV/m)	Read Level (dBμV)	Antenna Factor (dB/m)	Cable Loss (dB)	Preamp Factor (dB)	Ant Pos (cm)	Table Pos (deg)	Peak Avg. (P/A)	Pol. (H/V)
802.11a CH 100 5500MHz		5444.08	60.38	-13.62	74	47.28	32.41	11.64	30.95	100	62	P	H
		5465.52	60.28	-7.92	68.2	47.15	32.41	11.67	30.95	100	62	P	H
		5381.04	48.6	-5.4	54	35.53	32.42	11.6	30.95	100	62	A	H
	*	5500	89.62	-	-	76.5	32.4	11.67	30.95	100	62	P	H
	*	5500	78.23	-	-	65.11	32.4	11.67	30.95	100	62	A	H
		5397.04	59.99	-14.01	74	46.92	32.42	11.6	30.95	326	267	P	V
		5464.88	58.92	-9.28	68.2	45.79	32.41	11.67	30.95	326	267	P	V
		5457.36	48.6	-5.4	54	35.5	32.41	11.64	30.95	326	267	A	V
	*	5500	84.82	-	-	71.7	32.4	11.67	30.95	326	267	P	V
	*	5500	73.13	-	-	60.01	32.4	11.67	30.95	326	267	A	V
802.11a CH 116 5580MHz		5424.64	60.5	-13.5	74	47.39	32.42	11.64	30.95	100	61	P	H
		5464.48	59.58	-8.62	68.2	46.45	32.41	11.67	30.95	100	61	P	H
		5431.6	48.65	-5.35	54	35.55	32.41	11.64	30.95	100	61	A	H
	*	5580	90.27	-	-	76.89	32.62	11.74	30.98	100	61	P	H
	*	5580	79.48	-	-	66.1	32.62	11.74	30.98	100	61	A	H
		5726.85	60.77	-7.43	68.2	46.91	33.04	11.84	31.02	100	61	P	H
		5441.68	59.77	-14.23	74	46.67	32.41	11.64	30.95	300	254	P	V
		5467.12	59.29	-8.91	68.2	46.16	32.41	11.67	30.95	300	254	P	V
		5457.76	48.78	-5.22	54	35.68	32.41	11.64	30.95	300	254	A	V
	*	5580	83.26	-	-	69.88	32.62	11.74	30.98	300	254	P	V
	*	5580	72.62	-	-	59.24	32.62	11.74	30.98	300	254	A	V
	5737.875	61.12	-7.08	68.2	47.24	33.07	11.84	31.03	300	254	P	V	
802.11a CH 140 5700MHz	*	5700	91.15	-	-	77.38	32.96	11.82	31.01	100	61	P	H
	*	5700	80	-	-	66.23	32.96	11.82	31.01	100	61	A	H
		5764.52	61.35	-6.85	68.2	47.39	33.14	11.86	31.04	100	61	P	H
	*	5700	84.91	-	-	71.14	32.96	11.82	31.01	346	253	P	V
	*	5700	73.71	-	-	59.94	32.96	11.82	31.01	346	253	A	V
		5738.6	60.95	-7.25	68.2	47.07	33.07	11.84	31.03	346	253	P	V
Remark	1. No other spurious found. 2. All results are PASS against Peak and Average limit line.												



Band 3 - 5470~5725MHz
WIFI 802.11a (Harmonic @ 3m)

Table with 14 columns: WIFI Ant. 1, Note, Frequency (MHz), Level (dBµV/m), Over Limit (dB), Limit Line (dBµV/m), Read Level (dBµV), Antenna Factor (dB/m), Cable Loss (dB), Preamp Factor (dB), Ant Pos (cm), Table Pos (deg), Peak Avg. (P/A), Pol. (H/V). Rows include data for CH 100 (5500MHz), CH 116 (5580MHz), CH 140 (5700MHz), and a Remark section.



Band 3 - 5470~5725MHz
WIFI 802.11n HT20 (Band Edge @ 3m)

WIFI Ant. 1	Note	Frequency (MHz)	Level (dBμV/m)	Over Limit (dB)	Limit Line (dBμV/m)	Read Level (dBμV)	Antenna Factor (dB/m)	Cable Loss (dB)	Preamp Factor (dB)	Ant Pos (cm)	Table Pos (deg)	Peak Avg. (P/A)	Pol. (H/V)
802.11n HT20 CH 100 5500MHz		5459.12	60.06	-13.94	74	46.96	32.41	11.64	30.95	100	61	P	H
		5464.88	59.15	-9.05	68.2	46.02	32.41	11.67	30.95	100	61	P	H
		5450	48.6	-5.4	54	35.5	32.41	11.64	30.95	100	61	A	H
	*	5500	89.04	-	-	75.92	32.4	11.67	30.95	100	61	P	H
	*	5500	77.55	-	-	64.43	32.4	11.67	30.95	100	61	A	H
		5394.96	60	-14	74	46.93	32.42	11.6	30.95	321	284	P	V
		5468.4	58.86	-9.34	68.2	45.73	32.41	11.67	30.95	321	284	P	V
		5448.24	48.68	-5.32	54	35.58	32.41	11.64	30.95	321	284	A	V
	*	5500	84.73	-	-	71.61	32.4	11.67	30.95	321	284	P	V
	*	5500	72.99	-	-	59.87	32.4	11.67	30.95	321	284	A	V
802.11n HT20 CH 116 5580MHz		5361.28	61.04	-12.96	74	48.04	32.43	11.52	30.95	101	60	P	H
		5463.76	59.61	-8.59	68.2	46.48	32.41	11.67	30.95	101	60	P	H
		5440.96	48.63	-5.37	54	35.53	32.41	11.64	30.95	101	60	A	H
	*	5580	91.59	-	-	78.21	32.62	11.74	30.98	101	60	P	H
	*	5580	79.96	-	-	66.58	32.62	11.74	30.98	101	60	A	H
		5735.6	60.15	-8.05	68.2	46.28	33.06	11.84	31.03	101	60	P	H
		5438.56	60.26	-13.74	74	47.16	32.41	11.64	30.95	386	82	P	V
		5468.56	58.72	-9.48	68.2	45.59	32.41	11.67	30.95	386	82	P	V
		5431.36	48.65	-5.35	54	35.55	32.41	11.64	30.95	386	82	A	V
	*	5580	87.24	-	-	73.86	32.62	11.74	30.98	386	82	P	V
*	5580	75.54	-	-	62.16	32.62	11.74	30.98	386	82	A	V	
	5752.75	60.38	-7.82	68.2	46.44	33.11	11.86	31.03	386	82	P	V	
802.11n HT20 CH 140 5700MHz	*	5700	89.45	-	-	75.68	32.96	11.82	31.01	100	68	P	H
	*	5700	78.29	-	-	64.52	32.96	11.82	31.01	100	68	A	H
		5744.36	61.15	-7.05	68.2	47.24	33.08	11.86	31.03	100	68	P	H
	*	5700	85.19	-	-	71.42	32.96	11.82	31.01	322	275	P	V
	*	5700	73.36	-	-	59.59	32.96	11.82	31.01	322	275	A	V
		5740.68	61.06	-7.14	68.2	47.16	33.07	11.86	31.03	322	275	P	V
Remark	1. No other spurious found. 2. All results are PASS against Peak and Average limit line.												



Band 3 - 5470~5725MHz
WIFI 802.11n HT20 (Harmonic @ 3m)

Table with 14 columns: WIFI Ant. 1, Note, Frequency (MHz), Level (dBµV/m), Over Limit (dB), Limit Line (dBµV/m), Read Level (dBµV), Antenna Factor (dB/m), Cable Loss (dB), Preamp Factor (dB), Ant Pos (cm), Table Pos (deg), Peak Avg. (P/A), Pol. (H/V). Rows include data for 802.11n HT20 CH 100 (5500MHz) and 802.11n HT20 CH 140 (5700MHz).

Remark
1. No other spurious found.
2. All results are PASS against Peak and Average limit line.



Band 3 - 5470~5725MHz
WIFI 802.11n HT40 (Band Edge @ 3m)

WIFI Ant. 1	Note	Frequency (MHz)	Level (dBμV/m)	Over Limit (dB)	Limit Line (dBμV/m)	Read Level (dBμV)	Antenna Factor (dB/m)	Cable Loss (dB)	Preamp Factor (dB)	Ant Pos (cm)	Table Pos (deg)	Peak Avg. (P/A)	Pol. (H/V)
802.11n HT40 CH 102 5510MHz		5451.52	60.08	-13.92	74	46.98	32.41	11.64	30.95	100	61	P	H
		5465.2	60.3	-7.9	68.2	47.17	32.41	11.67	30.95	100	61	P	H
		5386.72	49.51	-4.49	54	36.44	32.42	11.6	30.95	100	61	A	H
	*	5510	85.43	-	-	72.26	32.43	11.7	30.96	100	61	P	H
	*	5510	74.19	-	-	61.02	32.43	11.7	30.96	100	61	A	H
		5726.85	60.74	-7.46	68.2	46.88	33.04	11.84	31.02	100	61	P	H
		5459.68	60.68	-13.32	74	47.58	32.41	11.64	30.95	304	271	P	V
		5463.76	59.3	-8.9	68.2	46.17	32.41	11.67	30.95	304	271	P	V
		5385.76	49.37	-4.63	54	36.3	32.42	11.6	30.95	304	271	A	V
	*	5510	82.85	-	-	69.68	32.43	11.7	30.96	304	271	P	V
	*	5510	71.67	-	-	58.5	32.43	11.7	30.96	304	271	A	V
	5749.425	60.31	-7.89	68.2	46.38	33.1	11.86	31.03	304	271	P	V	
802.11n HT40 CH 110 5550MHz		5452	60.58	-13.42	74	47.48	32.41	11.64	30.95	100	59	P	H
		5467.36	59.3	-8.9	68.2	46.17	32.41	11.67	30.95	100	59	P	H
		5451.76	49.37	-4.63	54	36.27	32.41	11.64	30.95	100	59	A	H
	*	5550	87.6	-	-	74.29	32.54	11.74	30.97	100	59	P	H
	*	5550	76.13	-	-	62.82	32.54	11.74	30.97	100	59	A	H
		5730.175	60.03	-8.17	68.2	46.17	33.04	11.84	31.02	100	59	P	H
		5390.8	60.04	-13.96	74	46.97	32.42	11.6	30.95	288	272	P	V
		5469.52	59.34	-8.86	68.2	46.21	32.41	11.67	30.95	288	272	P	V
		5443.36	49.38	-4.62	54	36.28	32.41	11.64	30.95	288	272	A	V
	*	5550	82.99	-	-	69.68	32.54	11.74	30.97	288	272	P	V
	*	5550	71.36	-	-	58.05	32.54	11.74	30.97	288	272	A	V
	5743.125	60.29	-7.91	68.2	46.38	33.08	11.86	31.03	288	272	P	V	



802.11n HT40 CH 134 5670MHz		5434.24	60.44	-13.56	74	47.34	32.41	11.64	30.95	100	62	P	H
		5463.04	58.67	-9.53	68.2	45.54	32.41	11.67	30.95	100	62	P	H
		5370.16	49.42	-4.58	54	36.42	32.43	11.52	30.95	100	62	A	H
	*	5670	87.16	-	-	73.47	32.88	11.82	31.01	100	62	P	H
	*	5670	76	-	-	62.31	32.88	11.82	31.01	100	62	A	H
		5741.2	61.3	-6.9	68.2	47.39	33.08	11.86	31.03	100	62	P	H
		5426.08	60.11	-13.89	74	47.01	32.41	11.64	30.95	299	280	P	V
		5464.24	59.16	-9.04	68.2	46.03	32.41	11.67	30.95	299	280	P	V
		5422.48	49.27	-4.73	54	36.16	32.42	11.64	30.95	299	280	A	V
	*	5670	82.28	-	-	68.59	32.88	11.82	31.01	299	280	P	V
	*	5670	70.62	-	-	56.93	32.88	11.82	31.01	299	280	A	V
		5728.775	60.36	-7.84	68.2	46.5	33.04	11.84	31.02	299	280	P	V
Remark	<p>1. No other spurious found.</p> <p>2. All results are PASS against Peak and Average limit line.</p>												



Band 3 - 5470~5725MHz
WIFI 802.11n HT40 (Harmonic @ 3m)

WIFI Ant. 1	Note	Frequency (MHz)	Level (dBμV/m)	Over Limit (dB)	Limit Line (dBμV/m)	Read Level (dBμV)	Antenna Factor (dB/m)	Cable Loss (dB)	Preamp Factor (dB)	Ant Pos (cm)	Table Pos (deg)	Peak Avg. (P/A)	Pol. (H/V)
802.11n HT40 CH 102		11020	46.94	-27.06	74	53.99	40.2	17.86	65.11	100	0	P	H
		16530	49.81	-18.39	68.2	52.81	39.61	22.46	65.07	100	0	P	H
5510MHz		11020	48.3	-25.7	74	55.35	40.2	17.86	65.11	100	0	P	V
		16530	53.73	-14.47	68.2	56.73	39.61	22.46	65.07	100	0	P	V
802.11n HT40 CH 110		11100	50.18	-23.82	74	57.19	40.2	17.95	65.16	100	0	P	H
		16650	51.36	-16.84	68.2	53.66	40.07	22.57	64.94	100	0	P	H
		11100	49.55	-24.45	74	56.56	40.2	17.95	65.16	100	0	P	V
		16650	56.43	-11.77	68.2	58.73	40.07	22.57	64.94	100	0	P	V
802.11n HT40 CH 134		9072	53.24	-20.76	74	64.77	37.44	16.14	65.11	186	111	P	H
		9072	50.04	-3.96	54	61.57	37.44	16.14	65.11	186	111	A	H
		11340	47.6	-26.4	74	54.48	40.2	18.22	65.3	100	0	P	H
		17010	52.2	-16	68.2	52.45	41.42	22.91	64.58	100	0	P	H
		9072	47.43	-26.57	74	58.96	37.44	16.14	65.11	100	0	P	V
		11340	48.91	-25.09	74	55.79	40.2	18.22	65.3	100	0	P	V
		17010	56.14	-12.06	68.2	56.39	41.42	22.91	64.58	100	0	P	V
Remark	1. No other spurious found. 2. All results are PASS against Peak and Average limit line.												



Emission below 1GHz

WIFI 802.11a (LF @ 3m)

WIFI	Note	Frequency	Level	Over	Limit	Read	Antenna	Cable	Preamp	Ant	Table	Peak	Pol.
Ant.				Limit	Line	Level	Factor	Loss	Factor	Pos	Pos	Avg.	
1		(MHz)	(dBμV/m)	(dB)	(dBμV/m)	(dBμV)	(dB/m)	(dB)	(dB)	(cm)	(deg)	(P/A)	(H/V)
802.11a LF		31.35	23.72	-16.28	40	30.14	25.26	0.78	32.46	-	-	P	H
		155.01	26.86	-16.64	43.5	40.28	17.25	1.75	32.42	-	-	P	H
		245.73	23.8	-22.2	46	36.21	18.09	1.83	32.33	-	-	P	H
		453.3	29	-17	46	35.35	23.15	2.89	32.39	-	-	P	H
		781.6	30.06	-15.94	46	30.43	27.73	4.14	32.24	-	-	P	H
		954.5	33.1	-12.9	46	29.2	30.24	4.75	31.09	100	0	P	H
		39.18	27.19	-12.81	40	38.01	20.86	0.78	32.46	100	0	P	V
		92.64	23.58	-19.92	43.5	39.79	15.16	1.06	32.43	-	-	P	V
		257.07	20.18	-25.82	46	31.46	19.2	1.83	32.31	-	-	P	V
		453.3	25.62	-20.38	46	31.97	23.15	2.89	32.39	-	-	P	V
		765.5	29.57	-16.43	46	30.21	27.66	3.97	32.27	-	-	P	V
		939.8	33.15	-12.85	46	29.74	30.03	4.6	31.22	-	-	P	V
Remark	1. No other spurious found. 2. All results are PASS against limit line.												



Note symbol

*	Fundamental Frequency which can be ignored. However, the level of any unwanted emissions shall not exceed the level of the fundamental frequency.
!	Test result is over limit line.
P/A	Peak or Average
H/V	Horizontal or Vertical



A calculation example for radiated spurious emission is shown as below:

WIFI	Note	Frequency	Level	Over	Limit	Read	Antenna	Cable	Preamp	Ant	Table	Peak	Pol.
Ant.				Limit	Line	Level	Factor	Loss	Factor	Pos	Pos	Avg.	
1		(MHz)	(dBμV/m)	(dB)	(dBμV/m)	(dBμV)	(dB/m)	(dB)	(dB)	(cm)	(deg)	(P/A)	(H/V)
802.11b		2390	55.45	-18.55	74	54.51	32.22	4.58	35.86	103	308	P	H
CH 01													
2412MHz		2390	43.54	-10.46	54	42.6	32.22	4.58	35.86	103	308	A	H

- Level(dBμV/m) =
Antenna Factor(dB/m) + Cable Loss(dB) + Read Level(dBμV) - Preamp Factor(dB)
- Over Limit(dB) = Level(dBμV/m) – Limit Line(dBμV/m)

For Peak Limit @ 2390MHz:

- Level(dBμV/m)
= Antenna Factor(dB/m) + Cable Loss(dB) + Read Level(dBμV) - Preamp Factor(dB)
= 32.22(dB/m) + 4.58(dB) + 54.51(dBμV) – 35.86 (dB)
= 55.45 (dBμV/m)
- Over Limit(dB)
= Level(dBμV/m) – Limit Line(dBμV/m)
= 55.45(dBμV/m) – 74(dBμV/m)
= -18.55(dB)

For Average Limit @ 2390MHz:

- Level(dBμV/m)
= Antenna Factor(dB/m) + Cable Loss(dB) + Read Level(dBμV) - Preamp Factor(dB)
= 32.22(dB/m) + 4.58(dB) + 42.6(dBμV) – 35.86 (dB)
= 43.54 (dBμV/m)
- Over Limit(dB)
= Level(dBμV/m) – Limit Line(dBμV/m)
= 43.54(dBμV/m) – 54(dBμV/m)
= -10.46(dB)

Both peak and average measured complies with the limit line, so test result is “PASS”.



Appendix C. Duty Cycle Plots

Band	Duty Cycle(%)	T(ms)	1/T(kHz)	VBW Setting
802.11a	97.22	1.400	0.714	1KHz
802.11n HT20	97.02	1.300	0.769	1KHz
802.11n HT40	94.74	0.648	1.543	3KHz

802.11a

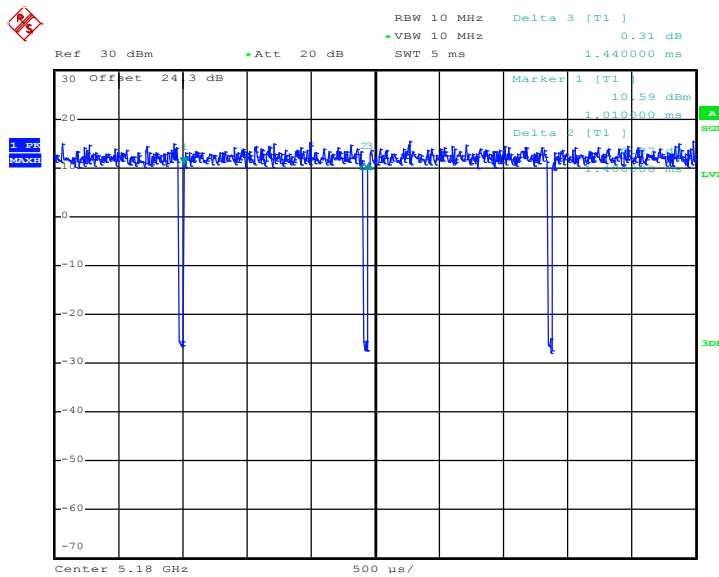

Date: 2.MAR.2017 21:09:48



802.11n HT20

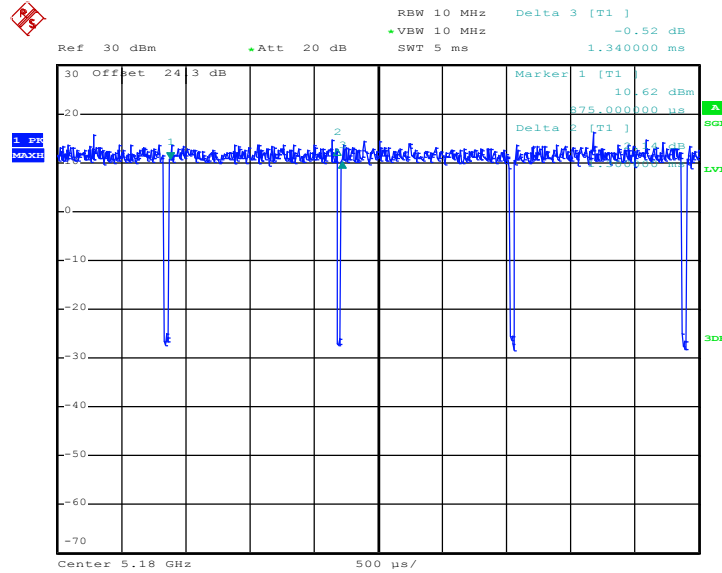

Date: 2.MAR.2017 21:38:12

802.11n HT40

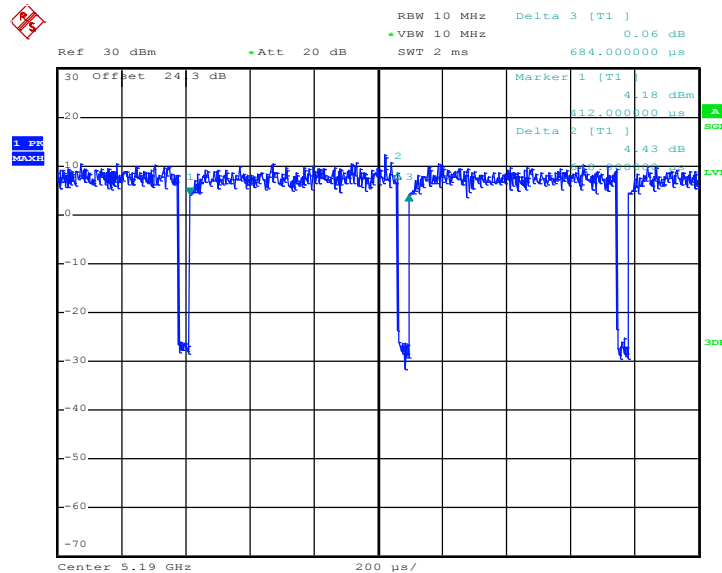

Date: 2.MAR.2017 21:48:49