

ELECTROMAGNETIC EMISSIONS COMPLIANCE REPORT

INTENTIONAL RADIATOR CERTIFICATION TO FCC PART 22 SUBPART H REQUIREMENT

OF

Product Name: Smart Phone

Brand Name: Nokia

Model No.: TA-1035

Model Difference: N/A

FCC ID: 2AJOTTA-1035

Report No.: ER/2017/60078-01

Issue Date: Aug. 24, 2017

FCC Rule Part: 2 , 22H

Prepared for: HMD Global Oy
Karaportti 2, 02610 Espoo, Finland

Prepared by: SGS Taiwan Ltd.
Electronics & Communication Laboratory
No.134, Wu Kung Road, New Taipei Industrial Park,
Wuku District, New Taipei City, Taiwan 24803



Note: This report shall not be reproduced except in full, without the written approval of SGS Taiwan Ltd. This document may be altered or revised by SGS Taiwan Ltd. personnel only, and shall be noted in the revision section of the document.

Unless otherwise stated the results shown in this test report refer only to the sample(s) tested and such sample(s) are retained for 90 days only.

除非另有說明，此報告結果僅對測試之樣品負責，同時此樣品僅保留90天。本報告未經本公司書面許可，不可部份複製。

This document is issued by the Company subject to its General Conditions of Service printed overleaf, available on request or accessible at www.sgs.com/terms_and_conditions.htm and, for electronic format documents, subject to Terms and Conditions for Electronic Documents at www.sgs.com/terms_e-document.htm. Attention is drawn to the limitation of liability, indemnification and jurisdiction issues defined therein. Any holder of this document is advised that information contained hereon reflects the Company's findings at the time of its intervention only and within the limits of Client's instructions, if any. The Company's sole responsibility is to its Client and this document does not exonerate parties to a transaction from exercising all their rights and obligations under the transaction documents. This document cannot be reproduced except in full, without prior written approval of the Company. Any unauthorized alteration, forgery or falsification of the content or appearance of this document is unlawful and offenders may be prosecuted to the fullest extent of the law.

SGS Taiwan Ltd.

No.134,WuKungRoad,NewTaipeiIndustrialPark,WukuDistrict,NewTaipeiCity,Taiwan24803/新北市五股區新北產業園區五工路 134 號

台灣檢驗科技股份有限公司

t (886-2) 2299-3279

f (886-2) 2298-0488

www.tw.sgs.com

Member of SGS Group

VERIFICATION OF COMPLIANCE

Applicant: HMD Global Oy
Karaportti 2, 02610 Espoo, Finland

Product Name: Smart Phone

Brand Name: Nokia

Model No.: TA-1035

Model Difference: N/A

FCC ID: 2AJOTTA-1035

File Number: ER/2017/60078-01

Date of test: Aug, 10, 2017

Date of EUT Received: Jul. 24, 2017

We hereby certify that:

The above equipment was tested by SGS Taiwan Ltd. Electronics & Communication Laboratory. The test data, data evaluation, test procedures, and equipment configurations shown in this report were made in accordance with the procedures given in TIA/EIA-603-D-2010 and the energy emitted by the sample EUT tested as described in this report is in compliance with conducted and radiated emission limits.

The test results of this report relate only to the tested sample identified in this report.

Test By:

Louis Chen

Date:

Aug. 24, 2017

Louis Chen / Engineer

Prepared By:

Allen Tsai

Date:

Aug. 24, 2017

Allen Tsai / Engineer

Approved By:

Jim Chang

Date:

Aug. 24, 2017

Jim Chang / Asst. Manager

Unless otherwise stated the results shown in this test report refer only to the sample(s) tested and such sample(s) are retained for 90 days only.

除非另有說明，此報告結果僅對測試之樣品負責，同時此樣品僅保留90天。本報告未經本公司書面許可，不可部份複製。

This document is issued by the Company subject to its General Conditions of Service printed overleaf, available on request or accessible at www.sgs.com/terms_and_conditions.htm and, for electronic format documents, subject to Terms and Conditions for Electronic Documents at www.sgs.com/terms_e-document.htm. Attention is drawn to the limitation of liability, indemnification and jurisdiction issues defined therein. Any holder of this document is advised that information contained hereon reflects the Company's findings at the time of its intervention only and within the limits of Client's instructions, if any. The Company's sole responsibility is to its Client and this document does not exonerate parties to a transaction from exercising all their rights and obligations under the transaction documents. This document cannot be reproduced except in full, without prior written approval of the Company. Any unauthorized alteration, forgery or falsification of the content or appearance of this document is unlawful and offenders may be prosecuted to the fullest extent of the law.

SGS Taiwan Ltd.

No.134,WuKungRoad,NewTaipeiIndustrialPark,WukuDistrict,NewTaipeiCity,Taiwan24803/新北市五股區新北產業園區五工路 134 號

台灣檢驗科技股份有限公司

t (886-2) 2299-3279

f (886-2) 2298-0488

www.tw.sgs.com

Member of SGS Group

Revision History

Report Number	Revision	Description	Issue Date
ER/2017/60078-01	Rev.00	Initial creation of document	Aug. 24, 2017

Unless otherwise stated the results shown in this test report refer only to the sample(s) tested and such sample(s) are retained for 90 days only.

除非另有說明，此報告結果僅對測試之樣品負責，同時此樣品僅保留90天。本報告未經本公司書面許可，不可部份複製。

This document is issued by the Company subject to its General Conditions of Service printed overleaf, available on request or accessible at www.sgs.com/terms_and_conditions.htm and, for electronic format documents, subject to Terms and Conditions for Electronic Documents at www.sgs.com/terms_e-document.htm. Attention is drawn to the limitation of liability, indemnification and jurisdiction issues defined therein. Any holder of this document is advised that information contained hereon reflects the Company's findings at the time of its intervention only and within the limits of Client's instructions, if any. The Company's sole responsibility is to its Client and this document does not exonerate parties to a transaction from exercising all their rights and obligations under the transaction documents. This document cannot be reproduced except in full, without prior written approval of the Company. Any unauthorized alteration, forgery or falsification of the content or appearance of this document is unlawful and offenders may be prosecuted to the fullest extent of the law.

SGS Taiwan Ltd.

No.134,WuKungRoad,NewTaipeiIndustrialPark,WukuDistrict,NewTaipeiCity,Taiwan24803/新北市五股區新北產業園區五工路 134 號

台灣檢驗科技股份有限公司

t (886-2) 2299-3279

f (886-2) 2298-0488

www.tw.sgs.com

Member of SGS Group

Contents

1. GENERAL PRODUCT INFORMATION	5
2. SYSTEM TEST CONFIGURATION	8
3. SUMMARY OF TEST RESULTS	11
4. DESCRIPTION OF TEST MODES	12
5. MEASUREMENT UNCERTAINTY	13
6. RF CONDUCTED OUTPUT POWER MEASUREMENT	14
7. EFFECTIVE RADIATED POWER AND EQUIVALENT ISOTROPIC RADIATED POWER MEASUREMENT	16
8. OCCUPIED BANDWIDTH MEASUREMENT	24
9. OUT OF BAND EMISSION AT ANTENNA TERMINALS	30
10. FIELD STRENGTH OF SPURIOUS RADIATION MEASUREMENT	39
11. FREQUENCY STABILITY MEASUREMENT	49
12. PEAK TO AVERAGE RATIO	51
PHOTOGRAPHS OF EUT	55

Unless otherwise stated the results shown in this test report refer only to the sample(s) tested and such sample(s) are retained for 90 days only.

除非另有說明，此報告結果僅對測試之樣品負責，同時此樣品僅保留90天。本報告未經本公司書面許可，不可部份複製。

This document is issued by the Company subject to its General Conditions of Service printed overleaf, available on request or accessible at www.sgs.com/terms_and_conditions.htm and, for electronic format documents, subject to Terms and Conditions for Electronic Documents at www.sgs.com/terms_e-document.htm. Attention is drawn to the limitation of liability, indemnification and jurisdiction issues defined therein. Any holder of this document is advised that information contained hereon reflects the Company's findings at the time of its intervention only and within the limits of Client's instructions, if any. The Company's sole responsibility is to its Client and this document does not exonerate parties to a transaction from exercising all their rights and obligations under the transaction documents. This document cannot be reproduced except in full, without prior written approval of the Company. Any unauthorized alteration, forgery or falsification of the content or appearance of this document is unlawful and offenders may be prosecuted to the fullest extent of the law.

SGS Taiwan Ltd.

No.134,WuKungRoad,NewTaipeiIndustrialPark,WukuDistrict,NewTaipeiCity,Taiwan24803/新北市五股區新北產業園區五工路 134 號

台灣檢驗科技股份有限公司

t (886-2) 2299-3279

f (886-2) 2298-0488

www.tw.sgs.com

Member of SGS Group

1. GENERAL PRODUCT INFORMATION

1.1. Product Description

General:

Product Name:	Smart Phone	
Brand Name:	Nokia	
Model No.:	TA-1035	
Model difference:	N/A	
Hardware Version:	880	
Software Version:	V0.300	
USB Cable:	Model No.: CUBB01M-FA010-DH, Supplier: Nokia	
Headset:	Model No.: WH-108, Supplier: Nokia	
Power Supply:	3.85Vdc from Rechargeable Li-polymer Battery or 5 V from AC/DC Adapter	
	Battery:	Model No.:HE338, Supplier: Nokia
	Adapter:	Model No.: FC0102, Supplier: Nokia

LTE:

Cellular Phone Standards Frequency Range and Power	Operating Frequency	
	LTE-Band 5 (1.4MHz)	824.7MHz – 848.3MHz
	LTE-Band 5 (3MHz)	825.5MHz – 847.5MHz
	LTE-Band 5 (5MHz)	826.5MHz – 846.5MHz
	LTE-Band 5 (10MHz)	829.0MHz – 844.0MHz
IMEI:	356041080003357	

Type of Emission:

LTE Band	BW (MHz)	Modulation	Type of Emission
LTE Band 5	1.4MHz	QPSK	1M10G7D
LTE Band 5	1.4MHz	16QAM	1M10D7W
LTE Band 5	3MHz	QPSK	2M70G7D
LTE Band 5	3MHz	16QAM	2M70D7W
LTE Band 5	5MHz	QPSK	4M51G7D
LTE Band 5	5MHz	16QAM	4M51D7W
LTE Band 5	10MHz	QPSK	9M01G7D
LTE Band 5	10MHz	16QAM	8M97D7W

Unless otherwise stated the results shown in this test report refer only to the sample(s) tested and such sample(s) are retained for 90 days only.

除非另有說明，此報告結果僅對測試之樣品負責，同時此樣品僅保留90天。本報告未經本公司書面許可，不可部份複製。

This document is issued by the Company subject to its General Conditions of Service printed overleaf, available on request or accessible at www.sgs.com/terms_and_conditions.htm and, for electronic format documents, subject to Terms and Conditions for Electronic Documents at www.sgs.com/terms_e-document.htm. Attention is drawn to the limitation of liability, indemnification and jurisdiction issues defined therein. Any holder of this document is advised that information contained hereon reflects the Company's findings at the time of its intervention only and within the limits of Client's instructions, if any. The Company's sole responsibility is to its Client and this document does not exonerate parties to a transaction from exercising all their rights and obligations under the transaction documents. This document cannot be reproduced except in full, without prior written approval of the Company. Any unauthorized alteration, forgery or falsification of the content or appearance of this document is unlawful and offenders may be prosecuted to the fullest extent of the law.

SGS Taiwan Ltd.

No.134,WuKungRoad,NewTaipeiIndustrialPark,WukuDistrict,NewTaipeiCity,Taiwan24803/新北市五股區新北產業園區五工路 134 號

台灣檢驗科技股份有限公司

t (886-2) 2299-3279

f (886-2) 2298-0488

www.tw.sgs.com

Member of SGS Group

Max ERP/EIRP Power Measurement Result:

	dBm		W
LTE-Band 5 (Bandwidth 1.4MHz) QPSK	15.62	ERP	0.036
LTE-Band 5 (Bandwidth 1.4MHz) 16QAM	15.21	ERP	0.033
LTE-Band 5 (Bandwidth 3MHz) QPSK	15.42	ERP	0.035
LTE-Band 5 (Bandwidth 3MHz) 16QAM	15.48	ERP	0.035
LTE-Band 5 (Bandwidth 5MHz) QPSK	15.21	ERP	0.033
LTE-Band 5 (Bandwidth 5MHz) 16QAM	16.18	ERP	0.041
LTE-Band 5 (Bandwidth 10MHz) QPSK	14.94	ERP	0.031
LTE-Band 5 (Bandwidth 10MHz) 16QAM	15.89	ERP	0.039

Unless otherwise stated the results shown in this test report refer only to the sample(s) tested and such sample(s) are retained for 90 days only.

除非另有說明，此報告結果僅對測試之樣品負責，同時此樣品僅保留90天。本報告未經本公司書面許可，不可部份複製。

This document is issued by the Company subject to its General Conditions of Service printed overleaf, available on request or accessible at www.sgs.com/terms_and_conditions.htm and, for electronic format documents, subject to Terms and Conditions for Electronic Documents at www.sgs.com/terms_e-document.htm. Attention is drawn to the limitation of liability, indemnification and jurisdiction issues defined therein. Any holder of this document is advised that information contained hereon reflects the Company's findings at the time of its intervention only and within the limits of Client's instructions, if any. The Company's sole responsibility is to its Client and this document does not exonerate parties to a transaction from exercising all their rights and obligations under the transaction documents. This document cannot be reproduced except in full, without prior written approval of the Company. Any unauthorized alteration, forgery or falsification of the content or appearance of this document is unlawful and offenders may be prosecuted to the fullest extent of the law.

SGS Taiwan Ltd.

No.134,WuKungRoad,NewTaipeiIndustrialPark,WukuDistrict,NewTaipeiCity,Taiwan24803/新北市五股區新北產業園區五工路 134 號

台灣檢驗科技股份有限公司

t (886-2) 2299-3279

f (886-2) 2298-0488

www.tw.sgs.com

Member of SGS Group

1.2. Test Methodology of Applied Standards

FCC 47 CFR Part 2, 22.

ANSI / TIA / EIA 603-D-2010

KDB971168 D01 Power Meas license Digital System

TS 151 010-1 is used to set, and measure the output power.

Note: All test items have been performed and record as per the above standards.

1.3. Test Facility

SGS Taiwan Ltd. Electronics & Communication Laboratory No.134, Wu Kung Road, New Taipei Industrial Park, Wuku District, New Taipei City, Taiwan. (TAF code 0513)

FCC Registration Numbers are: 509634

1.4. Special Accessories

No special accessories were used during testing.

1.5. Equipment Modifications

There were no modifications incorporated into the EUT.

Unless otherwise stated the results shown in this test report refer only to the sample(s) tested and such sample(s) are retained for 90 days only.

除非另有說明，此報告結果僅對測試之樣品負責，同時此樣品僅保留90天。本報告未經本公司書面許可，不可部份複製。

This document is issued by the Company subject to its General Conditions of Service printed overleaf, available on request or accessible at www.sgs.com/terms_and_conditions.htm and, for electronic format documents, subject to Terms and Conditions for Electronic Documents at www.sgs.com/terms_e-document.htm. Attention is drawn to the limitation of liability, indemnification and jurisdiction issues defined therein. Any holder of this document is advised that information contained hereon reflects the Company's findings at the time of its intervention only and within the limits of Client's instructions, if any. The Company's sole responsibility is to its Client and this document does not exonerate parties to a transaction from exercising all their rights and obligations under the transaction documents. This document cannot be reproduced except in full, without prior written approval of the Company. Any unauthorized alteration, forgery or falsification of the content or appearance of this document is unlawful and offenders may be prosecuted to the fullest extent of the law.

SGS Taiwan Ltd.

No.134,WuKungRoad,NewTaipeiIndustrialPark,WukuDistrict,NewTaipeiCity,Taiwan24803/新北市五股區新北產業園區五工路 134 號

台灣檢驗科技股份有限公司

t (886-2) 2299-3279

f (886-2) 2298-0488

www.tw.sgs.com

Member of SGS Group

2. SYSTEM TEST CONFIGURATION

2.1. EUT Configuration

The EUT configuration for testing is installed on RF field strength measurement to meet the Commissions requirement and operating in a manner which intends to maximize its emission characteristics in a continuous normal application.

2.2. EUT Exercise

The EUT (Transmitter) was operated in the continuous transmission mode employed with the simulator of the Base Station that fixates at test default channels to fix the Tx frequency which was for the purpose of the measurements.

2.3. Test Procedure

2.3.1 Conducted Measurement at Antenna Port

According to measurement procured TIA/EIA 603-D, the EUT is placed on a turn table which is 0.8 m above ground plane. A low loss of RF cable was used to connect the antenna port of EUT to measurement equipment.

2.3.2 Radiated Emissions (ERP/EIRP)

According to measurement procedure TIA/EIA 603-D, The EUT is placed on a turn table which is 0.8 m above ground plane. The turn table shall rotate 360 degrees to determine the position of maximum emission level. EUT is set 3m away from the receiving antenna which varied from 1m to 4m to find out the highest emission. And also, each emission was to be maximized by changing the polarization of receiving antenna both Horizontal and Vertical. In order to find out the max. emission, the relative positions of this hand-held transmitter (EUT) was rotated through three orthogonal axes and measurement procedures for electric field radiated emissions above 1 GHz the EUT measurement is to be made "while keeping the antenna in the 'cone of radiation' from that area and pointed at the area both in azimuth and elevation, with polarization oriented for maximum response." is still within the 3dB illumination BW of the measurement antenna according to the requirements in Section 8 and 13.

Unless otherwise stated the results shown in this test report refer only to the sample(s) tested and such sample(s) are retained for 90 days only.

除非另有說明，此報告結果僅對測試之樣品負責，同時此樣品僅保留90天。本報告未經本公司書面許可，不可部份複製。

This document is issued by the Company subject to its General Conditions of Service printed overleaf, available on request or accessible at www.sgs.com/terms_and_conditions.htm and, for electronic format documents, subject to Terms and Conditions for Electronic Documents at www.sgs.com/terms_e-document.htm. Attention is drawn to the limitation of liability, indemnification and jurisdiction issues defined therein. Any holder of this document is advised that information contained hereon reflects the Company's findings at the time of its intervention only and within the limits of Client's instructions, if any. The Company's sole responsibility is to its Client and this document does not exonerate parties to a transaction from exercising all their rights and obligations under the transaction documents. This document cannot be reproduced except in full, without prior written approval of the Company. Any unauthorized alteration, forgery or falsification of the content or appearance of this document is unlawful and offenders may be prosecuted to the fullest extent of the law.

SGS Taiwan Ltd.

No.134,WuKungRoad,NewTaipeiIndustrialPark,WukuDistrict,NewTaipeiCity,Taiwan24803/新北市五股區新北產業園區五工路134號

台灣檢驗科技股份有限公司

t (886-2) 2299-3279

f (886-2) 2298-0488

www.tw.sgs.com

Member of SGS Group

2.4. Measurement Results Explanation Example

For all conducted test items:

The offset level is set in the spectrum analyzer to compensate the RF cable loss and attenuation factor between EUT conducted port and spectrum analyzer. With the offset compensation, the spectrum analyzer reading level is exactly EUT RF output level.

Note:

The spectrum analyzer offset is derived from RF cable loss and attenuator factor.

Following shows an offset computation example with cable loss 1 dB for low band and 1 for high band with 10 dB attenuator and 3.2 splitter.

$$\text{Offset} = \text{RF cable loss (dB)} + \text{attenuation factor(dB)} = 3.8 + 10 = 13.8(\text{dB})$$

2.5. Final Amplifier Voltage and Current Information:

LTE Band 5

Test mode	DC voltage (V)	DC current (mA)
LTE Band 5_1.4M QPSK	3.85	719
LTE Band 5_1.4M 16QAM	3.85	678
LTE Band 5_3M QPSK	3.85	733
LTE Band 5_3M 16QAM	3.85	654
LTE Band 5_5M QPSK	3.85	759
LTE Band 5_5M 16QAM	3.85	681
LTE Band 5_10M QPSK	3.85	724
LTE Band 5_10M 16QAM	3.85	692

Unless otherwise stated the results shown in this test report refer only to the sample(s) tested and such sample(s) are retained for 90 days only.

除非另有說明，此報告結果僅對測試之樣品負責，同時此樣品僅保留90天。本報告未經本公司書面許可，不可部份複製。

This document is issued by the Company subject to its General Conditions of Service printed overleaf, available on request or accessible at www.sgs.com/terms_and_conditions.htm and, for electronic format documents, subject to Terms and Conditions for Electronic Documents at www.sgs.com/terms_e-document.htm. Attention is drawn to the limitation of liability, indemnification and jurisdiction issues defined therein. Any holder of this document is advised that information contained hereon reflects the Company's findings at the time of its intervention only and within the limits of Client's instructions, if any. The Company's sole responsibility is to its Client and this document does not exonerate parties to a transaction from exercising all their rights and obligations under the transaction documents. This document cannot be reproduced except in full, without prior written approval of the Company. Any unauthorized alteration, forgery or falsification of the content or appearance of this document is unlawful and offenders may be prosecuted to the fullest extent of the law.

SGS Taiwan Ltd.

No.134,WuKungRoad,NewTaipeiIndustrialPark,WukuDistrict,NewTaipeiCity,Taiwan24803/新北市五股區新北產業園區五工路 134 號

台灣檢驗科技股份有限公司

t (886-2) 2299-3279

f (886-2) 2298-0488

www.tw.sgs.com

Member of SGS Group

2.6. Configuration of Tested System

Fig. 2-1 Configuration of Tested System (Fixed Channel-Conducted)

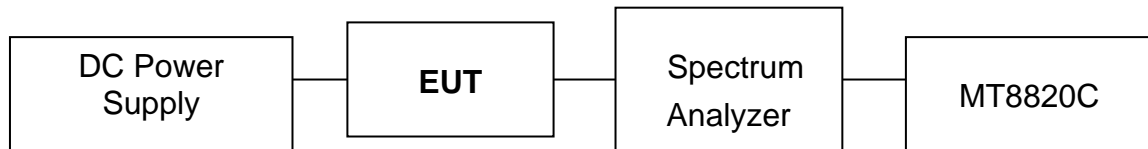

Fig. 2-2 Configuration of Tested System (Fixed Channel-Radiated)

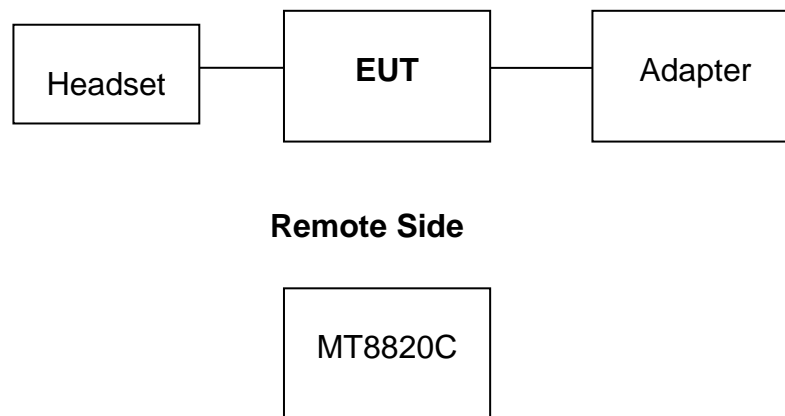

Table 2-1 Equipment Used in

Item	Equipment	Mfr/Brand	Model/ Type No.	Series No.	Data Cable	Power Cord
1.	Universal Radio Communication Tester	Anritsu	MT8820C	6200307563	shielded	Un-shielded

Unless otherwise stated the results shown in this test report refer only to the sample(s) tested and such sample(s) are retained for 90 days only.

除非另有說明，此報告結果僅對測試之樣品負責，同時此樣品僅保留90天。本報告未經本公司書面許可，不可部份複製。

This document is issued by the Company subject to its General Conditions of Service printed overleaf, available on request or accessible at www.sgs.com/terms_and_conditions.htm and, for electronic format documents, subject to Terms and Conditions for Electronic Documents at www.sgs.com/terms_e-document.htm. Attention is drawn to the limitation of liability, indemnification and jurisdiction issues defined therein. Any holder of this document is advised that information contained hereon reflects the Company's findings at the time of its intervention only and within the limits of Client's instructions, if any. The Company's sole responsibility is to its Client and this document does not exonerate parties to a transaction from exercising all their rights and obligations under the transaction documents. This document cannot be reproduced except in full, without prior written approval of the Company. Any unauthorized alteration, forgery or falsification of the content or appearance of this document is unlawful and offenders may be prosecuted to the fullest extent of the law.

SGS Taiwan Ltd.

No.134,WuKungRoad,NewTaipeiIndustrialPark,WukuDistrict,NewTaipeiCity,Taiwan24803/新北市五股區新北產業園區五工路 134 號

台灣檢驗科技股份有限公司

t (886-2) 2299-3279

f (886-2) 2298-0488

www.tw.sgs.com

Member of SGS Group

3. SUMMARY OF TEST RESULTS

FCC Rules	Description Of Test	Result
§2.1046	RF Power Output	Compliant
§2.1046(a) §22.913(a)(5)	ERP measurement	Compliant
§2.1049(h)	99% & 26dB Oc- cupied Bandwidth	Compliant
§2.1051 §22.917(a)	Out of Band Emissions at Antenna Terminals and Band Edge / Emission mask requirements	Compliant
§2.1053 §22.917(a)	Field Strength of Spu- rious Radiation	Compliant
§24.232(d) §27.50(b)	Peak to Average Ratio	Compliant
§2.1055(a)(1) §22.355	Frequency Stability	Compliant

Unless otherwise stated the results shown in this test report refer only to the sample(s) tested and such sample(s) are retained for 90 days only.

除非另有說明，此報告結果僅對測試之樣品負責，同時此樣品僅保留90天。本報告未經本公司書面許可，不可部份複製。

This document is issued by the Company subject to its General Conditions of Service printed overleaf, available on request or accessible at www.sgs.com/terms_and_conditions.htm and, for electronic format documents, subject to Terms and Conditions for Electronic Documents at www.sgs.com/terms_e-document.htm. Attention is drawn to the limitation of liability, indemnification and jurisdiction issues defined therein. Any holder of this document is advised that information contained hereon reflects the Company's findings at the time of its intervention only and within the limits of Client's instructions, if any. The Company's sole responsibility is to its Client and this document does not exonerate parties to a transaction from exercising all their rights and obligations under the transaction documents. This document cannot be reproduced except in full, without prior written approval of the Company. Any unauthorized alteration, forgery or falsification of the content or appearance of this document is unlawful and offenders may be prosecuted to the fullest extent of the law.

SGS Taiwan Ltd.

No.134,WuKungRoad,NewTaipeiIndustrialPark,WukuDistrict,NewTaipeiCity,Taiwan24803/新北市五股區新北產業園區五工路 134 號

台灣檢驗科技股份有限公司

t (886-2) 2299-3279

f (886-2) 2298-0488

www.tw.sgs.com

Member of SGS Group

4. DESCRIPTION OF TEST MODES

4.1. The Worst Test Modes and Channel Details

1. The EUT has been tested under operating condition.
2. Pre-Scan has been conducted to determine the worst-case mode from all possible combinations between available modulations, data rates, X(E1)Y(E2)Z(H) axis and antenna ports. The worst case was found as listed below. Following channel(s) was (were) selected for the final test as listed below:

BAND	ERP	RADIATED EMISSION and Wireless charging Cover
LTE Band 5	E2-plan	E2-plan

LTE Band 5 MODE

TEST ITEM	AVAILABLE CHANNEL	TESTED CHANNEL	CHANNEL BANDWIDTH	MODULATION	MODE
ERP	20407 to 20643	20407, 20525, 20643	1.4MHz	QPSK, 16QAM	1 RB/ 0,5 RB Offest
	20415 to 20635	20415, 20525, 20635	3MHz	QPSK, 16QAM	1 RB/ 0,14 RB Offest
	20425 to 20625	20425, 20525, 20625	5MHz	QPSK, 16QAM	1 RB/ 0,24 RB Offest
	20450 to 20600	20450, 20525, 20600	10MHz	QPSK, 16QAM	1 RB/ 0,49 RB Offest
FREQUENCY STABILITY	20450 to 20600	20525	10MHz	QPSK,	Full RB
OCCUPIED BANDWIDTH	20407 to 20643	20407, 20525, 20643	1.4MHz	QPSK, 16QAM	Full RB
	20415 to 20635	20415, 20525, 20635	3MHz	QPSK, 16QAM	Full RB
	20425 to 20625	20425, 20525, 20625	5MHz	QPSK, 16QAM	Full RB
	20450 to 20600	20450, 20525, 20600	10MHz	QPSK, 16QAM	Full RB
PEAK TO AVERAGE RATIO	20407 to 20643	20407, 20525, 20643	1.4MHz	16QAM	Full RB
	20415 to 20635	20415, 20525, 20635	3MHz	16QAM	Full RB
	20425 to 20625	20425, 20525, 20625	5MHz	16QAM	Full RB
	20450 to 20600	20450, 20525, 20600	10MHz	16QAM	Full RB
BAND EDGE	20407 to 20643	20407, 20643	1.4MHz	QPSK,	1 RB/ 0,5 RB Offes Full RB
	20415 to 20635	20415, 20635	3MHz	QPSK,	1 RB/ 0,14 RB Offest Full RB
	20425 to 20625	20425, 20625	5MHz	QPSK,	1 RB/ 0,24 RB Offest Full RB
	20450 to 20600	20450, 20600	10MHz	QPSK,	1 RB/ 0,49 RB Offest Full RB
CONDCUDED EMISSION	20407 to 20643	20407, 20525, 20643	1.4MHz	QPSK,	1 RB, 0 RB Offest
	20415 to 20635	20415, 20525, 20635	3MHz	QPSK,	1 RB, 0 RB Offest
	20425 to 20625	20425, 20525, 20625	5MHz	QPSK,	1 RB, 0 RB Offest
	20450 to 20600	20450, 20525, 20600	10MHz	QPSK,	1 RB, 0 RB Offest
RADIATED EMISSION	20425 to 20625	20425, 20525, 20625	5MHz	16QAM	1 RB/ 0 RB Offest

Unless otherwise stated the results shown in this test report refer only to the sample(s) tested and such sample(s) are retained for 90 days only.

除非另有說明，此報告結果僅對測試之樣品負責，同時此樣品僅保留90天。本報告未經本公司書面許可，不可部份複製。

This document is issued by the Company subject to its General Conditions of Service printed overleaf, available on request or accessible at www.sgs.com/terms_and_conditions.htm and, for electronic format documents, subject to Terms and Conditions for Electronic Documents at www.sgs.com/terms_e-document.htm. Attention is drawn to the limitation of liability, indemnification and jurisdiction issues defined therein. Any holder of this document is advised that information contained hereon reflects the Company's findings at the time of its intervention only and within the limits of Client's instructions, if any. The Company's sole responsibility is to its Client and this document does not exonerate parties to a transaction from exercising all their rights and obligations under the transaction documents. This document cannot be reproduced except in full, without prior written approval of the Company. Any unauthorized alteration, forgery or falsification of the content or appearance of this document is unlawful and offenders may be prosecuted to the fullest extent of the law.

SGS Taiwan Ltd.

No.134,WuKungRoad,NewTaipeiIndustrialPark,WukuDistrict,NewTaipeiCity,Taiwan24803/新北市五股區新北產業園區五工路 134 號

台灣檢驗科技股份有限公司

t (886-2) 2299-3279

f (886-2) 2298-0488

www.tw.sgs.com

Member of SGS Group

5. MEASUREMENT UNCERTAINTY

Test Items	Uncertainty
RF Power Output	+/- 1.10 dB
ERP/ EIRP measurement	Vertical Polarization = +/- 4.74dB Horizontal Polarization = +/- 4.62dB
99% Occupied Bandwidth	+/- 5.19 Hz
Out of Band Emissions at Antenna Terminals and Band Edge	+/- 0.70 dB
Peak to Average Ratio	+/- 0.70 dB
Frequency Stability vs. Temperature	+/- 5.19 Hz
Frequency Stability vs. Voltage	+/- 5.19 Hz
Temperature	+/- 0.65 °C
Humidity	+/- 4.6 %
DC / AC Power Source	DC= +/- 0.13%, AC= +/- 0.2%

Radiated Spurious Emission:

Measurement uncertainty (Polarization : Vertical)	9kHz – 30MHz: +/- 2.87 dB
	30MHz - 180MHz: +/- 3.37dB
	180MHz -417MHz: +/- 3.19dB
	0.417GHz-1GHz: +/- 3.19dB
	1GHz - 18GHz: +/- 4.04dB
	18GHz - 40GHz: +/- 4.04dB

Measurement uncertainty (Polarization : Horizontal)	9kHz – 30MHz: +/- 2.87 dB
	30MHz - 167MHz: +/- 4.22dB
	167MHz -500MHz: +/- 3.44dB
	0.5GHz-1GHz: +/- 3.39dB
	1GHz - 18GHz: +/- 4.08dB
	18GHz - 40GHz: +/- 4.08dB

This uncertainty represents an expanded uncertainty expressed at approximately the 95% confidence level using a coverage factor of k=2.

Unless otherwise stated the results shown in this test report refer only to the sample(s) tested and such sample(s) are retained for 90 days only.

除非另有說明，此報告結果僅對測試之樣品負責，同時此樣品僅保留90天。本報告未經本公司書面許可，不可部份複製。

This document is issued by the Company subject to its General Conditions of Service printed overleaf, available on request or accessible at www.sgs.com/terms_and_conditions.htm and, for electronic format documents, subject to Terms and Conditions for Electronic Documents at www.sgs.com/terms_e-document.htm. Attention is drawn to the limitation of liability, indemnification and jurisdiction issues defined therein. Any holder of this document is advised that information contained hereon reflects the Company's findings at the time of its intervention only and within the limits of Client's instructions, if any. The Company's sole responsibility is to its Client and this document does not exonerate parties to a transaction from exercising all their rights and obligations under the transaction documents. This document cannot be reproduced except in full, without prior written approval of the Company. Any unauthorized alteration, forgery or falsification of the content or appearance of this document is unlawful and offenders may be prosecuted to the fullest extent of the law.

6. RF CONDUCTED OUTPUT POWER MEASUREMENT

6.1. Standard Applicable

A base station simulator was used to establish communication with the EUT. Its parameters were set to transmit the maximum power on the EUT. The measured power in the radio frequency on the transmitter output terminals.

6.2. Test Set-up

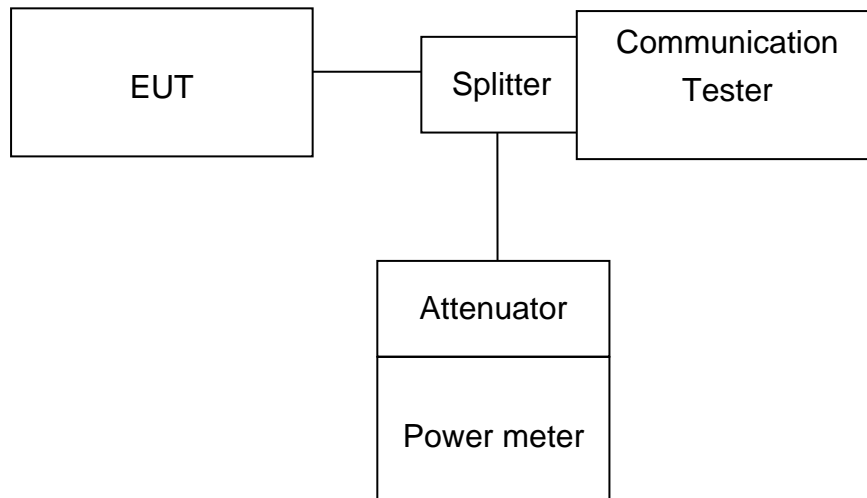

Note: Measurement setup for testing on Antenna connector

6.3. Measurement Procedure

The transmitter output was connected to a calibrated attenuator, the other end of which was connected to a power meter. Transmitter output was read off the power meter in dBm. The power output at the transmitter antenna port was determined by adding the value of the attenuator to the power meter reading. TS 151 010-1 is reference to conduct the test measurement of output power.

The Procedure of KDB 971168 D01 Power Meas License Digital System as the supplemental test methodology to adjust the proper setting obtaining the measurement results

Unless otherwise stated the results shown in this test report refer only to the sample(s) tested and such sample(s) are retained for 90 days only.

除非另有說明，此報告結果僅對測試之樣品負責，同時此樣品僅保留90天。本報告未經本公司書面許可，不可部份複製。

This document is issued by the Company subject to its General Conditions of Service printed overleaf, available on request or accessible at www.sgs.com/terms_and_conditions.htm and, for electronic format documents, subject to Terms and Conditions for Electronic Documents at www.sgs.com/terms_e-document.htm. Attention is drawn to the limitation of liability, indemnification and jurisdiction issues defined therein. Any holder of this document is advised that information contained hereon reflects the Company's findings at the time of its intervention only and within the limits of Client's instructions, if any. The Company's sole responsibility is to its Client and this document does not exonerate parties to a transaction from exercising all their rights and obligations under the transaction documents. This document cannot be reproduced except in full, without prior written approval of the Company. Any unauthorized alteration, forgery or falsification of the content or appearance of this document is unlawful and offenders may be prosecuted to the fullest extent of the law.

SGS Taiwan Ltd.

No.134,WuKungRoad,NewTaipeiIndustrialPark,WukuDistrict,NewTaipeiCity,Taiwan24803/新北市五股區新北產業園區五工路 134 號

台灣檢驗科技股份有限公司

t (886-2) 2299-3279

f (886-2) 2298-0488

www.tw.sgs.com

Member of SGS Group

6.4. Measurement Equipment Used

Conducted Emission (measured at antenna port) Test Site					
EQUIPMENT TYPE	MFR	MODEL NUMBER	SERIAL NUMBER	LAST CAL.	CAL DUE.
Power Meter	Anritsu	ML2495A	1005007	12/15/2016	12/14/2017
Power Sensor	Anritsu	MA2411B	917032	12/15/2016	12/14/2017
EXA Spectrum Analyzer	Agilent	N9030A	MY53120760	03/21/2017	03/20/2018
DC Block	Mini-Circuits	BLK-18-S+	1	01/05/2017	01/04/2018
Coaxial Cable	HUBER+SUHNER	SUCOFLEX 102	23670/2	01/05/2017	01/04/2018
Attenuator	Mini-Circuit	BW-S10W2+	2	01/05/2017	01/04/2018
Splitter	Agilent	11636B	N/A	01/05/2017	01/04/2018
DC Power Supply	Agilent	E3640A	MY52410006	11/21/2016	11/20/2017
Temperature Chamber	TERCHY	MHG-120LF	911009	05/19/2017	05/18/2018
Radio Communication Analyer	Anritsu	MT8820C	6201465317	01/03/2017	01/02/2018

6.5. Measurement Result

LTE Band 5 Uplink frequency band : 824 to 849 MHz								
BW (MHz)	RB Size	RB Offset	Conducted power(dBm)					
			QPSK			16QAM		
			Channel (Low) 20407	Channel (Mid) 20525	Channel (High) 20643	Channel (Low) 20407	Channel (Mid) 20525	Channel (High) 20643
1.4	1	0	23.12	23.03	23.30	22.51	21.89	22.57
	1	5	23.15	23.22	23.19	22.12	22.37	22.77
	3	2	22.81	22.90	22.83	21.82	21.97	21.97
	6	0	22.27	22.17	22.14	20.93	20.86	21.08

LTE Band 5 Uplink frequency band : 824 to 849 MHz								
BW (MHz)	RB Size	RB Offset	Conducted power(dBm)					
			QPSK			16QAM		
			Channel (Low) 20415	Channel (Mid) 20525	Channel (High) 20635	Channel (Low) 20415	Channel (Mid) 20525	Channel (High) 20635
3	1	0	23.41	23.18	23.50	22.48	22.55	22.77
	1	14	23.38	23.37	23.50	22.51	22.46	22.45
	8	4	22.27	22.16	22.33	20.95	21.12	21.26
	15	0	22.29	22.13	22.36	21.03	21.18	21.21

LTE Band 5 Uplink frequency band : 824 to 849 MHz								
BW (MHz)	RB Size	RB Offset	Conducted power(dBm)					
			QPSK			16QAM		
			Channel (Low) 20425	Channel (Mid) 20525	Channel (High) 20625	Channel (Low) 20425	Channel (Mid) 20525	Channel (High) 20625
5	1	0	23.05	23.18	23.19	22.34	22.39	22.69
	1	24	23.32	23.42	23.45	22.29	22.19	22.59
	12	6	22.28	22.21	22.23	21.28	21.06	21.23
	25	0	22.36	22.24	22.29	21.38	21.25	21.36

LTE Band 5 Uplink frequency band : 824 to 849 MHz								
BW (MHz)	RB Size	RB Offset	Conducted power(dBm)					
			QPSK			16QAM		
			Channel (Low) 20450	Channel (Mid) 20525	Channel (High) 20600	Channel (Low) 20450	Channel (Mid) 20525	Channel (High) 20600
10	1	0	23.27	23.33	23.34	22.47	22.81	22.73
	1	49	22.98	23.05	23.17	22.24	22.14	22.33
	25	12	22.39	22.18	22.42	21.33	21.24	21.55
	50	0	22.38	22.17	22.31	21.35	21.08	21.16

Unless otherwise stated the results shown in this test report refer only to the sample(s) tested and such sample(s) are retained for 90 days only.

除非另有說明，此報告結果僅對測試之樣品負責，同時此樣品僅保留90天。本報告未經本公司書面許可，不可部份複製。

This document is issued by the Company subject to its General Conditions of Service printed overleaf, available on request or accessible at www.sgs.com/terms_and_conditions.htm and, for electronic format documents, subject to Terms and Conditions for Electronic Documents at www.sgs.com/terms_e-document.htm. Attention is drawn to the limitation of liability, indemnification and jurisdiction issues defined therein. Any holder of this document is advised that information contained hereon reflects the Company's findings at the time of its intervention only and within the limits of Client's instructions, if any. The Company's sole responsibility is to its Client and this document does not exonerate parties to a transaction from exercising all their rights and obligations under the transaction documents. This document cannot be reproduced except in full, without prior written approval of the Company. Any unauthorized alteration, forgery or falsification of the content or appearance of this document is unlawful and offenders may be prosecuted to the fullest extent of the law.

7. EFFECTIVE RADIATED POWER AND EQUIVALENT ISOTROPIC RADIATED POWER MEASUREMENT

7.1. Standard Applicable

According to FCC §2.1046

FCC 22.913(a) Mobile station is limited to 7W ERP.

7.2. Test SET-UP

(A) Radiated Power Test Set-Up, Frequency Below 1000MHz

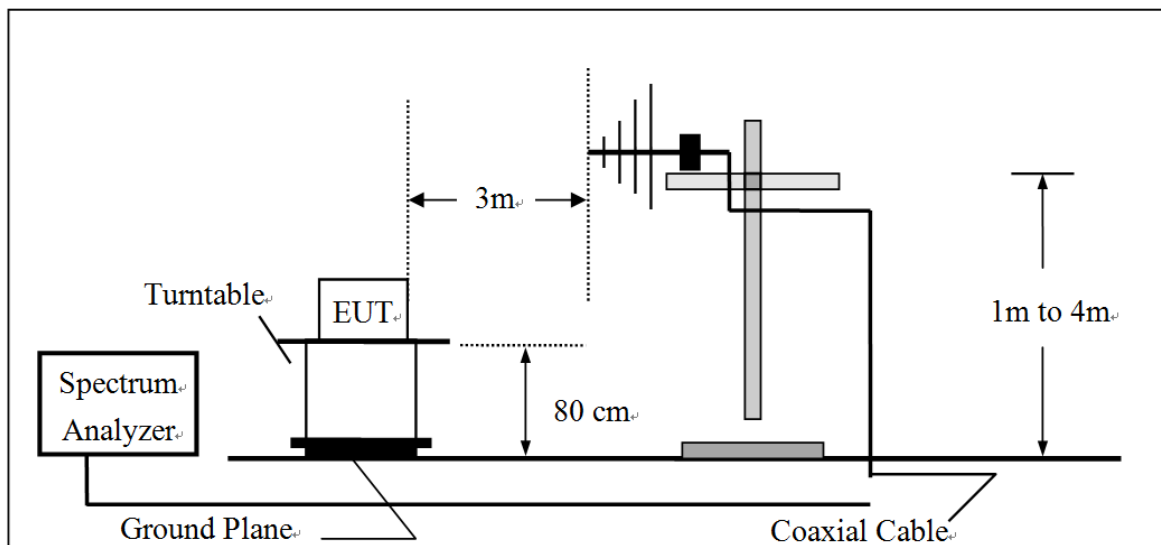

Unless otherwise stated the results shown in this test report refer only to the sample(s) tested and such sample(s) are retained for 90 days only.

除非另有說明，此報告結果僅對測試之樣品負責，同時此樣品僅保留90天。本報告未經本公司書面許可，不可部份複製。

This document is issued by the Company subject to its General Conditions of Service printed overleaf, available on request or accessible at www.sgs.com/terms_and_conditions.htm and, for electronic format documents, subject to Terms and Conditions for Electronic Documents at www.sgs.com/terms_e-document.htm. Attention is drawn to the limitation of liability, indemnification and jurisdiction issues defined therein. Any holder of this document is advised that information contained hereon reflects the Company's findings at the time of its intervention only and within the limits of Client's instructions, if any. The Company's sole responsibility is to its Client and this document does not exonerate parties to a transaction from exercising all their rights and obligations under the transaction documents. This document cannot be reproduced except in full, without prior written approval of the Company. Any unauthorized alteration, forgery or falsification of the content or appearance of this document is unlawful and offenders may be prosecuted to the fullest extent of the law.

SGS Taiwan Ltd.

No.134,WuKungRoad,NewTaipeiIndustrialPark,WukuDistrict,NewTaipeiCity,Taiwan24803/新北市五股區新北產業園區五工路 134 號

台灣檢驗科技股份有限公司

t (886-2) 2299-3279

f (886-2) 2298-0488

www.tw.sgs.com

Member of SGS Group

(B) Radiated Power Test Set-UP Frequency Over 1 GHz

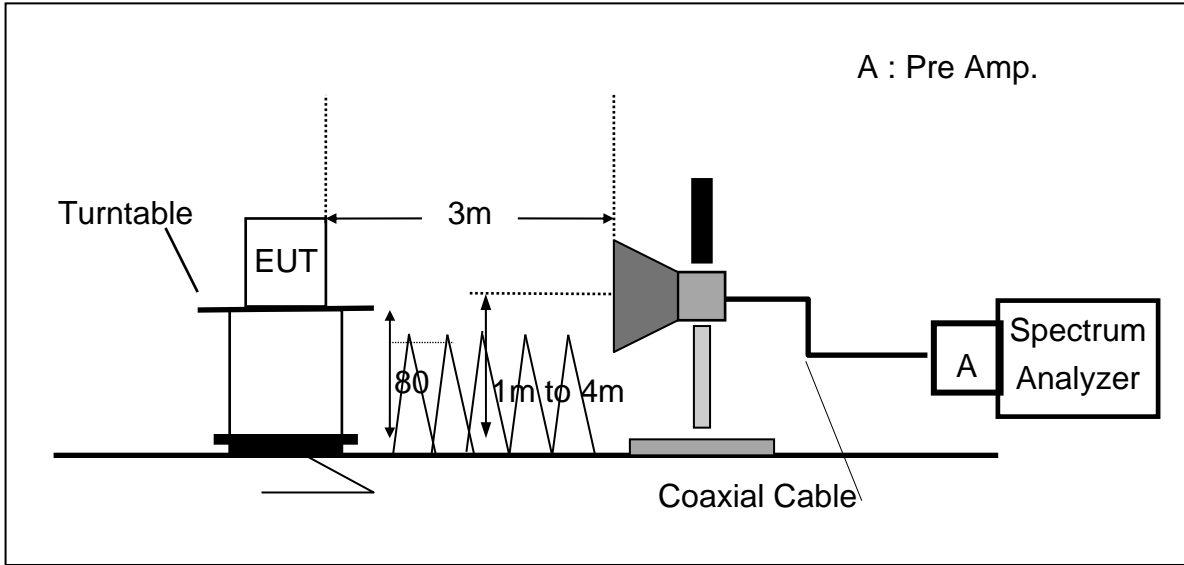

(C) Substituted Method Test Set-UP

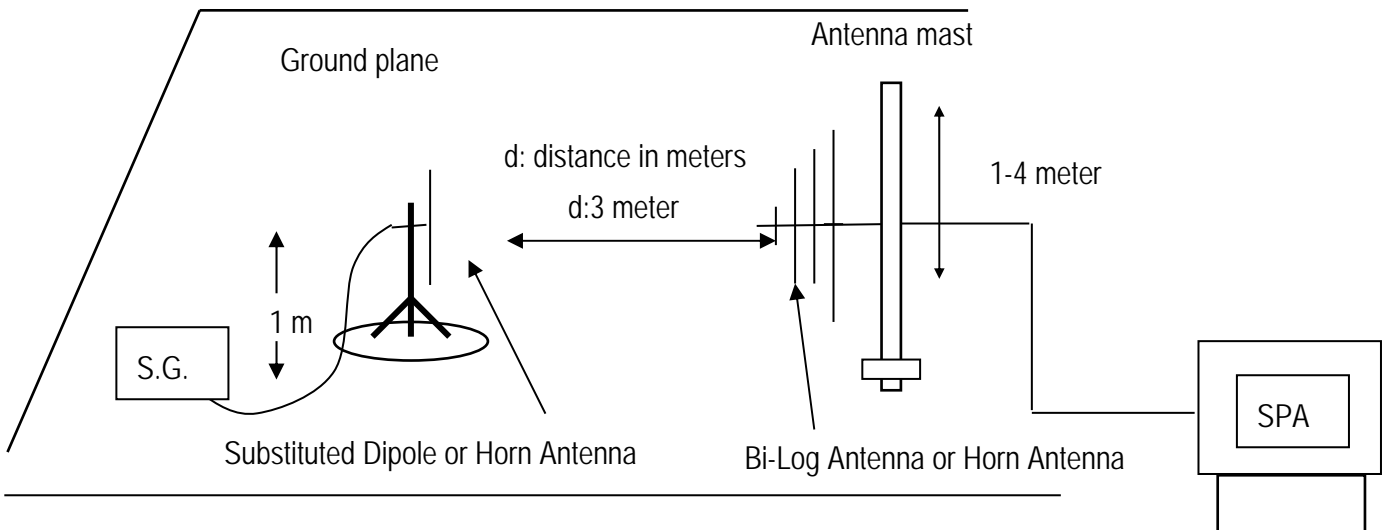

Unless otherwise stated the results shown in this test report refer only to the sample(s) tested and such sample(s) are retained for 90 days only.
除非另有說明，此報告結果僅對測試之樣品負責，同時此樣品僅保留90天。本報告未經本公司書面許可，不可部份複製。

This document is issued by the Company subject to its General Conditions of Service printed overleaf, available on request or accessible at www.sgs.com/terms_and_conditions.htm and, for electronic format documents, subject to Terms and Conditions for Electronic Documents at www.sgs.com/terms_e-document.htm. Attention is drawn to the limitation of liability, indemnification and jurisdiction issues defined therein. Any holder of this document is advised that information contained hereon reflects the Company's findings at the time of its intervention only and within the limits of Client's instructions, if any. The Company's sole responsibility is to its Client and this document does not exonerate parties to a transaction from exercising all their rights and obligations under the transaction documents. This document cannot be reproduced except in full, without prior written approval of the Company. Any unauthorized alteration, forgery or falsification of the content or appearance of this document is unlawful and offenders may be prosecuted to the fullest extent of the law.

7.3. Measurement Procedure

1. The testing follows the Measurement Procedure of FCC KDB 971168 D01
2. The EUT was placed on a non-conductive turntable using a non-conductive support. The radiated emission at the fundamental frequency was measured at 3 m with a test antenna and EMI spectrum analyzer.
3. During the measurement, the EUT was communication with the station. The highest emission was recorded with the rotation of the turntable and the lowering of the test antenna from 4m to 1m. The reading was recorded and the field strength (E in dBuV/m) was calculated
4. The testing follows the Measurement Procedure of FCC KDB 971168 D01
5. The substitution horn antenna is substituted for EUT at the same position and signals generator export the CW signal to the substitution antenna via a tx cable. Rotated the Turn Table and moved receiving antenna to find the maximum radiation power. Adjust output power level of S.G to get a Value of spectrum reading equal to "Read Value" of step b. Record the power level of S.G.
6. $ERP = S.G. \text{ output (dBm)} + \text{Antenna Gain (dBd)} - \text{Cable Loss (dB)}$
7. $EIRP = S.G. \text{ output (dBm)} + \text{Antenna Gain (dBi)} - \text{Cable Loss (dB)}$
8. Spectrum setting:
 - (1) Detector = Peak, marker the highest value of the detector by maximum hold, set RBW wide enough to capture the entire signal of emission, and $VBW \geq 3 \times RBW$.
 - (2) KDB 971168 D01 is adopted, and the procedure as lists under item 4, Measurement of the Average Power over the Fundamental Signal Bandwidth, is followed to set correspondingly for the acquisition of proper measurement data.Set frequency = nominal signal center frequency;
Set span = 2 X occupied BW;
Set RBW \approx 1~5% of the span, not to exceed 1 MHz
Set VBW = 3 x RBW;
Select average power (RMS) detector
Set sweep time and number of measurement points to achieve a minimum of 1 millisecond/pt integration time (ex. Point = 601points, then sweep time = $601 \times 10^{-3} = 6s$.)

Activate trace averaging routine over a minimum of 10 sweeps;

Activate marker/span pair and set span = signal or channel bandwidth;

Activate the band/interval power marker function;

Record the band power level;

Record adjusted value as the average signal power level. Then activate the occupied bandwidth measurement function.

The proper adjustment due to limitation of spectrum capability is given compensated to spectrum with conversion factor of $10 \times \log(TBW/RBW)$, where TBW is the transmission of UE exceeding the maximum BW UE can extends, and RBW is the resolution BW in UE.

Unless otherwise stated the results shown in this test report refer only to the sample(s) tested and such sample(s) are retained for 90 days only.

除非另有說明，此報告結果僅對測試之樣品負責，同時此樣品僅保留90天。本報告未經本公司書面許可，不可部份複製。

This document is issued by the Company subject to its General Conditions of Service printed overleaf, available on request or accessible at www.sgs.com/terms_and_conditions.htm and, for electronic format documents, subject to Terms and Conditions for Electronic Documents at www.sgs.com/terms_e-document.htm. Attention is drawn to the limitation of liability, indemnification and jurisdiction issues defined therein. Any holder of this document is advised that information contained hereon reflects the Company's findings at the time of its intervention only and within the limits of Client's instructions, if any. The Company's sole responsibility is to its Client and this document does not exonerate parties to a transaction from exercising all their rights and obligations under the transaction documents. This document cannot be reproduced except in full, without prior written approval of the Company. Any unauthorized alteration, forgery or falsification of the content or appearance of this document is unlawful and offenders may be prosecuted to the fullest extent of the law.

7.4. Measurement Equipment Used

ERP, EIRP MEASUREMENT EQUIPMENT List 966 Chamber					
EQUIPMENT TYPE	MFR	MODEL NUMBER	SERIAL NUMBER	LAST CAL.	CAL DUE.
EMI Test Receiver	R&S	ESCI7	100760	05/11/2017	05/10/2018
Spectrum Analyzer	Agilent	E4446A	MY51100003	04/25/2017	04/24/2018
Loop Antenna	ETS-Lindgren	6502	148045	09/20/2016	09/19/2017
Bilog Antenna	SCHWAZBECK	VULB9168	378	12/19/2016	12/18/2017
Horn Antenna	Schwarzbeck	BBHA9120D	1441	07/31/2017	07/30/2018
Pre-Amplifier	Agilent	8447D	2944A07676	01/05/2017	01/04/2018
Pre-Amplifier	EMC Instruments Corp.	EMC0126530	980038	01/05/2017	01/04/2018
Turn Table	HD	DT420	N/A	N.C.R	N.C.R
Antenna Tower	ChamPro	AM-BS-4500-B	060776-ABS	N.C.R	N.C.R
Controller	ChamPro	EM1000	60776	N.C.R	N.C.R
Low Loss Cable	Huber Suhner	966_RX	9	01/05/2017	01/04/2018
3m Site NSA	SGS	966 chamber	N/A	07/01/2017	06/30/2018
Low Loss Cable	Huber Suhner	966 TX	1	01/05/2017	01/04/2018
Horn Antenna	Schwarzbeck	BBHA9170	184	12/12/2016	12/11/2017
Pre-Amplifier	EMC Instruments Corp.	EMC184045	980135	01/05/2017	01/04/2018
Radio Communication Analyer	Anritsu	MT8820C	6201465317	01/03/2017	01/02/2018

Unless otherwise stated the results shown in this test report refer only to the sample(s) tested and such sample(s) are retained for 90 days only.

除非另有說明，此報告結果僅對測試之樣品負責，同時此樣品僅保留90天。本報告未經本公司書面許可，不可部份複製。

This document is issued by the Company subject to its General Conditions of Service printed overleaf, available on request or accessible at www.sgs.com/terms_and_conditions.htm and, for electronic format documents, subject to Terms and Conditions for Electronic Documents at www.sgs.com/terms_e-document.htm. Attention is drawn to the limitation of liability, indemnification and jurisdiction issues defined therein. Any holder of this document is advised that information contained hereon reflects the Company's findings at the time of its intervention only and within the limits of Client's instructions, if any. The Company's sole responsibility is to its Client and this document does not exonerate parties to a transaction from exercising all their rights and obligations under the transaction documents. This document cannot be reproduced except in full, without prior written approval of the Company. Any unauthorized alteration, forgery or falsification of the content or appearance of this document is unlawful and offenders may be prosecuted to the fullest extent of the law.

SGS Taiwan Ltd.

No.134,WuKungRoad,NewTaipeiIndustrialPark,WukuDistrict,NewTaipeiCity,Taiwan24803/新北市五股區新北產業園區五工路134號

台灣檢驗科技股份有限公司

t (886-2) 2299-3279

f (886-2) 2298-0488

www.tw.sgs.com

Member of SGS Group

7.5. Measurement Result: (Peak) –using option of peak measurement

EUT			Measurement					
Operation Band	Fundamental Frequency MHz	CH	Antenna Pol. V/H	S.G. Output dBm	Antenna Gain dBi	Cable Loss dB	ERP dBm	Limit dBm
BAND 5 BW: 1.4M QPSK RB: 1,0	824.7	20407	V	10.90	3.30	-2.93	11.27	38.45
			H	14.08	3.30	-2.93	14.45	38.45
	836.5	20525	V	11.73	3.29	-2.96	12.06	38.45
			H	15.29	3.29	-2.96	15.62	38.45
	848.3	20643	V	9.50	3.27	-2.99	9.78	38.45
			H	11.55	3.27	-2.99	11.83	38.45
BAND 5 BW: 1.4M QPSK RB: 1,5	824.7	20407	V	10.97	3.31	-2.92	11.36	38.45
			H	13.90	3.31	-2.92	14.29	38.45
	836.5	20525	V	11.72	3.29	-2.96	12.05	38.45
			H	13.84	3.29	-2.96	14.17	38.45
	848.3	20643	V	8.64	3.27	-3.00	8.91	38.45
			H	11.77	3.27	-3.00	12.04	38.45
BAND 5 BW: 1.4M 16QAM RB: 1,0	824.7	20407	V	11.95	3.30	-2.93	12.32	38.45
			H	14.07	3.30	-2.93	14.44	38.45
	836.5	20525	V	12.13	3.29	-2.96	12.46	38.45
			H	14.88	3.29	-2.96	15.21	38.45
	848.3	20643	V	10.45	3.27	-2.99	10.73	38.45
			H	12.01	3.27	-2.99	12.29	38.45
BAND 5 BW: 1.4M 16QAM RB: 1,5	824.7	20407	V	11.65	3.31	-2.92	12.04	38.45
			H	14.14	3.31	-2.92	14.53	38.45
	836.5	20525	V	11.81	3.29	-2.96	12.14	38.45
			H	14.68	3.29	-2.96	15.01	38.45
	848.3	20643	V	10.11	3.27	-3.00	10.38	38.45
			H	12.23	3.27	-3.00	12.50	38.45

The RBW,VBW of SPA for frequency RBW= 8MHz , VBW= 8MHz

Unless otherwise stated the results shown in this test report refer only to the sample(s) tested and such sample(s) are retained for 90 days only.

除非另有說明，此報告結果僅對測試之樣品負責，同時此樣品僅保留90天。本報告未經本公司書面許可，不可部份複製。

This document is issued by the Company subject to its General Conditions of Service printed overleaf, available on request or accessible at www.sgs.com/terms_and_conditions.htm and, for electronic format documents, subject to Terms and Conditions for Electronic Documents at www.sgs.com/terms_e-document.htm. Attention is drawn to the limitation of liability, indemnification and jurisdiction issues defined therein. Any holder of this document is advised that information contained hereon reflects the Company's findings at the time of its intervention only and within the limits of Client's instructions, if any. The Company's sole responsibility is to its Client and this document does not exonerate parties to a transaction from exercising all their rights and obligations under the transaction documents. This document cannot be reproduced except in full, without prior written approval of the Company. Any unauthorized alteration, forgery or falsification of the content or appearance of this document is unlawful and offenders may be prosecuted to the fullest extent of the law.

SGS Taiwan Ltd.

No.134,WuKungRoad,NewTaipeiIndustrialPark,WukuDistrict,NewTaipeiCity,Taiwan24803/新北市五股區新北產業園區五工路 134 號

台灣檢驗科技股份有限公司

t (886-2) 2299-3279

f (886-2) 2298-0488

www.tw.sgs.com

Member of SGS Group

EUT			Measurement					
Operation Band	Fundamental Frequency MHz	CH	Antenna Pol. V/H	S.G. Output dBm	Antenna Gain dBi	Cable Loss dB	ERP dBm	Limit dBm
BAND 5 BW: 3M QPSK RB: 1,0	825.5	20415	V	10.63	3.30	-2.93	11.00	38.45
			H	13.88	3.30	-2.93	14.25	38.45
	836.5	20525	V	11.29	3.29	-2.95	11.63	38.45
			H	15.08	3.29	-2.95	15.42	38.45
	847.5	20635	V	8.42	3.28	-2.99	8.71	38.45
			H	11.56	3.28	-2.99	11.85	38.45
BAND 5 BW: 3M QPSK RB: 1,14	825.5	20415	V	9.98	3.30	-2.93	10.35	38.45
			H	13.62	3.30	-2.93	13.99	38.45
	836.5	20525	V	10.57	3.29	-2.96	10.90	38.45
			H	14.68	3.29	-2.96	15.01	38.45
	847.5	20635	V	8.87	3.27	-3.00	9.14	38.45
			H	11.54	3.27	-3.00	11.81	38.45
BAND 5 BW: 3M 16QAM RB: 1,0	825.5	20415	V	11.26	3.30	-2.93	11.63	38.45
			H	14.67	3.30	-2.93	15.04	38.45
	836.5	20525	V	12.00	3.29	-2.95	12.34	38.45
			H	15.15	3.29	-2.96	15.48	38.45
	847.5	20635	V	9.75	3.28	-2.99	10.04	38.45
			H	12.27	3.28	-2.99	12.56	38.45
BAND 5 BW: 3M 16QAM RB: 1,14	825.5	20415	V	11.56	3.30	-2.93	11.93	38.45
			H	14.15	3.30	-2.93	14.52	38.45
	836.5	20525	V	11.38	3.29	-2.96	11.71	38.45
			H	14.59	3.29	-2.96	14.92	38.45
	847.5	20635	V	9.54	3.27	-3.00	9.81	38.45
			H	11.80	3.27	-3.00	12.07	38.45

The RBW,VBW of SPA for frequency RBW= 8MHz , VBW= 8MHz

Unless otherwise stated the results shown in this test report refer only to the sample(s) tested and such sample(s) are retained for 90 days only.

除非另有說明，此報告結果僅對測試之樣品負責，同時此樣品僅保留90天。本報告未經本公司書面許可，不可部份複製。

This document is issued by the Company subject to its General Conditions of Service printed overleaf, available on request or accessible at www.sgs.com/terms_and_conditions.htm and, for electronic format documents, subject to Terms and Conditions for Electronic Documents at www.sgs.com/terms_e-document.htm. Attention is drawn to the limitation of liability, indemnification and jurisdiction issues defined therein. Any holder of this document is advised that information contained hereon reflects the Company's findings at the time of its intervention only and within the limits of Client's instructions, if any. The Company's sole responsibility is to its Client and this document does not exonerate parties to a transaction from exercising all their rights and obligations under the transaction documents. This document cannot be reproduced except in full, without prior written approval of the Company. Any unauthorized alteration, forgery or falsification of the content or appearance of this document is unlawful and offenders may be prosecuted to the fullest extent of the law.

SGS Taiwan Ltd.

No.134,WuKungRoad,NewTaipeiIndustrialPark,WukuDistrict,NewTaipeiCity,Taiwan24803/新北市五股區新北產業園區五工路 134 號

台灣檢驗科技股份有限公司

t (886-2) 2299-3279

f (886-2) 2298-0488

www.tw.sgs.com

Member of SGS Group

EUT			Measurement					
Operation Band	Fundamental Frequency MHz	CH	Antenna Pol. V/H	S.G. Output dBm	Antenna Gain dBi	Cable Loss dB	ERP dBm	Limit dBm
BAND 5 BW: 5M QPSK RB: 1,0	826.5	20425	V	10.10	3.30	-2.93	10.47	38.45
			H	14.84	3.30	-2.93	15.21	38.45
	836.5	20525	V	11.24	3.29	-2.95	11.58	38.45
			H	14.63	3.29	-2.95	14.97	38.45
	846.5	20625	V	9.77	3.28	-2.98	10.07	38.45
			H	12.88	3.28	-2.98	13.18	38.45
BAND 5 BW: 5M QPSK RB: 1,24	826.5	20425	V	11.08	3.30	-2.93	11.45	38.45
			H	14.59	3.30	-2.93	14.96	38.45
	836.5	20525	V	9.78	3.29	-2.97	10.10	38.45
			H	13.18	3.29	-2.96	13.51	38.45
	846.5	20625	V	9.39	3.27	-3.00	9.66	38.45
			H	12.32	3.27	-3.00	12.59	38.45
BAND 5 BW: 5M 16QAM RB: 1,0	826.5	20425	V	11.04	3.30	-2.93	11.41	38.45
			H	14.78	3.30	-2.93	15.15	38.45
	836.5	20525	V	11.88	3.29	-2.95	12.22	38.45
			H	15.84	3.29	-2.95	16.18	38.45
	846.5	20625	V	9.61	3.28	-2.98	9.91	38.45
			H	12.99	3.28	-2.98	13.29	38.45
BAND 5 BW: 5M 16QAM RB: 1,24	826.5	20425	V	10.77	3.30	-2.93	11.14	38.45
			H	14.64	3.30	-2.93	15.01	38.45
	836.5	20525	V	11.39	3.29	-2.96	11.72	38.45
			H	14.59	3.29	-2.96	14.92	38.45
	846.5	20625	V	10.15	3.27	-3.00	10.42	38.45
			H	13.49	3.27	-3.00	13.76	38.45

The RBW,VBW of SPA for frequency RBW= 8MHz , VBW= 8MHz

Unless otherwise stated the results shown in this test report refer only to the sample(s) tested and such sample(s) are retained for 90 days only.

除非另有說明，此報告結果僅對測試之樣品負責，同時此樣品僅保留90天。本報告未經本公司書面許可，不可部份複製。

This document is issued by the Company subject to its General Conditions of Service printed overleaf, available on request or accessible at www.sgs.com/terms_and_conditions.htm and, for electronic format documents, subject to Terms and Conditions for Electronic Documents at www.sgs.com/terms_e-document.htm. Attention is drawn to the limitation of liability, indemnification and jurisdiction issues defined therein. Any holder of this document is advised that information contained hereon reflects the Company's findings at the time of its intervention only and within the limits of Client's instructions, if any. The Company's sole responsibility is to its Client and this document does not exonerate parties to a transaction from exercising all their rights and obligations under the transaction documents. This document cannot be reproduced except in full, without prior written approval of the Company. Any unauthorized alteration, forgery or falsification of the content or appearance of this document is unlawful and offenders may be prosecuted to the fullest extent of the law.

SGS Taiwan Ltd.

No.134,WuKungRoad,NewTaipeiIndustrialPark,WukuDistrict,NewTaipeiCity,Taiwan24803/新北市五股區新北產業園區五工路 134 號

台灣檢驗科技股份有限公司

t (886-2) 2299-3279

f (886-2) 2298-0488

www.tw.sgs.com

Member of SGS Group

EUT			Measurement					
Operation Band	Fundamental Frequency MHz	CH	Antenna Pol. V/H	S.G. Output dBm	Antenna Gain dBi	Cable Loss dB	ERP dBm	Limit dBm
BAND 5 BW: 10M QPSK RB: 1,0	829.0	20450	V	10.55	3.30	-2.93	10.92	38.45
			H	14.26	3.30	-2.93	14.63	38.45
	836.5	20525	V	11.36	3.30	-2.94	11.72	38.45
			H	14.58	3.30	-2.94	14.94	38.45
	844.0	20600	V	10.40	3.29	-2.97	10.72	38.45
			H	12.77	3.29	-2.97	13.09	38.45
BAND 5 BW: 10M QPSK RB: 1,49	829.0	20450	V	11.10	3.29	-2.95	11.44	38.45
			H	13.67	3.29	-2.95	14.01	38.45
	836.5	20525	V	9.06	3.28	-2.97	9.37	38.45
			H	12.53	3.28	-2.98	12.83	38.45
	844.0	20600	V	9.33	3.27	-3.00	9.60	38.45
			H	12.14	3.27	-3.00	12.41	38.45
BAND 5 BW: 10M 16QAM RB: 1,0	829.0	20450	V	11.62	3.30	-2.93	12.00	38.45
			H	15.44	3.30	-2.93	15.81	38.45
	836.5	20525	V	12.38	3.30	-2.94	12.73	38.45
			H	15.54	3.30	-2.94	15.89	38.45
	844.0	20600	V	10.88	3.29	-2.97	11.20	38.45
			H	14.18	3.29	-2.97	14.50	38.45
BAND 5 BW: 10M 16QAM RB: 1,49	829.0	20450	V	12.63	3.29	-2.95	12.97	38.45
			H	14.97	3.29	-2.95	15.31	38.45
	836.5	20525	V	9.49	3.28	-2.97	9.80	38.45
			H	12.86	3.28	-2.97	13.17	38.45
	844.0	20600	V	10.56	3.27	-3.00	10.83	38.45
			H	12.92	3.27	-3.00	13.19	38.45

The RBW,VBW of SPA for frequency RBW= 8MHz , VBW= 8MHz

Unless otherwise stated the results shown in this test report refer only to the sample(s) tested and such sample(s) are retained for 90 days only.

除非另有說明，此報告結果僅對測試之樣品負責，同時此樣品僅保留90天。本報告未經本公司書面許可，不可部份複製。

This document is issued by the Company subject to its General Conditions of Service printed overleaf, available on request or accessible at www.sgs.com/terms_and_conditions.htm and, for electronic format documents, subject to Terms and Conditions for Electronic Documents at www.sgs.com/terms_e-document.htm. Attention is drawn to the limitation of liability, indemnification and jurisdiction issues defined therein. Any holder of this document is advised that information contained hereon reflects the Company's findings at the time of its intervention only and within the limits of Client's instructions, if any. The Company's sole responsibility is to its Client and this document does not exonerate parties to a transaction from exercising all their rights and obligations under the transaction documents. This document cannot be reproduced except in full, without prior written approval of the Company. Any unauthorized alteration, forgery or falsification of the content or appearance of this document is unlawful and offenders may be prosecuted to the fullest extent of the law.

SGS Taiwan Ltd.

No.134,WuKungRoad,NewTaipeiIndustrialPark,WukuDistrict,NewTaipeiCity,Taiwan24803/新北市五股區新北產業園區五工路 134 號

台灣檢驗科技股份有限公司

t (886-2) 2299-3279

f (886-2) 2298-0488

www.tw.sgs.com

Member of SGS Group

8. OCCUPIED BANDWIDTH MEASUREMENT

8.1. Standard Applicable

The occupied bandwidth is the frequency bandwidth such that, below its lower and above its upper frequency limits, the mean powers radiated are each equal to 0.5 percent of the total mean power.

8.2. Test Set-up

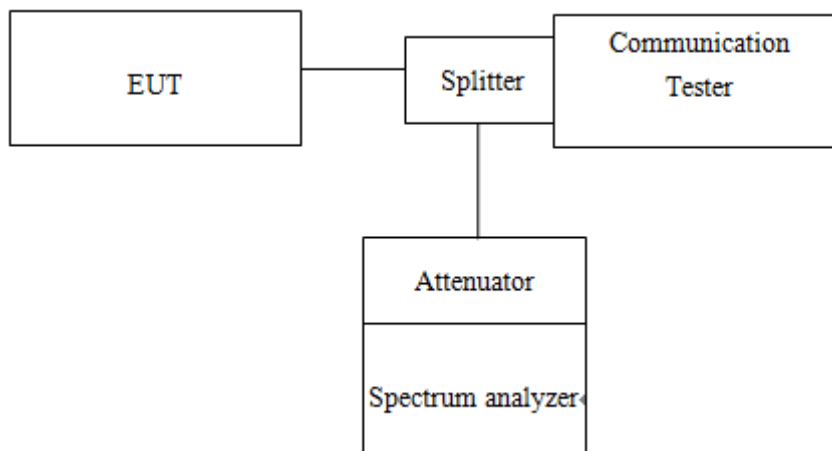

8.3. Measurement Procedure

99% & 26dB Bandwidth with detector peak

The EUT's output RF connector was connected with a short cable to the spectrum analyzer, RBW was set to about 1% of emission BW, VBW= 3 times RBW, -26dBc display line was placed on the screen (or 26dB bandwidth), the occupied bandwidth is the delta frequency between the two points where the display line intersects the signal trace. Then set RBW to 99% bandwidth, RBW= 1%, VBW= 3 RBW, with span > 2 * Signal BW, set % Power = 99%.

99% Bandwidth with detector sample

The EUT's output RF connector was connected with a short cable to the spectrum analyzer, RBW was set to about 1% ~ 5% of emission BW, VBW= 3 times RBW, -20dBc display line was placed on the screen (or 20dB bandwidth). Set RBW to 99% bandwidth, RBW= 1% ~ 5%, VBW= 3 RBW, with span > 2 * Signal BW, set % Power = 99%.

Unless otherwise stated the results shown in this test report refer only to the sample(s) tested and such sample(s) are retained for 90 days only.

除非另有說明，此報告結果僅對測試之樣品負責，同時此樣品僅保留90天。本報告未經本公司書面許可，不可部份複製。

This document is issued by the Company subject to its General Conditions of Service printed overleaf, available on request or accessible at www.sgs.com/terms_and_conditions.htm and, for electronic format documents, subject to Terms and Conditions for Electronic Documents at www.sgs.com/terms_e-document.htm. Attention is drawn to the limitation of liability, indemnification and jurisdiction issues defined therein. Any holder of this document is advised that information contained hereon reflects the Company's findings at the time of its intervention only and within the limits of Client's instructions, if any. The Company's sole responsibility is to its Client and this document does not exonerate parties to a transaction from exercising all their rights and obligations under the transaction documents. This document cannot be reproduced except in full, without prior written approval of the Company. Any unauthorized alteration, forgery or falsification of the content or appearance of this document is unlawful and offenders may be prosecuted to the fullest extent of the law.

8.4. Measurement Equipment Used

Conducted Emission (measured at antenna port) Test Site					
EQUIPMENT TYPE	MFR	MODEL NUMBER	SERIAL NUMBER	LAST CAL.	CAL DUE.
EXA Spectrum Analyzer	Agilent	N9030A	MY53120760	03/21/2017	03/20/2018
DC Block	Mini-Circuits	BLK-18-S+	1	01/05/2017	01/04/2018
Coaxial Cable	HUBER+SÜHNER	SUCOFLEX 102	23670/2	01/05/2017	01/04/2018
Attenuator	Mini-Circuit	BW-S10W2+	2	01/05/2017	01/04/2018
Splitter	Agilent	11636B	N/A	01/05/2017	01/04/2018
DC Power Supply	Agilent	E3640A	MY52410006	11/21/2016	11/20/2017
Temperature Chamber	TERCHY	MHG-120LF	911009	05/19/2017	05/18/2018
Radio Communication Analyser	Anritsu	MT8820C	6201465317	01/03/2017	01/02/2018

8.5. Measurement Result

LTE BAND 5 Channel bandwidth: 1.4MHz					
Freq. (MHz)	CH	99% BW (MHz)	99% BW (MHz)	26 dB BW (MHz)	26 dB BW (MHz)
		QPSK	16QAM	QPSK	16QAM
824.7	20407	1.0967	1.0987	1.291	1.288
836.5	20525	1.0956	1.0982	1.290	1.293
848.3	20643	1.0976	1.0986	1.291	1.295

LTE BAND 5 Channel bandwidth: 3MHz					
Freq. (MHz)	CH	99% BW (MHz)	99% BW (MHz)	26 dB BW (MHz)	26 dB BW (MHz)
		QPSK	16QAM	QPSK	16QAM
825.5	20415	2.6994	2.6978	2.979	2.999
836.5	20525	2.6997	2.6997	2.973	2.992
847.5	20635	2.6893	2.6963	2.923	2.930

LTE BAND 5 Channel bandwidth: 5MHz					
Freq. (MHz)	CH	99% BW (MHz)	99% BW (MHz)	26 dB BW (MHz)	26 dB BW (MHz)
		QPSK	16QAM	QPSK	16QAM
826.5	20425	4.5035	4.4998	5.037	5.041
836.5	20525	4.5097	4.5059	5.029	5.036
846.5	20625	4.4971	4.5016	4.874	5.032

LTE BAND 5 Channel bandwidth: 10MHz					
Freq. (MHz)	CH	99% BW (MHz)	99% BW (MHz)	26 dB BW (MHz)	26 dB BW (MHz)
		QPSK	16QAM	QPSK	16QAM
829.0	20450	8.9917	8.9431	9.895	9.842
836.5	20525	9.0069	8.9686	9.938	9.809
844.0	20600	8.9962	8.9643	9.888	9.839

Unless otherwise stated the results shown in this test report refer only to the sample(s) tested and such sample(s) are retained for 90 days only.

除非另有說明，此報告結果僅對測試之樣品負責，同時此樣品僅保留90天。本報告未經本公司書面許可，不可部份複製。

This document is issued by the Company subject to its General Conditions of Service printed overleaf, available on request or accessible at www.sgs.com/terms_and_conditions.htm and, for electronic format documents, subject to Terms and Conditions for Electronic Documents at www.sgs.com/terms_e-document.htm. Attention is drawn to the limitation of liability, indemnification and jurisdiction issues defined therein. Any holder of this document is advised that information contained hereon reflects the Company's findings at the time of its intervention only and within the limits of Client's instructions, if any. The Company's sole responsibility is to its Client and this document does not exonerate parties to a transaction from exercising all their rights and obligations under the transaction documents. This document cannot be reproduced except in full, without prior written approval of the Company. Any unauthorized alteration, forgery or falsification of the content or appearance of this document is unlawful and offenders may be prosecuted to the fullest extent of the law.

SGS Taiwan Ltd.

No.134,WuKungRoad,NewTaipeiIndustrialPark,WukuDistrict,NewTaipeiCity,Taiwan24803/新北市五股區新北產業園區五工路 134 號

台灣檢驗科技股份有限公司

t (886-2) 2299-3279

f (886-2) 2298-0488

www.tw.sgs.com

Member of SGS Group

Band5_1_4MHz_QPSK_6_0_LowCH20407-824.7

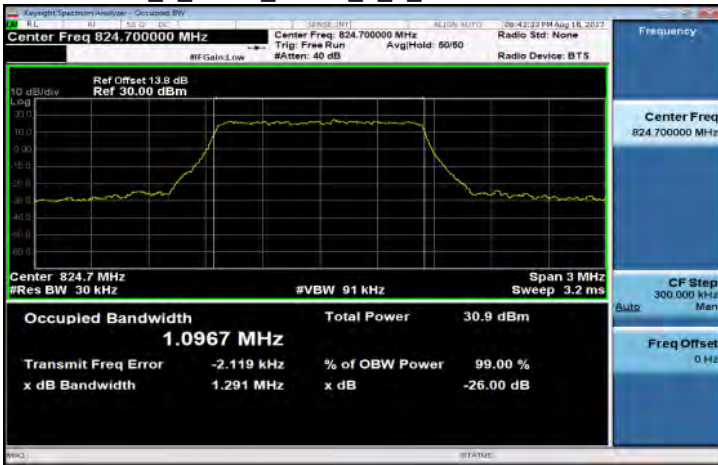

Band5_1_4MHz_16QAM_6_0_LowCH20407-824.7

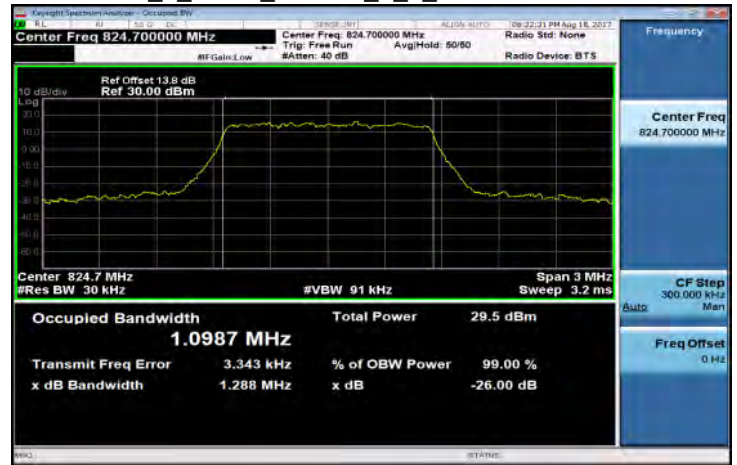

Band5_1_4MHz_QPSK_6_0_MidCH20525-836.5

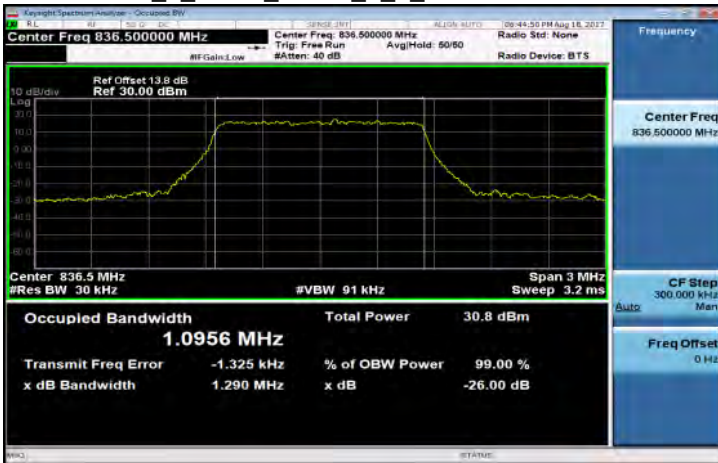

Band5_1_4MHz_16QAM_6_0_MidCH20525-836.5

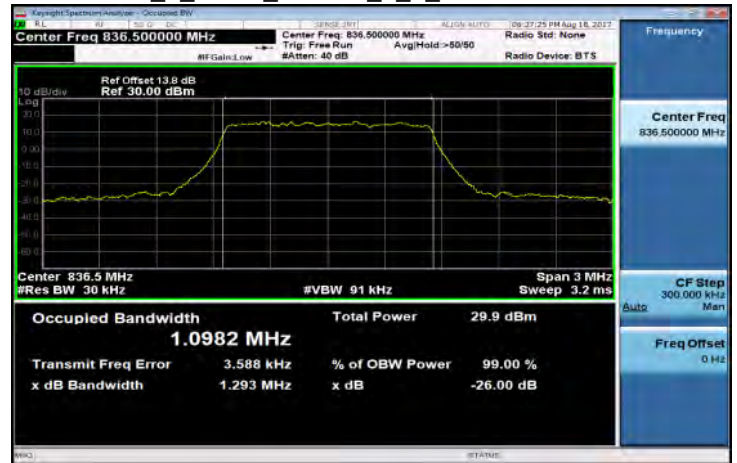

Band5_1_4MHz_QPSK_6_0_HighCH20643-848.3

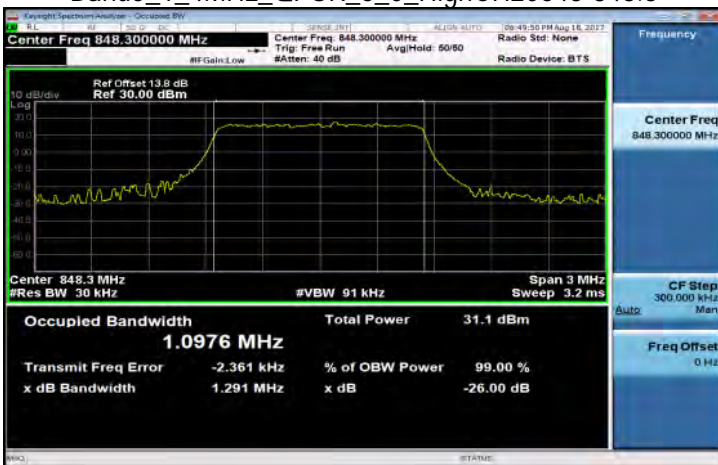

Band5_1_4MHz_16QAM_6_0_HighCH20643-848.3

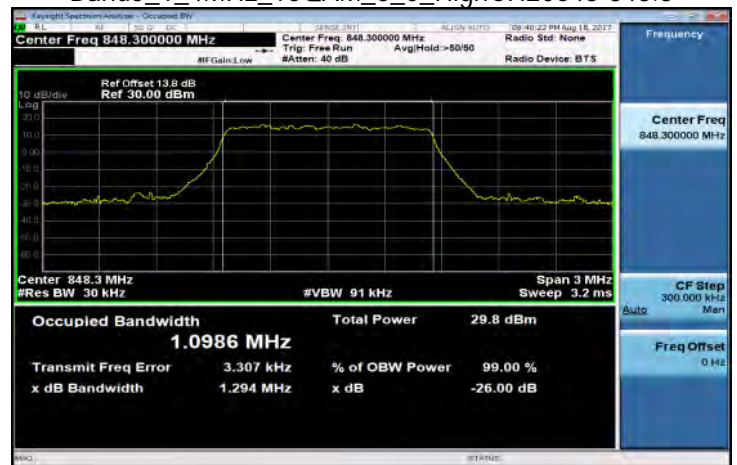

Unless otherwise stated the results shown in this test report refer only to the sample(s) tested and such sample(s) are retained for 90 days only.

除非另有說明，此報告結果僅對測試之樣品負責，同時此樣品僅保留90天。本報告未經本公司書面許可，不可部份複製。

This document is issued by the Company subject to its General Conditions of Service printed overleaf, available on request or accessible at www.sgs.com/terms_and_conditions.htm and, for electronic format documents, subject to Terms and Conditions for Electronic Documents at www.sgs.com/terms_e-document.htm. Attention is drawn to the limitation of liability, indemnification and jurisdiction issues defined therein. Any holder of this document is advised that information contained hereon reflects the Company's findings at the time of its intervention only and within the limits of Client's instructions, if any. The Company's sole responsibility is to its Client and this document does not exonerate parties to a transaction from exercising all their rights and obligations under the transaction documents. This document cannot be reproduced except in full, without prior written approval of the Company. Any unauthorized alteration, forgery or falsification of the content or appearance of this document is unlawful and offenders may be prosecuted to the fullest extent of the law.

Band5_3MHz_QPSK_15_0_LowCH20415-825.5

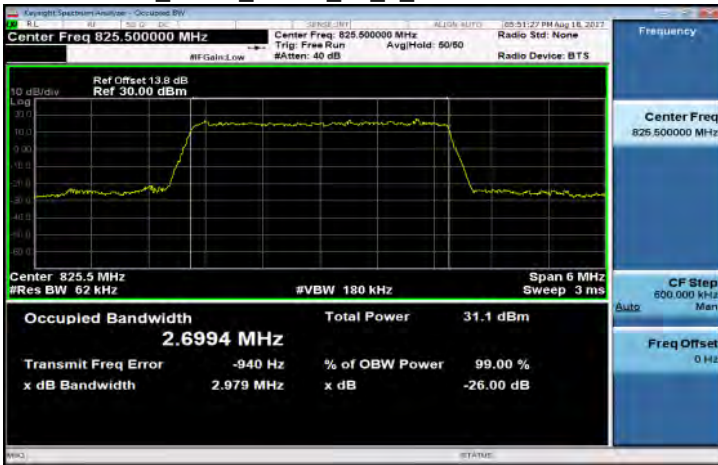

Band5_3MHz_16QAM_15_0_LowCH20415-825.5

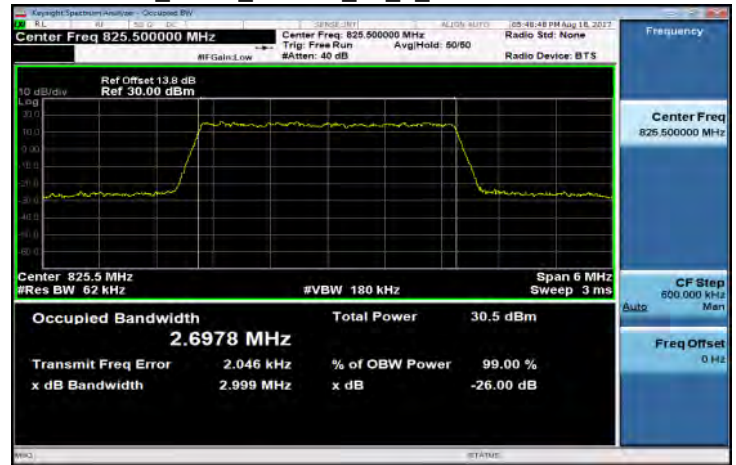

Band5_3MHz_QPSK_15_0_MidCH20525-836.5

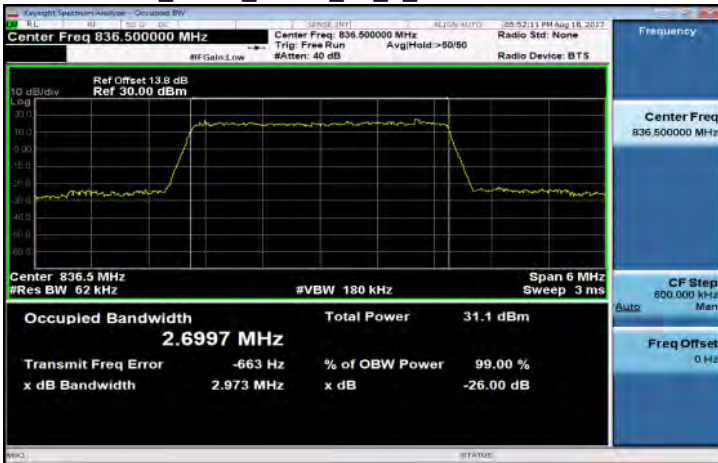

Band5_3MHz_16QAM_15_0_MidCH20525-836.5

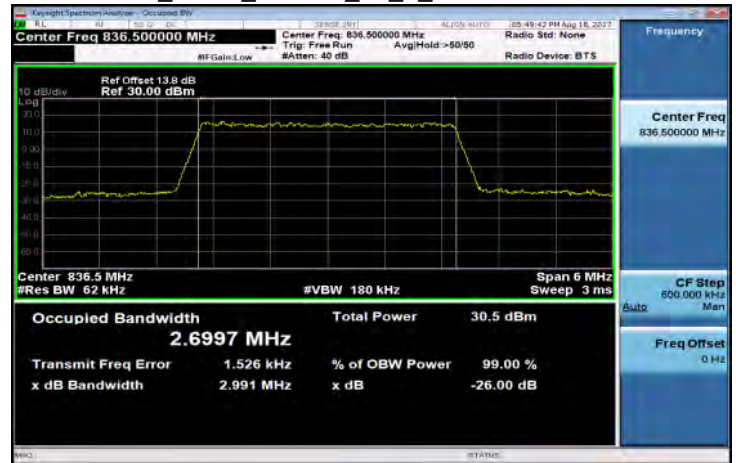

Band5_3MHz_QPSK_15_0_HighCH20635-847.5

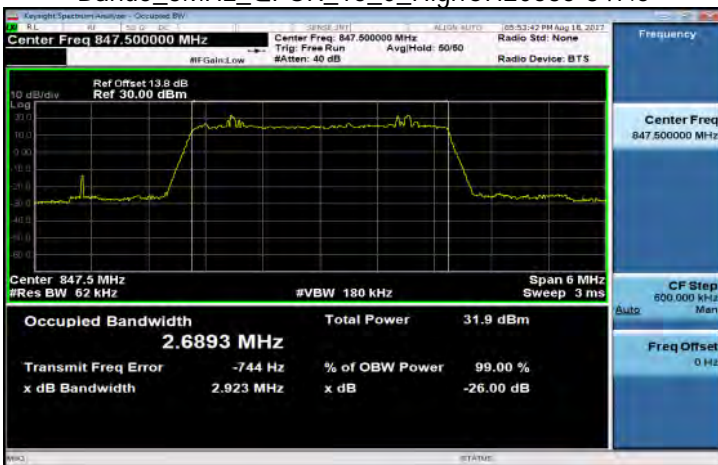

Band5_3MHz_16QAM_15_0_HighCH20635-847.5

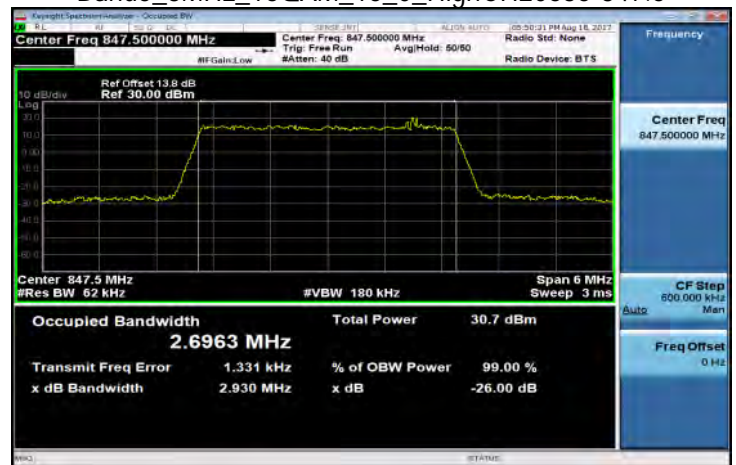

Unless otherwise stated the results shown in this test report refer only to the sample(s) tested and such sample(s) are retained for 90 days only.

除非另有說明，此報告結果僅對測試之樣品負責，同時此樣品僅保留90天。本報告未經本公司書面許可，不可部份複製。

This document is issued by the Company subject to its General Conditions of Service printed overleaf, available on request or accessible at www.sgs.com/terms_and_conditions.htm and, for electronic format documents, subject to Terms and Conditions for Electronic Documents at www.sgs.com/terms_e-document.htm. Attention is drawn to the limitation of liability, indemnification and jurisdiction issues defined therein. Any holder of this document is advised that information contained hereon reflects the Company's findings at the time of its intervention only and within the limits of Client's instructions, if any. The Company's sole responsibility is to its Client and this document does not exonerate parties to a transaction from exercising all their rights and obligations under the transaction documents. This document cannot be reproduced except in full, without prior written approval of the Company. Any unauthorized alteration, forgery or falsification of the content or appearance of this document is unlawful and offenders may be prosecuted to the fullest extent of the law.

Band5_5MHz_QPSK_25_0_LowCH20425-826.5

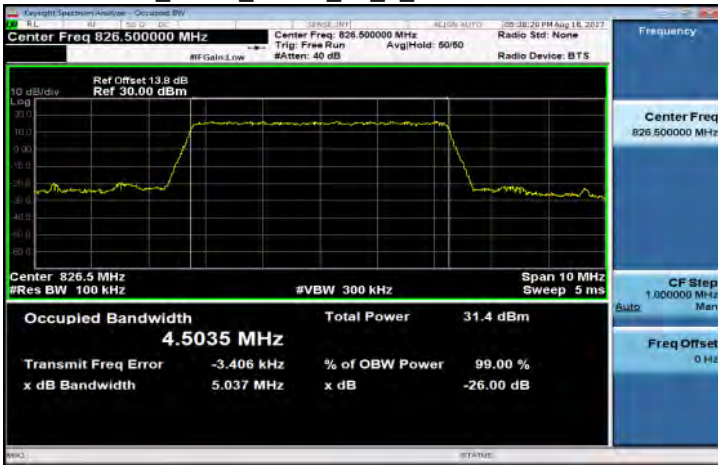

Band5_5MHz_16QAM_25_0_LowCH20425-826.5

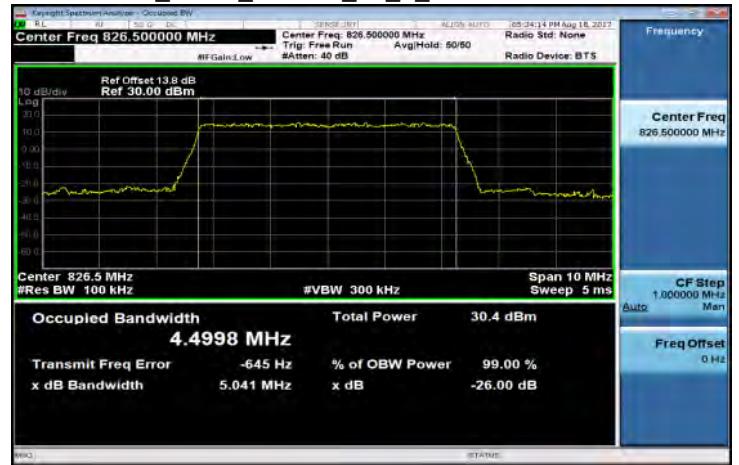

Band5_5MHz_QPSK_25_0_MidCH20525-836.5

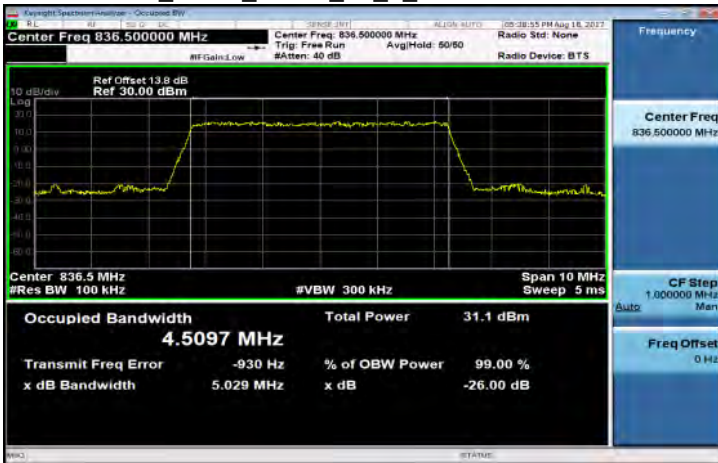

Band5_5MHz_16QAM_25_0_MidCH20525-836.5

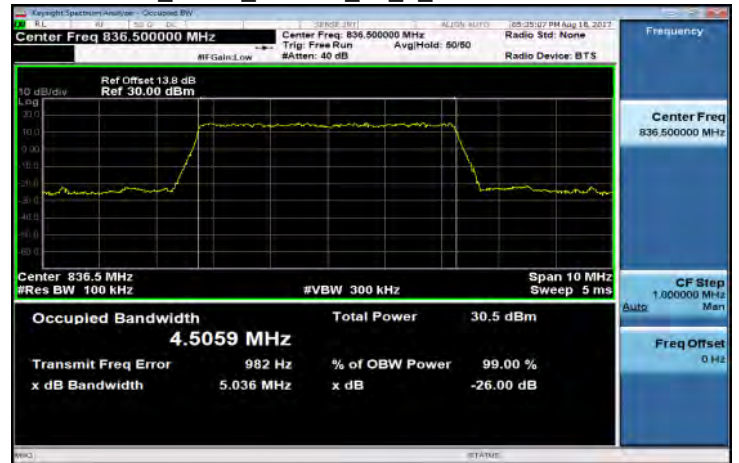

Band5_5MHz_QPSK_25_0_HighCH20625-846.5

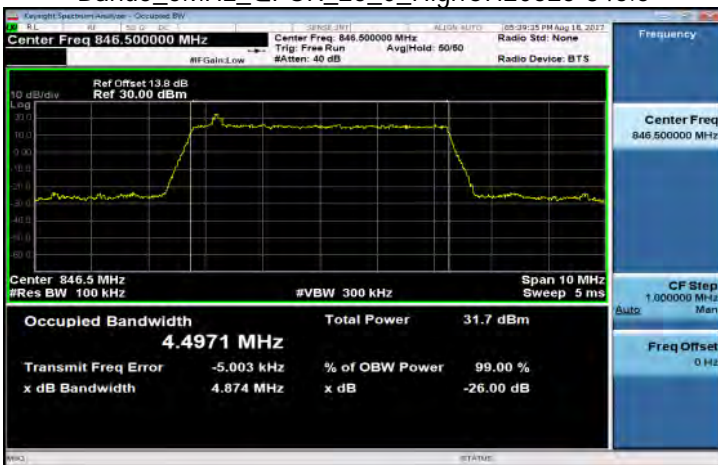

Band5_5MHz_16QAM_25_0_HighCH20625-846.5

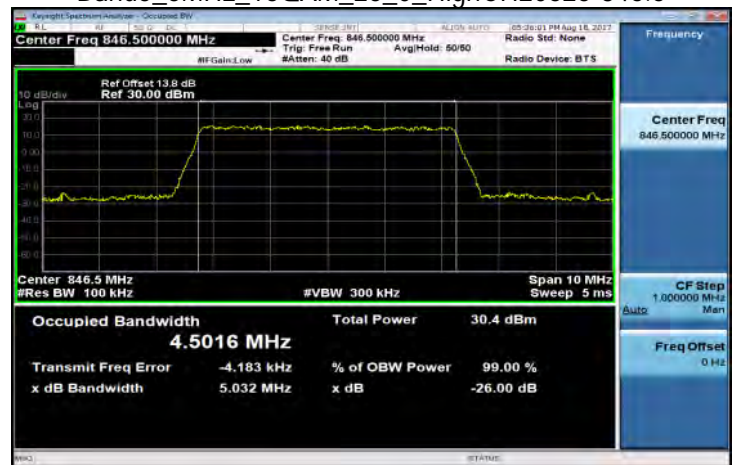

Unless otherwise stated the results shown in this test report refer only to the sample(s) tested and such sample(s) are retained for 90 days only.

除非另有說明，此報告結果僅對測試之樣品負責，同時此樣品僅保留90天。本報告未經本公司書面許可，不可部份複製。

This document is issued by the Company subject to its General Conditions of Service printed overleaf, available on request or accessible at www.sgs.com/terms_and_conditions.htm and, for electronic format documents, subject to Terms and Conditions for Electronic Documents at www.sgs.com/terms_e-document.htm. Attention is drawn to the limitation of liability, indemnification and jurisdiction issues defined therein. Any holder of this document is advised that information contained hereon reflects the Company's findings at the time of its intervention only and within the limits of Client's instructions, if any. The Company's sole responsibility is to its Client and this document does not exonerate parties to a transaction from exercising all their rights and obligations under the transaction documents. This document cannot be reproduced except in full, without prior written approval of the Company. Any unauthorized alteration, forgery or falsification of the content or appearance of this document is unlawful and offenders may be prosecuted to the fullest extent of the law.

Band5_10MHz_QPSK_50_0_LowCH20450-829

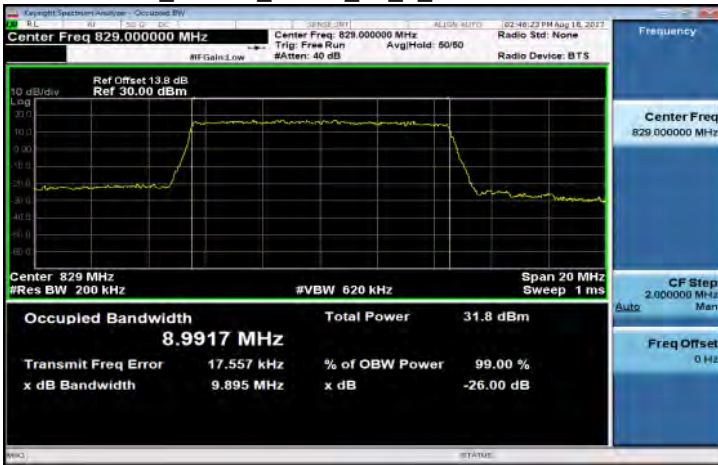

Band5_10MHz_16QAM_50_0_LowCH20450-829

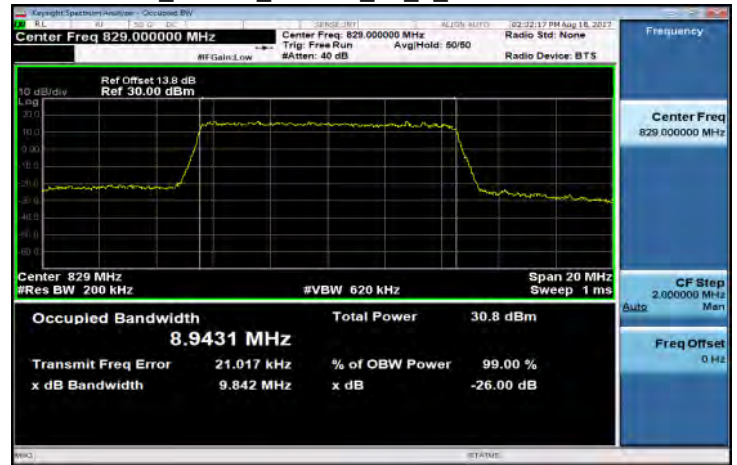

Band5_10MHz_QPSK_50_0_MidCH20525-836.5

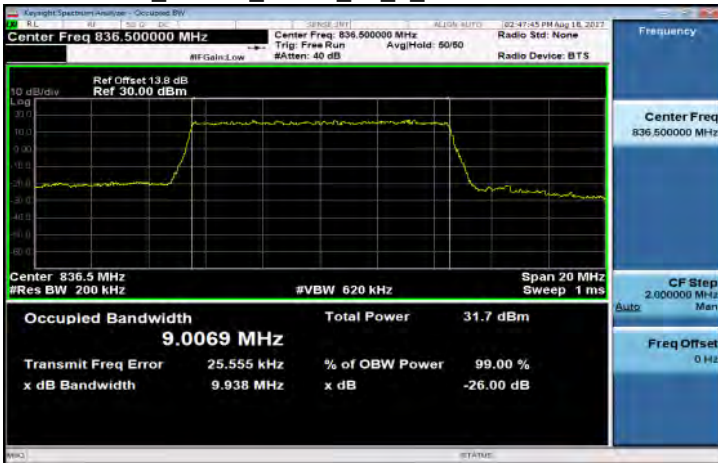

Band5_10MHz_16QAM_50_0_MidCH20525-836.5

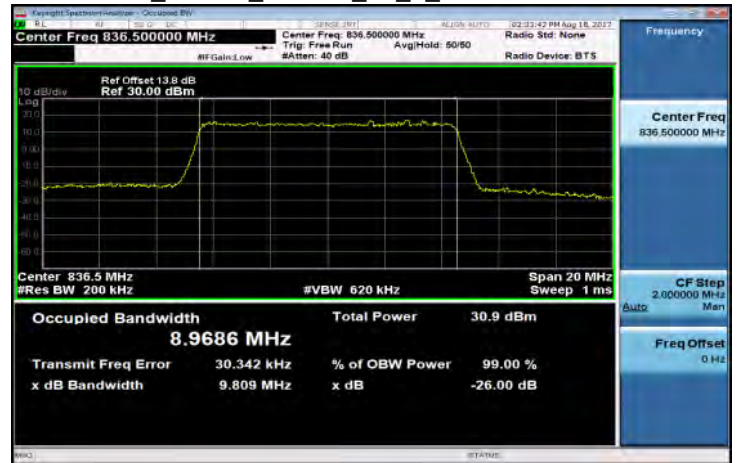

Band5_10MHz_QPSK_50_0_HighCH20600-844

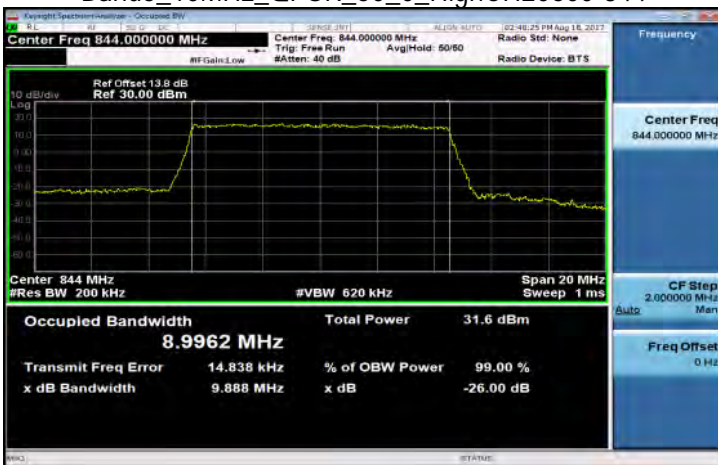

Band5_10MHz_16QAM_50_0_HighCH20600-844

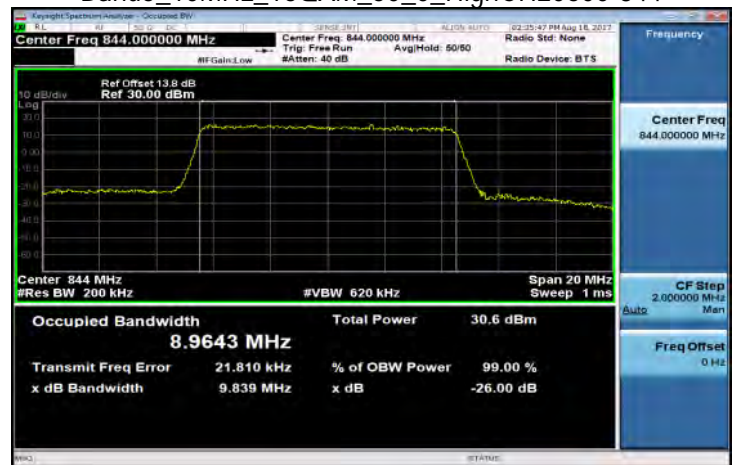

Unless otherwise stated the results shown in this test report refer only to the sample(s) tested and such sample(s) are retained for 90 days only.

除非另有說明，此報告結果僅對測試之樣品負責，同時此樣品僅保留90天。本報告未經本公司書面許可，不可部份複製。

This document is issued by the Company subject to its General Conditions of Service printed overleaf, available on request or accessible at www.sgs.com/terms_and_conditions.htm and, for electronic format documents, subject to Terms and Conditions for Electronic Documents at www.sgs.com/terms_e-document.htm. Attention is drawn to the limitation of liability, indemnification and jurisdiction issues defined therein. Any holder of this document is advised that information contained hereon reflects the Company's findings at the time of its intervention only and within the limits of Client's instructions, if any. The Company's sole responsibility is to its Client and this document does not exonerate parties to a transaction from exercising all their rights and obligations under the transaction documents. This document cannot be reproduced except in full, without prior written approval of the Company. Any unauthorized alteration, forgery or falsification of the content or appearance of this document is unlawful and offenders may be prosecuted to the fullest extent of the law.

9. OUT OF BAND EMISSION AT ANTENNA TERMINALS

9.1. Standard Applicable

FCC §22.917(a), the magnitude of each spurious and harmonic emission that can be detected when the equipment is operated under the conditions specified in the instruction manual and/or alignment procedure, shall not be less than $43 + 10 \log$ (mean output power in watts) dBc below the mean power output outside a license's frequency block (-13dBm).

9.2. Test SET-UP

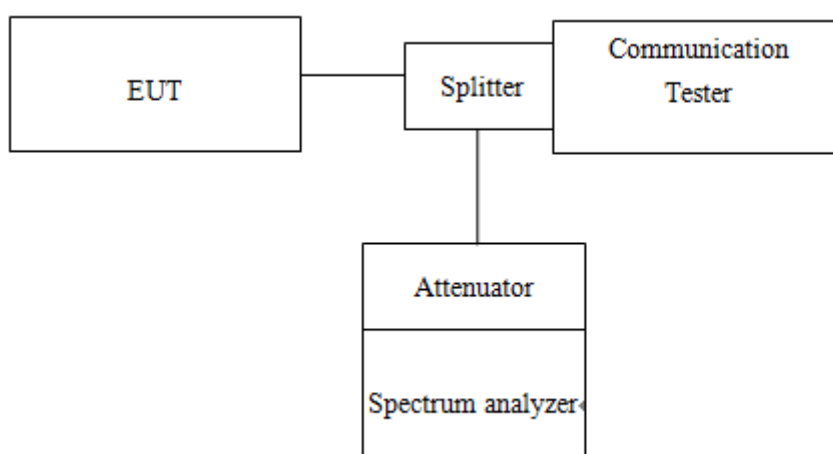

9.3. Measurement Procedure

Conducted Emission

The RF output of the transceiver was connected to a spectrum analyzer through appropriate attenuation. The resolution bandwidth of the spectrum analyzer was set at 1MHz, sufficient scans were taken to show the out of band Emissions if any up to 10th harmonic.

1. To connect Antenna Port of EUT to Spectrum.
2. Set RBW = 1MHz & VBW = 1MHz on Spectrum.
3. Allow trace to fully stabilize
4. Repeat above procedures until all default test channel measured were complete.

Unless otherwise stated the results shown in this test report refer only to the sample(s) tested and such sample(s) are retained for 90 days only.

除非另有說明，此報告結果僅對測試之樣品負責，同時此樣品僅保留90天。本報告未經本公司書面許可，不可部份複製。

This document is issued by the Company subject to its General Conditions of Service printed overleaf, available on request or accessible at www.sgs.com/terms_and_conditions.htm and, for electronic format documents, subject to Terms and Conditions for Electronic Documents at www.sgs.com/terms_e-document.htm. Attention is drawn to the limitation of liability, indemnification and jurisdiction issues defined therein. Any holder of this document is advised that information contained hereon reflects the Company's findings at the time of its intervention only and within the limits of Client's instructions, if any. The Company's sole responsibility is to its Client and this document does not exonerate parties to a transaction from exercising all their rights and obligations under the transaction documents. This document cannot be reproduced except in full, without prior written approval of the Company. Any unauthorized alteration, forgery or falsification of the content or appearance of this document is unlawful and offenders may be prosecuted to the fullest extent of the law.

SGS Taiwan Ltd.

No.134,WuKungRoad,NewTaipeiIndustrialPark,WukuDistrict,NewTaipeiCity,Taiwan24803/新北市五股區新北產業園區五工路 134 號

台灣檢驗科技股份有限公司

t (886-2) 2299-3279

f (886-2) 2298-0488

www.tw.sgs.com

Member of SGS Group

Band Edge

1. To connect Antenna Port of EUT to Spectrum.
2. The band edge of low and high channels for the highest RF powers was measured. Setting RBW \geq 1% EBW.
3. Allow trace to fully stabilize
4. Repeat above procedures until all default test channel measured were complete.

9.4. Measurement Equipment Used

Conducted Emission (measured at antenna port) Test Site					
EQUIPMENT TYPE	MFR	MODEL NUMBER	SERIAL NUMBER	LAST CAL.	CAL DUE.
EXA Spectrum Analyzer	Agilent	N9030A	MY53120760	03/21/2017	03/20/2018
DC Block	Mini-Circuits	BLK-18-S+	1	01/05/2017	01/04/2018
Coaxial Cable	HUBER+SUHNER	SUCOFLEX 102	23670/2	01/05/2017	01/04/2018
Attenuator	Mini-Circuit	BW-S10W2+	2	01/05/2017	01/04/2018
Splitter	Agilent	11636B	N/A	01/05/2017	01/04/2018
DC Power Supply	Agilent	E3640A	MY52410006	11/21/2016	11/20/2017
Temperature Chamber	TERCHY	MHG-120LF	911009	05/19/2017	05/18/2018
Radio Communication Analyer	Anritsu	MT8820C	6201465317	01/03/2017	01/02/2018

9.5. Measurement Result:

Refer to next pages.

NOTE: The occurrence of the spike on the conducted emission is the signal of the fundamental emission.

Unless otherwise stated the results shown in this test report refer only to the sample(s) tested and such sample(s) are retained for 90 days only.

除非另有說明，此報告結果僅對測試之樣品負責，同時此樣品僅保留90天。本報告未經本公司書面許可，不可部份複製。

This document is issued by the Company subject to its General Conditions of Service printed overleaf, available on request or accessible at www.sgs.com/terms_and_conditions.htm and, for electronic format documents, subject to Terms and Conditions for Electronic Documents at www.sgs.com/terms_e-document.htm. Attention is drawn to the limitation of liability, indemnification and jurisdiction issues defined therein. Any holder of this document is advised that information contained hereon reflects the Company's findings at the time of its intervention only and within the limits of Client's instructions, if any. The Company's sole responsibility is to its Client and this document does not exonerate parties to a transaction from exercising all their rights and obligations under the transaction documents. This document cannot be reproduced except in full, without prior written approval of the Company. Any unauthorized alteration, forgery or falsification of the content or appearance of this document is unlawful and offenders may be prosecuted to the fullest extent of the law.

SGS Taiwan Ltd.

No.134,WuKungRoad,NewTaipeiIndustrialPark,WukuDistrict,NewTaipeiCity,Taiwan24803/新北市五股區新北產業園區五工路 134 號

台灣檢驗科技股份有限公司

t (886-2) 2299-3279

f (886-2) 2298-0488

www.tw.sgs.com

Member of SGS Group

Emission

30MHz~3GHz_Band5_1_4MHz_QPSK_1_0_LowCH20407-824.7



3GHz~10GHz_Band5_1_4MHz_QPSK_1_0_MidCH20525-836.5

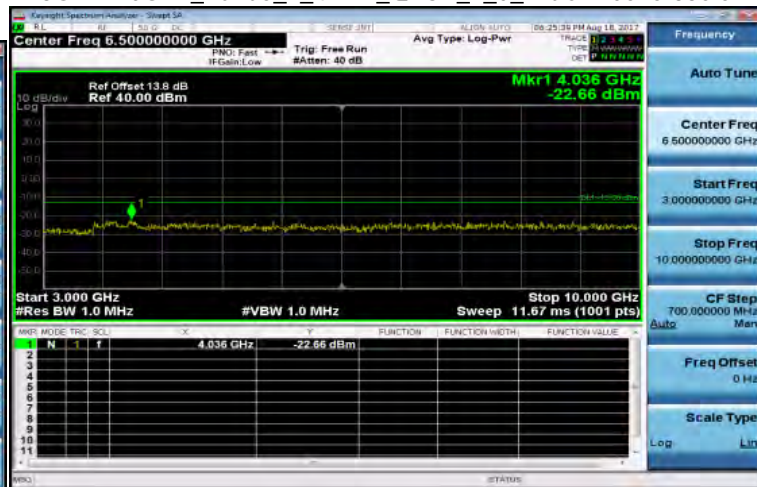

30MHz~3GHz_Band5_1_4MHz_QPSK_1_0_HighCH20643-848.3

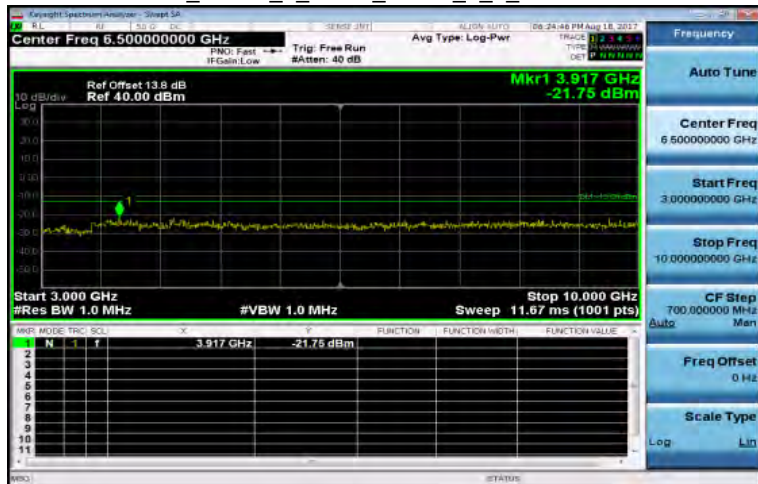

3GHz~10GHz_Band5_1_4MHz_QPSK_1_0_LowCH20407-824.7

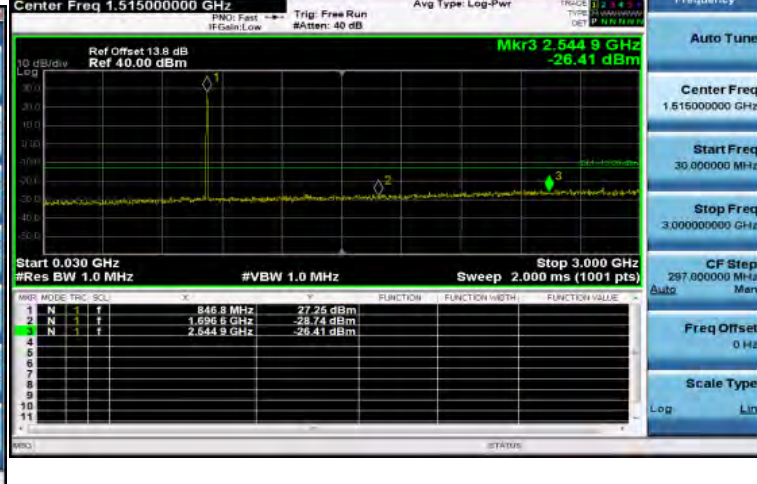

30MHz~3GHz_Band5_1_4MHz_QPSK_1_0_MidCH20525-836.5



3GHz~10GHz_Band5_1_4MHz_QPSK_1_0_HighCH20643-848.3



Unless otherwise stated the results shown in this test report refer only to the sample(s) tested and such sample(s) are retained for 90 days only.

除非另有說明，此報告結果僅對測試之樣品負責，同時此樣品僅保留90天。本報告未經本公司書面許可，不可部份複製。
This document is issued by the Company subject to its General Conditions of Service printed overleaf, available on request or accessible at www.sgs.com/terms_and_conditions.htm and, for electronic format documents, subject to Terms and Conditions for Electronic Documents at www.sgs.com/terms_e-document.htm. Attention is drawn to the limitation of liability, indemnification and jurisdiction issues defined therein. Any holder of this document is advised that information contained hereon reflects the Company's findings at the time of its intervention only and within the limits of Client's instructions, if any. The Company's sole responsibility is to its Client and this document does not exonerate parties to a transaction from exercising all their rights and obligations under the transaction documents. This document cannot be reproduced except in full, without prior written approval of the Company. Any unauthorized alteration, forgery or falsification of the content or appearance of this document is unlawful and offenders may be prosecuted to the fullest extent of the law.

30MHz~3GHz_Band5_3MHz_QPSK_1_0_LowCH20415-825.5



3GHz~10GHz_Band5_3MHz_QPSK_1_0_MidCH20525-836.5

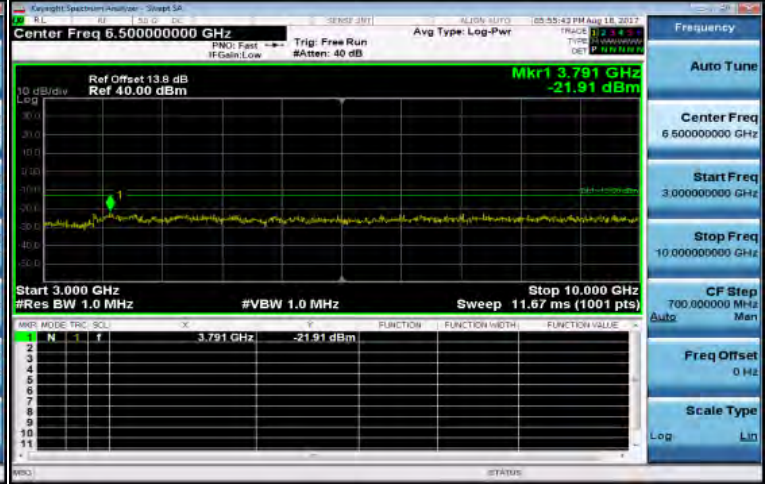

3GHz~10GHz_Band5_3MHz_QPSK_1_0_LowCH20415-825.5

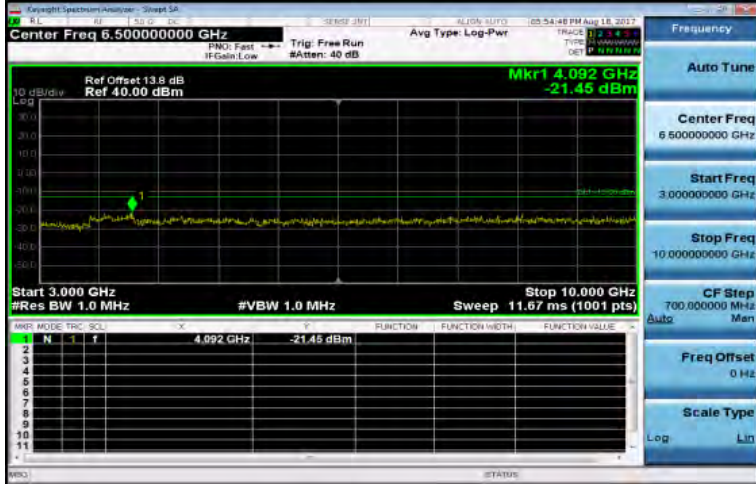

30MHz~3GHz_Band5_3MHz_QPSK_1_0_HighCH20635-847.5

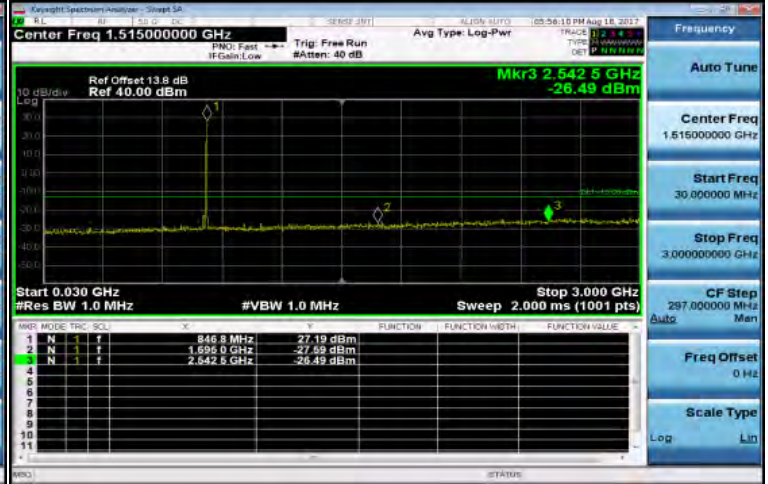

30MHz~3GHz_Band5_3MHz_QPSK_1_0_MidCH20525-836.5



3GHz~10GHz_Band5_3MHz_QPSK_1_0_HighCH20635-847.5

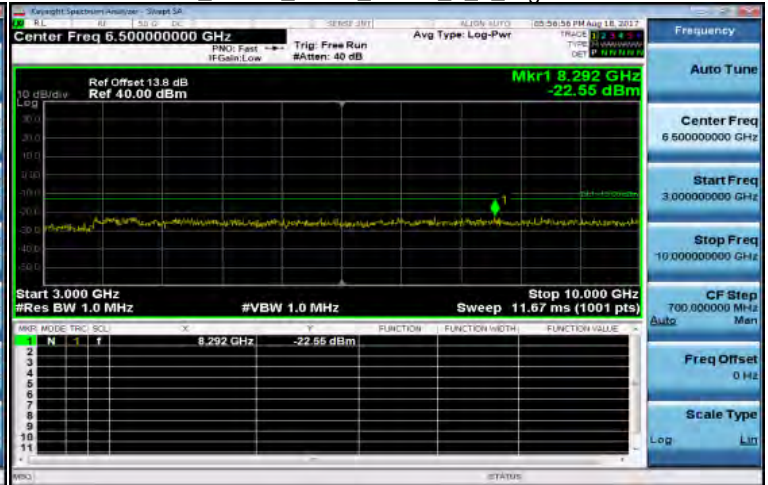

Unless otherwise stated the results shown in this test report refer only to the sample(s) tested and such sample(s) are retained for 90 days only.

除非另有說明，此報告結果僅對測試之樣品負責，同時此樣品僅保留90天。本報告未經本公司書面許可，不可部份複製。

This document is issued by the Company subject to its General Conditions of Service printed overleaf, available on request or accessible at www.sgs.com/terms_and_conditions.htm and, for electronic format documents, subject to Terms and Conditions for Electronic Documents at www.sgs.com/terms_e-document.htm. Attention is drawn to the limitation of liability, indemnification and jurisdiction issues defined therein. Any holder of this document is advised that information contained hereon reflects the Company's findings at the time of its intervention only and within the limits of Client's instructions, if any. The Company's sole responsibility is to its Client and this document does not exonerate parties to a transaction from exercising all their rights and obligations under the transaction documents. This document cannot be reproduced except in full, without prior written approval of the Company. Any unauthorized alteration, forgery or falsification of the content or appearance of this document is unlawful and offenders may be prosecuted to the fullest extent of the law.

30MHz~3GHz_Band5_5MHz_QPSK_1_0_LowCH20425-826.5



3GHz~10GHz_Band5_5MHz_QPSK_1_0_MidCH20525-836.5

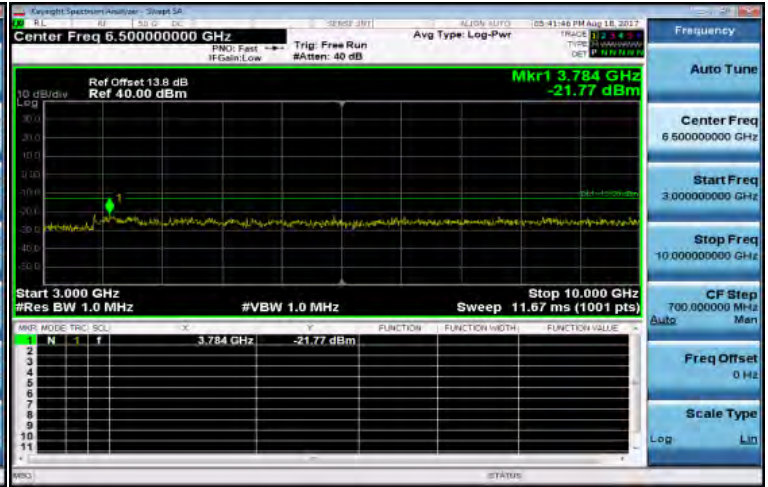

3GHz~10GHz_Band5_5MHz_QPSK_1_0_LowCH20425-826.5

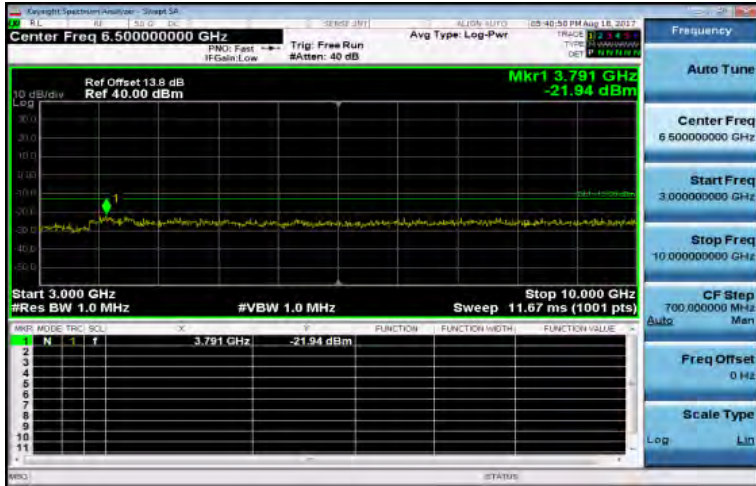

30MHz~3GHz_Band5_5MHz_QPSK_1_0_HighCH20625-846.5



30MHz~3GHz_Band5_5MHz_QPSK_1_0_MidCH20525-836.5

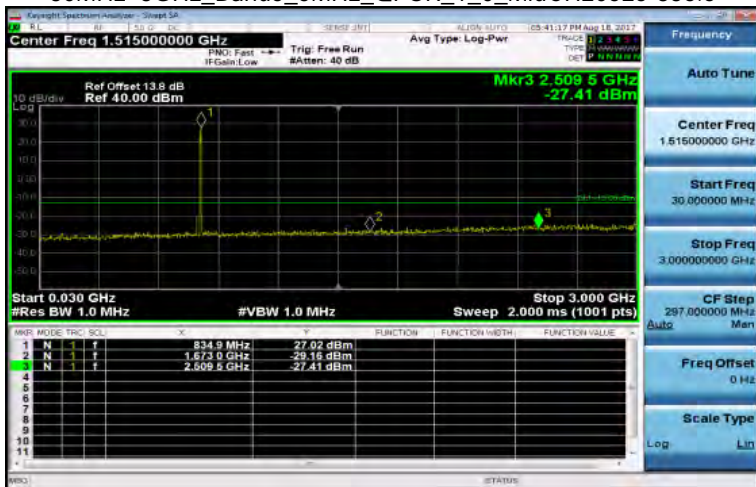

3GHz~10GHz_Band5_5MHz_QPSK_1_0_HighCH20625-846.5

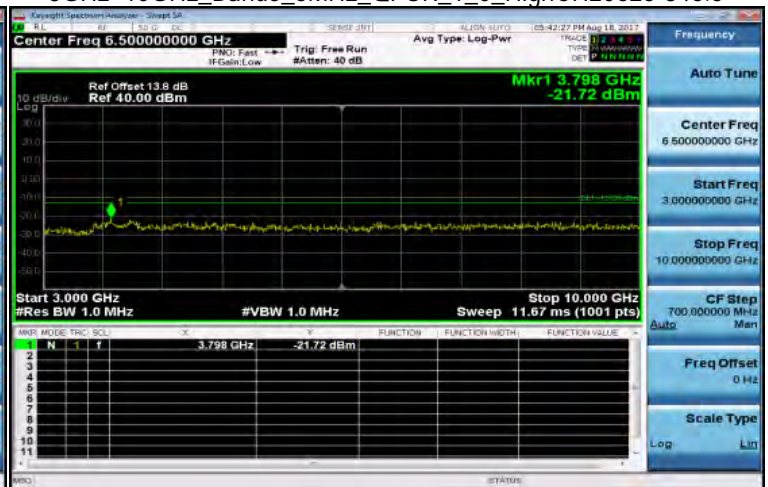

Unless otherwise stated the results shown in this test report refer only to the sample(s) tested and such sample(s) are retained for 90 days only.
除非另有說明，此報告結果僅對測試之樣品負責，同時此樣品僅保留90天。本報告未經本公司書面許可，不可部份複製。

This document is issued by the Company subject to its General Conditions of Service printed overleaf, available on request or accessible at www.sgs.com/terms_and_conditions.htm and, for electronic format documents, subject to Terms and Conditions for Electronic Documents at www.sgs.com/terms_e-document.htm. Attention is drawn to the limitation of liability, indemnification and jurisdiction issues defined therein. Any holder of this document is advised that information contained hereon reflects the Company's findings at the time of its intervention only and within the limits of Client's instructions, if any. The Company's sole responsibility is to its Client and this document does not exonerate parties to a transaction from exercising all their rights and obligations under the transaction documents. This document cannot be reproduced except in full, without prior written approval of the Company. Any unauthorized alteration, forgery or falsification of the content or appearance of this document is unlawful and offenders may be prosecuted to the fullest extent of the law.

30MHz~3GHz_Band5_10MHz_QPSK_1_0_LowCH20450-829



3GHz~10GHz_Band5_10MHz_QPSK_1_0_MidCH20525-836.5

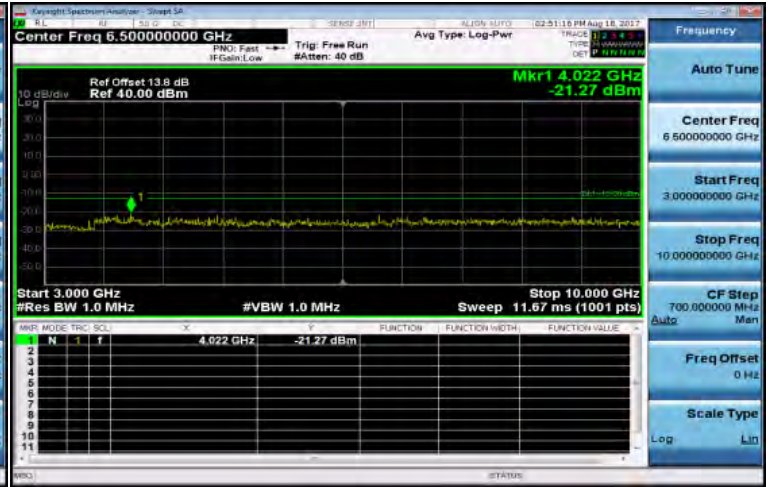

3GHz~10GHz_Band5_10MHz_QPSK_1_0_LowCH20450-829

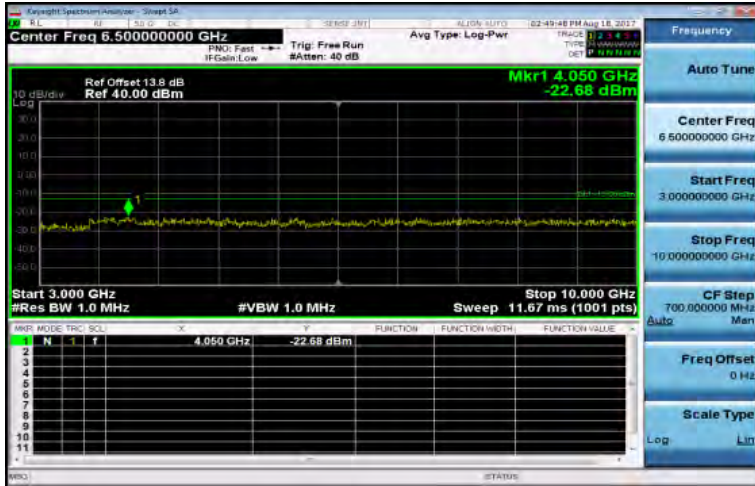

30MHz~3GHz_Band5_10MHz_QPSK_1_0_HighCH20600-844



30MHz~3GHz_Band5_10MHz_QPSK_1_0_MidCH20525-836.5

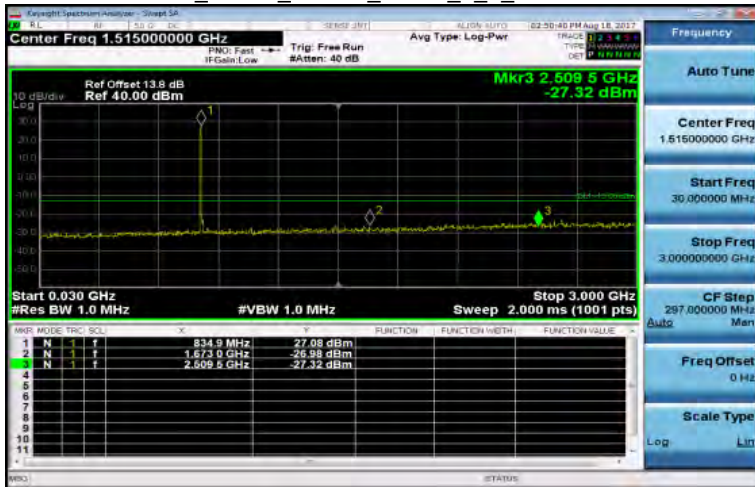

3GHz~10GHz_Band5_10MHz_QPSK_1_0_HighCH20600-844

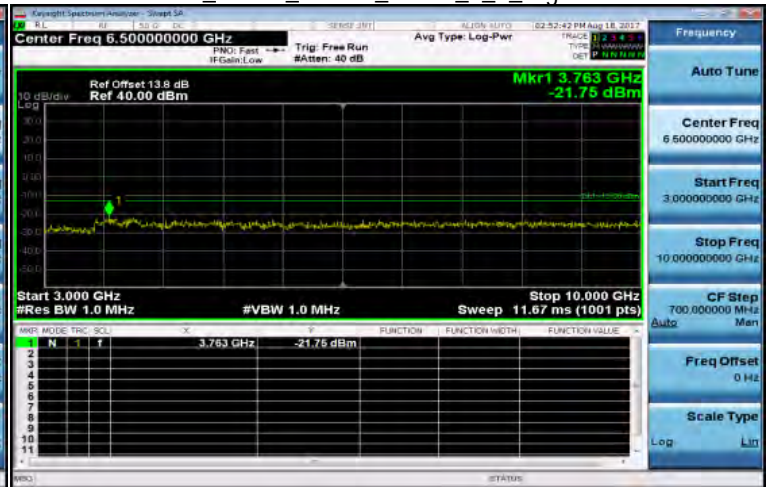

Unless otherwise stated the results shown in this test report refer only to the sample(s) tested and such sample(s) are retained for 90 days only.

除非另有說明，此報告結果僅對測試之樣品負責，同時此樣品僅保留90天。本報告未經本公司書面許可，不可部份複製。

This document is issued by the Company subject to its General Conditions of Service printed overleaf, available on request or accessible at www.sgs.com/terms_and_conditions.htm and, for electronic format documents, subject to Terms and Conditions for Electronic Documents at www.sgs.com/terms_e-document.htm. Attention is drawn to the limitation of liability, indemnification and jurisdiction issues defined therein. Any holder of this document is advised that information contained hereon reflects the Company's findings at the time of its intervention only and within the limits of Client's instructions, if any. The Company's sole responsibility is to its Client and this document does not exonerate parties to a transaction from exercising all their rights and obligations under the transaction documents. This document cannot be reproduced except in full, without prior written approval of the Company. Any unauthorized alteration, forgery or falsification of the content or appearance of this document is unlawful and offenders may be prosecuted to the fullest extent of the law.

Band Edge

Band5_1_4MHz_QPSK_1_0_LowCH20407-824.7



Band5_1_4MHz_QPSK_6_0_HighCH20643-848.3

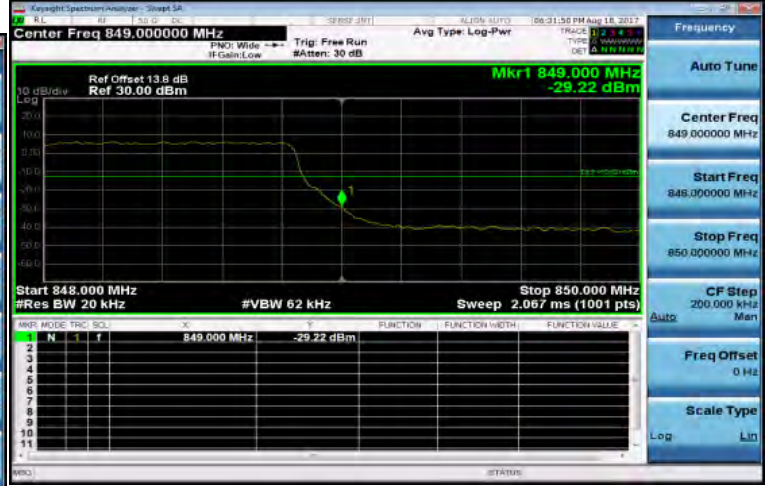

Band5_1_4MHz_QPSK_1_5_HighCH20643-848.3



Band5_3MHz_QPSK_1_0_LowCH20415-825.5



Band5_1_4MHz_QPSK_6_0_LowCH20407-824.7

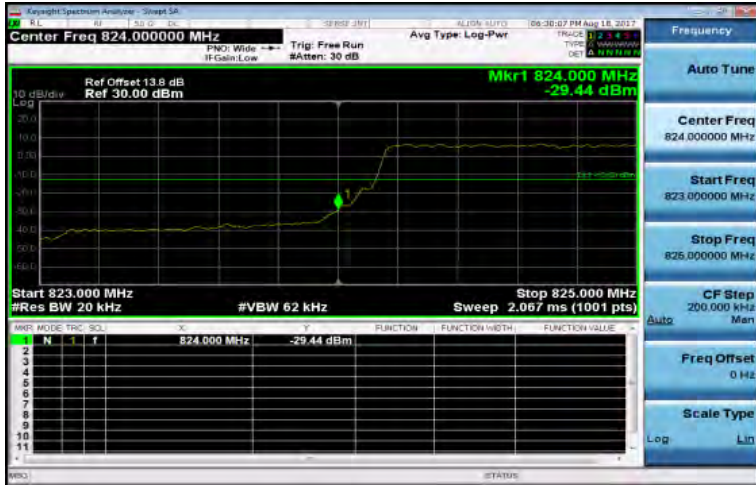

Band5_3MHz_QPSK_1_14_HighCH20635-847.5



Unless otherwise stated the results shown in this test report refer only to the sample(s) tested and such sample(s) are retained for 90 days only.

除非另有說明，此報告結果僅對測試之樣品負責，同時此樣品僅保留90天。本報告未經本公司書面許可，不可部份複製。

This document is issued by the Company subject to its General Conditions of Service printed overleaf, available on request or accessible at www.sgs.com/terms_and_conditions.htm and, for electronic format documents, subject to Terms and Conditions for Electronic Documents at www.sgs.com/terms_e-document.htm. Attention is drawn to the limitation of liability, indemnification and jurisdiction issues defined therein. Any holder of this document is advised that information contained hereon reflects the Company's findings at the time of its intervention only and within the limits of Client's instructions, if any. The Company's sole responsibility is to its Client and this document does not exonerate parties to a transaction from exercising all their rights and obligations under the transaction documents. This document cannot be reproduced except in full, without prior written approval of the Company. Any unauthorized alteration, forgery or falsification of the content or appearance of this document is unlawful and offenders may be prosecuted to the fullest extent of the law.

Band5_3MHz_QPSK_15_0_LowCH20415-825.5



Band5_5MHz_QPSK_1_24_HighCH20625-846.5



Band5_3MHz_QPSK_15_0_HighCH20635-847.5



Band5_5MHz_QPSK_25_0_LowCH20425-826.5

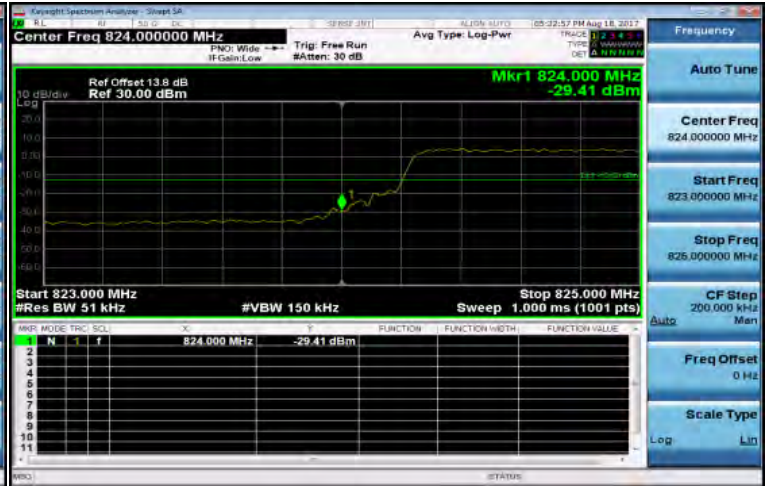

Band5_5MHz_QPSK_1_0_LowCH20425-826.5

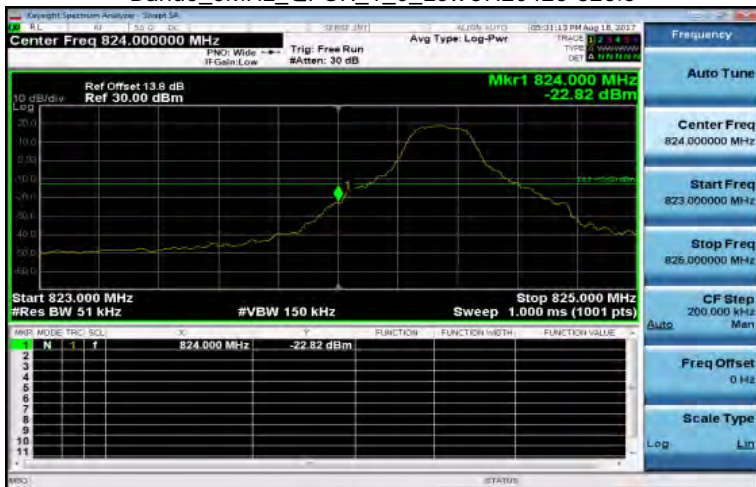

Band5_5MHz_QPSK_25_0_HighCH20625-846.5



Unless otherwise stated the results shown in this test report refer only to the sample(s) tested and such sample(s) are retained for 90 days only.

除非另有說明，此報告結果僅對測試之樣品負責，同時此樣品僅保留90天。本報告未經本公司書面許可，不可部份複製。

This document is issued by the Company subject to its General Conditions of Service printed overleaf, available on request or accessible at www.sgs.com/terms_and_conditions.htm and, for electronic format documents, subject to Terms and Conditions for Electronic Documents at www.sgs.com/terms_e-document.htm. Attention is drawn to the limitation of liability, indemnification and jurisdiction issues defined therein. Any holder of this document is advised that information contained hereon reflects the Company's findings at the time of its intervention only and within the limits of Client's instructions, if any. The Company's sole responsibility is to its Client and this document does not exonerate parties to a transaction from exercising all their rights and obligations under the transaction documents. This document cannot be reproduced except in full, without prior written approval of the Company. Any unauthorized alteration, forgery or falsification of the content or appearance of this document is unlawful and offenders may be prosecuted to the fullest extent of the law.

Band5_10MHz_QPSK_1_0_LowCH20450-829



Band5_10MHz_QPSK_50_0_HighCH20600-844



Band5_10MHz_QPSK_1_49_HighCH20600-844



Band5_10MHz_QPSK_50_0_LowCH20450-829



Unless otherwise stated the results shown in this test report refer only to the sample(s) tested and such sample(s) are retained for 90 days only.
除非另有說明，此報告結果僅對測試之樣品負責，同時此樣品僅保留90天。本報告未經本公司書面許可，不可部份複製。

This document is issued by the Company subject to its General Conditions of Service printed overleaf, available on request or accessible at www.sgs.com/terms_and_conditions.htm and, for electronic format documents, subject to Terms and Conditions for Electronic Documents at www.sgs.com/terms_e-document.htm. Attention is drawn to the limitation of liability, indemnification and jurisdiction issues defined therein. Any holder of this document is advised that information contained hereon reflects the Company's findings at the time of its intervention only and within the limits of Client's instructions, if any. The Company's sole responsibility is to its Client and this document does not exonerate parties to a transaction from exercising all their rights and obligations under the transaction documents. This document cannot be reproduced except in full, without prior written approval of the Company. Any unauthorized alteration, forgery or falsification of the content or appearance of this document is unlawful and offenders may be prosecuted to the fullest extent of the law.

10. FIELD STRENGTH OF SPURIOUS RADIATION MEASUREMENT

10.1. Standard Applicable

According to FCC §2.1053,

FCC §22.917(a) , §24.238(a) , §27.53(g)(h) , the magnitude of each spurious and harmonic emission that can be detected when the equipment is operated under the conditions specified in the instruction manual and/ or alignment procedure, shall not be less than $43 + 10 \log$ (mean output power in watts) dBc below the mean power output outside a license's frequency block (-13dBm).

FCC §27.53 (m) (4) shall not be less than $55 + 10 \log$ (mean output power in watt) dBc below the mean power output outside a license's frequency block (-25dBm).

Table 2 — Unwanted Emissions for Mobile, Portable and Low-Power Fixed Subscriber Equipment

Frequency (MHz)	Attenuation (dB)
<2200	$43 + 10 \log_{10}(p)$
2200 - 2288	$70 + 10 \log_{10}(p)$
2288 - 2292	$67 + 10 \log_{10}(p)$
2292 - 2296	$61 + 10 \log_{10}(p)$
2296 - 2300	$55 + 10 \log_{10}(p)$
2300 - 2305	$43 + 10 \log_{10}(p)$
2305 - 2320	$43 + 10 \log_{10}(p)$ ^{Note}
2320 - 2324	$55 + 10 \log_{10}(p)$
2324 - 2328	$61 + 10 \log_{10}(p)$
2328 - 2337	$67 + 10 \log_{10}(p)$
2337 - 2341	$61 + 10 \log_{10}(p)$
2341 - 2345	$55 + 10 \log_{10}(p)$
2345 - 2360	$43 + 10 \log_{10}(p)$ ^{Note}
2360 - 2365	$43 + 10 \log_{10}(p)$
2365 - 2395	$70 + 10 \log_{10}(p)$
>2395	$43 + 10 \log_{10}(p)$

Note: Measured at the edges of the highest and lowest frequency range(s) in which the equipment is designed to operate. See Section 5.2 for the permitted frequency ranges for various equipment types.

Unless otherwise stated the results shown in this test report refer only to the sample(s) tested and such sample(s) are retained for 90 days only.

除非另有說明，此報告結果僅對測試之樣品負責，同時此樣品僅保留90天。本報告未經本公司書面許可，不可部份複製。

This document is issued by the Company subject to its General Conditions of Service printed overleaf, available on request or accessible at www.sgs.com/terms_and_conditions.htm and, for electronic format documents, subject to Terms and Conditions for Electronic Documents at www.sgs.com/terms_e-document.htm. Attention is drawn to the limitation of liability, indemnification and jurisdiction issues defined therein. Any holder of this document is advised that information contained hereon reflects the Company's findings at the time of its intervention only and within the limits of Client's instructions, if any. The Company's sole responsibility is to its Client and this document does not exonerate parties to a transaction from exercising all their rights and obligations under the transaction documents. This document cannot be reproduced except in full, without prior written approval of the Company. Any unauthorized alteration, forgery or falsification of the content or appearance of this document is unlawful and offenders may be prosecuted to the fullest extent of the law.

SGS Taiwan Ltd.

No.134,WuKungRoad,NewTaipeiIndustrialPark,WukuDistrict,NewTaipeiCity,Taiwan24803/新北市五股區新北產業園區五工路 134 號

台灣檢驗科技股份有限公司

t (886-2) 2299-3279

f (886-2) 2298-0488

www.tw.sgs.com

Member of SGS Group

10.2. EUT Setup

Radiated Emission Test Set-Up, Frequency Below 1000MHz

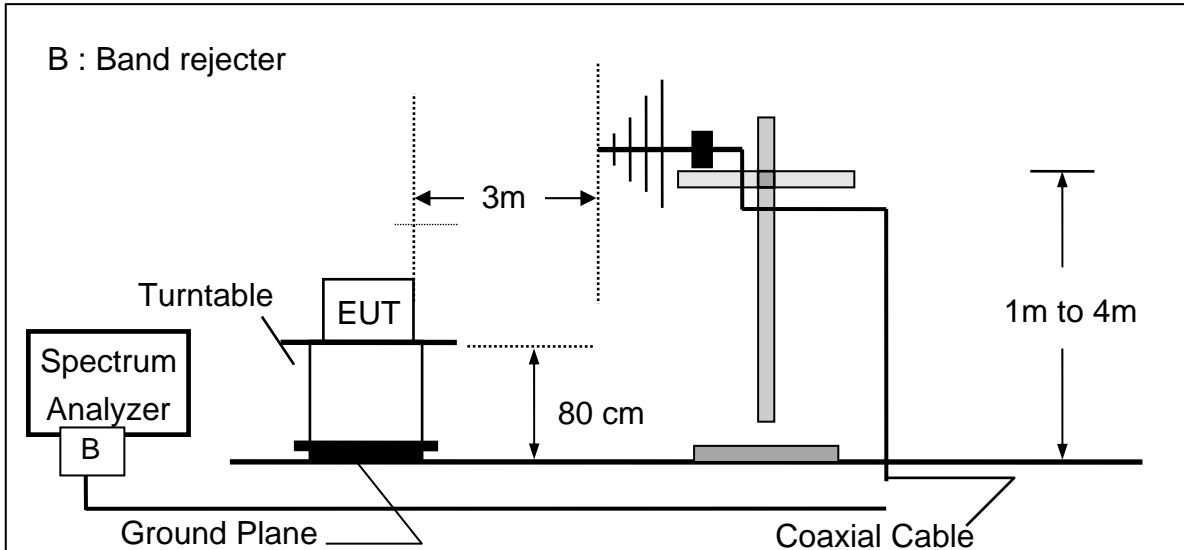

Radiated Emission Test Set-UP Frequency Over 1 GHz

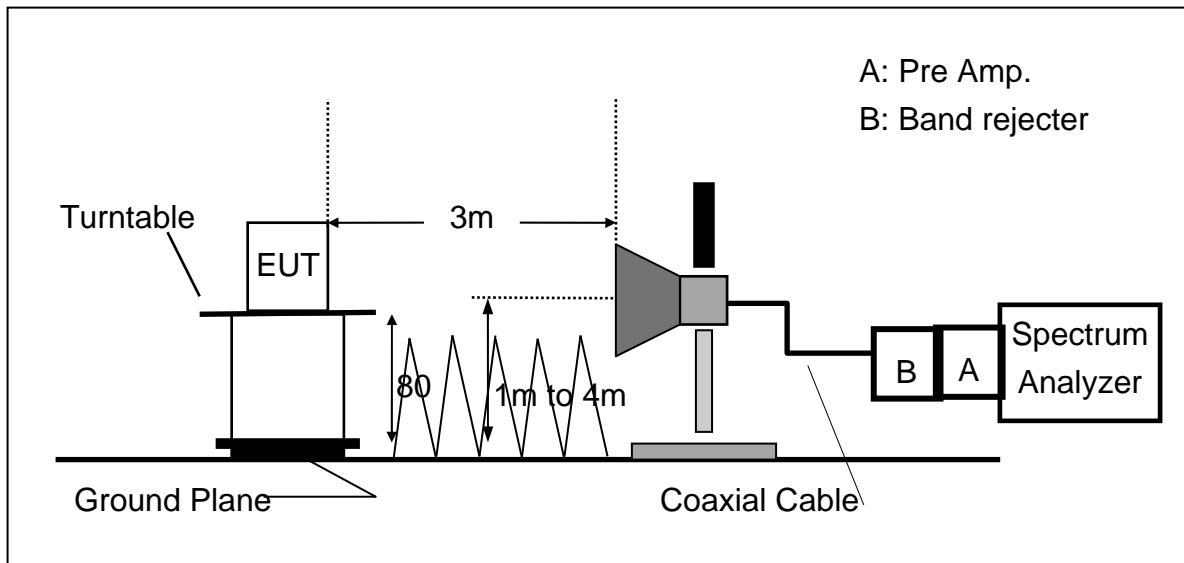

Unless otherwise stated the results shown in this test report refer only to the sample(s) tested and such sample(s) are retained for 90 days only.

除非另有說明，此報告結果僅對測試之樣品負責，同時此樣品僅保留90天。本報告未經本公司書面許可，不可部份複製。

This document is issued by the Company subject to its General Conditions of Service printed overleaf, available on request or accessible at www.sgs.com/terms_and_conditions.htm and, for electronic format documents, subject to Terms and Conditions for Electronic Documents at www.sgs.com/terms_e-document.htm. Attention is drawn to the limitation of liability, indemnification and jurisdiction issues defined therein. Any holder of this document is advised that information contained hereon reflects the Company's findings at the time of its intervention only and within the limits of Client's instructions, if any. The Company's sole responsibility is to its Client and this document does not exonerate parties to a transaction from exercising all their rights and obligations under the transaction documents. This document cannot be reproduced except in full, without prior written approval of the Company. Any unauthorized alteration, forgery or falsification of the content or appearance of this document is unlawful and offenders may be prosecuted to the fullest extent of the law.

10.3. Measurement Procedure:

The EUT was placed on a non-conductive; the measurement antenna was placed at a distance of 3 meters from the EUT. During the tests, the antenna height and the EUT azimuth were varied in order to identify the maximum level of emissions from the EUT. This maximization process was repeated with the EUT positioned in each of its three orthogonal orientations.

The frequency range up to tenth harmonic was investigated for each of three fundamental frequencies (low, middle and high channels). Once spurious emission was identified, the power of the emission was determined using the substitution method.

The spurious emissions attenuation was calculated as the difference between radiated power at the fundamental frequency and the spurious emissions frequency.

$$\text{ERP (dBm)} = \text{SG Level(dBm)} + \text{Antenna Gain(dBd)} + \text{Cable Loss(dB)}$$

$$\text{EIRP (dBm)} = \text{SG Level(dBm)} + \text{Antenna Gain(dBi)} + \text{Cable Loss(dB)}$$

Note : "F" : denotes Fundamental Frequency. ; "H" : denotes Harmonic Frequency.

"E" : denotes Band Edge Frequency. ; "S" : denotes Spurious Frequency.

"---" : denotes Noise Floor.

Unless otherwise stated the results shown in this test report refer only to the sample(s) tested and such sample(s) are retained for 90 days only.

除非另有說明，此報告結果僅對測試之樣品負責，同時此樣品僅保留90天。本報告未經本公司書面許可，不可部份複製。

This document is issued by the Company subject to its General Conditions of Service printed overleaf, available on request or accessible at www.sgs.com/terms_and_conditions.htm and, for electronic format documents, subject to Terms and Conditions for Electronic Documents at www.sgs.com/terms_e-document.htm. Attention is drawn to the limitation of liability, indemnification and jurisdiction issues defined therein. Any holder of this document is advised that information contained hereon reflects the Company's findings at the time of its intervention only and within the limits of Client's instructions, if any. The Company's sole responsibility is to its Client and this document does not exonerate parties to a transaction from exercising all their rights and obligations under the transaction documents. This document cannot be reproduced except in full, without prior written approval of the Company. Any unauthorized alteration, forgery or falsification of the content or appearance of this document is unlawful and offenders may be prosecuted to the fullest extent of the law.

SGS Taiwan Ltd.

No.134,WuKungRoad,NewTaipeiIndustrialPark,WukuDistrict,NewTaipeiCity,Taiwan24803/新北市五股區新北產業園區五工路 134 號

台灣檢驗科技股份有限公司

t (886-2) 2299-3279

f (886-2) 2298-0488

www.tw.sgs.com

Member of SGS Group

10.4. Measurement Equipment Used:

ERP, EIRP MEASUREMENT EQUIPMENT List 966 Chamber					
EQUIPMENT TYPE	MFR	MODEL NUMBER	SERIAL NUMBER	LAST CAL.	CAL DUE.
EMI Test Receiver	R&S	ESC17	100760	05/11/2017	05/10/2018
Spectrum Analyzer	Agilent	E4446A	MY51100003	04/25/2017	04/24/2018
Loop Antenna	ETS-Lindgren	6502	148045	09/20/2016	09/19/2017
Bilog Antenna	SCHWAZBECK	VULB9168	378	12/19/2016	12/18/2017
Horn Antenna	Schwarzbeck	BBHA9120D	1441	07/31/2017	07/30/2018
Pre-Amplifier	Agilent	8447D	2944A07676	01/05/2017	01/04/2018
Pre-Amplifier	EMC Instruments Corp.	EMC0126530	980038	01/05/2017	01/04/2018
Turn Table	HD	DT420	N/A	N.C.R	N.C.R
Antenna Tower	ChamPro	AM-BS-4500-B	060776-ABS	N.C.R	N.C.R
Controller	ChamPro	EM1000	60776	N.C.R	N.C.R
Low Loss Cable	Huber Suhner	966_RX	9	01/05/2017	01/04/2018
3m Site NSA	SGS	966 chamber	N/A	07/01/2017	06/30/2018
Low Loss Cable	Huber Suhner	966 TX	1	01/05/2017	01/04/2018
Horn Antenna	Schwarzbeck	BBHA9170	184	12/12/2016	12/11/2017
Pre-Amplifier	EMC Instruments Corp.	EMC184045	980135	01/05/2017	01/04/2018
Radio Communication Analyer	Anritsu	MT8820C	6201465317	01/03/2017	01/02/2018

Unless otherwise stated the results shown in this test report refer only to the sample(s) tested and such sample(s) are retained for 90 days only.

除非另有說明，此報告結果僅對測試之樣品負責，同時此樣品僅保留90天。本報告未經本公司書面許可，不可部份複製。

This document is issued by the Company subject to its General Conditions of Service printed overleaf, available on request or accessible at www.sgs.com/terms_and_conditions.htm and, for electronic format documents, subject to Terms and Conditions for Electronic Documents at www.sgs.com/terms_e-document.htm. Attention is drawn to the limitation of liability, indemnification and jurisdiction issues defined therein. Any holder of this document is advised that information contained hereon reflects the Company's findings at the time of its intervention only and within the limits of Client's instructions, if any. The Company's sole responsibility is to its Client and this document does not exonerate parties to a transaction from exercising all their rights and obligations under the transaction documents. This document cannot be reproduced except in full, without prior written approval of the Company. Any unauthorized alteration, forgery or falsification of the content or appearance of this document is unlawful and offenders may be prosecuted to the fullest extent of the law.

SGS Taiwan Ltd.

No.134,WuKungRoad,NewTaipeiIndustrialPark,WukuDistrict,NewTaipeiCity,Taiwan24803/新北市五股區新北產業園區五工路 134 號

台灣檢驗科技股份有限公司

t (886-2) 2299-3279

f (886-2) 2298-0488

www.tw.sgs.com

Member of SGS Group

10.5. Measurement Result:

Radiated Spurious Emission Measurement Result: LTE-Band 5 (The Worst Case)

Operation Band :LTE B5 Temp./Humi. :22 deg_C / 61 RH
 Fundamental Frequency :826.5 MHz Engineer :Tin
 Operation Mode :Tx CH LOW
 EUT Pol. :E2 Plane Measurement Antenna Pol.:VERTICAL

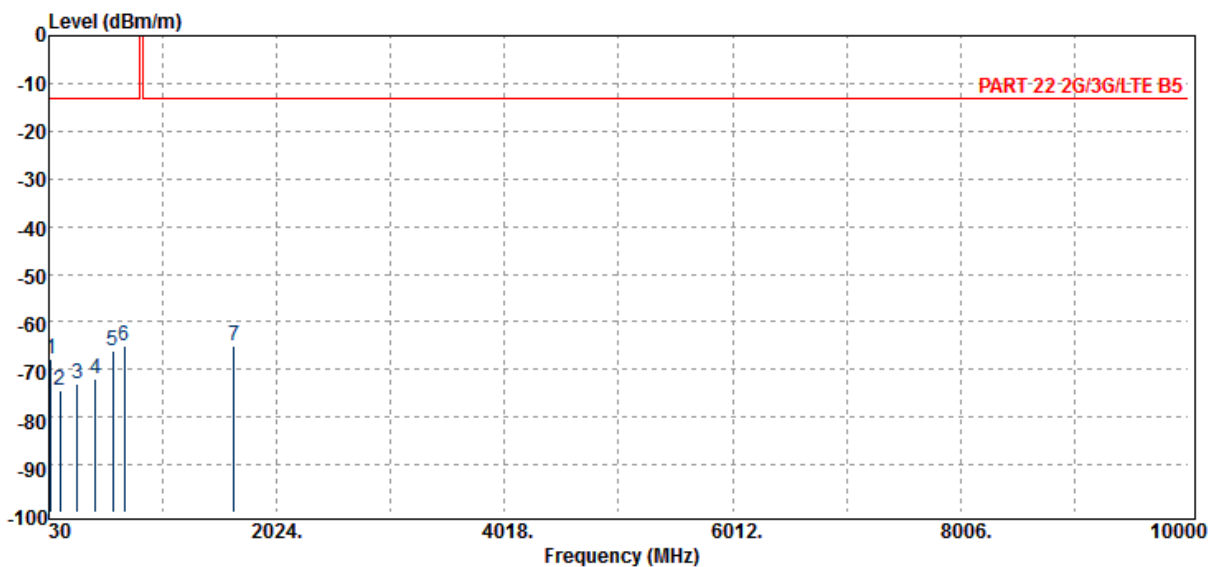

Freq. MHz	Note F/H/E/S	ERP dBm	SG Output Level dBm	Antenna Gain dBd	Cable Loss dB	Limit dBm	Margin dB
48.43	S	-67.80	-55.12	-11.65	-1.04	-13.00	-54.80
124.09	S	-74.25	-70.39	-2.52	-1.34	-13.00	-61.25
278.32	S	-72.85	-74.42	3.44	-1.87	-13.00	-59.85
438.37	S	-71.88	-73.35	3.68	-2.22	-13.00	-58.88
592.60	S	-66.20	-66.70	3.29	-2.79	-13.00	-53.20
692.51	S	-65.06	-65.31	3.09	-2.84	-13.00	-52.06
1653.00	H	-65.19	-68.08	7.12	-4.24	-13.00	-52.19

Unless otherwise stated the results shown in this test report refer only to the sample(s) tested and such sample(s) are retained for 90 days only.

除非另有說明，此報告結果僅對測試之樣品負責，同時此樣品僅保留90天。本報告未經本公司書面許可，不可部份複製。

This document is issued by the Company subject to its General Conditions of Service printed overleaf, available on request or accessible at www.sgs.com/terms_and_conditions.htm and, for electronic format documents, subject to Terms and Conditions for Electronic Documents at www.sgs.com/terms_e-document.htm. Attention is drawn to the limitation of liability, indemnification and jurisdiction issues defined therein. Any holder of this document is advised that information contained hereon reflects the Company's findings at the time of its intervention only and within the limits of Client's instructions, if any. The Company's sole responsibility is to its Client and this document does not exonerate parties to a transaction from exercising all their rights and obligations under the transaction documents. This document cannot be reproduced except in full, without prior written approval of the Company. Any unauthorized alteration, forgery or falsification of the content or appearance of this document is unlawful and offenders may be prosecuted to the fullest extent of the law.

SGS Taiwan Ltd.

No.134,WuKungRoad,NewTaipeiIndustrialPark,WukuDistrict,NewTaipeiCity,Taiwan24803/新北市五股區新北產業園區五工路 134 號

台灣檢驗科技股份有限公司

t (886-2) 2299-3279

f (886-2) 2298-0488

www.tw.sgs.com

Member of SGS Group

Operation Band	:LTE B5	Temp./Humi.	:22 deg_C / 61 RH
Fundamental Frequency	:826.5 MHz	Engineer	:Tin
Operation Mode	:Tx CH LOW		
EUT Pol.	:E2 Plane	Measurement Antenna Pol.	:HORIZONTAL

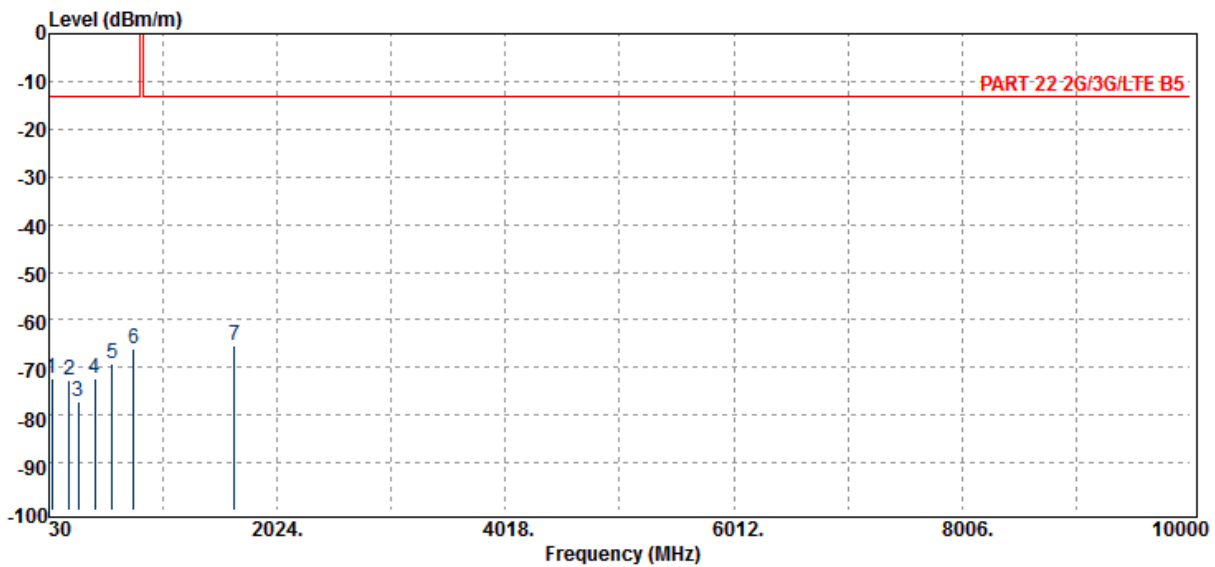

Freq. MHz	Note F/H/E/S	ERP dBm	SG Output Level dBm	Antenna Gain dBd	Cable Loss dB	Limit dBm	Margin dB
56.19	S	-72.37	-61.62	-9.69	-1.07	-13.00	-59.37
203.63	S	-72.53	-74.14	3.26	-1.65	-13.00	-59.53
287.05	S	-77.08	-78.60	3.43	-1.91	-13.00	-64.08
430.61	S	-72.23	-73.68	3.71	-2.26	-13.00	-59.23
581.93	S	-69.31	-69.88	3.36	-2.79	-13.00	-56.31
770.11	S	-65.99	-66.28	3.25	-2.95	-13.00	-52.99
1653.00	H	-65.37	-68.26	7.12	-4.24	-13.00	-52.37

Unless otherwise stated the results shown in this test report refer only to the sample(s) tested and such sample(s) are retained for 90 days only.

除非另有說明，此報告結果僅對測試之樣品負責，同時此樣品僅保留90天。本報告未經本公司書面許可，不可部份複製。

This document is issued by the Company subject to its General Conditions of Service printed overleaf, available on request or accessible at www.sgs.com/terms_and_conditions.htm and, for electronic format documents, subject to Terms and Conditions for Electronic Documents at www.sgs.com/terms_e-document.htm. Attention is drawn to the limitation of liability, indemnification and jurisdiction issues defined therein. Any holder of this document is advised that information contained hereon reflects the Company's findings at the time of its intervention only and within the limits of Client's instructions, if any. The Company's sole responsibility is to its Client and this document does not exonerate parties to a transaction from exercising all their rights and obligations under the transaction documents. This document cannot be reproduced except in full, without prior written approval of the Company. Any unauthorized alteration, forgery or falsification of the content or appearance of this document is unlawful and offenders may be prosecuted to the fullest extent of the law.

SGS Taiwan Ltd.

No.134,WuKungRoad,NewTaipeiIndustrialPark,WukuDistrict,NewTaipeiCity,Taiwan24803/新北市五股區新北產業園區五工路 134 號

台灣檢驗科技股份有限公司

t (886-2) 2299-3279

f (886-2) 2298-0488

www.tw.sgs.com

Member of SGS Group

Operation Band	:LTE B5	Temp./Humi.	:22 deg_C / 61 RH
Fundamental Frequency	:836.5 MHz	Engineer	:Tin
Operation Mode	:Tx CH MID		
EUT Pol.	:E2 Plane	Measurement Antenna	:VERTICAL
		Pol.	

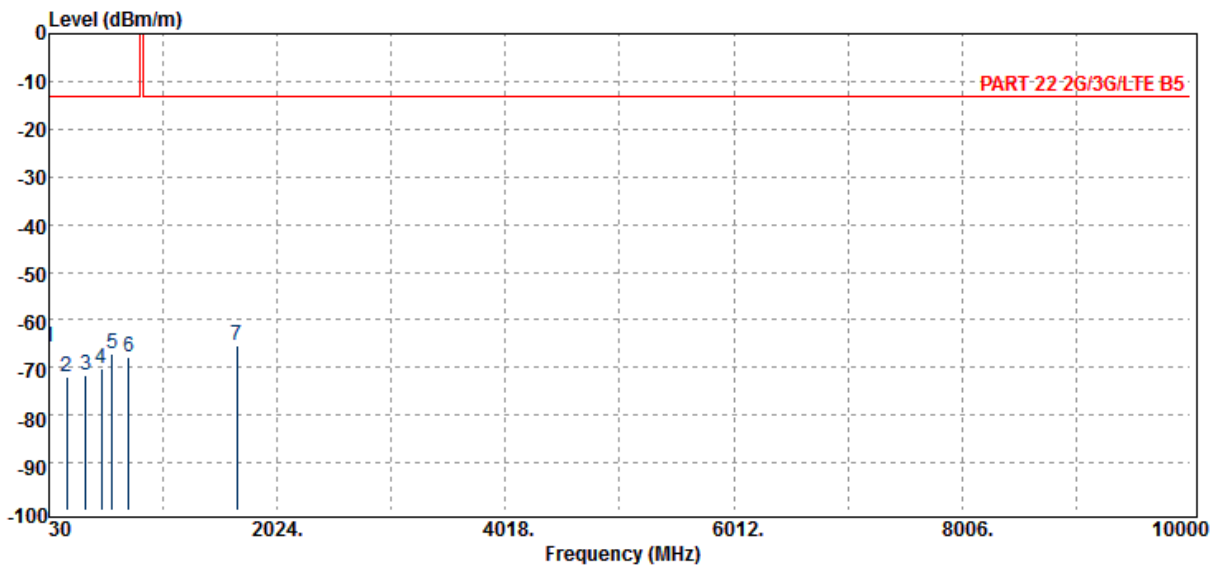

Freq. MHz	Note F/H/E/S	ERP dBm	SG Output Level dBm	Antenna Gain dBd	Cable Loss dB	Limit dBm	Margin dB
34.85	S	-65.85	-51.21	-13.67	-0.97	-13.00	-52.85
187.14	S	-72.13	-72.63	2.09	-1.59	-13.00	-59.13
348.16	S	-71.71	-73.53	3.85	-2.03	-13.00	-58.71
484.93	S	-70.22	-71.76	3.80	-2.25	-13.00	-57.22
579.02	S	-67.28	-67.88	3.38	-2.78	-13.00	-54.28
722.58	S	-67.73	-67.77	3.13	-3.09	-13.00	-54.73
1673.00	H	-65.23	-68.14	7.20	-4.29	-13.00	-52.23

Unless otherwise stated the results shown in this test report refer only to the sample(s) tested and such sample(s) are retained for 90 days only.

除非另有說明，此報告結果僅對測試之樣品負責，同時此樣品僅保留90天。本報告未經本公司書面許可，不可部份複製。

This document is issued by the Company subject to its General Conditions of Service printed overleaf, available on request or accessible at www.sgs.com/terms_and_conditions.htm and, for electronic format documents, subject to Terms and Conditions for Electronic Documents at www.sgs.com/terms_e-document.htm. Attention is drawn to the limitation of liability, indemnification and jurisdiction issues defined therein. Any holder of this document is advised that information contained hereon reflects the Company's findings at the time of its intervention only and within the limits of Client's instructions, if any. The Company's sole responsibility is to its Client and this document does not exonerate parties to a transaction from exercising all their rights and obligations under the transaction documents. This document cannot be reproduced except in full, without prior written approval of the Company. Any unauthorized alteration, forgery or falsification of the content or appearance of this document is unlawful and offenders may be prosecuted to the fullest extent of the law.

SGS Taiwan Ltd.

No.134,WuKungRoad,NewTaipeiIndustrialPark,WukuDistrict,NewTaipeiCity,Taiwan24803/新北市五股區新北產業園區五工路 134 號

台灣檢驗科技股份有限公司

t (886-2) 2299-3279

f (886-2) 2298-0488

www.tw.sgs.com

Member of SGS Group

Operation Band	:LTE B5	Temp./Humi.	:22 deg_C / 61 RH
Fundamental Frequency	:836.5 MHz	Engineer	:Tin
Operation Mode	:Tx CH MID		
EUT Pol.	:E2 Plane	Measurement Antenna	:HORIZONTAL
		Pol.	

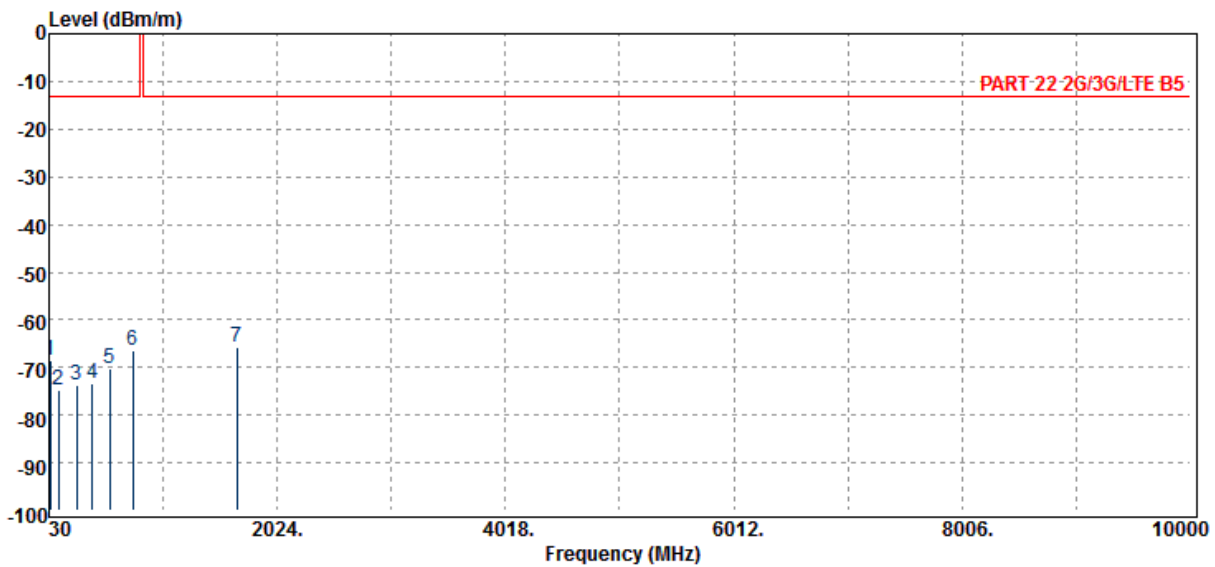

Freq. MHz	Note F/H/E/S	ERP dBm	SG Output Level dBm	Antenna Gain dBd	Cable Loss dB	Limit dBm	Margin dB
42.61	S	-68.38	-54.68	-12.69	-1.01	-13.00	-55.38
112.45	S	-74.82	-71.05	-2.48	-1.30	-13.00	-61.82
272.50	S	-73.67	-75.31	3.49	-1.84	-13.00	-60.67
407.33	S	-73.41	-74.78	3.79	-2.42	-13.00	-60.41
563.50	S	-70.17	-70.90	3.49	-2.76	-13.00	-57.17
764.29	S	-66.42	-66.66	3.23	-2.99	-13.00	-53.42
1673.00	H	-65.63	-68.54	7.20	-4.29	-13.00	-52.63

Unless otherwise stated the results shown in this test report refer only to the sample(s) tested and such sample(s) are retained for 90 days only.

除非另有說明，此報告結果僅對測試之樣品負責，同時此樣品僅保留90天。本報告未經本公司書面許可，不可部份複製。

This document is issued by the Company subject to its General Conditions of Service printed overleaf, available on request or accessible at www.sgs.com/terms_and_conditions.htm and, for electronic format documents, subject to Terms and Conditions for Electronic Documents at www.sgs.com/terms_e-document.htm. Attention is drawn to the limitation of liability, indemnification and jurisdiction issues defined therein. Any holder of this document is advised that information contained hereon reflects the Company's findings at the time of its intervention only and within the limits of Client's instructions, if any. The Company's sole responsibility is to its Client and this document does not exonerate parties to a transaction from exercising all their rights and obligations under the transaction documents. This document cannot be reproduced except in full, without prior written approval of the Company. Any unauthorized alteration, forgery or falsification of the content or appearance of this document is unlawful and offenders may be prosecuted to the fullest extent of the law.

SGS Taiwan Ltd.

No.134,WuKungRoad,NewTaipeiIndustrialPark,WukuDistrict,NewTaipeiCity,Taiwan24803/新北市五股區新北產業園區五工路 134 號

台灣檢驗科技股份有限公司

t (886-2) 2299-3279

f (886-2) 2298-0488

www.tw.sgs.com

Member of SGS Group

Operation Band	:LTE B5	Temp./Humi.	:22 deg_C / 61 RH
Fundamental Frequency	:846.5 MHz	Engineer	:Tin
Operation Mode	:Tx CH HIGH		
EUT Pol.	:E2 Plane	Measurement Antenna	:VERTICAL
		Pol.	

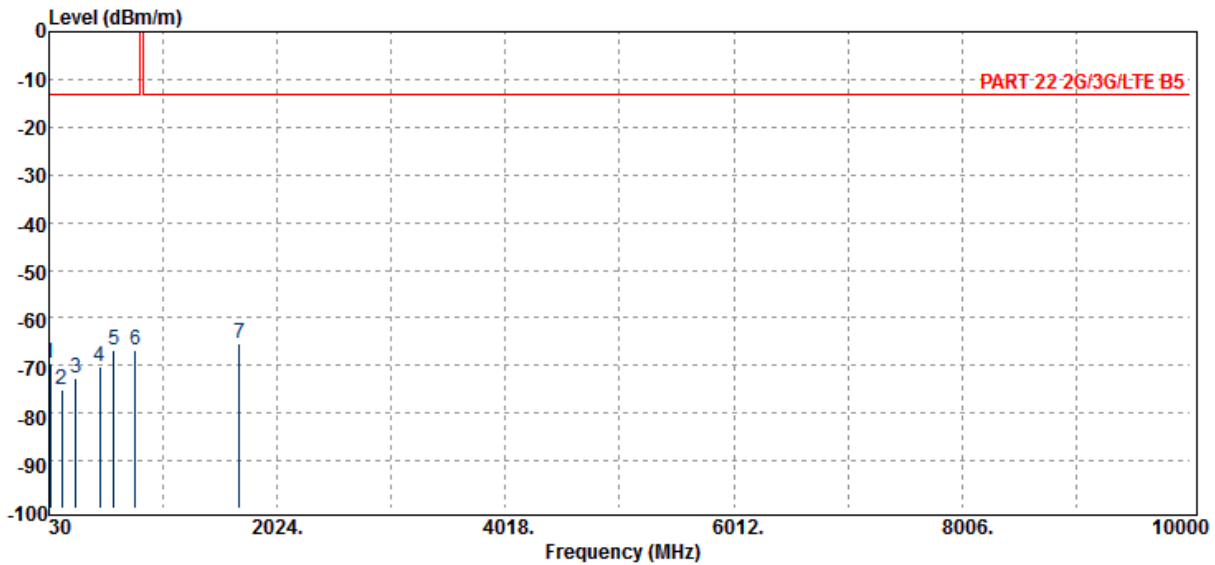

Freq. MHz	Note F/H/E/S	ERP dBm	SG Output Level dBm	Antenna Gain dBd	Cable Loss dB	Limit dBm	Margin dB
43.58	S	-69.63	-56.06	-12.55	-1.01	-13.00	-56.63
143.49	S	-75.03	-71.14	-2.48	-1.41	-13.00	-62.03
262.80	S	-72.61	-74.45	3.63	-1.79	-13.00	-59.61
476.20	S	-70.20	-71.73	3.76	-2.23	-13.00	-57.20
595.51	S	-66.87	-67.37	3.27	-2.77	-13.00	-53.87
785.63	S	-66.86	-67.25	3.30	-2.91	-13.00	-53.86
1693.00	H	-65.36	-68.32	7.27	-4.30	-13.00	-52.36

Unless otherwise stated the results shown in this test report refer only to the sample(s) tested and such sample(s) are retained for 90 days only.
除非另有說明，此報告結果僅對測試之樣品負責，同時此樣品僅保留90天。本報告未經本公司書面許可，不可部份複製。

This document is issued by the Company subject to its General Conditions of Service printed overleaf, available on request or accessible at www.sgs.com/terms_and_conditions.htm and, for electronic format documents, subject to Terms and Conditions for Electronic Documents at www.sgs.com/terms_e-document.htm. Attention is drawn to the limitation of liability, indemnification and jurisdiction issues defined therein. Any holder of this document is advised that information contained hereon reflects the Company's findings at the time of its intervention only and within the limits of Client's instructions, if any. The Company's sole responsibility is to its Client and this document does not exonerate parties to a transaction from exercising all their rights and obligations under the transaction documents. This document cannot be reproduced except in full, without prior written approval of the Company. Any unauthorized alteration, forgery or falsification of the content or appearance of this document is unlawful and offenders may be prosecuted to the fullest extent of the law.

Operation Band	:LTE B5	Temp./Humi.	:22 deg_C / 61 RH
Fundamental Frequency	:846.5 MHz	Engineer	:Tin
Operation Mode	:Tx CH HIGH		
EUT Pol.	:E2 Plane	Measurement Antenna Pol.	:HORIZONTAL

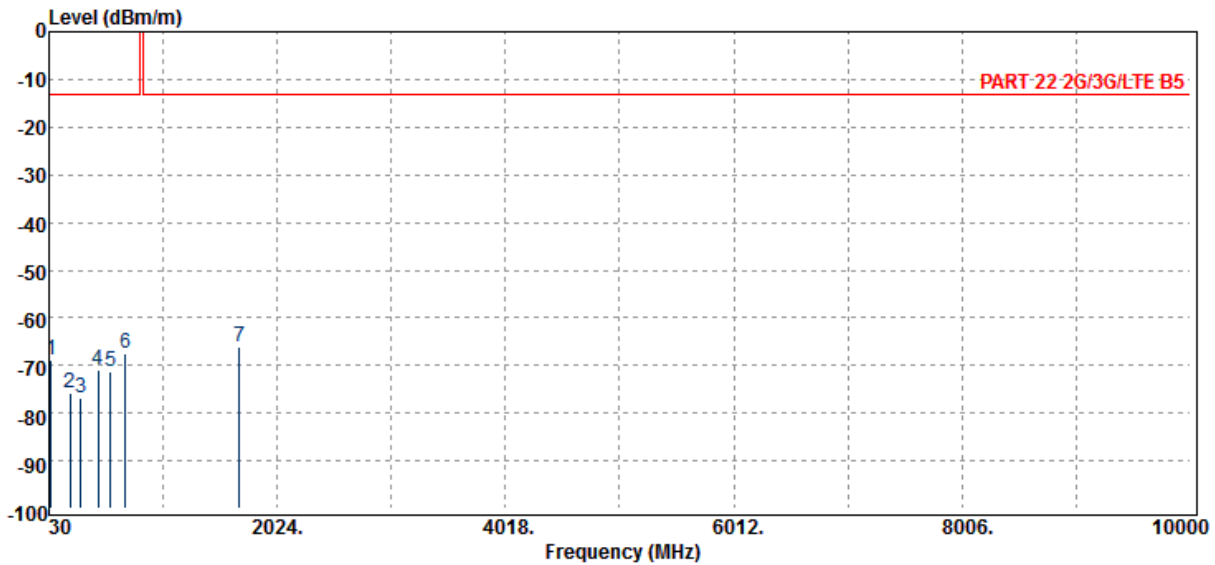

Freq. MHz	Note F/H/E/S	ERP dBm	SG Output Level dBm	Antenna Gain dBd	Cable Loss dB	Limit dBm	Margin dB
48.43	S	-68.82	-56.14	-11.65	-1.04	-13.00	-55.82
217.21	S	-75.78	-77.47	3.38	-1.69	-13.00	-62.78
308.39	S	-76.68	-78.41	3.67	-1.94	-13.00	-63.68
458.74	S	-70.99	-72.47	3.68	-2.20	-13.00	-57.99
566.41	S	-71.43	-72.13	3.47	-2.77	-13.00	-58.43
697.36	S	-67.62	-67.77	3.08	-2.93	-13.00	-54.62
1693.00	H	-66.02	-68.98	7.27	-4.30	-13.00	-53.02

Unless otherwise stated the results shown in this test report refer only to the sample(s) tested and such sample(s) are retained for 90 days only.
除非另有說明，此報告結果僅對測試之樣品負責，同時此樣品僅保留90天。本報告未經本公司書面許可，不可部份複製。

This document is issued by the Company subject to its General Conditions of Service printed overleaf, available on request or accessible at www.sgs.com/terms_and_conditions.htm and, for electronic format documents, subject to Terms and Conditions for Electronic Documents at www.sgs.com/terms_e-document.htm. Attention is drawn to the limitation of liability, indemnification and jurisdiction issues defined therein. Any holder of this document is advised that information contained hereon reflects the Company's findings at the time of its intervention only and within the limits of Client's instructions, if any. The Company's sole responsibility is to its Client and this document does not exonerate parties to a transaction from exercising all their rights and obligations under the transaction documents. This document cannot be reproduced except in full, without prior written approval of the Company. Any unauthorized alteration, forgery or falsification of the content or appearance of this document is unlawful and offenders may be prosecuted to the fullest extent of the law.

11. FREQUENCY STABILITY MEASUREMENT

11.1. Standard Applicable:

The frequency stability shall be sufficient to ensure that the fundamental emission stays within the authorized frequency block.

11.2. Test Set-up:

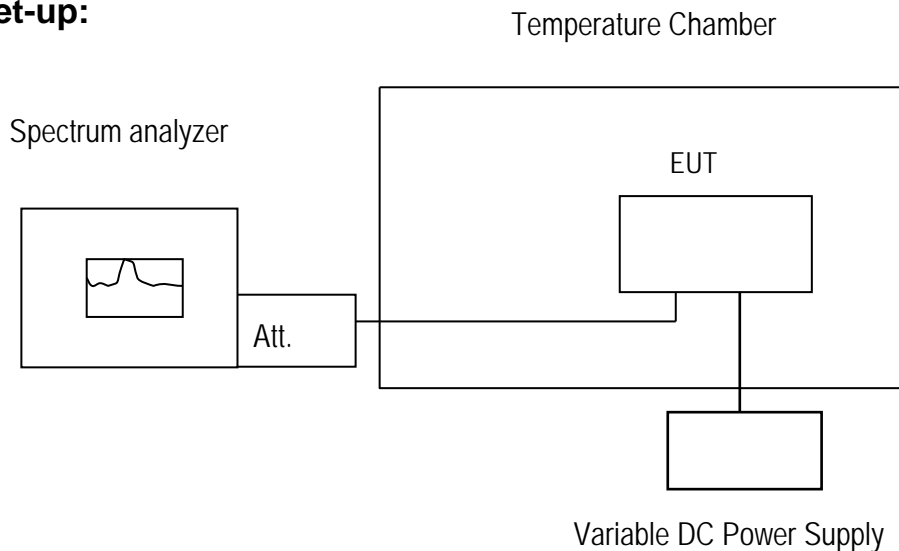

Note: Measurement setup for testing on Antenna connector

11.3. Measurement Procedure:

The equipment under test was connected to an external AC or DC power supply and input rated voltage. RF output was connected to a frequency counter or spectrum analyzer via feed through attenuators. The EUT was placed inside the temperature chamber. Set the spectrum analyzer RBW low enough to obtain the desired frequency resolution and measure EUT 25°C operating frequency as reference frequency. Turn EUT off and set the chamber temperature to -30°C. After the temperature stabilized for approximately 30 minutes recorded the frequency. Repeat step measure with 10°C increased per stage until the highest temperature of +50°C reached.

Set chamber temperature to 25 . Use a variable AC power supply / DC power source to power the EUT and set the voltage to rated voltage. Set the spectrum analyzer RBW low enough to obtain the desired frequency resolution and recorded the frequency.

Reduce the input voltage to specify extreme voltage variation (+/- 15%) and endpoint as declared by the manufacturer, record the maximum frequency change.

Unless otherwise stated the results shown in this test report refer only to the sample(s) tested and such sample(s) are retained for 90 days only.

除非另有說明，此報告結果僅對測試之樣品負責，同時此樣品僅保留90天。本報告未經本公司書面許可，不可部份複製。

This document is issued by the Company subject to its General Conditions of Service printed overleaf, available on request or accessible at www.sgs.com/terms_and_conditions.htm and, for electronic format documents, subject to Terms and Conditions for Electronic Documents at www.sgs.com/terms_e-document.htm. Attention is drawn to the limitation of liability, indemnification and jurisdiction issues defined therein. Any holder of this document is advised that information contained hereon reflects the Company's findings at the time of its intervention only and within the limits of Client's instructions, if any. The Company's sole responsibility is to its Client and this document does not exonerate parties to a transaction from exercising all their rights and obligations under the transaction documents. This document cannot be reproduced except in full, without prior written approval of the Company. Any unauthorized alteration, forgery or falsification of the content or appearance of this document is unlawful and offenders may be prosecuted to the fullest extent of the law.

11.4. Measurement Equipment Used:

Conducted Emission (measured at antenna port) Test Site					
EQUIPMENT TYPE	MFR	MODEL NUMBER	SERIAL NUMBER	LAST CAL.	CAL DUE.
EXA Spectrum Analyzer	Agilent	N9030A	MY53120760	03/21/2017	03/20/2018
DC Block	Mini-Circuits	BLK-18-S+	1	01/05/2017	01/04/2018
Coaxial Cable	HUBER+SUHNER	SUCOFLEX 102	23670/2	01/05/2017	01/04/2018
Attenuator	Mini-Circuit	BW-S10W2+	2	01/05/2017	01/04/2018
Splitter	Agilent	11636B	N/A	01/05/2017	01/04/2018
DC Power Supply	Agilent	E3640A	MY52410006	11/21/2016	11/20/2017
Temperature Chamber	TERCHY	MHG-120LF	911009	05/19/2017	05/18/2018
Radio Communication Analyer	Anritsu	MT8820C	6201465317	01/03/2017	01/02/2018

11.5. Measurement Result:

Reference Freq.:		LTE B5 Mid Channel		836.5 MHz 10M QPSK CH 20525	
Power Supply Vdc	Temp. ()	Freq. (MHz)	Delta (Hz)	Limit = +/- 2.5 ppm (Hz)	
Freq. ERROR vs. VOLTAGE					
4.4	25	836.4999619	-52.5	2091	
3.85	25	836.5000144	0	2091	
3.5	25	836.497251	-2763	2091	
2.5 (End Point)	25	836.4999728	-41.6	2091	
Freq. ERROR vs. Temp.					
3.85	-30	836.4999586	-8.7	2091	
3.85	-20	836.4999655	-1.8	2091	
3.85	-10	836.5000212	53.9	2091	
3.85	0	836.4999743	7	2091	
3.85	10	836.5000169	49.6	2091	
3.85	20	836.4999673	0	2091	
3.85	30	836.4999631	-4.2	2091	
3.85	40	836.4999708	3.5	2091	
3.85	50	836.5000012	33.9	2091	

Unless otherwise stated the results shown in this test report refer only to the sample(s) tested and such sample(s) are retained for 90 days only.

除非另有說明，此報告結果僅對測試之樣品負責，同時此樣品僅保留90天。本報告未經本公司書面許可，不可部份複製。

This document is issued by the Company subject to its General Conditions of Service printed overleaf, available on request or accessible at www.sgs.com/terms_and_conditions.htm and, for electronic format documents, subject to Terms and Conditions for Electronic Documents at www.sgs.com/terms_e-document.htm. Attention is drawn to the limitation of liability, indemnification and jurisdiction issues defined therein. Any holder of this document is advised that information contained hereon reflects the Company's findings at the time of its intervention only and within the limits of Client's instructions, if any. The Company's sole responsibility is to its Client and this document does not exonerate parties to a transaction from exercising all their rights and obligations under the transaction documents. This document cannot be reproduced except in full, without prior written approval of the Company. Any unauthorized alteration, forgery or falsification of the content or appearance of this document is unlawful and offenders may be prosecuted to the fullest extent of the law.

12. PEAK TO AVERAGE RATIO

12.1. Standard Applicable

The peak-to-average ratio (PAR) of the transmission may not exceed 13dB.

12.2. Test SET-UP

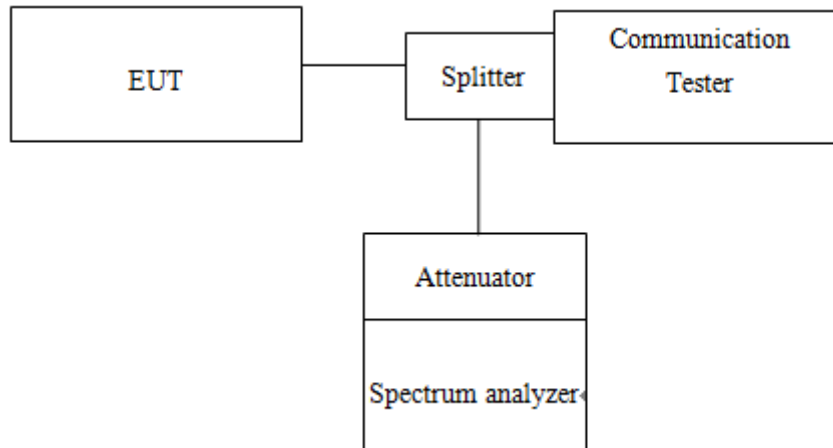

12.3. Measurement Procedure

1. KDB 971168 D01 is employed as the following procedure is proper adjusted accordingly:
2. Set resolution/measurement bandwidth \geq signal's occupied bandwidth; & internal =1ms
3. Set the number of counts to a value that stabilizes the measured CCDF curve.

12.4. Measurement Equipment Used

Conducted Emission (measured at antenna port) Test Site					
EQUIPMENT TYPE	MFR	MODEL NUMBER	SERIAL NUMBER	LAST CAL.	CAL DUE.
EXA Spectrum Analyzer	Agilent	N9030A	MY53120760	03/21/2017	03/20/2018
DC Block	Mini-Circuits	BLK-18-S+	1	01/05/2017	01/04/2018
Coaxial Cable	HUBER+SUHNER	SUCOFLEX 102	23670/2	01/05/2017	01/04/2018
Attenuator	Mini-Circuit	BW-S10W2+	2	01/05/2017	01/04/2018
Splitter	Agilent	11636B	N/A	01/05/2017	01/04/2018
DC Power Supply	Agilent	E3640A	MY52410006	11/21/2016	11/20/2017
Temperature Chamber	TERCHY	MHG-120LF	911009	05/19/2017	05/18/2018
Radio Communication Analyer	Anritsu	MT8820C	6201465317	01/03/2017	01/02/2018

Unless otherwise stated the results shown in this test report refer only to the sample(s) tested and such sample(s) are retained for 90 days only.

除非另有說明，此報告結果僅對測試之樣品負責，同時此樣品僅保留90天。本報告未經本公司書面許可，不可部份複製。

This document is issued by the Company subject to its General Conditions of Service printed overleaf, available on request or accessible at www.sgs.com/terms_and_conditions.htm and, for electronic format documents, subject to Terms and Conditions for Electronic Documents at www.sgs.com/terms_e-document.htm. Attention is drawn to the limitation of liability, indemnification and jurisdiction issues defined therein. Any holder of this document is advised that information contained hereon reflects the Company's findings at the time of its intervention only and within the limits of Client's instructions, if any. The Company's sole responsibility is to its Client and this document does not exonerate parties to a transaction from exercising all their rights and obligations under the transaction documents. This document cannot be reproduced except in full, without prior written approval of the Company. Any unauthorized alteration, forgery or falsification of the content or appearance of this document is unlawful and offenders may be prosecuted to the fullest extent of the law.

SGS Taiwan Ltd.

No.134,WuKungRoad,NewTaipeiIndustrialPark,WukuDistrict,NewTaipeiCity,Taiwan24803/新北市五股區新北產業園區五工路 134 號

台灣檢驗科技股份有限公司

t (886-2) 2299-3279

f (886-2) 2298-0488

www.tw.sgs.com

Member of SGS Group

12.5. Measurement Result

Tabular Results:

LTE BAND 5							
Channel bandwidth: 1.4MHz				Channel bandwidth: 3MHz			
Freq. (MHz)	CH	Peak-to-Average Ratio		Freq. (MHz)	CH	Peak-to-Average Ratio	
		16QAM	Limit			16QAM	Limit
824.7	20407	6.16	13	825.5	20415	6.16	13
836.5	20525	6.15	13	836.5	20525	6.11	13
848.3	20643	6.15	13	847.5	20635	6.15	13

LTE BAND 5							
Channel bandwidth: 5MHz				Channel bandwidth: 10MHz			
Freq. (MHz)	CH	Peak-to-Average Ratio		Freq. (MHz)	CH	Peak-to-Average Ratio	
		16QAM	Limit			16QAM	Limit
826.5	20425	6.05	13	829.0	20450	6.12	13
836.5	20525	6.10	13	836.5	20525	6.06	13
846.5	20625	5.97	13	844.0	20600	6.03	13

Unless otherwise stated the results shown in this test report refer only to the sample(s) tested and such sample(s) are retained for 90 days only.

除非另有說明，此報告結果僅對測試之樣品負責，同時此樣品僅保留90天。本報告未經本公司書面許可，不可部份複製。

This document is issued by the Company subject to its General Conditions of Service printed overleaf, available on request or accessible at www.sgs.com/terms_and_conditions.htm and, for electronic format documents, subject to Terms and Conditions for Electronic Documents at www.sgs.com/terms_e-document.htm. Attention is drawn to the limitation of liability, indemnification and jurisdiction issues defined therein. Any holder of this document is advised that information contained hereon reflects the Company's findings at the time of its intervention only and within the limits of Client's instructions, if any. The Company's sole responsibility is to its Client and this document does not exonerate parties to a transaction from exercising all their rights and obligations under the transaction documents. This document cannot be reproduced except in full, without prior written approval of the Company. Any unauthorized alteration, forgery or falsification of the content or appearance of this document is unlawful and offenders may be prosecuted to the fullest extent of the law.

SGS Taiwan Ltd.

No.134,WuKungRoad,NewTaipeiIndustrialPark,WukuDistrict,NewTaipeiCity,Taiwan24803/新北市五股區新北產業園區五工路 134 號

台灣檢驗科技股份有限公司

t (886-2) 2299-3279

f (886-2) 2298-0488

www.tw.sgs.com

Member of SGS Group

LTE_Band5_1_4MHz_16QAM_6_0_LowCH20407-824.7



LTE_Band5_3MHz_16QAM_15_0_LowCH20415-825.5



LTE_Band5_1_4MHz_16QAM_6_0_MidCH20525-836.5

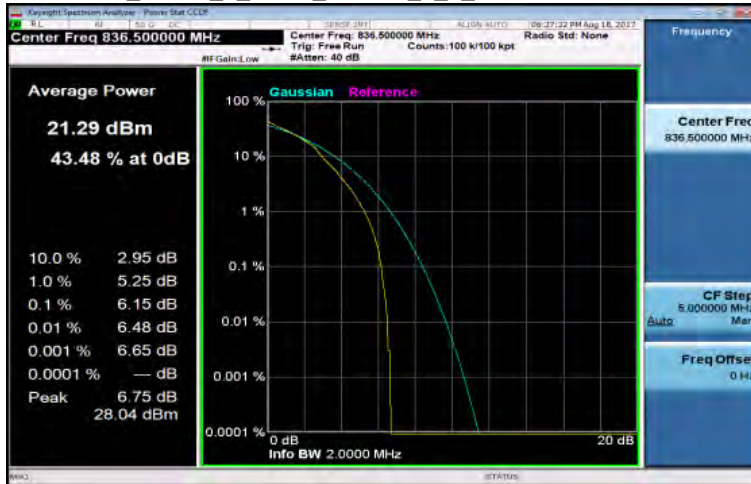

LTE_Band5_3MHz_16QAM_15_0_MidCH20525-836.5



LTE_Band5_1_4MHz_16QAM_6_0_HighCH20643-848.3



LTE_Band5_3MHz_16QAM_15_0_HighCH20635-847.5



Unless otherwise stated the results shown in this test report refer only to the sample(s) tested and such sample(s) are retained for 90 days only.

除非另有說明，此報告結果僅對測試之樣品負責，同時此樣品僅保留90天。本報告未經本公司書面許可，不可部份複製。

This document is issued by the Company subject to its General Conditions of Service printed overleaf, available on request or accessible at www.sgs.com/terms_and_conditions.htm and, for electronic format documents, subject to Terms and Conditions for Electronic Documents at www.sgs.com/terms_e-document.htm. Attention is drawn to the limitation of liability, indemnification and jurisdiction issues defined therein. Any holder of this document is advised that information contained hereon reflects the Company's findings at the time of its intervention only and within the limits of Client's instructions, if any. The Company's sole responsibility is to its Client and this document does not exonerate parties to a transaction from exercising all their rights and obligations under the transaction documents. This document cannot be reproduced except in full, without prior written approval of the Company. Any unauthorized alteration, forgery or falsification of the content or appearance of this document is unlawful and offenders may be prosecuted to the fullest extent of the law.

LTE_Band5_5MHz_16QAM_25_0_LowCH20425-826.5



LTE_Band5_10MHz_16QAM_50_0_LowCH20450-829

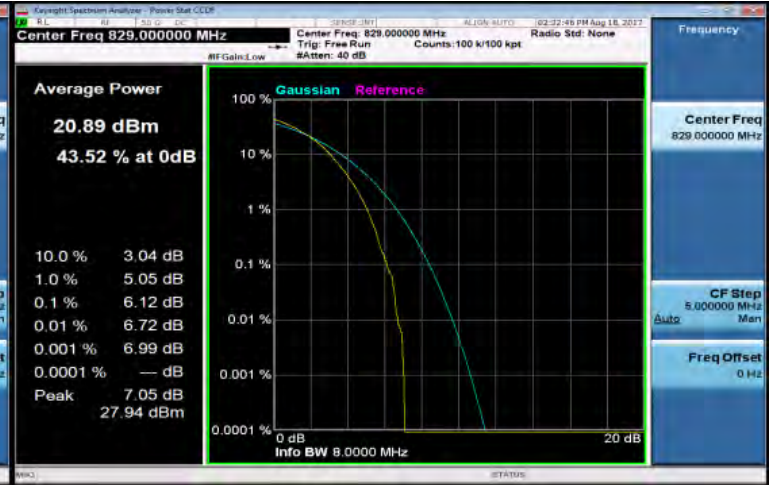

LTE_Band5_5MHz_16QAM_25_0_MidCH20525-836.5

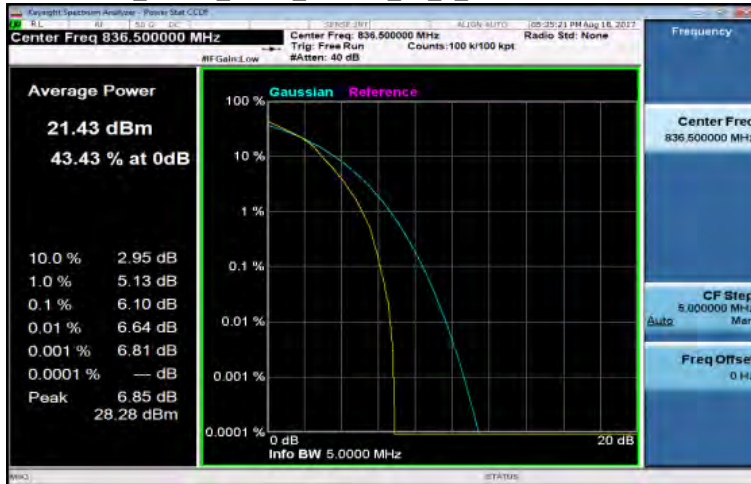

LTE_Band5_10MHz_16QAM_50_0_MidCH20525-836.5

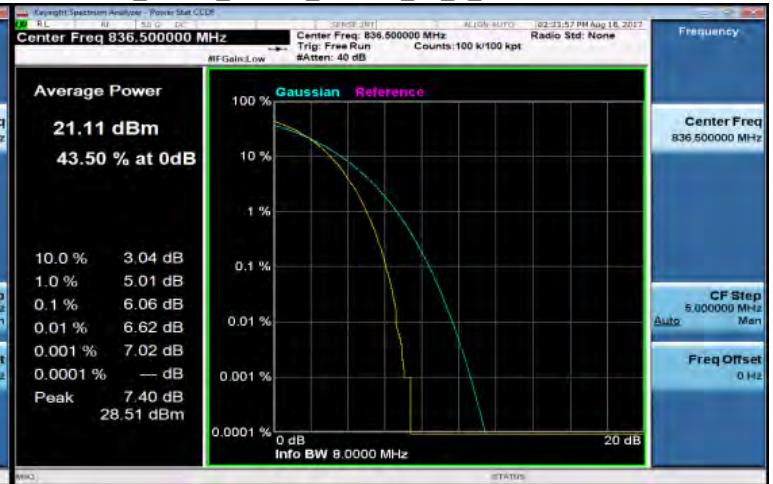

LTE_Band5_5MHz_16QAM_25_0_HighCH20625-846.5



LTE_Band5_10MHz_16QAM_50_0_HighCH20600-844

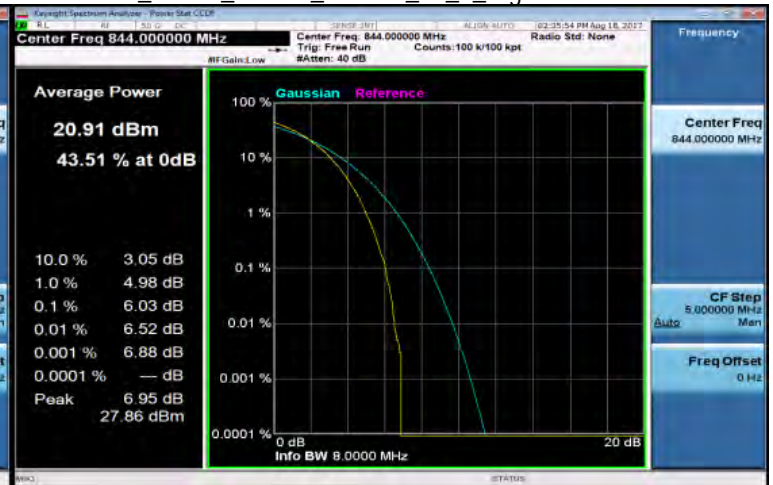

Unless otherwise stated the results shown in this test report refer only to the sample(s) tested and such sample(s) are retained for 90 days only.
除非另有說明，此報告結果僅對測試之樣品負責，同時此樣品僅保留90天。本報告未經本公司書面許可，不可部份複製。

This document is issued by the Company subject to its General Conditions of Service printed overleaf, available on request or accessible at www.sgs.com/terms_and_conditions.htm and, for electronic format documents, subject to Terms and Conditions for Electronic Documents at www.sgs.com/terms_e-document.htm. Attention is drawn to the limitation of liability, indemnification and jurisdiction issues defined therein. Any holder of this document is advised that information contained hereon reflects the Company's findings at the time of its intervention only and within the limits of Client's instructions, if any. The Company's sole responsibility is to its Client and this document does not exonerate parties to a transaction from exercising all their rights and obligations under the transaction documents. This document cannot be reproduced except in full, without prior written approval of the Company. Any unauthorized alteration, forgery or falsification of the content or appearance of this document is unlawful and offenders may be prosecuted to the fullest extent of the law.

PHOTOGRAPHS OF EUT

Please refer to the attached file(EUT Photo)

~ End of Report ~

Unless otherwise stated the results shown in this test report refer only to the sample(s) tested and such sample(s) are retained for 90 days only.

除非另有說明，此報告結果僅對測試之樣品負責，同時此樣品僅保留90天。本報告未經本公司書面許可，不可部份複製。

This document is issued by the Company subject to its General Conditions of Service printed overleaf, available on request or accessible at www.sgs.com/terms_and_conditions.htm and, for electronic format documents, subject to Terms and Conditions for Electronic Documents at www.sgs.com/terms_e-document.htm. Attention is drawn to the limitation of liability, indemnification and jurisdiction issues defined therein. Any holder of this document is advised that information contained hereon reflects the Company's findings at the time of its intervention only and within the limits of Client's instructions, if any. The Company's sole responsibility is to its Client and this document does not exonerate parties to a transaction from exercising all their rights and obligations under the transaction documents. This document cannot be reproduced except in full, without prior written approval of the Company. Any unauthorized alteration, forgery or falsification of the content or appearance of this document is unlawful and offenders may be prosecuted to the fullest extent of the law.

SGS Taiwan Ltd.

No.134,WuKungRoad,NewTaipeiIndustrialPark,WukuDistrict,NewTaipeiCity,Taiwan24803/新北市五股區新北產業園區五工路 134 號

台灣檢驗科技股份有限公司

t (886-2) 2299-3279

f (886-2) 2298-0488

www.tw.sgs.com

Member of SGS Group