



# TEST REPORT

## No. I17Z60314-SRD07

for

**HMD GLOBAL OY**

**Smart Phone**

**MODEL NAME: TA-1033**

**FCC ID: 2AJOTTA-1033**

with

**Hardware Version: 3**

**Software Version: 000C\_1\_130**

**Issued Date: 2017-04-17**



**Note:**

The test results in this test report relate only to the devices specified in this report. This report shall not be reproduced except in full without the written approval of CTTL.

**Test Laboratory:**

CTTL, Telecommunication Technology Labs, Academy of Telecommunication Research, MIIT

No. 52, Huayuan North Road, Haidian District, Beijing, P. R. China 100191.

Tel:+86(0)10-62304633-2512, Fax:+86(0)10-62304633-2504

Email: [ctl\\_terminals@catr.cn](mailto:ctl_terminals@catr.cn), website: [www.chinattl.com](http://www.chinattl.com)



## **CONTENTS**

<b>1. BTEST LABORATORY .....</b>	<b>3</b>
1.1. 8BTESTING LOCATION .....	3
1.2. 9BTESTING ENVIRONMENT.....	3
1.3. 10BPROJECT DATA .....	3
1.4. 11BSIGNATURE .....	3
<b>2. BCLIENT INFORMATION .....</b>	<b>4</b>
2.1. 12BAPPLICANT INFORMATION .....	4
2.2. 13BMANUFACTURER INFORMATION.....	4
<b>3. BEQUIPMENT UNDER TEST (EUT) AND ANCILLARY EQUIPMENT (AE) .....</b>	<b>5</b>
3.1. 14BABOUT EUT .....	5
3.2. 15BINTERNAL IDENTIFICATION OF EUT USED DURING THE TEST .....	5
3.3. 16BINTERNAL IDENTIFICATION OF AE USED DURING THE TEST.....	5
3.4. 17BGENERAL DESCRIPTION.....	5
3.5. 18BEUT SET-UPS .....	6
<b>4. BREFERENCE DOCUMENTS .....</b>	<b>6</b>
4.1. 19BDOCUMENTS SUPPLIED BY THE APPLICANT .....	6
4.2. 20BREGULATIONS AND STANDARDS.....	6
<b>5. BLABORATORY ENVIRONMENT .....</b>	<b>7</b>
<b>6. BSUMMARY OF TEST RESULTS.....</b>	<b>8</b>
6.1. 21BSUMMARY OF TEST RESULTS.....	8
6.2. 22BTERMS USED IN THE SUMMARY OF TEST RESULTS .....	9
6.3. 23BSTATEMENTS.....	9
<b>7. BTEST EQUIPMENTS UTILIZED .....</b>	<b>10</b>
<b>ANNEX A: MEASUREMENT RESULTS.....</b>	<b>11</b>
24BA.1. ELECTRIC FIELD STRENGTH OF FUNDAMENTAL AND OUTSIDE THE ALLOCATED BANDS .....	11
25BA.2. ELECTRIC FIELD RADIATED EMISSIONS (< 30MHZ) .....	13
26BA.3. ELECTRIC FIELD RADIATED EMISSIONS (≥30MHZ) .....	15
27BA.4. FREQUENCY TOLERANCE .....	17
28BA.5. 20DB BANDWIDTH.....	19
29BA.6. CONDUCTED EMISSION .....	20
<b>FINAL RESULT.....</b>	错误!未定义书签。
<b>ANNEX C: TEST LAYOUT .....</b>	错误!未定义书签。

## 1. Test Laboratory

### 1.1. Testing Location

Company Name: CTTL Beijing, Telecommunication Metrology Center of MIIT  
Address: No 52, Huayuanbei Road, Haidian District, Beijing, P.R.China  
Postal Code: 100191  
Telephone: +86-10-62304633-2678  
Fax: +86-10-62304633-2504

### 1.2. Testing Environment

Ambient Temperature: 15 ~ 25 °C  
Relative Humidity: 30 ~ 60 %  
Air pressure 860 ~ 1060 mbar

### 1.3. Project Data

Testing Start Date: 2017-03-28  
Testing End Date: 2017-04-17

### 1.4. Signature

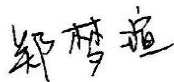

---

Zheng Mengxuan  
(Prepared this test report)



---

Zhu Liang  
( Reviewed this test report)

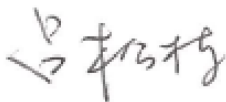

---

Lv Songdong  
(Approved this test report)



## **2. Client Information**

### **2.1. Applicant Information**

Company Name:	HMD Global Oy
Address:	Karaportti 2, 02610 Espoo, Finland
Country:	Finland
Contact	Mikko Kahlos
Tel:	+358-408036126
Email:	mikko.kahlos@hmdglobal.com

### **2.2. Manufacturer Information**

Company Name:	HMD Global Oy
Address:	Karaportti 2, 02610 Espoo, Finland
Country:	Finland
Contact	Mikko Kahlos
Tel:	+358-408036126
Email:	mikko.kahlos@hmdglobal.com

### **3. Equipment Under Test (EUT) and Ancillary Equipment (AE)**

#### **3.1. About EUT**

The smart phone TA-1033 manufactured by HMD GLOBAL OY is a variant model based on TA-1021 for conformance test. According to the declaration of changes, the results are inherited from the initial model. The report number of initial model is I17Z60076-SRD10.

#### **3.2. Internal Identification of EUT Used during the Test**

##### **Mobile phone identification**

<b>EUT ID*</b>	<b>IMEI</b>	<b>HW Version</b>	<b>SW Version</b>
EUT1	356020080007758	3	000C_1_130
EUT2	356020080007956	3	000C_1_130

\*EUT ID: is used to identify the test sample in the lab internally.

#### **3.3. Internal Identification of AE Used during the Test**

<b>AE ID*</b>	<b>Description</b>	<b>SN</b>	<b>Reversion</b>
AE1	Battery	/	INBUILT
AE2	Battery	/	INBUILT
AE3	NFC Card	/	/

##### AE1

Model	HE316
Manufacturer	SCUD(FUJIAN) ELECTRONICS CO LTD
Capacitance	3000mAh
Nominal voltage	3.82V

##### AE2

Model	HE317
Manufacturer	SCUD(FUJIAN) ELECTRONICS CO LTD
Capacitance	3000mAh
Nominal voltage	3.84V

##### AE3

Type	/
Manufacturer	/
Type of card	PICC

\*AE ID: is used to identify the test sample in the lab internally.

#### **3.4. General Description**

This is a product supporting 2.4G/5G technologies.

Manuals and specifications of the EUT were provided to fulfil the test.

Samples undergoing test were selected by the client.

Manufacturer's declaration: NFC work does not depend on other access methods, such as WLAN, GPRS, etc.

### 3.5. EUT Set-ups

EUT Set-up No.	Combination of EUT and AE	Remarks
Set.1	EUT2+AE1+AE3	--
Set.2	EUT2+AE1	

The Transmit State of NFC: the NFC function is on. The EUT will transmit the NFC data and command continuously during the test.

The Transmit State of without modulation: The EUT will transmit the CW signal at the operating frequency.

## 4. Reference Documents

### 4.1. Documents Supplied by the Applicant

EUT feature information is supplied by the applicant or manufacturer, which is the basis of testing.

### 4.2. Regulations and Standards

The following documents listed in this section are referred for testing.

Reference	Title	Version
CFR 47 Part 2	Part 2 — Frequency Allocations and Radio Treaty Matters; General Rules and Regulations.	2015
CFR 47 Part 15	Part 15 — Radio Frequency Devices. Subpart C — Intentional Radiators. § 15.35 Measurement detector functions and bandwidths. § 15.207 Conducted limits. § 15.209 Radiated emission limits, general requirements. § 15.215 Additional provisions to the general radiated emission limitations. § 15.225 Operation within the band 13.110–14.010 MHz.	2015
ANSI C63.10	American National Standard of Procedures for Compliance Testing of Unlicensed Wireless Devices	2013

## 5. LABORATORY ENVIRONMENT

**Semi-anechoic chamber SAC-1** (23 meters×17meters×10meters) did not exceed following limits along the EMC testing:

Temperature	Min. = 15 °C, Max. = 35 °C
Relative humidity	Min. = 15 %, Max. = 75 %
Shielding effectiveness	0.014MHz - 1MHz, >60dB; 1MHz - 1000MHz, >90dB.
Electrical insulation	> 2 MΩ
Ground system resistance	< 4Ω
Normalised site attenuation (NSA)	< ± 4 dB, 3m/10m distance, from 30 to 1000 MHz
Site voltage standing-wave ratio ( $S_{VSWR}$ )	Between 0 and 6 dB, from 1GHz to 18GHz
Uniformity of field strength	Between 0 and 6 dB, from 80 to 3000 MHz

**Fully-Anechoic Chamber FAC-3** (8.6m×6.1m×3.85m) did not exceed following limits along the testing:

Temperature	Min. = 15 °C, Max. = 25 °C
Relative humidity	Min. = 30 %, Max. = 60 %
Shielding effectiveness	> 110 dB
Electrical insulation	> 2 MΩ
Ground system resistance	< 1 Ω
Site voltage standing-wave ratio ( $S_{VSWR}$ )	Between 0 and 6 dB, from 1 to 18GHz
Uniformity of field strength	Between 0 and 6 dB, from 80 to 4000 MHz

**Conducted Chamber** did not exceed following limits along the testing:

Temperature	Min. = 15 °C, Max. = 25 °C
Relative humidity	Min. = 30 %, Max. = 60 %
Shielding effectiveness	> 110 dB
Electrical insulation	> 2 MΩ
Ground system resistance	< 0.5 Ω

**Control Room** did not exceed following limits along the testing:

Temperature	Min. = 15 °C, Max. = 25 °C
Relative humidity	Min. =30 %, Max. = 60 %
Shielding effectiveness	> 110 dB
Electrical insulation	> 2 MΩ
Ground system resistance	< 0.5 Ω

## 6. SUMMARY OF TEST RESULTS

### 6.1. Summary of Test Results

No	Test Cases	Clause in Regulation	Section in This Report	Verdict
1	Electric Field Strength of Fundamental Emissions	CFR 47 § 15.225(a)	A.1	P(Set. NFC03)
2	Electric Field Strength of Outside the Allocated Bands	CFR 47 § 15.225(b) CFR 47 § 15.225(c)		P(Set. NFC03)
3	Electric Field Radiated Emissions	CFR 47 § 15.209	A.2	P (Set. NFC01)
		CFR 47 § 15.225(d)	A.3	P(Set. NFC01)
4	Frequency Tolerance	CFR 47 § 15.225(e)	A.4	P(Set. NFC02)
5	20dB Bandwidth	CFR 47 § 15.215(c)	A.5	P(Set. NFC02, 03)
6	Conducted Emissions	CFR 47 § 15.207	A.6	P (Set. NFC01)
The measurement is carried out according to ANSI C63.10 See <b>ANNEX A</b> for details.				

#### Test Conditions:

For this report, all the test cases listed above were tested under normal Temperature, Voltage, Humidity, and Air Pressure. The specific conditions are as following:

Temperature	T min	-20 °C
	T nom	25 °C
	T max	55 °C
Voltage	V min	3.6 V
	V nom	3.8 V
	V max	4.2 V
Humidity	H nom	44%
Air Pressure	A nom	1010 mbar



## 6.2. Terms Used in the Summary of Test Results

### Terms Used in Condition Column:

T nom	Normal Temperature
T min	Low Temperature
T max	High Temperature
V nom	Normal Voltage
V min	Low Voltage
V max	High voltage
H nom	Norm Humidity
A nom	Norm Air Pressure

### Terms Used in Verdict Column:

P	Pass, The EUT complies with the essential requirements in the standard.
NP	Not Perform, The test was not performed by CTTL
NA	Not Applicable, The test was not applicable
F	Fail, The EUT does not comply with the essential requirements in the standard

### Abbreviations:

AC	Alternating Current
AFH	Adaptive Frequency Hopping
BW	Band Width
E.I.R.P.	equivalent is tropical radiated power
ISM	Industrial, Scientific and Medical
RF	Radio Frequency
Tx	Transmitter

## 6.3. Statements

The test cases listed in Section 6.1 of this report for the EUT specified in Section 3 were performed by CTTL according to the reference documents in Section 4.

The EUT meets all applicable requirements of the regulations and standards in Section 4.2.

This report only deals with the NFC function among the features described in section 3.

## **7. Test Equipments Utilized**

<b>NO.</b>	<b>NAME</b>	<b>TYPE</b>	<b>SERIES NUMBER</b>	<b>PRODUCER</b>	<b>CAL. DUE DATE</b>
1.	Thermal Chamber	PL-2G	343074	ESPEC	2017-05-12
2.	Spectrum Analyzer	RSA3408A	B 010277	Tektronix	2017-05-27
3.	H-field Antenna	HFH2-Z2	829324/0007	R&S	2017-12-16
4.	EMI Antenna	VULB 9163	9163-235	Schwarz beck	2018-03-02
5.	Test Receiver	ESCI	100344	R&S	2018-03-01
6.	Universal Radio Communication Tester	CMW500	143008	R&S	2017-12-01
7.	Universal Radio Communication Tester	CMW500	116588	R&S	2017-12-01
8.	Spectrum Analyzer	E4440A	MY48250642	Agilent	2018-03-03
9.	LISN	ESH2-Z5	829991/012	R&S	2018-04-11

## **ANNEX A: MEASUREMENT RESULTS**

### **A.1. Electric Field Strength of Fundamental and Outside the Allocated bands**

#### **A.1.1. Reference**

See Clause 13.5, Clause 13.4, Clause 8, and Annex E of ANSI C63.10-2013 specifically.  
See Clause 4, Clause 5, and Clause 6 of ANSI C63.10-2013 generally.

#### **A.1.2. Measurement Methods**

The transmitter carrier output levels (E-Field) from the EUT are measured in a semi-anechoic chamber. The EUT is placed on a non-conductive stand of 80cm high, and at a measurement distance of 3m from the receiving antenna. The center of the receiving loop antenna is 1.0 meter above the ground. The E-field is measured with a shielded loop antenna connected to a measurement receiver. Detected E-field was maximized by rotating the EUT through 360° and adjusting the receiving antenna polarizations. The maximization processes were repeated with the EUT positioned respectively in its three orthogonal axes. The measurements were performed with the peak detector and if required, the quasi-peak detector.

The measurement bandwidth is:

Frequency of Emission (MHz)	RBW/VBW
12.56-14.56	10/30 kHz

The E-field measured at 3m is calculated as:

$$\text{E-field (dB}\mu\text{V/m)} = \text{Rx (dB}\mu\text{V)} + \text{Cable Loss (dB)} + \text{AF@3m (dB/m)}$$

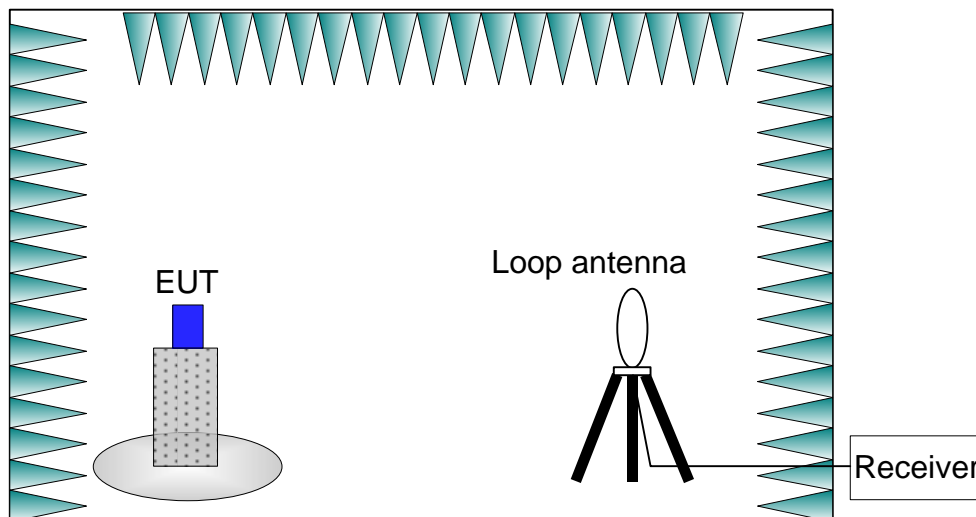

#### **A.1.3. EUT Operating Mode and Test Conditions**

The measurement of EUT is carried out under the transmit state of NFC (See 3.5).

The EUT is powered by a travel adapter.

During the measurements, the ambient temperature of the electromagnetic anechoic chamber is in the range of 15 ~ 25 °C.

**A.1.4. Limits**

Frequency Range (MHz)	E-field Strength Limit @ 30 m ( $\mu\text{V/m}$ )	E-field Strength Limit @ 3 m ( $\text{dB}\mu\text{V/m}$ )
13.560 $\pm$ 0.007	+15,848	124
13.410 to 13.553 13.567 to 13.710	+334	90
13.110 to 13.410 13.710 to 14.010	+106	81

Note: Where the limits have been defined at one distance, and a signal level measured at another, the limits have been extrapolated using the following formula:  

$$\text{Extrapolation(dB)} = 40\log_{10}(\text{Measurement Distance}/\text{Specification Distance})$$

**A.1.5. Measurement Results**

Measurement results of normal conditions see Figure C-1 for different set-ups of EUT. The result displayed take into account applicable antenna factors and cable losses.

**Conclusions:** Set. 2, **PASS.**

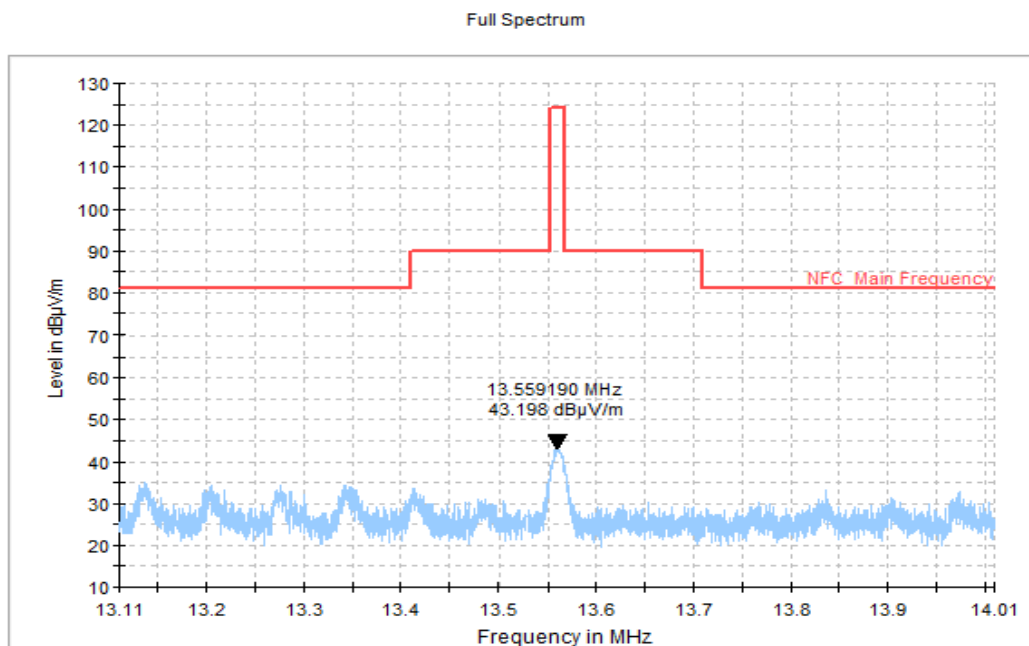

**Figure A-1: Set. 2**

**A.1.6. Measurement Uncertainty**

Measurement uncertainty:  $U = 3.94 \text{ dB}$ ,  $k=2$ .

## **A.2. Electric Field Radiated Emissions (< 30MHz)**

### **A.2.1. Reference**

See Clause 13.4, Clause 8 and Annex E of ANSI C63.10-2013 specifically.  
See Clause 4, Clause 5, and Clause 6 of ANSI C63.10-2013 generally.

### **A.2.2. Measurement Methods**

The transmitter carrier output levels (E-Field) from the EUT are measured in a semi-anechoic chamber. The EUT is placed on a non-conductive stand of 80cm high, and at a measurement distance of 3m from the receiving antenna. The center of the receiving loop antenna is 1.0 meter above the ground. The E-field is measured with a shielded loop antenna connected to a measurement receiver. Detected E-field was maximized by rotating the EUT through 360° and adjusting the receiving antenna polarizations. The maximization processes were repeated with the EUT positioned respectively in its three orthogonal axes. The measurements were performed with the peak detector and if required, the quasi-peak detector.

The measurement bandwidth is:

Frequency of Emission (MHz)	RBW/VBW
0.009-0.15	100/300 Hz
0.15-30	10/30 kHz

The E-field measured at 3m is calculated as:

$$\text{E-field (dB}\mu\text{V/m)} = \text{Rx (dB}\mu\text{V)} + \text{Cable Loss (dB)} + \text{AF@3m (dB/m)}$$

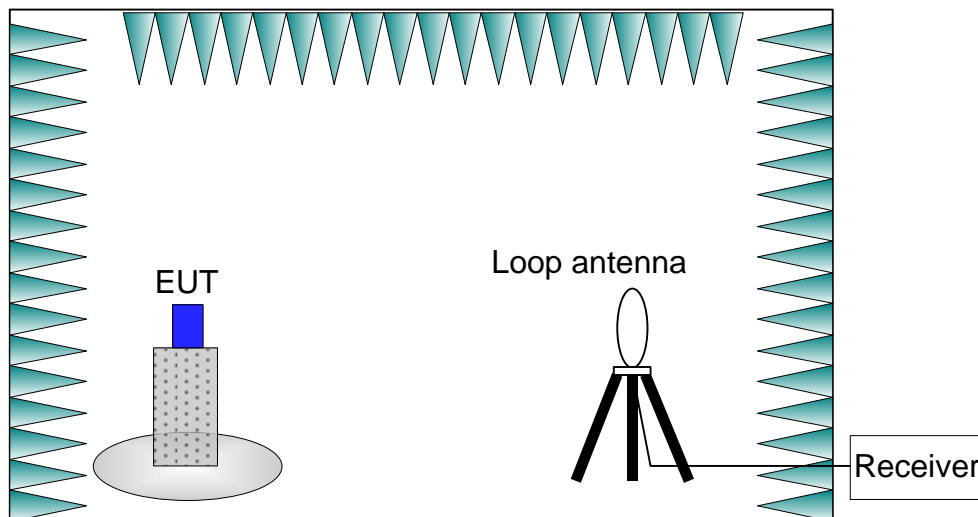

### **A.2.3. EUT Operating Mode and Test Conditions**

The measurement of EUT is carried out under the transmit state of NFC (See 3.5).

The EUT is powered by a travel adapter.

During the measurements, the ambient temperature of the electromagnetic anechoic chamber is in the range of 15 ~ 25 °C.

**A.2.4. Limits**

Frequency Range (MHz)	E-field Strength Limit @ 30m (mV/m)	E-field Strength Limit @ 3m (dBμV/m)
0.009-0.490	2400/F(kHz)	129-94
0.490-1.705	24000/F(kHz)	74-63
1.705-30	30	70

Note: Where the limits have been defined at one distance, and a signal level measured at another, the limits have been extrapolated using the following formula:  
 Extrapolation(dB) =  $40\log_{10}(\text{Measurement Distance}/\text{Specification Distance})$

**A.2.5. Measurement Results**

Measurement results of normal conditions see Figure C-2 for different set-ups of EUT. The result displayed take into account applicable antenna factors and cable losses.

**Conclusions:** Set. 1, **PASS.**

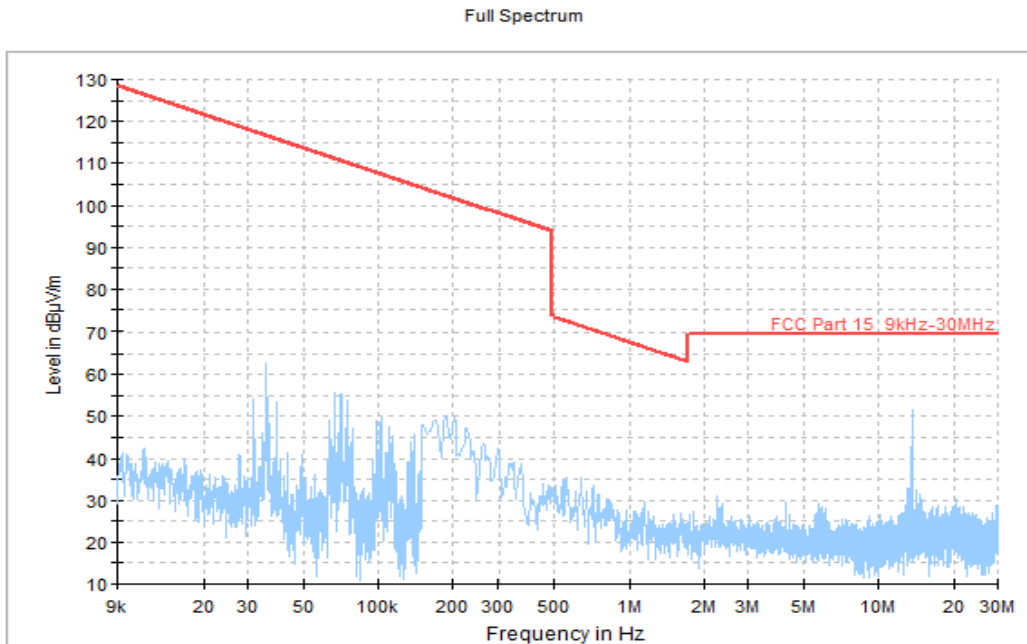

**Figure A-2: Set. 1**

**A.2.6. Measurement Uncertainty**

Measurement uncertainty:  $U = 3.94 \text{ dB}$ ,  $k=2$ .

### A.3. Electric Field Radiated Emissions ( $\geq 30\text{MHz}$ )

#### A.3.1. Reference

See Clause 13.4, Clause 8, and Annex E of ANSI C63.10-2013 specifically.  
See Clause 4, Clause 5, and Clause 6 of ANSI C63.10-2013 generally.

#### A.3.2. Measurement Methods

The electric field radiated emissions from the EUT are measured in a semi-anechoic chamber. The EUT is placed on a non-conductive stand of 80cm high, and at a measurement distance of 10m from the receiving antenna. The receiving antennas connected to a measurement receiver comply with Clause 15 of ANSI C63.2-1996 and Clause 6.5 of ANSI C63.10-2013. In order to search for maximum field strength emitted from the EUT, the receiving antenna can be moved between the height of 1.0 m to 4.0 m. Detected E-field was maximized at each frequency by rotating the EUT through 360° and adjusting the receiving antenna positions for both vertical and horizontal antenna polarizations. The maximization processes were repeated with the EUT positioned respectively in its three orthogonal axes. The measurements were performed with the peak detector and if required, the quasi-peak detector.

The measurement bandwidth is:

Frequency of Emission (MHz)	RBW/VBW
30-1000	120kHz

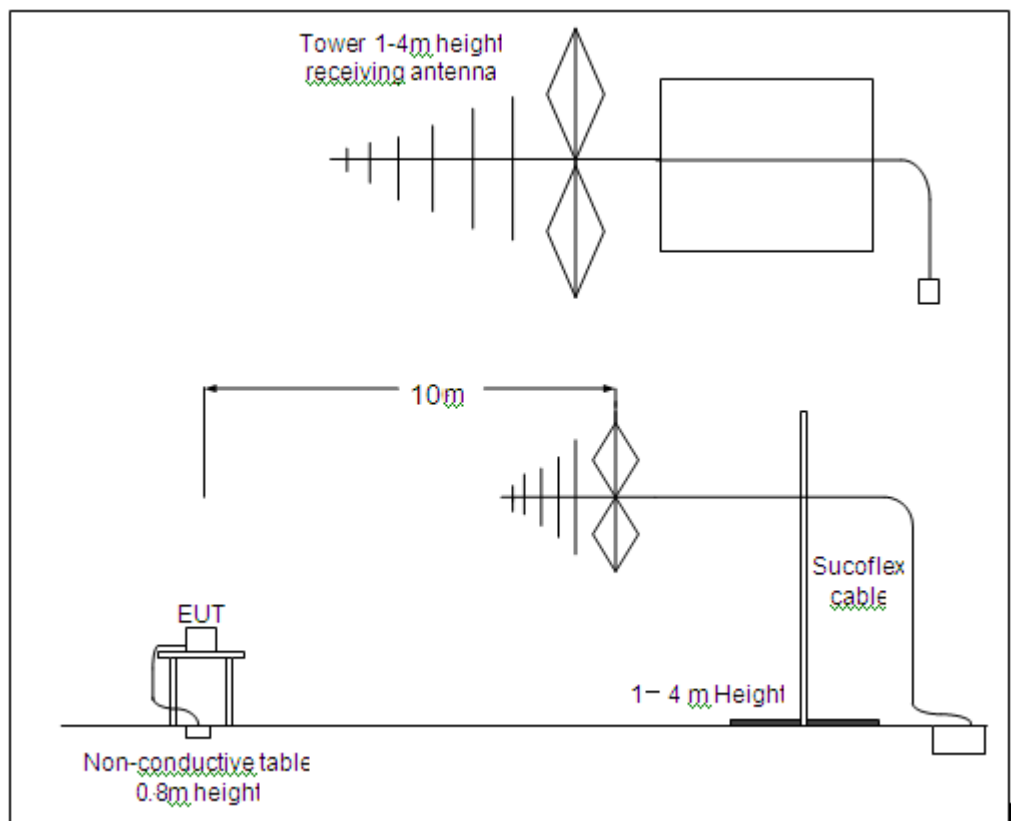

### A.3.3. EUT Operating Mode and Test Conditions

The measurement of EUT is carried out under the transmit state of NFC (See 3.5).

EUT1 had been connected to a travel adapter.

During the measurements, the ambient temperature of the electromagnetic anechoic chamber is in the range of 15 ~ 25 °C.

### A.3.4. Limits

Frequency Range (MHz)	E-field Strength Limit @ 3m (mV/m)	E-field Strength Limit @ 3m (dB $\mu$ V/m)	E-field Strength Limit @ 10m (dB $\mu$ V/m)
30-88	100	40	30
88-216	150	43.5	33.5
216-960	200	46	36
960-1000	500	54	44

### A.3.5. Measurement Results

Measurement results of normal conditions see Figure C-3 for different set-ups of EUT. The result displayed take into account applicable antenna factors and cable losses.

**Conclusions:** Set. 1, **PASS**.

### A.3.6. Measurement Uncertainty

Measurement uncertainty:  $U = 3.9$  dB,  $k=2$

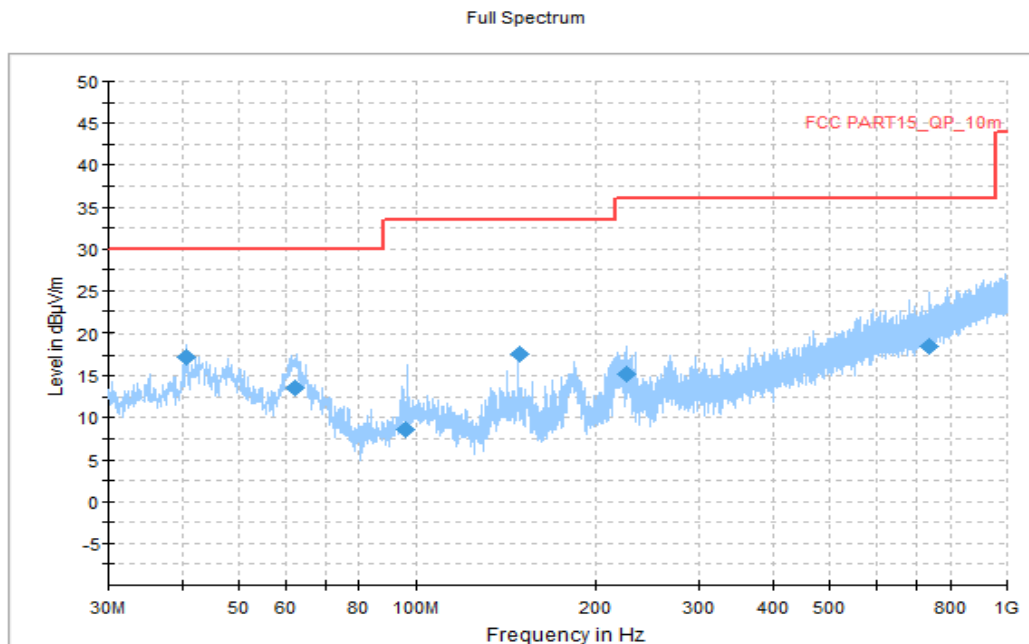

Figure A-3: Set. 1



**Final Result**

Frequency (MHz)	QuasiPeak (dB $\mu$ V/m)	Limit (dB $\mu$ V/m)	Margin (dB)	Meas. Time	Bandwidth (kHz)	Height (cm)	Pol	Azimuth (deg)
40.670000	17.24	30.00	12.76	1000.0	120.000	218.0	V	281.0
62.269000	13.61	30.00	16.39	1000.0	120.000	206.0	V	82.0
95.845000	8.64	33.50	24.88	1000.0	120.000	294.0	V	183.0
149.176000	17.56	33.50	15.96	1000.0	120.000	107.0	V	17.0
225.714000	15.19	36.00	20.83	1000.0	120.000	121.0	V	94.0
738.128000	18.61	36.00	17.41	1000.0	120.000	109.0	V	-30.0

**A.4. Frequency Tolerance**

**A.4.1. Reference**

See Clause 13.6 of ANSI C63.10-2013 specifically.

See Clause 4, Clause 5, and Clause 6 of ANSI C63.10-2013 generally.

**A.4.2. Measurement Methods**

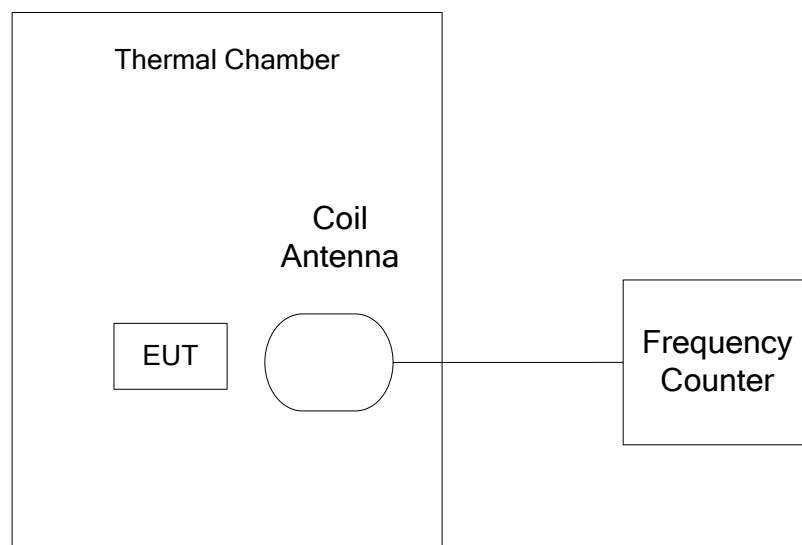

The transmitter output signal was picked up by coil antenna connected to the frequency counter. The center frequency was measured with 30Hz RBW and 1kHz span.

During the test, the EUT was placed in a thermal chamber until thermal balance and lasting appropriate time.

**A.4.3. EUT Operating Mode and Test Conditions**

The measurement of EUT is carried out under the transmit state of without modulation (See 3.5). EUT1 had been not connected to a travel adapter.

Operation Temperature: T min, T nom, and T max with V nom.

Operation Voltage: V min and V max with T nom.

**A.4.4. Test Layouts**

See A.4.2.

**A.4.5. Limits**

The frequency tolerance of the carrier signal shall be maintained within +/- 0.01% of the operating frequency.

**A.4.6. Measurement Results**

Measurement results see Table A-1 for different test conditions.

**Conclusions:** Set. NFC02, **PASS**.

**Table A-1: Frequency Stability VS Temperature and Voltage**

Temperature	Voltage	Frequency Error (MHz)			
		Startup	2 Min Later	5 Min Later	10 Min Later
T min	V nom	13.5602625	13.5602625	13.5602625	13.5601375
T max	V nom	13.5603175	13.5601875	13.5600657	13.5601875
T nom	V nom	13.5602438	13.5601875	13.5601875	13.5601750
T nom	V min	13.5601750	13.5601750	13.5600560	13.5602438
T nom	V max	13.5603175	13.5602438	13.5601750	13.5601875

Temperature	Voltage	Frequency Error (%)			
		Startup	2 Min Later	5 Min Later	10 Min Later
T min	V nom	0.002	0.002	0.002	0.001
T max	V nom	0.002	0.001	0.000	0.001
T nom	V nom	0.002	0.001	0.001	0.001
T nom	V min	0.001	0.001	0.000	0.002
T nom	V max	0.002	0.002	0.001	0.001

**A.4.7. Measurement Uncertainty**

Measurement uncertainty:  $U = 77 \text{ Hz}$ ,  $k=2$

## **A.5. 20dB Bandwidth**

### **A.5.1. Reference**

See Clause 13.7 of ANSI C63.10-2013 specifically.

See Clause 4, Clause 5, and Clause 6 of ANSI C63.10-2013 generally.

### **A.5.2. Measurement Methods**

The transmitter output signal was picked up by coil antenna to the spectrum analyzer.

The transmitter output signal was picked up by coil antenna connected to the spectrum analyzer.

The bandwidth of the center frequency was measured with 140Hz RBW, 420Hz VBW and 14kHz span.

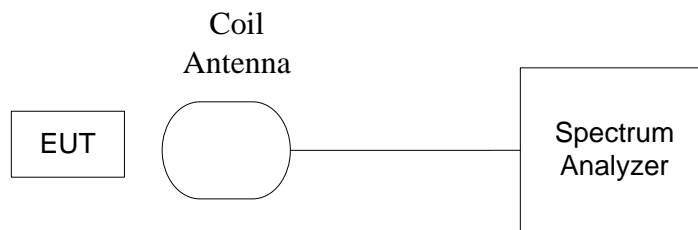

### **A.5.3. EUT Operating Mode and Test Conditions**

The measurement of EUT is carried out under the transmit state of NFC and without modulation (See 3.5).

EUT had been not connected to a travel adapter..

During the measurements, the ambient temperature is in the range of 15 ~ 25 °C.

### **A.5.4. Test Layouts**

See A.5.2.

### **A.5.5. Limits**

The 20dB bandwidth shall be less than 80% of the permitted frequency band. For 13.56 MHz NFC, the permitted frequency band is 14kHz, so the limit is 11.2 kHz.

### **A.5.6. Measurement Results**

Measurement results see Figure A-4.

**Conclusions:** Set. NFC02 and NFC03, **PASS**.

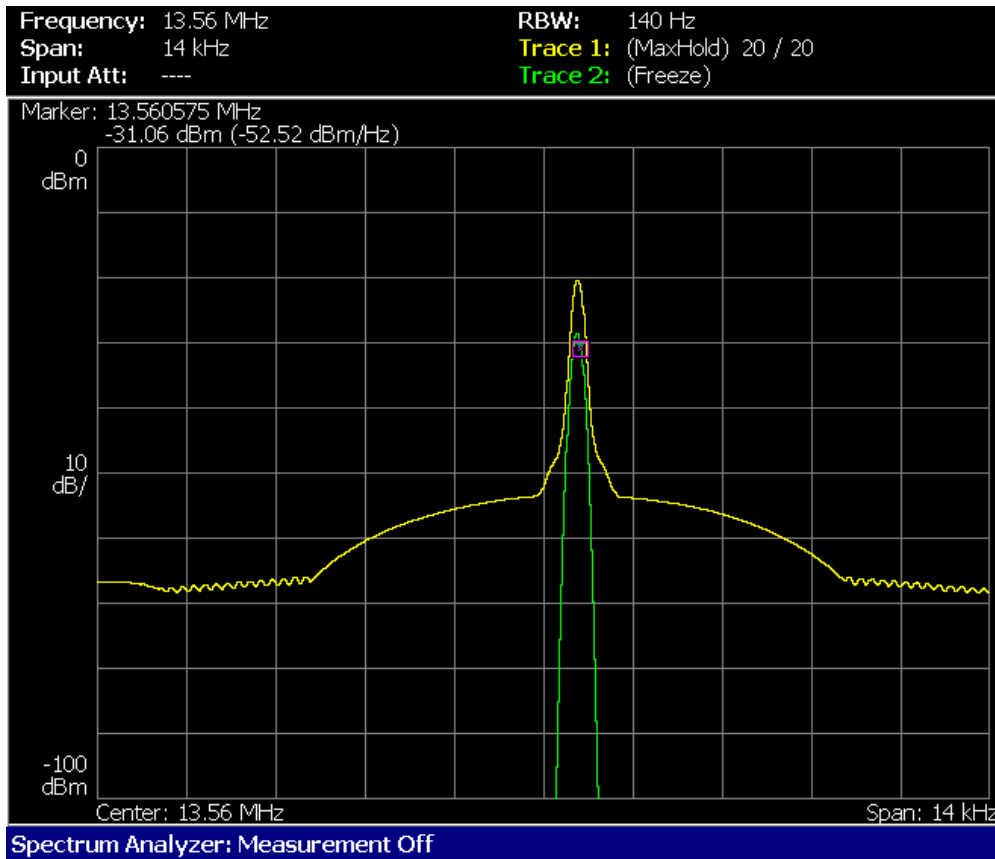

Figure A-4: Test result of EUT1 at test set. NFC02

#### A.5.7. Measurement Uncertainty

Measurement uncertainty:  $U = 77$  Hz,  $k=2$

### A.6. Conducted emission

#### A.6.1. Reference

See Clause 13.3 and Clause 7 of ANSI C63.10-2013 specifically.

See Clause 4, Clause 5, and Clause 6 of ANSI C63.10-2013 generally.

#### A.6.2. Measurement Methods

The conducted emissions from the AC port of the EUT are measured in a shielding room. The EUT is connected to a Line Impedance Stabilization Network (LISN). An overview sweep with peak detection was performed. The measurements were performed with a quasi-peak detector and if required, an average detector.

The conducted emission measurements were made with the following detector of the test receiver: Quasi-Peak / Average Detector.

The measurement bandwidth is:

Frequency of Emission (MHz)	RBW/VBW
0.15-30	9kHz

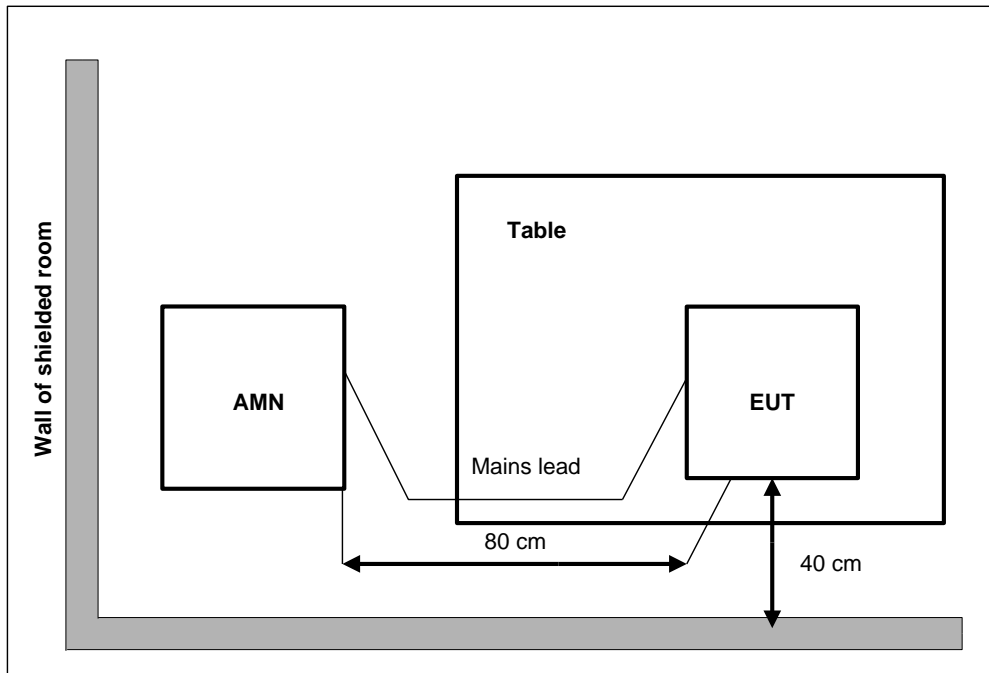

#### A.6.3. EUT Operating Mode and Test Conditions

The measurement of EUT is carried out under the transmit state of NFC (See 3.5).

The EUT is powered by a travel adapter.

During the measurements, the ambient temperature is in the range of 15 ~ 25 °C.

#### A.6.4. Limits

Frequency range (MHz)	Quasi-peak Limit (dB $\mu$ V)	Average Limit (dB $\mu$ V)
0.15 to 0.5	66 to 56	56 to 46
0.5 to 5	56	46
5 to 30	60	50

#### A.6.5. Measurement Results

Measurement results see Figure C-5.

**Conclusions:** Set. 1, **PASS**.

Note: The measurement result at 13.56MHz is the fundamental emission of NFC signal.

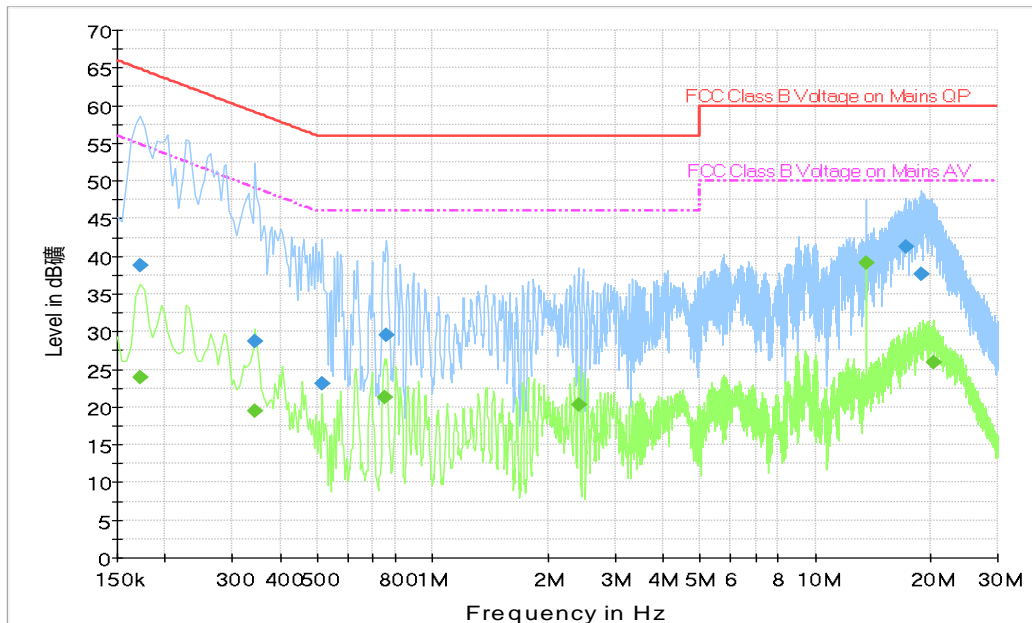

### Final Result 1

Frequency (MHz)	QuasiPeak (dBμV)	Meas. Time (ms)	Bandwidth (kHz)	Filter	Line	Corr. (dB)	Margin (dB)	Limit (dBμV)
0.172500	38.8	2000.0	9.000	On	N	19.8	26.0	64.8
0.343500	28.7	2000.0	9.000	On	N	19.9	30.4	59.1
0.514500	23.1	2000.0	9.000	On	N	19.9	32.9	56.0
0.757500	29.6	2000.0	9.000	On	N	19.8	26.4	56.0
17.263500	41.3	2000.0	9.000	On	L1	19.9	18.7	60.0
19.000500	37.7	2000.0	9.000	On	N	19.9	22.3	60.0

### Final Result 2

Frequency (MHz)	Average (dBμV)	Meas. Time (ms)	Bandwidth (kHz)	Filter	Line	Corr. (dB)	Margin (dB)	Limit (dBμV)
0.172500	24.0	2000.0	9.000	On	N	19.8	30.9	54.8
0.343500	19.5	2000.0	9.000	On	N	19.9	29.6	49.1
0.748500	21.2	2000.0	9.000	On	N	19.8	24.8	46.0
2.404500	20.3	2000.0	9.000	On	N	19.2	25.7	46.0
13.560000	39.2	2000.0	9.000	On	L1	19.8	10.8	50.0
20.418000	25.9	2000.0	9.000	On	L1	19.9	24.1	50.0

Figure A-5: Test result of EUT1 at test set. 1

#### A.6.6. Measurement Uncertainty

Measurement uncertainty:  $U = 3.38$  dB,  $k=2$

\*\*\*END OF REPORT\*\*\*