



# FCC RF Test Report

**APPLICANT** : HMD Global Oy  
**EQUIPMENT** : Smart Phone  
**BRAND NAME** : NOKIA  
**MODEL NAME** : TA-1038  
**FCC ID** : 2AJOTTA-1038  
**STANDARD** : FCC Part 15 Subpart C §15.225  
**CLASSIFICATION** : (DXX) Low Power Communication Device Transmitter

The product was received on Jan. 18, 2017 and testing was completed on Mar. 02, 2017. We, SPORTON INTERNATIONAL INC., would like to declare that the tested sample has been evaluated in accordance with the test procedures and has been in compliance with the applicable technical standards.

The test results in this report apply exclusively to the tested model / sample. Without written approval of SPORTON INTERNATIONAL INC., the test report shall not be reproduced except in full.

Reviewed by: Joseph Lin / Supervisor

Approved by: Jones Tsai / Manager



## SPORTON INTERNATIONAL INC.

No. 52, Hwa Ya 1<sup>st</sup> Rd., Hwa Ya Technology Park, Kwei-Shan District, Tao Yuan City, Taiwan, R.O.C.



# TABLE OF CONTENTS

**SUMMARY OF THE TEST RESULT .....4**

**1. GENERAL INFORMATION.....5**

1.1 Applicant..... 5

1.2 Manufacturer ..... 5

1.3 Product Feature of Equipment Under Test ..... 5

1.4 Product Specification of Equipment Under Test ..... 5

1.5 Modification of EUT ..... 6

1.6 Testing Location ..... 6

1.7 Applicable Standards..... 6

**2. TEST CONFIGURATION OF EQUIPMENT UNDER TEST .....7**

2.1 Descriptions of Test Mode ..... 7

2.2 Connection Diagram of Test System ..... 7

2.3 Table for Supporting Units ..... 8

2.4 EUT Operation Test Setup ..... 8

**3. TEST RESULTS.....9**

3.1 AC Power Line Conducted Emissions Measurement ..... 9

3.2 20dB Bandwidth Measurement ..... 11

3.3 Frequency Stability Measurement ..... 12

3.4 Field Strength of Fundamental Emissions and Mask Measurement..... 13

3.5 Radiated Emissions Measurement ..... 15

3.6 Antenna Requirements..... 18

**4. LIST OF MEASURING EQUIPMENT .....19**

**APPENDIX A. TEST RESULTS OF CONDUCTED EMISSION TEST**

**APPENDIX B. TEST RESULTS OF CONDUCTED TEST ITEMS**

B1. Test Result of 20dB Spectrum Bandwidth

B2. Test Result of Frequency Stability

**APPENDIX C. TEST RESULTS OF RADIATED TEST ITEMS**

C1. Test Result of Field Strength of Fundamental Emissions

C2. Results of Radiated Emissions (9 kHz~30MHz)

C3. Results of Radiated Emissions (30MHz~1GHz)

**APPENDIX D. SETUP PHOTOGRAPHS**





### SUMMARY OF THE TEST RESULT

Applied Standard: 47 CFR FCC Part 15 Subpart C				
Part	FCC Rule	Description of Test	Result	Under Limit
3.1	15.207	AC Power Line Conducted Emissions	Complies	18.3 dB at 0.150 MHz
3.2	15.215(c)	20dB Spectrum Bandwidth	Complies	-
3.3	15.225(e)	Frequency Stability	Complies	-
3.4	15.225(a)(b)(c)	Field Strength of Fundamental Emissions	Complies	65.13 dB at 13.560 MHz
3.5	15.225(d) 15.209	Radiated Emissions	Complies	0.86 dB at 40.680 MHz for Quasi-Peak
3.6	15.203	Antenna Requirements	Complies	-

Test Items	Uncertainty	Remark
AC Power Line Conducted Emissions	±2.7dB	Confidence levels of 95%
Radiated Emissions (30MHz~1000MHz)	±5.7dB	Confidence levels of 95%



# 1. GENERAL INFORMATION

## 1.1 Applicant

HMD Global Oy  
Karaportti 2, 02610 Espoo, Finland

## 1.2 Manufacturer

HMD Global Oy  
Karaportti 2, 02610 Espoo, Finland

## 1.3 Product Feature of Equipment Under Test

Product Feature	
Equipment	Smart Phone
Brand Name	NOKIA
Model Name	TA-1038
FCC ID	2AJOTTA-1038
EUT supports Radios application	GSM/GPRS/EGPRS/WCDMA/HSPA/DC-HSDPA/ HSPA+/LTE/NFC WLAN 2.4GHz 802.11b/g/n HT20/ WLAN 5GHz 802.11a/n HT20/HT40 Bluetooth v3.0 + EDR/ Bluetooth v 4.0 LE/ Bluetooth v4.1 LE / Bluetooth v4.2 LE
IMEI Code	Conducted: 356805080008438/356805080008420 Conduction: 356805080006838/356805080006820 356805080006473/356805080006465 Radiation: 356805080008438
HW Version	DVT1.5
SW Version	000C_1_26A
EUT Stage	Production Unit

**Remark:** The above EUT's information was declared by manufacturer. Please refer to the specifications or user's manual for more detailed description.

## 1.4 Product Specification of Equipment Under Test

Standards-related Product Specification	
Tx/Rx Frequency Range	13.553 ~ 13.567MHz
Channel Number	1
20dBW	2.64 kHz
Antenna Type	Loop Antenna
Type of Modulation	ASK

**Remark:** The above EUT's information was declared by manufacturer. Please refer to the specifications or user's manual for more detailed description.



### 1.5 Modification of EUT

No modifications are made to the EUT during all test items.

### 1.6 Testing Location

Sporton Lab is accredited to ISO 17025 by Taiwan Accreditation Foundation (TAF code : 1190) and the FCC designation No. TW1022 under the FCC 2.948(e) by Mutual Recognition Agreement (MRA) in FCC Test.

<b>Test Site</b>	SPORTON INTERNATIONAL INC.		
<b>Test Site Location</b>	No. 52, Hwa Ya 1 <sup>st</sup> Rd., Hwa Ya Technology Park, Kwei-Shan District, Tao Yuan City, Taiwan, R.O.C. TEL: +886-3-327-3456 FAX: +886-3-328-4978		
<b>Test Site No.</b>	<b>Sporton Site No.</b>		
	TH03-HY	CO05-HY	03CH07-HY
<b>Test Engineer</b>	William Liao	Kai-Chun Chu & Arthur Hsieh	James Chiu
<b>Temperature</b>	22~24°C	20~22°C	21~24°C
<b>Relative Humidity</b>	53~55%	40~42%	51~54%

**Note:** The test site complies with ANSI C63.4 2014 requirement.

### 1.7 Applicable Standards

According to the specifications of the manufacturer, the EUT must comply with the requirements of the following standards:

- ♦ FCC Part 15 Subpart C §15.225
- ♦ ANSI C63.10-2013

## 2. TEST CONFIGURATION OF EQUIPMENT UNDER TEST

### 2.1 Descriptions of Test Mode

Investigation has been done on all the possible configurations for searching the worst cases.

The following table is a list of the test modes shown in this test report.

Test Items	
AC Power Line Conducted Emissions	Field Strength of Fundamental Emissions
20dB Spectrum Bandwidth	Frequency Stability
Radiated Emissions 9kHz~30MHz	Radiated Emissions 30MHz~1GHz

The EUT pre-scanned in four NFC type, A, B, F. The worst type (type F) was recorded in this report.

Pre-scanned tests, X, Y, Z in three orthogonal panels to determine the final configuration (Y plane as worst plane) from all possible combinations.

### 2.2 Connection Diagram of Test System

#### <AC Conducted Emissions>

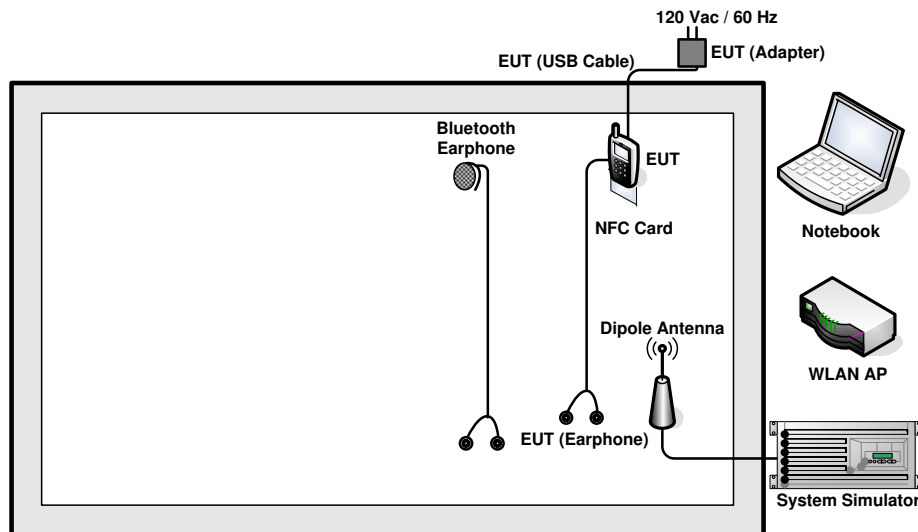

**< For Fundamental Emissions and Mask and Radiated Emissions Measurement >**

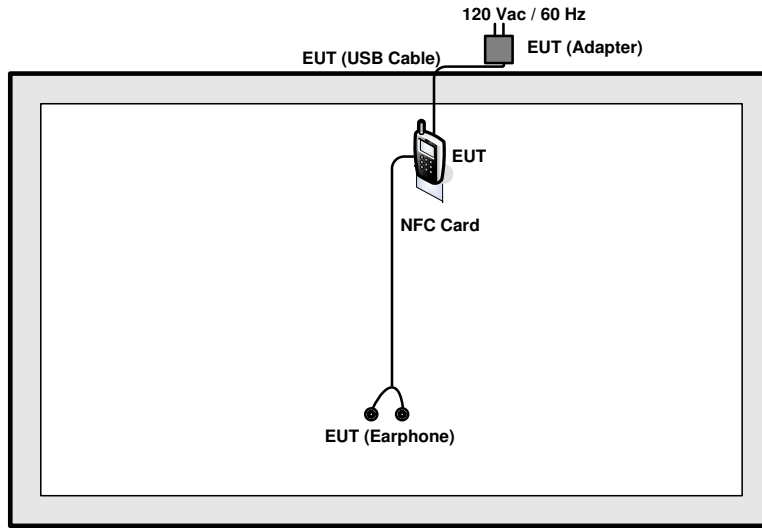

**2.3 Table for Supporting Units**

Support Unit	Manufacturer	Model	FCC ID
System Simulator	Anritsu	MT8820C	N/A
WLAN AP	ASUS	RT-AC66U	MSQ-RTAC66U
Notebook	Dell	Latitude E6320	FCC DoC
Bluetooth Earphone	Sony Ericsson	MW600	PY700A2029
NFC Card	N/A	N/A	N/A

**2.4 EUT Operation Test Setup**

The EUT was programmed to be in continuously transmitting mode.

The ancillary equipment, NFC card, is used to make the EUT (NFC) continuously transmit at 13.56MHz and is placed around 3 cm gap to the EUT.





### 3. TEST RESULTS

#### 3.1 AC Power Line Conducted Emissions Measurement

##### 3.1.1 Limit of AC Conducted Emission

For equipment that is designed to be connected to the public utility (AC) power line, the radio frequency voltage that is conducted back onto the AC power line on any frequency or frequencies within the band 150 kHz to 30 MHz shall not exceed the limits in the following table.

Frequency of Emission (MHz)	Conducted Limit (dB $\mu$ V)	
	Quasi-Peak	Average
0.15-0.5	66 to 56*	56 to 46*
0.5-5	56	46
5-30	60	50

\*Decreases with the logarithm of the frequency.

For terminal test result, the testing follows FCC KDB 174176.

##### 3.1.2 Measuring Instruments

See list of measuring instruments of this test report.

##### 3.1.3 Test Procedures

1. The EUT was placed 0.4 meter from the conducting wall of the shielding room, and it was kept at least 80 centimeters from any other grounded conducting surface.
2. Connect EUT to the power mains through a line impedance stabilization network (LISN).
3. All the support units are connecting to the other LISN.
4. The LISN provides 50 ohm coupling impedance for the measuring instrument.
5. The FCC states that a 50 ohm, 50 microhenry LISN should be used.
6. Both sides of AC line were checked for maximum conducted interference.
7. The frequency range from 150 kHz to 30 MHz was searched.
8. Set the test-receiver system to Peak Detect Function and specified bandwidth (IF Bandwidth = 9kHz) with Maximum Hold Mode. Then measurement is also conducted by Average Detector and Quasi-Peak Detector Function respectively.

### 3.1.4 Test setup

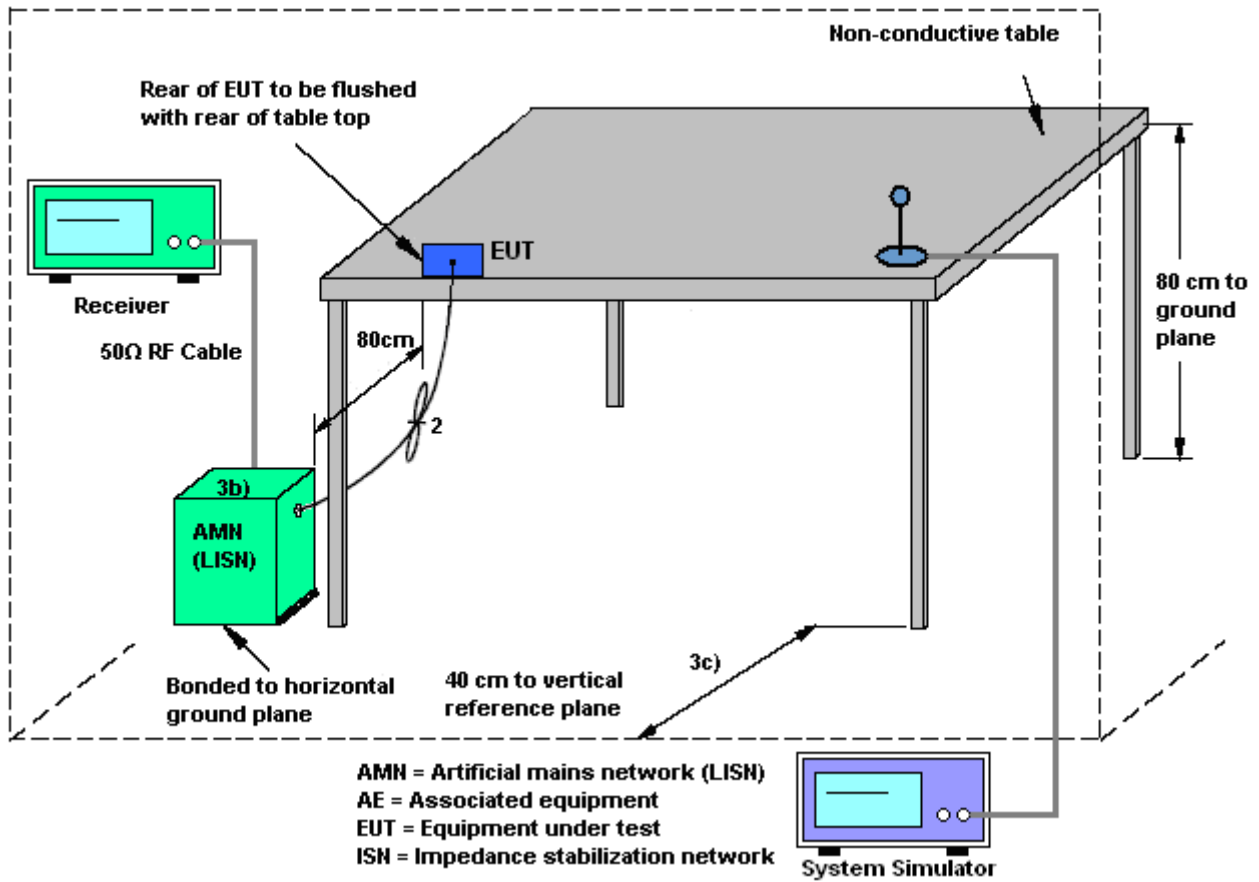

### 3.1.5 Test Result of AC Conducted Emission

Please refer to Appendix A.

## 3.2 20dB Bandwidth Measurement

### 3.2.1 Limit

Intentional radiators must be designed to ensure that the 20dB bandwidth in the specific band 13.553~13.567MHz.

### 3.2.2 Measuring Instruments

See list of measuring instruments of this test report.

### 3.2.3 Test Procedures

1. The spectrum analyzer connected via a receive antenna placed near the EUT in peak Max hold mode.
2. The resolution bandwidth of 1 kHz and the video bandwidth of 3 kHz were used.
3. Measured the spectrum width with power higher than 20dB below carrier.

### 3.2.4 Test Setup

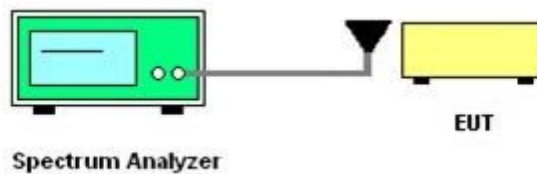

### 3.2.5 Test Result of Conducted Test Items

Please refer to Appendix B.

### 3.3 Frequency Stability Measurement

#### 3.3.1 Limit

The frequency tolerance of the carrier signal shall be maintained within +/- 0.01% (100ppm) of the operating frequency over a temperature variation of -20 degrees to +50 degrees C at normal supply voltage, and for a variation in the primary supply voltage from 85% to 115% of the rated supply voltage at a temperature of 20 degrees C. For battery operated equipment, the equipment tests shall be performed using a new battery.

#### 3.3.2 Measuring Instruments

See list of measuring instruments of this test report.

#### 3.3.3 Test Procedures

1. The spectrum analyzer connected via a receive antenna placed near the EUT.
2. EUT have transmitted signal and fixed channelize.
3. Set the spectrum analyzer span to view the entire emissions bandwidth.
4. Set RBW = 1 kHz, VBW = 3 kHz with peak detector and maxhold settings.
5. The  $f_c$  is declaring of channel frequency. Then the frequency error formula is  $(f_c - f) / f_c \times 10^6$  ppm and the limit is less than  $\pm 100$ ppm.
6. Extreme temperature rule is -20°C~50°C.

#### 3.3.4 Test Setup

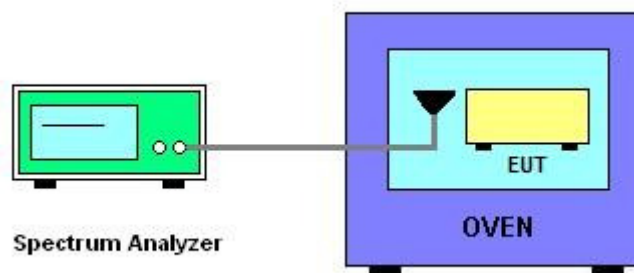

#### 3.3.5 Test Result of Conducted Test Items

Please refer to Appendix B.



### 3.4 Field Strength of Fundamental Emissions and Mask Measurement

#### 3.4.1 Limit

Rules and specifications	FCC CFR 47 Part 15 section 15.225			
Description	Compliance with the spectrum mask is tested with RBW set to 9kHz.			
Freq. of Emission (MHz)	Field Strength (μV/m) at 30m	Field Strength (dBμV/m) at 30m	Field Strength (dBμV/m) at 10m	Field Strength (dBμV/m) at 3m
1.705~13.110	30	29.5	48.58	69.5
13.110~13.410	106	40.5	59.58	80.5
13.410~13.553	334	50.5	69.58	90.5
13.553~13.567	15848	84.0	103.08	124.0
13.567~13.710	334	50.5	69.58	90.5
13.710~14.010	106	40.5	59.58	80.5
14.010~30.000	30	29.5	48.58	69.5

#### 3.4.2 Measuring Instruments

See list of measuring instruments of this test report.

#### 3.4.3 Test Procedures

1. Configure the EUT according to ANSI C63.10. The EUT was placed on the top of the turntable 0.8 meter above ground. The phase center of the loop receiving antenna mounted antenna tower was placed 3 meters far away from the turntable.
2. Power on the EUT and all the supporting units. The turntable was rotated by 360 degrees to determine the position of the highest radiation.
3. The height of the receiving antenna was fixed at one meter above ground to find the maximum emissions field strength.
4. For Fundamental emissions, use the receiver to measure QP reading.

5. When the radiated emissions limits are expressed in terms of the average value of the emissions, and pulsed operation is employed, the measurement field strength shall be determined by averaging over one complete pulse train, including blanking intervals, as long as the pulse train does not exceed 0.1 seconds. As an alternative (provided the transmitter operates for longer than 0.1 seconds) or in cases where the pulse train exceeds 0.1 seconds, the measured field strength shall be determined from the average absolute voltage during a 0.1 second interval during which the field strength is at its maximum value.
6. Compliance with the spectrum mask is tested with RBW set to 9kHz.  
Note: Emission level (dB $\mu$ V/m) = 20 log Emission level ( $\mu$ V/m).

### 3.4.4 Test Setup

For radiated emissions below 30MHz

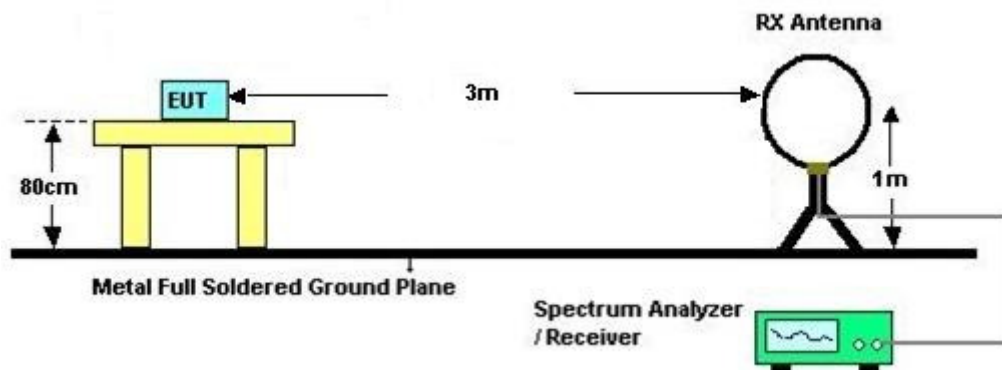

### 3.4.5 Test Result of Field Strength of Fundamental Emissions and Mask

Please refer to Appendix C.



### 3.5 Radiated Emissions Measurement

#### 3.5.1 Limit

The field strength of any emissions which appear outside of 13.110 ~14.010MHz band shall not exceed the general radiated emissions limits.

Frequencies (MHz)	Field Strength (µV/m)	Measurement Distance (meters)
0.009~0.490	2400/F(kHz)	300
0.490~1.705	24000/F(kHz)	30
1.705~30.0	30	30
30~88	100	3
88~216	150	3
216~960	200	3
Above 960	500	3

#### 3.5.2 Measuring Instruments

See list of measuring instruments of this test report.

#### 3.5.3 Measuring Instrument Setting

The following table is the setting of receiver.

Receiver Parameter	Setting
Attenuation	Auto
Frequency Range: 9kHz~150kHz	RBW 200Hz for QP
Frequency Range: 150kHz~30MHz	RBW 9kHz for QP
Frequency Range: 30MHz~1000MHz	RBW 120kHz for Peak

**Note:** The emission limits shown in the above table are based on measurements employing a CISPR quasi-peak detector except for the frequency bands 9-90 kHz, 110-490 kHz. Radiated emission limits in these two bands are based on measurements employing an average detector.



### **3.5.4 Test Procedures**

1. Configure the EUT according to ANSI C63.10. The EUT was placed on the top of the turntable 0.8 meter above ground. The phase center of the receiving antenna mounted on the top of a height-variable antenna tower was placed 3 meters far away from the turntable.
2. Power on the EUT and all the supporting units. The turntable was rotated by 360 degrees to determine the position of the highest radiation.
3. The height of the broadband receiving antenna was varied between one meter and four meters above ground to find the maximum emissions field strength of both horizontal and vertical polarization.
4. For each suspected emissions, the antenna tower was scan (from 1 M to 4 M) and then the turntable was rotated (from 0 degree to 360 degrees) to find the maximum reading.
5. Set the test-receiver system to Peak or CISPR quasi-peak Detect Function with specified bandwidth under Maximum Hold Mode.
6. When the radiated emissions limits are expressed in terms of the average value of the emissions, and pulsed operation is employed, the measurement field strength shall be determined by averaging over one complete pulse train, including blanking intervals, as long as the pulse train does not exceed 0.1 seconds. As an alternative (provided the transmitter operates for longer than 0.1 seconds) or in cases where the pulse train exceeds 0.1 seconds, the measured field strength shall be determined from the average absolute voltage during a 0.1 second interval during which the field strength is at its maximum value.
7. In case the emission is lower than 30MHz, loop antenna has to be used for measurement and the recorded data should be QP measured by receiver. Antenna Requirements



### 3.5.5 Test Setup

For radiated emissions above 30MHz

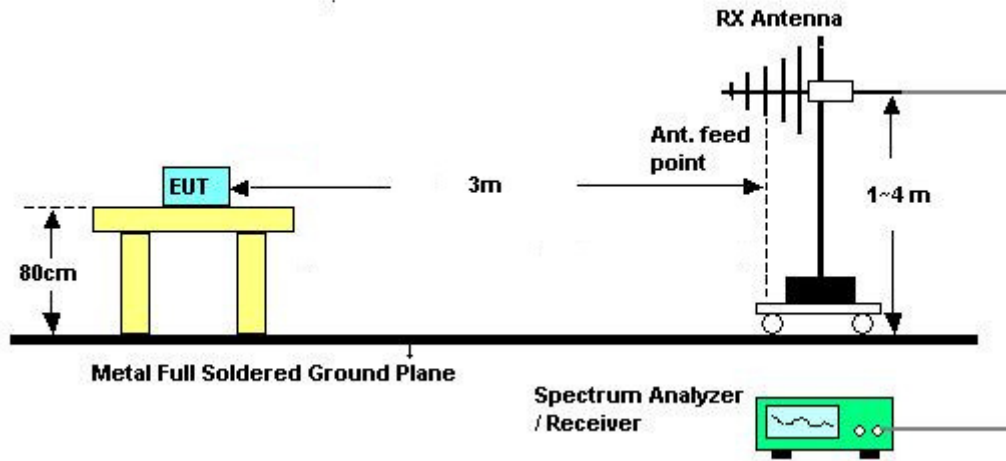

### 3.5.6 Test Result of Radiated Emissions Measurement

Please refer to Appendix C.



## **3.6 Antenna Requirements**

### **3.6.1 Standard Applicable**

Except for special regulations, the Low-power Radio-frequency Devices must not be equipped with any jacket for installing an antenna with extension cable. An intentional radiator shall be designed to ensure that no antenna other than that furnished by the responsible party shall be used with the device. The use of a permanently attached antenna or of an antenna that uses a unique coupling to the intentional radiator shall be considered sufficient to comply with the provisions of this Section. The manufacturer may design the unit so that the user can replace a broken antenna, but the use of a standard antenna jack or electrical connector is prohibited.

The use of a permanently attached antenna or of an antenna that uses a unique coupling to the intentional radiator shall be considered sufficient to comply with the FCC rule.

### **3.6.2 Antenna Anti-Replacement Construction**

An embedded-in antenna design is used.



### 4. LIST OF MEASURING EQUIPMENT

Instrument	Manufacturer	Model No.	Serial No.	Characteristics	Calibration Date	Test Date	Due Date	Remark
AC Power Source	AC POWER	AFC-500W	F10407001 1	50Hz~60Hz	Dec. 01, 2016	Feb. 02, 2017	Nov. 30, 2017	Conducted (TH03-HY)
Hygrometer	Testo	608-H1	34893241	N/A	May 03, 2016	Feb. 02, 2017	May 02, 2017	Conducted (TH03-HY)
Spectrum Analyzer	Rohde & Schwarz	FSP30	101329	9kHz~30GHz	Jun. 27, 2016	Feb. 02, 2017	Jun. 26, 2017	Conducted (TH03-HY)
Temperature Chamber	ESPEC	SU-641	92013721	-30°C ~70°C	Nov. 16, 2016	Feb. 02, 2017	Nov. 15, 2017	Conducted (TH03-HY)
Bilog Antenna	TESEQ	CBL 6111D&00800 N1D01N-06	35419&03	30MHz to 1GHz	Jan. 07, 2017	Jan. 18, 2017~ Mar. 02, 2017	Jan. 06, 2018	Radiation (03CH07-HY)
EMI Test Receiver	Keysight	N9038A (MXE)	MY541300 85	20Hz ~ 8.4GHz	Oct. 26, 2016	Jan. 18, 2017~ Mar. 02, 2017	Oct. 25, 2017	Radiation (03CH07-HY)
Loop Antenna	Rohde & Schwarz	HFH2-Z2	100315	9 kHz~30 MHz	Sep. 02, 2016	Jan. 18, 2017~ Mar. 02, 2017	Sep. 01, 2017	Radiation (03CH07-HY)
Preamplifier	COM-POWER	PA-103A	161241	10MHz-1GHz	Mar. 18, 2016	Jan. 18, 2017~ Mar. 02, 2017	Mar. 17, 2017	Radiation (03CH07-HY)
Spectrum Analyzer	Agilent	N9030A	MY523502 76	3Hz~44GHz	Mar. 21, 2016	Jan. 18, 2017~ Mar. 02, 2017	Mar. 20, 2017	Radiation (03CH07-HY)
RF Cable	HUBER + SUHNER	SUCOFLEX 104	Y8420952 1+MY8420 9521	9KHz~30MHz	Jan. 03, 2017	Jan. 18, 2017~ Mar. 02, 2017	Jan. 02, 2018	Radiation (03CH07-HY)
RF Cable	HUBER + SUHNER	SUCOFLEX 104	MY842095 21	30MHz~1GHz	Jan. 03, 2017	Jan. 18, 2017~ Mar. 02, 2017	Jan. 02, 2018	Radiation (03CH07-HY)
Controller	Max-Full	MF7802	MF780208 368	Control Ant Mast	NCR	Jan. 18, 2017~ Mar. 02, 2017	NCR	Radiation (03CH07-HY)
Antenna Mast	Max-Full	MFA520BS	N/A	1m~4m	NCR	Jan. 18, 2017~ Mar. 02, 2017	NCR	Radiation (03CH07-HY)
Turn Table	ChainTek	Chaintek 3000	N/A	0~360 Degree	NCR	Jan. 18, 2017~ Mar. 02, 2017	NCR	Radiation (03CH07-HY)
AC Power Source	ChainTek	APC-1000W	N/A	N/A	NCR	Jan. 26, 2017 ~ Feb. 18, 2017	NCR	Conduction (CO05-HY)
EMI Test Receiver	Rohde & Schwarz	ESCI 7	100724	9kHz~7GHz	Aug. 30, 2016	Jan. 26, 2017 ~ Feb. 18, 2017	Aug. 29, 2017	Conduction (CO05-HY)
Hygrometer	Testo	608-H1	34913912	N/A	Apr. 19, 2016	Jan. 26, 2017 ~ Feb. 18, 2017	Apr. 18, 2017	Conduction (CO05-HY)
LISN	Rohde & Schwarz	ENV216	100080	9kHz~30MHz	Nov. 29, 2016	Jan. 26, 2017 ~ Feb. 18, 2017	Nov. 28, 2017	Conduction (CO05-HY)
LF Cable	HUBER + SUHNER	RG-214/U	LF01	N/A	Jan. 05, 2017	Jan. 26, 2017 ~ Feb. 18, 2017	Jan. 04, 2018	Conduction (CO05-HY)
Pulse Limiter	Rohde & Schwarz	ESH3-Z2	100851	N/A	Jan. 05, 2017	Jan. 26, 2017 ~ Feb. 18, 2017	Jan. 04, 2018	Conduction (CO05-HY)

NCR: No Calibration Required

## Appendix A. Test Results of Conducted Emission Test

Test Mode :	NFC Tx	Test Voltage :	120Vac / 60Hz
Function Type :	GSM850 Link + Bluetooth Link + WLAN Link + USB Cable (Charging from Adapter) + Earphone + NFC Tx + SIM2		

ENV216 Auto Test NCC CE Power Bar - L

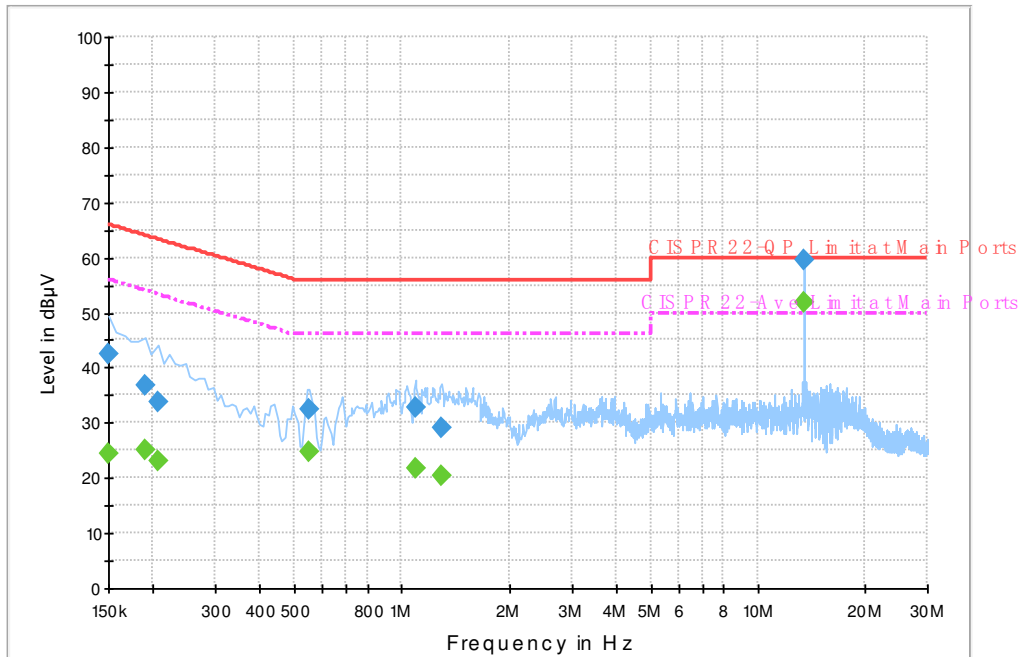

**Final Result : Quasi-Peak**

Frequency (MHz)	Quasi-Peak (dBµV)	Filter	Line	Corr. (dB)	Margin (dB)	Limit (dBµV)
0.150000	42.4	Off	L1	19.6	23.6	66.0
0.190000	36.7	Off	L1	19.6	27.3	64.0
0.206000	33.9	Off	L1	19.6	29.5	63.4
0.550000	32.5	Off	L1	19.6	23.5	56.0
1.094000	32.7	Off	L1	19.6	23.3	56.0
1.294000	29.0	Off	L1	19.6	27.0	56.0
13.56000	59.4	Off	L1	20.1	0.6	60.0

**Final Result : Average**

Frequency (MHz)	Average (dBµV)	Filter	Line	Corr. (dB)	Margin (dB)	Limit (dBµV)
0.150000	24.5	Off	L1	19.6	31.5	56.0
0.190000	24.9	Off	L1	19.6	29.1	54.0
0.206000	23.0	Off	L1	19.6	30.4	53.4
0.550000	24.8	Off	L1	19.6	21.2	46.0
1.094000	21.7	Off	L1	19.6	24.3	46.0
1.294000	20.5	Off	L1	19.6	25.5	46.0
13.56000	52.0	Off	L1	20.1	-2.0	50.0

(1) With antenna

Remark: 13.560MHz is the NFC RF fundamental signal.



<b>Test Mode :</b>	NFC Tx	<b>Test Voltage :</b>	120Vac / 60Hz
<b>Function Type :</b>	GSM850 Link + Bluetooth Link + WLAN Link + USB Cable (Charging from Adapter) + Earphone + NFC Tx + SIM2		

ENV216 Auto Test NCC CE Power Bar - N

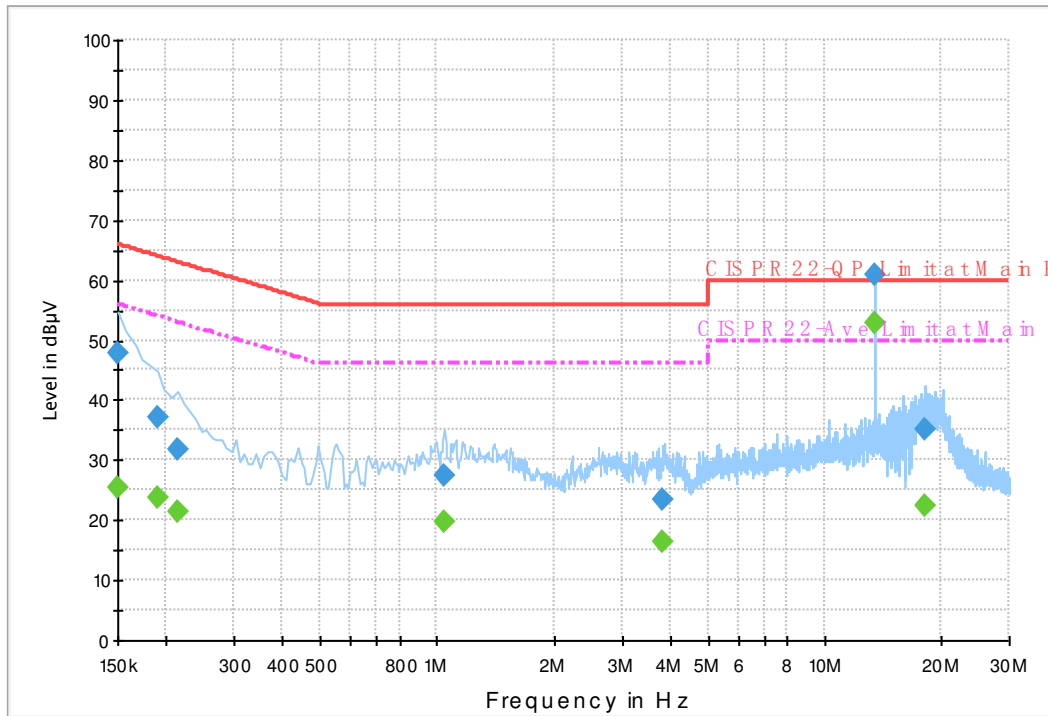

**Final Result : Quasi-Peak**

Frequency (MHz)	Quasi-Peak (dBµV)	Filter	Line	Corr. (dB)	Margin (dB)	Limit (dBµV)
0.150000	47.7	Off	N	19.6	18.3	66.0
0.190000	37.2	Off	N	19.5	26.8	64.0
0.214000	31.8	Off	N	19.5	31.2	63.0
1.046000	27.5	Off	N	19.6	28.5	56.0
3.814000	23.3	Off	N	19.6	32.7	56.0
13.560000	60.9	Off	N	20.2	-0.9	60.0
18.142000	35.0	Off	N	20.4	25.0	60.0

**Final Result : Average**

Frequency (MHz)	Average (dBµV)	Filter	Line	Corr. (dB)	Margin (dB)	Limit (dBµV)
0.150000	25.4	Off	N	19.6	30.6	56.0
0.190000	23.9	Off	N	19.5	30.1	54.0
0.214000	21.3	Off	N	19.5	31.7	53.0
1.046000	19.9	Off	N	19.6	26.1	46.0
3.814000	16.4	Off	N	19.6	29.6	46.0
13.560000	52.8	Off	N	20.2	-2.8	50.0
18.142000	22.6	Off	N	20.4	27.4	50.0

(1) with antenna

Remark: 13.560MHz is the NFC RF fundamental signal.



<b>Test Mode :</b>	NFC Tx	<b>Test Voltage :</b>	120Vac / 60Hz
<b>Function Type :</b>	GSM850 Link + Bluetooth Link + WLAN Link + USB Cable (Charging from Adapter) + Earphone + NFC Tx + SIM2		

ENV216 Auto Test NCC CE Power Bar - L

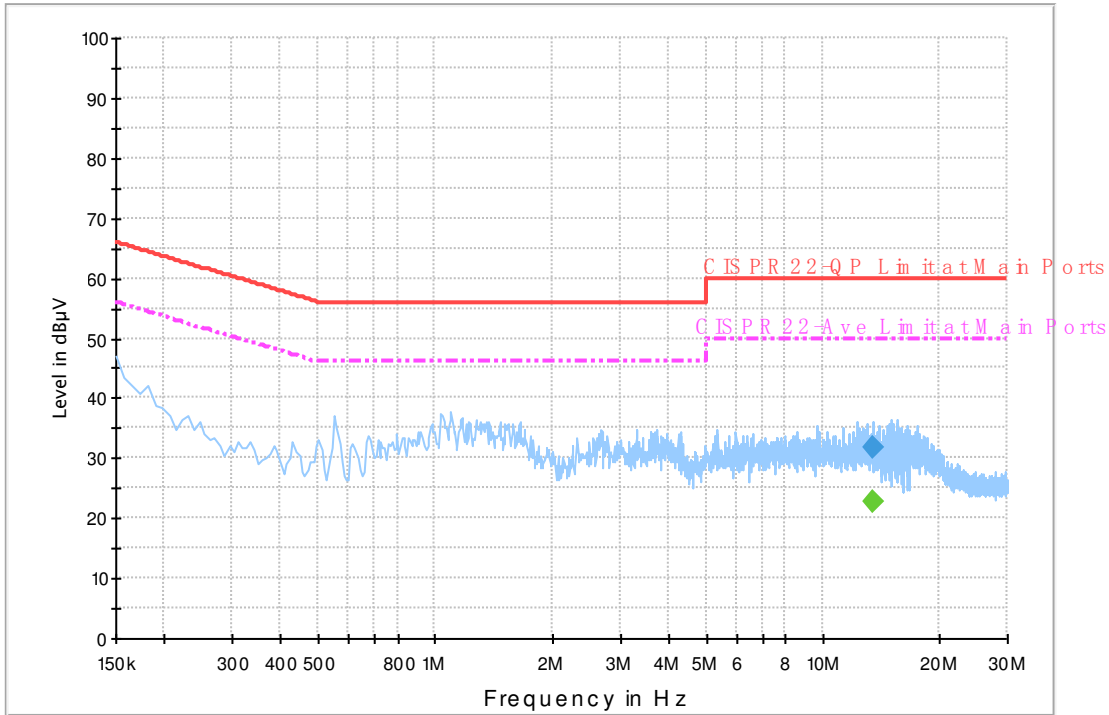

**Final Result : Quasi-Peak**

Frequency (MHz)	Quasi-Peak (dBµV)	Filter	Line	Corr. (dB)	Margin (dB)	Limit (dBµV)
13.56000	31.7	Off	L1	20.1	28.3	60.0

**Final Result : Average**

Frequency (MHz)	Average (dBµV)	Filter	Line	Corr. (dB)	Margin (dB)	Limit (dBµV)
13.56000	22.9	Off	L1	20.1	27.1	50.0

(2) With dummy load

Remark: Only the fundamental NFC signal needs to be retested per C63.4.



<b>Test Mode :</b>	NFC Tx	<b>Test Voltage :</b>	120Vac / 60Hz
<b>Function Type :</b>	GSM850 Link + Bluetooth Link + WLAN Link + USB Cable (Charging from Adapter) + Earphone + NFC Tx + SIM2		

ENV216 Auto Test NCC CE Power Bar - N

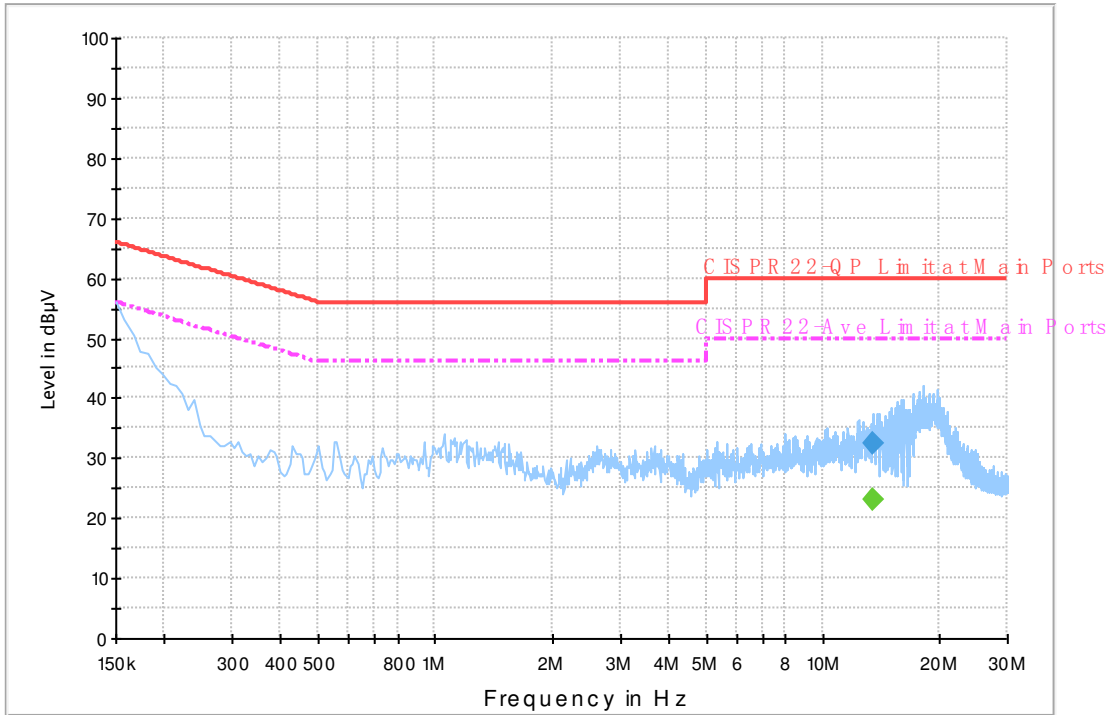

**Final Result : Quasi-Peak**

Frequency (MHz)	Quasi-Peak (dBµV)	Filter	Line	Corr. (dB)	Margin (dB)	Limit (dBµV)
13.56000	32.6	Off	N	20.2	27.4	60.0

**Final Result : Average**

Frequency (MHz)	Average (dBµV)	Filter	Line	Corr. (dB)	Margin (dB)	Limit (dBµV)
13.56000	23.0	Off	N	20.2	27.0	50.0

(2) With dummy load

Remark: Only the fundamental NFC signal needs to be retested per C63.4.



## Appendix B. Test Results of Conducted Test Items

### B1. Test Result of 20dB Spectrum Bandwidth

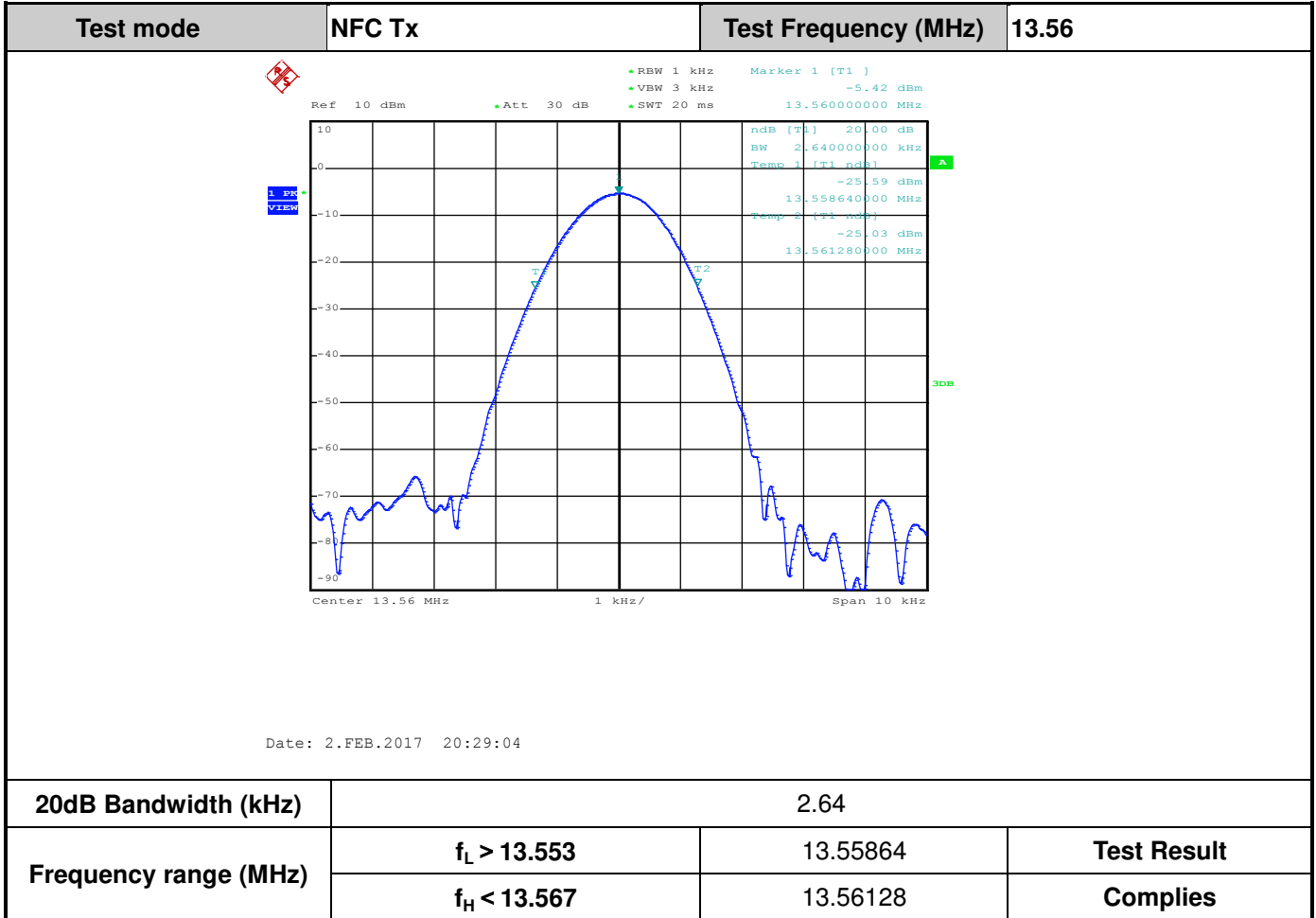





**B2. Test Result of Frequency Stability**

Voltage vs. Frequency Stability		Temperature vs. Frequency Stability		
Voltage (Vac)	Measurement Frequency (MHz)	Temperature (°C)	Time	Measurement Frequency (MHz)
120	13.55998	-20	0	13.55996
108	13.55998		2	13.55996
132	13.55997		5	13.55996
			10	13.55996
		-10	0	13.55996
			2	13.55996
			5	13.55996
			10	13.55996
		0	0	13.55996
			2	13.55996
			5	13.55996
			10	13.55996
		10	0	13.55996
			2	13.55996
			5	13.55996
			10	13.55996
		20	0	13.55997
			2	13.55998
			5	13.55996
			10	13.55996
		30	0	13.55998
			2	13.55998
			5	13.55997
			10	13.55996
		40	0	13.55998
			2	13.55997
			5	13.55998
			10	13.55998



Voltage vs. Frequency Stability		Temperature vs. Frequency Stability		
Voltage (Vac)	Measurement Frequency (MHz)	Temperature (°C)	Time	Measurement Frequency (MHz)
		50	0	13.55997
			2	13.55998
			5	13.55997
			10	13.55998
Max.Deviation (MHz)	-0.00003	Max.Deviation (MHz)		-0.00004
Max.Deviation (ppm)	-2.2124	Max.Deviation (ppm)		-2.9499
Limit	FS < ±100 ppm	Limit		FS < ±100 ppm
Test Result	PASS	Test Result		PASS



# Appendix C. Test Results of Radiated Test Items

## C1. Test Result of Field Strength of Fundamental Emissions

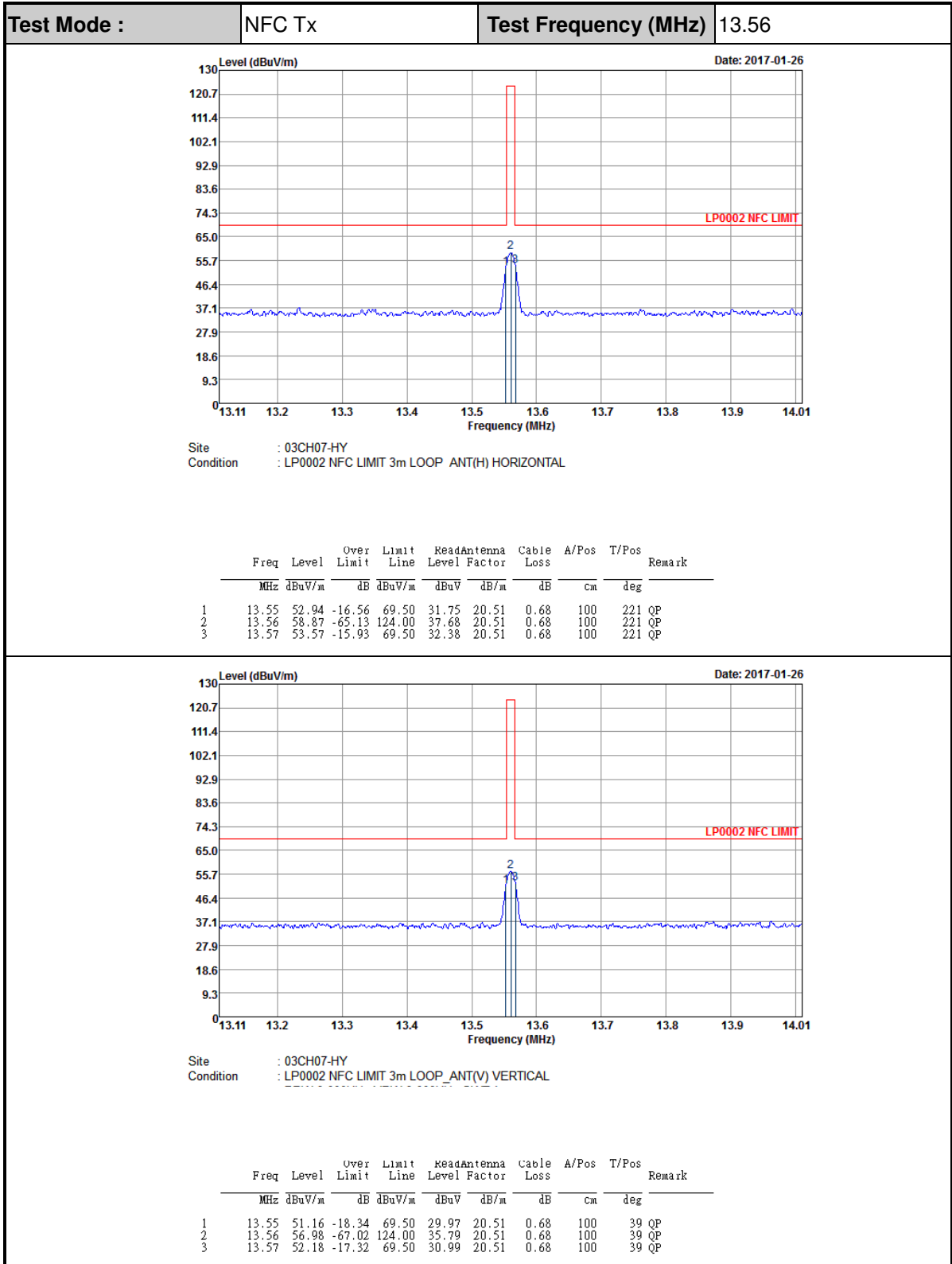



**C2. Results of Radiated Spurious Emissions (9 kHz~30MHz)**

<b>Test Mode :</b>	NFC Tx	<b>Polarization :</b>	Horizontal
--------------------	--------	-----------------------	------------

Frequency ( MHz )	Level ( dBμV/m )	Over Limit ( dB )	Limit Line ( dBμV/m )	Read Level (dBμV)	Antenna Factor ( dB )	Cable Loss ( dB )	Ant Pos ( cm )	Table Pos ( deg )	Remark
0.01339	44.96	-80.11	125.07	21.38	22.9	0.68	-	-	Average
0.07086	44.04	-66.56	110.6	24.36	19	0.68	-	-	Average
0.10294	34.78	-72.57	107.35	15.3	18.8	0.68	-	-	QP
0.11012	33.87	-72.9	106.77	14.39	18.8	0.68	-	-	Average
0.15238	45.97	-57.98	103.95	26.52	18.77	0.68	-	-	Average
0.49751	37.52	-36.15	73.67	18.24	18.6	0.68	-	-	QP
10.928	36.45	-33.05	69.5	15.78	19.99	0.68	-	-	QP
21.256	38.96	-30.54	69.5	16.02	21.87	1.07	100	33	QP
27.68	38.94	-30.56	69.5	15.61	22.26	1.07	-	-	QP

<b>Test Mode :</b>	NFC Tx	<b>Polarization :</b>	Vertical
--------------------	--------	-----------------------	----------

Frequency ( MHz )	Level ( dBμV/m )	Over Limit ( dB )	Limit Line ( dBμV/m )	Read Level (dBμV)	Antenna Factor ( dB )	Cable Loss ( dB )	Ant Pos ( cm )	Table Pos ( deg )	Remark
0.01318	45.67	-79.54	125.21	22.09	22.9	0.68	-	-	Average
0.07011	50.58	-60.11	110.69	30.9	19	0.68	-	-	Average
0.0901	34.27	-74.24	108.51	14.79	18.8	0.68	-	-	QP
0.11024	31.67	-75.09	106.76	12.19	18.8	0.68	-	-	Average
0.15	45.68	-58.4	104.08	26.23	18.77	0.68	-	-	Average
0.49	37	-36.8	73.8	17.72	18.6	0.68	-	-	QP
8.36	36.92	-32.58	69.5	16.7	19.54	0.68	-	-	QP
23.002	38.59	-30.91	69.5	15.54	21.98	1.07	-	-	QP
28.325	39.34	-30.16	69.5	15.97	22.3	1.07	100	115	QP

**Note:**

1. The amplitude of spurious emissions which are attenuated by more than 20dB below the permissible value has no need to be reported.
2. Distance extrapolation factor = 40 log (specific distance / test distance) (dB);
3. Limit line = specific limits (dBμV) + distance extrapolation factor.



**C3. Results of Radiated Spurious Emissions (30MHz~1GHz)**

<b>Test Mode :</b>	NFC Tx	<b>Polarization :</b>	Horizontal
--------------------	--------	-----------------------	------------

Frequency ( MHz )	Level ( dBμV/m )	Over Limit ( dB )	Limit Line ( dBμV/m )	Read Level ( dBμV )	Antenna Factor ( dB )	Cable Loss ( dB )	Preamp Factor ( dB )	Ant Pos ( cm )	Table Pos ( deg )	Remark
30	28.37	-11.63	40	32.65	26	1.07	31.35	100	0	Peak
40.68	26.37	-13.63	40	36.95	19.84	1.07	31.49	-	-	Peak
244.11	24.12	-21.88	46	34.99	18.45	2.07	31.39	-	-	Peak
587.7	27.79	-18.21	46	30.07	25.2	3.36	30.84	-	-	Peak
843.9	32.23	-13.77	46	30.12	28.58	4.1	30.57	-	-	Peak
954.5	33.37	-12.63	46	29.62	30.21	4.07	30.53	-	-	Peak

<b>Test Mode :</b>	NFC Tx	<b>Polarization :</b>	Vertical
--------------------	--------	-----------------------	----------

Frequency ( MHz )	Level ( dBμV/m )	Over Limit ( dB )	Limit Line ( dBμV/m )	Read Level ( dBμV )	Antenna Factor ( dB )	Cable Loss ( dB )	Preamp Factor ( dB )	Ant Pos ( cm )	Table Pos ( deg )	Remark
40.68	39.14	-0.86	40	49.72	19.84	1.07	31.49	100	59	QP
67.8	22.69	-17.31	40	40.42	12.56	1.28	31.57	-	-	Peak
258.96	25.06	-20.94	46	34.45	19.9	2.07	31.36	-	-	Peak
544.3	27.15	-18.85	46	30.29	24.55	3.24	30.93	-	-	Peak
815.2	31.23	-14.77	46	29.92	27.99	3.9	30.58	-	-	Peak
986	33.62	-20.38	54	29.89	30.27	3.98	30.52	-	-	Peak

**Note:**

1. The amplitude of spurious emissions which are attenuated by more than 20dB below the permissible value has no need to be reported.
2. Emission level (dBμV/m) = 20 log Emission level (μV/m).
3. Corrected Reading: Antenna Factor + Cable Loss + Read Level - Preamp Factor= Level.