



# SAR TEST REPORT

No. I17Z60075-SEM04

For

**HMD Global Oy**

**Smart Phone**

**Model Name: TA-1025**

With

**Hardware Version: 3**

**Software Version: 000C\_3\_110**

**FCC ID: 2AJOTTA-1025**

**Issued Date: 2017-5-1**



**Note:**

The test results in this test report relate only to the devices specified in this report. This report shall not be reproduced except in full without the written approval of CTTL.

**Test Laboratory:**

CTTL, Telecommunication Technology Labs, Academy of Telecommunication Research, MIIT  
No. 51 Shouxiang Science Building, Xueyuan Road, Haidian District, Beijing, P. R. China100191  
Tel:+86(0)10-62304633-2512,Fax:+86(0)10-62304633-2504  
Email:[ctl\\_terminals@catr.cn](mailto:ctl_terminals@catr.cn), website:[www.chinattl.com](http://www.chinattl.com)



## **REPORT HISTORY**

<b>Report Number</b>	<b>Revision</b>	<b>Issue Date</b>	<b>Description</b>
I17Z60075-SEM04	Rev.0	2017-4-17	Initial creation of test report
I17Z60075-SEM04	Rev.1	2017-4-21	<ol style="list-style-type: none"><li>1. Remove the value of WLAN 2.4G HT40 mode on page 40</li><li>2. Modify the description of OFDM adjusted SAR on page 63</li></ol>
I17Z60075-SEM04	Rev.2	2017-5-1	<ol style="list-style-type: none"><li>1. Modify the description of WLAN 5GHz in the table 2.1 on page 6</li><li>2. Add the simultaneous SAR values for cellular(PCE) and NII on page 7</li></ol>

## TABLE OF CONTENT

<b>1</b>	<b>TEST LABORATORY</b> .....	<b>5</b>
1.1	TESTING LOCATION.....	5
1.2	TESTING ENVIRONMENT .....	5
1.3	PROJECT DATA.....	5
1.4	SIGNATURE.....	5
<b>2</b>	<b>STATEMENT OF COMPLIANCE</b> .....	<b>6</b>
<b>3</b>	<b>CLIENT INFORMATION</b> .....	<b>8</b>
3.1	APPLICANT INFORMATION.....	8
3.2	MANUFACTURER INFORMATION.....	8
<b>4</b>	<b>EQUIPMENT UNDER TEST (EUT) AND ANCILLARY EQUIPMENT (AE)</b> .....	<b>9</b>
4.1	ABOUT EUT .....	9
4.2	INTERNAL IDENTIFICATION OF EUT USED DURING THE TEST .....	9
4.3	INTERNAL IDENTIFICATION OF AE USED DURING THE TEST.....	9
<b>5</b>	<b>TEST METHODOLOGY</b> .....	<b>10</b>
5.1	APPLICABLE LIMIT REGULATIONS .....	10
5.2	APPLICABLE MEASUREMENT STANDARDS .....	10
<b>6</b>	<b>SPECIFIC ABSORPTION RATE (SAR)</b> .....	<b>11</b>
6.1	INTRODUCTION .....	11
6.2	SAR DEFINITION.....	11
<b>7</b>	<b>TISSUE SIMULATING LIQUIDS</b> .....	<b>12</b>
7.1	TARGETS FOR TISSUE SIMULATING LIQUID.....	12
7.2	DIELECTRIC PERFORMANCE .....	12
<b>8</b>	<b>SYSTEM VERIFICATION</b> .....	<b>20</b>
8.1	SYSTEM SETUP.....	20
8.2	SYSTEM VERIFICATION.....	21
<b>9</b>	<b>MEASUREMENT PROCEDURES</b> .....	<b>22</b>
9.1	TESTS TO BE PERFORMED .....	22
9.2	GENERAL MEASUREMENT PROCEDURE .....	24
9.3	WCDMA MEASUREMENT PROCEDURES FOR SAR .....	25
9.4	SAR MEASUREMENT FOR LTE.....	26
9.5	BLUETOOTH & WI-FI MEASUREMENT PROCEDURES FOR SAR .....	26
9.6	POWER DRIFT .....	27
<b>10</b>	<b>AREA SCAN BASED 1-G SAR</b> .....	<b>27</b>
10.1	REQUIREMENT OF KDB .....	27
10.2	FAST SAR ALGORITHMS.....	27
<b>11</b>	<b>CONDUCTED OUTPUT POWER</b> .....	<b>28</b>

11.1	GSM MEASUREMENT RESULT .....	28
11.2	WCDMA MEASUREMENT RESULT .....	29
11.3	LTE MEASUREMENT RESULT .....	30
11.4	WI-FI AND BT MEASUREMENT RESULT .....	39
<b>12</b>	<b>SIMULTANEOUS TX SAR CONSIDERATIONS .....</b>	<b>42</b>
12.1	INTRODUCTION .....	42
12.2	TRANSMIT ANTENNA SEPARATION DISTANCES .....	42
12.3	SAR MEASUREMENT POSITIONS .....	43
12.4	STANDALONE SAR TEST EXCLUSION CONSIDERATIONS .....	43
<b>13</b>	<b>EVALUATION OF SIMULTANEOUS .....</b>	<b>44</b>
<b>14</b>	<b>SAR TEST RESULT .....</b>	<b>45</b>
14.1	EVALUATION OF MULTI-BATTERIES AND SIM SLOTS .....	45
14.2	SAR RESULTS .....	47
14.3	FULL SAR .....	62
14.4	WLAN EVALUATION FOR 2.4G .....	63
14.5	WLAN EVALUATION FOR 5G .....	66
<b>15</b>	<b>SAR MEASUREMENT VARIABILITY .....</b>	<b>71</b>
<b>16</b>	<b>MEASUREMENT UNCERTAINTY .....</b>	<b>72</b>
16.1	MEASUREMENT UNCERTAINTY FOR NORMAL SAR TESTS (300MHz~3GHz) .....	72
16.2	MEASUREMENT UNCERTAINTY FOR NORMAL SAR TESTS (3~6GHz) .....	73
16.3	MEASUREMENT UNCERTAINTY FOR FAST SAR TESTS (300MHz~3GHz) .....	74
16.4	MEASUREMENT UNCERTAINTY FOR FAST SAR TESTS (3~6GHz) .....	75
<b>17</b>	<b>MAIN TEST INSTRUMENTS .....</b>	<b>77</b>
<b>ANNEX A</b>	<b>GRAPH RESULTS .....</b>	<b>78</b>
<b>ANNEX B</b>	<b>SYSTEM VERIFICATION RESULTS .....</b>	<b>110</b>
<b>ANNEX C</b>	<b>SAR MEASUREMENT SETUP .....</b>	<b>129</b>
<b>ANNEX D</b>	<b>POSITION OF THE WIRELESS DEVICE IN RELATION TO THE PHANTOM .....</b>	<b>135</b>
<b>ANNEX E</b>	<b>EQUIVALENT MEDIA RECIPES .....</b>	<b>138</b>
<b>ANNEX F</b>	<b>SYSTEM VALIDATION .....</b>	<b>139</b>
<b>ANNEX G</b>	<b>PROBE CALIBRATION CERTIFICATE .....</b>	<b>140</b>
<b>ANNEX H</b>	<b>DIPOLE CALIBRATION CERTIFICATE .....</b>	<b>151</b>
<b>ANNEX I</b>	<b>ACCREDITATION CERTIFICATE .....</b>	<b>212</b>

## 1 Test Laboratory

### 1.1 Testing Location

Company Name:	CTTL(Shouxiang)
Address:	No. 51 Shouxiang Science Building, Xueyuan Road, Haidian District, Beijing, P. R. China100191

### 1.2 Testing Environment

Temperature:	18°C~25 °C,
Relative humidity:	30%~ 70%
Ground system resistance:	< 0.5 $\Omega$
Ambient noise & Reflection:	< 0.012 W/kg

### 1.3 Project Data

Project Leader:	Qi Dianyuan
Test Engineer:	Lin Xiaojun
Testing Start Date:	April 5, 2017
Testing End Date:	April 11, 2017

### 1.4 Signature



---

Lin Xiaojun  
(Prepared this test report)

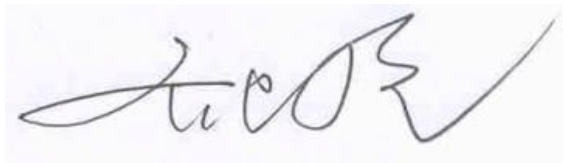

---

Qi Dianyuan  
(Reviewed this test report)

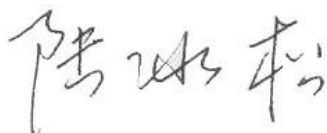

---

Lu Bingsong  
Deputy Director of the laboratory  
(Approved this test report)

## 2 Statement of Compliance

The maximum results of SAR found during testing for HMD Global Oy Smart Phone TA-1025 is as follows:

**Table 2.1: Highest Reported SAR (1g)**

Exposure Configuration	Technology Band	Highest Reported SAR 1g (W/Kg)	Equipment Class
Head (Separation Distance 0mm)	GSM 850	0.18	PCE
	PCS 1900	0.19	
	UMTS FDD 2	0.53	
	UMTS FDD 4	0.30	
	UMTS FDD 5	0.23	
	LTE Band 2	0.36	
	LTE Band 4	0.13	
	LTE Band 7	0.42	
	LTE Band 12	0.16	
	LTE Band 38	0.24	
	WLAN 2.4 GHz	1.22	
	WLAN 5 GHz	1.24	NII
	Hotspot (Separation Distance 10mm)	GSM 850	0.32
PCS 1900		0.58	
UMTS FDD 2		0.62	
UMTS FDD 4		0.42	
UMTS FDD 5		0.38	
LTE Band 2		0.47	
LTE Band 4		0.18	
LTE Band 7		0.53	
LTE Band 12		0.23	
LTE Band 38		0.17	
WLAN 2.4 GHz		0.09	DTS
WLAN 5 GHz		0.06	NII

The SAR values found for the Mobile Phone are below the maximum recommended levels of 1.6 W/Kg as averaged over any 1g tissue according to the ANSI C95.1-1992.

For body worn operation, this device has been tested and meets FCC RF exposure guidelines when used with any accessory that contains no metal and which provides a minimum separation distance of 10 mm between this device and the body of the user. Use of other accessories may not ensure compliance with FCC RF exposure guidelines.

The EUT battery must be fully charged and checked periodically during the test to ascertain uniform power output.

The measurement together with the test system set-up is described in annex C of this test report. A detailed description of the equipment under test can be found in chapter 4 of this test report.

The highest reported SAR value is obtained at the case of **(Table 2.1)**, and the values are: 1.24 W/kg (1g).

**Table 2.2: The sum of reported SAR values for main antenna and WiFi**

	Position	Main antenna	WiFi	Sum
<b>Highest reported SAR value for Head</b>	Right hand, Touch cheek	0.34	1.22(DTS)	<b>1.56</b>
			1.24(NII)	<b>1.58</b>
<b>Highest reported SAR value for Body</b>	Left edge	0.62	0.03(DTS)	<b>0.65</b>
			0.02(NII)	<b>0.64</b>

Note1: we have evaluated and chose the highest value of both main antennae in the above table

**Table 2.3: The sum of reported SAR values for main antenna and BT**

	Position	Main antenna	BT	Sum
<b>Maximum reported SAR value for Head</b>	Left hand, Touch cheek	0.53	0.19	<b>0.72</b>
<b>Maximum reported SAR value for Body</b>	Left edge	0.62	0.09	<b>0.71</b>

[1] - Estimated SAR for Bluetooth (see the table 13.3)

According to the above tables, the highest sum of reported SAR values is **1.58 W/kg (1g)**. The detail for simultaneous transmission consideration is described in chapter 13.

### 3 Client Information

#### 3.1 Applicant Information

Company Name:	HMD Global Oy
Address /Post:	Karaportti 2, 02610 Espoo, Finland
City:	Shanghai
Postal Code:	/
Country:	China
Contact Person:	Gong Zhizhou
E-mail:	mikko.kahlos@hmdglobal.com
Telephone:	+358-408036126
Fax:	/

#### 3.2 Manufacturer Information

Company Name:	HMD Global Oy
Address /Post:	Karaportti 2, 02610 Espoo, Finland
City:	Shanghai
Postal Code:	/
Country:	China
Contact Person:	Mikko Kahlos
E-mail:	mikko.kahlos@hmdglobal.com
Telephone:	+358-408036126
Fax:	/



## 4 Equipment Under Test (EUT) and Ancillary Equipment (AE)

### 4.1 About EUT

Description:	Smart Phone
Model name:	TA-1025
Operating mode(s):	GSM 850/900/1800/1900 WCDMA850/900/1700/1900/2100 LTE B2/3/4/7/12/17/28/38, BT, WLAN
Tested Tx Frequency:	825 – 848.8 MHz (GSM 850)
	1850.2 – 1910 MHz (GSM 1900)
	826.4–846.6 MHz (WCDMA 850 Band V)
	1712.4 – 1752.6 MHz (WCDMA 1700 Band IV)
	1852.4–1907.6 MHz (WCDMA1900 Band II)
	1860 – 1900 MHz (LTE Band 2)
	1720 – 1745 MHz (LTE Band 4)
	2502.5 – 2567.5 MHz (LTE Band 7)
	707.5 – 715.3 MHz (LTE Band 12)
	706.5 – 713.5MHz(LTE Band 17)
	2572.5 – 2617.5 MHz (LTE Band 38)
2412 – 2462 MHz (Wi-Fi 2.4G)	
5180 – 5825 MHz (Wi-Fi 5G)	
GPRS/EGPRS Multislot Class:	33
GPRS capability Class:	33
Test device Production information:	Production unit
Device type:	Portable device
Antenna type:	Integrated antenna
Accessories/Body-worn configurations:	Headset
Hotspot mode:	Support
Product dimension	Long 154 mm ;Wide 75.8 mm ; Overall Diagonal 171.6 mm

### 4.2 Internal Identification of EUT used during the test

EUTID	IMEI	HW Version	SW Version
1	356020080000331	3	000C_3_110
	356020080000349		
2	356020080026113	3	000C_3_110
	356020080026121		
3	356020080010331	3	000C_3_110
	356020080010349		
4	356020080026238	3	000C_3_110
	356020080026246		

\*EUT ID: is used to identify the test sample in the lab internally.

**Note:** It is performed to test SAR with the EUT1 to 3 and conducted power with the EUT4.

### 4.3 Internal Identification of AE used during the test

AE ID*	Description	Model	SN	Manufacturer
AE1	Battery	HE316	/	SCUD
AE2	Battery	HE317	/	SCUD
AE3	Headset	CAB5422B-N01-DG	/	Foxconn

\*AE ID: is used to identify the test sample in the lab internally.

## 5 TEST METHODOLOGY

### 5.1 Applicable Limit Regulations

**ANSI C95.1–1992:** IEEE Standard for Safety Levels with Respect to Human Exposure to Radio Frequency Electromagnetic Fields, 3 kHz to 300 GHz.

It specifies the maximum exposure limit of **1.6 W/kg** as averaged over any 1 gram of tissue for portable devices being used within 20 cm of the user in the uncontrolled environment.

### 5.2 Applicable Measurement Standards

**IEEE 1528–2013:** Recommended Practice for Determining the Peak Spatial-Average Specific Absorption Rate (SAR) in the Human Head from Wireless Communications Devices: Measurement Techniques.

**KDB447498 D01 General RF Exposure Guidance v06:** Mobile and Portable Devices RF Exposure Procedures and Equipment Authorization Policies.

**KDB648474 D04 Handset SAR v01r03:** SAR Evaluation Considerations for Wireless Handsets.

**KDB941225 D01 SAR test for 3G devices v03r01:** SAR Measurement Procedures for 3G Devices

**KDB941225 D05 SAR for LTE Devices v02r05:** SAR Evaluation Considerations for LTE Devices

**KDB248227 D01 802.11 Wi-Fi SAR v02r02:** SAR GUIDANCE FOR IEEE 802.11 (Wi-Fi) TRANSMITTERS

**KDB865664 D01 SAR measurement 100 MHz to 6 GHz v01r04:** SAR Measurement Requirements for 100 MHz to 6 GHz.

**KDB865664 D02 RF Exposure Reporting v01r02:** RF Exposure Compliance Reporting and Documentation Considerations

## 6 Specific Absorption Rate (SAR)

### 6.1 Introduction

SAR is related to the rate at which energy is absorbed per unit mass in an object exposed to a radio field. The SAR distribution in a biological body is complicated and is usually carried out by experimental techniques or numerical modeling. The standard recommends limits for two tiers of groups, occupational/controlled and general population/uncontrolled, based on a person's awareness and ability to exercise control over his or her exposure. In general, occupational/controlled exposure limits are higher than the limits for general population/uncontrolled.

### 6.2 SAR Definition

The SAR definition is the time derivative (rate) of the incremental energy ( $dW$ ) absorbed by (dissipated in) an incremental mass ( $dm$ ) contained in a volume element ( $dv$ ) of a given density ( $\rho$ ). The equation description is as below:

$$SAR = \frac{d}{dt} \left( \frac{dW}{dm} \right) = \frac{d}{dt} \left( \frac{dW}{\rho dv} \right)$$

SAR is expressed in units of Watts per kilogram (W/kg)

SAR measurement can be either related to the temperature elevation in tissue by

$$SAR = c \left( \frac{\delta T}{\delta t} \right)$$

Where:  $C$  is the specific heat capacity,  $\delta T$  is the temperature rise and  $\delta t$  is the exposure duration, or related to the electrical field in the tissue by

$$SAR = \frac{\sigma |E|^2}{\rho}$$

Where:  $\sigma$  is the conductivity of the tissue,  $\rho$  is the mass density of tissue and  $E$  is the RMS electrical field strength.

However for evaluating SAR of low power transmitter, electrical field measurement is typically applied.

## 7 Tissue Simulating Liquids

### 7.1 Targets for tissue simulating liquid

Table 7.1: Targets for tissue simulating liquid

Frequency(MHz)	Liquid Type	Conductivity( $\sigma$ )	$\pm 5\%$ Range	Permittivity( $\epsilon$ )	$\pm 5\%$ Range
750	Head	0.89	0.85~0.93	41.94	39.8~44.0
750	Body	0.96	0.91~1.01	55.5	52.7~58.3
835	Head	0.90	0.86~0.95	41.5	39.4~43.6
835	Body	0.97	0.92~1.02	55.2	52.4~58.0
1750	Head	1.37	1.30~1.44	40.08	38.1~42.1
1750	Body	1.49	1.42~1.56	53.4	50.7~56.1
1900	Head	1.40	1.33~1.47	40.0	38.0~42.0
1900	Body	1.52	1.44~1.60	53.3	50.6~56.0
2450	Head	1.80	1.71~1.89	39.2	37.2~41.2
2450	Body	1.95	1.85~2.05	52.7	50.1~55.3
2600	Head	1.96	1.86~2.06	39.01	37.06~40.96
2600	Body	2.16	2.05~2.27	52.5	49.9~55.1
5250	Head	4.71	4.47~4.95	35.93	34.1~37.7
5250	Body	5.36	5.09~5.63	48.9	46.5~51.3
5600	Head	5.07	4.82~5.32	35.53	33.8~37.3
5600	Body	5.77	5.48~6.06	48.5	46.1~50.9
5750	Head	5.22	4.96~5.48	35.36	33.6~37.1
5750	Body	5.94	5.64~6.24	48.3	45.9~50.7

### 7.2 Dielectric Performance

Table 7.2: Dielectric Performance of Tissue Simulating Liquid

Measurement Date (yyyy-mm-dd)	Type	Frequency	Permittivity $\epsilon$	Drift (%)	Conductivity $\sigma$ (S/m)	Drift (%)
2017-4-5	Head	750 MHz	41.7	-0.57	0.898	0.90
	Body	750 MHz	55.35	-0.27	0.951	-0.94
2017-4-6	Head	835 MHz	41.6	0.24	0.901	0.11
	Body	835 MHz	56.1	1.63	0.988	1.86
2017-4-7	Head	1750 MHz	40.68	1.50	1.38	0.73
	Body	1750 MHz	53.22	-0.34	1.514	1.61
2017-4-8	Head	1900 MHz	39.55	-1.13	1.39	-0.71
	Body	1900 MHz	53.19	-0.21	1.536	1.05
2017-4-9	Head	2450 MHz	39.05	-0.38	1.784	-0.89
	Body	2450 MHz	53.36	1.25	1.966	0.82
2017-4-10	Head	2600 MHz	39.57	1.44	1.966	0.31
	Body	2600 MHz	51.61	-1.70	2.138	-1.02
2017-4-11	Head	5250 MHz	36.28	0.97	4.726	0.34
	Body	5250 MHz	47.44	-2.99	5.259	-1.88
	Head	5600 MHz	35.73	0.56	5.199	2.54
	Body	5600 MHz	46.98	-3.13	5.708	-1.07
	Head	5750 MHz	35.38	0.06	5.414	3.72
	Body	5750 MHz	46.78	-3.15	5.992	0.88

Note: The liquid temperature is 22.0 °C

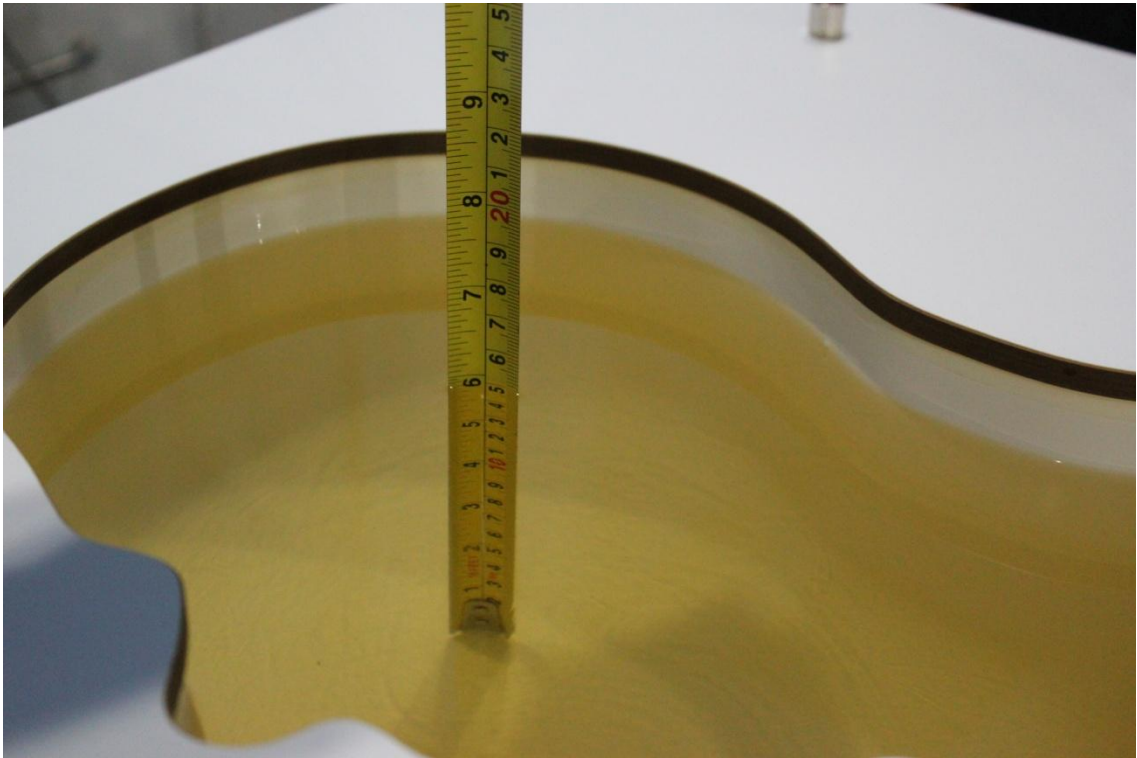

Picture 7-1 Liquid depth in the Head Phantom (750 MHz)



Picture 7-2 Liquid depth in the Flat Phantom (750 MHz)



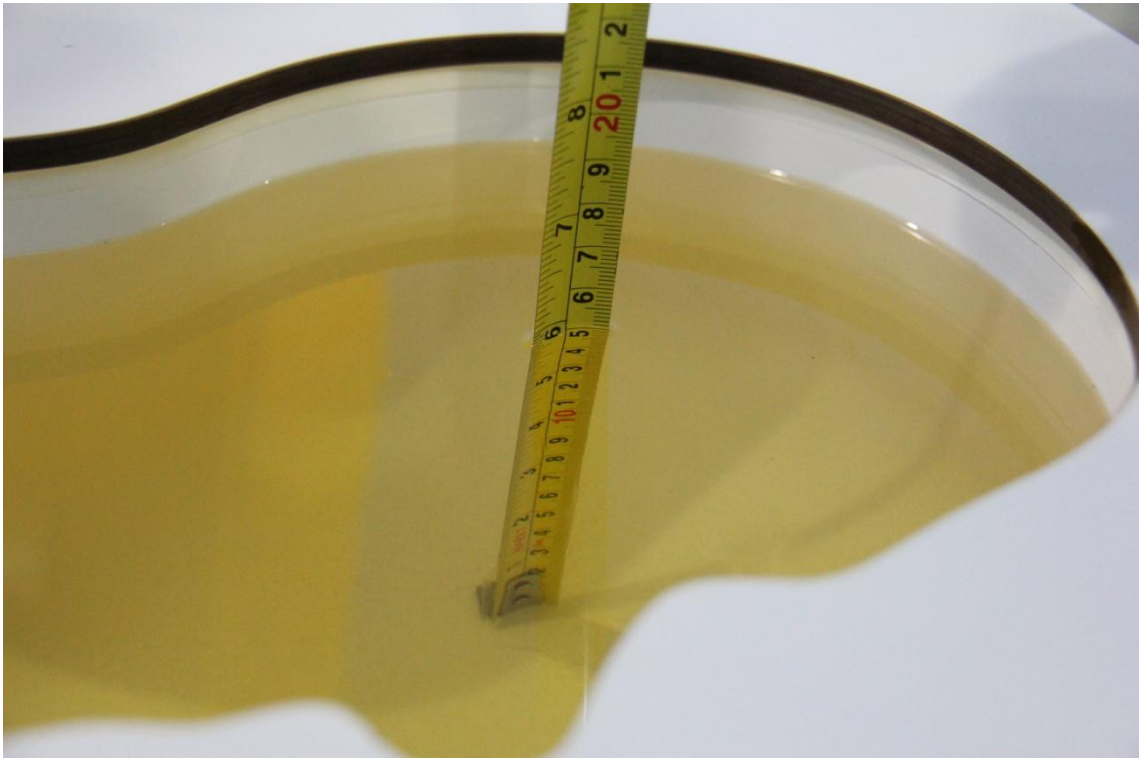

**Picture 7-3 Liquid depth in the Head Phantom (835MHz)**



**Picture 7-4 Liquid depth in the Flat Phantom (835MHz)**



Picture 7-5 Liquid depth in the Head Phantom (1750 MHz)

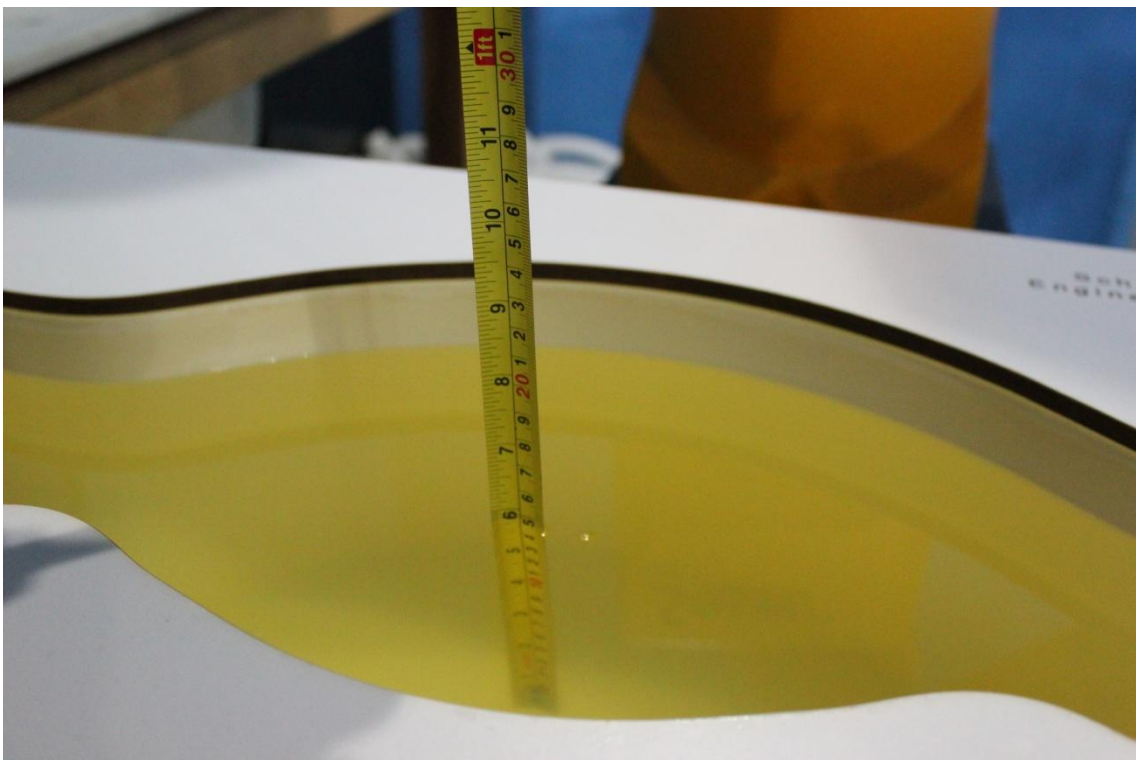

Picture 7-6 Liquid depth in the Flat Phantom (1750MHz)

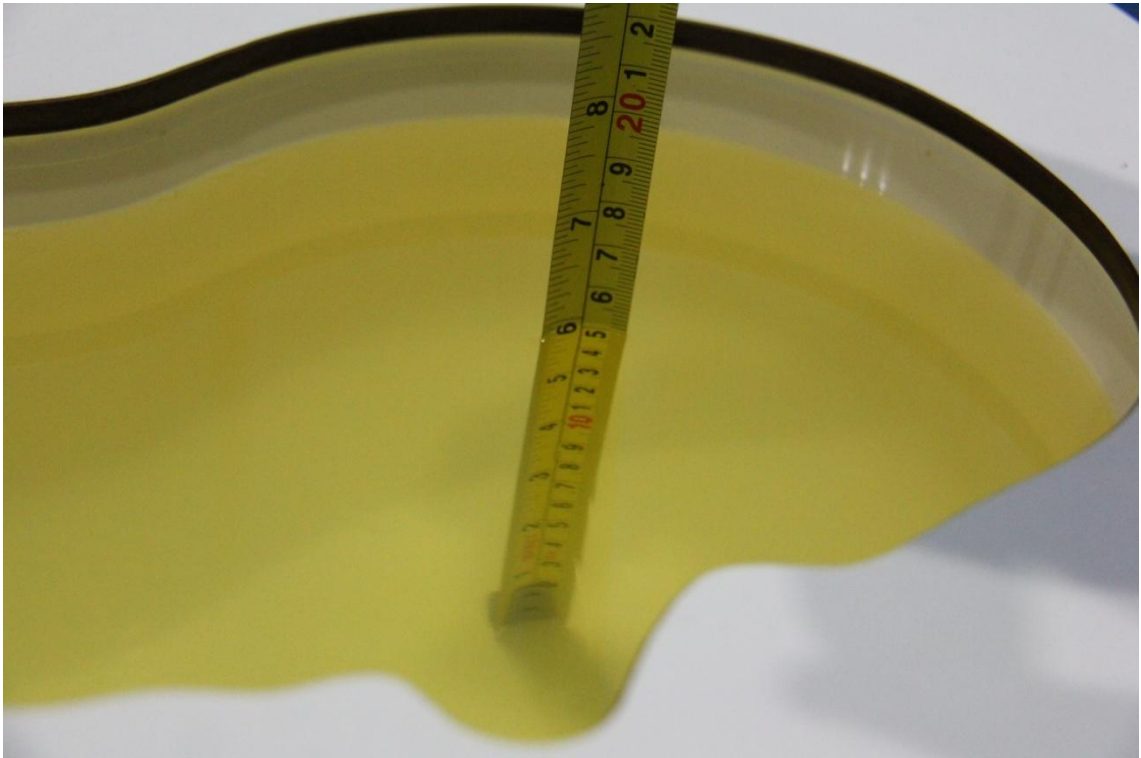

Picture 7-7 Liquid depth in the Head Phantom (1900 MHz)

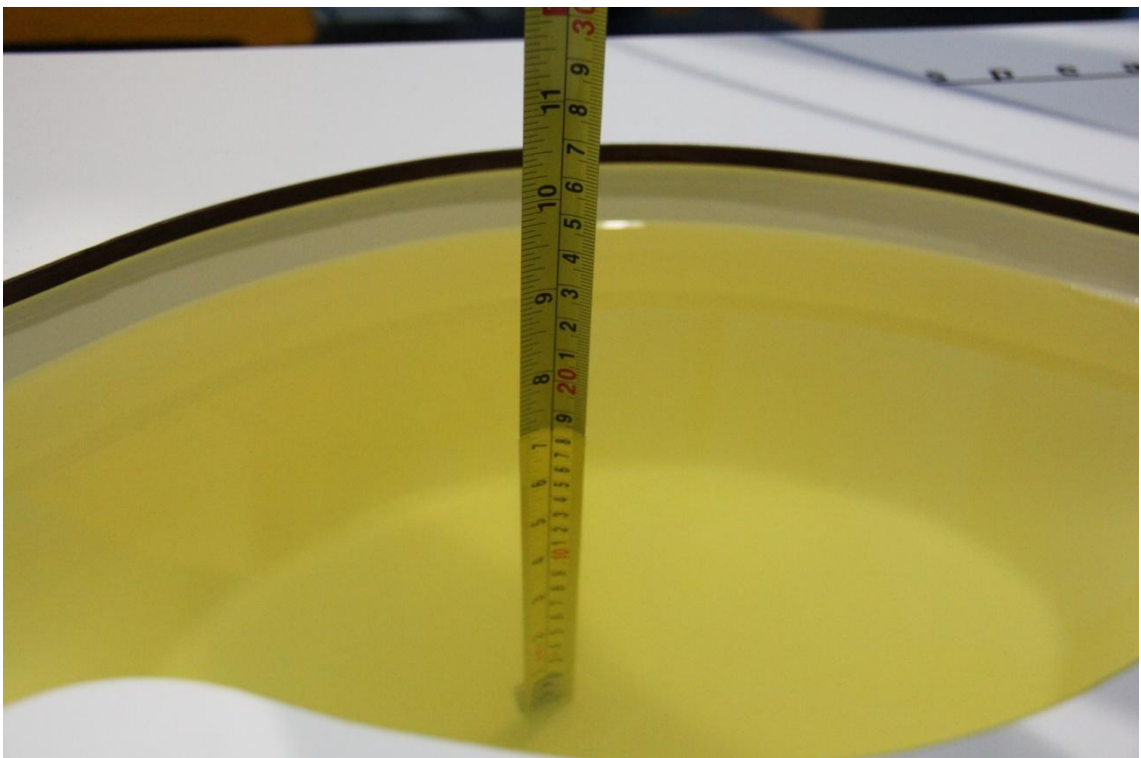

Picture 7-8 Liquid depth in the Flat Phantom (1900MHz)



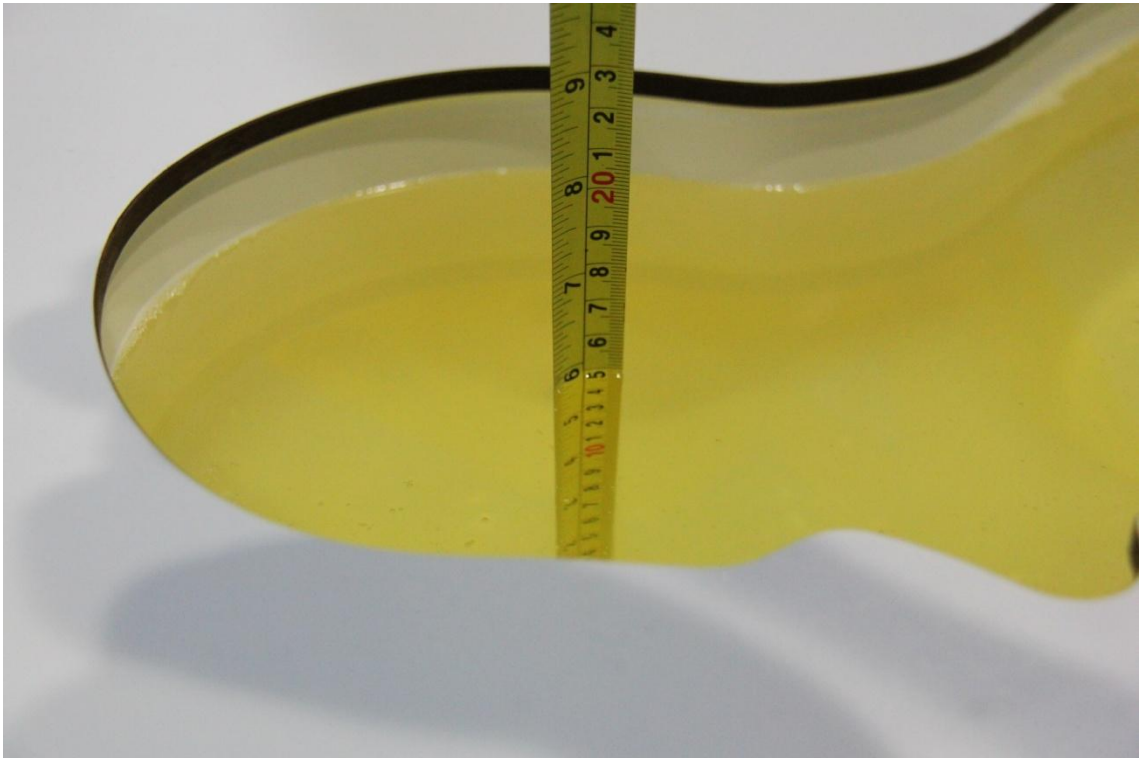

**Picture 7-9 Liquid depth in the Head Phantom (2450MHz)**

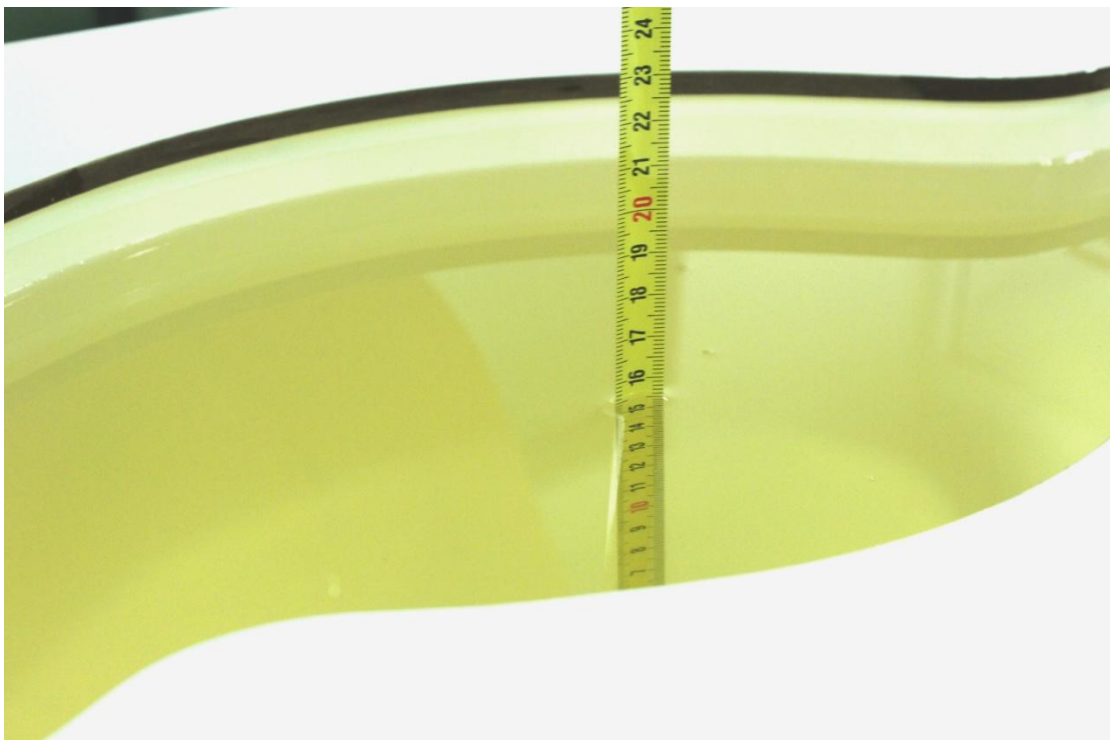

**Picture 7-10 Liquid depth in the Flat Phantom (2450MHz)**



**Picture 7-11 Liquid depth in the Head Phantom (2600 MHz Head)**

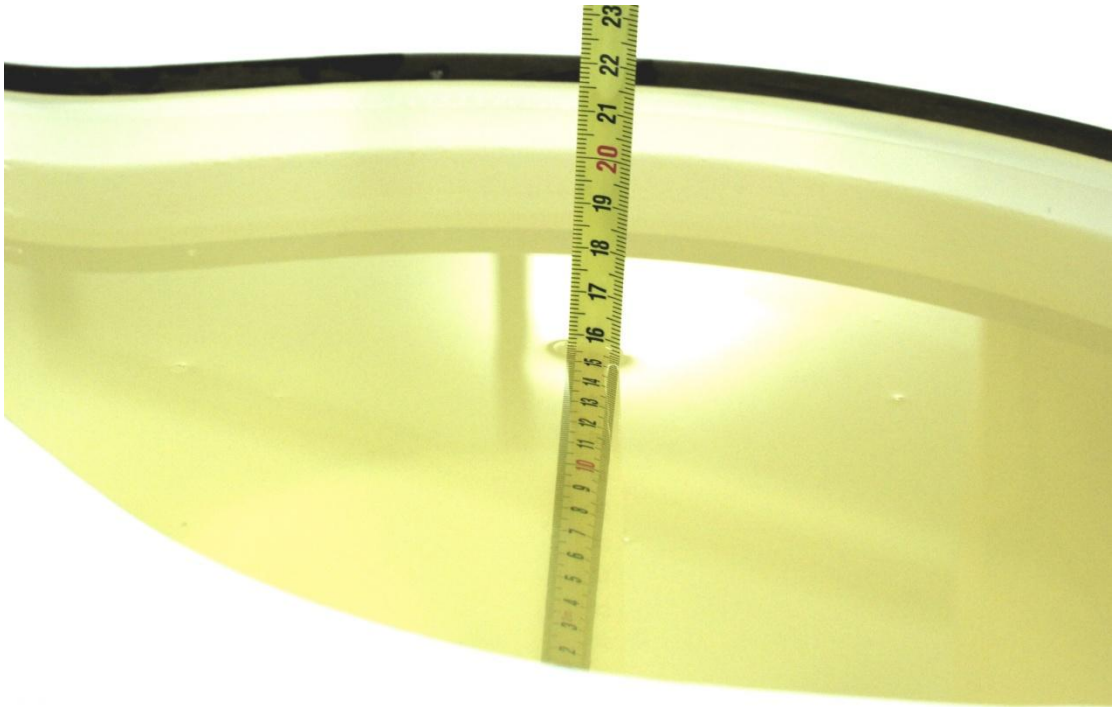

**Picture 7-12 Liquid depth in the Flat Phantom (2600MHz)**



**Picture 7-13 Liquid depth in the Head Phantom (5GHz)**

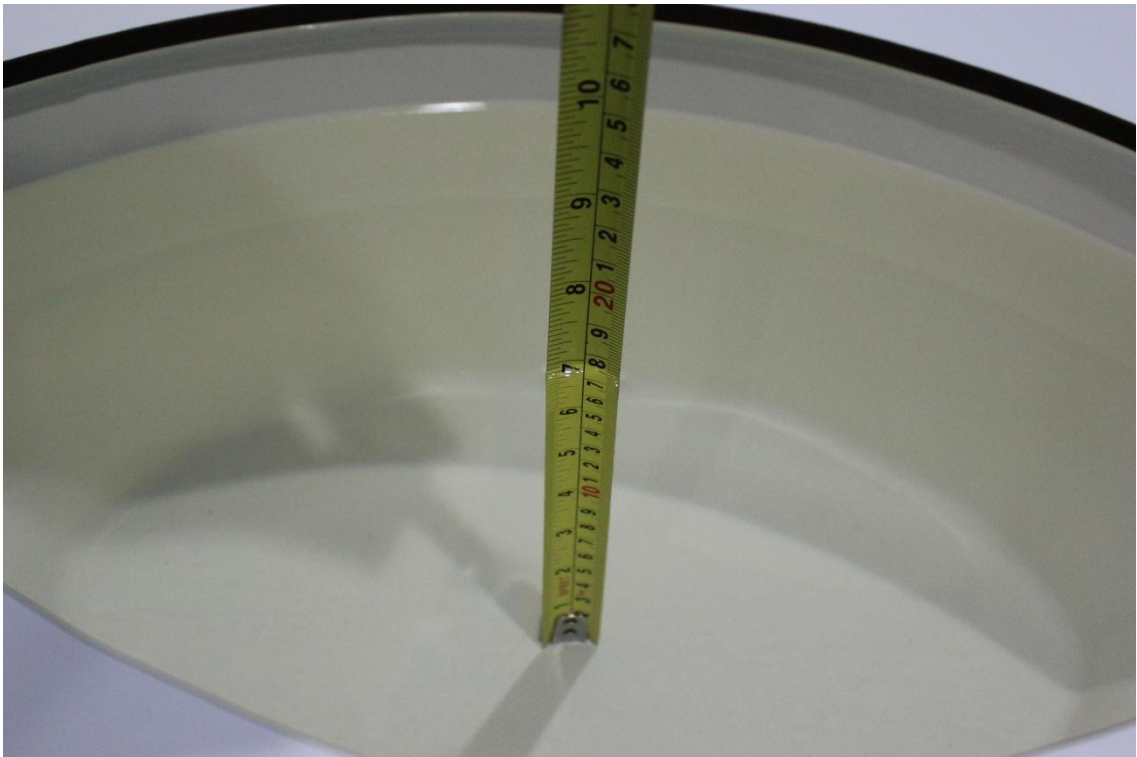

**Picture 7-14 Liquid depth in the Flat Phantom (5GHz)**

## 8 System verification

### 8.1 System Setup

In the simplified setup for system evaluation, the DUT is replaced by a calibrated dipole and the power source is replaced by a continuous wave that comes from a signal generator. The calibrated dipole must be placed beneath the flat phantom section of the SAM twin phantom with the correct distance holder. The distance holder should touch the phantom surface with a light pressure at the reference marking and be oriented parallel to the long side of the phantom. The equipment setup is shown below:

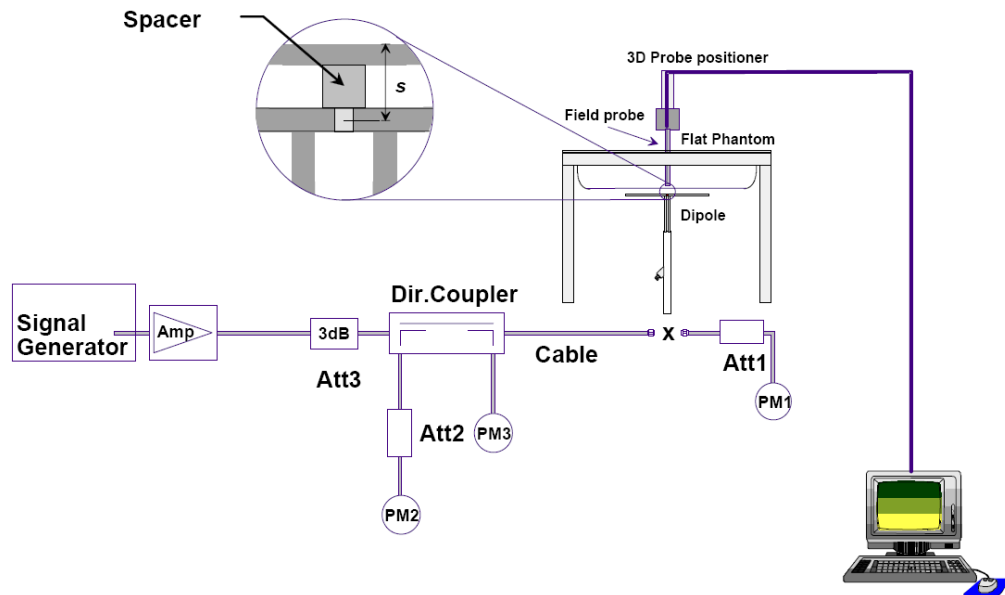

Picture 8.1 System Setup for System Evaluation



Picture 8.2 Photo of Dipole Setup

## 8.2 System Verification

SAR system verification is required to confirm measurement accuracy, according to the tissue dielectric media, probe calibration points and other system operating parameters required for measuring the SAR of a test device. The system verification must be performed for each frequency band and within the valid range of each probe calibration point required for testing the device.

The system verification results are required that the area scan estimated 1-g SAR is within 3% of the zoom scan 1-g SAR. The details are presented in annex B.

**Table 8.1: System Verification of Head**

Measurement Date (yyyy-mm-dd)	Frequency	Target value (W/kg)		Measured value(W/kg)		Deviation	
		10 g Average	1 g Average	10 g Average	1 g Average	10 g Average	1 g Average
2017-4-5	750 MHz	5.46	8.33	5.4	8.32	-1.10%	-0.12%
2017-4-6	835 MHz	6.18	9.44	6.2	9.56	0.32%	1.27%
2017-4-7	1750 MHz	19.5	36.8	19.6	36.24	0.51%	-1.52%
2017-4-8	1900 MHz	21.2	40.7	21	41.28	-0.94%	1.43%
2017-4-9	2450 MHz	24.6	52.8	25.04	53.76	1.79%	1.82%
2017-4-10	2600 MHz	25.2	56.7	25.36	57.6	0.63%	1.59%
2017-4-11	5250 MHz	5.46	8.33	5.4	8.32	-1.10%	-0.12%
	5600 MHz	6.18	9.44	6.2	9.56	0.32%	1.27%
	5750 MHz	19.5	36.8	19.6	36.24	0.51%	-1.52%

**Table 8.2: System Verification of Body**

Measurement Date (yyyy-mm-dd)	Frequency	Target value (W/kg)		Measured value (W/kg)		Deviation	
		10 g Average	1 g Average	10 g Average	1 g Average	10 g Average	1 g Average
2017-4-5	750 MHz	5.76	8.78	5.66	8.48	-1.74%	-3.42%
2017-4-6	835 MHz	6.36	9.69	6.20	9.64	-2.52%	-0.52%
2017-4-7	1750 MHz	19.6	37.0	19.44	37	-0.82%	0.00%
2017-4-8	1900 MHz	21.3	40.1	21.48	41	0.85%	2.24%
2017-4-9	2450 MHz	24.1	51.2	24.72	52.76	2.57%	3.05%
2017-4-10	2600 MHz	24.8	55.3	25.24	56.8	1.77%	2.71%
2017-4-11	5250 MHz	21.2	75.6	21.30	75.40	0.47%	-0.26%
	5600 MHz	22.1	79.1	22.50	79.30	1.81%	0.25%
	5750 MHz	20.8	74.5	20.90	74.20	0.48%	-0.40%



## 9 Measurement Procedures

### 9.1 Tests to be performed

In order to determine the highest value of the peak spatial-average SAR of a handset, all device positions, configurations and operational modes shall be tested for each frequency band according to steps 1 to 3 below. A flowchart of the test process is shown in picture 9.1.

**Step 1:** The tests described in 9.2 shall be performed at the channel that is closest to the center of the transmit frequency band ( $f_c$ ) for:

- a) all device positions (cheek and tilt, for both left and right sides of the SAM phantom, as described in annex D),
- b) all configurations for each device position in a), e.g., antenna extended and retracted, and
- c) all operational modes, e.g., analogue and digital, for each device position in a) and configuration in b) in each frequency band.

If more than three frequencies need to be tested according to 11.1 (i.e.,  $N_c > 3$ ), then all frequencies, configurations and modes shall be tested for all of the above test conditions.

**Step 2:** For the condition providing highest peak spatial-average SAR determined in Step 1, perform all tests described in 9.2 at all other test frequencies, i.e., lowest and highest frequencies. In addition, for all other conditions (device position, configuration and operational mode) where the peak spatial-average SAR value determined in Step 1 is within 3 dB of the applicable SAR limit, it is recommended that all other test frequencies shall be tested as well.

**Step 3:** Examine all data to determine the highest value of the peak spatial-average SAR found in Steps 1 to 2.

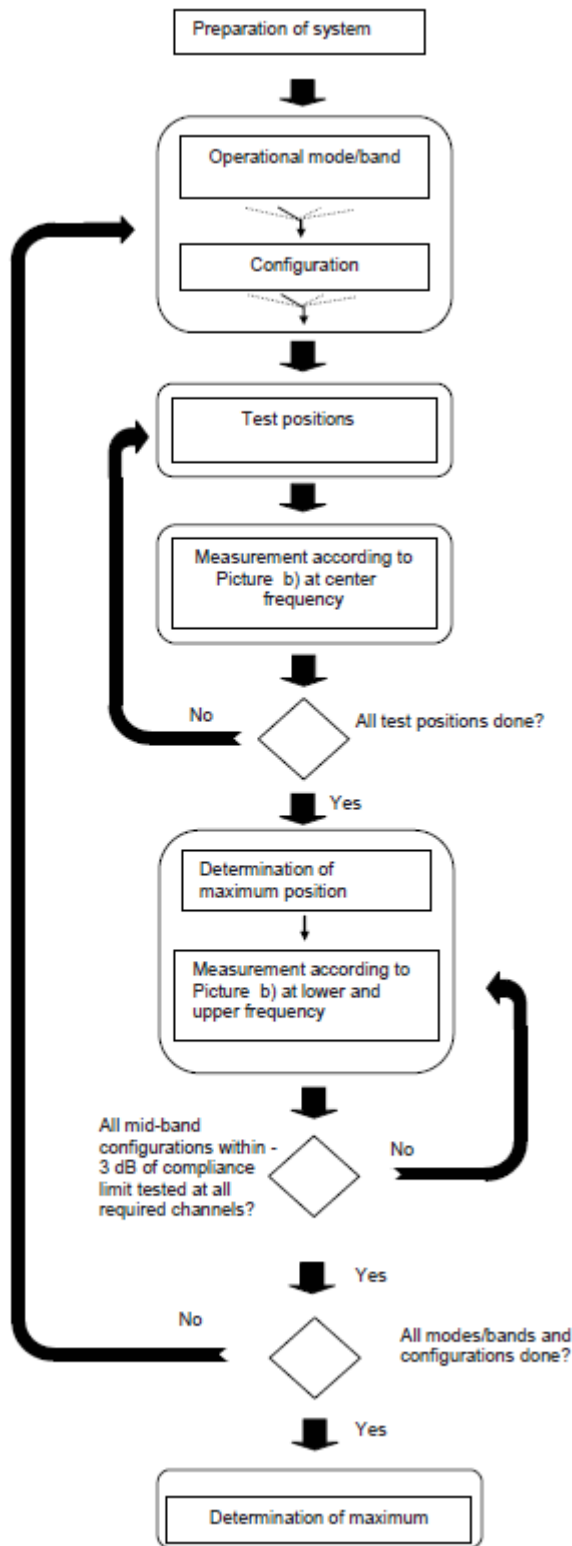

Picture a – Tests to be performed

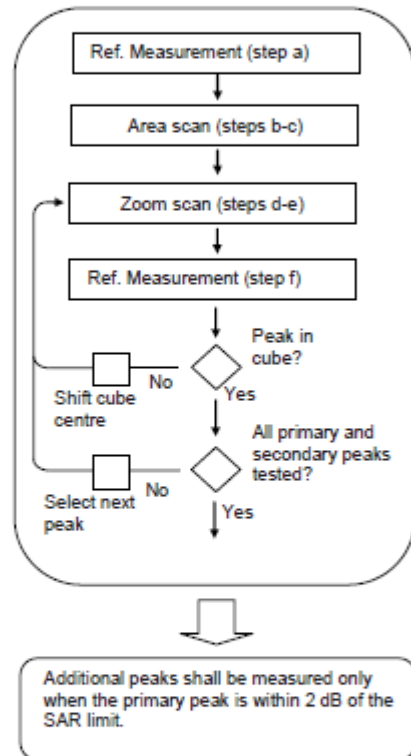

Picture b – General procedure

Additional peaks shall be measured only when the primary peak is within 2 dB of the SAR limit.

Picture 9.1 Block diagram of the tests to be performed

## 9.2 General Measurement Procedure

The area and zoom scan resolutions specified in the table below must be applied to the SAR measurements and fully documented in SAR reports to qualify for TCB approval. Probe boundary effect error compensation is required for measurements with the probe tip closer than half a probe tip diameter to the phantom surface. Both the probe tip diameter and sensor offset distance must satisfy measurement protocols; to ensure probe boundary effect errors are minimized and the higher fields closest to the phantom surface can be correctly measured and extrapolated to the phantom surface for computing 1-g SAR. Tolerances of the post-processing algorithms must be verified by the test laboratory for the scan resolutions used in the SAR measurements, according to the reference distribution functions specified in IEEE Std 1528-2003. The results should be documented as part of the system validation records and may be requested to support test results when all the measurement parameters in the following table are not satisfied.

		$\leq 3$ GHz	$> 3$ GHz	
Maximum distance from closest measurement point (geometric center of probe sensors) to phantom surface		$5 \pm 1$ mm	$\frac{1}{2} \cdot \delta \cdot \ln(2) \pm 0.5$ mm	
Maximum probe angle from probe axis to phantom surface normal at the measurement location		$30^\circ \pm 1^\circ$	$20^\circ \pm 1^\circ$	
Maximum area scan spatial resolution: $\Delta x_{Area}$ , $\Delta y_{Area}$		$\leq 2$ GHz: $\leq 15$ mm 2 – 3 GHz: $\leq 12$ mm	3 – 4 GHz: $\leq 12$ mm 4 – 6 GHz: $\leq 10$ mm	
		When the x or y dimension of the test device, in the measurement plane orientation, is smaller than the above, the measurement resolution must be $\leq$ the corresponding x or y dimension of the test device with at least one measurement point on the test device.		
Maximum zoom scan spatial resolution: $\Delta x_{Zoom}$ , $\Delta y_{Zoom}$		$\leq 2$ GHz: $\leq 8$ mm 2 – 3 GHz: $\leq 5$ mm*	3 – 4 GHz: $\leq 5$ mm* 4 – 6 GHz: $\leq 4$ mm*	
Maximum zoom scan spatial resolution, normal to phantom surface	uniform grid: $\Delta z_{Zoom}(n)$	$\leq 5$ mm	3 – 4 GHz: $\leq 4$ mm 4 – 5 GHz: $\leq 3$ mm 5 – 6 GHz: $\leq 2$ mm	
	graded grid	$\Delta z_{Zoom}(1)$ : between 1 <sup>st</sup> two points closest to phantom surface	$\leq 4$ mm	3 – 4 GHz: $\leq 3$ mm 4 – 5 GHz: $\leq 2.5$ mm 5 – 6 GHz: $\leq 2$ mm
		$\Delta z_{Zoom}(n>1)$ : between subsequent points	$\leq 1.5 \cdot \Delta z_{Zoom}(n-1)$	
Minimum zoom scan volume	x, y, z	$\geq 30$ mm	3 – 4 GHz: $\geq 28$ mm 4 – 5 GHz: $\geq 25$ mm 5 – 6 GHz: $\geq 22$ mm	
<p>Note: <math>\delta</math> is the penetration depth of a plane-wave at normal incidence to the tissue medium; see draft standard IEEE P1528-2011 for details.</p> <p>* When zoom scan is required and the <i>reported</i> SAR from the area scan based 1-g SAR estimation procedures of KDB 447498 is <math>\leq 1.4</math> W/kg, <math>\leq 8</math> mm, <math>\leq 7</math> mm and <math>\leq 5</math> mm zoom scan resolution may be applied, respectively, for 2 GHz to 3 GHz, 3 GHz to 4 GHz and 4 GHz to 6 GHz.</p>				



### 9.3 WCDMA Measurement Procedures for SAR

The following procedures are applicable to WCDMA handsets operating under 3GPP Release99, Release 5 and Release 6. The default test configuration is to measure SAR with an established radio link between the DUT and a communication test set using a 12.2kbps RMC (reference measurement channel) configured in Test Loop Mode 1. SAR is selectively confirmed for other physical channel configurations (DPCCH & DPDCH<sub>n</sub>), HSDPA and HSPA (HSUPA/HSDPA) modes according to output power, exposure conditions and device operating capabilities. Both uplink and downlink should be configured with the same RMC or AMR, when required. SAR for Release 5 HSDPA and Release 6 HSPA are measured using the applicable FRC (fixed reference channel) and E-DCH reference channel configurations. Maximum output power is verified according to applicable versions of 3GPP TS 34.121 and SAR must be measured according to these maximum output conditions. When Maximum Power Reduction (MPR) is not implemented according to Cubic Metric (CM) requirements for Release 6 HSPA, the following procedures do not apply.

#### For Release 5 HSDPA Data Devices:

Sub-test	$\beta_c$	$\beta_d$	$\beta_d$ (SF)	$\beta_c / \beta_d$	$\beta_{hs}$	CM/dB
1	2/15	15/15	64	2/15	4/15	0.0
2	12/15	15/15	64	12/15	24/25	1.0
3	15/15	8/15	64	15/8	30/15	1.5
4	15/15	4/15	64	15/4	30/15	1.5

#### For Release 6 HSPA Data Devices

Sub-test	$\beta_c$	$\beta_d$	$\beta_d$ (SF)	$\beta_c / \beta_d$	$\beta_{hs}$	$\beta_{ec}$	$\beta_{ed}$	$\beta_{ed}$ (SF)	$\beta_{ed}$ (codes)	CM (dB)	MPR (dB)	AG Index	E-TFCI
1	11/15	15/15	64	11/15	22/15	209/225	1039/225	4	1	1.5	1.5	20	75
2	6/15	15/15	64	6/15	12/15	12/15	12/15	4	1	1.5	1.5	12	67
3	15/15	9/15	64	15/9	30/15	30/15	$\beta_{ed1}:47/15$ $\beta_{ed2}:47/15$	4	2	1.5	1.5	15	92
4	2/15	15/15	64	2/15	4/15	4/15	56/75	4	1	1.5	1.5	17	71
5	15/15	15/15	64	15/15	24/15	30/15	134/15	4	1	1.5	1.5	21	81

#### Rel.8 DC-HSDPA (Cat 24)

SAR test exclusion for Rel.8 DC-HSDPA must satisfy the SAR test exclusion requirements of Rel.5 HSDPA. SAR test exclusion for DC-HSDPA devices is determined by power measurements according to the H-Set 12, Fixed Reference Channel (FRC) configuration in Table C.8.1.12 of 3GPP TS 34.121-1. A primary and a secondary serving HS-DSCH Cell are required to perform the power measurement and for the results to qualify for SAR test exclusion.

#### 9.4 SAR Measurement for LTE

SAR tests for LTE are performed with a base station simulator, Rohde & Schwarz CMW500. Closed loop power control was used so the UE transmits with maximum output power during SAR testing. All powers were measured with the CMW 500.

It is performed for conducted power and SAR based on the KDB941225 D05.

SAR is evaluated separately according to the following procedures for the different test positions in each exposure condition – head, body, body-worn accessories and other use conditions. The procedures in the following subsections are applied separately to test each LTE frequency band.

1) QPSK with 1 RB allocation

Start with the largest channel bandwidth and measure SAR for QPSK with 1 RB allocation, using the RB offset and required test channel combination with the highest maximum output power among RB offsets at the upper edge, middle and lower edge of each required test channel. When the reported SAR is  $\leq 0.8$  W/kg, testing of the remaining RB offset configurations and required test channels is not required for 1 RB allocation; otherwise, SAR is required for the remaining required test channels and only for the RB offset configuration with the highest output power for that channel. When the reported SAR of a required test channel is  $> 1.45$  W/kg, SAR is required for all three RB offset configurations for that required test channel.

2) QPSK with 50% RB allocation

The procedures required for 1 RB allocation in 1) are applied to measure the SAR for QPSK with 50% RB allocation.

3) QPSK with 100% RB allocation

For QPSK with 100% RB allocation, SAR is not required when the highest maximum output power for 100 % RB allocation is less than the highest maximum output power in 50% and 1 RB allocations and the highest reported SAR for 1 RB and 50% RB allocation in 1) and 2) are  $\leq 0.8$  W/kg. Otherwise, SAR is measured for the highest output power channel; and if the reported SAR is  $> 1.45$  W/kg, the remaining required test channels must also be tested.

#### 9.5 Bluetooth & Wi-Fi Measurement Procedures for SAR

Normal network operating configurations are not suitable for measuring the SAR of 802.11 transmitters in general. Unpredictable fluctuations in network traffic and antenna diversity conditions can introduce undesirable variations in SAR results. The SAR for these devices should be measured using chipset based test mode software to ensure that the results are consistent and reliable.

Chipset based test mode software is hardware dependent and generally varies among manufacturers. The device operating parameters established in a test mode for SAR measurements must be identical to those programmed in production units, including output power levels, amplifier gain settings and other RF performance tuning parameters. The test frequencies should correspond to actual channel frequencies defined for domestic use. SAR for devices with switched diversity should be measured with only one antenna transmitting at a time during each SAR measurement, according to a fixed modulation and data rate. The same data pattern should be used for all measurements.

## 9.6 Power Drift

To control the output power stability during the SAR test, DASY4 system calculates the power drift by measuring the E-field at the same location at the beginning and at the end of the measurement for each test position. These drift values can be found in section 14 labeled as: (Power Drift [dB]). This ensures that the power drift during one measurement is within 5%.

## 10 Area Scan Based 1-g SAR

### 10.1 Requirement of KDB

According to the KDB447498 D01 v05, when the implementation is based the specific polynomial fit algorithm as presented at the 29th Bioelectromagnetics Society meeting (2007) and the estimated 1-g SAR is  $\leq 1.2$  W/kg, a zoom scan measurement is not required provided it is also not needed for any other purpose; for example, if the peak SAR location required for simultaneous transmission SAR test exclusion can be determined accurately by the SAR system or manually to discriminate between distinctive peaks and scattered noisy SAR distributions from area scans.

There must not be any warning or alert messages due to various measurement concerns identified by the SAR system; for example, noise in measurements, peaks too close to scan boundary, peaks are too sharp, spatial resolution and uncertainty issues etc. The SAR system verification must also demonstrate that the area scan estimated 1-g SAR is within 3% of the zoom scan 1-g SAR (See Annex B). When all the SAR results for each exposure condition in a frequency band and wireless mode are based on estimated 1-g SAR, the 1-g SAR for the highest SAR configuration must be determined by a zoom scan.

### 10.2 Fast SAR Algorithms

The approach is based on the area scan measurement applying a frequency dependent attenuation parameter. This attenuation parameter was empirically determined by analyzing a large number of phones. The MOTOROLA FAST SAR was developed and validated by the MOTOROLA Research Group in Ft. Lauderdale.

In the initial study, an approximation algorithm based on Linear fit was developed. The accuracy of the algorithm has been demonstrated across a broad frequency range (136-2450 MHz) and for both 1- and 10-g averaged SAR using a sample of 264 SAR measurements from 55 wireless handsets. For the sample size studied, the root-mean-squared errors of the algorithm are 1.2% and 5.8% for 1- and 10-g averaged SAR, respectively. The paper describing the algorithm in detail is expected to be published in August 2004 within the Special Issue of Transactions on MTT.

In the second step, the same research group optimized the fitting algorithm to an Polynomial fit whereby the frequency validity was extended to cover the range 30-6000MHz. Details of this study can be found in the BEMS 2007 Proceedings.

Both algorithms are implemented in DASY software.

## 11 Conducted Output Power

### 11.1 GSM Measurement result

During the process of testing, the EUT was controlled via Agilent Digital Radio Communication tester (E5515C) to ensure the maximum power transmission and proper modulation. This result contains conducted output power for the EUT. In all cases, the measured peak output power should be greater and within 5% than EMI measurement.

**Table 11- 1 GSM850**

GSM850								
Config	Tune-up	Measured Power (dBm)			Calculation	Average Power (dBm)		
		CH251 848.8 MHz	CH190 836.6 MHz	CH128 824.2 MHz		CH251 848.8 MHz	CH190 836.6 MHz	CH128 824.2 MHz
GSM Speech	33.60	33.55	33.55	33.49				
GPRS 1 Txslot	33.60	33.46	33.47	33.43	-9.03	24.43	24.44	24.40
GPRS 2 Txslots	31.50	30.58	30.66	30.72	-6.02	24.56	24.64	24.70
GPRS 3 Txslots	30.50	29.71	29.72	30.04	-4.26	25.45	25.46	25.78
GPRS 4 Txslots	29.00	28.70	28.76	28.80	-3.01	25.69	25.75	25.79
EGPRS GMSK 1 Txslot	33.60	33.45	33.45	33.44	-9.03	24.42	24.42	24.41
EGPRS GMSK 2 Txslots	31.50	30.58	30.66	30.73	-6.02	24.56	24.64	24.71
EGPRS GMSK 3 Txslots	30.50	29.70	29.77	30.03	-4.26	25.44	25.51	25.77
EGPRS GMSK 4 Txslots	29.00	28.69	28.76	28.79	-3.01	25.68	25.75	25.78
EGPRS 8PSK 1 Txslot	29.00	28.50	28.54	28.62	-9.03	19.47	19.51	19.59
EGPRS 8PSK 2 Txslots	28.00	27.35	27.42	27.52	-6.02	21.33	21.40	21.50
EGPRS 8PSK 3 Txslots	26.50	26.28	26.33	26.38	-4.26	22.02	22.07	22.12
EGPRS 8PSK 4 Txslots	25.50	25.17	25.27	25.25	-3.01	22.16	22.26	22.24

**Table 11- 2 PCS1900**

PCS1900								
Config	Tune-up	Measured Power (dBm)			Calculation	Average Power (dBm)		
		CH810 1909.8 MHz	CH661 1880 MHz	CH512 1850.2 MHz		CH810 1909.8 MHz	CH661 1880 MHz	CH512 1850.2 MHz
GSM Speech	31.00	30.81	30.92	30.99				
GPRS 1 Txslot	31.50	30.84	30.96	31.01	-9.03	21.81	21.93	21.98
GPRS 2 Txslots	30.50	29.92	30.19	30.19	-6.02	23.90	24.17	24.17
GPRS 3 Txslots	29.50	29.07	28.95	29.00	-4.26	24.81	24.69	24.74
GPRS 4 Txslots	28.00	27.96	27.83	27.85	-3.01	24.95	24.82	24.84
EGPRS GMSK 1 Txslot	31.50	30.83	30.94	31.04	-9.03	21.80	21.91	22.01
EGPRS GMSK 2 Txslots	30.50	29.91	30.21	30.21	-6.02	23.89	24.19	24.19
EGPRS GMSK 3 Txslots	29.50	29.07	28.93	29.00	-4.26	24.81	24.67	24.74
EGPRS GMSK 4 Txslots	28.00	27.94	27.81	27.85	-3.01	24.93	24.80	24.84
EGPRS 8PSK 1 Txslot	28.00	27.86	27.83	27.83	-9.03	18.83	18.80	18.80
EGPRS 8PSK 2 Txslots	27.00	26.92	26.85	26.80	-6.02	20.90	20.83	20.78
EGPRS 8PSK 3 Txslots	26.00	25.85	25.79	25.65	-4.26	21.59	21.53	21.39
EGPRS 8PSK 4 Txslots	25.00	24.84	24.73	24.57	-3.01	21.83	21.72	21.56

**NOTES:**

**Division Factors**

To average the power, the division factor is as follows:

1TX-slot = 1 transmit time slot out of 8 time slots=> conducted power divided by (8/1) => -9.03dB

2TX-slots = 2 transmit time slots out of 8 time slots=> conducted power divided by (8/2) => -6.02dB

3TX-slots = 3 transmit time slots out of 8 time slots=> conducted power divided by (8/3) => -4.26dB

4TX-slots = 4 transmit time slots out of 8 time slots=> conducted power divided by (8/4) => -3.01dB

**According to the conducted power as above, the body measurements are performed with 4Txslots for GSM850 and PCS1900.**

## 11.2 WCDMA Measurement result

Table 11- 3 WCDMA1900-BII

WCDMA1900-BII					
Item		Tune-up	Measured Power (dBm)		
			CH9538 1907.6 MHz	CH9400 1880 MHz	CH9262 1852.4 MHz
WCDMA	RMC	24.50	24.24	23.99	24.02
HSUPA	subtest1	24.50	24.19	24.18	23.78
	subtest2	24.50	22.99	23.51	23.26
	subtest3	24.50	22.68	23.17	22.97
	subtest4	24.50	23.95	24.08	23.91
	subtest5	24.50	24.44	24.48	24.36
DC-HSDPA	subtest1	23.00	22.83	22.86	22.72
	subtest2	23.00	22.81	22.88	22.71
	subtest3	23.00	22.83	22.84	22.71
	subtest4	23.00	22.84	22.85	22.73

Table 11- 4 WCDMA1700-BIV

WCDMA1700-BIV					
Item		Tune-up	Measured Power (dBm)		
			CH1513 1752.6 MHz	CH1412 1732.4 MHz	CH1312 1712.4 MHz
WCDMA	RMC	24.50	24.03	24.01	24.11
HSUPA	subtest1	25.00	24.77	24.71	24.15
	subtest2	25.00	23.51	23.44	23.59
	subtest3	25.00	23.27	23.07	23.33
	subtest4	25.00	24.50	24.39	24.28
	subtest5	25.00	24.93	24.83	24.65
DC-HSDPA	subtest1	23.00	22.91	22.88	22.91
	subtest2	23.00	22.88	22.87	22.89
	subtest3	23.00	22.86	22.85	22.88
	subtest4	23.00	22.89	22.86	22.89

Table 11- 5 WCDMA850-BV

WCDMA850-BV					
Item		Tune-up	Measured Power (dBm)		
			CH4233 846.6 MHz	CH4715 835.4 MHz	CH4132 826.4 MHz
WCDMA	RMC	24.50	24.42	24.39	24.50
HSUPA	subtest1	24.50	24.09	24.14	23.72
	subtest2	24.50	23.43	23.47	23.41
	subtest3	24.50	23.01	23.06	23.02
	subtest4	24.50	23.89	23.84	23.89
	subtest5	24.50	24.34	24.31	24.30
DC-HSDPA	subtest1	23.00	22.86	22.87	22.86
	subtest2	23.00	22.84	22.88	22.85
	subtest3	23.00	22.85	22.87	22.84
	subtest4	23.00	22.87	22.86	22.83

11.3 LTE Measurement result

Table 11- 6 LTE1900-FDD2

LTE1900-FDD2							
SN				Measured Power (dBm) & MPR			
BandWidth	RB Number/Start	Channel/Frequency	Tune-up	QPSK		16QAM	
				Measured Power	MPR	Measured Power	MPR
1.4MHz	1H	19193	24.9	23.93	0	23.48	1
		18900	24.9	23.92	0	23.69	1
		18607	24.9	23.81	0	23.84	1
	1M	19193	24.9	24.22	0	23.46	1
		18900	24.9	24.09	0	23.75	1
		18607	24.9	24.16	0	23.45	1
	1L	19193	24.9	24.10	0	23.78	1
		18900	24.9	24.03	0	23.58	1
		18607	24.9	23.87	0	23.88	1
	3H	19193	24.9	24.29	0	22.76	1
		18900	24.9	24.00	0	23.14	1
		18607	24.9	23.94	0	23.00	1
	3M	19193	24.9	24.17	0	23.18	1
		18900	24.9	24.06	0	23.08	1
		18607	24.9	24.13	0	23.04	1
	3L	19193	24.9	24.27	0	23.20	1
		18900	24.9	24.04	0	23.10	1
		18607	24.9	24.14	0	23.33	1
6	19193	24.9	23.22	1	22.43	2	
	18900	24.9	23.07	1	22.29	2	
	18607	24.9	23.17	1	22.38	2	
3MHz	1H	19185	24.9	24.12	0	23.28	1
		18900	24.9	24.12	0	23.40	1
		18615	24.9	24.38	0	23.41	1
	1M	19185	24.9	24.15	0	23.36	1
		18900	24.9	23.96	0	23.13	1
		18615	24.9	23.98	0	23.54	1
	1L	19185	24.9	24.13	0	23.31	1
		18900	24.9	24.00	0	23.51	1
		18615	24.9	24.28	0	23.56	1
	8H	19185	24.9	23.12	1	21.91	2
		18900	24.9	23.07	1	21.90	2
		18615	24.9	23.05	1	22.28	2
	8M	19185	24.9	23.17	1	22.31	2
		18900	24.9	23.06	1	22.11	2
		18615	24.9	22.97	1	22.24	2
	8L	19185	24.9	23.25	1	22.27	2
		18900	24.9	23.18	1	22.47	2
		18615	24.9	23.00	1	22.16	2
15	19185	24.9	23.18	1	22.16	2	
	18900	24.9	23.08	1	22.06	2	
	18615	24.9	23.10	1	22.17	2	
5MHz	1H	19175	24.9	24.18	0	23.48	1
		18900	24.9	23.96	0	22.67	1
		18625	24.9	24.07	0	23.44	1
	1M	19175	24.9	24.05	0	23.53	1
		18900	24.9	24.12	0	22.52	1
		18625	24.9	23.92	0	23.35	1
	1L	19175	24.9	24.08	0	23.48	1
		18900	24.9	23.93	0	22.61	1
		18625	24.9	24.16	0	23.48	1
	12H	19175	24.9	23.20	1	22.29	2
		18900	24.9	23.11	1	21.97	2
		18625	24.9	22.99	1	22.03	2
	12M	19175	24.9	23.26	1	22.38	2
		18900	24.9	23.14	1	22.26	2
		18625	24.9	23.07	1	22.16	2
	12L	19175	24.9	23.23	1	22.35	2
		18900	24.9	23.12	1	22.25	2
		18625	24.9	23.09	1	22.22	2
25	19175	24.9	23.24	1	22.39	2	
	18900	24.9	23.07	1	22.25	2	
	18625	24.9	23.10	1	22.26	2	





10MHz	1H	19150	24.9	24.06	0	23.84	1	
		18900	24.9	24.09	0	23.54	1	
		18650	24.9	24.34	0	23.49	1	
	1M	19150	24.9	24.28	0	23.84	1	
		18900	24.9	24.14	0	23.90	1	
		18650	24.9	23.99	0	23.45	1	
	1L	19150	24.9	24.35	0	23.83	1	
		18900	24.9	24.07	0	23.49	1	
		18650	24.9	24.06	0	23.43	1	
	25H	19150	24.9	23.16	1	22.18	2	
		18900	24.9	23.09	1	22.11	2	
		18650	24.9	23.10	1	22.14	2	
	25M	19150	24.9	23.15	1	22.20	2	
		18900	24.9	23.11	1	22.17	2	
		18650	24.9	23.10	1	22.07	2	
	25L	19150	24.9	23.17	1	22.22	2	
		18900	24.9	23.11	1	22.17	2	
		18650	24.9	23.06	1	22.12	2	
	50	19150	24.9	23.16	1	22.19	2	
		18900	24.9	23.13	1	22.17	2	
		18650	24.9	23.12	1	22.16	2	
	15MHz	1H	19125	24.9	23.84	0	23.60	1
			18900	24.9	24.00	0	23.35	1
			18675	24.9	24.04	0	23.89	1
		1M	19125	24.9	24.16	0	23.55	1
			18900	24.9	23.93	0	23.54	1
			18675	24.9	24.14	0	23.78	1
1L		19125	24.9	24.12	0	23.32	1	
		18900	24.9	24.04	0	23.56	1	
		18675	24.9	23.92	0	23.88	1	
36H		19125	24.9	23.12	1	22.17	2	
		18900	24.9	23.11	1	22.13	2	
		18675	24.9	23.08	1	22.11	2	
36M		19125	24.9	23.17	1	22.19	2	
		18900	24.9	23.03	1	22.15	2	
		18675	24.9	23.02	1	22.16	2	
36L		19125	24.9	23.16	1	22.20	2	
		18900	24.9	23.17	1	22.23	2	
		18675	24.9	23.12	1	22.16	2	
75		19125	24.9	23.18	1	22.22	2	
		18900	24.9	23.15	1	22.11	2	
		18675	24.9	23.08	1	22.13	2	
20MHz		1H	19100	24.9	24.07	0	23.27	1
			18900	24.9	24.02	0	23.61	1
			18700	24.9	24.22	0	22.92	1
		1M	19100	24.9	24.49	0	23.11	1
			18900	24.9	24.01	0	23.60	1
			18700	24.9	24.25	0	23.19	1
	1L	19100	24.9	24.30	0	23.28	1	
		18900	24.9	23.93	0	23.56	1	
		18700	24.9	24.14	0	23.20	1	
	50H	19100	24.9	23.20	1	22.18	2	
		18900	24.9	23.11	1	22.14	2	
		18700	24.9	22.99	1	22.11	2	
	50M	19100	24.9	23.16	1	22.20	2	
		18900	24.9	23.06	1	22.21	2	
		18700	24.9	23.10	1	22.25	2	
	50L	19100	24.9	23.18	1	22.25	2	
		18900	24.9	23.10	1	22.13	2	
		18700	24.9	23.12	1	22.19	2	
	100	19100	24.9	23.13	1	22.21	2	
		18900	24.9	23.19	1	22.28	2	
		18700	24.9	23.13	1	22.22	2	

Table 11- 7 LTE1700-FDD4

LTE1700-FDD4								
SN	BandWidth	RB Number/Start Channel/Frequency	Tune-up	Measured Power (dBm) & MPR				
				QPSK		16QAM		
				Measured Power	MPR	Measured Power	MPR	
1.4MHz	1H	20393	24.8	24.03	0	23.77	1	
		20175	24.8	23.95	0	23.66	1	
		19957	24.8	23.91	0	23.66	1	
	1M	20393	24.8	24.24	0	23.54	1	
		20175	24.8	24.17	0	23.33	1	
		19957	24.8	24.22	0	23.43	1	
	1L	20393	24.8	24.20	0	23.31	1	
		20175	24.8	23.93	0	23.16	1	
		19957	24.8	24.00	0	23.63	1	
	3H	20393	24.8	24.23	0	23.08	1	
		20175	24.8	24.23	0	23.07	1	
		19957	24.8	24.07	0	22.96	1	
	3M	20393	24.8	24.32	0	23.21	1	
		20175	24.8	24.13	0	23.01	1	
		19957	24.8	24.21	0	23.06	1	
	3L	20393	24.8	24.16	0	23.21	1	
		20175	24.8	24.04	0	23.22	1	
		19957	24.8	24.15	0	23.14	1	
	6	20393	24.8	23.24	1	22.46	2	
		20175	24.8	22.98	1	22.30	2	
		19957	24.8	23.05	1	22.34	2	
	3MHz	1H	20385	24.8	24.27	0	23.67	1
			20175	24.8	24.13	0	23.70	1
			19965	24.8	24.10	0	23.24	1
		1M	20385	24.8	24.15	0	23.55	1
			20175	24.8	24.00	0	23.20	1
			19965	24.8	24.03	0	23.58	1
1L		20385	24.8	24.17	0	23.67	1	
		20175	24.8	24.01	0	23.32	1	
		19965	24.8	24.11	0	23.44	1	
8H		20385	24.8	23.16	1	22.20	2	
		20175	24.8	23.01	1	22.13	2	
		19965	24.8	23.04	1	22.24	2	
8M		20385	24.8	23.19	1	22.40	2	
		20175	24.8	23.02	1	22.15	2	
		19965	24.8	23.12	1	22.17	2	
8L		20385	24.8	23.15	1	22.32	2	
		20175	24.8	22.95	1	22.02	2	
		19965	24.8	23.11	1	22.27	2	
15		20385	24.8	23.19	1	22.28	2	
		20175	24.8	23.05	1	22.11	2	
		19965	24.8	23.15	1	22.14	2	
5MHz		1H	20375	24.8	24.16	0	23.60	1
			20175	24.8	23.85	0	22.42	1
			19975	24.8	24.13	0	23.37	1
		1M	20375	24.8	24.17	0	23.62	1
			20175	24.8	23.96	0	22.35	1
			19975	24.8	23.94	0	23.44	1
	1L	20375	24.8	24.28	0	23.61	1	
		20175	24.8	24.03	0	22.46	1	
		19975	24.8	23.89	0	23.55	1	
	12H	20375	24.8	23.30	1	22.32	2	
		20175	24.8	23.04	1	22.16	2	
		19975	24.8	23.07	1	22.16	2	
	12M	20375	24.8	23.35	1	22.48	2	
		20175	24.8	23.00	1	22.19	2	
		19975	24.8	23.08	1	22.20	2	
	12L	20375	24.8	23.39	1	22.43	2	
		20175	24.8	23.03	1	22.15	2	
		19975	24.8	23.10	1	22.24	2	
	25	20375	24.8	23.30	1	22.56	2	
		20175	24.8	23.11	1	22.27	2	
		19975	24.8	23.14	1	22.30	2	





10MHz	1H	20350	24.8	24.19	0	23.63	1
		20175	24.8	24.33	0	23.26	1
		20000	24.8	24.01	0	23.71	1
	1M	20350	24.8	24.63	0	23.69	1
		20175	24.8	24.07	0	23.39	1
		20000	24.8	24.27	0	23.77	1
	1L	20350	24.8	24.52	0	23.66	1
		20175	24.8	24.03	0	23.34	1
		20000	24.8	24.24	0	23.73	1
	25H	20350	24.8	23.28	1	22.49	2
		20175	24.8	23.01	1	22.04	2
		20000	24.8	23.08	1	22.11	2
	25M	20350	24.8	23.39	1	22.47	2
		20175	24.8	22.97	1	22.10	2
		20000	24.8	23.14	1	22.20	2
	25L	20350	24.8	23.33	1	22.39	2
		20175	24.8	23.13	1	22.23	2
		20000	24.8	23.15	1	22.22	2
50	20350	24.8	23.33	1	22.40	2	
	20175	24.8	23.07	1	22.10	2	
	20000	24.8	23.07	1	22.22	2	
15MHz	1H	20325	24.8	24.10	0	23.68	1
		20175	24.8	24.17	0	23.37	1
		20025	24.8	23.90	0	23.80	1
	1M	20325	24.8	24.25	0	23.48	1
		20175	24.8	23.94	0	23.46	1
		20025	24.8	24.22	0	23.80	1
	1L	20325	24.8	24.31	0	23.52	1
		20175	24.8	23.92	0	23.53	1
		20025	24.8	24.06	0	23.79	1
	36H	20325	24.8	23.27	1	22.31	2
		20175	24.8	23.08	1	22.00	2
		20025	24.8	23.08	1	22.04	2
	36M	20325	24.8	23.28	1	22.32	2
		20175	24.8	23.02	1	22.04	2
		20025	24.8	23.11	1	22.11	2
	36L	20325	24.8	23.26	1	22.30	2
		20175	24.8	23.09	1	22.11	2
		20025	24.8	23.07	1	22.09	2
75	20325	24.8	23.32	1	22.38	2	
	20175	24.8	23.12	1	22.06	2	
	20025	24.8	23.07	1	22.12	2	
20MHz	1H	20300	24.8	24.48	0	23.46	1
		20175	24.8	24.11	0	23.67	1
		20050	24.8	24.32	0	23.22	1
	1M	20300	24.8	24.48	0	23.27	1
		20175	24.8	23.93	0	23.56	1
		20050	24.8	24.72	0	23.36	1
	1L	20300	24.8	24.37	0	23.28	1
		20175	24.8	23.89	0	23.31	1
		20050	24.8	24.27	0	23.11	1
	50H	20300	24.8	23.32	1	22.36	2
		20175	24.8	23.04	1	22.07	2
		20050	24.8	23.08	1	22.14	2
	50M	20300	24.8	23.35	1	22.41	2
		20175	24.8	22.96	1	22.11	2
		20050	24.8	23.07	1	22.18	2
	50L	20300	24.8	23.34	1	22.35	2
		20175	24.8	23.03	1	22.11	2
		20050	24.8	23.12	1	22.10	2
100	20300	24.8	23.26	1	22.36	2	
	20175	24.8	23.06	1	22.15	2	
	20050	24.8	23.19	1	22.25	2	

**Table 11- 8 LTE2500-FDD7**

LTE2500-FDD7								
BandWidth	RB Number/Start	Channel/Frequency	Tune-up	Measured Power (dBm) & MPR				
				QPSK		16QAM		
				Measured Power	MPR	Measured Power	MPR	
5MHz	1H	21425	24.5	23.41	0	22.61	1	
		21100	24.5	23.38	0	22.07	1	
		20775	24.5	23.23	0	22.34	1	
	1M	21425	24.5	23.48	0	22.74	1	
		21100	24.5	23.35	0	22.08	1	
		20775	24.5	23.51	0	22.06	1	
	1L	21425	24.5	23.38	0	22.72	1	
		21100	24.5	23.51	0	22.10	1	
		20775	24.5	23.40	0	22.23	1	
	12H	21425	24.5	22.42	1	21.56	2	
		21100	24.5	22.52	1	21.62	2	
		20775	24.5	22.44	1	21.61	2	
	12M	21425	24.5	22.47	1	21.73	2	
		21100	24.5	22.56	1	21.67	2	
		20775	24.5	22.61	1	21.68	2	
	12L	21425	24.5	22.52	1	21.68	2	
		21100	24.5	22.57	1	21.68	2	
		20775	24.5	22.51	1	21.70	2	
	25	21425	24.5	22.46	1	21.77	2	
		21100	24.5	22.58	1	21.72	2	
		20775	24.5	22.53	1	21.66	2	
	10MHz	1H	21400	24.5	23.54	0	23.10	1
			21100	24.5	23.72	0	22.70	1
			20800	24.5	23.26	0	23.03	1
		1M	21400	24.5	23.77	0	23.19	1
			21100	24.5	23.72	0	22.88	1
			20800	24.5	23.65	0	23.11	1
1L		21400	24.5	23.59	0	23.20	1	
		21100	24.5	23.61	0	22.85	1	
		20800	24.5	23.41	0	23.10	1	
25H		21400	24.5	22.48	1	21.68	2	
		21100	24.5	22.56	1	21.68	2	
		20800	24.5	22.57	1	21.60	2	
25M		21400	24.5	22.57	1	21.75	2	
		21100	24.5	22.59	1	21.73	2	
		20800	24.5	22.54	1	21.57	2	
25L		21400	24.5	22.45	1	21.81	2	
		21100	24.5	22.61	1	21.65	2	
		20800	24.5	22.54	1	21.56	2	
50		21400	24.5	22.51	1	21.70	2	
		21100	24.5	22.55	1	21.59	2	
		20800	24.5	22.61	1	21.54	2	
15MHz		1H	21375	24.5	23.37	0	22.73	1
			21100	24.5	23.76	0	22.96	1
			20825	24.5	23.36	0	23.20	1
		1M	21375	24.5	23.48	0	22.80	1
			21100	24.5	23.70	0	22.86	1
			20825	24.5	23.68	0	23.24	1
	1L	21375	24.5	23.52	0	23.00	1	
		21100	24.5	23.57	0	22.94	1	
		20825	24.5	23.36	0	23.23	1	
	36H	21375	24.5	22.48	1	21.61	2	
		21100	24.5	22.65	1	21.66	2	
		20825	24.5	22.56	1	21.59	2	
	36M	21375	24.5	22.59	1	21.68	2	
		21100	24.5	22.56	1	21.58	2	
		20825	24.5	22.58	1	21.57	2	
	36L	21375	24.5	22.62	1	21.70	2	
		21100	24.5	22.61	1	21.72	2	
		20825	24.5	22.55	1	21.65	2	
	75	21375	24.5	22.51	1	21.60	2	
		21100	24.5	22.64	1	21.60	2	
		20825	24.5	22.62	1	21.57	2	



20MHz	1H	21350	24.5	23.69	0	22.53	1
		21100	24.5	23.53	0	22.89	1
		20850	24.5	23.48	0	22.41	1
	1M	21350	24.5	23.93	0	22.80	1
		21100	24.5	23.55	0	22.74	1
		20850	24.5	23.78	0	22.56	1
	1L	21350	24.5	23.71	0	22.78	1
		21100	24.5	23.23	0	22.88	1
		20850	24.5	23.52	0	22.61	1
	50H	21350	24.5	22.42	1	21.67	2
		21100	24.5	22.64	1	21.77	2
		20850	24.5	22.55	1	21.69	2
	50M	21350	24.5	22.66	1	21.68	2
		21100	24.5	22.52	1	21.67	2
		20850	24.5	22.58	1	21.65	2
	50L	21350	24.5	22.59	1	21.69	2
		21100	24.5	22.64	1	21.71	2
		20850	24.5	22.59	1	21.67	2
	100	21350	24.5	22.60	1	21.71	2
		21100	24.5	22.62	1	21.62	2
		20850	24.5	22.54	1	21.63	2

**Table 11- 9 LTE2500-FDD12**

LTE700-FDD12								
BandWidth	RB Number/Start	Channel/Frequency	Tune-up	Measured Power (dBm) & MPR				
				QPSK		16QAM		
				Measured Power	MPR	Measured Power	MPR	
1.4MHz	1H	23173	25	23.63	0	22.79	1	
		23095	25	23.63	0	23.54	1	
		23017	25	23.51	0	22.89	1	
	1M	23173	25	23.84	0	23.04	1	
		23095	25	23.86	0	23.48	1	
		23017	25	23.61	0	23.35	1	
	1L	23173	25	23.70	0	22.88	1	
		23095	25	23.86	0	23.31	1	
		23017	25	23.52	0	23.07	1	
	3H	23173	25	23.83	0	22.99	1	
		23095	25	23.89	0	22.82	1	
		23017	25	23.56	0	22.60	1	
	3M	23173	25	23.85	0	22.40	1	
		23095	25	23.93	0	22.92	1	
		23017	25	23.55	0	22.54	1	
	3L	23173	25	23.76	0	22.76	1	
		23095	25	23.84	0	22.85	1	
		23017	25	23.63	0	22.63	1	
	6	23173	25	22.77	1	21.96	2	
		23095	25	22.80	1	22.11	2	
		23017	25	22.63	1	21.82	2	
	3MHz	1H	23165	25	23.68	0	22.92	1
			23095	25	23.77	0	23.15	1
			23025	25	23.61	0	23.22	1
1M		23165	25	23.68	0	23.06	1	
		23095	25	23.69	0	23.02	1	
		23025	25	23.73	0	23.28	1	
1L		23165	25	23.85	0	23.29	1	
		23095	25	23.67	0	23.09	1	
		23025	25	23.59	0	23.22	1	
8H		23165	25	22.72	1	21.47	2	
		23095	25	22.91	1	21.78	2	
		23025	25	22.69	1	21.67	2	
8M		23165	25	22.77	1	21.50	2	
		23095	25	22.82	1	21.95	2	
		23025	25	22.71	1	21.84	2	
8L		23165	25	22.81	1	21.81	2	
		23095	25	22.72	1	21.84	2	
		23025	25	22.60	1	21.70	2	
15		23165	25	22.83	1	21.80	2	
		23095	25	22.95	1	21.91	2	
		23025	25	22.81	1	21.57	2	
5MHz		1H	23155	25	23.40	0	23.05	1
			23095	25	23.85	0	22.41	1
			23035	25	23.58	0	23.05	1
	1M	23155	25	23.51	0	23.06	1	
		23095	25	23.82	0	22.08	1	
		23035	25	23.79	0	23.12	1	
	1L	23155	25	23.67	0	22.96	1	
		23095	25	23.65	0	22.22	1	
		23035	25	23.46	0	22.90	1	
	12H	23155	25	22.77	1	21.87	2	
		23095	25	22.84	1	21.74	2	
		23035	25	22.73	1	21.81	2	
	12M	23155	25	22.77	1	21.79	2	
		23095	25	22.90	1	22.02	2	
		23035	25	22.75	1	21.86	2	
	12L	23155	25	22.86	1	21.78	2	
		23095	25	22.88	1	22.00	2	
		23035	25	22.74	1	21.85	2	
	25	23155	25	22.78	1	21.92	2	
		23095	25	22.83	1	21.88	2	
		23035	25	22.69	1	21.74	2	



10MHz	1H	23130	25	23.79	0	23.24	1
		23095	25	23.85	0	23.03	1
		23060	25	23.68	0	23.22	1
	1M	23130	25	23.95	0	23.41	1
		23095	25	23.93	0	23.65	1
		23060	25	23.86	0	23.06	1
	1L	23130	25	23.67	0	23.33	1
		23095	25	23.78	0	22.93	1
		23060	25	23.47	0	22.75	1
	25H	23130	25	22.80	1	21.73	2
		23095	25	22.80	1	21.83	2
		23060	25	22.74	1	21.77	2
	25M	23130	25	22.89	1	21.93	2
		23095	25	22.87	1	21.82	2
		23060	25	22.84	1	21.81	2
	25L	23130	25	22.92	1	21.87	2
		23095	25	22.79	1	21.75	2
		23060	25	22.71	1	21.65	2
	50	23130	25	22.91	1	21.94	2
		23095	25	22.85	1	21.87	2
		23060	25	22.69	1	21.72	2

**Table 11- 10 LTE2600-TDD38**

LTE2600-TDD38								
BandWidth	RB Number/Start	Channel/Frequency	Tune-up	Measured Power (dBm) & MPR				
				QPSK		16QAM		
				Measured Power	MPR	Measured Power	MPR	
5MHz	1H	38225	24.5	23.28	0	22.90	1	
		38000	24.5	23.26	0	22.52	1	
		37775	24.5	23.41	0	22.57	1	
	1M	38225	24.5	23.41	0	22.83	1	
		38000	24.5	23.45	0	22.73	1	
		37775	24.5	23.49	0	22.76	1	
	1L	38225	24.5	23.34	0	22.87	1	
		38000	24.5	23.43	0	22.79	1	
		37775	24.5	23.45	0	22.73	1	
	12H	38225	24.5	22.63	1	21.59	2	
		38000	24.5	22.43	1	21.46	2	
		37775	24.5	22.37	1	21.55	2	
	12M	38225	24.5	22.52	1	21.63	2	
		38000	24.5	22.49	1	21.54	2	
		37775	24.5	22.50	1	21.71	2	
	12L	38225	24.5	22.49	1	21.60	2	
		38000	24.5	22.45	1	21.55	2	
		37775	24.5	22.56	1	21.72	2	
	25	38225	24.5	22.45	1	21.62	2	
		38000	24.5	22.51	1	21.63	2	
		37775	24.5	22.49	1	21.59	2	
	10MHz	1H	38200	24.5	23.49	0	22.74	1
			38000	24.5	23.45	0	22.61	1
			37800	24.5	23.40	0	22.75	1
		1M	38200	24.5	23.69	0	22.69	1
			38000	24.5	23.50	0	22.88	1
			37800	24.5	23.53	0	22.55	1
1L		38200	24.5	23.36	0	22.67	1	
		38000	24.5	23.37	0	22.76	1	
		37800	24.5	23.48	0	22.75	1	
25H		38200	24.5	21.52	1	21.61	2	
		38000	24.5	21.53	1	21.62	2	
		37800	24.5	21.58	1	21.62	2	
25M		38200	24.5	21.60	1	21.60	2	
		38000	24.5	21.61	1	21.61	2	
		37800	24.5	21.61	1	21.61	2	
25L		38200	24.5	22.49	1	21.60	2	
		38000	24.5	22.51	1	21.77	2	
		37800	24.5	22.50	1	21.64	2	
50		38200	24.5	21.59	1	21.70	2	
		38000	24.5	21.59	1	21.59	2	
		37800	24.5	21.68	1	21.70	2	
15MHz		1H	38175	24.5	23.44	0	22.71	1
			38000	24.5	23.24	0	22.72	1
			37825	24.5	23.35	0	22.74	1
		1M	38175	24.5	23.37	0	22.57	1
			38000	24.5	23.48	0	22.58	1
			37825	24.5	23.39	0	22.69	1
	1L	38175	24.5	23.43	0	22.60	1	
		38000	24.5	23.52	0	22.60	1	
		37825	24.5	23.36	0	22.62	1	
	36H	38175	24.5	22.51	1	21.55	2	
		38000	24.5	21.50	1	21.59	2	
		37825	24.5	21.61	1	21.59	2	
	36M	38175	24.5	22.60	1	21.66	2	
		38000	24.5	21.59	1	21.58	2	
		37825	24.5	21.59	1	21.58	2	
	36L	38175	24.5	22.55	1	21.59	2	
		38000	24.5	21.58	1	21.63	2	
		37825	24.5	21.58	1	21.67	2	
	75	38175	24.5	22.59	1	21.67	2	
		38000	24.5	21.76	1	21.76	2	
		37825	24.5	21.57	1	21.57	2	

20MHz	1H	38150	24.5	23.57	0	22.64	1
		38000	24.5	23.50	0	22.74	1
		37850	24.5	23.52	0	22.74	1
	1M	38150	24.5	23.74	0	22.88	1
		38000	24.5	23.40	0	22.80	1
		37850	24.5	23.42	0	22.65	1
	1L	38150	24.5	23.62	0	22.90	1
		38000	24.5	23.45	0	22.32	1
		37850	24.5	23.38	0	22.33	1
	50H	38150	24.5	22.50	1	21.24	2
		38000	24.5	22.49	1	21.31	2
		37850	24.5	22.36	1	21.50	2
	50M	38150	24.5	22.44	1	21.36	2
		38000	24.5	22.47	1	21.39	2
		37850	24.5	22.46	1	21.49	2
	50L	38150	24.5	22.51	1	21.32	2
		38000	24.5	22.44	1	21.34	2
		37850	24.5	22.53	1	21.56	2
	100	38150	24.5	22.41	1	21.46	2
		38000	24.5	22.44	1	21.48	2
		37850	24.5	22.43	1	21.22	2

### 11.4 Wi-Fi and BT Measurement result

The output power of BT antenna is as following:

**Table 11- 11 Bluetooth**

Bluetooth Power				
Mode	Channel	Frequency	Tune-up	Measured
GFSK	78	2480 MHz	9.5	7.62
	39	2441 MHz	9.5	9.13
	0	2402 MHz	9.5	8

The average conducted power for Wi-Fi is as following:

**Table 11- 12 WLAN 2450 802.11b**

Channel\data rate	1Mbps	Tune up
1	15.94	16
6	15.79	16
11	15.76	16

**Table 11- 13 WLAN 2450 802.11g**

Channel\data rate	6Mbps	Tune up
1	12.41	12.5
6	12.31	12.5
11	12.28	12.5

**Table 11- 14 WLAN 2450 802.11n - HT20**

Channel\data rate	MCS0	Tune up
1	11.37	12.00
6	11.36	12.00
11	11.28	12.00

**Table 11- 15 WLAN 5G 11a**

Channel\data rate	6Mbps	Tune up
36(5180 MHz)	13.13	13.50
40(5200 MHz)	13.20	13.50
44(5220 MHz)	12.99	13.00
48(5240 MHz)	12.87	13.00
52(5260 MHz)	12.56	12.60
56(5280 MHz)	12.12	12.60
60(5300 MHz)	11.92	12.60
64(5320 MHz)	11.75	12.60
100(5500 MHz)	12.72	12.90
104(5520 MHz)	12.85	12.90
108(5540 MHz)	12.90	12.90
112(5560 MHz)	12.82	12.90
116(5580 MHz)	12.57	12.90
120(5600 MHz)	12.34	12.90
124(5620 MHz)	12.20	12.90
128(5640 MHz)	12.01	12.90
132(5660 MHz)	11.74	11.80
136(5680 MHz)	11.57	11.80
140(5700 MHz)	11.66	11.80
149(5745 MHz)	11.52	11.80
153(5765 MHz)	11.46	11.80
157(5785 MHz)	11.74	11.80
161(5805 MHz)	11.71	11.80
165(5825 MHz)	11.89	12.00

**Table 11- 16 WLAN 5G 11n – HT20**

Channel\data rate	MCS0	Tune up
36(5180 MHz)	12.07	12.50
40(5200 MHz)	11.95	12.00
44(5220 MHz)	11.94	12.00
48(5240 MHz)	11.76	12.00
52(5260 MHz)	11.51	12.00
56(5280 MHz)	11.05	12.00
60(5300 MHz)	10.86	11.00
64(5320 MHz)	10.70	11.00
100(5500 MHz)	11.54	12.00
104(5520 MHz)	11.67	12.00
108(5540 MHz)	11.71	12.00
112(5560 MHz)	11.62	12.00
116(5580 MHz)	11.48	12.00
120(5600 MHz)	11.47	12.00



124(5620 MHz)	11.28	12.00
128(5640 MHz)	11.14	12.00
132(5660 MHz)	10.87	11.00
136(5680 MHz)	10.70	11.00
140(5700 MHz)	10.53	11.00
149(5745 MHz)	10.30	11.00
153(5765 MHz)	10.43	11.00
157(5785 MHz)	10.46	11.00
161(5805 MHz)	10.44	11.00
165(5825 MHz)	10.59	11.00

**Table 11- 17 WLAN 5G 11n – HT40**

Channel\data rate	MCS0	Tune up
38(5190 MHz)	11.44	12.00
46(5230 MHz)	11.22	12.00
54(5270 MHz)	10.65	11.00
62(5310 MHz)	10.37	11.00
102(5510 MHz)	11.21	12.00
110(5550 MHz)	11.28	12.00
118(5590 MHz)	10.99	11.00
126(5630 MHz)	10.79	11.00
134(5670 MHz)	10.28	11.00
151(5755 MHz)	10.01	11.00
159(5795 MHz)	10.12	11.00

## 12 Simultaneous TX SAR Considerations

### 12.1 Introduction

The following procedures adopted from “FCC SAR Considerations for Cell Phones with Multiple Transmitters” are applicable to handsets with built-in unlicensed transmitters such as 802.11 a/b/g and Bluetooth devices which may simultaneously transmit with the licensed transmitter. For this device, the BT and Wi-Fi can transmit simultaneous with other transmitters.

### 12.2 Transmit Antenna Separation Distances

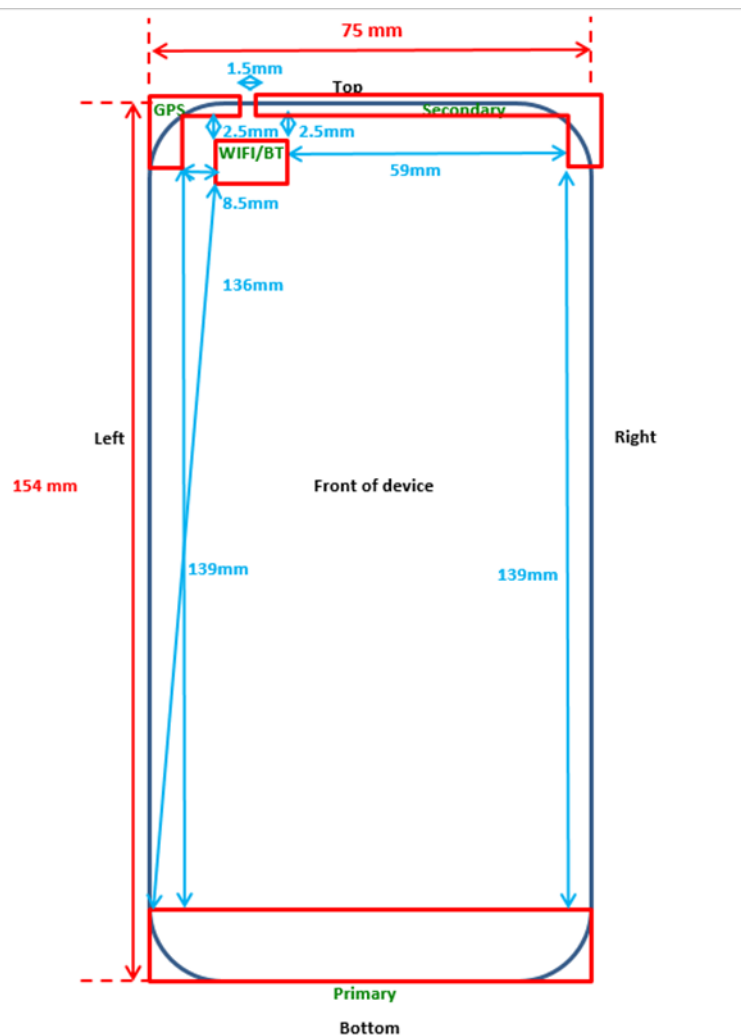

Picture 12.1 Antenna Locations

### 12.3 SAR Measurement Positions

According to the KDB941225 D06 Hot Spot SAR v01, the edges with less than 2.5 cm distance to the antennas need to be tested for SAR.

SAR measurement positions						
Mode	Front	Rear	Left edge	Right edge	Top edge	Bottom edge
Main antenna	Yes	Yes	Yes	Yes	No	Yes
WLAN	Yes	Yes	Yes	No	Yes	No

### 12.4 Standalone SAR Test Exclusion Considerations

Standalone 1-g head or body SAR evaluation by measurement or numerical simulation is not required when the corresponding SAR Exclusion Threshold condition, listed below, is satisfied. The 1-g SAR test exclusion threshold for 100 MHz to 6 GHz at test separation distances  $\leq 50$  mm are determined by:

$[(\text{max. power of channel, including tune-up tolerance, mW}) / (\text{min. test separation distance, mm})] \cdot [\sqrt{f(\text{GHz})}] \leq 3.0$  for 1-g SAR, where

- $f(\text{GHz})$  is the RF channel transmit frequency in GHz
- Power and distance are rounded to the nearest mW and mm before calculation
- The result is rounded to one decimal place for comparison

**Table 12.1: Standalone SAR test exclusion considerations**

Band/Mode	F(GHz)	Position	SAR test exclusion threshold (mW)	RF output power		SAR test exclusion
				dBm	mW	
Bluetooth	2.441	Head	9.6	9.5	8.91	Yes
		Body	9.6	9.5	8.91	Yes
2.4GHz WLAN	2.45	Head	9.58	16	39.81	No
		Body	9.58	16	39.81	No
5GHz WLAN	5.25	Head	6.58	13.5	22.39	No
		Body	13.16	13.5	22.39	No
	5.6	Head	6.34	12.9	19.50	No
		Body	12.68	12.9	19.50	No
	5.75	Head	6.23	12	15.85	No
		Body	12.46	12	15.85	No

### 13 Evaluation of Simultaneous

**Table 13.1: The sum of reported SAR values for main antenna and WiFi**

	Position	Main antenna	WiFi	Sum
<b>Highest reported SAR value for Head</b>	Right hand, Touch cheek	0.34	1.22(DTS)	<b>1.56</b>
			1.24(NII)	<b>1.58</b>
<b>Highest reported SAR value for Body</b>	Left edge	0.62	0.03(DTS)	<b>0.65</b>
			0.02(NII)	<b>0.64</b>

Note1: we have evaluated and chose the highest value of both main antennae in the above table

**Table 13.2: The sum of reported SAR values for main antenna and BT**

	Position	Main antenna	BT	Sum
<b>Maximum reported SAR value for Head</b>	Left hand, Touch cheek	0.53	0.19	<b>0.72</b>
<b>Maximum reported SAR value for Body</b>	Left edge	0.62	0.09	<b>0.71</b>

[1] - Estimated SAR for Bluetooth (see the table 13.3)

**Table 13.3: Estimated SAR for Bluetooth**

Mode/Band	F (GHz)	Position	Distance (mm)	Upper limit of power *		Estimated <sub>1g</sub> (W/kg)
				dBm	mW	
Bluetooth	2.441	Head	5	9.5	8.91	0.19
Bluetooth	2.441	Body	10	9.5	8.91	0.09

\* - Maximum possible output power declared by manufacturer

When standalone SAR test exclusion applies to an antenna that transmits simultaneously with other antennas, the standalone SAR must be estimated according to following to determine simultaneous transmission SAR test exclusion:

(max. power of channel, including tune-up tolerance, mW)/(min. test separation distance, mm)]·[√f(GHz)/x] W/kg for test separation distances ≤ 50 mm;

where x = 7.5 for 1-g SAR.

When the minimum test separation distance is < 5 mm, a distance of 5 mm is applied to determine SAR test exclusion

#### Conclusion:

According to the above tables, the sum of reported SAR values is < 1.6W/kg. So the simultaneous transmission SAR with volume scans is not required.

## 14 SAR Test Result

It is determined by user manual for the distance between the EUT and the phantom bottom.

The distance is 10 mm and just applied to the condition of body worn accessory.

It is performed for all SAR measurements with area scan based 1-g SAR estimation (Fast SAR). A zoom scan measurement is added when the estimated 1-g SAR is the highest measured SAR in each exposure configuration, wireless mode and frequency band combination or more than 1.2W/kg.

The calculated SAR is obtained by the following formula:

$$\text{Reported SAR} = \text{Measured SAR} \times 10^{(P_{\text{Target}} - P_{\text{Measured}})/10}$$

Where  $P_{\text{Target}}$  is the power of manufacturing upper limit;

$P_{\text{Measured}}$  is the measured power in chapter 11.

Mode	Duty Cycle
Speech for GSM850/1900	1:8.3
GPRS&EGPRS for GSM850/1900	1:2
WCDMA&LTE FDD	1:1
LTE TDD	1:1.58

### 14.1 Evaluation of multi-batteries and SIM slots

We'll perform the head measurement in all bands with the primary battery and SIM slot depending on the evaluation of multi-batteries and SIM slots retest on highest value point with other batteries and SIM slots. Then, repeat the measurement in the Body test.

Note:

The battery of HE316 is B1.

The battery of HE317 is B2.

The SIM1 is S1.

The SIM2 is S2.

The headset of CAB5422B-N01-DG is H1.

frequency		Mode/Band	Side	Position	BatteryType	1g SAR (W/kg)	PowerDrift
MHz	Channel						
2560	21350	LTE Band7	Left	Cheek	HE316	0.357	0.04
2560	21350	LTE Band7	Left	Cheek	HE317	0.368	0.06

Note: According to the values in the above table, the battery, HE317, is the primary battery. We'll perform the head measurement with this battery and retest on highest value point with others.

frequency		Mode/Band	Position	BatteryType	1g SAR (W/kg)	PowerDrift
MHz	Channel					
2560	21350	LTE Band7	Rear	HE316	0.329	-0.08
2560	21350	LTE Band7	Rear	HE317	0.382	-0.04

Note: According to the values in the above table, the battery, HE317, is the primary battery. We'll perform the Body measurement with this battery and retest on highest value point with others.

frequency		Mode/Band	Side	Position	SIM Card	1g SAR (W/kg)	PowerDrift
MHz	Channel						
2560	21350	LTE Band7	Left	Cheek	SIM1	0.368	0.06
2560	21350	LTE Band7	Left	Cheek	SIM2	0.361	0.01

Note: According to the values in the above table, the slot, S1, is the primary slot. We'll perform the head measurement with this slot and retest on highest value point with others.

frequency		Mode/Band	Position	SIM Card	1g SAR (W/kg)	PowerDrift
MHz	Channel					
2560	21350	LTE Band7	Rear	SIM1	0.382	-0.04
2560	21350	LTE Band7	Rear	SIM2	0.338	0.12

Note: According to the values in the above table, the slot, S1, is the primary slot. We'll perform the body measurement with this slot and retest on highest value point with others.

## 14.2 SAR results

**Table 14-1 GSM850 Head**

GSM850 Head									
Ambient Temperature:			22.5			Liquid Temperature:			23.3
Mode	Device orientation	SAR measurement	Measured SAR [W/kg]			Reported SAR [W/kg]			
			CH251 848.8 MHz	CH190 836.6 MHz	CH128 824.2 MHz	CH251 848.8 MHz	CH190 836.6 MHz	CH128 824.2 MHz	
GSM	Tune-up		33.60	33.60	33.60	Scaling factor*			
	Slot Average Power [dBm]		33.55	33.55	33.49	1.01	1.01	1.03	
	Left Cheek	1g SAR		0.102			0.10		
		10g SAR		0.081			0.08		
		Deviation		0.01			0.01		
	Left Tilt	1g SAR		0.066			0.07		
		10g SAR		0.053			0.05		
		Deviation		0.03			0.03		
	Right Cheek	1g SAR	0.143	0.163	0.178	0.14	0.16	0.18	
		10g SAR	0.109	0.123	0.138	0.11	0.12	0.14	
		Deviation	0.03	0.05	-0.06	0.03	0.05	-0.06	
	Right Tilt	1g SAR		0.065			0.07		
10g SAR			0.051			0.05			
Deviation			-0.09			-0.09			
GSM B1	Right Cheek	1g SAR			0.17			0.17	
		10g SAR			0.13			0.13	
		Deviation			0.12			0.12	
SIM 2	Right Cheek	1g SAR			0.162			0.17	
		10g SAR			0.121			0.12	
		Deviation			0.04			0.04	

**Table 14-2 GSM850 Body**

GSM850 Body									
Ambient Temperature:			22.5			Liquid Temperature:			23.3
Mode	Device orientation	SAR measurement	Measured SAR [W/kg]			Reported SAR [W/kg]			
			CH251 848.8 MHz	CH190 836.6 MHz	CH128 824.2 MHz	CH251 848.8 MHz	CH190 836.6 MHz	CH128 824.2 MHz	
GPRS 4 Txslots	Tune-up		29.00	29.00	29.00	Scaling factor*			
	Slot Average Power [dBm]		28.70	28.76	28.80	1.07	1.06	1.05	
	Front	1g SAR		0.187			0.20		
		10g SAR		0.118			0.12		
		Deviation		-0.09			-0.09		
	Rear	1g SAR		0.141			0.15		
		10g SAR		0.112			0.12		
		Deviation		-0.16			-0.16		
	Bottom edge	1g SAR		0.158			0.17		
		10g SAR		0.0842			0.09		
		Deviation		0.11			0.11		
	Left edge	1g SAR		0.131			0.14		
		10g SAR		0.0904			0.10		
		Deviation		0.16			0.16		
	Right edge	1g SAR	0.121	0.236	0.305	0.13	0.25	0.32	
		10g SAR	0.139	0.167	0.209	0.15	0.18	0.22	
		Deviation	0.1	0.14	0.08	0.10	0.14	0.08	
	EGPRS GMSK 4 Txslots	Tune-up		29.00	29.00	29.00	Scaling factor*		
Slot Average Power [dBm]		28.69	28.76	28.79	1.07	1.06	1.05		
Right edge		1g SAR			0.265			0.28	
		10g SAR			0.175			0.18	
	Deviation			0.08			0.08		
GSM B1	Right edge	1g SAR			0.299			0.31	
		10g SAR			0.202			0.21	
		Deviation			0.1			0.10	
SIM 2	Right edge	1g SAR			0.288			0.30	
		10g SAR			0.193			0.20	
		Deviation			-0.09			-0.09	

**Table 14-3 PCS1900 Head**

PCS1900 Head									
Ambient Temperature:			22.5			Liquid Temperature:			23.3
Mode	Device orientation	SAR measurement	Measured SAR [W/kg]			Reported SAR [W/kg]			
			CH810 1909.8 MHz	CH661 1880 MHz	CH512 1850.2 MHz	CH810 1909.8 MHz	CH661 1880 MHz	CH512 1850.2 MHz	
GSM	Tune-up		31.00	31.00	31.00	Scaling factor*			
	Slot Average Power [dBm]		30.81	30.92	30.99	1.05	1.02	1.00	
	Left Cheek	1g SAR	0.176	0.19	0.184	0.18	0.19	0.18	
		10g SAR	0.112	0.122	0.118	0.12	0.12	0.12	
		Deviation	0.11	-0.02	0.09	0.11	-0.02	0.09	
	Left Tilt	1g SAR		0.046			0.05		
		10g SAR		0.031			0.03		
		Deviation		0.14			0.14		
	Right Cheek	1g SAR		0.089			0.09		
		10g SAR		0.061			0.06		
		Deviation		-0.08			-0.08		
	Right Tilt	1g SAR		0.052			0.05		
10g SAR			0.043			0.04			
Deviation			0.1			0.10			
GSM B1	Left Cheek	1g SAR		0.181			0.18		
		10g SAR		0.119			0.12		
		Deviation		0.06			0.06		
SIM 2	Left Cheek	1g SAR		0.179			0.18		
		10g SAR		0.115			0.12		
		Deviation		0.12			0.12		

**Table 14-4 PCS1900 Body**

PCS1900 Body									
Ambient Temperature:			22.5			Liquid Temperature:			23.3
Mode	Device orientation	SAR measurement	Measured SAR [W/kg]			Reported SAR [W/kg]			
			CH810 1909.8 MHz	CH661 1880 MHz	CH512 1850.2 MHz	CH810 1909.8 MHz	CH661 1880 MHz	CH512 1850.2 MHz	
GPRS 4 Txslots	Tune-up		28.00	28.00	28.00	Scaling factor*			
	Slot Average Power [dBm]		27.96	27.83	27.85	1.01	1.04	1.03	
	Front	1g SAR		0.402			0.42		
		10g SAR		0.238			0.25		
		Deviation		0.01			0.01		
	Rear	1g SAR		0.522			0.54		
		10g SAR		0.307			0.32		
		Deviation		0.14			0.14		
	Bottom edge	1g SAR		0.513			0.53		
		10g SAR		0.271			0.28		
		Deviation		0.12			0.12		
	Left edge	1g SAR	0.496	0.53	0.558	0.50	0.55	0.58	
10g SAR		0.286	0.302	0.338	0.29	0.31	0.35		
Deviation		-0.03	0.07	-0.12	-0.03	0.07	-0.12		
Right edge	1g SAR		0.0495			0.05			
	10g SAR		0.0271			0.03			
	Deviation		0.13			0.13			
EGPRS GMSK 4 Txslots	Tune-up		28.00	28.00	28.00	Scaling factor*			
	Slot Average Power [dBm]		27.94	27.81	27.85	1.01	1.05	1.04	
	Left edge	1g SAR			0.527			0.55	
		10g SAR			0.291			0.30	
Deviation				-0.11			-0.11		
GSM B1	Left edge	1g SAR		0.521			0.54		
		10g SAR		0.282			0.29		
		Deviation		-0.04			-0.04		
SIM 2	Left edge	1g SAR		0.522			0.54		
		10g SAR		0.284			0.29		
		Deviation		-0.06			-0.06		



**Table 14-5 WCDMA1900-BII Head**

WCDMA1900-BII Head									
Ambient Temperature:			22.5			Liquid Temperature:			23.3
Mode	Device orientation	SAR measurement	Measured SAR [W/kg]			Reported SAR [W/kg]			
			CH9538 1907.6 MHz	CH9400 1880 MHz	CH9262 1852.4 MHz	CH9538 1907.6 MHz	CH9400 1880 MHz	CH9262 1852.4 MHz	
RMC	Tune-up		24.50	24.50	24.50	Scaling factor*			
	Slot Average Power [dBm]		24.24	23.99	24.02	1.06	1.12	1.12	
	Left Cheek	1g SAR	0.499	0.466	0.47	0.53	0.52	0.52	
		10g SAR	0.315	0.264	0.269	0.33	0.30	0.30	
		Deviation	0.06	0.11	0.04	0.06	0.11	0.04	
	Left Tilt	1g SAR		0.164			0.18		
		10g SAR		0.1			0.11		
		Deviation		-0.1			-0.10		
	Right Cheek	1g SAR		0.304			0.34		
		10g SAR		0.239			0.27		
		Deviation		0.09			0.09		
	Right Tilt	1g SAR		0.145			0.16		
		10g SAR		0.092			0.10		
		Deviation		0.16			0.16		
	RMC B1	Left Cheek	1g SAR	0.472			0.50		
10g SAR			0.273			0.29			
Deviation			-0.08			-0.08			
SIM 2	Left Cheek	1g SAR	0.466			0.50			
		10g SAR	0.265			0.28			
		Deviation	-0.12			-0.12			

**Table 14-6 WCDMA1900-BII Body**

WCDMA1900-BII Body									
Ambient Temperature:			22.5			Liquid Temperature:			23.3
Mode	Device orientation	SAR measurement	Measured SAR [W/kg]			Reported SAR [W/kg]			
			CH9538 1907.6 MHz	CH9400 1880 MHz	CH9262 1852.4 MHz	CH9538 1907.6 MHz	CH9400 1880 MHz	CH9262 1852.4 MHz	
RMC	Tune-up		24.50	24.50	24.50	Scaling factor*			
	Slot Average Power [dBm]		24.24	23.99	24.02	1.06	1.12	1.12	
	Front	1g SAR		0.526			0.59		
		10g SAR		0.291			0.33		
		Deviation		0.01			0.01		
	Rear	1g SAR		0.464			0.52		
		10g SAR		0.245			0.28		
		Deviation		-0.06			-0.06		
	Bottom edge	1g SAR		0.465			0.52		
		10g SAR		0.231			0.26		
		Deviation		0.17			0.17		
	Left edge	1g SAR	0.416	0.549	0.502	0.44	0.62	0.56	
		10g SAR	0.136	0.332	0.275	0.14	0.37	0.31	
		Deviation	0.04	-0.16	0.18	0.04	-0.16	0.18	
	Right edge	1g SAR		0.0674			0.08		
		10g SAR		0.0366			0.04		
		Deviation		0.09			0.09		
	RMC B1	Left edge	1g SAR		0.526			0.59	
			10g SAR		0.291			0.33	
			Deviation		0.09			0.09	
	SIM 2	Left edge	1g SAR		0.515			0.58	
10g SAR				0.285			0.32		
Deviation				-0.01			-0.01		

**Table 14-7 WCDMA1700-BIV Head**

WCDMA1700-BIV Head								
Ambient Temperature: 22.5			Liquid Temperature: 23.3					
Mode	Device orientation	SAR measurement	Measured SAR [W/kg]			Reported SAR [W/kg]		
			CH1513 1752.6 MHz	CH1412 1732.4 MHz	CH1312 1712.4 MHz	CH1513 1752.6 MHz	CH1412 1732.4 MHz	CH1312 1712.4 MHz
RMC	Tune-up		24.50	24.50	24.50	Scaling factor*		
	Slot Average Power [dBm]		24.03	24.01	24.11	1.11	1.12	1.10
	Left Cheek	1g SAR	0.268	0.208	0.202	0.30	0.23	0.22
		10g SAR	0.178	0.137	0.136	0.20	0.15	0.15
		Deviation	0.18	0.02	0.11	0.18	0.02	0.11
	Left Tilt	1g SAR		0.195			0.22	
		10g SAR		0.144			0.16	
		Deviation		-0.09			-0.09	
	Right Cheek	1g SAR		0.201			0.23	
		10g SAR		0.152			0.17	
		Deviation		0.12			0.12	
	Right Tilt	1g SAR		0.101			0.11	
		10g SAR		0.07			0.08	
		Deviation		0.06			0.06	
	RMC B1	Left Cheek	1g SAR	0.247			0.28	
10g SAR			0.169			0.19		
Deviation			0.05			0.05		
SIM 2	Left Cheek	1g SAR	0.261			0.29		
		10g SAR	0.171			0.19		
		Deviation	0.1			0.10		

**Table 14-8 WCDMA1700-BIV Body**

WCDMA1700-BIV Body									
Ambient Temperature: 22.5			Liquid Temperature: 23.3						
Mode	Device orientation	SAR measurement	Measured SAR [W/kg]			Reported SAR [W/kg]			
			CH1513 1752.6 MHz	CH1412 1732.4 MHz	CH1312 1712.4 MHz	CH1513 1752.6 MHz	CH1412 1732.4 MHz	CH1312 1712.4 MHz	
RMC	Tune-up		24.50	24.50	24.50	Scaling factor*			
	Slot Average Power [dBm]		24.03	24.01	24.11	1.11	1.12	1.10	
	Front	1g SAR		0.253			0.28		
		10g SAR		0.15			0.17		
		Deviation		0.11			0.11		
	Rear	1g SAR		0.235			0.26		
		10g SAR		0.136			0.15		
		Deviation		-0.09			-0.09		
	Bottom edge	1g SAR	0.375	0.296	0.258	0.42	0.33	0.28	
		10g SAR	0.2	0.155	0.133	0.22	0.17	0.15	
		Deviation	-0.18	0.02	-0.05	-0.18	0.02	-0.05	
	Left edge	1g SAR		0.203			0.23		
		10g SAR		0.104			0.12		
		Deviation		-0.11			-0.11		
	Right edge	1g SAR		0.054			0.06		
		10g SAR		0.03			0.03		
		Deviation		-0.11			-0.11		
	RMC B1	Bottom edge	1g SAR	0.343			0.38		
			10g SAR	0.165			0.18		
			Deviation	0.07			0.07		
	SIM 2	Bottom edge	1g SAR	0.347			0.39		
10g SAR			0.169			0.19			
Deviation			0.16			0.16			

**Table 14-9 WCDMA850-BV Head**

WCDMA850-BV Head									
Ambient Temperature:			22.5			Liquid Temperature:			23.3
Mode	Device orientation	SAR measurement	Measured SAR [W/kg]			Reported SAR [W/kg]			
			CH4233 846.6 MHz	CH4715 835.4 MHz	CH4132 826.4 MHz	CH4233 846.6 MHz	CH4715 835.4 MHz	CH4132 826.4 MHz	
RMC	Tune-up		24.50	24.50	24.50	Scaling factor*			
	Slot Average Power [dBm]		24.42	24.39	24.50	1.02	1.02	1.00	
	Left Cheek	1g SAR		0.145			0.15		
		10g SAR		0.106			0.11		
		Deviation		0.03			0.03		
	Left Tilt	1g SAR		0.136			0.14		
		10g SAR		0.075			0.08		
		Deviation		-0.01			-0.01		
	Right Cheek	1g SAR	0.174	0.22	0.209	0.18	0.23	0.21	
		10g SAR	0.121	0.17	0.146	0.12	0.17	0.15	
		Deviation	0.09	-0.05	0.03	0.09	-0.05	0.03	
	Right Tilt	1g SAR		0.086			0.09		
		10g SAR		0.04			0.04		
		Deviation		0.12			0.12		
	RMC B1	Right Cheek	1g SAR		0.203			0.21	
10g SAR				0.116			0.12		
Deviation				0.01			0.01		
SIM 2	Right Cheek	1g SAR		0.198			0.20		
		10g SAR		0.113			0.12		
		Deviation		0.03			0.03		

**Table 14-10 WCDMA850-BV Body**

WCDMA850-BV Body									
Ambient Temperature:			22.5			Liquid Temperature:			23.3
Mode	Device orientation	SAR measurement	Measured SAR [W/kg]			Reported SAR [W/kg]			
			CH4233 846.6 MHz	CH4715 835.4 MHz	CH4132 826.4 MHz	CH4233 846.6 MHz	CH4715 835.4 MHz	CH4132 826.4 MHz	
RMC	Tune-up		24.50	24.50	24.50	Scaling factor*			
	Slot Average Power [dBm]		24.42	24.39	24.50	1.02	1.02	1.00	
	Front	1g SAR		0.244			0.25		
		10g SAR		0.182			0.19		
		Deviation		0.1			0.10		
	Rear	1g SAR		0.268			0.27		
		10g SAR		0.201			0.21		
		Deviation		0.08			0.08		
	Bottom edge	1g SAR		0.216			0.22		
		10g SAR		0.107			0.11		
		Deviation		0.16			0.16		
	Left edge	1g SAR		0.191			0.20		
		10g SAR		0.126			0.13		
		Deviation		0.03			0.03		
	Right edge	1g SAR	0.331	0.374	0.318	0.34	0.38	0.32	
		10g SAR	0.219	0.256	0.211	0.22	0.26	0.21	
		Deviation	-0.1	-0.12	0.08	-0.10	-0.12	0.08	
	SIM2	Right edge	1g SAR		0.348			0.36	
			10g SAR		0.227			0.23	
			Deviation		-0.07			-0.07	
	RMC B1	Right edge	1g SAR		0.359			0.37	
10g SAR				0.237			0.24		
Deviation				0.1			0.10		

Table 14-11 LTE1900-FDD2 Head

LTE1900-FDD2 Head								
Ambient Temperature: 22.5			Liquid Temperature: 23.3					
Mode	Device orientation	SAR measurement	Measured SAR [W/kg]			Reported SAR [W/kg]		
			19100 M	18900 H	18700 M	19100 M	18900 H	18700 M
20MHz QPSK1RB	Tune-up		24.90	24.90	24.90	Scaling factor*		
	Measured Power [dBm]		24.49	24.02	24.25	1.10	1.22	1.16
	Left Cheek	1g SAR	0.328			0.36		
		10g SAR	0.208			0.23		
		Deviation	-0.06			-0.06		
	Left Tilt	1g SAR	0.122			0.13		
		10g SAR	0.085			0.09		
		Deviation	0.08			0.08		
	Right Cheek	1g SAR	0.185			0.20		
		10g SAR	0.131			0.14		
		Deviation	0.11			0.11		
	Right Tilt	1g SAR	0.119			0.13		
		10g SAR	0.065			0.07		
Deviation		-0.06			-0.06			
TRUE	Device orientation	SAR measurement	Measured SAR [W/kg]			Reported SAR [W/kg]		
			19100 H	18900 H	18700 L	19100 H	18900 H	18700 L
20MHz QPSK50%RB	Tune-up		23.90	23.90	23.90	Scaling factor*		
	Measured Power [dBm]		23.20	23.11	23.12	1.18	1.20	1.20
	Left Cheek	1g SAR	0.249			0.29		
		10g SAR	0.159			0.19		
		Deviation	0.04			0.04		
	Left Tilt	1g SAR	0.091			0.11		
		10g SAR	0.063			0.07		
		Deviation	0.18			0.18		
	Right Cheek	1g SAR	0.151			0.18		
		10g SAR	0.107			0.13		
		Deviation	0.06			0.06		
	Right Tilt	1g SAR	0.087			0.10		
		10g SAR	0.047			0.06		
Deviation		0.11			0.11			
Mode	Device orientation	SAR measurement	Measured SAR [W/kg]			Reported SAR [W/kg]		
			19100	18900	18700	19100	18900	18700
20MHz QPSK100%RB	Tune-up		23.90	23.90	23.90	Scaling factor*		
	Measured Power [dBm]		23.13	23.19	23.13	1.19	1.18	1.19
	Left Cheek	1g SAR						
		10g SAR						
Deviation								
20MHz QPSK1RB B1	Left Cheek	1g SAR	0.304			0.33		
		10g SAR	0.197			0.22		
		Deviation	-0.12			-0.12		
SIM 2	Left Cheek	1g SAR	0.311			0.34		
		10g SAR	0.202			0.22		
		Deviation	-0.09			-0.09		

**Table 14-12 LTE1900-FDD2 Body**

LTE1900-FDD2 Body								
Ambient Temperature: 22.5			Liquid Temperature: 23.3					
Mode	Device orientation	SAR measurement	Measured SAR [W/kg]			Reported SAR [W/kg]		
			19100	18900	18700	19100	18900	18700
			M	H	M	M	H	M
20MHz QPSK1RB	Tune-up		24.90	24.90	24.90	Scaling factor*		
	Measured Power [dBm]		24.49	24.02	24.25	1.10	1.22	1.16
	Front	1g SAR	0.426			0.47		
		10g SAR	0.233			0.26		
		Deviation	-0.03			-0.03		
	Rear	1g SAR	0.335			0.37		
		10g SAR	0.192			0.21		
		Deviation	-0.01			-0.01		
	Bottom edge	1g SAR	0.327			0.36		
		10g SAR	0.161			0.18		
		Deviation	0.18			0.18		
	Left edge	1g SAR	0.371			0.41		
		10g SAR	0.204			0.22		
		Deviation	0.04			0.04		
	Right edge	1g SAR	0.0532			0.06		
10g SAR		0.0374			0.04			
Deviation		-0.14			-0.14			
Mode	Device orientation	SAR measurement	Measured SAR [W/kg]			Reported SAR [W/kg]		
			19100	18900	18700	19100	18900	18700
			H	H	L			
20MHz QPSK50%RB	Tune-up		23.90	23.90	23.90	Scaling factor*		
	Measured Power [dBm]		23.20	23.11	23.12	1.18	1.20	1.20
	Front	1g SAR	0.333			0.39		
		10g SAR	0.183			0.22		
		Deviation	0.09			0.09		
	Rear	1g SAR	0.274			0.32		
		10g SAR	0.157			0.18		
		Deviation	-0.01			-0.01		
	Bottom edge	1g SAR	0.258			0.30		
		10g SAR	0.127			0.15		
		Deviation	-0.06			-0.06		
	Left edge	1g SAR	0.306			0.36		
		10g SAR	0.169			0.20		
		Deviation	-0.06			-0.06		
	Right edge	1g SAR	0.048			0.06		
10g SAR		0.0268			0.03			
Deviation		0.11			0.11			
Mode	Device orientation	SAR measurement	Measured SAR [W/kg]			Reported SAR [W/kg]		
			19100	18900	18700	19100	18900	18700
20MHz QPSK100%RB	Tune-up		23.90	23.90	23.90	Scaling factor*		
	Measured Power [dBm]		23.13	23.19	23.13	1.19	1.18	1.19
20MHz QPSK1RB B1	Front	1g SAR	0.412			0.45		
		10g SAR	0.221			0.24		
		Deviation	0.11			0.11		
SIM 2	Front	1g SAR	0.407			0.45		
		10g SAR	0.214			0.24		
		Deviation	0.05			0.05		



Table 14-13 LTE1700-FDD4 Head

LTE1700-FDD4 Head								
Ambient Temperature: 22.5			Liquid Temperature: 23.3					
Mode	Device orientation	SAR measurement	Measured SAR [W/kg]			Reported SAR [W/kg]		
			20300	20175	20050	20300	20175	20050
			H	H	M	H	H	M
20MHz QPSK1RB	Tune-up		24.80	24.80	24.80	Scaling factor*		
	Measured Power [dBm]		24.48	24.11	24.72	1.08	1.17	1.02
	Left Cheek	1g SAR			0.13			0.13
		10g SAR			0.085			0.09
		Deviation			-0.12			-0.12
	Left Tilt	1g SAR			0.057			0.06
		10g SAR			0.035			0.04
		Deviation			0.08			0.08
	Right Cheek	1g SAR			0.06			0.06
		10g SAR			0.035			0.04
		Deviation			-0.06			-0.06
	Right Tilt	1g SAR			0.059			0.06
10g SAR				0.035			0.04	
Deviation				-0.06			-0.06	
TRUE	Device orientation	SAR measurement	Measured SAR [W/kg]			Reported SAR [W/kg]		
			20300	20175	20050	20300	20175	20050
			M	H	L	M	H	L
20MHz QPSK50%RB	Tune-up		23.80	23.80	23.80	Scaling factor*		
	Measured Power [dBm]		23.35	23.04	23.12	1.11	1.19	1.17
	Left Cheek	1g SAR	0.112			0.12		
		10g SAR	0.073			0.08		
		Deviation	0.07			0.07		
	Left Tilt	1g SAR	0.039			0.04		
		10g SAR	0.024			0.03		
		Deviation	0.18			0.18		
	Right Cheek	1g SAR	0.062			0.07		
		10g SAR	0.044			0.05		
		Deviation	0.04			0.04		
	Right Tilt	1g SAR	0.053			0.06		
10g SAR		0.031			0.03			
Deviation		0.15			0.15			
Mode	Device orientation	SAR measurement	Measured SAR [W/kg]			Reported SAR [W/kg]		
			20300	20175	20050	20300	20175	20050
20MHz QPSK100%RB	Tune-up		23.80	23.80	23.80	Scaling factor*		
	Measured Power [dBm]		23.26	23.06	23.19	1.13	1.18	1.15
	Left Cheek	1g SAR						
10g SAR								
Deviation								
20MHz QPSK1RB B1	Left Cheek	1g SAR			0.12			0.12
		10g SAR			0.075			0.08
		Deviation			0.11			0.11
SIM 2	Left Cheek	1g SAR			0.121			0.12
		10g SAR			0.081			0.08
		Deviation			-0.06			-0.06

**Table 14-14 LTE1700-FDD4 Body**

LTE1700-FDD4 Body									
Ambient Temperature:			22.5			Liquid Temperature:			23.3
Mode	Device orientation	SAR measurement	Measured SAR [W/kg]			Reported SAR [W/kg]			
			20300	20175	20050	20300	20175	20050	
			H	H	M	H	H	M	
20MHz QPSK1RB	Tune-up		24.80	24.80	24.80	Scaling factor*			
	Measured Power [dBm]		24.48	24.11	24.72	1.08	1.17	1.02	
	Front	1g SAR			0.138			0.14	
		10g SAR			0.0853			0.09	
		Deviation			0.09			0.09	
	Rear	1g SAR			0.118			0.12	
		10g SAR			0.0793			0.08	
		Deviation			0.12			0.12	
	Bottom edge	1g SAR			0.143			0.15	
		10g SAR			0.081			0.08	
		Deviation			0.07			0.07	
	Left edge	1g SAR			0.179			0.18	
		10g SAR			0.109			0.11	
		Deviation			0			0.00	
	Right edge	1g SAR			0.0912			0.09	
10g SAR				0.0377			0.04		
Deviation				0.04			0.04		
Mode	Device orientation	SAR measurement	Measured SAR [W/kg]			Reported SAR [W/kg]			
			20300	20175	20050	20300	20175	20050	
			M	H	L				
20MHz QPSK50%RB	Tune-up		23.80	23.80	23.80	Scaling factor*			
	Measured Power [dBm]		23.35	23.04	23.12	1.11	1.19	1.17	
	Front	1g SAR	0.106			0.12			
		10g SAR	0.0628			0.07			
		Deviation	0.02			0.02			
	Rear	1g SAR	0.0973			0.11			
		10g SAR	0.0617			0.07			
		Deviation	-0.11			-0.11			
	Bottom edge	1g SAR	0.102			0.11			
		10g SAR	0.0631			0.07			
		Deviation	-0.04			-0.04			
	Left edge	1g SAR	0.109			0.12			
		10g SAR	0.0638			0.07			
		Deviation	-0.02			-0.02			
	Right edge	1g SAR	0.0524			0.06			
10g SAR		0.0213			0.02				
Deviation		0.11			0.11				
Mode	Device orientation	SAR measurement	Measured SAR [W/kg]			Reported SAR [W/kg]			
			20300	20175	20050	20300	20175	20050	
20MHz QPSK100%RB	Tune-up		23.80	23.80	23.80	Scaling factor*			
	Measured Power [dBm]		23.26	23.06	23.19	1.13	1.18	1.15	
Left edge	1g SAR								
	10g SAR								
	Deviation								
20MHz QPSK1RB B1	Left edge	1g SAR			0.149			0.15	
		10g SAR			0.0966			0.10	
		Deviation			0.04			0.04	
SIM 2	Left edge	1g SAR			0.149			0.15	
		10g SAR			0.0879			0.09	
		Deviation			0.14			0.14	

Table 14-15 LTE2500-FDD7 Head

LTE2500-FDD7 Head									
Ambient Temperature: 22.5			Liquid Temperature: 23.3						
Mode	Device orientation	SAR measurement	Measured SAR [W/kg]			Reported SAR [W/kg]			
			21350	21100	20850	21350	21100	20850	
			M	M	M	M	M	M	
20MHz QPSK1RB	Tune-up		24.50	24.50	24.50	Scaling factor*			
	Measured Power [dBm]		23.93	23.55	23.78	1.14	1.25	1.18	
	Left Cheek	1g SAR	0.368			0.42			
		10g SAR	0.206			0.23			
		Deviation	0.06			0.06			
	Left Tilt	1g SAR	0.09			0.10			
		10g SAR	0.043			0.05			
		Deviation	0.04			0.04			
	Right Cheek	1g SAR	0.203			0.23			
		10g SAR	0.117			0.13			
		Deviation	-0.09			-0.09			
	Right Tilt	1g SAR	0.162			0.18			
		10g SAR	0.066			0.08			
		Deviation	0.01			0.01			
TRUE	Device orientation	SAR measurement	Measured SAR [W/kg]			Reported SAR [W/kg]			
			21350	21100	20850	21350	21100	20850	
			M	H	L	M	H	L	
20MHz QPSK50%RB	Tune-up		23.50	23.50	23.50	Scaling factor*			
	Measured Power [dBm]		22.66	22.64	22.59	1.21	1.22	1.23	
	Left Cheek	1g SAR	0.283			0.34			
		10g SAR	0.152			0.18			
		Deviation	0.17			0.17			
	Left Tilt	1g SAR	0.073			0.09			
		10g SAR	0.034			0.04			
		Deviation	0.04			0.04			
	Right Cheek	1g SAR	0.154			0.19			
		10g SAR	0.089			0.11			
		Deviation	0.09			0.09			
	Right Tilt	1g SAR	0.13			0.16			
		10g SAR	0.053			0.06			
		Deviation	0.01			0.01			
Mode	Device orientation	SAR measurement	Measured SAR [W/kg]			Reported SAR [W/kg]			
			21350	21100	20850	21350	21100	20850	
20MHz QPSK100%RB	Tune-up		23.50	23.50	23.50	Scaling factor*			
	Measured Power [dBm]		22.60	22.62	22.54	1.23	1.22	1.25	
	Left Cheek	1g SAR							
		10g SAR							
Deviation									
20MHz QPSK1RB B1	Left Cheek	1g SAR	0.334			0.38			
		10g SAR	0.171			0.19			
		Deviation	-0.05			-0.05			
SIM 2	Left Cheek	1g SAR	0.364			0.41			
		10g SAR	0.193			0.22			
		Deviation	0.1			0.10			



**Table 14-16 LTE2500-FDD7 Body**

LTE2500-FDD7 Body								
Ambient Temperature: 22.5			Liquid Temperature: 23.3					
Mode	Device orientation	SAR measurement	Measured SAR [W/kg]			Reported SAR [W/kg]		
			21350	21100	20850	21350	21100	20850
			M	M	M	M	M	M
20MHz QPSK1RB	Tune-up		24.50	24.50	24.50	Scaling factor*		
	Measured Power [dBm]		23.93	23.55	23.78	1.14	1.25	1.18
	Front	1g SAR	0.335			0.38		
		10g SAR	0.181			0.21		
		Deviation	-0.1			-0.10		
	Rear	1g SAR	0.382			0.44		
		10g SAR	0.215			0.25		
		Deviation	-0.04			-0.04		
	Bottom edge	1g SAR	0.324			0.37		
		10g SAR	0.144			0.16		
		Deviation	0.09			0.09		
	Left edge	1g SAR	0.461			0.53		
		10g SAR	0.247			0.28		
		Deviation	0.05			0.05		
Right edge	1g SAR	0.0561			0.06			
	10g SAR	0.0327			0.04			
	Deviation	0.07			0.07			
Mode	Device orientation	SAR measurement	Measured SAR [W/kg]			Reported SAR [W/kg]		
			21350	21100	20850	21350	21100	20850
			M	H	L			
20MHz QPSK50%RB	Tune-up		23.50	23.50	23.50	Scaling factor*		
	Measured Power [dBm]		22.66	22.64	22.59	1.21	1.22	1.23
	Front	1g SAR	0.292			0.35		
		10g SAR	0.167			0.20		
		Deviation	0.14			0.14		
	Rear	1g SAR	0.304			0.37		
		10g SAR	0.179			0.22		
		Deviation	0.02			0.02		
	Bottom edge	1g SAR	0.243			0.30		
		10g SAR	0.108			0.13		
		Deviation	-0.09			-0.09		
	Left edge	1g SAR	0.326			0.40		
		10g SAR	0.173			0.21		
		Deviation	-0.1			-0.10		
Right edge	1g SAR	0.0506			0.06			
	10g SAR	0.0266			0.03			
	Deviation	0.19			0.19			
Mode	Device orientation	SAR measurement	Measured SAR [W/kg]			Reported SAR [W/kg]		
			21350	21100	20850	21350	21100	20850
20MHz QPSK100%RB	Tune-up		23.50	23.50	23.50	Scaling factor*		
	Measured Power [dBm]		22.60	22.62	22.54	1.23	1.22	1.25
	Front	1g SAR						
10g SAR								
Deviation								
20MHz QPSK1RB B1	Left edge	1g SAR	0.418			0.48		
		10g SAR	0.224			0.26		
		Deviation	0.1			0.10		
SIM 2	Left edge	1g SAR	0.405			0.46		
		10g SAR	0.219			0.25		
		Deviation	0.16			0.16		



Table14-17 LTE700-FDD12 Head

LTE700-FDD12 Head								
Ambient Temperature: 22.5			Liquid Temperature: 23.3					
Mode	Device orientation	SAR measurement	Measured SAR [W/kg]			Reported SAR [W/kg]		
			23130	23095	23060	23130	23095	23060
			M	M	M	M	M	M
10MHz QPSK1RB	Tune-up		25.00	25.00	25.00	Scaling factor*		
	Measured Power [dBm]		23.95	23.93	23.86	1.27	1.28	1.30
	Left Cheek	1g SAR	0.1			0.13		
		10g SAR	0.088			0.11		
		Deviation	0.03			0.03		
	Left Tilt	1g SAR	0.067			0.07		
		10g SAR	0.025			0.03		
		Deviation	0.01			0.01		
	Right Cheek	1g SAR	0.124			0.16		
		10g SAR	0.098			0.12		
		Deviation	0.02			0.02		
	Right Tilt	1g SAR	0.07			0.09		
		10g SAR	0.06			0.08		
Deviation		0.03			0.03			
TRUE	Device orientation	SAR measurement	Measured SAR [W/kg]			Reported SAR [W/kg]		
			23130	23095	23060	23130	23095	23060
			L	M	M	L	M	M
10MHz QPSK50%RB	Tune-up		24.00	24.00	24.00	Scaling factor*		
	Measured Power [dBm]		22.92	22.87	22.84	1.28	1.30	1.31
	Left Cheek	1g SAR	0.078			0.10		
		10g SAR	0.066			0.08		
		Deviation	0.08			0.08		
	Left Tilt	1g SAR	0.04			0.05		
		10g SAR	0.02			0.03		
		Deviation	0.03			0.03		
	Right Cheek	1g SAR	0.094			0.12		
		10g SAR	0.075			0.10		
		Deviation	-0.09			-0.09		
	Right Tilt	1g SAR	0.054			0.07		
		10g SAR	0.045			0.06		
Deviation		0.13			0.13			
Mode	Device orientation	SAR measurement	Measured SAR [W/kg]			Reported SAR [W/kg]		
			23130	23095	23060	23130	23095	23060
10MHz QPSK100%RB	Tune-up		24.00	24.00	24.00	Scaling factor*		
	Measured Power [dBm]		22.91	22.85	22.69	1.28	1.30	1.35
	Left Cheek	1g SAR						
10g SAR								
Deviation								
10MHz QPSK1RB B1	Right Cheek	1g SAR	0.096			0.12		
		10g SAR	0.076			0.10		
		Deviation	0.08			0.08		
SIM 1	Right Cheek	1g SAR	0.098			0.12		
		10g SAR	0.085			0.11		
		Deviation	0.19			0.19		

**Table 14-18 LTE700-FDD12 Body**

LTE700-FDD12 Body								
Ambient Temperature: 22.5			Liquid Temperature: 23.3					
Mode	Device orientation	SAR measurement	Measured SAR [W/kg]			Reported SAR [W/kg]		
			23130	23095	23060	23130	23095	23060
			M	M	M	M	M	M
10MHz QPSK1RB	Tune-up		25.00	25.00	25.00	Scaling factor*		
	Measured Power [dBm]		23.95	23.93	23.86	1.27	1.28	1.30
	Front	1g SAR	0.133			0.17		
		10g SAR	0.106			0.14		
		Deviation	0.12			0.12		
	Rear	1g SAR	0.108			0.14		
		10g SAR	0.0852			0.11		
		Deviation	0.04			0.04		
	Bottom edge	1g SAR	0.0426			0.05		
		10g SAR	0.0237			0.03		
		Deviation	0.06			0.06		
	Left edge	1g SAR	0.124			0.16		
		10g SAR	0.0867			0.11		
		Deviation	0.16			0.16		
	Right edge	1g SAR	0.182			0.23		
10g SAR		0.129			0.16			
Deviation		-0.08			-0.08			
Mode	Device orientation	SAR measurement	Measured SAR [W/kg]			Reported SAR [W/kg]		
			23130	23095	23060	23130	23095	23060
			L	M	M			
10MHz QPSK50%RB	Tune-up		24.00	24.00	24.00	Scaling factor*		
	Measured Power [dBm]		22.92	22.87	22.84	1.28	1.30	1.31
	Front	1g SAR	0.0982			0.13		
		10g SAR	0.0778			0.10		
		Deviation	-0.05			-0.05		
	Rear	1g SAR	0.0783			0.10		
		10g SAR	0.0615			0.08		
		Deviation	0.08			0.08		
	Bottom edge	1g SAR	0.0309			0.04		
		10g SAR	0.017			0.02		
		Deviation	0.06			0.06		
	Left edge	1g SAR	0.09			0.12		
		10g SAR	0.063			0.08		
		Deviation	0.03			0.03		
	Right edge	1g SAR	0.135			0.17		
10g SAR		0.0949			0.12			
Deviation		-0.04			-0.04			
Mode	Device orientation	SAR measurement	Measured SAR [W/kg]			Reported SAR [W/kg]		
			23130	23095	23060	23130	23095	23060
10MHz QPSK100%RB	Tune-up		24.00	24.00	24.00	Scaling factor*		
	Measured Power [dBm]		22.91	22.85	22.89	1.28	1.30	1.35
	Front	1g SAR						
		10g SAR						
Deviation								
10MHz QPSK1RB B1	Right edge	1g SAR	0.177			0.23		
		10g SAR	0.121			0.15		
		Deviation	0.03			0.03		
SIM 2	Right edge	1g SAR	0.168			0.21		
		10g SAR	0.117			0.15		
		Deviation	-0.12			-0.12		



Table 14-19 LTE2600-FDD38 Head

LTE2600-TDD38 Head								
Ambient Temperature: 22.5			Liquid Temperature: 23.3					
Mode	Device orientation	SAR measurement	Measured SAR [W/kg]			Reported SAR [W/kg]		
			38150	38000	37850	38150	38000	37850
			M	H	H	M	H	H
20MHz QPSK1RB	Tune-up		24.50	24.50	24.50	Scaling factor*		
	Measured Power [dBm]		23.74	23.50	23.52	1.19	1.26	1.25
	Left Cheek	1g SAR	0.2			0.24		
		10g SAR	0.101			0.12		
		Deviation	0.02			0.02		
	Left Tilt	1g SAR	0.051			0.06		
		10g SAR	0.026			0.03		
		Deviation	0.12			0.12		
	Right Cheek	1g SAR	0.081			0.10		
		10g SAR	0.046			0.05		
		Deviation	0.09			0.09		
	Right Tilt	1g SAR	0.055			0.07		
		10g SAR	0.028			0.03		
Deviation		-0.14			-0.14			
TRUE	Device orientation	SAR measurement	Measured SAR [W/kg]			Reported SAR [W/kg]		
			38150	38000	37850	38150	38000	37850
			L	H	L	L	H	L
20MHz QPSK50%RB	Tune-up		23.50	23.50	23.50	Scaling factor*		
	Measured Power [dBm]		22.51	22.49	22.53	1.26	1.26	1.25
	Left Cheek	1g SAR			0.144			0.18
		10g SAR			0.077			0.10
		Deviation			0.08			0.08
	Left Tilt	1g SAR			0.09			0.11
		10g SAR			0.042			0.05
		Deviation			0.06			0.06
	Right Cheek	1g SAR			0.065			0.08
		10g SAR			0.037			0.05
		Deviation			-0.05			-0.05
	Right Tilt	1g SAR			0.07			0.09
		10g SAR			0.033			0.04
Deviation				0.03			0.03	
Mode	Device orientation	SAR measurement	Measured SAR [W/kg]			Reported SAR [W/kg]		
			38150	38000	37850	38150	38000	37850
20MHz QPSK100%RB	Tune-up		23.50	23.50	23.50	Scaling factor*		
	Measured Power [dBm]		22.41	22.44	22.43	1.29	1.28	1.28
	Left Cheek	1g SAR						
		10g SAR						
Deviation								
20MHz QPSK1RB B1	Left Cheek	1g SAR	0.164			0.20		
		10g SAR	0.084			0.10		
		Deviation	0.08			0.08		
SIM2	Left Cheek	1g SAR	0.151			0.18		
		10g SAR	0.082			0.10		
		Deviation	0.01			0.01		