

**ELECTROMAGNETIC EMISSIONS COMPLIANCE REPORT**  
**INTENTIONAL RADIATOR CERTIFICATION TO**  
**FCC PART 22 SUBPART H, PART 24 SUBPART E and PART 27 SUBPART**  
**B, C & SUBPART L REQUIREMENT**

OF

**Product Name:** Smart Phone  
**Brand Name:** Nokia  
**Model No.:** TA-1023  
**Model Difference:** N/A  
**FCC ID:** 2AJOTTA-1023  
**Report No.:** ER/2017/60090  
**Issue Date:** Jul. 18, 2017  
**FCC Rule Part:** 2 , 22H & 24E & 27B, C & L  
**Prepared for:** HMD Global Oy  
Karaportti 2, 02610 Espoo, Finland  
**Prepared by:** SGS Taiwan Ltd.  
Electronics & Communication Laboratory  
No.134, Wu Kung Road, New Taipei Industrial Park,  
Wuku District, New Taipei City, Taiwan 24803



**Note:** This report shall not be reproduced except in full, without the written approval of SGS Taiwan Ltd. This document may be altered or revised by SGS Taiwan Ltd. personnel only, and shall be noted in the revision section of the document.

Unless otherwise stated the results shown in this test report refer only to the sample(s) tested and such sample(s) are retained for 90 days only.

除非另有說明，此報告結果僅對測試之樣品負責，同時此樣品僅保留90天。本報告未經本公司書面許可，不可部份複製。

This document is issued by the Company subject to its General Conditions of Service printed overleaf, available on request or accessible at [www.sgs.com/terms\\_and\\_conditions.htm](http://www.sgs.com/terms_and_conditions.htm) and, for electronic format documents, subject to Terms and Conditions for Electronic Documents at [www.sgs.com/terms\\_e-document.htm](http://www.sgs.com/terms_e-document.htm). Attention is drawn to the limitation of liability, indemnification and jurisdiction issues defined therein. Any holder of this document is advised that information contained hereon reflects the Company's findings at the time of its intervention only and within the limits of Client's instructions, if any. The Company's sole responsibility is to its Client and this document does not exonerate parties to a transaction from exercising all their rights and obligations under the transaction documents. This document cannot be reproduced except in full, without prior written approval of the Company. Any unauthorized alteration, forgery or falsification of the content or appearance of this document is unlawful and offenders may be prosecuted to the fullest extent of the law.

SGS Taiwan Ltd.

No.134,WuKungRoad,NewTaipeiIndustrialPark,WukuDistrict,NewTaipeiCity,Taiwan24803/新北市五股區新北產業園區五工路 134 號

台灣檢驗科技股份有限公司

t (886-2) 2299-3279

f (886-2) 2298-0488

[www.tw.sgs.com](http://www.tw.sgs.com)

Member of SGS Group

## VERIFICATION OF COMPLIANCE

**Applicant:** HMD Global Oy  
Karaportti 2, 02610 Espoo, Finland

**Product Name:** Smart Phone

**Brand Name:** Nokia

**Model No.:** TA-1023

**Model Difference:** N/A

**FCC ID:** 2AJOTTA-1023

**File Number:** ER/2017/60090

**Date of test:** Jul. 03, 2017 ~ Jul. 06, 2017

**Date of EUT Received:** Jul. 24, 2017

### We hereby certify that:

The above equipment was tested by SGS Taiwan Ltd. Electronics & Communication Laboratory. The test data, data evaluation, test procedures, and equipment configurations shown in this report were made in accordance with the procedures given in TIA/EIA-603-D-2010 and the energy emitted by the sample EUT tested as described in this report is in compliance with conducted and radiated emission limits.

The test results of this report relate only to the tested sample identified in this report.

**Test By:**

*Louis Chen*

**Date:**

Jul. 18, 2017

\_\_\_\_\_  
**Louis Chen / Engineer**

**Prepared By:**

*Karen Huang*

**Date:**

Jul. 18, 2017

\_\_\_\_\_  
**Karen Huang / Clerk**

**Approved By:**

*Jim Chang*

**Date:**

Jul. 18, 2017

\_\_\_\_\_  
**Jim Chang / Asst. Manager**

Unless otherwise stated the results shown in this test report refer only to the sample(s) tested and such sample(s) are retained for 90 days only.

除非另有說明，此報告結果僅對測試之樣品負責，同時此樣品僅保留90天。本報告未經本公司書面許可，不可部份複製。

This document is issued by the Company subject to its General Conditions of Service printed overleaf, available on request or accessible at [www.sgs.com/terms\\_and\\_conditions.htm](http://www.sgs.com/terms_and_conditions.htm) and, for electronic format documents, subject to Terms and Conditions for Electronic Documents at [www.sgs.com/terms\\_e-document.htm](http://www.sgs.com/terms_e-document.htm). Attention is drawn to the limitation of liability, indemnification and jurisdiction issues defined therein. Any holder of this document is advised that information contained hereon reflects the Company's findings at the time of its intervention only and within the limits of Client's instructions, if any. The Company's sole responsibility is to its Client and this document does not exonerate parties to a transaction from exercising all their rights and obligations under the transaction documents. This document cannot be reproduced except in full, without prior written approval of the Company. Any unauthorized alteration, forgery or falsification of the content or appearance of this document is unlawful and offenders may be prosecuted to the fullest extent of the law.

SGS Taiwan Ltd.

No.134,WuKungRoad,NewTaipeiIndustrialPark,WukuDistrict,NewTaipeiCity,Taiwan24803/新北市五股區新北產業園區五工路 134 號

台灣檢驗科技股份有限公司

t (886-2) 2299-3279

f (886-2) 2298-0488

www.tw.sgs.com

Member of SGS Group

## Revision History

Report Number	Revision	Description	Issue Date
ER/2017/60090	Rev.00	Initial creation of document	Jul. 18, 2017

Unless otherwise stated the results shown in this test report refer only to the sample(s) tested and such sample(s) are retained for 90 days only.

除非另有說明，此報告結果僅對測試之樣品負責，同時此樣品僅保留90天。本報告未經本公司書面許可，不可部份複製。

This document is issued by the Company subject to its General Conditions of Service printed overleaf, available on request or accessible at [www.sgs.com/terms\\_and\\_conditions.htm](http://www.sgs.com/terms_and_conditions.htm) and, for electronic format documents, subject to Terms and Conditions for Electronic Documents at [www.sgs.com/terms\\_e-document.htm](http://www.sgs.com/terms_e-document.htm). Attention is drawn to the limitation of liability, indemnification and jurisdiction issues defined therein. Any holder of this document is advised that information contained hereon reflects the Company's findings at the time of its intervention only and within the limits of Client's instructions, if any. The Company's sole responsibility is to its Client and this document does not exonerate parties to a transaction from exercising all their rights and obligations under the transaction documents. This document cannot be reproduced except in full, without prior written approval of the Company. Any unauthorized alteration, forgery or falsification of the content or appearance of this document is unlawful and offenders may be prosecuted to the fullest extent of the law.

SGS Taiwan Ltd.

No.134,WuKungRoad,NewTaipeiIndustrialPark,WukuDistrict,NewTaipeiCity,Taiwan24803/新北市五股區新北產業園區五工路 134 號

台灣檢驗科技股份有限公司

t (886-2) 2299-3279

f (886-2) 2298-0488

[www.tw.sgs.com](http://www.tw.sgs.com)

Member of SGS Group

## Contents

1. GENERAL PRODUCT INFORMATION .....	5
2. SYSTEM TEST CONFIGURATION .....	12
3. SUMMARY OF TEST RESULTS .....	16
4. DESCRIPTION OF TEST MODES .....	17
5. MEASUREMENT UNCERTAINTY .....	25
6. RF CONDUCTED OUTPUT POWER MEASUREMENT .....	26
7. EFFECTIVE RADIATED POWER AND EQUIVALENT ISOTROPIC RADIATED POWER MEASUREMENT .....	38
8. OCCUPIED BANDWIDTH MEASUREMENT .....	74
9. OUT OF BAND EMISSION AT ANTENNA TERMINALS .....	114
10. FIELD STRENGTH OF SPURIOUS RADIATION MEASUREMENT .....	200
11. FREQUENCY STABILITY MEASUREMENT .....	270
12. PEAK TO AVERAGE RATIO .....	278
PHOTOGRAPHS OF SET UP .....	304
PHOTOGRAPHS OF EUT .....	309

Unless otherwise stated the results shown in this test report refer only to the sample(s) tested and such sample(s) are retained for 90 days only.

除非另有說明，此報告結果僅對測試之樣品負責，同時此樣品僅保留90天。本報告未經本公司書面許可，不可部份複製。

This document is issued by the Company subject to its General Conditions of Service printed overleaf, available on request or accessible at [www.sgs.com/terms\\_and\\_conditions.htm](http://www.sgs.com/terms_and_conditions.htm) and, for electronic format documents, subject to Terms and Conditions for Electronic Documents at [www.sgs.com/terms\\_e-document.htm](http://www.sgs.com/terms_e-document.htm). Attention is drawn to the limitation of liability, indemnification and jurisdiction issues defined therein. Any holder of this document is advised that information contained hereon reflects the Company's findings at the time of its intervention only and within the limits of Client's instructions, if any. The Company's sole responsibility is to its Client and this document does not exonerate parties to a transaction from exercising all their rights and obligations under the transaction documents. This document cannot be reproduced except in full, without prior written approval of the Company. Any unauthorized alteration, forgery or falsification of the content or appearance of this document is unlawful and offenders may be prosecuted to the fullest extent of the law.

SGS Taiwan Ltd.

No.134,WuKungRoad,NewTaipeiIndustrialPark,WukuDistrict,NewTaipeiCity,Taiwan24803/新北市五股區新北產業園區五工路 134 號

台灣檢驗科技股份有限公司

t (886-2) 2299-3279

f (886-2) 2298-0488

[www.tw.sgs.com](http://www.tw.sgs.com)

Member of SGS Group

## 1. GENERAL PRODUCT INFORMATION

### 1.1. Product Description

General:

Product Name:	Smart Phone	
Brand Name:	Nokia	
Model No.:	TA-1023	
Model difference:	N/A	
Hardware Version:	890	
Software Version:	V0.140	
USB Cable:	Model No.: CUBB01M-FA010-DH, Supplier: Nokia	
Headset:	Model No.: WH-108, Supplier: Nokia	
Power Supply:	3.85Vdc from Rechargeable Li-polymer Battery or 5 V from AC/DC Adapter	
	Battery:	Model No.: HE338, Supplier: Nokia
	Adapter:	Model No.: FC0102, Supplier: Nokia

Unless otherwise stated the results shown in this test report refer only to the sample(s) tested and such sample(s) are retained for 90 days only.

除非另有說明，此報告結果僅對測試之樣品負責，同時此樣品僅保留90天。本報告未經本公司書面許可，不可部份複製。

This document is issued by the Company subject to its General Conditions of Service printed overleaf, available on request or accessible at [www.sgs.com/terms\\_and\\_conditions.htm](http://www.sgs.com/terms_and_conditions.htm) and, for electronic format documents, subject to Terms and Conditions for Electronic Documents at [www.sgs.com/terms\\_e-document.htm](http://www.sgs.com/terms_e-document.htm). Attention is drawn to the limitation of liability, indemnification and jurisdiction issues defined therein. Any holder of this document is advised that information contained hereon reflects the Company's findings at the time of its intervention only and within the limits of Client's instructions, if any. The Company's sole responsibility is to its Client and this document does not exonerate parties to a transaction from exercising all their rights and obligations under the transaction documents. This document cannot be reproduced except in full, without prior written approval of the Company. Any unauthorized alteration, forgery or falsification of the content or appearance of this document is unlawful and offenders may be prosecuted to the fullest extent of the law.

SGS Taiwan Ltd.

No.134,WuKungRoad,NewTaipeiIndustrialPark,WukuDistrict,NewTaipeiCity,Taiwan24803/新北市五股區新北產業園區五工路 134 號

台灣檢驗科技股份有限公司

t (886-2) 2299-3279

f (886-2) 2298-0488

[www.tw.sgs.com](http://www.tw.sgs.com)

Member of SGS Group

**GSM / WCDMA / LTE:**

	Operating Frequency		Rated Power	
		GSM/GPRS 850	824.2 MHz– 848.8 MHz	33dBm
	EDGE 850	824.2 MHz– 848.8 MHz	27dBm	
	GSM/GPRS 1900	1850.2MHz – 1909.8MHz	30dBm	
	EDGE 1900	1850.2MHz – 1909.8MHz	26dBm	
	WCDMA / HSPA+ Band II	1852.4MHz – 1907.6MHz	23.5dBm	
	WCDMA / HSPA+ Band IV	1712.4MHz – 1752.6MHz	24dBm	
	WCDMA / HSPA+ Band V	826.4MHz - 846.6MHz	24dBm	
Cellular Phone Standards Frequency Range and Power	LTE-Band 2 (1.4MHz)	1850.7MHz– 1909.3MHz	23dBm	
	LTE-Band 2 (3MHz)	1851.5MHz – 1908.5MHz	23dBm	
	LTE-Band 2 (5MHz)	1852.5MHz – 1907.5MHz	23dBm	
	LTE-Band 2 (10MHz)	1855.0MHz – 1905.0MHz	23dBm	
	LTE-Band 2 (15MHz)	1857.5MHz – 1902.5MHz	23dBm	
	LTE-Band 2 (20MHz)	1860.0MHz – 1900.0MHz	23dBm	
	LTE-Band 4 (1.4MHz)	1710.7MHz– 1754.3MHz	23dBm	
	LTE-Band 4 (3MHz)	1711.5MHz – 1753.5MHz	23dBm	
	LTE-Band 4 (5MHz)	1712.5MHz – 1752.5MHz	23dBm	
	LTE-Band 4 (10MHz)	1715MHz – 1750MHz	23dBm	
	LTE-Band 4 (15MHz)	1717.5MHz – 1747.5MHz	23dBm	
	LTE-Band 4 (20MHz)	1720MHz – 1745MHz	23dBm	
	LTE-Band 7 (Bandwidth 5MHz)	2502.5MHz – 2567.5MHz	23dBm	
	LTE-Band 7 (Bandwidth 10MHz)	2505.0MHz – 2565.0MHz	23dBm	
	LTE-Band 7 (Bandwidth 15MHz)	2507.5MHz – 2562.5MHz	23dBm	
	LTE-Band 7 (Bandwidth 20MHz)	2510.0MHz – 2560MHz	23dBm	
	LTE-Band 12 (1.4MHz)	699.7MHz– 715.3MHz	23dBm	
	LTE-Band 12 (3MHz)	700.5MHz – 714.5MHz	23dBm	
	LTE-Band 12 (5MHz)	701.5MHz – 713.5MHz	23dBm	
	LTE-Band 12 (10MHz)	704.0MHz – 711.0MHz	23dBm	
	LTE-Band 17 (5MHz)	706.5MHz – 713.5MHz	23dBm	
	LTE-Band 17 (10MHz)	709.0MHz –711.0MHz	23dBm	
	LTE-Band 38 (Bandwidth 5MHz)	2572.5MHz – 2617.5MHz	23dBm	
	LTE-Band 38 (Bandwidth 10MHz)	2575MHz – 2615MHz	23dBm	
	LTE-Band 38 (Bandwidth 15MHz)	2577.5MHz – 2612.5MHz	23dBm	
	LTE-Band 38 (Bandwidth 20MHz)	2580MHz – 2610MHz	23dBm	
	IMEI:	356041080003357		

Unless otherwise stated the results shown in this test report refer only to the sample(s) tested and such sample(s) are retained for 90 days only.

除非另有說明，此報告結果僅對測試之樣品負責，同時此樣品僅保留90天。本報告未經本公司書面許可，不可部份複製。

This document is issued by the Company subject to its General Conditions of Service printed overleaf, available on request or accessible at [www.sgs.com/terms\\_and\\_conditions.htm](http://www.sgs.com/terms_and_conditions.htm) and, for electronic format documents, subject to Terms and Conditions for Electronic Documents at [www.sgs.com/terms\\_e-document.htm](http://www.sgs.com/terms_e-document.htm). Attention is drawn to the limitation of liability, indemnification and jurisdiction issues defined therein. Any holder of this document is advised that information contained hereon reflects the Company's findings at the time of its intervention only and within the limits of Client's instructions, if any. The Company's sole responsibility is to its Client and this document does not exonerate parties to a transaction from exercising all their rights and obligations under the transaction documents. This document cannot be reproduced except in full, without prior written approval of the Company. Any unauthorized alteration, forgery or falsification of the content or appearance of this document is unlawful and offenders may be prosecuted to the fullest extent of the law.

**Type of Emission:**

Frequency Band	Type of Emission:
GSM 850	243KGXW
GPRS 850	245KGXW
EDGE 850	245KG7W
GSM 1900	246KGXW
GPRS 1900	240KGXW
EDGE 1900	249KG7W
WCDMA Band II	4M16F9W
HSDPA Band II	4M16F9W
HSUPA Band II	4M16F9W
WCDMA Band IV	4M15F9W
HSDPA Band IV	4M16F9W
HSUPA Band IV	4M16F9W
WCDMA Band V	4M13F9W
HSDPA Band V	4M15F9W
HSUPA Band V	4M13F9W

LTE Band	BW (MHz)	Modulation	Type of Emission
LTE Band 2	1.4MHz	QPSK	1M10G7D
LTE Band 2	1.4MHz	16QAM	1M10D7W
LTE Band 2	3MHz	QPSK	2M70G7D
LTE Band 2	3MHz	16QAM	2M71D7W
LTE Band 2	5MHz	QPSK	4M51G7D
LTE Band 2	5MHz	16QAM	4M51D7W
LTE Band 2	10MHz	QPSK	9M02G7D
LTE Band 2	10MHz	16QAM	8M96D7W
LTE Band 2	15MHz	QPSK	13M5G7D
LTE Band 2	15MHz	16QAM	13M5D7W
LTE Band 2	20MHz	QPSK	18M0G7D
LTE Band 2	20MHz	16QAM	18M0D7W
LTE Band 4	1.4MHz	QPSK	1M10G7D
LTE Band 4	1.4MHz	16QAM	1M10D7W
LTE Band 4	3MHz	QPSK	2M71G7D
LTE Band 4	3MHz	16QAM	2M71D7W
LTE Band 4	5MHz	QPSK	4M51G7D
LTE Band 4	5MHz	16QAM	4M51D7W
LTE Band 4	10MHz	QPSK	9M01G7D
LTE Band 4	10MHz	16QAM	8M96D7W
LTE Band 4	15MHz	QPSK	13M5G7D
LTE Band 4	15MHz	16QAM	13M5D7W
LTE Band 4	20MHz	QPSK	18M0G7D
LTE Band 4	20MHz	16QAM	18M0D7W

Unless otherwise stated the results shown in this test report refer only to the sample(s) tested and such sample(s) are retained for 90 days only.

除非另有說明，此報告結果僅對測試之樣品負責，同時此樣品僅保留90天。本報告未經本公司書面許可，不可部份複製。

This document is issued by the Company subject to its General Conditions of Service printed overleaf, available on request or accessible at [www.sgs.com/terms\\_and\\_conditions.htm](http://www.sgs.com/terms_and_conditions.htm) and, for electronic format documents, subject to Terms and Conditions for Electronic Documents at [www.sgs.com/terms\\_e-document.htm](http://www.sgs.com/terms_e-document.htm). Attention is drawn to the limitation of liability, indemnification and jurisdiction issues defined therein. Any holder of this document is advised that information contained hereon reflects the Company's findings at the time of its intervention only and within the limits of Client's instructions, if any. The Company's sole responsibility is to its Client and this document does not exonerate parties to a transaction from exercising all their rights and obligations under the transaction documents. This document cannot be reproduced except in full, without prior written approval of the Company. Any unauthorized alteration, forgery or falsification of the content or appearance of this document is unlawful and offenders may be prosecuted to the fullest extent of the law.

LTE Band	BW (MHz)	Modulation	Type of Emission
LTE Band 7	5MHz	QPSK	4M53G7D
LTE Band 7	5MHz	16QAM	4M52D7W
LTE Band 7	10MHz	QPSK	9M01G7D
LTE Band 7	10MHz	16QAM	8M96D7W
LTE Band 7	15MHz	QPSK	13M5G7D
LTE Band 7	15MHz	16QAM	13M5D7W
LTE Band 7	20MHz	QPSK	17M9G7D
LTE Band 7	20MHz	16QAM	18M0D7W
LTE Band 12	1.4MHz	QPSK	1M10G7D
LTE Band 12	1.4MHz	16QAM	1M10D7W
LTE Band 12	3MHz	QPSK	2M70G7D
LTE Band 12	3MHz	16QAM	2M70D7W
LTE Band 12	5MHz	QPSK	4M52G7D
LTE Band 12	5MHz	16QAM	4M52D7W
LTE Band 12	10MHz	QPSK	9M03G7D
LTE Band 12	10MHz	16QAM	8M95D7W
LTE Band 17	5MHz	QPSK	4M52G7D
LTE Band 17	5MHz	16QAM	4M59D7W
LTE Band 17	10MHz	QPSK	9M10G7D
LTE Band 17	10MHz	16QAM	9M12D7W
LTE Band 38	5MHz	QPSK	4M21G7D
LTE Band 38	5MHz	16QAM	4M51D7W
LTE Band 38	10MHz	QPSK	8M99G7D
LTE Band 38	10MHz	16QAM	8M98D7W
LTE Band 38	15MHz	QPSK	13M5G7D
LTE Band 38	15MHz	16QAM	13M5D7W
LTE Band 38	20MHz	QPSK	18M0G7D
LTE Band 38	20MHz	16QAM	18M0D7W

Unless otherwise stated the results shown in this test report refer only to the sample(s) tested and such sample(s) are retained for 90 days only.

除非另有說明，此報告結果僅對測試之樣品負責，同時此樣品僅保留90天。本報告未經本公司書面許可，不可部份複製。

This document is issued by the Company subject to its General Conditions of Service printed overleaf, available on request or accessible at [www.sgs.com/terms\\_and\\_conditions.htm](http://www.sgs.com/terms_and_conditions.htm) and, for electronic format documents, subject to Terms and Conditions for Electronic Documents at [www.sgs.com/terms\\_e-document.htm](http://www.sgs.com/terms_e-document.htm). Attention is drawn to the limitation of liability, indemnification and jurisdiction issues defined therein. Any holder of this document is advised that information contained hereon reflects the Company's findings at the time of its intervention only and within the limits of Client's instructions, if any. The Company's sole responsibility is to its Client and this document does not exonerate parties to a transaction from exercising all their rights and obligations under the transaction documents. This document cannot be reproduced except in full, without prior written approval of the Company. Any unauthorized alteration, forgery or falsification of the content or appearance of this document is unlawful and offenders may be prosecuted to the fullest extent of the law.

SGS Taiwan Ltd.

No.134,WuKungRoad,NewTaipeiIndustrialPark,WukuDistrict,NewTaipeiCity,Taiwan24803/新北市五股區新北產業園區五工路 134 號

台灣檢驗科技股份有限公司

t (886-2) 2299-3279

f (886-2) 2298-0488

www.tw.sgs.com

Member of SGS Group



**Max ERP/EIRP Power Measurement Result:**

	<b>dBm</b>		<b>W</b>
GSM 850	<b>15.65</b>	ERP	0.037
GPRS 850	<b>19.15</b>	ERP	0.082
EDGE 850	<b>16.95</b>	ERP	0.050
GSM 1900	<b>22.44</b>	EIRP	0.175
GPRS 1900	<b>26.29</b>	EIRP	0.426
EDGE 1900	<b>24.72</b>	EIRP	0.296
WCDMA Band II	<b>21.53</b>	EIRP	0.142
HSDPA Band II	<b>25.33</b>	EIRP	0.341
HSUPA Band II	<b>23.08</b>	EIRP	0.203
WCDMA Band IV	<b>21.52</b>	EIRP	0.142
HSDPA Band IV	<b>24.31</b>	EIRP	0.270
HSUPA Band IV	<b>22.83</b>	EIRP	0.192
WCDMA Band V	<b>10.72</b>	ERP	0.012
HSDPA Band V	<b>12.44</b>	ERP	0.018
HSUPA Band V	<b>11.71</b>	ERP	0.015
LTE-Band 2 (Bandwidth 1.4MHz) QPSK	<b>18.87</b>	EIRP	0.077
LTE-Band 2 (Bandwidth 1.4MHz) 16QAM	<b>19.06</b>	EIRP	0.081
LTE-Band 2 (Bandwidth 3MHz) QPSK	<b>19.23</b>	EIRP	0.084
LTE-Band 2 (Bandwidth 3MHz) 16QAM	<b>19.33</b>	EIRP	0.086
LTE-Band 2 (Bandwidth 5MHz) QPSK	<b>19.17</b>	EIRP	0.083
LTE-Band 2 (Bandwidth 5MHz) 16QAM	<b>19.18</b>	EIRP	0.083
LTE-Band 2 (Bandwidth 10MHz) QPSK	<b>19.63</b>	EIRP	0.092
LTE-Band 2 (Bandwidth 10MHz) 16QAM	<b>19.01</b>	EIRP	0.080
LTE-Band 2 (Bandwidth 15MHz) QPSK	<b>19.34</b>	EIRP	0.086
LTE-Band 2 (Bandwidth 15MHz) 16QAM	<b>19.62</b>	EIRP	0.092
LTE-Band 2 (Bandwidth 20MHz) QPSK	<b>19.60</b>	EIRP	0.091
LTE-Band 2 (Bandwidth 20MHz) 16QAM	<b>19.55</b>	EIRP	0.090
LTE-Band 4 (Bandwidth 1.4MHz) QPSK	<b>18.87</b>	EIRP	0.077
LTE-Band 4 (Bandwidth 1.4MHz) 16QAM	<b>19.06</b>	EIRP	0.081
LTE-Band 4 (Bandwidth 3MHz) QPSK	<b>19.23</b>	EIRP	0.084
LTE-Band 4 (Bandwidth 3MHz) 16QAM	<b>19.33</b>	EIRP	0.086
LTE-Band 4 (Bandwidth 5MHz) QPSK	<b>19.17</b>	EIRP	0.083
LTE-Band 4 (Bandwidth 5MHz) 16QAM	<b>19.18</b>	EIRP	0.083
LTE-Band 4 (Bandwidth 10MHz) QPSK	<b>19.63</b>	EIRP	0.092
LTE-Band 4 (Bandwidth 10MHz) 16QAM	<b>19.01</b>	EIRP	0.080
LTE-Band 4 (Bandwidth 15MHz) QPSK	<b>19.34</b>	EIRP	0.086
LTE-Band 4 (Bandwidth 15MHz) 16QAM	<b>19.62</b>	EIRP	0.092
LTE-Band 4 (Bandwidth 20MHz) QPSK	<b>19.60</b>	EIRP	0.091
LTE-Band 4 (Bandwidth 20MHz) 16QAM	<b>19.55</b>	EIRP	0.090

Unless otherwise stated the results shown in this test report refer only to the sample(s) tested and such sample(s) are retained for 90 days only.

除非另有說明，此報告結果僅對測試之樣品負責，同時此樣品僅保留90天。本報告未經本公司書面許可，不可部份複製。

This document is issued by the Company subject to its General Conditions of Service printed overleaf, available on request or accessible at [www.sgs.com/terms\\_and\\_conditions.htm](http://www.sgs.com/terms_and_conditions.htm) and, for electronic format documents, subject to Terms and Conditions for Electronic Documents at [www.sgs.com/terms\\_e-document.htm](http://www.sgs.com/terms_e-document.htm). Attention is drawn to the limitation of liability, indemnification and jurisdiction issues defined therein. Any holder of this document is advised that information contained hereon reflects the Company's findings at the time of its intervention only and within the limits of Client's instructions, if any. The Company's sole responsibility is to its Client and this document does not exonerate parties to a transaction from exercising all their rights and obligations under the transaction documents. This document cannot be reproduced except in full, without prior written approval of the Company. Any unauthorized alteration, forgery or falsification of the content or appearance of this document is unlawful and offenders may be prosecuted to the fullest extent of the law.

SGS Taiwan Ltd.

No.134,WuKungRoad,NewTaipeiIndustrialPark,WukuDistrict,NewTaipeiCity,Taiwan24803/新北市五股區新北產業園區五工路 134 號

台灣檢驗科技股份有限公司

t (886-2) 2299-3279

f (886-2) 2298-0488

www.tw.sgs.com

Member of SGS Group

	<b>dBm</b>		<b>W</b>
LTE-Band 7 (Bandwidth 5MHz) QPSK	<b>22.11</b>	EIRP	0.163
LTE-Band 7 (Bandwidth 5MHz) 16QAM	<b>21.98</b>	EIRP	0.158
LTE-Band 7 (Bandwidth 10MHz) QPSK	<b>22.52</b>	EIRP	0.179
LTE-Band 7 (Bandwidth 10MHz) 16QAM	<b>22.44</b>	EIRP	0.175
LTE-Band 7 (Bandwidth 15MHz) QPSK	<b>22.36</b>	EIRP	0.172
LTE-Band 7 (Bandwidth 15MHz) 16QAM	<b>22.80</b>	EIRP	0.191
LTE-Band 7 (Bandwidth 20MHz) QPSK	<b>22.60</b>	EIRP	0.182
LTE-Band 7 (Bandwidth 20MHz) 16QAM	<b>22.11</b>	EIRP	0.163
LTE-Band 12 (Bandwidth 1.4MHz) QPSK	<b>14.97</b>	ERP	0.031
LTE-Band 12 (Bandwidth 1.4MHz) 16QAM	<b>14.77</b>	ERP	0.030
LTE-Band 12 (Bandwidth 3MHz) QPSK	<b>15.12</b>	ERP	0.033
LTE-Band 12 (Bandwidth 3MHz) 16QAM	<b>14.75</b>	ERP	0.030
LTE-Band 12 (Bandwidth 5MHz) QPSK	<b>14.70</b>	ERP	0.030
LTE-Band 12 (Bandwidth 5MHz) 16QAM	<b>14.56</b>	ERP	0.029
LTE-Band 12 (Bandwidth 10MHz) QPSK	<b>14.88</b>	ERP	0.031
LTE-Band 12 (Bandwidth 10MHz) 16QAM	<b>14.70</b>	ERP	0.030
LTE-Band 17 (Bandwidth 5MHz) QPSK	<b>16.44</b>	ERP	0.044
LTE-Band 17 (Bandwidth 5MHz) 16QAM	<b>16.51</b>	ERP	0.045
LTE-Band 17 (Bandwidth 10MHz) QPSK	<b>16.00</b>	ERP	0.040
LTE-Band 17 (Bandwidth 10MHz) 16QAM	<b>15.60</b>	ERP	0.036
LTE-Band 38 (Bandwidth 5MHz) QPSK	<b>28.36</b>	EIRP	0.685
LTE-Band 38 (Bandwidth 5MHz) 16QAM	<b>27.89</b>	EIRP	0.615
LTE-Band 38 (Bandwidth 10MHz) QPSK	<b>28.39</b>	EIRP	0.690
LTE-Band 38 (Bandwidth 10MHz) 16QAM	<b>27.63</b>	EIRP	0.579
LTE-Band 38 (Bandwidth 15MHz) QPSK	<b>28.02</b>	EIRP	0.634
LTE-Band 38 (Bandwidth 15MHz) 16QAM	<b>27.66</b>	EIRP	0.583
LTE-Band 38 (Bandwidth 20MHz) QPSK	<b>26.58</b>	EIRP	0.455
LTE-Band 38 (Bandwidth 20MHz) 16QAM	<b>26.35</b>	EIRP	0.432

Unless otherwise stated the results shown in this test report refer only to the sample(s) tested and such sample(s) are retained for 90 days only.

除非另有說明，此報告結果僅對測試之樣品負責，同時此樣品僅保留90天。本報告未經本公司書面許可，不可部份複製。

This document is issued by the Company subject to its General Conditions of Service printed overleaf, available on request or accessible at [www.sgs.com/terms\\_and\\_conditions.htm](http://www.sgs.com/terms_and_conditions.htm) and, for electronic format documents, subject to Terms and Conditions for Electronic Documents at [www.sgs.com/terms\\_e-document.htm](http://www.sgs.com/terms_e-document.htm). Attention is drawn to the limitation of liability, indemnification and jurisdiction issues defined therein. Any holder of this document is advised that information contained hereon reflects the Company's findings at the time of its intervention only and within the limits of Client's instructions, if any. The Company's sole responsibility is to its Client and this document does not exonerate parties to a transaction from exercising all their rights and obligations under the transaction documents. This document cannot be reproduced except in full, without prior written approval of the Company. Any unauthorized alteration, forgery or falsification of the content or appearance of this document is unlawful and offenders may be prosecuted to the fullest extent of the law.

SGS Taiwan Ltd.

No.134,WuKungRoad,NewTaipeiIndustrialPark,WukuDistrict,NewTaipeiCity,Taiwan24803/新北市五股區新北產業園區五工路 134 號

台灣檢驗科技股份有限公司

t (886-2) 2299-3279

f (886-2) 2298-0488

www.tw.sgs.com

Member of SGS Group

## 1.2. Test Methodology of Applied Standards

FCC 47 CFR Part 2, 22, 24, 27

ANSI / TIA / EIA 603-D-2010

KDB971168 D01 Power Meas license Digital System

KDB941225 of the Output power Procedure of (SAR Measurement Procedures for 3G Devices, WCDMA / HSPA) was used for EUT and Base station setting.

TS 151 010-1 is used to set, and measure the output power.

Note: All test items have been performed and record as per the above standards.

## 1.3. Test Facility

SGS Taiwan Ltd. Electronics & Communication Laboratory No.134, Wu Kung Road, New Taipei Industrial Park, Wuku District, New Taipei City, Taiwan. (TAF code 0513)

FCC Registration Numbers are: 509634

## 1.4. Special Accessories

No special accessories were used during testing.

## 1.5. Equipment Modifications

There were no modifications incorporated into the EUT.

## 1.6. Referencing test data across separate equipment authorization

The test data in PCE test report (ER/2017/ 60078) under original FCC ID: 2AJOTTA-1035 are **fully** referred for the FCC ID: 2AJOTTA-1023 in this test report.

Unless otherwise stated the results shown in this test report refer only to the sample(s) tested and such sample(s) are retained for 90 days only.

除非另有說明，此報告結果僅對測試之樣品負責，同時此樣品僅保留90天。本報告未經本公司書面許可，不可部份複製。

This document is issued by the Company subject to its General Conditions of Service printed overleaf, available on request or accessible at [www.sgs.com/terms\\_and\\_conditions.htm](http://www.sgs.com/terms_and_conditions.htm) and, for electronic format documents, subject to Terms and Conditions for Electronic Documents at [www.sgs.com/terms\\_e-document.htm](http://www.sgs.com/terms_e-document.htm). Attention is drawn to the limitation of liability, indemnification and jurisdiction issues defined therein. Any holder of this document is advised that information contained hereon reflects the Company's findings at the time of its intervention only and within the limits of Client's instructions, if any. The Company's sole responsibility is to its Client and this document does not exonerate parties to a transaction from exercising all their rights and obligations under the transaction documents. This document cannot be reproduced except in full, without prior written approval of the Company. Any unauthorized alteration, forgery or falsification of the content or appearance of this document is unlawful and offenders may be prosecuted to the fullest extent of the law.

SGS Taiwan Ltd.

No.134,WuKungRoad,NewTaipeiIndustrialPark,WukuDistrict,NewTaipeiCity,Taiwan24803/新北市五股區新北產業園區五工路 134 號

台灣檢驗科技股份有限公司

t (886-2) 2299-3279

f (886-2) 2298-0488

[www.tw.sgs.com](http://www.tw.sgs.com)

Member of SGS Group

## 2. SYSTEM TEST CONFIGURATION

### 2.1. EUT Configuration

The EUT configuration for testing is installed on RF field strength measurement to meet the Commissions requirement and operating in a manner which intends to maximize its emission characteristics in a continuous normal application.

### 2.2. EUT Exercise

The EUT (Transmitter) was operated in the continuous transmission mode employed with the simulator of the Base Station that fixates at test default channels to fix the Tx frequency which was for the purpose of the measurements.

### 2.3. Test Procedure

#### 2.3.1 Conducted Measurement at Antenna Port

According to measurement procured TIA/EIA 603C, the EUT is placed on a turn table which is 0.8 m above ground plane. A low loss of RF cable was used to connect the antenna port of EUT to measurement equipment.

#### 2.3.2 Radiated Emissions (ERP/EIRP)

According to measurement procured TIA/EIA 603C, The EUT is a placed on as turn table which is 0.8 m above ground plane. The turn table shall rotate 360 degrees to determine the position of maximum emission level. EUT is set 3m away from the receiving antenna which varied from 1m to 4m to find out the highest emission. And also, each emission was to be maximized by changing the polarization of receiving antenna both Horizontal and Vertical. In order to find out the max. emission, the relative positions of this hand-held transmitter (EUT) was rotated through three orthogonal axes and measurement procedures for electric field radiated emissions above 1 GHz the EUT measurement is to be made "while keeping the antenna in the 'cone of radiation' from that area and pointed at the area both in azimuth and elevation, with polarization oriented for maximum response." is still within the 3dB illumination BW of the measurement antenna according to the requirements in Section 8 and 13.

Unless otherwise stated the results shown in this test report refer only to the sample(s) tested and such sample(s) are retained for 90 days only.

除非另有說明，此報告結果僅對測試之樣品負責，同時此樣品僅保留90天。本報告未經本公司書面許可，不可部份複製。

This document is issued by the Company subject to its General Conditions of Service printed overleaf, available on request or accessible at [www.sgs.com/terms\\_and\\_conditions.htm](http://www.sgs.com/terms_and_conditions.htm) and, for electronic format documents, subject to Terms and Conditions for Electronic Documents at [www.sgs.com/terms\\_e-document.htm](http://www.sgs.com/terms_e-document.htm). Attention is drawn to the limitation of liability, indemnification and jurisdiction issues defined therein. Any holder of this document is advised that information contained hereon reflects the Company's findings at the time of its intervention only and within the limits of Client's instructions, if any. The Company's sole responsibility is to its Client and this document does not exonerate parties to a transaction from exercising all their rights and obligations under the transaction documents. This document cannot be reproduced except in full, without prior written approval of the Company. Any unauthorized alteration, forgery or falsification of the content or appearance of this document is unlawful and offenders may be prosecuted to the fullest extent of the law.

SGS Taiwan Ltd.

No.134,WuKungRoad,NewTaipeiIndustrialPark,WukuDistrict,NewTaipeiCity,Taiwan24803/新北市五股區新北產業園區五工路 134 號

台灣檢驗科技股份有限公司

t (886-2) 2299-3279

f (886-2) 2298-0488

[www.tw.sgs.com](http://www.tw.sgs.com)

Member of SGS Group

## 2.4. Measurement Results Explanation Example

### For all conducted test items:

The offset level is set in the spectrum analyzer to compensate the RF cable loss and attenuation factor between EUT conducted port and spectrum analyzer. With the offset compensation, the spectrum analyzer reading level is exactly EUT RF output level.

### Note:

The spectrum analyzer offset is derived from RF cable loss and attenuator factor.

Following shows an offset computation example with cable loss 1 dB for low band and 1 for high band with 10 dB attenuator and 3.2 splitter.

Low Band: Offset = RF cable loss (dB) + attenuation factor(dB) =3.8+10=13.8(dB)

High Band: Offset = RF cable loss (dB) + attenuation factor(dB) =4+10=14(dB)

## 2.5. Final Amplifier Voltage and Current Information:

Test mode	DC voltage (V)	DC current (mA)
GSM 850	3.8	316
GSM 1900	3.8	206
GPRS 850	3.8	325
GPRS 1900	3.8	222
EDGE 850	3.8	337
EDGE 1900	3.8	207
WCDMA B2	3.8	332
WCDMA B4	3.8	206
WCDMA B5	3.8	325
HSUPA B2	3.8	226
HSUPA B4	3.8	343
HSUPA B5	3.8	231
HSDPA B2	3.8	333
HSDPA B4	3.8	239
HSDPA B5	3.8	348

### LTE Band 2

Test mode	DC voltage (V)	DC current (mA)
LTE Band 2_1.4M QPSK	3.8	729
LTE Band 2_1.4M 16QAM	3.8	641
LTE Band 2_3M QPSK	3.8	736
LTE Band 2_3M 16QAM	3.8	658
LTE Band 2_5M QPSK	3.8	736
LTE Band 2_5M 16QAM	3.8	664
LTE Band 2_10M QPSK	3.8	720
LTE Band 2_10M 16QAM	3.8	651
LTE Band 2_15M QPSK	3.8	732
LTE Band 2_15M 16QAM	3.8	660
LTE Band 2_20M QPSK	3.8	708
LTE Band 2_20M 16QAM	3.8	640

Unless otherwise stated the results shown in this test report refer only to the sample(s) tested and such sample(s) are retained for 90 days only.

除非另有說明，此報告結果僅對測試之樣品負責，同時此樣品僅保留90天。本報告未經本公司書面許可，不可部份複製。

This document is issued by the Company subject to its General Conditions of Service printed overleaf, available on request or accessible at [www.sgs.com/terms\\_and\\_conditions.htm](http://www.sgs.com/terms_and_conditions.htm) and, for electronic format documents, subject to Terms and Conditions for Electronic Documents at [www.sgs.com/terms\\_e-document.htm](http://www.sgs.com/terms_e-document.htm). Attention is drawn to the limitation of liability, indemnification and jurisdiction issues defined therein. Any holder of this document is advised that information contained hereon reflects the Company's findings at the time of its intervention only and within the limits of Client's instructions, if any. The Company's sole responsibility is to its Client and this document does not exonerate parties to a transaction from exercising all their rights and obligations under the transaction documents. This document cannot be reproduced except in full, without prior written approval of the Company. Any unauthorized alteration, forgery or falsification of the content or appearance of this document is unlawful and offenders may be prosecuted to the fullest extent of the law.

SGS Taiwan Ltd.

No.134,WuKungRoad,NewTaipeiIndustrialPark,WukuDistrict,NewTaipeiCity,Taiwan24803/新北市五股區新北產業園區五工路 134 號

台灣檢驗科技股份有限公司

t (886-2) 2299-3279

f (886-2) 2298-0488

www.tw.sgs.com

Member of SGS Group

#### LTE Band 4

Test mode	DC voltage (V)	DC current (mA)
LTE Band 4_1.4M QPSK	3.8	656
LTE Band 4_1.4M 16QAM	3.8	605
LTE Band 4_3M QPSK	3.8	660
LTE Band 4_3M 16QAM	3.8	615
LTE Band 4_5M QPSK	3.8	641
LTE Band 4_5M 16QAM	3.8	588
LTE Band 4_10M QPSK	3.8	639
LTE Band 4_10M 16QAM	3.8	608
LTE Band 4_15M QPSK	3.8	628
LTE Band 4_15M 16QAM	3.8	579
LTE Band 4_20M QPSK	3.8	635
LTE Band 4_20M 16QAM	3.8	594

#### LTE Band 7

Test mode	DC voltage (V)	DC current (mA)
LTE Band 7_5M QPSK	3.8	732
LTE Band 7_5M 16QAM	3.8	655
LTE Band 7_10M QPSK	3.8	741
LTE Band 7_10M 16QAM	3.8	633
LTE Band 7_15M QPSK	3.8	771
LTE Band 7_15M 16QAM	3.8	665
LTE Band 7_20M QPSK	3.8	711
LTE Band 7_20M 16QAM	3.8	671

#### LTE Band 12

Test mode	DC voltage (V)	DC current (mA)
LTE Band 12_1.4M QPSK	3.8	462
LTE Band 12_1.4M 16QAM	3.8	431
LTE Band 12_3M QPSK	3.8	486
LTE Band 12_3M 16QAM	3.8	448
LTE Band 12_5M QPSK	3.8	474
LTE Band 12_5M 16QAM	3.8	444
LTE Band 12_10M QPSK	3.8	458
LTE Band 12_10M 16QAM	3.8	419

#### LTE Band 17

Test mode	DC voltage (V)	DC current (mA)
LTE Band 17_5M QPSK	3.8	28
LTE Band 17_5M 16QAM	3.8	402
LTE Band 17_10M QPSK	3.8	449
LTE Band 17_10M 16QAM	3.8	414

#### LTE Band 38

Test mode	DC voltage (V)	DC current (mA)
LTE Band 38_5M QPSK	3.8	349
LTE Band 38_5M 16QAM	3.8	301
LTE Band 38_10M QPSK	3.8	322
LTE Band 38_10M 16QAM	3.8	289
LTE Band 38_15M QPSK	3.8	311
LTE Band 38_15M 16QAM	3.8	294
LTE Band 38_20M QPSK	3.8	317
LTE Band 38_20M 16QAM	3.8	288

Unless otherwise stated the results shown in this test report refer only to the sample(s) tested and such sample(s) are retained for 90 days only.

除非另有說明，此報告結果僅對測試之樣品負責，同時此樣品僅保留90天。本報告未經本公司書面許可，不可部份複製。

This document is issued by the Company subject to its General Conditions of Service printed overleaf, available on request or accessible at [www.sgs.com/terms\\_and\\_conditions.htm](http://www.sgs.com/terms_and_conditions.htm) and, for electronic format documents, subject to Terms and Conditions for Electronic Documents at [www.sgs.com/terms\\_e-document.htm](http://www.sgs.com/terms_e-document.htm). Attention is drawn to the limitation of liability, indemnification and jurisdiction issues defined therein. Any holder of this document is advised that information contained hereon reflects the Company's findings at the time of its intervention only and within the limits of Client's instructions, if any. The Company's sole responsibility is to its Client and this document does not exonerate parties to a transaction from exercising all their rights and obligations under the transaction documents. This document cannot be reproduced except in full, without prior written approval of the Company. Any unauthorized alteration, forgery or falsification of the content or appearance of this document is unlawful and offenders may be prosecuted to the fullest extent of the law.

## 2.6. Configuration of Tested System

**Fig. 2-1 Configuration of Tested System (Fixed Channel-Conducted)**

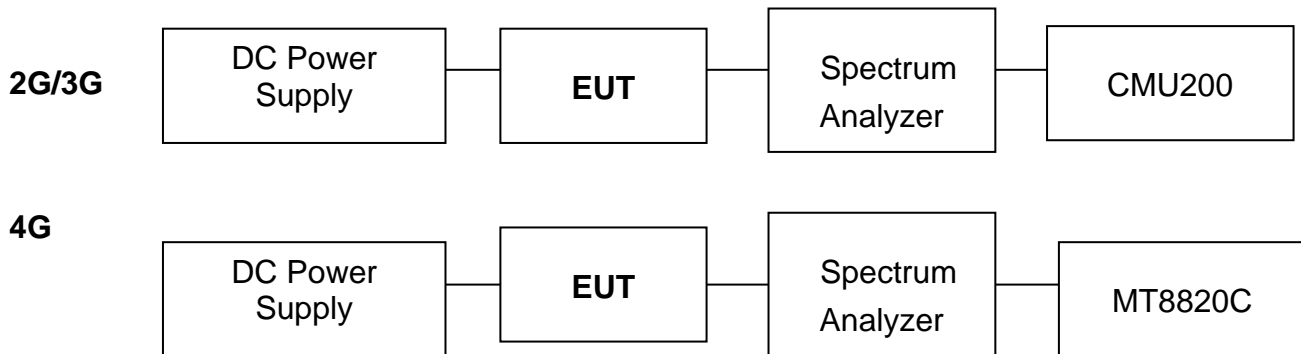

**Fig. 2-2 Configuration of Tested System (Fixed Channel-Radiated)**

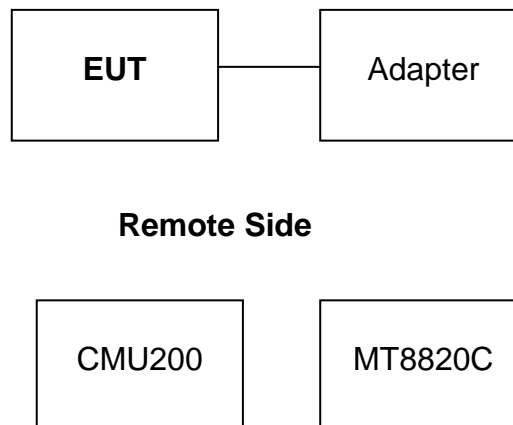

**Table 2-1 Equipment Used in**

Item	Equipment	Mfr/Brand	Model/ Type No.	Series No.	Data Cable	Power Cord
1.	Universal Radio Communication Tester	R&S	CMU200	102189	shielded	Un-shielded
2.	Universal Radio Communication Tester	Anritsu	MT8820C	6200307563	shielded	Un-shielded

Unless otherwise stated the results shown in this test report refer only to the sample(s) tested and such sample(s) are retained for 90 days only.

除非另有說明，此報告結果僅對測試之樣品負責，同時此樣品僅保留90天。本報告未經本公司書面許可，不可部份複製。

This document is issued by the Company subject to its General Conditions of Service printed overleaf, available on request or accessible at [www.sgs.com/terms\\_and\\_conditions.htm](http://www.sgs.com/terms_and_conditions.htm) and, for electronic format documents, subject to Terms and Conditions for Electronic Documents at [www.sgs.com/terms\\_e-document.htm](http://www.sgs.com/terms_e-document.htm). Attention is drawn to the limitation of liability, indemnification and jurisdiction issues defined therein. Any holder of this document is advised that information contained hereon reflects the Company's findings at the time of its intervention only and within the limits of Client's instructions, if any. The Company's sole responsibility is to its Client and this document does not exonerate parties to a transaction from exercising all their rights and obligations under the transaction documents. This document cannot be reproduced except in full, without prior written approval of the Company. Any unauthorized alteration, forgery or falsification of the content or appearance of this document is unlawful and offenders may be prosecuted to the fullest extent of the law.

SGS Taiwan Ltd.

No.134,WuKungRoad,NewTaipeiIndustrialPark,WukuDistrict,NewTaipeiCity,Taiwan24803/新北市五股區新北產業園區五工路 134 號

台灣檢驗科技股份有限公司

t (886-2) 2299-3279

f (886-2) 2298-0488

[www.tw.sgs.com](http://www.tw.sgs.com)

Member of SGS Group



### 3. SUMMARY OF TEST RESULTS

FCC Rules	Description Of Test	Result
§2.1046	RF Power Output	Compliant
§2.1046(a) §22.913(a)(5) §24.232(c) §27.50(c)(9)(10) §27.50(d)(4) §27.50(h)(2)	ERP/ EIRP measurement	Compliant
§2.1049(h)	99% & 26dB Occupied Bandwidth	Compliant
§2.1051 §22.917(a) §24.238(a) §27.53(g) §27.53(h) §27.53(m)(4)(6)	Out of Band Emissions at Antenna Terminals and Band Edge / Emission mask requirements	Compliant
§2.1053 §22.917(a) §24.238(a) §27.53(g) §27.53(h) §27.53(m)	Field Strength of Spurious Radiation	Compliant
§24.232(d) §27.50(b)	Peak to Average Ratio	Compliant
§2.1055(a)(1) §22.355 §24.235 §27.54	Frequency Stability	Compliant

Unless otherwise stated the results shown in this test report refer only to the sample(s) tested and such sample(s) are retained for 90 days only.

除非另有說明，此報告結果僅對測試之樣品負責，同時此樣品僅保留90天。本報告未經本公司書面許可，不可部份複製。

This document is issued by the Company subject to its General Conditions of Service printed overleaf, available on request or accessible at [www.sgs.com/terms\\_and\\_conditions.htm](http://www.sgs.com/terms_and_conditions.htm) and, for electronic format documents, subject to Terms and Conditions for Electronic Documents at [www.sgs.com/terms\\_e-document.htm](http://www.sgs.com/terms_e-document.htm). Attention is drawn to the limitation of liability, indemnification and jurisdiction issues defined therein. Any holder of this document is advised that information contained hereon reflects the Company's findings at the time of its intervention only and within the limits of Client's instructions, if any. The Company's sole responsibility is to its Client and this document does not exonerate parties to a transaction from exercising all their rights and obligations under the transaction documents. This document cannot be reproduced except in full, without prior written approval of the Company. Any unauthorized alteration, forgery or falsification of the content or appearance of this document is unlawful and offenders may be prosecuted to the fullest extent of the law.

SGS Taiwan Ltd.

No.134,WuKungRoad,NewTaipeiIndustrialPark,WukuDistrict,NewTaipeiCity,Taiwan24803/新北市五股區新北產業園區五工路 134 號

台灣檢驗科技股份有限公司

t (886-2) 2299-3279

f (886-2) 2298-0488

[www.tw.sgs.com](http://www.tw.sgs.com)

Member of SGS Group



## 4. DESCRIPTION OF TEST MODES

### 4.1. The Worst Test Modes and Channel Details

1. The EUT has been tested under operating condition.
2. Pre-Scan has been conducted to determine the worst-case mode from all possible combinations between available modulations, data rates, X(E1)Y(E2)Z(H) axis and antenna ports. The worst case was found as listed below. Following channel(s) was (were) selected for the final test as listed below:

BAND	ERP/EIRP	RADIATED EMISSION and Wireless charging Cover
GSM/GPRS/EDGE 850	E2-plan	E2-plan
GSM/GPRS/EDGE 1900	H-plan	H-plan
WCDMA/HSPA Band II	H-plan	H-plan
WCDMA/HSPA Band IV	H-plan	H-plan
WCDMA/HSPA Band V	E2-plan	E2-plan
LTE Band 2	H-plan	H-plan
LTE Band 4	H-plan	H-plan
LTE Band 7	H-plan	H-plan
LTE Band 12	E2-plan	E2-plan
LTE Band 17	E2-plan	E2-plan
LTE Band 38	H-plan	H-plan

Unless otherwise stated the results shown in this test report refer only to the sample(s) tested and such sample(s) are retained for 90 days only.

除非另有說明，此報告結果僅對測試之樣品負責，同時此樣品僅保留90天。本報告未經本公司書面許可，不可部份複製。

This document is issued by the Company subject to its General Conditions of Service printed overleaf, available on request or accessible at [www.sgs.com/terms\\_and\\_conditions.htm](http://www.sgs.com/terms_and_conditions.htm) and, for electronic format documents, subject to Terms and Conditions for Electronic Documents at [www.sgs.com/terms\\_e-document.htm](http://www.sgs.com/terms_e-document.htm). Attention is drawn to the limitation of liability, indemnification and jurisdiction issues defined therein. Any holder of this document is advised that information contained hereon reflects the Company's findings at the time of its intervention only and within the limits of Client's instructions, if any. The Company's sole responsibility is to its Client and this document does not exonerate parties to a transaction from exercising all their rights and obligations under the transaction documents. This document cannot be reproduced except in full, without prior written approval of the Company. Any unauthorized alteration, forgery or falsification of the content or appearance of this document is unlawful and offenders may be prosecuted to the fullest extent of the law.

SGS Taiwan Ltd.

No.134,WuKungRoad,NewTaipeiIndustrialPark,WukuDistrict,NewTaipeiCity,Taiwan24803/新北市五股區新北產業園區五工路 134 號

台灣檢驗科技股份有限公司

t (886-2) 2299-3279

f (886-2) 2298-0488

[www.tw.sgs.com](http://www.tw.sgs.com)

Member of SGS Group

GSM/GPRS/EDGE MODE

TEST ITEM	AVAILABLE CHANNEL	TESTED CHANNEL	MODE
ERP	128 to 251	128, 190, 251	GSM/GPRS/EDGE 850
EIRP	512 to 810	512, 661, 810	GSM/GPRS/EDGE 1900
FREQUENCY STABILITY	128 to 251 512 to 810	190 661	GPRS 850 GPRS 1900
OCCUPIED BANDWIDTH	128 to 251 512 to 810	190 661	GSM/GPRS/EDGE 850 GSM/GPRS/EDGE 1900
PEAK TO AVERAGE RATIO	128 to 251 512 to 810	128, 190, 251 512, 661, 810	GSM/GPRS/EDGE 850 GSM/GPRS/EDGE 1900
BAND EDGE	128 to 251 512 to 810	128, 251 512, 810	GSM/GPRS/EDGE 850 GSM/GPRS/EDGE 1900
CONDCUDED EMISSION	128 to 251 512 to 810	128, 190, 251 512, 661, 810	GSM/GPRS/EDGE 850 GSM/GPRS/EDGE 1900
RADIATED EMISSION	128 to 251 512 to 810	128, 190, 251 512, 661, 810	GSM 850 GPRS 1900

WCDMA/HSPA MODE

TEST ITEM	AVAILABLE CHANNEL	TESTED CHANNEL	MODE
ERP	4132 to 4233	4132, 4183, 4233	WCDMA/HSPA Band V
EIRP	9262 to 9538 1312 to 1513	9262, 9400, 9583 1312, 1413, 1513	WCDMA/HSPA Band II WCDMA/HSPA Band IV
FREQUENCY STABILITY	4132 to 4233 1312 to 1513 9262 to 9538	4183 1413 9400	WCDMA Band II WCDMA Band IV WCDMA Band V
OCCUPIED BANDWIDTH	4132 to 4233 1312 to 1513 9262 to 9538	4132, 4183, 4233 1312, 1413, 1513 9262, 9400, 9583	WCDMA/HSPA Band II WCDMA/HSPA Band IV WCDMA/HSPA Band V
PEAK TO AVERAGE RATIO	4132 to 4233 1312 to 1513 9262 to 9538	4132, 4183, 4233 1312, 1413, 1513 9262, 9400, 9583	WCDMA/HSPA Band II WCDMA/HSPA Band IV WCDMA/HSPA Band V
BAND EDGE	4132 to 4233 1312 to 1513 9262 to 9538	4132, 4233 1312, 1513 9262, 9583	WCDMA Band II WCDMA Band IV WCDMA Band V
CONDCUDED EMISSION	4132 to 4233 1312 to 1513 9262 to 9538	4132, 4183, 4233 1312, 1413, 1513 9262, 9400, 9583	WCDMA Band II WCDMA Band IV WCDMA Band V
RADIATED EMISSION	4132 to 4233 1312 to 1513 9262 to 9538	4132, 4183, 4233 1312, 1413, 1513 9262, 9400, 9583	HSDPA Band II HSUPA Band IV WCDMA Band V

Unless otherwise stated the results shown in this test report refer only to the sample(s) tested and such sample(s) are retained for 90 days only.

除非另有說明，此報告結果僅對測試之樣品負責，同時此樣品僅保留90天。本報告未經本公司書面許可，不可部份複製。

This document is issued by the Company subject to its General Conditions of Service printed overleaf, available on request or accessible at [www.sgs.com/terms\\_and\\_conditions.htm](http://www.sgs.com/terms_and_conditions.htm) and, for electronic format documents, subject to Terms and Conditions for Electronic Documents at [www.sgs.com/terms\\_e-document.htm](http://www.sgs.com/terms_e-document.htm). Attention is drawn to the limitation of liability, indemnification and jurisdiction issues defined therein. Any holder of this document is advised that information contained hereon reflects the Company's findings at the time of its intervention only and within the limits of Client's instructions, if any. The Company's sole responsibility is to its Client and this document does not exonerate parties to a transaction from exercising all their rights and obligations under the transaction documents. This document cannot be reproduced except in full, without prior written approval of the Company. Any unauthorized alteration, forgery or falsification of the content or appearance of this document is unlawful and offenders may be prosecuted to the fullest extent of the law.

**LTE Band 2 MODE**

TEST ITEM	AVAILABLE CHANNEL	TESTED CHANNEL	CHANNEL BANDWIDTH	MODULATION	MODE
EIRP	18607 to 19193	18607, 18900, 19193	1.4MHz	QPSK, 16QAM	1 RB/ 0,5 RB Offest
	18615 to 19185	18615, 18900, 19185	3MHz	QPSK, 16QAM	1 RB/ 0,14 RB Offest
	18625 to 19175	18625, 18900, 19175	5MHz	QPSK, 16QAM	1 RB/ 0,24 RB Offest
	18650 to 19150	18650, 18900, 19150	10MHz	QPSK, 16QAM	1 RB/ 0,49 RB Offest
	18675 to 19125	18675, 18900, 19125	15MHz	QPSK, 16QAM	1 RB/ 0,74 RB Offest
	18700 to 19100	18700, 18900, 19100	20MHz	QPSK, 16QAM	1 RB/ 0,99 RB Offest
FREQUENCY STABILITY	18650 to 19150	18900	10MHz	QPSK,	Full RB
OCCUPIED BANDWIDTH	18607 to 19193	18607, 18900, 19193	1.4MHz	QPSK, 16QAM	Full RB
	18615 to 19185	18615, 18900, 19185	3MHz	QPSK, 16QAM	Full RB
	18625 to 19175	18625, 18900, 19175	5MHz	QPSK, 16QAM	Full RB
	18650 to 19150	18650, 18900, 19150	10MHz	QPSK, 16QAM	Full RB
	18675 to 19125	18675, 18900, 19125	15MHz	QPSK, 16QAM	Full RB
	18700 to 19100	18700, 18900, 19100	20MHz	QPSK, 16QAM	Full RB
PEAK TO AVERAGE RATIO	18607 to 19193	18607, 18900, 19193	1.4MHz	16QAM	Full RB
	18615 to 19185	18615, 18900, 19185	3MHz	16QAM	Full RB
	18625 to 19175	18625, 18900, 19175	5MHz	16QAM	Full RB
	18650 to 19150	18650, 18900, 19150	10MHz	16QAM	Full RB
	18675 to 19125	18675, 18900, 19125	15MHz	16QAM	Full RB
	18700 to 19100	18700, 18900, 19100	20MHz	16QAM	Full RB
BAND EDGE	18607 to 19193	18607, 19193	1.4MHz	QPSK,	1 RB/ 0,5 RB Offes Full RB
	18615 to 19185	18615, 19185	3MHz	QPSK,	1 RB/ 0,14 RB Offest Full RB
	18625 to 19175	18625, 19175	5MHz	QPSK,	1 RB/ 0,24 RB Offest Full RB
	18650 to 19150	18650, 19150	10MHz	QPSK,	1 RB/ 0,49 RB Offest Full RB
	18675 to 19125	18675, 19125	15MHz	QPSK,	1 RB/ 0,74 RB Offest Full RB
	18700 to 19100	18700, 19100	20MHz	QPSK,	1 RB/ 0,99 RB Offest Full RB
CONDCUDED EMISSION	18607 to 19193	18607, 18900, 19193	1.4MHz	QPSK,	1 RB, 0 RB Offest
	18615 to 19185	18615, 18900, 19185	3MHz	QPSK,	1 RB, 0 RB Offest
	18625 to 19175	18625, 18900, 19175	5MHz	QPSK,	1 RB, 0 RB Offest
	18650 to 19150	18650, 18900, 19150	10MHz	QPSK,	1 RB, 0 RB Offest
	18675 to 19125	18675, 18900, 19125	15MHz	QPSK,	1 RB, 0 RB Offest
	18700 to 19100	18700, 18900, 19100	20MHz	QPSK,	1 RB, 0 RB Offest
RADIATED EMISSION	18625 to 19175	18625, 18900, 19175	5MHz	QPSK	1 RB, 0 RB Offest

Unless otherwise stated the results shown in this test report refer only to the sample(s) tested and such sample(s) are retained for 90 days only.

除非另有說明，此報告結果僅對測試之樣品負責，同時此樣品僅保留90天。本報告未經本公司書面許可，不可部份複製。

This document is issued by the Company subject to its General Conditions of Service printed overleaf, available on request or accessible at [www.sgs.com/terms\\_and\\_conditions.htm](http://www.sgs.com/terms_and_conditions.htm) and, for electronic format documents, subject to Terms and Conditions for Electronic Documents at [www.sgs.com/terms\\_e-document.htm](http://www.sgs.com/terms_e-document.htm). Attention is drawn to the limitation of liability, indemnification and jurisdiction issues defined therein. Any holder of this document is advised that information contained hereon reflects the Company's findings at the time of its intervention only and within the limits of Client's instructions, if any. The Company's sole responsibility is to its Client and this document does not exonerate parties to a transaction from exercising all their rights and obligations under the transaction documents. This document cannot be reproduced except in full, without prior written approval of the Company. Any unauthorized alteration, forgery or falsification of the content or appearance of this document is unlawful and offenders may be prosecuted to the fullest extent of the law.

SGS Taiwan Ltd.

No.134,WuKungRoad,NewTaipeiIndustrialPark,WukuDistrict,NewTaipeiCity,Taiwan24803/新北市五股區新北產業園區五工路 134 號

台灣檢驗科技股份有限公司

t (886-2) 2299-3279

f (886-2) 2298-0488

www.tw.sgs.com

Member of SGS Group

**LTE Band 4 MODE**

TEST ITEM	AVAILABLE CHANNEL	TESTED CHANNEL	CHANNEL BANDWIDTH	MODULATION	MODE
EIRP	19957 to 19393	19957, 20175, 19393	1.4MHz	QPSK, 16QAM	1 RB/ 0,5 RB Offest
	19965 to 22385	19965, 20175, 22385	3MHz	QPSK, 16QAM	1 RB/ 0,14 RB Offest
	19975 to 20375	19975, 20175, 20375	5MHz	QPSK, 16QAM	1 RB/ 0,24 RB Offest
	20000 to 20350	20000, 20175, 20350	10MHz	QPSK, 16QAM	1 RB/ 0,49 RB Offest
	20025 to 20325	20025, 20175, 20325	15MHz	QPSK, 16QAM	1 RB/ 0,74 RB Offest
	20050 to 20300	20050, 20175, 20300	20MHz	QPSK, 16QAM	1 RB/ 0,99 RB Offest
FREQUENCY STABILITY	20000 to 20350	20175	10MHz	QPSK,	Full RB
OCCUPIED BANDWIDTH	19957 to 19393	19957, 20175, 19393	1.4MHz	QPSK, 16QAM	Full RB
	19965 to 22385	19965, 20175, 22385	3MHz	QPSK, 16QAM	Full RB
	19975 to 20375	19975, 20175, 20375	5MHz	QPSK, 16QAM	Full RB
	20000 to 20350	20000, 20175, 20350	10MHz	QPSK, 16QAM	Full RB
	20025 to 20325	20025, 20175, 20325	15MHz	QPSK, 16QAM	Full RB
	20050 to 20300	20050, 20175, 20300	20MHz	QPSK, 16QAM	Full RB
PEAK TO AVERAGE RATIO	19957 to 19393	19957, 20175, 19393	1.4MHz	16QAM	Full RB
	19965 to 22385	19965, 20175, 22385	3MHz	16QAM	Full RB
	19975 to 20375	19975, 20175, 20375	5MHz	16QAM	Full RB
	20000 to 20350	20000, 20175, 20350	10MHz	16QAM	Full RB
	20025 to 20325	20025, 20175, 20325	15MHz	16QAM	Full RB
	20050 to 20300	20050, 20175, 20300	20MHz	16QAM	Full RB
BAND EDGE	19957 to 19393	19957, 19393	1.4MHz	QPSK,	1 RB/ 0,5 RB Offes Full RB
	19965 to 22385	19965, 22385	3MHz	QPSK,	1 RB/ 0,14 RB Offest Full RB
	19975 to 20375	19975, 20375	5MHz	QPSK,	1 RB/ 0,24 RB Offest Full RB
	20000 to 20350	20000, 20350	10MHz	QPSK,	1 RB/ 0,49 RB Offest Full RB
	20025 to 20325	20025, 20325	15MHz	QPSK,	1 RB/ 0,74 RB Offest Full RB
	20050 to 20300	20050, 20300	20MHz	QPSK,	1 RB/ 0,99 RB Offest Full RB
CONDCUDED EMISSION	19957 to 19393	19957, 20175, 19393	1.4MHz	QPSK,	1 RB, 0 RB Offest
	19965 to 22385	19965, 20175, 22385	3MHz	QPSK,	1 RB, 0 RB Offest
	19975 to 20375	19975, 20175, 20375	5MHz	QPSK,	1 RB, 0 RB Offest
	20000 to 20350	20000, 20175, 20350	10MHz	QPSK,	1 RB, 0 RB Offest
	20025 to 20325	20025, 20175, 20325	15MHz	QPSK,	1 RB, 0 RB Offest
	20050 to 20300	20050, 20175, 20300	20MHz	QPSK,	1 RB, 0 RB Offest
RADIATED EMISSION	19965 to 22385	19965, 20175, 22385	3MHz	16QAM,	1 RB, 0 RB Offest

Unless otherwise stated the results shown in this test report refer only to the sample(s) tested and such sample(s) are retained for 90 days only.

除非另有說明，此報告結果僅對測試之樣品負責，同時此樣品僅保留90天。本報告未經本公司書面許可，不可部份複製。

This document is issued by the Company subject to its General Conditions of Service printed overleaf, available on request or accessible at [www.sgs.com/terms\\_and\\_conditions.htm](http://www.sgs.com/terms_and_conditions.htm) and, for electronic format documents, subject to Terms and Conditions for Electronic Documents at [www.sgs.com/terms\\_e-document.htm](http://www.sgs.com/terms_e-document.htm). Attention is drawn to the limitation of liability, indemnification and jurisdiction issues defined therein. Any holder of this document is advised that information contained hereon reflects the Company's findings at the time of its intervention only and within the limits of Client's instructions, if any. The Company's sole responsibility is to its Client and this document does not exonerate parties to a transaction from exercising all their rights and obligations under the transaction documents. This document cannot be reproduced except in full, without prior written approval of the Company. Any unauthorized alteration, forgery or falsification of the content or appearance of this document is unlawful and offenders may be prosecuted to the fullest extent of the law.

SGS Taiwan Ltd.

No.134,WuKungRoad,NewTaipeiIndustrialPark,WukuDistrict,NewTaipeiCity,Taiwan24803/新北市五股區新北產業園區五工路 134 號

台灣檢驗科技股份有限公司

t (886-2) 2299-3279

f (886-2) 2298-0488

www.tw.sgs.com

Member of SGS Group

**LTE Band 7 MODE**

TEST ITEM	AVAILABLE CHANNEL	TESTED CHANNEL	CHANNEL BANDWIDTH	MODULATION	MODE
EIRP	20775 to 21425	20775, 21100, 21425	5MHz	QPSK, 16QAM	1 RB/ 0,24 RB Offest
	20800 to 21400	20800, 21100, 21400	10MHz	QPSK, 16QAM	1 RB/ 0,49 RB Offest
	20850 to 21375	20850, 21100, 21375	15MHz	QPSK, 16QAM	1 RB/ 0,74 RB Offest
	20850 to 21350	20850, 21100, 21350	20MHz	QPSK, 16QAM	1 RB/ 0,99 RB Offest
FREQUENCY STABILITY	20800 to 21400	21100	10MHz	QPSK,	Full RB
OCCUPIED BANDWIDTH	20775 to 21425	20775, 21100, 21425	5MHz	QPSK, 16QAM	Full RB
	20800 to 21400	20800, 21100, 21400	10MHz	QPSK, 16QAM	Full RB
	20850 to 21375	20850, 21100, 21375	15MHz	QPSK, 16QAM	Full RB
	20850 to 21350	20850, 21100, 21350	20MHz	QPSK, 16QAM	Full RB
PEAK TO AVERAGE RATIO	20775 to 21425	20775, 21100, 21425	5MHz	16QAM	Full RB
	20800 to 21400	20800, 21100, 21400	10MHz	16QAM	Full RB
	20850 to 21375	20850, 21100, 21375	15MHz	16QAM	Full RB
	20850 to 21350	20850, 21100, 21350	20MHz	16QAM	Full RB
BAND EDGE	20775 to 21425	20775, 21100, 21425	5MHz	QPSK,	1 RB/ 0,24 RB Offest Full RB
	20800 to 21400	20800, 21100, 21400	10MHz	QPSK,	1 RB/ 0,49 RB Offest Full RB
	20850 to 21375	20850, 21100, 21375	15MHz	QPSK,	1 RB/ 0,74 RB Offest Full RB
	20850 to 21350	20850, 21100, 21350	20MHz	QPSK,	1 RB/ 0,99 RB Offest Full RB
CONDCUDED EMISSION	20775 to 21425	20775, 21100, 21425	5MHz	QPSK,	1 RB, 0 RB Offest
	20800 to 21400	20800, 21100, 21400	10MHz	QPSK,	1 RB, 0 RB Offest
	20850 to 21375	20850, 21100, 21375	15MHz	QPSK,	1 RB, 0 RB Offest
	20850 to 21350	20850, 21100, 21350	20MHz	QPSK,	1 RB, 0 RB Offest
RADIATED EMISSION	20775 to 21425	20775, 21100, 21425	5MHz	QPSK,	1 RB, 0 RB Offest
EMISSION MASK	20775 to 21425	20775, 21100, 21425	5MHz	QPSK,	1 RB/ 0,24 RB Offest 25 RB/ 0 Offset
	20800 to 21400	20800, 21100, 21400	10MHz	QPSK,	1 RB/ 0,49 RB Offest 50 RB/ 0 Offset
	20850 to 21375	20850, 21100, 21375	15MHz	QPSK,	1 RB/ 0,74 RB Offest 75 RB/ 0 Offset
	20850 to 21350	20850, 21100, 21350	20MHz	QPSK,	1 RB/ 0,99 RB Offest 100 RB/ 0 Offset

Unless otherwise stated the results shown in this test report refer only to the sample(s) tested and such sample(s) are retained for 90 days only.

除非另有說明，此報告結果僅對測試之樣品負責，同時此樣品僅保留90天。本報告未經本公司書面許可，不可部份複製。

This document is issued by the Company subject to its General Conditions of Service printed overleaf, available on request or accessible at [www.sgs.com/terms\\_and\\_conditions.htm](http://www.sgs.com/terms_and_conditions.htm) and, for electronic format documents, subject to Terms and Conditions for Electronic Documents at [www.sgs.com/terms\\_e-document.htm](http://www.sgs.com/terms_e-document.htm). Attention is drawn to the limitation of liability, indemnification and jurisdiction issues defined therein. Any holder of this document is advised that information contained hereon reflects the Company's findings at the time of its intervention only and within the limits of Client's instructions, if any. The Company's sole responsibility is to its Client and this document does not exonerate parties to a transaction from exercising all their rights and obligations under the transaction documents. This document cannot be reproduced except in full, without prior written approval of the Company. Any unauthorized alteration, forgery or falsification of the content or appearance of this document is unlawful and offenders may be prosecuted to the fullest extent of the law.

SGS Taiwan Ltd.

No.134,WuKungRoad,NewTaipeiIndustrialPark,WukuDistrict,NewTaipeiCity,Taiwan24803/新北市五股區新北產業園區五工路 134 號

台灣檢驗科技股份有限公司

t (886-2) 2299-3279

f (886-2) 2298-0488

www.tw.sgs.com

Member of SGS Group

**LTE Band 12 MODE**

TEST ITEM	AVAILABLE CHANNEL	TESTED CHANNEL	CHANNEL BANDWIDTH	MODULATION	MODE
ERP	23017 to 23173	23017, 23095, 23173	1.4MHz	QPSK, 16QAM	1 RB/ 0,5 RB Offest
	23025 to 23165	23025, 23095, 23165	3MHz	QPSK, 16QAM	1 RB/ 0,14 RB Offest
	23035 to 23155	23035, 23095, 23155	5MHz	QPSK, 16QAM	1 RB/ 0,24 RB Offest
	23060 to 23130	23060, 23095, 23130	10MHz	QPSK, 16QAM	1 RB/ 0,49 RB Offest
FREQUENCY STABILITY	23060 to 23130	23095	10MHz	QPSK,	Full RB
OCCUPIED BANDWIDTH	23017 to 23173	23017, 23095, 23173	1.4MHz	QPSK, 16QAM	Full RB
	23025 to 23165	23025, 23095, 23165	3MHz	QPSK, 16QAM	Full RB
	23035 to 23155	23035, 23095, 23155	5MHz	QPSK, 16QAM	Full RB
	23060 to 23130	23060, 23095, 23130	10MHz	QPSK, 16QAM	Full RB
PEAK TO AVERAGE RATIO	23017 to 23173	23017, 23095, 23173	1.4MHz	16QAM	Full RB
	23025 to 23165	23025, 23095, 23165	3MHz	16QAM	Full RB
	23035 to 23155	23035, 23095, 23155	5MHz	16QAM	Full RB
	23060 to 23130	23060, 23095, 23130	10MHz	16QAM	Full RB
BAND EDGE	23017 to 23173	23017, 23095, 23173	1.4MHz	QPSK,	1 RB/ 0,5 RB Offes Full RB
	23025 to 23165	23025, 23095, 23165	3MHz	QPSK,	1 RB/ 0,14 RB Offest Full RB
	23035 to 23155	23035, 23095, 23155	5MHz	QPSK,	1 RB/ 0,24 RB Offest Full RB
	23060 to 23130	23060, 23095, 23130	10MHz	QPSK,	1 RB/ 0,49 RB Offest Full RB
CONDCUDED EMISSION	23017 to 23173	23017, 23095, 23173	1.4MHz	QPSK,	1 RB, 0 RB Offest
	23025 to 23165	23025, 23095, 23165	3MHz	QPSK,	1 RB, 0 RB Offest
	23035 to 23155	23035, 23095, 23155	5MHz	QPSK,	1 RB, 0 RB Offest
	23060 to 23130	23060, 23095, 23130	10MHz	QPSK,	1 RB, 0 RB Offest
RADIATED EMISSION	23035 to 23155	23035, 23095, 23155	5MHz	16QAM	1 RB, 24 RB Offest

Unless otherwise stated the results shown in this test report refer only to the sample(s) tested and such sample(s) are retained for 90 days only.

除非另有說明，此報告結果僅對測試之樣品負責，同時此樣品僅保留90天。本報告未經本公司書面許可，不可部份複製。

This document is issued by the Company subject to its General Conditions of Service printed overleaf, available on request or accessible at [www.sgs.com/terms\\_and\\_conditions.htm](http://www.sgs.com/terms_and_conditions.htm) and, for electronic format documents, subject to Terms and Conditions for Electronic Documents at [www.sgs.com/terms\\_e-document.htm](http://www.sgs.com/terms_e-document.htm). Attention is drawn to the limitation of liability, indemnification and jurisdiction issues defined therein. Any holder of this document is advised that information contained hereon reflects the Company's findings at the time of its intervention only and within the limits of Client's instructions, if any. The Company's sole responsibility is to its Client and this document does not exonerate parties to a transaction from exercising all their rights and obligations under the transaction documents. This document cannot be reproduced except in full, without prior written approval of the Company. Any unauthorized alteration, forgery or falsification of the content or appearance of this document is unlawful and offenders may be prosecuted to the fullest extent of the law.

SGS Taiwan Ltd.

No.134,WuKungRoad,NewTaipeiIndustrialPark,WukuDistrict,NewTaipeiCity,Taiwan24803/新北市五股區新北產業園區五工路 134 號

台灣檢驗科技股份有限公司

t (886-2) 2299-3279

f (886-2) 2298-0488

www.tw.sgs.com

Member of SGS Group



**LTE Band 17 MODE**

TEST ITEM	AVAILABLE CHANNEL	TESTED CHANNEL	CHANNEL BANDWIDTH	MODULATION	MODE
ERP	23755 to 23825	23755, 23790, 23825	5MHz	QPSK, 16QAM	1 RB/ 0,24 RB Offest
	23780 to 23800	23780, 23790, 23800	10MHz	QPSK, 16QAM	1 RB/ 0,49 RB Offest
FREQUENCY STABILITY	23780 to 23800	23790	10MHz	QPSK,	Full RB
OCCUPIED BANDWIDTH	23755 to 23825	23755, 23790, 23825	5MHz	QPSK, 16QAM	Full RB
	23780 to 23800	23780, 23790, 23800	10MHz	QPSK, 16QAM	Full RB
PEAK TO AVERAGE RATIO	23755 to 23825	23755, 23790, 23825	5MHz	16QAM	Full RB
	23780 to 23800	23780, 23790, 23800	10MHz	16QAM	Full RB
BAND EDGE	23755 to 23825	23755, 23825	5MHz	QPSK,	1 RB/ 0,24 RB Offest Full RB
	23780 to 23800	23780, 23800	10MHz	QPSK,	1 RB/ 0,49 RB Offest Full RB
CONDCUDED EMISSION	23755 to 23825	23755, 23790, 23825	5MHz	QPSK,	1 RB, 0 RB Offest
	23780 to 23800	23780, 23790, 23800	10MHz	QPSK,	1 RB, 0 RB Offest
RADIATED EMISSION	23755 to 23825	23755, 23790, 23825	5MHz	16QAM	1 RB, 0 RB Offest

Unless otherwise stated the results shown in this test report refer only to the sample(s) tested and such sample(s) are retained for 90 days only.

除非另有說明，此報告結果僅對測試之樣品負責，同時此樣品僅保留90天。本報告未經本公司書面許可，不可部份複製。

This document is issued by the Company subject to its General Conditions of Service printed overleaf, available on request or accessible at [www.sgs.com/terms\\_and\\_conditions.htm](http://www.sgs.com/terms_and_conditions.htm) and, for electronic format documents, subject to Terms and Conditions for Electronic Documents at [www.sgs.com/terms\\_e-document.htm](http://www.sgs.com/terms_e-document.htm). Attention is drawn to the limitation of liability, indemnification and jurisdiction issues defined therein. Any holder of this document is advised that information contained hereon reflects the Company's findings at the time of its intervention only and within the limits of Client's instructions, if any. The Company's sole responsibility is to its Client and this document does not exonerate parties to a transaction from exercising all their rights and obligations under the transaction documents. This document cannot be reproduced except in full, without prior written approval of the Company. Any unauthorized alteration, forgery or falsification of the content or appearance of this document is unlawful and offenders may be prosecuted to the fullest extent of the law.

SGS Taiwan Ltd.

No.134,WuKungRoad,NewTaipeiIndustrialPark,WukuDistrict,NewTaipeiCity,Taiwan24803/新北市五股區新北產業園區五工路 134 號

台灣檢驗科技股份有限公司

t (886-2) 2299-3279

f (886-2) 2298-0488

www.tw.sgs.com

Member of SGS Group

**LTE Band 38 MODE**

TEST ITEM	AVAILABLE CHANNEL	TESTED CHANNEL	CHANNEL BANDWIDTH	MODULATION	MODE
EIRP	37775 to 38225	37775, 38000, 38225	5MHz	QPSK, 16QAM	1 RB/ 0,24 RB Offest
	37800 to 38200	37800 , 38000, 38200	10MHz	QPSK, 16QAM	1 RB/ 0,49 RB Offest
	37825 to 38175	37825 , 38000, 38175	15MHz	QPSK, 16QAM	1 RB/ 0,74 RB Offest
	37850 to 38150	37850 , 38000, 38150	20MHz	QPSK, 16QAM	1 RB/ 0,99 RB Offest
FREQUENCY STABILITY	37800 to 38200	37800 , 38000, 38200	10MHz	QPSK,	Full RB
OCCUPIED BANDWIDTH	37775 to 38225	37775, 38000, 38225	5MHz	QPSK, 16QAM	Full RB
	37800 to 38200	37800 , 38000, 38200	10MHz	QPSK, 16QAM	Full RB
	37825 to 38175	37825 , 38000, 38175	15MHz	QPSK, 16QAM	Full RB
	37850 to 38150	37850 , 38000, 38150	20MHz	QPSK, 16QAM	Full RB
PEAK TO AVERAGE RATIO	37775 to 38225	37775, 38000, 38225	5MHz	16QAM	Full RB
	37800 to 38200	37800 , 38000, 38200	10MHz	16QAM	Full RB
	37825 to 38175	37825 , 38000, 38175	15MHz	16QAM	Full RB
	37850 to 38150	37850 , 38000, 38150	20MHz	16QAM	Full RB
BAND EDGE	37775 to 38225	37775, 38000, 38225	5MHz	QPSK,	1 RB/ 0,24 RB Offest Full RB
	37800 to 38200	37800 , 38000, 38200	10MHz	QPSK,	1 RB/ 0,49 RB Offest Full RB
	37825 to 38175	37825 , 38000, 38175	15MHz	QPSK,	1 RB/ 0,74 RB Offest Full RB
	37850 to 38150	37850 , 38000, 38150	20MHz	QPSK,	1 RB/ 0,99 RB Offest Full RB
CONDCUDED EMISSION	37775 to 38225	37775, 38000, 38225	5MHz	QPSK,	1 RB, 0 RB Offest
	37800 to 38200	37800 , 38000, 38200	10MHz	QPSK,	1 RB, 0 RB Offest
	37825 to 38175	37825 , 38000, 38175	15MHz	QPSK,	1 RB, 0 RB Offest
	37850 to 38150	37850 , 38000, 38150	20MHz	QPSK,	1 RB, 0 RB Offest
RADIATED EMISSION	37775 to 38225	37775, 38000, 38225	5MHz	QPSK,	1 RB, 0 RB Offest
EMISSION MASK	37775 to 38225	37775, 38000, 38225	5MHz	QPSK,	1 RB/ 0,24 RB Offest 25 RB/ 0 Offset
	37800 to 38200	37800 , 38000, 38200	10MHz	QPSK,	1 RB/ 0,49 RB Offest 50 RB/ 0 Offset
	37825 to 38175	37825 , 38000, 38175	15MHz	QPSK,	1 RB/ 0,74 RB Offest 75 RB/ 0 Offset
	37850 to 38150	37850 , 38000, 38150	20MHz	QPSK,	1 RB/ 0,99 RB Offest 100 RB/ 0 Offset

Unless otherwise stated the results shown in this test report refer only to the sample(s) tested and such sample(s) are retained for 90 days only.

除非另有說明，此報告結果僅對測試之樣品負責，同時此樣品僅保留90天。本報告未經本公司書面許可，不可部份複製。

This document is issued by the Company subject to its General Conditions of Service printed overleaf, available on request or accessible at [www.sgs.com/terms\\_and\\_conditions.htm](http://www.sgs.com/terms_and_conditions.htm) and, for electronic format documents, subject to Terms and Conditions for Electronic Documents at [www.sgs.com/terms\\_e-document.htm](http://www.sgs.com/terms_e-document.htm). Attention is drawn to the limitation of liability, indemnification and jurisdiction issues defined therein. Any holder of this document is advised that information contained hereon reflects the Company's findings at the time of its intervention only and within the limits of Client's instructions, if any. The Company's sole responsibility is to its Client and this document does not exonerate parties to a transaction from exercising all their rights and obligations under the transaction documents. This document cannot be reproduced except in full, without prior written approval of the Company. Any unauthorized alteration, forgery or falsification of the content or appearance of this document is unlawful and offenders may be prosecuted to the fullest extent of the law.

SGS Taiwan Ltd.

No.134,WuKungRoad,NewTaipeiIndustrialPark,WukuDistrict,NewTaipeiCity,Taiwan24803/新北市五股區新北產業園區五工路 134 號

台灣檢驗科技股份有限公司

t (886-2) 2299-3279

f (886-2) 2298-0488

www.tw.sgs.com

Member of SGS Group



## 5. MEASUREMENT UNCERTAINTY

Test Items	Uncertainty
RF Power Output	+/- 1.10 dB
ERP/ EIRP measurement	Vertical Polarization = +/- 4.74dB Horizontal Polarization = +/- 4.62dB
99% Occupied Bandwidth	+/- 5.19 Hz
Out of Band Emissions at Antenna Terminals and Band Edge	+/- 0.70 dB
Peak to Average Ratio	+/- 0.70 dB
Frequency Stability vs. Temperature	+/- 5.19 Hz
Frequency Stability vs. Voltage	+/- 5.19 Hz
Temperature	+/- 0.65 °C
Humidity	+/- 4.6 %
DC / AC Power Source	DC= +/- 0.13%, AC= +/- 0.2%

### Radiated Spurious Emission:

Measurement uncertainty (Polarization : <b>Vertical</b> )	9kHz – 30MHz: +/- 2.87 dB
	30MHz - 180MHz: +/- 3.37dB
	180MHz -417MHz: +/- 3.19dB
	0.417GHz-1GHz: +/- 3.19dB
	1GHz - 18GHz: +/- 4.04dB
	18GHz - 40GHz: +/- 4.04dB

Measurement uncertainty (Polarization : <b>Horizontal</b> )	9kHz – 30MHz: +/- 2.87 dB
	30MHz - 167MHz: +/- 4.22dB
	167MHz -500MHz: +/- 3.44dB
	0.5GHz-1GHz: +/- 3.39dB
	1GHz - 18GHz: +/- 4.08dB
	18GHz - 40GHz: +/- 4.08dB

This uncertainty represents an expanded uncertainty expressed at approximately the 95% confidence level using a coverage factor of k=2.

Unless otherwise stated the results shown in this test report refer only to the sample(s) tested and such sample(s) are retained for 90 days only.

除非另有說明，此報告結果僅對測試之樣品負責，同時此樣品僅保留90天。本報告未經本公司書面許可，不可部份複製。

This document is issued by the Company subject to its General Conditions of Service printed overleaf, available on request or accessible at [www.sgs.com/terms\\_and\\_conditions.htm](http://www.sgs.com/terms_and_conditions.htm) and, for electronic format documents, subject to Terms and Conditions for Electronic Documents at [www.sgs.com/terms\\_e-document.htm](http://www.sgs.com/terms_e-document.htm). Attention is drawn to the limitation of liability, indemnification and jurisdiction issues defined therein. Any holder of this document is advised that information contained hereon reflects the Company's findings at the time of its intervention only and within the limits of Client's instructions, if any. The Company's sole responsibility is to its Client and this document does not exonerate parties to a transaction from exercising all their rights and obligations under the transaction documents. This document cannot be reproduced except in full, without prior written approval of the Company. Any unauthorized alteration, forgery or falsification of the content or appearance of this document is unlawful and offenders may be prosecuted to the fullest extent of the law.

## 6. RF CONDUCTED OUTPUT POWER MEASUREMENT

### 6.1. Standard Applicable

A base station simulator was used to establish communication with the EUT. Its parameters were set to transmit the maximum power on the EUT. The measured power in the radio frequency on the transmitter output terminals.

### 6.2. Test Set-up

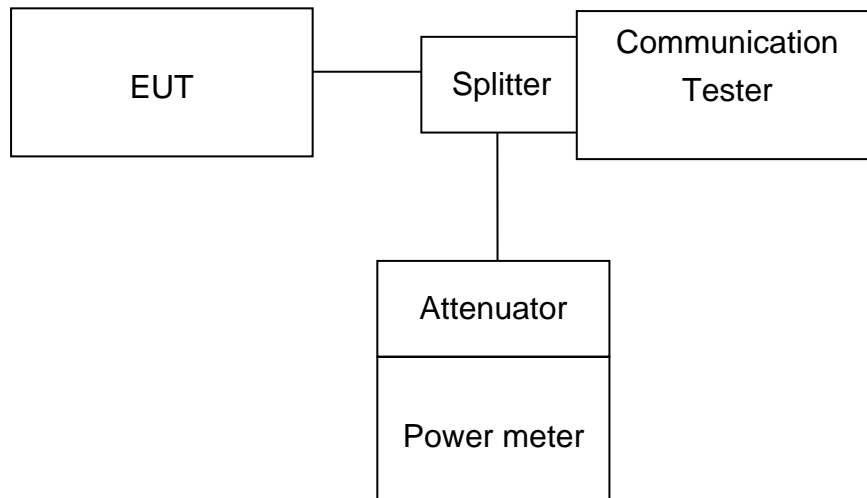

**Note:** Measurement setup for testing on Antenna connector

### 6.3. Measurement Procedure

The transmitter output was connected to a calibrated attenuator, the other end of which was connected to a power meter. Transmitter output was read off the power meter in dBm. The power output at the transmitter antenna port was determined by adding the value of the attenuator to the power meter reading. TS 151 010-1 is reference to conduct the test measurement of output power.

The Procedure of KDB941225 (SAR Measurement Procedures for 3G devices, (WCD-MA/HSPA) was used for EUT and Base station setting. RMC 12.2kps is used for this testing, and KDB 971168 D01 Power Meas License Digital System as the supplemental test methodology to adjust the proper setting obtaining the measurement results

Unless otherwise stated the results shown in this test report refer only to the sample(s) tested and such sample(s) are retained for 90 days only.

除非另有說明，此報告結果僅對測試之樣品負責，同時此樣品僅保留90天。本報告未經本公司書面許可，不可部份複製。

This document is issued by the Company subject to its General Conditions of Service printed overleaf, available on request or accessible at [www.sgs.com/terms\\_and\\_conditions.htm](http://www.sgs.com/terms_and_conditions.htm) and, for electronic format documents, subject to Terms and Conditions for Electronic Documents at [www.sgs.com/terms\\_e-document.htm](http://www.sgs.com/terms_e-document.htm). Attention is drawn to the limitation of liability, indemnification and jurisdiction issues defined therein. Any holder of this document is advised that information contained hereon reflects the Company's findings at the time of its intervention only and within the limits of Client's instructions, if any. The Company's sole responsibility is to its Client and this document does not exonerate parties to a transaction from exercising all their rights and obligations under the transaction documents. This document cannot be reproduced except in full, without prior written approval of the Company. Any unauthorized alteration, forgery or falsification of the content or appearance of this document is unlawful and offenders may be prosecuted to the fullest extent of the law.

SGS Taiwan Ltd.

No.134,WuKungRoad,NewTaipeiIndustrialPark,WukuDistrict,NewTaipeiCity,Taiwan24803/新北市五股區新北產業園區五工路 134 號

台灣檢驗科技股份有限公司

t (886-2) 2299-3279

f (886-2) 2298-0488

www.tw.sgs.com

Member of SGS Group

#### 6.4. Measurement Equipment Used

Conducted Emission (measured at antenna port) Test Site					
EQUIPMENT TYPE	MFR	MODEL NUMBER	SERIAL NUMBER	LAST CAL.	CAL DUE.
Power Meter	Anritsu	ML2495A	1005007	12/15/2016	12/14/2017
Power Sensor	Anritsu	MA2411B	917032	12/15/2016	12/14/2017
EXA Spectrum Analyzer	Agilent	N9030A	MY53120760	03/21/2017	03/20/2018
DC Block	Mini-Circuits	BLK-18-S+	1	01/05/2017	01/04/2018
Coaxial Cable	HUBER+SÜHNER	SUCOFLEX 102	23670/2	01/05/2017	01/04/2018
Attenuator	Mini-Circuit	BW-S10W2+	2	01/05/2017	01/04/2018
Splitter	Agilent	11636B	N/A	01/05/2017	01/04/2018
DC Power Supply	Agilent	E3640A	MY52410006	11/21/2016	11/20/2017
Temperature Chamber	TERCHY	MHG-120LF	911009	05/19/2017	05/18/2018
Radio Communication Analyzer	R&S	CMU200	102189	02/10/2017	02/09/2018
Radio Communication Analyser	Anritsu	MT8820C	6201465317	01/03/2017	01/02/2018

#### 6.5. Measurement Result

##### RF Conducted Output Power

GSM/GPRS/EDGE (GMSK; 8-PSK) Result:

EUT Mode	Freq. (MHz)	CH	Avg. Power (dBm)
GSM 850	824.2	128	33.54
	836.6	190	33.67
	848.8	251	33.63
GSM 1900	1850.2	512	30.07
	1880.0	661	30.44
	1909.8	810	30.82

Unless otherwise stated the results shown in this test report refer only to the sample(s) tested and such sample(s) are retained for 90 days only.

除非另有說明，此報告結果僅對測試之樣品負責，同時此樣品僅保留90天。本報告未經本公司書面許可，不可部份複製。

This document is issued by the Company subject to its General Conditions of Service printed overleaf, available on request or accessible at [www.sgs.com/terms\\_and\\_conditions.htm](http://www.sgs.com/terms_and_conditions.htm) and, for electronic format documents, subject to Terms and Conditions for Electronic Documents at [www.sgs.com/terms\\_e-document.htm](http://www.sgs.com/terms_e-document.htm). Attention is drawn to the limitation of liability, indemnification and jurisdiction issues defined therein. Any holder of this document is advised that information contained hereon reflects the Company's findings at the time of its intervention only and within the limits of Client's instructions, if any. The Company's sole responsibility is to its Client and this document does not exonerate parties to a transaction from exercising all their rights and obligations under the transaction documents. This document cannot be reproduced except in full, without prior written approval of the Company. Any unauthorized alteration, forgery or falsification of the content or appearance of this document is unlawful and offenders may be prosecuted to the fullest extent of the law.

SGS Taiwan Ltd.

No.134,WuKungRoad,NewTaipeiIndustrialPark,WukuDistrict,NewTaipeiCity,Taiwan24803/新北市五股區新北產業園區五工路 134 號

台灣檢驗科技股份有限公司

t (886-2) 2299-3279

f (886-2) 2298-0488

[www.tw.sgs.com](http://www.tw.sgs.com)

Member of SGS Group

EUT Mode	Frequency (MHz)	CH	Average Burst Power (1DN 1UP) Class 8 (dBm)	Average Burst Power (1DN 2UP) Class 10 (dBm)	Average Burst Power (1DN 3UP) Class 12 (dBm)	Average Burst Power (1DN 4UP) Class 12 (dBm)
GPRS 850	824.2	128	33.54	29.18	28.21	26.93
	836.6	190	33.67	29.31	28.33	26.82
	848.8	251	33.63	29.07	28.31	26.92
GPRS 1900	1850.2	512	30.07	27.99	26.87	25.61
	1880.0	661	30.44	28.44	26.75	25.46
	1909.8	810	30.82	28.5	26.88	25.54
EDGE 850	824.2	128	26.98	25.95	24.88	23.46
	836.6	190	26.89	25.91	24.25	23.04
	848.8	251	26.84	25.88	24.25	22.95
EDGE 1900	1850.2	512	25.66	25.14	23.92	22.42
	1880.0	661	26.04	25.34	23.68	22.29
	1909.8	810	26.24	25.47	23.7	22.41

#### WCDMA MODE:

The following tests were completed according to the test requirements outlined in section 5.2 of the 3GPP TS34.121-1 V8.4.0 specification. The EUT supports power Class 3, which has a nominal maximum output power of 24 dBm (+1.7/-3.7). RMC 12.2kps is used for this testing.

#### Results:

Mode	Avg. Power (dBm) Band II Channel			Avg. Power (dBm) Band IV Channel			Avg. Power (dBm) Band V Channel		
	9262	9400	9538	1312	1413	1513	4132	4183	4233
WCDMA	23.43	23.05	22.91	24.30	24.32	24.24	24.54	24.55	24.63
HSDPA	22.35	22.06	21.87	23.16	23.14	23.31	23.40	23.30	23.45
HSUPA	22.42	21.70	21.26	23.01	23.11	23.14	23.33	23.23	23.28

Unless otherwise stated the results shown in this test report refer only to the sample(s) tested and such sample(s) are retained for 90 days only.

除非另有說明，此報告結果僅對測試之樣品負責，同時此樣品僅保留90天。本報告未經本公司書面許可，不可部份複製。

This document is issued by the Company subject to its General Conditions of Service printed overleaf, available on request or accessible at [www.sgs.com/terms\\_and\\_conditions.htm](http://www.sgs.com/terms_and_conditions.htm) and, for electronic format documents, subject to Terms and Conditions for Electronic Documents at [www.sgs.com/terms\\_e-document.htm](http://www.sgs.com/terms_e-document.htm). Attention is drawn to the limitation of liability, indemnification and jurisdiction issues defined therein. Any holder of this document is advised that information contained hereon reflects the Company's findings at the time of its intervention only and within the limits of Client's instructions, if any. The Company's sole responsibility is to its Client and this document does not exonerate parties to a transaction from exercising all their rights and obligations under the transaction documents. This document cannot be reproduced except in full, without prior written approval of the Company. Any unauthorized alteration, forgery or falsification of the content or appearance of this document is unlawful and offenders may be prosecuted to the fullest extent of the law.

**LTE Result**

LTE Band 2 Uplink frequency band : 1850 to 1910 MHz								
BW (MHz)	RB Size	RB Offset	Conducted power(dBm)					
			QPSK			16QAM		
			Channel (Low)	Channel (Mid)	Channel (High)	Channel (Low)	Channel (Mid)	Channel (High)
			18607	18900	19193	18607	18900	19193
1.4	1	0	23.18	22.89	22.77	21.98	22.37	21.52
	1	5	23.23	23.02	22.64	22.39	21.48	22.04
	3	2	<b>23.34</b>	22.99	22.67	<b>22.42</b>	22.10	22.10
	6	0	22.26	21.92	21.67	21.21	20.69	20.58

LTE Band 2 Uplink frequency band : 1850 to 1910 MHz								
BW (MHz)	RB Size	RB Offset	Conducted power(dBm)					
			QPSK			16QAM		
			Channel (Low)	Channel (Mid)	Channel (High)	Channel (Low)	Channel (Mid)	Channel (High)
			18615	18900	19185	18615	18900	19185
3	1	0	22.93	22.88	22.64	22.04	22.09	22.14
	1	14	<b>23.18</b>	22.89	22.74	<b>22.17</b>	21.87	21.46
	8	4	22.22	21.89	21.77	21.27	21.02	20.99
	15	0	22.13	21.88	21.65	21.17	20.87	20.84

LTE Band 2 Uplink frequency band : 1850 to 1910 MHz								
BW (MHz)	RB Size	RB Offset	Conducted power(dBm)					
			QPSK			16QAM		
			Channel (Low)	Channel (Mid)	Channel (High)	Channel (Low)	Channel (Mid)	Channel (High)
			18625	18900	19175	18625	18900	19175
5	1	0	<b>23.19</b>	22.93	22.63	22.29	<b>22.49</b>	21.71
	1	24	23.18	22.89	22.87	22.14	21.83	22.25
	12	6	22.21	21.88	21.65	21.21	20.84	20.61
	25	0	22.18	21.86	21.68	21.16	20.84	20.80

LTE Band 2 Uplink frequency band : 1850 to 1910 MHz								
BW (MHz)	RB Size	RB Offset	Conducted power(dBm)					
			QPSK			16QAM		
			Channel (Low)	Channel (Mid)	Channel (High)	Channel (Low)	Channel (Mid)	Channel (High)
			18650	18900	19150	18650	18900	19150
10	1	0	23.09	22.91	22.60	22.37	21.70	21.76
	1	49	<b>23.40</b>	22.94	22.85	<b>22.45</b>	22.41	21.99
	25	12	22.20	21.96	21.81	21.30	21.14	20.67
	50	0	22.22	21.95	21.77	21.39	20.96	20.73

LTE Band 2 Uplink frequency band : 1850 to 1910 MHz								
BW (MHz)	RB Size	RB Offset	Conducted power(dBm)					
			QPSK			16QAM		
			Channel (Low)	Channel (Mid)	Channel (High)	Channel (Low)	Channel (Mid)	Channel (High)
			18675	18900	19125	18675	18900	19125
15	1	0	<b>23.26</b>	22.89	22.77	<b>22.50</b>	21.87	22.12
	1	74	23.09	22.83	22.85	22.47	22.03	21.95
	36	19	22.19	21.86	21.74	21.27	20.84	20.71
	75	0	22.16	21.85	21.78	21.32	20.90	20.73

LTE Band 2 Uplink frequency band : 1850 to 1910 MHz								
BW (MHz)	RB Size	RB Offset	Conducted power(dBm)					
			QPSK			16QAM		
			Channel (Low)	Channel (Mid)	Channel (High)	Channel (Low)	Channel (Mid)	Channel (High)
			18700	18900	19100	18700	18900	19100
20	1	0	<b>23.41</b>	22.89	22.87	<b>22.48</b>	21.90	22.05
	1	99	22.99	22.84	22.50	21.29	22.06	22.21
	50	25	22.22	21.84	21.71	21.09	20.94	20.61
	100	0	22.05	21.78	21.74	21.17	20.90	20.63

Unless otherwise stated the results shown in this test report refer only to the sample(s) tested and such sample(s) are retained for 90 days only.

除非另有說明，此報告結果僅對測試之樣品負責，同時此樣品僅保留90天。本報告未經本公司書面許可，不可部份複製。

This document is issued by the Company subject to its General Conditions of Service printed overleaf, available on request or accessible at [www.sgs.com/terms\\_and\\_conditions.htm](http://www.sgs.com/terms_and_conditions.htm) and, for electronic format documents, subject to Terms and Conditions for Electronic Documents at [www.sgs.com/terms\\_e-document.htm](http://www.sgs.com/terms_e-document.htm). Attention is drawn to the limitation of liability, indemnification and jurisdiction issues defined therein. Any holder of this document is advised that information contained hereon reflects the Company's findings at the time of its intervention only and within the limits of Client's instructions, if any. The Company's sole responsibility is to its Client and this document does not exonerate parties to a transaction from exercising all their rights and obligations under the transaction documents. This document cannot be reproduced except in full, without prior written approval of the Company. Any unauthorized alteration, forgery or falsification of the content or appearance of this document is unlawful and offenders may be prosecuted to the fullest extent of the law.

LTE Band 4_Uplink frequency band : 1710 to 1755 MHz								
BW (MHz)	RB Size	RB Offset	Conducted power(dBm)					
			QPSK			16QAM		
			Channel (Low)	Channel (Mid)	Channel (High)	Channel (Low)	Channel (Mid)	Channel (High)
1.4	1	0	19957	20175	20393	19957	20175	20393
	1	5	22.96	22.91	22.99	22.07	22.06	22.36
	1	5	22.90	22.81	22.98	22.06	21.67	<b>22.44</b>
	3	2	23.02	23.02	<b>23.04</b>	21.90	21.80	22.12
6	0	22.06	22.09	22.16	20.85	20.85	20.92	

LTE Band 4_Uplink frequency band : 1710 to 1755 MHz								
BW (MHz)	RB Size	RB Offset	Conducted power(dBm)					
			QPSK			16QAM		
			Channel (Low)	Channel (Mid)	Channel (High)	Channel (Low)	Channel (Mid)	Channel (High)
3	1	0	19965	20175	20385	19965	20175	20385
	1	0	<b>23.28</b>	23.00	23.06	22.50	22.53	<b>22.74</b>
	1	14	23.20	22.88	23.12	22.18	22.01	22.23
	8	4	22.07	22.08	22.14	20.81	20.86	21.28
15	0	21.98	22.08	22.07	20.99	21.23	21.35	

LTE Band 4_Uplink frequency band : 1710 to 1755 MHz								
BW (MHz)	RB Size	RB Offset	Conducted power(dBm)					
			QPSK			16QAM		
			Channel (Low)	Channel (Mid)	Channel (High)	Channel (Low)	Channel (Mid)	Channel (High)
5	1	0	19975	20175	20375	19975	20175	20375
	1	0	<b>23.13</b>	22.96	22.89	21.98	<b>22.73</b>	22.46
	1	24	23.09	22.91	23.07	22.38	22.31	22.67
	12	6	22.00	21.94	22.15	21.11	20.97	21.10
25	0	22.08	21.98	22.07	21.32	21.03	21.28	

LTE Band 4_Uplink frequency band : 1710 to 1755 MHz								
BW (MHz)	RB Size	RB Offset	Conducted power(dBm)					
			QPSK			16QAM		
			Channel (Low)	Channel (Mid)	Channel (High)	Channel (Low)	Channel (Mid)	Channel (High)
10	1	0	20000	20175	20350	20000	20175	20350
	1	0	23.09	22.92	23.12	21.81	21.89	22.52
	1	49	<b>23.24</b>	22.72	22.99	<b>22.66</b>	21.83	22.16
	25	12	22.22	22.09	22.14	21.20	21.25	21.08
50	0	22.07	22.05	22.04	21.17	21.05	21.12	

LTE Band 4_Uplink frequency band : 1710 to 1755 MHz								
BW (MHz)	RB Size	RB Offset	Conducted power(dBm)					
			QPSK			16QAM		
			Channel (Low)	Channel (Mid)	Channel (High)	Channel (Low)	Channel (Mid)	Channel (High)
15	1	0	20025	20175	20325	20025	20175	20325
	1	0	23.11	<b>23.15</b>	23.05	22.49	<b>22.74</b>	22.24
	1	74	<b>23.15</b>	22.81	23.05	22.44	21.92	22.17
	36	19	22.23	21.98	22.12	21.26	21.03	21.16
75	0	22.31	22.01	22.14	21.17	21.13	21.09	

LTE Band 4_Uplink frequency band : 1710 to 1755 MHz								
BW (MHz)	RB Size	RB Offset	Conducted power(dBm)					
			QPSK			16QAM		
			Channel (Low)	Channel (Mid)	Channel (High)	Channel (Low)	Channel (Mid)	Channel (High)
20	1	0	20050	20175	20300	20050	20175	20300
	1	0	22.93	<b>23.14</b>	23.06	<b>22.56</b>	22.38	22.12
	1	99	22.92	22.83	22.82	22.05	21.58	22.12
	50	25	22.16	22.01	22.18	21.09	20.99	21.07
100	0	22.08	22.07	22.06	21.10	21.10	21.12	

Unless otherwise stated the results shown in this test report refer only to the sample(s) tested and such sample(s) are retained for 90 days only.

除非另有說明，此報告結果僅對測試之樣品負責，同時此樣品僅保留90天。本報告未經本公司書面許可，不可部份複製。

This document is issued by the Company subject to its General Conditions of Service printed overleaf, available on request or accessible at [www.sgs.com/terms\\_and\\_conditions.htm](http://www.sgs.com/terms_and_conditions.htm) and, for electronic format documents, subject to Terms and Conditions for Electronic Documents at [www.sgs.com/terms\\_e-document.htm](http://www.sgs.com/terms_e-document.htm). Attention is drawn to the limitation of liability, indemnification and jurisdiction issues defined therein. Any holder of this document is advised that information contained hereon reflects the Company's findings at the time of its intervention only and within the limits of Client's instructions, if any. The Company's sole responsibility is to its Client and this document does not exonerate parties to a transaction from exercising all their rights and obligations under the transaction documents. This document cannot be reproduced except in full, without prior written approval of the Company. Any unauthorized alteration, forgery or falsification of the content or appearance of this document is unlawful and offenders may be prosecuted to the fullest extent of the law.

LTE Band 7_Uplink frequency band : 2500 to 2570 MHz								
BW (MHz)	RB Size	RB Offset	Conducted power(dBm)					
			QPSK			16QAM		
			Channel (Low)	Channel (Mid)	Channel (High)	Channel (Low)	Channel (Mid)	Channel (High)
5	1	0	22.50	22.38	<b>22.59</b>	21.38	21.54	<b>21.92</b>
	1	24	22.44	22.51	22.45	21.73	21.48	21.83
	12	6	21.46	21.27	21.60	20.32	20.33	20.52
	25	0	21.37	21.31	21.53	20.33	20.28	20.46

LTE Band 7_Uplink frequency band : 2500 to 2570 MHz								
BW (MHz)	RB Size	RB Offset	Conducted power(dBm)					
			QPSK			16QAM		
			Channel (Low)	Channel (Mid)	Channel (High)	Channel (Low)	Channel (Mid)	Channel (High)
10	1	0	22.52	22.33	22.35	21.71	21.80	<b>21.93</b>
	1	49	22.37	22.50	<b>22.60</b>	21.39	21.60	21.70
	25	12	21.36	21.32	21.62	20.60	20.28	20.50
	50	0	21.44	21.31	21.58	20.30	20.18	20.49

LTE Band 7_Uplink frequency band : 2500 to 2570 MHz								
BW (MHz)	RB Size	RB Offset	Conducted power(dBm)					
			QPSK			16QAM		
			Channel (Low)	Channel (Mid)	Channel (High)	Channel (Low)	Channel (Mid)	Channel (High)
15	1	0	<b>22.47</b>	22.44	22.42	21.51	<b>21.64</b>	21.30
	1	74	22.41	22.25	22.45	21.63	20.94	21.38
	36	19	21.26	21.31	21.50	20.32	20.20	20.44
	75	0	21.33	21.28	21.46	20.25	20.26	20.51

LTE Band 7_Uplink frequency band : 2500 to 2570 MHz								
BW (MHz)	RB Size	RB Offset	Conducted power(dBm)					
			QPSK			16QAM		
			Channel (Low)	Channel (Mid)	Channel (High)	Channel (Low)	Channel (Mid)	Channel (High)
20	1	0	22.41	22.88	<b>22.90</b>	21.80	21.67	21.52
	1	99	22.38	22.62	22.73	<b>21.82</b>	21.39	21.56
	50	25	21.64	21.62	21.87	20.72	20.78	20.93
	100	0	21.69	21.61	21.98	20.69	20.70	20.85

LTE Band 12_Uplink frequency band : 699 to 716 MHz								
BW (MHz)	RB Size	RB Offset	Conducted power(dBm)					
			QPSK			16QAM		
			Channel (Low)	Channel (Mid)	Channel (High)	Channel (Low)	Channel (Mid)	Channel (High)
1.4	1	0	23.50	23.49	<b>23.88</b>	22.08	22.78	22.91
	1	5	23.51	23.36	23.83	22.39	22.84	22.97
	3	2	23.47	23.35	23.87	22.20	22.45	<b>22.98</b>
	6	0	22.43	22.54	22.76	21.07	21.40	21.49

LTE Band 12_Uplink frequency band : 699 to 716 MHz								
BW (MHz)	RB Size	RB Offset	Conducted power(dBm)					
			QPSK			16QAM		
			Channel (Low)	Channel (Mid)	Channel (High)	Channel (Low)	Channel (Mid)	Channel (High)
3	1	0	23.44	23.65	23.92	22.40	22.74	<b>22.92</b>
	1	14	23.42	23.47	<b>23.95</b>	22.71	22.60	22.91
	8	4	22.40	22.52	22.85	21.11	21.56	21.67
	15	0	22.30	22.59	22.68	21.60	21.64	21.66

LTE Band 12_Uplink frequency band : 699 to 716 MHz								
BW (MHz)	RB Size	RB Offset	Conducted power(dBm)					
			QPSK			16QAM		
			Channel (Low)	Channel (Mid)	Channel (High)	Channel (Low)	Channel (Mid)	Channel (High)
5	1	0	23.15	23.52	23.63	22.61	22.92	22.86
	1	24	23.67	23.66	<b>23.75</b>	<b>22.93</b>	22.71	<b>22.93</b>
	12	6	22.56	22.51	22.69	21.17	21.54	21.92
	25	0	22.52	22.54	22.76	21.40	21.52	21.76

LTE Band 12_Uplink frequency band : 699 to 716 MHz								
BW (MHz)	RB Size	RB Offset	Conducted power(dBm)					
			QPSK			16QAM		
			Channel (Low)	Channel (Mid)	Channel (High)	Channel (Low)	Channel (Mid)	Channel (High)
10	1	0	23.37	23.25	23.73	22.08	22.85	22.40
	1	49	23.51	23.36	<b>23.99</b>	22.25	22.57	<b>22.97</b>
	25	12	22.50	22.52	22.77	21.50	21.47	21.98
	50	0	22.53	22.52	22.71	21.50	21.57	21.87

Unless otherwise stated the results shown in this test report refer only to the sample(s) tested and such sample(s) are retained for 90 days only.

除非另有說明，此報告結果僅對測試之樣品負責，同時此樣品僅保留90天。本報告未經本公司書面許可，不可部份複製。

This document is issued by the Company subject to its General Conditions of Service printed overleaf, available on request or accessible at [www.sgs.com/terms\\_and\\_conditions.htm](http://www.sgs.com/terms_and_conditions.htm) and, for electronic format documents, subject to Terms and Conditions for Electronic Documents at [www.sgs.com/terms\\_e-document.htm](http://www.sgs.com/terms_e-document.htm). Attention is drawn to the limitation of liability, indemnification and jurisdiction issues defined therein. Any holder of this document is advised that information contained hereon reflects the Company's findings at the time of its intervention only and within the limits of Client's instructions, if any. The Company's sole responsibility is to its Client and this document does not exonerate parties to a transaction from exercising all their rights and obligations under the transaction documents. This document cannot be reproduced except in full, without prior written approval of the Company. Any unauthorized alteration, forgery or falsification of the content or appearance of this document is unlawful and offenders may be prosecuted to the fullest extent of the law.



LTE Band 17_Uplink frequency band : 704 to 716 MHz								
BW (MHz)	RB Size	RB Offset	Conducted power(dBm)					
			QPSK			16QAM		
			Channel (Low) 23755	Channel (Mid) 23790	Channel (High) 23825	Channel (Low) 23755	Channel (Mid) 23790	Channel (High) 23825
5	1	0	23.67	23.65	23.96	22.41	22.94	22.91
	1	24	23.79	23.81	23.95	22.85	22.92	22.63
	12	6	22.74	22.70	22.91	21.54	21.64	21.85
	25	0	22.81	22.80	22.88	21.65	21.85	21.84

LTE Band 17_Uplink frequency band : 704 to 716 MHz								
BW (MHz)	RB Size	RB Offset	Conducted power(dBm)					
			QPSK			16QAM		
			Channel (Low) 23780	Channel (Mid) 23790	Channel (High) 23800	Channel (Low) 23780	Channel (Mid) 23790	Channel (High) 23800
10	1	0	23.64	23.68	23.75	22.83	22.42	22.94
	1	49	23.98	23.94	23.95	22.92	22.93	22.95
	25	12	22.79	22.70	22.80	21.66	21.93	21.74
	50	0	22.73	22.85	22.86	21.80	21.70	21.74

LTE Band 38_Uplink frequency band : 2570 to 2620 MHz								
BW (MHz)	RB Size	RB Offset	Conducted power (dBm)					
			QPSK			16QAM		
			CH (Low) 37775	CH (Mid) 38000	CH (High) 38225	CH (Low) 37775	CH (Mid) 38000	CH (High) 38225
5	1	0	23.31	23.59	23.39	22.57	22.90	22.85
	1	24	23.40	23.53	23.21	22.68	22.83	22.32
	12	6	22.57	22.66	22.41	21.69	21.82	21.38
	25	0	22.69	22.74	22.51	21.79	21.91	21.45

LTE Band 38_Uplink frequency band : 2570 to 2620 MHz								
BW (MHz)	RB Size	RB Offset	Conducted power (dBm)					
			QPSK			16QAM		
			CH (Low) 37800	CH (Mid) 38000	CH (High) 38200	CH (Low) 37800	CH (Mid) 38000	CH (High) 38200
10	1	0	23.39	23.71	23.45	22.81	22.63	22.60
	1	49	23.43	23.48	23.37	22.45	22.81	22.41
	25	12	22.78	22.81	22.49	21.66	21.86	21.68
	50	0	22.51	22.89	22.46	21.64	21.79	21.68

LTE Band 38_Uplink frequency band : 2570 to 2620 MHz								
BW (MHz)	RB Size	RB Offset	Conducted power (dBm)					
			QPSK			16QAM		
			CH (Low) 37825	CH (Mid) 38000	CH (High) 38175	CH (Low) 37825	CH (Mid) 38000	CH (High) 38175
15	1	0	23.46	23.84	23.71	22.60	22.93	22.94
	1	74	23.65	23.84	23.41	22.82	22.84	22.34
	36	19	22.66	22.86	22.59	21.72	21.81	21.72
	75	0	22.73	22.75	22.67	21.54	21.61	21.53

LTE Band 38_Uplink frequency band : 2570 to 2620 MHz								
BW (MHz)	RB Size	RB Offset	Conducted power (dBm)					
			QPSK			16QAM		
			CH (Low) 37850	CH (Mid) 38000	CH (High) 38150	CH (Low) 37850	CH (Mid) 38000	CH (High) 38150
20	1	0	23.46	23.85	23.70	22.85	22.96	22.92
	1	99	23.47	23.39	23.26	22.70	22.76	22.34
	50	25	22.76	22.90	22.71	21.87	21.83	21.68
	100	0	22.83	22.74	22.66	21.73	21.76	21.61

Unless otherwise stated the results shown in this test report refer only to the sample(s) tested and such sample(s) are retained for 90 days only.

除非另有說明，此報告結果僅對測試之樣品負責，同時此樣品僅保留90天。本報告未經本公司書面許可，不可部份複製。

This document is issued by the Company subject to its General Conditions of Service printed overleaf, available on request or accessible at [www.sgs.com/terms\\_and\\_conditions.htm](http://www.sgs.com/terms_and_conditions.htm) and, for electronic format documents, subject to Terms and Conditions for Electronic Documents at [www.sgs.com/terms\\_e-document.htm](http://www.sgs.com/terms_e-document.htm). Attention is drawn to the limitation of liability, indemnification and jurisdiction issues defined therein. Any holder of this document is advised that information contained hereon reflects the Company's findings at the time of its intervention only and within the limits of Client's instructions, if any. The Company's sole responsibility is to its Client and this document does not exonerate parties to a transaction from exercising all their rights and obligations under the transaction documents. This document cannot be reproduced except in full, without prior written approval of the Company. Any unauthorized alteration, forgery or falsification of the content or appearance of this document is unlawful and offenders may be prosecuted to the fullest extent of the law.



**HSDPA Release 6 MODE:**

The following 4 Sub-Tests were completed according to the test requirements outlined in section 5.2A of the 3GPP TS34.121-1 V8.4.0 specification. All TX RMS power requirements for Power Class 3 were met according to table 5.2AA.5 and 5.2B.5 All UE channels and power ratio's are set according to table C10.1.4 & C11.1.3 in the 3GPP TS34.121-1 V8.4.0. RMC 12.2kps is used for this testing.

**HSDPA SUB-TEST Setting**

Table C.10.1.4:  $\beta$  values for transmitter characteristics tests with HS-DPCCH(FOR HSDPA)

Sub-test	$\beta_c$	$\beta_d$	$\beta_d$ (SF)	$\beta_c/\beta_d$	$\beta_{HS}$ (Note 1, Note 2)	CM (dB) (Note 3)	MPR (dB) (Note 3)	RMC (Kbps)
1	2/15	15/15	64	2/15	4/15	0.0	0.0	12.2
2	12/15 (Note 4)	15/15 (Note 4)	64	12/15 (Note 4)	24/15	1.0	0.0	12.2
3	15/15	8/15	64	15/8	30/15	1.5	0.5	12.2
4	15/15	4/15	64	15/4	30/15	1.5	0.5	12.2

**Note: The recommended HSDPA MPRs are implemented as per following sub-tests.**

**Results:**

Unless otherwise stated the results shown in this test report refer only to the sample(s) tested and such sample(s) are retained for 90 days only.

除非另有說明，此報告結果僅對測試之樣品負責，同時此樣品僅保留90天。本報告未經本公司書面許可，不可部份複製。

This document is issued by the Company subject to its General Conditions of Service printed overleaf, available on request or accessible at [www.sgs.com/terms\\_and\\_conditions.htm](http://www.sgs.com/terms_and_conditions.htm) and, for electronic format documents, subject to Terms and Conditions for Electronic Documents at [www.sgs.com/terms\\_e-document.htm](http://www.sgs.com/terms_e-document.htm). Attention is drawn to the limitation of liability, indemnification and jurisdiction issues defined therein. Any holder of this document is advised that information contained hereon reflects the Company's findings at the time of its intervention only and within the limits of Client's instructions, if any. The Company's sole responsibility is to its Client and this document does not exonerate parties to a transaction from exercising all their rights and obligations under the transaction documents. This document cannot be reproduced except in full, without prior written approval of the Company. Any unauthorized alteration, forgery or falsification of the content or appearance of this document is unlawful and offenders may be prosecuted to the fullest extent of the law.

SGS Taiwan Ltd.

No.134,WuKungRoad,NewTaipeiIndustrialPark,WukuDistrict,NewTaipeiCity,Taiwan24803/新北市五股區新北產業園區五工路 134 號

台灣檢驗科技股份有限公司

t (886-2) 2299-3279

f (886-2) 2298-0488

www.tw.sgs.com

Member of SGS Group

Mode	Sub test	Avg. Power (dBm) Channel			Power Class 3 Limitation (dBm)	Result
		9262	9400	9538		
HSDPA II	1	<b>22.35</b>	22.06	21.87	20.3 ~ 25.7	Pass
	2	21.83	21.57	21.47	20.3 ~ 25.7	Pass
	3	21.98	21.73	21.44	19.8 ~ 25.7	Pass
	4	21.97	21.71	21.43	19.8 ~ 25.7	Pass

Mode	Sub test	Avg. Power (dBm) Channel			Power Class 3 Limitation (dBm)	Result
		1312	1413	1513		
HSDPA IV	1	23.16	<b>23.14</b>	23.31	20.3 ~ 25.7	Pass
	2	22.73	22.61	22.80	20.3 ~ 25.7	Pass
	3	22.77	22.75	22.83	19.8 ~ 25.7	Pass
	4	22.66	22.75	22.95	19.8 ~ 25.7	Pass

Mode	Sub test	Avg. Power (dBm) Channel			Power Class 3 Limitation (dBm)	Result
		4132	4183	4233		
HSDPA V	1	23.40	23.30	<b>23.45</b>	20.3 ~ 25.7	Pass
	2	23.21	23.12	23.17	20.3 ~ 25.7	Pass
	3	23.14	23.13	23.06	19.8 ~ 25.7	Pass
	4	23.14	23.13	23.06	19.8 ~ 25.7	Pass

Unless otherwise stated the results shown in this test report refer only to the sample(s) tested and such sample(s) are retained for 90 days only.

除非另有說明，此報告結果僅對測試之樣品負責，同時此樣品僅保留90天。本報告未經本公司書面許可，不可部份複製。

This document is issued by the Company subject to its General Conditions of Service printed overleaf, available on request or accessible at [www.sgs.com/terms\\_and\\_conditions.htm](http://www.sgs.com/terms_and_conditions.htm) and, for electronic format documents, subject to Terms and Conditions for Electronic Documents at [www.sgs.com/terms\\_e-document.htm](http://www.sgs.com/terms_e-document.htm). Attention is drawn to the limitation of liability, indemnification and jurisdiction issues defined therein. Any holder of this document is advised that information contained hereon reflects the Company's findings at the time of its intervention only and within the limits of Client's instructions, if any. The Company's sole responsibility is to its Client and this document does not exonerate parties to a transaction from exercising all their rights and obligations under the transaction documents. This document cannot be reproduced except in full, without prior written approval of the Company. Any unauthorized alteration, forgery or falsification of the content or appearance of this document is unlawful and offenders may be prosecuted to the fullest extent of the law.

SGS Taiwan Ltd.

No.134,WuKungRoad,NewTaipeiIndustrialPark,WukuDistrict,NewTaipeiCity,Taiwan24803/新北市五股區新北產業園區五工路 134 號

台灣檢驗科技股份有限公司

t (886-2) 2299-3279

f (886-2) 2298-0488

www.tw.sgs.com

Member of SGS Group

## HSPA (HSDPA & HSUPA) Release 6 MODE

The following 5 Sub-Tests were completed according to the test requirements outlined in section 5.2A of the 3GPP TS34.121-1 V8.4.0 specification. All TX RMS power requirements for Power Class 3 were met according to table 5.2AA.5 and 5.2B.5 All UE channels and power ratio's are set according to table C11.1.3 in the 3GPP TS34.121-1 V8.4.0. RMC 12.2kps is used for this testing

### HSPA SUB-TEST Setting

Table C.11.1.3:  $\beta$  values for transmitter characteristics tests with HS-DPCCH and E-DCH(FOR HSUPA)

Sub-test	$\beta_c$	$\beta_d$	$\beta_d$ (SF)	$\beta_c/\beta_d$	$\beta_{HS}$	$\beta_{ec}$	$\beta_{ed}$	$\beta_{ed}$ (SF)	$\beta_{ed}$ (Code s)	CM (dB)	MPR (dB)	AG Index	E-TFCI	RMC (Kbps)
1	11/15 (Note 3)	15/15 (Note 3)	64	11/15 (Note 3)	22/15	209/225	1309/225	4	1	1.0	0.0	20	75	12.2
2	6/15	15/15	64	6/15	12/15	12/15	94/75	4	1	3.0	2.0	12	67	12.2
3	15/15	9/15	64	15/9	30/15	30/15	$\beta_{ed1}: 47/15$ $\beta_{ed2}: 47/15$	4 4	2	2.0	1.0	15	92	12.2
4	2/15	15/15	64	2/15	4/15	2/15	56/75	4	1	3.0	2.0	17	71	12.2
5	15/15 (Note 4)	15/15 (Note 4)	64	15/15 (Note 4)	30/15	24/15	134/15	4	1	1.0	0.0	21	81	12.2

**Note: The recommended HSUPA MPRs are implemented as per following sub-tests.**

### Results:

Unless otherwise stated the results shown in this test report refer only to the sample(s) tested and such sample(s) are retained for 90 days only.

除非另有說明，此報告結果僅對測試之樣品負責，同時此樣品僅保留90天。本報告未經本公司書面許可，不可部份複製。

This document is issued by the Company subject to its General Conditions of Service printed overleaf, available on request or accessible at [www.sgs.com/terms\\_and\\_conditions.htm](http://www.sgs.com/terms_and_conditions.htm) and, for electronic format documents, subject to Terms and Conditions for Electronic Documents at [www.sgs.com/terms\\_e-document.htm](http://www.sgs.com/terms_e-document.htm). Attention is drawn to the limitation of liability, indemnification and jurisdiction issues defined therein. Any holder of this document is advised that information contained hereon reflects the Company's findings at the time of its intervention only and within the limits of Client's instructions, if any. The Company's sole responsibility is to its Client and this document does not exonerate parties to a transaction from exercising all their rights and obligations under the transaction documents. This document cannot be reproduced except in full, without prior written approval of the Company. Any unauthorized alteration, forgery or falsification of the content or appearance of this document is unlawful and offenders may be prosecuted to the fullest extent of the law.

SGS Taiwan Ltd.

No.134,WuKungRoad,NewTaipeiIndustrialPark,WukuDistrict,NewTaipeiCity,Taiwan24803/新北市五股區新北產業園區五工路 134 號

台灣檢驗科技股份有限公司

t (886-2) 2299-3279

f (886-2) 2298-0488

[www.tw.sgs.com](http://www.tw.sgs.com)

Member of SGS Group

Mode	Sub test	Avg. Power (dBm) Channel			Power Class 3 Limitation (dBm)	Result
		9262	9400	9538		
HSUPA II	1	22.42	<b>21.70</b>	21.26	18.8 ~ 25.7	Pass
	2	21.44	21.02	20.85	16.8 ~ 25.7	Pass
	3	21.08	21.05	20.96	17.8 ~ 25.7	Pass
	4	21.56	21.01	20.96	16.8 ~ 25.7	Pass
	5	22.40	21.90	21.70	18.8 ~ 25.7	Pass

Mode	Sub test	Avg. Power (dBm) Channel			Power Class 3 Limitation (dBm)	Result
		1312	1413	1513		
HSDPA IV	1	23.01	23.11	<b>23.14</b>	20.3 ~ 25.7	Pass
	2	22.51	22.54	22.73	20.3 ~ 25.7	Pass
	3	23.14	23.08	23.04	19.8 ~ 25.7	Pass
	4	23.02	23.03	23.18	19.8 ~ 25.7	Pass
	5	23.10	23.12	23.19	19.8 ~ 25.7	Pass

Mode	Sub test	Avg. Power (dBm) Channel			Power Class 3 Limitation (dBm)	Result
		4132	4183	4233		
HSUPA V	1	23.33	<b>23.23</b>	23.28	18.8 ~ 25.7	Pass
	2	23.03	23.01	23.03	16.8 ~ 25.7	Pass
	3	23.25	23.15	23.29	17.8 ~ 25.7	Pass
	4	23.36	23.21	23.33	16.8 ~ 25.7	Pass
	5	23.39	23.27	23.34	16.8 ~ 25.7	Pass

Unless otherwise stated the results shown in this test report refer only to the sample(s) tested and such sample(s) are retained for 90 days only.

除非另有說明，此報告結果僅對測試之樣品負責，同時此樣品僅保留90天。本報告未經本公司書面許可，不可部份複製。

This document is issued by the Company subject to its General Conditions of Service printed overleaf, available on request or accessible at [www.sgs.com/terms\\_and\\_conditions.htm](http://www.sgs.com/terms_and_conditions.htm) and, for electronic format documents, subject to Terms and Conditions for Electronic Documents at [www.sgs.com/terms\\_e-document.htm](http://www.sgs.com/terms_e-document.htm). Attention is drawn to the limitation of liability, indemnification and jurisdiction issues defined therein. Any holder of this document is advised that information contained hereon reflects the Company's findings at the time of its intervention only and within the limits of Client's instructions, if any. The Company's sole responsibility is to its Client and this document does not exonerate parties to a transaction from exercising all their rights and obligations under the transaction documents. This document cannot be reproduced except in full, without prior written approval of the Company. Any unauthorized alteration, forgery or falsification of the content or appearance of this document is unlawful and offenders may be prosecuted to the fullest extent of the law.

SGS Taiwan Ltd.

No.134,WuKungRoad,NewTaipeiIndustrialPark,WukuDistrict,NewTaipeiCity,Taiwan24803/新北市五股區新北產業園區五工路 134 號

台灣檢驗科技股份有限公司

t (886-2) 2299-3279

f (886-2) 2298-0488

www.tw.sgs.com

Member of SGS Group

**Minimum Communications Power Measurement**  
**PCS 1900 band**

PCL	0	1	2	3	4	5	6	7	8
Output power (dBm)	30.7	28.7	25.9	23.7	22.4	19.6	17.4	15.6	13.3

PCL	9	10	11	12	13	14	15
Output power (dBm)	10.9	9.4	7.3	4.5	2.7	1.5	-0.1

Note: The EUT output power was controlled by simulator. Set Communication Tester [MT8820C](#) PCL as above, and get the mobile phone output power reading

**WCDMA/HSDPA/HSUPA band II, IV, V**

The EUT output power was controlled by simulator. Set Communication Tester MT8820C function key “UE Power Control” and enter max rated power 24dBm. The EUT is going to be set to max output power to 24dBm. Then record the read (see page 15 for measurement data). The min. power was measures by a function key “minimum power” then record the read. It is -52.3dBm. The power variation can be 0.1dB step by setting.

Unless otherwise stated the results shown in this test report refer only to the sample(s) tested and such sample(s) are retained for 90 days only.

除非另有說明，此報告結果僅對測試之樣品負責，同時此樣品僅保留90天。本報告未經本公司書面許可，不可部份複製。

This document is issued by the Company subject to its General Conditions of Service printed overleaf, available on request or accessible at [www.sgs.com/terms\\_and\\_conditions.htm](http://www.sgs.com/terms_and_conditions.htm) and, for electronic format documents, subject to Terms and Conditions for Electronic Documents at [www.sgs.com/terms\\_e-document.htm](http://www.sgs.com/terms_e-document.htm). Attention is drawn to the limitation of liability, indemnification and jurisdiction issues defined therein. Any holder of this document is advised that information contained hereon reflects the Company's findings at the time of its intervention only and within the limits of Client's instructions, if any. The Company's sole responsibility is to its Client and this document does not exonerate parties to a transaction from exercising all their rights and obligations under the transaction documents. This document cannot be reproduced except in full, without prior written approval of the Company. Any unauthorized alteration, forgery or falsification of the content or appearance of this document is unlawful and offenders may be prosecuted to the fullest extent of the law.

SGS Taiwan Ltd.

No.134,WuKungRoad,NewTaipeiIndustrialPark,WukuDistrict,NewTaipeiCity,Taiwan24803/新北市五股區新北產業園區五工路 134 號

台灣檢驗科技股份有限公司

t (886-2) 2299-3279

f (886-2) 2298-0488

[www.tw.sgs.com](http://www.tw.sgs.com)

Member of SGS Group

## 7. EFFECTIVE RADIATED POWER AND EQUIVALENT ISOTROPIC RADIATED POWER MEASUREMENT

### 7.1. Standard Applicable

According to FCC §2.1046

FCC 22.913(a) Mobile station is limited to 7W ERP.

FCC 24.232(c) Mobile and portable stations are limited to 2 W EIRP.

FCC 27.50(c) (10) Control stations and mobile stations are limited to 3 W ERP.

FCC 27.50(d)(4) Fixed, mobile, and portable (hand-held) stations are limited to 1W EIRP.

FCC 27, 50(h)(2) Mobile and other user stations. Mobile stations are limited to 2 W EIRP

### 7.2. Test SET-UP

(A) Radiated Power Test Set-Up, Frequency Below 1000MHz

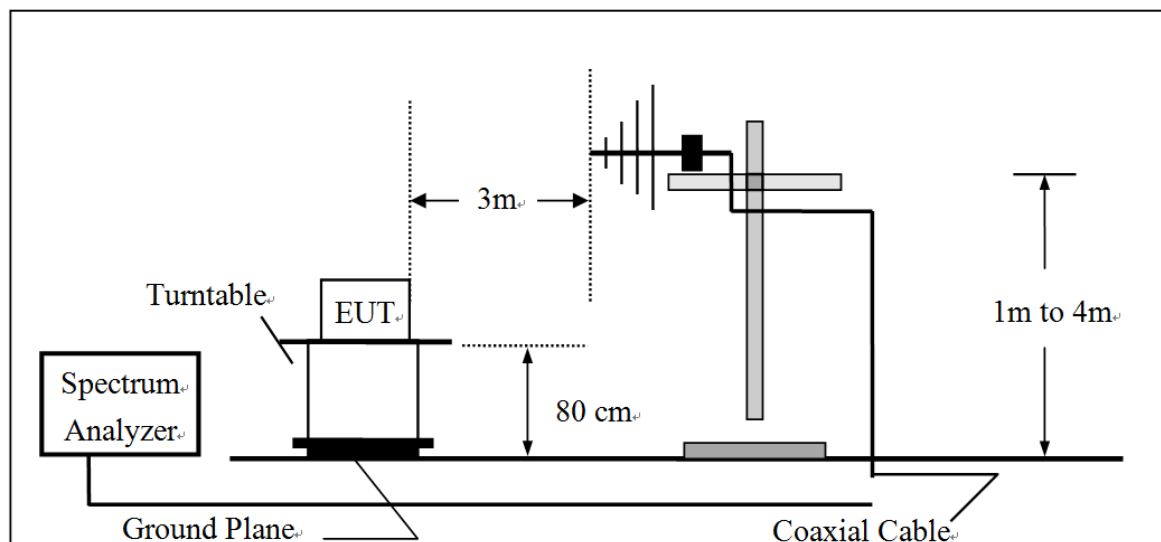

Unless otherwise stated the results shown in this test report refer only to the sample(s) tested and such sample(s) are retained for 90 days only.

除非另有說明，此報告結果僅對測試之樣品負責，同時此樣品僅保留90天。本報告未經本公司書面許可，不可部份複製。

This document is issued by the Company subject to its General Conditions of Service printed overleaf, available on request or accessible at [www.sgs.com/terms\\_and\\_conditions.htm](http://www.sgs.com/terms_and_conditions.htm) and, for electronic format documents, subject to Terms and Conditions for Electronic Documents at [www.sgs.com/terms\\_e-document.htm](http://www.sgs.com/terms_e-document.htm). Attention is drawn to the limitation of liability, indemnification and jurisdiction issues defined therein. Any holder of this document is advised that information contained hereon reflects the Company's findings at the time of its intervention only and within the limits of Client's instructions, if any. The Company's sole responsibility is to its Client and this document does not exonerate parties to a transaction from exercising all their rights and obligations under the transaction documents. This document cannot be reproduced except in full, without prior written approval of the Company. Any unauthorized alteration, forgery or falsification of the content or appearance of this document is unlawful and offenders may be prosecuted to the fullest extent of the law.

SGS Taiwan Ltd.

No.134,WuKungRoad,NewTaipeiIndustrialPark,WukuDistrict,NewTaipeiCity,Taiwan24803/新北市五股區新北產業園區五工路 134 號

台灣檢驗科技股份有限公司

t (886-2) 2299-3279

f (886-2) 2298-0488

www.tw.sgs.com

Member of SGS Group

(B) Radiated Power Test Set-UP Frequency Over 1 GHz

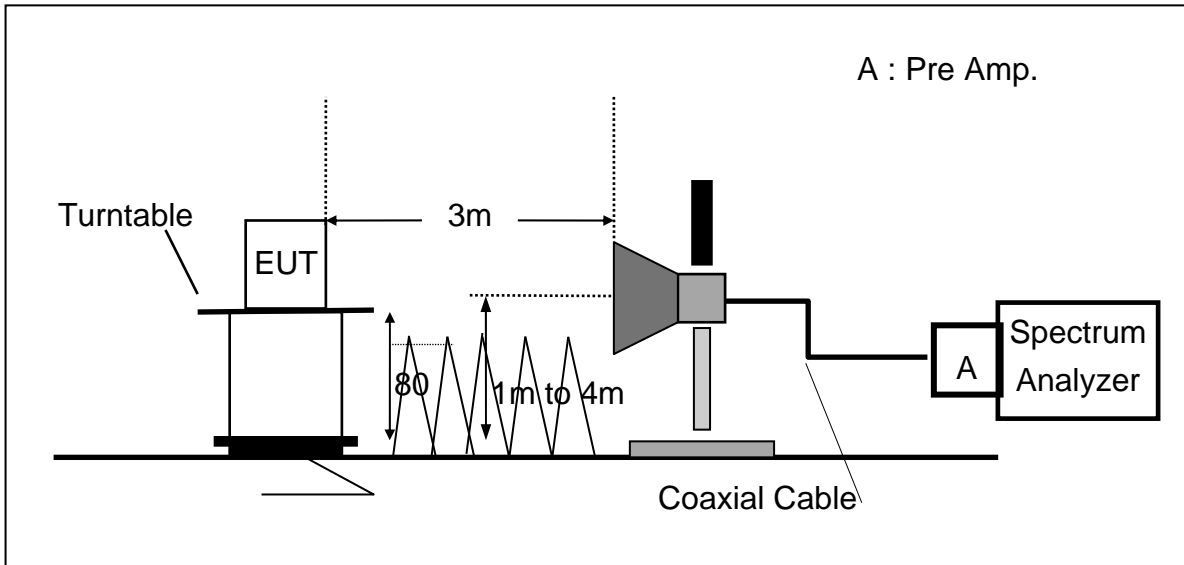

(C) Substituted Method Test Set-UP

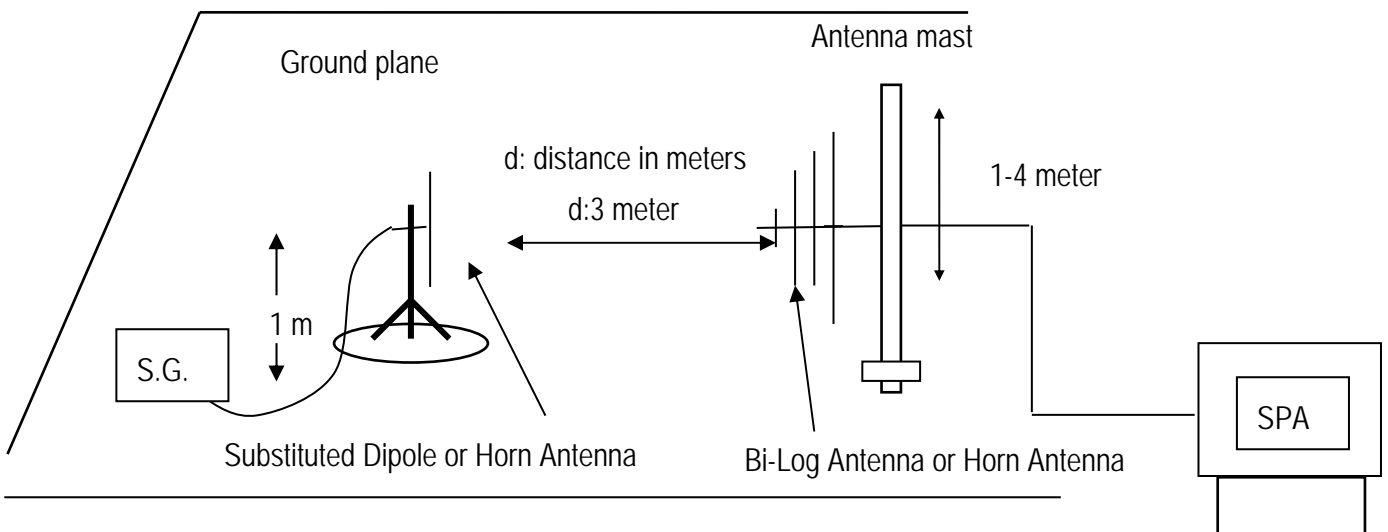

Unless otherwise stated the results shown in this test report refer only to the sample(s) tested and such sample(s) are retained for 90 days only.

除非另有說明，此報告結果僅對測試之樣品負責，同時此樣品僅保留90天。本報告未經本公司書面許可，不可部份複製。

This document is issued by the Company subject to its General Conditions of Service printed overleaf, available on request or accessible at [www.sgs.com/terms\\_and\\_conditions.htm](http://www.sgs.com/terms_and_conditions.htm) and, for electronic format documents, subject to Terms and Conditions for Electronic Documents at [www.sgs.com/terms\\_e-document.htm](http://www.sgs.com/terms_e-document.htm). Attention is drawn to the limitation of liability, indemnification and jurisdiction issues defined therein. Any holder of this document is advised that information contained hereon reflects the Company's findings at the time of its intervention only and within the limits of Client's instructions, if any. The Company's sole responsibility is to its Client and this document does not exonerate parties to a transaction from exercising all their rights and obligations under the transaction documents. This document cannot be reproduced except in full, without prior written approval of the Company. Any unauthorized alteration, forgery or falsification of the content or appearance of this document is unlawful and offenders may be prosecuted to the fullest extent of the law.

### 7.3. Measurement Procedure

1. The testing follows the Measurement Procedure of FCC KDB 971168 D01
2. The EUT was placed on a non-conductive turntable using a non-conductive support. The radiated emission at the fundamental frequency was measured at 3 m with a test antenna and EMI spectrum analyzer.
3. During the measurement, the EUT was communication with the station. The highest emission was recorded with the rotation of the turntable and the lowering of the test antenna from 4m to 1m. The reading was recorded and the field strength (E in dBuV/m) was calculated
4. The testing follows the Measurement Procedure of FCC KDB 971168 D01
5. The substitution horn antenna is substituted for EUT at the same position and signals generator export the CW signal to the substitution antenna via a tx cable. Rotated the Turn Table and moved receiving antenna to find the maximum radiation power. Adjust output power level of S.G to get a Value of spectrum reading equal to "Read Value" of step b. Record the power level of S.G.
6.  $ERP = S.G. \text{ output (dBm)} + \text{Antenna Gain (dBd)} - \text{Cable Loss (dB)}$
7.  $ERP = S.G. \text{ output (dBm)} + \text{Antenna Gain (dBd)} - \text{Cable Loss (dB)}$
8. Spectrum setting:
  - (1) Detector = Peak, marker the highest value of the detector by maximum hold, set RBW wide enough to capture the entire signal of emission, and  $VBW \geq 3 \times RBW$ .
  - (2) KDB 971168 D01 is adopted, and the procedure as lists under item 4, Measurement of the Average Power over the Fundamental Signal Bandwidth, is followed to set correspondingly for the acquisition of proper measurement data.Set frequency = nominal signal center frequency;  
Set span = 2 X occupied BW;  
Set RBW  $\approx$  1~5% of the span, not to exceed 1 MHz  
Set VBW = 3 x RBW;  
Select average power (RMS) detector  
Set sweep time and number of measurement points to achieve a minimum of 1 millisecond/pt integration time (ex. Point = 601points, then sweep time =  $601 \times 10^{-3} = 6s$ .)

Activate trace averaging routine over a minimum of 10 sweeps;

Activate marker/span pair and set span = signal or channel bandwidth;

Activate the band/interval power marker function;

Record the band power level;

Record adjusted value as the average signal power level. Then activate the occupied bandwidth measurement function.

The proper adjustment due to limitation of spectrum capability is given compensated to spectrum with conversion factor of  $10 \times \log(TBW/RBW)$ , where TBW is the transmission of UE exceeding the maximum BW UE can extends, and RBW is the resolution BW in UE.

Unless otherwise stated the results shown in this test report refer only to the sample(s) tested and such sample(s) are retained for 90 days only.

除非另有說明，此報告結果僅對測試之樣品負責，同時此樣品僅保留90天。本報告未經本公司書面許可，不可部份複製。

This document is issued by the Company subject to its General Conditions of Service printed overleaf, available on request or accessible at [www.sgs.com/terms\\_and\\_conditions.htm](http://www.sgs.com/terms_and_conditions.htm) and, for electronic format documents, subject to Terms and Conditions for Electronic Documents at [www.sgs.com/terms\\_e-document.htm](http://www.sgs.com/terms_e-document.htm). Attention is drawn to the limitation of liability, indemnification and jurisdiction issues defined therein. Any holder of this document is advised that information contained hereon reflects the Company's findings at the time of its intervention only and within the limits of Client's instructions, if any. The Company's sole responsibility is to its Client and this document does not exonerate parties to a transaction from exercising all their rights and obligations under the transaction documents. This document cannot be reproduced except in full, without prior written approval of the Company. Any unauthorized alteration, forgery or falsification of the content or appearance of this document is unlawful and offenders may be prosecuted to the fullest extent of the law.



#### 7.4. Measurement Equipment Used

ERP, EIRP MEASUREMENT EQUIPMENT List 966 Chamber					
EQUIPMENT TYPE	MFR	MODEL NUMBER	SERIAL NUMBER	LAST CAL.	CAL DUE.
EMI Test Receiver	R&S	ESCI7	100760	05/11/2017	05/10/2018
Spectrum Analyzer	Agilent	E4446A	MY51100003	04/25/2017	04/24/2018
Loop Antenna	ETS-Lindgren	6502	148045	09/20/2016	09/19/2017
Bilog Antenna	SCHWAZBECK	VULB9168	378	12/19/2016	12/18/2017
Horn Antenna	Schwarzbeck	BBHA9120D	1441	08/01/2016	07/31/2017
Pre-Amplifier	Agilent	8447D	2944A07676	01/05/2017	01/04/2018
Pre-Amplifier	EMC Instruments Corp.	EMC0126530	980038	01/05/2017	01/04/2018
Turn Table	HD	DT420	N/A	N.C.R	N.C.R
Antenna Tower	ChamPro	AM-BS-4500-B	060776-ABS	N.C.R	N.C.R
Controller	ChamPro	EM1000	60776	N.C.R	N.C.R
Low Loss Cable	Huber Suhner	966_RX	9	01/05/2017	01/04/2018
3m Site NSA	SGS	966 chamber	N/A	07/01/2017	06/30/2018
Low Loss Cable	Huber Suhner	966 TX	1	01/05/2017	01/04/2018
Horn Antenna	Schwarzbeck	BBHA9170	184	12/12/2016	12/11/2017
Pre-Amplifier	EMC Instruments Corp.	EMC184045	980135	01/05/2017	01/04/2018
Radio Communication Analyzer	R&S	CMU200	102189	02/10/2017	02/09/2018
Radio Communication Analyer	Anritsu	MT8820C	6201465317	01/03/2017	01/02/2018

Unless otherwise stated the results shown in this test report refer only to the sample(s) tested and such sample(s) are retained for 90 days only.

除非另有說明，此報告結果僅對測試之樣品負責，同時此樣品僅保留90天。本報告未經本公司書面許可，不可部份複製。

This document is issued by the Company subject to its General Conditions of Service printed overleaf, available on request or accessible at [www.sgs.com/terms\\_and\\_conditions.htm](http://www.sgs.com/terms_and_conditions.htm) and, for electronic format documents, subject to Terms and Conditions for Electronic Documents at [www.sgs.com/terms\\_e-document.htm](http://www.sgs.com/terms_e-document.htm). Attention is drawn to the limitation of liability, indemnification and jurisdiction issues defined therein. Any holder of this document is advised that information contained hereon reflects the Company's findings at the time of its intervention only and within the limits of Client's instructions, if any. The Company's sole responsibility is to its Client and this document does not exonerate parties to a transaction from exercising all their rights and obligations under the transaction documents. This document cannot be reproduced except in full, without prior written approval of the Company. Any unauthorized alteration, forgery or falsification of the content or appearance of this document is unlawful and offenders may be prosecuted to the fullest extent of the law.

SGS Taiwan Ltd.

No.134,WuKungRoad,NewTaipeiIndustrialPark,WukuDistrict,NewTaipeiCity,Taiwan24803/新北市五股區新北產業園區五工路 134 號

台灣檢驗科技股份有限公司

t (886-2) 2299-3279

f (886-2) 2298-0488

www.tw.sgs.com

Member of SGS Group

### 7.5. Measurement Result: (Peak) –using option of peak measurement

EUT			Measurement					
Operation Band	Fundamental Frequency	CH	Antenna Pol.	S.G. Output	Antenna Gain	Cable Loss	ERP	Limit
	MHz		V/H	dBm	dBd	dB	dBm	dBm
GSM 850	824.2	128	V	7.38	3.31	-2.92	7.76	38.45
			H	14.99	3.31	-2.92	15.37	38.45
	836.6	190	V	7.41	3.29	-2.96	7.74	38.45
			H	14.33	3.29	-2.96	14.65	38.45
	848.8	251	V	1.54	3.27	-3.00	1.80	38.45
			H	15.39	3.27	-3.00	<b>15.65</b>	38.45
GPRS 850	824.2	128	V	9.68	3.31	-2.92	10.06	38.45
			H	18.77	3.31	-2.92	<b>19.15</b>	38.45
	836.6	190	V	10.01	3.29	-2.96	10.34	38.45
			H	17.56	3.29	-2.96	17.88	38.45
	848.8	251	V	9.05	3.27	-3.00	9.32	38.45
			H	17.70	3.27	-3.00	17.96	38.45
EDGE 850	824.2	128	V	8.79	3.31	-2.92	9.18	38.45
			H	16.57	3.31	-2.92	<b>16.95</b>	38.45
	836.6	190	V	8.65	3.29	-2.96	8.97	38.45
			H	15.16	3.29	-2.96	15.48	38.45
	848.8	251	V	6.73	3.27	-3.00	6.99	38.45
			H	15.82	3.27	-3.00	16.08	38.45

**Remark: The RBW,VBW of SPA for frequency RBW=300 KHz, VBW=1MHz**

Unless otherwise stated the results shown in this test report refer only to the sample(s) tested and such sample(s) are retained for 90 days only.

除非另有說明，此報告結果僅對測試之樣品負責，同時此樣品僅保留90天。本報告未經本公司書面許可，不可部份複製。

This document is issued by the Company subject to its General Conditions of Service printed overleaf, available on request or accessible at [www.sgs.com/terms\\_and\\_conditions.htm](http://www.sgs.com/terms_and_conditions.htm) and, for electronic format documents, subject to Terms and Conditions for Electronic Documents at [www.sgs.com/terms\\_e-document.htm](http://www.sgs.com/terms_e-document.htm). Attention is drawn to the limitation of liability, indemnification and jurisdiction issues defined therein. Any holder of this document is advised that information contained hereon reflects the Company's findings at the time of its intervention only and within the limits of Client's instructions, if any. The Company's sole responsibility is to its Client and this document does not exonerate parties to a transaction from exercising all their rights and obligations under the transaction documents. This document cannot be reproduced except in full, without prior written approval of the Company. Any unauthorized alteration, forgery or falsification of the content or appearance of this document is unlawful and offenders may be prosecuted to the fullest extent of the law.

EUT			Measurement					
Operation Band	Fundamental Frequency	CH	Antenna Pol.	S.G. Output	Antenna Gain	Cable Loss	ERP	Limit
	MHz		V/H	dBm	dBd	dB	dBm	dBm
GSM 1900	1850.2	512	V	12.97	9.94	-4.46	18.45	33.00
			H	15.92	9.94	-4.46	21.40	33.00
	1880.0	661	V	14.44	10.03	-4.51	19.97	33.00
			H	16.58	10.03	-4.51	22.10	33.00
	1909.8	810	V	14.07	10.13	-4.55	19.65	33.00
			H	16.86	10.13	-4.55	<b>22.44</b>	33.00
GPRS 1900	1850.2	512	V	15.86	9.94	-4.46	21.34	33.00
			H	20.81	9.94	-4.46	<b>26.29</b>	33.00
	1880.0	661	V	17.93	10.03	-4.51	23.45	33.00
			H	20.70	10.03	-4.51	26.22	33.00
	1909.8	810	V	17.75	10.13	-4.55	23.33	33.00
			H	20.20	10.13	-4.55	25.78	33.00
EDGE 1900	1850.2	512	V	14.43	9.94	-4.46	19.91	33.00
			H	19.07	9.94	-4.46	24.55	33.00
	1880.0	661	V	16.28	10.03	-4.51	21.81	33.00
			H	18.94	10.03	-4.51	24.47	33.00
	1909.8	810	V	15.70	10.13	-4.55	21.27	33.00
			H	19.15	10.13	-4.55	<b>24.72</b>	33.00

**Remark: The RBW,VBW of SPA for frequency RBW=300 KHz, VBW=1MHz**

Unless otherwise stated the results shown in this test report refer only to the sample(s) tested and such sample(s) are retained for 90 days only.

除非另有說明，此報告結果僅對測試之樣品負責，同時此樣品僅保留90天。本報告未經本公司書面許可，不可部份複製。

This document is issued by the Company subject to its General Conditions of Service printed overleaf, available on request or accessible at [www.sgs.com/terms\\_and\\_conditions.htm](http://www.sgs.com/terms_and_conditions.htm) and, for electronic format documents, subject to Terms and Conditions for Electronic Documents at [www.sgs.com/terms\\_e-document.htm](http://www.sgs.com/terms_e-document.htm). Attention is drawn to the limitation of liability, indemnification and jurisdiction issues defined therein. Any holder of this document is advised that information contained hereon reflects the Company's findings at the time of its intervention only and within the limits of Client's instructions, if any. The Company's sole responsibility is to its Client and this document does not exonerate parties to a transaction from exercising all their rights and obligations under the transaction documents. This document cannot be reproduced except in full, without prior written approval of the Company. Any unauthorized alteration, forgery or falsification of the content or appearance of this document is unlawful and offenders may be prosecuted to the fullest extent of the law.

SGS Taiwan Ltd.

No.134,WuKungRoad,NewTaipeiIndustrialPark,WukuDistrict,NewTaipeiCity,Taiwan24803/新北市五股區新北產業園區五工路 134 號

台灣檢驗科技股份有限公司

t (886-2) 2299-3279

f (886-2) 2298-0488

www.tw.sgs.com

Member of SGS Group

EUT			Measurement					
Operation Band	Fundamental Frequency	CH	Antenna Pol.	S.G. Output	Antenna Gain	Cable Loss	EIRP	Limit
	MHz		V/H	dBm	dBd	dB	dBm	dBm
GSM 1900	1850.2	512	V	12.97	9.94	-4.46	18.45	33.00
			H	15.92	9.94	-4.46	21.40	33.00
	1880.0	661	V	14.44	10.03	-4.51	19.97	33.00
			H	16.58	10.03	-4.51	22.10	33.00
	1909.8	810	V	14.07	10.13	-4.55	19.65	33.00
			H	16.86	10.13	-4.55	<b>22.44</b>	33.00
GPRS 1900	1850.2	512	V	15.86	9.94	-4.46	21.34	33.00
			H	20.81	9.94	-4.46	<b>26.29</b>	33.00
	1880.0	661	V	17.93	10.03	-4.51	23.45	33.00
			H	20.70	10.03	-4.51	26.22	33.00
	1909.8	810	V	17.75	10.13	-4.55	23.33	33.00
			H	20.20	10.13	-4.55	25.78	33.00
EDGE 1900	1850.2	512	V	14.43	9.94	-4.46	19.91	33.00
			H	19.07	9.94	-4.46	24.55	33.00
	1880.0	661	V	16.28	10.03	-4.51	21.81	33.00
			H	18.94	10.03	-4.51	24.47	33.00
	1909.8	810	V	15.70	10.13	-4.55	21.27	33.00
			H	19.15	10.13	-4.55	<b>24.72</b>	33.00

**Remark: The RBW,VBW of SPA for frequency RBW=300 KHz, VBW=1MHz**

Unless otherwise stated the results shown in this test report refer only to the sample(s) tested and such sample(s) are retained for 90 days only.

除非另有說明，此報告結果僅對測試之樣品負責，同時此樣品僅保留90天。本報告未經本公司書面許可，不可部份複製。

This document is issued by the Company subject to its General Conditions of Service printed overleaf, available on request or accessible at [www.sgs.com/terms\\_and\\_conditions.htm](http://www.sgs.com/terms_and_conditions.htm) and, for electronic format documents, subject to Terms and Conditions for Electronic Documents at [www.sgs.com/terms\\_e-document.htm](http://www.sgs.com/terms_e-document.htm). Attention is drawn to the limitation of liability, indemnification and jurisdiction issues defined therein. Any holder of this document is advised that information contained hereon reflects the Company's findings at the time of its intervention only and within the limits of Client's instructions, if any. The Company's sole responsibility is to its Client and this document does not exonerate parties to a transaction from exercising all their rights and obligations under the transaction documents. This document cannot be reproduced except in full, without prior written approval of the Company. Any unauthorized alteration, forgery or falsification of the content or appearance of this document is unlawful and offenders may be prosecuted to the fullest extent of the law.

SGS Taiwan Ltd.

No.134,WuKungRoad,NewTaipeiIndustrialPark,WukuDistrict,NewTaipeiCity,Taiwan24803/新北市五股區新北產業園區五工路 134 號

台灣檢驗科技股份有限公司

t (886-2) 2299-3279

f (886-2) 2298-0488

www.tw.sgs.com

Member of SGS Group

EUT			Measurement					
Operation Band	Fundamental Frequency	CH	Antenna Pol.	S.G. Output	Antenna Gain	Cable Loss	EIRP	Limit
	MHz		V/H	dBm	dBd	dB	dBm	dBm
WCDMA Band II	1852.4	9262	V	7.68	9.94	-4.46	13.16	33.00
			H	16.05	9.95	-4.46	<b>21.53</b>	33.00
	1880.0	9400	V	12.17	10.03	-4.51	17.69	33.00
			H	15.92	10.03	-4.51	21.45	33.00
	1907.6	9538	V	7.45	10.12	-4.55	13.02	33.00
			H	14.31	10.12	-4.55	19.88	33.00
HSDPA Band II	1852.4	9262	V	12.81	9.94	-4.46	18.29	33.00
			H	19.84	9.95	-4.46	<b>25.33</b>	33.00
	1880.0	9400	V	13.48	10.04	-4.51	19.01	33.00
			H	18.51	10.04	-4.51	24.04	33.00
	1907.6	9538	V	11.82	10.12	-4.55	17.39	33.00
			H	18.48	10.12	-4.55	24.05	33.00
HSUPA Band II	1852.4	9262	V	9.37	9.95	-4.46	14.85	33.00
			H	17.60	9.94	-4.46	<b>23.08</b>	33.00
	1880.0	9400	V	11.75	10.03	-4.51	17.27	33.00
			H	17.39	10.04	-4.51	22.92	33.00
	1907.6	9538	V	9.01	10.12	-4.55	14.58	33.00
			H	15.17	10.12	-4.55	20.74	33.00

**Remark: The RBW,VBW of SPA for frequency RBW=5 MHz, VBW=8 MHz**

Unless otherwise stated the results shown in this test report refer only to the sample(s) tested and such sample(s) are retained for 90 days only.

除非另有說明，此報告結果僅對測試之樣品負責，同時此樣品僅保留90天。本報告未經本公司書面許可，不可部份複製。

This document is issued by the Company subject to its General Conditions of Service printed overleaf, available on request or accessible at [www.sgs.com/terms\\_and\\_conditions.htm](http://www.sgs.com/terms_and_conditions.htm) and, for electronic format documents, subject to Terms and Conditions for Electronic Documents at [www.sgs.com/terms\\_e-document.htm](http://www.sgs.com/terms_e-document.htm). Attention is drawn to the limitation of liability, indemnification and jurisdiction issues defined therein. Any holder of this document is advised that information contained hereon reflects the Company's findings at the time of its intervention only and within the limits of Client's instructions, if any. The Company's sole responsibility is to its Client and this document does not exonerate parties to a transaction from exercising all their rights and obligations under the transaction documents. This document cannot be reproduced except in full, without prior written approval of the Company. Any unauthorized alteration, forgery or falsification of the content or appearance of this document is unlawful and offenders may be prosecuted to the fullest extent of the law.

SGS Taiwan Ltd.

No.134,WuKungRoad,NewTaipeiIndustrialPark,WukuDistrict,NewTaipeiCity,Taiwan24803/新北市五股區新北產業園區五工路 134 號

台灣檢驗科技股份有限公司

t (886-2) 2299-3279

f (886-2) 2298-0488

www.tw.sgs.com

Member of SGS Group

EUT			Measurement					
Operation Band	Fundamental Frequency	CH	Antenna Pol.	S.G. Output	Antenna Gain	Cable Loss	EIRP	Limit
	MHz		V/H	dBm	dBd	dB	dBm	dBm
WCDMA Band IV	1712.4	1312	V	10.17	9.48	-4.31	15.35	30.00
			H	15.57	9.48	-4.31	20.74	30.00
	1732.6	1413	V	11.17	9.55	-4.31	16.41	30.00
			H	16.28	9.55	-4.31	<b>21.52</b>	30.00
	1752.6	1513	V	9.06	9.62	-4.34	14.34	30.00
			H	14.57	9.62	-4.34	19.85	30.00
HSDPA Band IV	1712.4	1312	V	12.93	9.48	-4.31	18.11	30.00
			H	19.14	9.48	-4.31	<b>24.31</b>	30.00
	1732.6	1413	V	13.16	9.55	-4.31	18.40	30.00
			H	16.80	9.55	-4.31	22.04	30.00
	1752.6	1513	V	10.48	9.62	-4.34	15.77	30.00
			H	16.20	9.62	-4.34	21.49	30.00
HSUPA Band IV	1712.4	1312	V	11.28	9.48	-4.31	16.45	30.00
			H	17.65	9.48	-4.31	<b>22.83</b>	30.00
	1732.6	1413	V	11.77	9.55	-4.31	17.01	30.00
			H	16.26	9.55	-4.31	21.51	30.00
	1752.6	1513	V	10.10	9.62	-4.34	15.38	30.00
			H	15.15	9.62	-4.34	20.43	30.00

**Remark: The RBW,VBW of SPA for frequency RBW=5 MHz, VBW=8 MHz**

Unless otherwise stated the results shown in this test report refer only to the sample(s) tested and such sample(s) are retained for 90 days only.

除非另有說明，此報告結果僅對測試之樣品負責，同時此樣品僅保留90天。本報告未經本公司書面許可，不可部份複製。

This document is issued by the Company subject to its General Conditions of Service printed overleaf, available on request or accessible at [www.sgs.com/terms\\_and\\_conditions.htm](http://www.sgs.com/terms_and_conditions.htm) and, for electronic format documents, subject to Terms and Conditions for Electronic Documents at [www.sgs.com/terms\\_e-document.htm](http://www.sgs.com/terms_e-document.htm). Attention is drawn to the limitation of liability, indemnification and jurisdiction issues defined therein. Any holder of this document is advised that information contained hereon reflects the Company's findings at the time of its intervention only and within the limits of Client's instructions, if any. The Company's sole responsibility is to its Client and this document does not exonerate parties to a transaction from exercising all their rights and obligations under the transaction documents. This document cannot be reproduced except in full, without prior written approval of the Company. Any unauthorized alteration, forgery or falsification of the content or appearance of this document is unlawful and offenders may be prosecuted to the fullest extent of the law.

SGS Taiwan Ltd.

No.134,WuKungRoad,NewTaipeiIndustrialPark,WukuDistrict,NewTaipeiCity,Taiwan24803/新北市五股區新北產業園區五工路 134 號

台灣檢驗科技股份有限公司

t (886-2) 2299-3279

f (886-2) 2298-0488

www.tw.sgs.com

Member of SGS Group

EUT			Measurement					
Operation Band	Fundamental Frequency	CH	Antenna Pol.	S.G. Output	Antenna Gain	Cable Loss	ERP	Limit
	MHz		V/H	dBm	dBd	dB	dBm	dBm
WCDMA Band V	826.4	4132	V	4.02	3.30	-2.93	4.39	38.45
			H	10.35	3.30	-2.93	<b>10.72</b>	38.45
	836.6	4183	V	2.04	3.29	-2.97	2.36	38.45
			H	9.34	3.29	-2.96	9.66	38.45
	846.6	4233	V	0.38	3.27	-3.00	0.66	38.45
			H	9.15	3.27	-3.00	9.43	38.45
HSDPA Band V	826.4	4132	V	5.48	3.30	-2.93	5.85	38.45
			H	12.07	3.30	-2.93	<b>12.44</b>	38.45
	836.6	4183	V	3.31	3.29	-2.96	3.64	38.45
			H	10.44	3.29	-2.96	10.77	38.45
	846.6	4233	V	2.37	3.27	-3.00	2.65	38.45
			H	10.58	3.27	-3.00	10.85	38.45
HSUPA Band V	826.4	4132	V	4.63	3.30	-2.93	5.01	38.45
			H	11.33	3.30	-2.93	<b>11.71</b>	38.45
	836.6	4183	V	2.93	3.29	-2.96	3.26	38.45
			H	9.54	3.29	-2.96	9.87	38.45
	846.6	4233	V	1.49	3.27	-3.00	1.76	38.45
			H	9.88	3.27	-3.00	10.15	38.45

**Remark: The RBW,VBW of SPA for frequency RBW=5 MHz, VBW=8 MHz**

Unless otherwise stated the results shown in this test report refer only to the sample(s) tested and such sample(s) are retained for 90 days only.

除非另有說明，此報告結果僅對測試之樣品負責，同時此樣品僅保留90天。本報告未經本公司書面許可，不可部份複製。

This document is issued by the Company subject to its General Conditions of Service printed overleaf, available on request or accessible at [www.sgs.com/terms\\_and\\_conditions.htm](http://www.sgs.com/terms_and_conditions.htm) and, for electronic format documents, subject to Terms and Conditions for Electronic Documents at [www.sgs.com/terms\\_e-document.htm](http://www.sgs.com/terms_e-document.htm). Attention is drawn to the limitation of liability, indemnification and jurisdiction issues defined therein. Any holder of this document is advised that information contained hereon reflects the Company's findings at the time of its intervention only and within the limits of Client's instructions, if any. The Company's sole responsibility is to its Client and this document does not exonerate parties to a transaction from exercising all their rights and obligations under the transaction documents. This document cannot be reproduced except in full, without prior written approval of the Company. Any unauthorized alteration, forgery or falsification of the content or appearance of this document is unlawful and offenders may be prosecuted to the fullest extent of the law.

SGS Taiwan Ltd.

No.134,WuKungRoad,NewTaipeiIndustrialPark,WukuDistrict,NewTaipeiCity,Taiwan24803/新北市五股區新北產業園區五工路 134 號

台灣檢驗科技股份有限公司

t (886-2) 2299-3279

f (886-2) 2298-0488

www.tw.sgs.com

Member of SGS Group



EUT			Measurement					
Operation Band	Fundamental Frequency MHz	CH	Antenna Pol. V/H	S.G. Output dBm	Antenna Gain dBi	Cable Loss dB	EIRP dBm	Limit dBm
<b>BAND 2 BW: 1.4M QPSK RB: 1,0</b>	1850.7	18607	V	11.09	9.94	-4.46	16.57	33.01
			H	11.99	9.95	-4.46	17.47	33.01
	1880.0	18900	V	9.32	10.03	-4.51	14.84	33.01
			H	13.35	10.03	-4.51	<b>18.87</b>	33.01
	1909.3	19193	V	3.51	10.12	-4.55	9.08	33.01
			H	8.66	10.12	-4.55	14.23	33.01
<b>BAND 2 BW: 1.4M QPSK RB: 1,5</b>	1850.7	18607	V	11.09	9.94	-4.46	16.57	33.01
			H	11.98	9.94	-4.46	17.46	33.01
	1880.0	18900	V	9.26	10.03	-4.51	14.78	33.01
			H	13.31	10.03	-4.51	<b>18.84</b>	33.01
	1909.3	19193	V	3.22	10.12	-4.55	8.80	33.01
			H	8.43	10.12	-4.55	14.00	33.01
<b>BAND 2 BW: 1.4M 16QAM RB: 1,0</b>	1850.7	18607	V	11.17	9.94	-4.46	16.65	33.01
			H	12.12	9.94	-4.46	17.61	33.01
	1880.0	18900	V	9.14	10.03	-4.51	14.66	33.01
			H	13.30	10.03	-4.51	<b>18.83</b>	33.01
	1909.3	19193	V	3.48	10.12	-4.55	9.05	33.01
			H	8.61	10.12	-4.55	14.19	33.01
<b>BAND 2 BW: 1.4M 16QAM RB: 1,5</b>	1850.7	18607	V	11.12	9.94	-4.46	16.60	33.01
			H	11.87	9.94	-4.46	17.35	33.01
	1880.0	18900	V	8.93	10.03	-4.51	14.46	33.01
			H	13.54	10.03	-4.51	<b>19.06</b>	33.01
	1909.3	19193	V	3.19	10.12	-4.55	8.77	33.01
			H	8.28	10.12	-4.55	13.85	33.01

The RBW,VBW of SPA for frequency RBW= 8MHz , VBW= 8MHz

Unless otherwise stated the results shown in this test report refer only to the sample(s) tested and such sample(s) are retained for 90 days only.

除非另有說明，此報告結果僅對測試之樣品負責，同時此樣品僅保留90天。本報告未經本公司書面許可，不可部份複製。

This document is issued by the Company subject to its General Conditions of Service printed overleaf, available on request or accessible at [www.sgs.com/terms\\_and\\_conditions.htm](http://www.sgs.com/terms_and_conditions.htm) and, for electronic format documents, subject to Terms and Conditions for Electronic Documents at [www.sgs.com/terms\\_e-document.htm](http://www.sgs.com/terms_e-document.htm). Attention is drawn to the limitation of liability, indemnification and jurisdiction issues defined therein. Any holder of this document is advised that information contained hereon reflects the Company's findings at the time of its intervention only and within the limits of Client's instructions, if any. The Company's sole responsibility is to its Client and this document does not exonerate parties to a transaction from exercising all their rights and obligations under the transaction documents. This document cannot be reproduced except in full, without prior written approval of the Company. Any unauthorized alteration, forgery or falsification of the content or appearance of this document is unlawful and offenders may be prosecuted to the fullest extent of the law.

SGS Taiwan Ltd.

No.134,WuKungRoad,NewTaipeiIndustrialPark,WukuDistrict,NewTaipeiCity,Taiwan24803/新北市五股區新北產業園區五工路 134 號

台灣檢驗科技股份有限公司

t (886-2) 2299-3279

f (886-2) 2298-0488

www.tw.sgs.com

Member of SGS Group

EUT			Measurement					
Operation Band	Fundamental Frequency MHz	CH	Antenna Pol. V/H	S.G. Output dBm	Antenna Gain dBi	Cable Loss dB	EIRP dBm	Limit dBm
<b>BAND 2 BW: 3M QPSK RB: 1,0</b>	1851.5	18615	V	11.61	9.95	-4.46	17.09	33.01
			H	11.89	9.95	-4.46	17.38	33.01
	1880.0	18900	V	10.49	10.03	-4.50	16.01	33.01
			H	13.71	10.03	-4.50	<b>19.23</b>	33.01
	1908.5	19185	V	5.91	10.11	-4.55	11.48	33.01
			H	9.96	10.11	-4.55	15.53	33.01
<b>BAND 2 BW: 3M QPSK RB: 1,14</b>	1851.5	18615	V	11.28	9.94	-4.46	16.76	33.01
			H	12.02	9.94	-4.46	17.50	33.01
	1880.0	18900	V	10.19	10.03	-4.51	15.72	33.01
			H	13.24	10.03	-4.51	<b>18.77</b>	33.01
	1908.5	19185	V	4.60	10.12	-4.55	10.18	33.01
			H	9.01	10.12	-4.55	14.58	33.01
<b>BAND 2 BW: 3M 16QAM RB: 1,0</b>	1851.5	18615	V	11.47	9.95	-4.46	16.96	33.01
			H	11.82	9.94	-4.46	17.30	33.01
	1880.0	18900	V	10.41	10.02	-4.50	15.93	33.01
			H	13.81	10.02	-4.50	<b>19.33</b>	33.01
	1908.5	19185	V	5.94	10.11	-4.54	11.51	33.01
			H	10.18	10.11	-4.55	15.75	33.01
<b>BAND 2 BW: 3M 16QAM RB: 1,14</b>	1851.5	18615	V	11.28	9.94	-4.46	16.77	33.01
			H	11.75	9.94	-4.46	17.23	33.01
	1880.0	18900	V	10.08	10.03	-4.51	15.60	33.01
			H	13.10	10.03	-4.51	<b>18.62</b>	33.01
	1908.5	19185	V	4.53	10.12	-4.55	10.10	33.01
			H	8.97	10.12	-4.55	14.55	33.01

The RBW,VBW of SPA for frequency RBW= 8MHz , VBW= 8MHz

Unless otherwise stated the results shown in this test report refer only to the sample(s) tested and such sample(s) are retained for 90 days only.

除非另有說明，此報告結果僅對測試之樣品負責，同時此樣品僅保留90天。本報告未經本公司書面許可，不可部份複製。

This document is issued by the Company subject to its General Conditions of Service printed overleaf, available on request or accessible at [www.sgs.com/terms\\_and\\_conditions.htm](http://www.sgs.com/terms_and_conditions.htm) and, for electronic format documents, subject to Terms and Conditions for Electronic Documents at [www.sgs.com/terms\\_e-document.htm](http://www.sgs.com/terms_e-document.htm). Attention is drawn to the limitation of liability, indemnification and jurisdiction issues defined therein. Any holder of this document is advised that information contained hereon reflects the Company's findings at the time of its intervention only and within the limits of Client's instructions, if any. The Company's sole responsibility is to its Client and this document does not exonerate parties to a transaction from exercising all their rights and obligations under the transaction documents. This document cannot be reproduced except in full, without prior written approval of the Company. Any unauthorized alteration, forgery or falsification of the content or appearance of this document is unlawful and offenders may be prosecuted to the fullest extent of the law.

SGS Taiwan Ltd.

No.134,WuKungRoad,NewTaipeiIndustrialPark,WukuDistrict,NewTaipeiCity,Taiwan24803/新北市五股區新北產業園區五工路 134 號

台灣檢驗科技股份有限公司

t (886-2) 2299-3279

f (886-2) 2298-0488

www.tw.sgs.com

Member of SGS Group

EUT			Measurement					
Operation Band	Fundamental Frequency MHz	CH	Antenna Pol. V/H	S.G. Output dBm	Antenna Gain dBi	Cable Loss dB	EIRP dBm	Limit dBm
<b>BAND 2 BW: 5M QPSK RB: 1,0</b>	1852.5	18625	V	11.49	9.95	-4.46	16.97	33.01
			H	11.81	9.95	-4.46	17.30	33.01
	1880.0	18900	V	10.14	10.02	-4.50	15.66	33.01
			H	13.66	10.02	-4.50	<b>19.17</b>	33.01
	1907.5	19175	V	6.96	10.11	-4.54	12.52	33.01
			H	10.85	10.11	-4.54	16.42	33.01
<b>BAND 2 BW: 5M QPSK RB: 1,24</b>	1852.5	18625	V	10.64	9.95	-4.46	16.13	33.01
			H	11.71	9.95	-4.46	17.19	33.01
	1880.0	18900	V	9.80	10.04	-4.51	15.32	33.01
			H	12.87	10.04	-4.51	<b>18.40</b>	33.01
	1907.5	19175	V	4.30	10.12	-4.55	9.87	33.01
			H	9.00	10.12	-4.55	14.58	33.01
<b>BAND 2 BW: 5M 16QAM RB: 1,0</b>	1852.5	18625	V	11.26	9.95	-4.46	16.74	33.01
			H	11.67	9.94	-4.46	17.15	33.01
	1880.0	18900	V	10.28	10.02	-4.50	15.80	33.01
			H	13.66	10.02	-4.50	<b>19.18</b>	33.01
	1907.5	19175	V	6.65	10.11	-4.54	12.22	33.01
			H	10.62	10.11	-4.54	16.19	33.01
<b>BAND 2 BW: 5M 16QAM RB: 1,24</b>	1852.5	18625	V	10.50	9.95	-4.46	15.98	33.01
			H	11.63	9.95	-4.46	17.11	33.01
	1880.0	18900	V	9.76	10.04	-4.51	15.29	33.01
			H	12.82	10.04	-4.51	<b>18.34</b>	33.01
	1907.5	19175	V	4.30	10.12	-4.55	9.88	33.01
			H	8.87	10.12	-4.55	14.45	33.01

The RBW,VBW of SPA for frequency RBW= 8MHz , VBW= 8MHz

Unless otherwise stated the results shown in this test report refer only to the sample(s) tested and such sample(s) are retained for 90 days only.

除非另有說明，此報告結果僅對測試之樣品負責，同時此樣品僅保留90天。本報告未經本公司書面許可，不可部份複製。

This document is issued by the Company subject to its General Conditions of Service printed overleaf, available on request or accessible at [www.sgs.com/terms\\_and\\_conditions.htm](http://www.sgs.com/terms_and_conditions.htm) and, for electronic format documents, subject to Terms and Conditions for Electronic Documents at [www.sgs.com/terms\\_e-document.htm](http://www.sgs.com/terms_e-document.htm). Attention is drawn to the limitation of liability, indemnification and jurisdiction issues defined therein. Any holder of this document is advised that information contained hereon reflects the Company's findings at the time of its intervention only and within the limits of Client's instructions, if any. The Company's sole responsibility is to its Client and this document does not exonerate parties to a transaction from exercising all their rights and obligations under the transaction documents. This document cannot be reproduced except in full, without prior written approval of the Company. Any unauthorized alteration, forgery or falsification of the content or appearance of this document is unlawful and offenders may be prosecuted to the fullest extent of the law.

SGS Taiwan Ltd.

No.134,WuKungRoad,NewTaipeiIndustrialPark,WukuDistrict,NewTaipeiCity,Taiwan24803/新北市五股區新北產業園區五工路 134 號

台灣檢驗科技股份有限公司

t (886-2) 2299-3279

f (886-2) 2298-0488

www.tw.sgs.com

Member of SGS Group

EUT			Measurement					
Operation Band	Fundamental Frequency MHz	CH	Antenna Pol. V/H	S.G. Output dBm	Antenna Gain dBi	Cable Loss dB	EIRP dBm	Limit dBm
<b>BAND 2 BW: 10M QPSK RB: 1,0</b>	1855.0	18650	V	11.38	9.95	-4.46	16.86	33.01
			H	11.82	9.95	-4.46	17.31	33.01
	1880.0	18900	V	10.73	10.01	-4.50	16.24	33.01
			H	14.11	10.01	-4.50	<b>19.63</b>	33.01
	1905.0	19150	V	8.16	10.09	-4.54	13.72	33.01
			H	11.66	10.09	-4.54	17.21	33.01
<b>BAND 2 BW: 10M QPSK RB: 1,49</b>	1855.0	18650	V	9.84	9.96	-4.47	15.33	33.01
			H	12.09	9.96	-4.47	17.58	33.01
	1880.0	18900	V	9.20	10.04	-4.51	14.73	33.01
			H	12.07	10.04	-4.51	<b>17.60</b>	33.01
	1905.0	19150	V	4.34	10.12	-4.55	9.92	33.01
			H	8.93	10.12	-4.55	14.50	33.01
<b>BAND 2 BW: 10M 16QAM RB: 1,0</b>	1855.0	18650	V	11.26	9.95	-4.46	16.74	33.01
			H	11.79	9.95	-4.46	17.27	33.01
	1880.0	18900	V	10.00	10.02	-4.50	15.52	33.01
			H	13.49	10.02	-4.50	<b>19.01</b>	33.01
	1905.0	19150	V	8.38	10.09	-4.54	13.93	33.01
			H	11.52	10.09	-4.54	17.08	33.01
<b>BAND 2 BW: 10M 16QAM RB: 1,49</b>	1855.0	18650	V	9.74	9.96	-4.47	15.23	33.01
			H	12.05	9.96	-4.47	17.54	33.01
	1880.0	18900	V	9.28	10.04	-4.51	14.81	33.01
			H	12.35	10.04	-4.51	<b>17.88</b>	33.01
	1905.0	19150	V	4.35	10.12	-4.55	9.93	33.01
			H	9.00	10.12	-4.55	14.57	33.01

The RBW,VBW of SPA for frequency RBW= 8MHz , VBW= 8MHz

Unless otherwise stated the results shown in this test report refer only to the sample(s) tested and such sample(s) are retained for 90 days only.

除非另有說明，此報告結果僅對測試之樣品負責，同時此樣品僅保留90天。本報告未經本公司書面許可，不可部份複製。

This document is issued by the Company subject to its General Conditions of Service printed overleaf, available on request or accessible at [www.sgs.com/terms\\_and\\_conditions.htm](http://www.sgs.com/terms_and_conditions.htm) and, for electronic format documents, subject to Terms and Conditions for Electronic Documents at [www.sgs.com/terms\\_e-document.htm](http://www.sgs.com/terms_e-document.htm). Attention is drawn to the limitation of liability, indemnification and jurisdiction issues defined therein. Any holder of this document is advised that information contained hereon reflects the Company's findings at the time of its intervention only and within the limits of Client's instructions, if any. The Company's sole responsibility is to its Client and this document does not exonerate parties to a transaction from exercising all their rights and obligations under the transaction documents. This document cannot be reproduced except in full, without prior written approval of the Company. Any unauthorized alteration, forgery or falsification of the content or appearance of this document is unlawful and offenders may be prosecuted to the fullest extent of the law.

SGS Taiwan Ltd.

No.134,WuKungRoad,NewTaipeiIndustrialPark,WukuDistrict,NewTaipeiCity,Taiwan24803/新北市五股區新北產業園區五工路 134 號

台灣檢驗科技股份有限公司

t (886-2) 2299-3279

f (886-2) 2298-0488

www.tw.sgs.com

Member of SGS Group

EUT			Measurement					
Operation Band	Fundamental Frequency MHz	CH	Antenna Pol. V/H	S.G. Output dBm	Antenna Gain dBi	Cable Loss dB	EIRP dBm	Limit dBm
<b>BAND 2 BW: 15M QPSK RB: 1,0</b>	1857.5	18675	V	11.48	9.94	-4.46	16.96	33.01
			H	11.74	9.94	-4.46	17.22	33.01
	1880.0	18900	V	10.33	10.01	-4.50	15.84	33.01
			H	13.83	10.01	-4.50	<b>19.34</b>	33.01
	1902.5	19125	V	7.39	10.08	-4.53	12.94	33.01
			H	11.09	10.08	-4.53	16.64	33.01
<b>BAND 2 BW: 15M QPSK RB: 1,74</b>	1857.5	18675	V	10.02	9.98	-4.48	15.52	33.01
			H	13.14	9.98	-4.48	<b>18.63</b>	33.01
	1880.0	18900	V	8.32	10.05	-4.52	13.85	33.01
			H	11.25	10.05	-4.52	16.79	33.01
	1902.5	19125	V	4.31	10.12	-4.55	9.89	33.01
			H	8.94	10.12	-4.55	14.51	33.01
<b>BAND 2 BW: 15M 16QAM RB: 1,0</b>	1857.5	18675	V	11.03	9.94	-4.46	16.51	33.01
			H	11.71	9.95	-4.46	17.20	33.01
	1880.0	18900	V	10.22	10.01	-4.50	15.73	33.01
			H	14.11	10.01	-4.50	<b>19.62</b>	33.01
	1902.5	19125	V	7.44	10.08	-4.53	12.99	33.01
			H	11.02	10.08	-4.53	16.57	33.01
<b>BAND 2 BW: 15M 16QAM RB: 1,74</b>	1857.5	18675	V	9.94	9.98	-4.48	15.44	33.01
			H	12.94	9.98	-4.48	<b>18.44</b>	33.01
	1880.0	18900	V	8.28	10.05	-4.52	13.82	33.01
			H	11.46	10.05	-4.52	16.99	33.01
	1902.5	19125	V	4.22	10.12	-4.55	9.79	33.01
			H	8.89	10.12	-4.55	14.47	33.01

The RBW,VBW of SPA for frequency RBW= 8MHz , VBW= 8MHz

Unless otherwise stated the results shown in this test report refer only to the sample(s) tested and such sample(s) are retained for 90 days only.

除非另有說明，此報告結果僅對測試之樣品負責，同時此樣品僅保留90天。本報告未經本公司書面許可，不可部份複製。

This document is issued by the Company subject to its General Conditions of Service printed overleaf, available on request or accessible at [www.sgs.com/terms\\_and\\_conditions.htm](http://www.sgs.com/terms_and_conditions.htm) and, for electronic format documents, subject to Terms and Conditions for Electronic Documents at [www.sgs.com/terms\\_e-document.htm](http://www.sgs.com/terms_e-document.htm). Attention is drawn to the limitation of liability, indemnification and jurisdiction issues defined therein. Any holder of this document is advised that information contained hereon reflects the Company's findings at the time of its intervention only and within the limits of Client's instructions, if any. The Company's sole responsibility is to its Client and this document does not exonerate parties to a transaction from exercising all their rights and obligations under the transaction documents. This document cannot be reproduced except in full, without prior written approval of the Company. Any unauthorized alteration, forgery or falsification of the content or appearance of this document is unlawful and offenders may be prosecuted to the fullest extent of the law.

SGS Taiwan Ltd.

No.134,WuKungRoad,NewTaipeiIndustrialPark,WukuDistrict,NewTaipeiCity,Taiwan24803/新北市五股區新北產業園區五工路 134 號

台灣檢驗科技股份有限公司

t (886-2) 2299-3279

f (886-2) 2298-0488

www.tw.sgs.com

Member of SGS Group

EUT			Measurement					
Operation Band	Fundamental Frequency MHz	CH	Antenna Pol. V/H	S.G. Output dBm	Antenna Gain dBi	Cable Loss dB	EIRP dBm	Limit dBm
<b>BAND 2 BW: 20M QPSK RB: 1,0</b>	1860.0	18700	V	11.34	9.95	-4.46	16.83	33.01
			H	11.66	9.95	-4.46	17.14	33.01
	1880.0	18900	V	10.37	10.00	-4.49	15.88	33.01
			H	14.09	10.00	-4.49	<b>19.60</b>	33.01
	1900.0	19100	V	7.63	10.07	-4.52	13.17	33.01
			H	10.73	10.07	-4.52	16.27	33.01
<b>BAND 2 BW: 20M QPSK RB: 1,99</b>	1860.0	18700	V	10.52	9.99	-4.49	16.02	33.01
			H	13.98	9.99	-4.49	<b>19.49</b>	33.01
	1880.0	18900	V	8.00	10.06	-4.52	13.54	33.01
			H	10.92	10.06	-4.52	16.45	33.01
	1900.0	19100	V	4.48	10.12	-4.55	10.05	33.01
			H	9.05	10.12	-4.55	14.62	33.01
<b>BAND 2 BW: 20M 16QAM RB: 1,0</b>	1860.0	18700	V	11.12	9.95	-4.46	16.61	33.01
			H	12.13	9.94	-4.46	17.61	33.01
	1880.0	18900	V	9.76	10.00	-4.49	15.27	33.01
			H	14.04	10.00	-4.49	<b>19.55</b>	33.01
	1900.0	19100	V	7.61	10.07	-4.52	13.16	33.01
			H	10.67	10.07	-4.52	16.21	33.01
<b>BAND 2 BW: 20M 16QAM RB: 1,99</b>	1860.0	18700	V	10.29	9.99	-4.49	15.80	33.01
			H	13.81	9.99	-4.49	<b>19.32</b>	33.01
	1880.0	18900	V	7.82	10.06	-4.52	13.36	33.01
			H	11.13	10.06	-4.52	16.66	33.01
	1900.0	19100	V	4.39	10.12	-4.55	9.96	33.01
			H	8.95	10.12	-4.55	14.52	33.01

The RBW,VBW of SPA for frequency RBW= 8MHz , VBW= 8MHz

Unless otherwise stated the results shown in this test report refer only to the sample(s) tested and such sample(s) are retained for 90 days only.

除非另有說明，此報告結果僅對測試之樣品負責，同時此樣品僅保留90天。本報告未經本公司書面許可，不可部份複製。

This document is issued by the Company subject to its General Conditions of Service printed overleaf, available on request or accessible at [www.sgs.com/terms\\_and\\_conditions.htm](http://www.sgs.com/terms_and_conditions.htm) and, for electronic format documents, subject to Terms and Conditions for Electronic Documents at [www.sgs.com/terms\\_e-document.htm](http://www.sgs.com/terms_e-document.htm). Attention is drawn to the limitation of liability, indemnification and jurisdiction issues defined therein. Any holder of this document is advised that information contained hereon reflects the Company's findings at the time of its intervention only and within the limits of Client's instructions, if any. The Company's sole responsibility is to its Client and this document does not exonerate parties to a transaction from exercising all their rights and obligations under the transaction documents. This document cannot be reproduced except in full, without prior written approval of the Company. Any unauthorized alteration, forgery or falsification of the content or appearance of this document is unlawful and offenders may be prosecuted to the fullest extent of the law.

SGS Taiwan Ltd.

No.134,WuKungRoad,NewTaipeiIndustrialPark,WukuDistrict,NewTaipeiCity,Taiwan24803/新北市五股區新北產業園區五工路 134 號

台灣檢驗科技股份有限公司

t (886-2) 2299-3279

f (886-2) 2298-0488

www.tw.sgs.com

Member of SGS Group



EUT			Measurement					
Operation Band	Fundamental Frequency MHz	CH	Antenna Pol. V/H	S.G. Output dBm	Antenna Gain dBi	Cable Loss dB	EIRP dBm	Limit dBm
<b>BAND 4 BW: 1.4M QPSK RB: 1,0</b>	1710.7	19957	V	11.09	9.94	-4.46	16.57	30.00
			H	11.99	9.95	-4.46	17.47	30.00
	1732.5	20175	V	9.32	10.03	-4.51	14.84	30.00
			H	13.35	10.03	-4.51	<b>18.87</b>	30.00
	1754.3	20393	V	3.51	10.12	-4.55	9.08	30.00
			H	8.66	10.12	-4.55	14.23	30.00
<b>BAND 4 BW: 1.4M QPSK RB: 1,5</b>	1710.7	19957	V	11.09	9.94	-4.46	16.57	30.00
			H	11.98	9.94	-4.46	17.46	30.00
	1732.5	20175	V	9.26	10.03	-4.51	14.78	30.00
			H	13.31	10.03	-4.51	<b>18.84</b>	30.00
	1754.3	20393	V	3.22	10.12	-4.55	8.80	30.00
			H	8.43	10.12	-4.55	14.00	30.00
<b>BAND 4 BW: 1.4M 16QAM RB: 1,0</b>	1710.7	19957	V	11.17	9.94	-4.46	16.65	30.00
			H	12.12	9.94	-4.46	17.61	30.00
	1732.5	20175	V	9.14	10.03	-4.51	14.66	30.00
			H	13.30	10.03	-4.51	<b>18.83</b>	30.00
	1754.3	20393	V	3.48	10.12	-4.55	9.05	30.00
			H	8.61	10.12	-4.55	14.19	30.00
<b>BAND 4 BW: 1.4M 16QAM RB: 1,5</b>	1710.7	19957	V	11.12	9.94	-4.46	16.60	30.00
			H	11.87	9.94	-4.46	17.35	30.00
	1732.5	20175	V	8.93	10.03	-4.51	14.46	30.00
			H	13.54	10.03	-4.51	<b>19.06</b>	30.00
	1754.3	20393	V	3.19	10.12	-4.55	8.77	30.00
			H	8.28	10.12	-4.55	13.85	30.00

The RBW,VBW of SPA for frequency RBW= 8MHz , VBW= 8MHz

Unless otherwise stated the results shown in this test report refer only to the sample(s) tested and such sample(s) are retained for 90 days only.

除非另有說明，此報告結果僅對測試之樣品負責，同時此樣品僅保留90天。本報告未經本公司書面許可，不可部份複製。

This document is issued by the Company subject to its General Conditions of Service printed overleaf, available on request or accessible at [www.sgs.com/terms\\_and\\_conditions.htm](http://www.sgs.com/terms_and_conditions.htm) and, for electronic format documents, subject to Terms and Conditions for Electronic Documents at [www.sgs.com/terms\\_e-document.htm](http://www.sgs.com/terms_e-document.htm). Attention is drawn to the limitation of liability, indemnification and jurisdiction issues defined therein. Any holder of this document is advised that information contained hereon reflects the Company's findings at the time of its intervention only and within the limits of Client's instructions, if any. The Company's sole responsibility is to its Client and this document does not exonerate parties to a transaction from exercising all their rights and obligations under the transaction documents. This document cannot be reproduced except in full, without prior written approval of the Company. Any unauthorized alteration, forgery or falsification of the content or appearance of this document is unlawful and offenders may be prosecuted to the fullest extent of the law.

SGS Taiwan Ltd.

No.134,WuKungRoad,NewTaipeiIndustrialPark,WukuDistrict,NewTaipeiCity,Taiwan24803/新北市五股區新北產業園區五工路 134 號

台灣檢驗科技股份有限公司

t (886-2) 2299-3279

f (886-2) 2298-0488

www.tw.sgs.com

Member of SGS Group



EUT			Measurement					
Operation Band	Fundamental Frequency MHz	CH	Antenna Pol. V/H	S.G. Output dBm	Antenna Gain dBi	Cable Loss dB	EIRP dBm	Limit dBm
<b>BAND 4 BW: 3M QPSK RB: 1,0</b>	1711.5	19965	V	11.61	9.95	-4.46	17.09	30.00
			H	11.89	9.95	-4.46	17.38	30.00
	1732.5	20175	V	10.49	10.03	-4.50	16.01	30.00
			H	13.71	10.03	-4.50	<b>19.23</b>	30.00
	1753.5	20385	V	5.91	10.11	-4.55	11.48	30.00
			H	9.96	10.11	-4.55	15.53	30.00
<b>BAND 4 BW: 3M QPSK RB: 1,14</b>	1711.5	19965	V	11.28	9.94	-4.46	16.76	30.00
			H	12.02	9.94	-4.46	17.50	30.00
	1732.5	20175	V	10.19	10.03	-4.51	15.72	30.00
			H	13.24	10.03	-4.51	<b>18.77</b>	30.00
	1753.5	20385	V	4.60	10.12	-4.55	10.18	30.00
			H	9.01	10.12	-4.55	14.58	30.00
<b>BAND 4 BW: 3M 16QAM RB: 1,0</b>	1711.5	19965	V	11.47	9.95	-4.46	16.96	30.00
			H	11.82	9.94	-4.46	17.30	30.00
	1732.5	20175	V	10.41	10.02	-4.50	15.93	30.00
			H	13.81	10.02	-4.50	<b>19.33</b>	30.00
	1753.5	20385	V	5.94	10.11	-4.54	11.51	30.00
			H	10.18	10.11	-4.55	15.75	30.00
<b>BAND 4 BW: 3M 16QAM RB: 1,14</b>	1711.5	19965	V	11.28	9.94	-4.46	16.77	30.00
			H	11.75	9.94	-4.46	17.23	30.00
	1732.5	20175	V	10.08	10.03	-4.51	15.60	30.00
			H	13.10	10.03	-4.51	<b>18.62</b>	30.00
	1753.5	20385	V	4.53	10.12	-4.55	10.10	30.00
			H	8.97	10.12	-4.55	14.55	30.00

The RBW,VBW of SPA for frequency RBW= 8MHz , VBW= 8MHz

Unless otherwise stated the results shown in this test report refer only to the sample(s) tested and such sample(s) are retained for 90 days only.

除非另有說明，此報告結果僅對測試之樣品負責，同時此樣品僅保留90天。本報告未經本公司書面許可，不可部份複製。

This document is issued by the Company subject to its General Conditions of Service printed overleaf, available on request or accessible at [www.sgs.com/terms\\_and\\_conditions.htm](http://www.sgs.com/terms_and_conditions.htm) and, for electronic format documents, subject to Terms and Conditions for Electronic Documents at [www.sgs.com/terms\\_e-document.htm](http://www.sgs.com/terms_e-document.htm). Attention is drawn to the limitation of liability, indemnification and jurisdiction issues defined therein. Any holder of this document is advised that information contained hereon reflects the Company's findings at the time of its intervention only and within the limits of Client's instructions, if any. The Company's sole responsibility is to its Client and this document does not exonerate parties to a transaction from exercising all their rights and obligations under the transaction documents. This document cannot be reproduced except in full, without prior written approval of the Company. Any unauthorized alteration, forgery or falsification of the content or appearance of this document is unlawful and offenders may be prosecuted to the fullest extent of the law.

SGS Taiwan Ltd.

No.134,WuKungRoad,NewTaipeiIndustrialPark,WukuDistrict,NewTaipeiCity,Taiwan24803/新北市五股區新北產業園區五工路 134 號

台灣檢驗科技股份有限公司

t (886-2) 2299-3279

f (886-2) 2298-0488

www.tw.sgs.com

Member of SGS Group

EUT			Measurement					
Operation Band	Fundamental Frequency MHz	CH	Antenna Pol. V/H	S.G. Output dBm	Antenna Gain dBi	Cable Loss dB	EIRP dBm	Limit dBm
<b>BAND 4 BW: 5M QPSK RB: 1,0</b>	1712.5	19975	V	11.49	9.95	-4.46	16.97	30.00
			H	11.81	9.95	-4.46	17.30	30.00
	1732.5	20175	V	10.14	10.02	-4.50	15.66	30.00
			H	13.66	10.02	-4.50	<b>19.17</b>	30.00
	1752.5	20375	V	6.96	10.11	-4.54	12.52	30.00
			H	10.85	10.11	-4.54	16.42	30.00
<b>BAND 4 BW: 5M QPSK RB: 1,24</b>	1712.5	19975	V	10.64	9.95	-4.46	16.13	30.00
			H	11.71	9.95	-4.46	17.19	30.00
	1732.5	20175	V	9.80	10.04	-4.51	15.32	30.00
			H	12.87	10.04	-4.51	<b>18.40</b>	30.00
	1752.5	20375	V	4.30	10.12	-4.55	9.87	30.00
			H	9.00	10.12	-4.55	14.58	30.00
<b>BAND 4 BW: 5M 16QAM RB: 1,0</b>	1712.5	19975	V	11.26	9.95	-4.46	16.74	30.00
			H	11.67	9.94	-4.46	17.15	30.00
	1732.5	20175	V	10.28	10.02	-4.50	15.80	30.00
			H	13.66	10.02	-4.50	<b>19.18</b>	30.00
	1752.5	20375	V	6.65	10.11	-4.54	12.22	30.00
			H	10.62	10.11	-4.54	16.19	30.00
<b>BAND 4 BW: 5M 16QAM RB: 1,24</b>	1712.5	19975	V	10.50	9.95	-4.46	15.98	30.00
			H	11.63	9.95	-4.46	17.11	30.00
	1732.5	20175	V	9.76	10.04	-4.51	15.29	30.00
			H	12.82	10.04	-4.51	<b>18.34</b>	30.00
	1752.5	20375	V	4.30	10.12	-4.55	9.88	30.00
			H	8.87	10.12	-4.55	14.45	30.00

The RBW,VBW of SPA for frequency RBW= 8MHz , VBW= 8MHz

Unless otherwise stated the results shown in this test report refer only to the sample(s) tested and such sample(s) are retained for 90 days only.

除非另有說明，此報告結果僅對測試之樣品負責，同時此樣品僅保留90天。本報告未經本公司書面許可，不可部份複製。

This document is issued by the Company subject to its General Conditions of Service printed overleaf, available on request or accessible at [www.sgs.com/terms\\_and\\_conditions.htm](http://www.sgs.com/terms_and_conditions.htm) and, for electronic format documents, subject to Terms and Conditions for Electronic Documents at [www.sgs.com/terms\\_e-document.htm](http://www.sgs.com/terms_e-document.htm). Attention is drawn to the limitation of liability, indemnification and jurisdiction issues defined therein. Any holder of this document is advised that information contained hereon reflects the Company's findings at the time of its intervention only and within the limits of Client's instructions, if any. The Company's sole responsibility is to its Client and this document does not exonerate parties to a transaction from exercising all their rights and obligations under the transaction documents. This document cannot be reproduced except in full, without prior written approval of the Company. Any unauthorized alteration, forgery or falsification of the content or appearance of this document is unlawful and offenders may be prosecuted to the fullest extent of the law.

SGS Taiwan Ltd.

No.134,WuKungRoad,NewTaipeiIndustrialPark,WukuDistrict,NewTaipeiCity,Taiwan24803/新北市五股區新北產業園區五工路 134 號

台灣檢驗科技股份有限公司

t (886-2) 2299-3279

f (886-2) 2298-0488

www.tw.sgs.com

Member of SGS Group

EUT			Measurement					
Operation Band	Fundamental Frequency MHz	CH	Antenna Pol. V/H	S.G. Output dBm	Antenna Gain dBi	Cable Loss dB	EIRP dBm	Limit dBm
<b>BAND 4 BW: 10M QPSK RB: 1,0</b>	1715.0	20000	V	11.38	9.95	-4.46	16.86	30.00
			H	11.82	9.95	-4.46	17.31	30.00
	1732.5	20175	V	10.73	10.01	-4.50	16.24	30.00
			H	14.11	10.01	-4.50	<b>19.63</b>	30.00
	1750.0	20350	V	8.16	10.09	-4.54	13.72	30.00
			H	11.66	10.09	-4.54	17.21	30.00
<b>BAND 4 BW: 10M QPSK RB: 1,49</b>	1715.0	20000	V	9.84	9.96	-4.47	15.33	30.00
			H	12.09	9.96	-4.47	17.58	30.00
	1732.5	20175	V	9.20	10.04	-4.51	14.73	30.00
			H	12.07	10.04	-4.51	<b>17.60</b>	30.00
	1750.0	20350	V	4.34	10.12	-4.55	9.92	30.00
			H	8.93	10.12	-4.55	14.50	30.00
<b>BAND 4 BW: 10M 16QAM RB: 1,0</b>	1715.0	20000	V	11.26	9.95	-4.46	16.74	30.00
			H	11.79	9.95	-4.46	17.27	30.00
	1732.5	20175	V	10.00	10.02	-4.50	15.52	30.00
			H	13.49	10.02	-4.50	<b>19.01</b>	30.00
	1750.0	20350	V	8.38	10.09	-4.54	13.93	30.00
			H	11.52	10.09	-4.54	17.08	30.00
<b>BAND 4 BW: 10M 16QAM RB: 1,49</b>	1715.0	20000	V	9.74	9.96	-4.47	15.23	30.00
			H	12.05	9.96	-4.47	17.54	30.00
	1732.5	20175	V	9.28	10.04	-4.51	14.81	30.00
			H	12.35	10.04	-4.51	<b>17.88</b>	30.00
	1750.0	20350	V	4.35	10.12	-4.55	9.93	30.00
			H	9.00	10.12	-4.55	14.57	30.00

The RBW,VBW of SPA for frequency RBW= 8MHz , VBW= 8MHz

Unless otherwise stated the results shown in this test report refer only to the sample(s) tested and such sample(s) are retained for 90 days only.

除非另有說明，此報告結果僅對測試之樣品負責，同時此樣品僅保留90天。本報告未經本公司書面許可，不可部份複製。

This document is issued by the Company subject to its General Conditions of Service printed overleaf, available on request or accessible at [www.sgs.com/terms\\_and\\_conditions.htm](http://www.sgs.com/terms_and_conditions.htm) and, for electronic format documents, subject to Terms and Conditions for Electronic Documents at [www.sgs.com/terms\\_e-document.htm](http://www.sgs.com/terms_e-document.htm). Attention is drawn to the limitation of liability, indemnification and jurisdiction issues defined therein. Any holder of this document is advised that information contained hereon reflects the Company's findings at the time of its intervention only and within the limits of Client's instructions, if any. The Company's sole responsibility is to its Client and this document does not exonerate parties to a transaction from exercising all their rights and obligations under the transaction documents. This document cannot be reproduced except in full, without prior written approval of the Company. Any unauthorized alteration, forgery or falsification of the content or appearance of this document is unlawful and offenders may be prosecuted to the fullest extent of the law.

SGS Taiwan Ltd.

No.134,WuKungRoad,NewTaipeiIndustrialPark,WukuDistrict,NewTaipeiCity,Taiwan24803/新北市五股區新北產業園區五工路 134 號

台灣檢驗科技股份有限公司

t (886-2) 2299-3279

f (886-2) 2298-0488

www.tw.sgs.com

Member of SGS Group

EUT			Measurement					
Operation Band	Fundamental Frequency MHz	CH	Antenna Pol. V/H	S.G. Output dBm	Antenna Gain dBi	Cable Loss dB	EIRP dBm	Limit dBm
<b>BAND 4 BW: 15M QPSK RB: 1,0</b>	1717.5	20025	V	11.48	9.94	-4.46	16.96	30.00
			H	11.74	9.94	-4.46	17.22	30.00
	1732.5	20175	V	10.33	10.01	-4.50	15.84	30.00
			H	13.83	10.01	-4.50	<b>19.34</b>	30.00
	1747.5	20325	V	7.39	10.08	-4.53	12.94	30.00
			H	11.09	10.08	-4.53	16.64	30.00
<b>BAND 4 BW: 15M QPSK RB: 1,74</b>	1717.5	20025	V	10.02	9.98	-4.48	15.52	30.00
			H	13.14	9.98	-4.48	<b>18.63</b>	30.00
	1732.5	20175	V	8.32	10.05	-4.52	13.85	30.00
			H	11.25	10.05	-4.52	16.79	30.00
	1747.5	20325	V	4.31	10.12	-4.55	9.89	30.00
			H	8.94	10.12	-4.55	14.51	30.00
<b>BAND 4 BW: 15M 16QAM RB: 1,0</b>	1717.5	20025	V	11.03	9.94	-4.46	16.51	30.00
			H	11.71	9.95	-4.46	17.20	30.00
	1732.5	20175	V	10.22	10.01	-4.50	15.73	30.00
			H	14.11	10.01	-4.50	<b>19.62</b>	30.00
	1747.5	20325	V	7.44	10.08	-4.53	12.99	30.00
			H	11.02	10.08	-4.53	16.57	30.00
<b>BAND 4 BW: 15M 16QAM RB: 1,74</b>	1717.5	20025	V	9.94	9.98	-4.48	15.44	30.00
			H	12.94	9.98	-4.48	<b>18.44</b>	30.00
	1732.5	20175	V	8.28	10.05	-4.52	13.82	30.00
			H	11.46	10.05	-4.52	16.99	30.00
	1747.5	20325	V	4.22	10.12	-4.55	9.79	30.00
			H	8.89	10.12	-4.55	14.47	30.00

The RBW,VBW of SPA for frequency RBW= 8MHz , VBW= 8MHz

Unless otherwise stated the results shown in this test report refer only to the sample(s) tested and such sample(s) are retained for 90 days only.

除非另有說明，此報告結果僅對測試之樣品負責，同時此樣品僅保留90天。本報告未經本公司書面許可，不可部份複製。

This document is issued by the Company subject to its General Conditions of Service printed overleaf, available on request or accessible at [www.sgs.com/terms\\_and\\_conditions.htm](http://www.sgs.com/terms_and_conditions.htm) and, for electronic format documents, subject to Terms and Conditions for Electronic Documents at [www.sgs.com/terms\\_e-document.htm](http://www.sgs.com/terms_e-document.htm). Attention is drawn to the limitation of liability, indemnification and jurisdiction issues defined therein. Any holder of this document is advised that information contained hereon reflects the Company's findings at the time of its intervention only and within the limits of Client's instructions, if any. The Company's sole responsibility is to its Client and this document does not exonerate parties to a transaction from exercising all their rights and obligations under the transaction documents. This document cannot be reproduced except in full, without prior written approval of the Company. Any unauthorized alteration, forgery or falsification of the content or appearance of this document is unlawful and offenders may be prosecuted to the fullest extent of the law.

SGS Taiwan Ltd.

No.134,WuKungRoad,NewTaipeiIndustrialPark,WukuDistrict,NewTaipeiCity,Taiwan24803/新北市五股區新北產業園區五工路 134 號

台灣檢驗科技股份有限公司

t (886-2) 2299-3279

f (886-2) 2298-0488

www.tw.sgs.com

Member of SGS Group

EUT			Measurement					
Operation Band	Fundamental Frequency MHz	CH	Antenna Pol. V/H	S.G. Output dBm	Antenna Gain dBi	Cable Loss dB	EIRP dBm	Limit dBm
<b>BAND 4 BW: 20M QPSK RB: 1,0</b>	1720.0	20050	V	11.34	9.95	-4.46	16.83	30.00
			H	11.66	9.95	-4.46	17.14	30.00
	1732.5	20175	V	10.37	10.00	-4.49	15.88	30.00
			H	14.09	10.00	-4.49	<b>19.60</b>	30.00
	1745.0	20300	V	7.63	10.07	-4.52	13.17	30.00
			H	10.73	10.07	-4.52	16.27	30.00
<b>BAND 4 BW: 20M QPSK RB: 1,99</b>	1720.0	20050	V	10.52	9.99	-4.49	16.02	30.00
			H	13.98	9.99	-4.49	<b>19.49</b>	30.00
	1732.5	20175	V	8.00	10.06	-4.52	13.54	30.00
			H	10.92	10.06	-4.52	16.45	30.00
	1745.0	20300	V	4.48	10.12	-4.55	10.05	30.00
			H	9.05	10.12	-4.55	14.62	30.00
<b>BAND 4 BW: 20M 16QAM RB: 1,0</b>	1720.0	20050	V	11.12	9.95	-4.46	16.61	30.00
			H	12.13	9.94	-4.46	17.61	30.00
	1732.5	20175	V	9.76	10.00	-4.49	15.27	30.00
			H	14.04	10.00	-4.49	<b>19.55</b>	30.00
	1745.0	20300	V	7.61	10.07	-4.52	13.16	30.00
			H	10.67	10.07	-4.52	16.21	30.00
<b>BAND 4 BW: 20M 16QAM RB: 1,99</b>	1720.0	20050	V	10.29	9.99	-4.49	15.80	30.00
			H	13.81	9.99	-4.49	<b>19.32</b>	30.00
	1732.5	20175	V	7.82	10.06	-4.52	13.36	30.00
			H	11.13	10.06	-4.52	16.66	30.00
	1745.0	20300	V	4.39	10.12	-4.55	9.96	30.00
			H	8.95	10.12	-4.55	14.52	30.00

The RBW,VBW of SPA for frequency RBW= 8MHz , VBW= 8MHz

Unless otherwise stated the results shown in this test report refer only to the sample(s) tested and such sample(s) are retained for 90 days only.

除非另有說明，此報告結果僅對測試之樣品負責，同時此樣品僅保留90天。本報告未經本公司書面許可，不可部份複製。

This document is issued by the Company subject to its General Conditions of Service printed overleaf, available on request or accessible at [www.sgs.com/terms\\_and\\_conditions.htm](http://www.sgs.com/terms_and_conditions.htm) and, for electronic format documents, subject to Terms and Conditions for Electronic Documents at [www.sgs.com/terms\\_e-document.htm](http://www.sgs.com/terms_e-document.htm). Attention is drawn to the limitation of liability, indemnification and jurisdiction issues defined therein. Any holder of this document is advised that information contained hereon reflects the Company's findings at the time of its intervention only and within the limits of Client's instructions, if any. The Company's sole responsibility is to its Client and this document does not exonerate parties to a transaction from exercising all their rights and obligations under the transaction documents. This document cannot be reproduced except in full, without prior written approval of the Company. Any unauthorized alteration, forgery or falsification of the content or appearance of this document is unlawful and offenders may be prosecuted to the fullest extent of the law.

SGS Taiwan Ltd.

No.134,WuKungRoad,NewTaipeiIndustrialPark,WukuDistrict,NewTaipeiCity,Taiwan24803/新北市五股區新北產業園區五工路 134 號

台灣檢驗科技股份有限公司

t (886-2) 2299-3279

f (886-2) 2298-0488

www.tw.sgs.com

Member of SGS Group

EUT			Measurement					
Operation Band	Fundamental Frequency MHz	CH	Antenna Pol. V/H	S.G. Output dBm	Antenna Gain dBi	Cable Loss dB	EIRP dBm	Limit dBm
<b>BAND 7 BW: 5M QPSK RB: 1,0</b>	2502.5	20775	V	7.79	10.90	-5.26	13.44	33.01
			H	15.58	10.90	-5.25	<b>21.22</b>	33.01
	2535.0	21100	V	9.72	10.94	-5.30	15.36	33.01
			H	15.34	10.94	-5.30	20.98	33.01
	2567.5	21425	V	5.73	10.98	-5.34	11.37	33.01
			H	13.83	10.98	-5.34	19.47	33.01
<b>BAND 7 BW: 5M QPSK RB: 1,24</b>	2502.5	20775	V	8.67	10.90	-5.26	14.31	33.01
			H	16.47	10.90	-5.26	<b>22.11</b>	33.01
	2535.0	21100	V	9.64	10.95	-5.31	15.28	33.01
			H	15.67	10.95	-5.31	21.31	33.01
	2567.5	21425	V	4.98	10.99	-5.34	10.63	33.01
			H	13.08	10.99	-5.34	18.73	33.01
<b>BAND 7 BW: 5M 16QAM RB: 1,0</b>	2502.5	20775	V	7.62	10.90	-5.25	13.26	33.01
			H	15.42	10.90	-5.25	<b>21.07</b>	33.01
	2535.0	21100	V	9.80	10.94	-5.30	15.44	33.01
			H	15.26	10.94	-5.30	20.90	33.01
	2567.5	21425	V	5.94	10.98	-5.34	11.58	33.01
			H	14.01	10.98	-5.34	19.66	33.01
<b>BAND 7 BW: 5M 16QAM RB: 1,24</b>	2502.5	20775	V	8.60	10.90	-5.26	14.25	33.01
			H	16.33	10.90	-5.26	<b>21.98</b>	33.01
	2535.0	21100	V	9.55	10.95	-5.31	15.19	33.01
			H	15.49	10.95	-5.31	21.13	33.01
	2567.5	21425	V	5.15	10.99	-5.34	10.80	33.01
			H	13.28	10.99	-5.34	18.93	33.01

The RBW,VBW of SPA for frequency RBW= 8MHz , VBW= 8MHz

Unless otherwise stated the results shown in this test report refer only to the sample(s) tested and such sample(s) are retained for 90 days only.

除非另有說明，此報告結果僅對測試之樣品負責，同時此樣品僅保留90天。本報告未經本公司書面許可，不可部份複製。

This document is issued by the Company subject to its General Conditions of Service printed overleaf, available on request or accessible at [www.sgs.com/terms\\_and\\_conditions.htm](http://www.sgs.com/terms_and_conditions.htm) and, for electronic format documents, subject to Terms and Conditions for Electronic Documents at [www.sgs.com/terms\\_e-document.htm](http://www.sgs.com/terms_e-document.htm). Attention is drawn to the limitation of liability, indemnification and jurisdiction issues defined therein. Any holder of this document is advised that information contained hereon reflects the Company's findings at the time of its intervention only and within the limits of Client's instructions, if any. The Company's sole responsibility is to its Client and this document does not exonerate parties to a transaction from exercising all their rights and obligations under the transaction documents. This document cannot be reproduced except in full, without prior written approval of the Company. Any unauthorized alteration, forgery or falsification of the content or appearance of this document is unlawful and offenders may be prosecuted to the fullest extent of the law.

SGS Taiwan Ltd.

No.134,WuKungRoad,NewTaipeiIndustrialPark,WukuDistrict,NewTaipeiCity,Taiwan24803/新北市五股區新北產業園區五工路 134 號

台灣檢驗科技股份有限公司

t (886-2) 2299-3279

f (886-2) 2298-0488

www.tw.sgs.com

Member of SGS Group

EUT			Measurement					
Operation Band	Fundamental Frequency	CH	Antenna Pol.	S.G. Output	Antenna Gain	Cable Loss	EIRP	Limit
	MHz		V/H	dBm	dBi	dB	dBm	dBm
<b>BAND 7</b>	2505.0	20800	V	7.54	10.90	-5.26	13.19	33.01
			H	15.46	10.90	-5.26	21.11	33.01
<b>BW: 10M</b>	2535.0	21100	V	9.45	10.94	-5.29	15.10	33.01
			H	15.26	10.94	-5.29	20.91	33.01
<b>QPSK</b>	2565.0	21400	V	7.25	10.98	-5.34	12.89	33.01
			H	15.50	10.98	-5.34	<b>21.13</b>	33.01
<b>RB: 1,0</b>	2505.0	20800	V	8.30	10.91	-5.26	13.95	33.01
			H	16.87	10.91	-5.26	<b>22.52</b>	33.01
<b>BAND 7</b>	2535.0	21100	V	9.43	10.95	-5.31	15.07	33.01
			H	15.86	10.95	-5.31	21.50	33.01
<b>BW: 10M</b>	2565.0	21400	V	4.81	10.99	-5.34	10.46	33.01
			H	13.05	10.99	-5.34	18.70	33.01
<b>QPSK</b>	2505.0	20800	V	7.49	10.90	-5.26	13.14	33.01
			H	15.44	10.90	-5.26	21.09	33.01
<b>RB: 1,0</b>	2535.0	21100	V	9.26	10.94	-5.29	14.91	33.01
			H	15.31	10.94	-5.29	20.96	33.01
<b>BAND 7</b>	2565.0	21400	V	7.40	10.98	-5.34	13.04	33.01
			H	15.70	10.98	-5.34	<b>21.34</b>	33.01
<b>BW: 10M</b>	2505.0	20800	V	8.36	10.91	-5.26	14.01	33.01
			H	16.79	10.91	-5.26	<b>22.44</b>	33.01
<b>16QAM</b>	2535.0	21100	V	9.10	10.95	-5.31	14.74	33.01
			H	15.58	10.95	-5.31	21.22	33.01
<b>RB: 1,49</b>	2565.0	21400	V	5.01	10.99	-5.34	10.66	33.01
			H	13.23	10.99	-5.34	18.88	33.01
The RBW,VBW of SPA for frequency RBW= 8MHz , VBW= 8MHz								

Unless otherwise stated the results shown in this test report refer only to the sample(s) tested and such sample(s) are retained for 90 days only.

除非另有說明，此報告結果僅對測試之樣品負責，同時此樣品僅保留90天。本報告未經本公司書面許可，不可部份複製。

This document is issued by the Company subject to its General Conditions of Service printed overleaf, available on request or accessible at [www.sgs.com/terms\\_and\\_conditions.htm](http://www.sgs.com/terms_and_conditions.htm) and, for electronic format documents, subject to Terms and Conditions for Electronic Documents at [www.sgs.com/terms\\_e-document.htm](http://www.sgs.com/terms_e-document.htm). Attention is drawn to the limitation of liability, indemnification and jurisdiction issues defined therein. Any holder of this document is advised that information contained hereon reflects the Company's findings at the time of its intervention only and within the limits of Client's instructions, if any. The Company's sole responsibility is to its Client and this document does not exonerate parties to a transaction from exercising all their rights and obligations under the transaction documents. This document cannot be reproduced except in full, without prior written approval of the Company. Any unauthorized alteration, forgery or falsification of the content or appearance of this document is unlawful and offenders may be prosecuted to the fullest extent of the law.

SGS Taiwan Ltd.

No.134,WuKungRoad,NewTaipeiIndustrialPark,WukuDistrict,NewTaipeiCity,Taiwan24803/新北市五股區新北產業園區五工路 134 號

台灣檢驗科技股份有限公司

t (886-2) 2299-3279

f (886-2) 2298-0488

www.tw.sgs.com

Member of SGS Group



EUT			Measurement					
Operation Band	Fundamental Frequency MHz	CH	Antenna Pol. V/H	S.G. Output dBm	Antenna Gain dBi	Cable Loss dB	EIRP dBm	Limit dBm
<b>BAND 7 BW: 15M QPSK RB: 1,0</b>	2507.5	20825	V	7.57	10.90	-5.26	13.22	33.01
			H	15.42	10.90	-5.25	21.07	33.01
	2535.0	21100	V	9.17	10.93	-5.29	14.81	33.01
			H	15.43	10.94	-5.29	21.08	33.01
	2562.5	21375	V	8.78	10.97	-5.34	14.41	33.01
			H	16.55	10.97	-5.34	<b>22.18</b>	33.01
<b>BAND 7 BW: 15M QPSK RB: 1,74</b>	2507.5	20825	V	8.11	10.92	-5.27	13.76	33.01
			H	16.71	10.92	-5.27	<b>22.36</b>	33.01
	2535.0	21100	V	9.33	10.95	-5.32	14.97	33.01
			H	16.15	10.95	-5.32	21.79	33.01
	2562.5	21375	V	4.82	10.99	-5.34	10.46	33.01
			H	12.99	10.99	-5.34	18.64	33.01
<b>BAND 7 BW: 15M 16QAM RB: 1,0</b>	2507.5	20825	V	7.50	10.90	-5.25	13.15	33.01
			H	15.53	10.90	-5.25	21.17	33.01
	2535.0	21100	V	9.08	10.93	-5.29	14.73	33.01
			H	15.31	10.93	-5.29	20.96	33.01
	2562.5	21375	V	9.04	10.97	-5.34	14.67	33.01
			H	16.41	10.97	-5.34	<b>22.04</b>	33.01
<b>BAND 7 BW: 15M 16QAM RB: 1,74</b>	2507.5	20825	V	7.91	10.92	-5.27	13.56	33.01
			H	17.15	10.92	-5.27	<b>22.80</b>	33.01
	2535.0	21100	V	9.09	10.95	-5.32	14.73	33.01
			H	16.12	10.95	-5.32	21.76	33.01
	2562.5	21375	V	4.95	10.99	-5.34	10.60	33.01
			H	13.20	10.99	-5.34	18.85	33.01

The RBW,VBW of SPA for frequency RBW= 8MHz , VBW= 8MHz

Unless otherwise stated the results shown in this test report refer only to the sample(s) tested and such sample(s) are retained for 90 days only.

除非另有說明，此報告結果僅對測試之樣品負責，同時此樣品僅保留90天。本報告未經本公司書面許可，不可部份複製。

This document is issued by the Company subject to its General Conditions of Service printed overleaf, available on request or accessible at [www.sgs.com/terms\\_and\\_conditions.htm](http://www.sgs.com/terms_and_conditions.htm) and, for electronic format documents, subject to Terms and Conditions for Electronic Documents at [www.sgs.com/terms\\_e-document.htm](http://www.sgs.com/terms_e-document.htm). Attention is drawn to the limitation of liability, indemnification and jurisdiction issues defined therein. Any holder of this document is advised that information contained hereon reflects the Company's findings at the time of its intervention only and within the limits of Client's instructions, if any. The Company's sole responsibility is to its Client and this document does not exonerate parties to a transaction from exercising all their rights and obligations under the transaction documents. This document cannot be reproduced except in full, without prior written approval of the Company. Any unauthorized alteration, forgery or falsification of the content or appearance of this document is unlawful and offenders may be prosecuted to the fullest extent of the law.

SGS Taiwan Ltd.

No.134,WuKungRoad,NewTaipeiIndustrialPark,WukuDistrict,NewTaipeiCity,Taiwan24803/新北市五股區新北產業園區五工路 134 號

台灣檢驗科技股份有限公司

t (886-2) 2299-3279

f (886-2) 2298-0488

www.tw.sgs.com

Member of SGS Group

EUT			Measurement					
Operation Band	Fundamental Frequency MHz	CH	Antenna Pol. V/H	S.G. Output dBm	Antenna Gain dBi	Cable Loss dB	EIRP dBm	Limit dBm
<b>BAND 7 BW: 20M QPSK RB: 1,0</b>	2510.0	20850	V	7.56	10.90	-5.25	13.21	33.01
			H	15.40	10.90	-5.26	21.05	33.01
	2535.0	21100	V	8.84	10.93	-5.29	14.49	33.01
			H	15.43	10.93	-5.29	21.08	33.01
	2560.0	21350	V	9.41	10.96	-5.33	15.04	33.01
			H	16.97	10.96	-5.33	<b>22.60</b>	33.01
<b>BAND 7 BW: 20M QPSK RB: 1,99</b>	2510.0	20850	V	8.02	10.92	-5.27	13.67	33.01
			H	16.05	10.92	-5.27	21.70	33.01
	2535.0	21100	V	9.48	10.95	-5.32	15.11	33.01
			H	16.40	10.95	-5.32	<b>22.03</b>	33.01
	2560.0	21350	V	4.65	10.99	-5.34	10.30	33.01
			H	12.98	10.99	-5.34	18.63	33.01
<b>BAND 7 BW: 20M 16QAM RB: 1,0</b>	2510.0	20850	V	7.37	10.90	-5.26	13.01	33.01
			H	15.66	10.90	-5.25	21.31	33.01
	2535.0	21100	V	8.73	10.93	-5.29	14.38	33.01
			H	15.37	10.93	-5.29	21.02	33.01
	2560.0	21350	V	8.88	10.96	-5.33	14.51	33.01
			H	16.48	10.96	-5.33	<b>22.11</b>	33.01
<b>BAND 7 BW: 20M 16QAM RB: 1,99</b>	2510.0	20850	V	7.91	10.92	-5.27	13.56	33.01
			H	15.95	10.92	-5.27	21.60	33.01
	2535.0	21100	V	9.15	10.96	-5.32	14.79	33.01
			H	16.24	10.96	-5.32	<b>21.88</b>	33.01
	2560.0	21350	V	4.88	10.99	-5.34	10.53	33.01
			H	13.19	10.99	-5.34	18.84	33.01

The RBW,VBW of SPA for frequency RBW= 8MHz , VBW= 8MHz

Unless otherwise stated the results shown in this test report refer only to the sample(s) tested and such sample(s) are retained for 90 days only.

除非另有說明，此報告結果僅對測試之樣品負責，同時此樣品僅保留90天。本報告未經本公司書面許可，不可部份複製。

This document is issued by the Company subject to its General Conditions of Service printed overleaf, available on request or accessible at [www.sgs.com/terms\\_and\\_conditions.htm](http://www.sgs.com/terms_and_conditions.htm) and, for electronic format documents, subject to Terms and Conditions for Electronic Documents at [www.sgs.com/terms\\_e-document.htm](http://www.sgs.com/terms_e-document.htm). Attention is drawn to the limitation of liability, indemnification and jurisdiction issues defined therein. Any holder of this document is advised that information contained hereon reflects the Company's findings at the time of its intervention only and within the limits of Client's instructions, if any. The Company's sole responsibility is to its Client and this document does not exonerate parties to a transaction from exercising all their rights and obligations under the transaction documents. This document cannot be reproduced except in full, without prior written approval of the Company. Any unauthorized alteration, forgery or falsification of the content or appearance of this document is unlawful and offenders may be prosecuted to the fullest extent of the law.

SGS Taiwan Ltd.

No.134,WuKungRoad,NewTaipeiIndustrialPark,WukuDistrict,NewTaipeiCity,Taiwan24803/新北市五股區新北產業園區五工路 134 號

台灣檢驗科技股份有限公司

t (886-2) 2299-3279

f (886-2) 2298-0488

www.tw.sgs.com

Member of SGS Group

EUT			Measurement					
Operation Band	Fundamental Frequency MHz	CH	Antenna Pol. V/H	S.G. Output dBm	Antenna Gain dBi	Cable Loss dB	EIRP dBm	Limit dBm
<b>BAND 12 BW: 1.4M QPSK RB: 1,0</b>	699.7	23017	V	8.60	3.08	-2.96	8.72	34.77
			H	14.51	3.08	-2.96	<b>14.63</b>	34.77
	707.5	23095	V	6.38	3.09	-3.04	6.44	34.77
			H	13.35	3.09	-3.04	13.41	34.77
	715.3	23173	V	5.10	3.11	-3.06	5.15	34.77
			H	13.62	3.11	-3.06	13.67	34.77
<b>BAND 12 BW: 1.4M QPSK RB: 1,5</b>	699.7	23017	V	8.90	3.08	-2.96	9.02	34.77
			H	14.85	3.08	-2.96	<b>14.97</b>	34.77
	707.5	23095	V	6.59	3.09	-3.04	6.64	34.77
			H	13.68	3.09	-3.04	13.74	34.77
	715.3	23173	V	4.96	3.11	-3.06	5.01	34.77
			H	13.69	3.11	-3.06	13.74	34.77
<b>BAND 12 BW: 1.4M 16QAM RB: 1,0</b>	699.7	23017	V	8.10	3.08	-2.96	8.22	34.77
			H	14.13	3.08	-2.96	<b>14.25</b>	34.77
	707.5	23095	V	6.10	3.09	-3.04	6.16	34.77
			H	13.15	3.09	-3.04	13.21	34.77
	715.3	23173	V	5.14	3.11	-3.06	5.18	34.77
			H	13.68	3.11	-3.06	13.73	34.77
<b>BAND 12 BW: 1.4M 16QAM RB: 1,5</b>	699.7	23017	V	8.29	3.08	-2.96	8.41	34.77
			H	14.64	3.08	-2.96	<b>14.77</b>	34.77
	707.5	23095	V	6.32	3.10	-3.04	6.38	34.77
			H	13.26	3.09	-3.04	13.32	34.77
	715.3	23173	V	4.62	3.11	-3.06	4.67	34.77
			H	13.54	3.11	-3.06	13.59	34.77

The RBW,VBW of SPA for frequency RBW= 8MHz , VBW= 8MHz

Unless otherwise stated the results shown in this test report refer only to the sample(s) tested and such sample(s) are retained for 90 days only.

除非另有說明，此報告結果僅對測試之樣品負責，同時此樣品僅保留90天。本報告未經本公司書面許可，不可部份複製。

This document is issued by the Company subject to its General Conditions of Service printed overleaf, available on request or accessible at [www.sgs.com/terms\\_and\\_conditions.htm](http://www.sgs.com/terms_and_conditions.htm) and, for electronic format documents, subject to Terms and Conditions for Electronic Documents at [www.sgs.com/terms\\_e-document.htm](http://www.sgs.com/terms_e-document.htm). Attention is drawn to the limitation of liability, indemnification and jurisdiction issues defined therein. Any holder of this document is advised that information contained hereon reflects the Company's findings at the time of its intervention only and within the limits of Client's instructions, if any. The Company's sole responsibility is to its Client and this document does not exonerate parties to a transaction from exercising all their rights and obligations under the transaction documents. This document cannot be reproduced except in full, without prior written approval of the Company. Any unauthorized alteration, forgery or falsification of the content or appearance of this document is unlawful and offenders may be prosecuted to the fullest extent of the law.

SGS Taiwan Ltd.

No.134,WuKungRoad,NewTaipeiIndustrialPark,WukuDistrict,NewTaipeiCity,Taiwan24803/新北市五股區新北產業園區五工路 134 號

台灣檢驗科技股份有限公司

t (886-2) 2299-3279

f (886-2) 2298-0488

www.tw.sgs.com

Member of SGS Group

EUT			Measurement					
Operation Band	Fundamental Frequency MHz	CH	Antenna Pol. V/H	S.G. Output dBm	Antenna Gain dBi	Cable Loss dB	EIRP dBm	Limit dBm
<b>BAND 12 BW: 3M QPSK RB: 1,0</b>	700.5	23025	V	8.71	3.08	-2.96	8.84	34.77
			H	14.81	3.08	-2.96	<b>14.93</b>	34.77
	707.5	23095	V	6.08	3.09	-3.03	6.14	34.77
			H	13.22	3.09	-3.03	13.27	34.77
	714.5	23165	V	6.10	3.11	-3.06	6.15	34.77
			H	14.32	3.11	-3.06	14.36	34.77
<b>BAND 12 BW: 3M QPSK RB: 1,14</b>	700.5	23025	V	8.55	3.08	-2.98	8.65	34.77
			H	15.01	3.08	-2.98	<b>15.12</b>	34.77
	707.5	23095	V	6.63	3.10	-3.04	6.69	34.77
			H	14.04	3.10	-3.04	14.09	34.77
	714.5	23165	V	4.92	3.11	-3.06	4.96	34.77
			H	13.68	3.11	-3.06	13.73	34.77
<b>BAND 12 BW: 3M 16QAM RB: 1,0</b>	700.5	23025	V	8.25	3.08	-2.98	8.35	34.77
			H	14.36	3.08	-2.99	14.46	34.77
	707.5	23095	V	5.88	3.09	-3.03	5.93	34.77
			H	12.92	3.09	-3.03	12.97	34.77
	714.5	23165	V	5.78	3.11	-3.06	5.83	34.77
			H	14.47	3.11	-3.06	<b>14.52</b>	34.77
<b>BAND 12 BW: 3M 16QAM RB: 1,14</b>	700.5	23025	V	8.27	3.08	-2.98	8.37	34.77
			H	14.64	3.08	-2.97	<b>14.75</b>	34.77
	707.5	23095	V	6.40	3.10	-3.04	6.45	34.77
			H	13.71	3.10	-3.04	13.76	34.77
	714.5	23165	V	4.67	3.11	-3.06	4.72	34.77
			H	13.59	3.11	-3.06	13.64	34.77

The RBW,VBW of SPA for frequency RBW= 8MHz , VBW= 8MHz

Unless otherwise stated the results shown in this test report refer only to the sample(s) tested and such sample(s) are retained for 90 days only.

除非另有說明，此報告結果僅對測試之樣品負責，同時此樣品僅保留90天。本報告未經本公司書面許可，不可部份複製。

This document is issued by the Company subject to its General Conditions of Service printed overleaf, available on request or accessible at [www.sgs.com/terms\\_and\\_conditions.htm](http://www.sgs.com/terms_and_conditions.htm) and, for electronic format documents, subject to Terms and Conditions for Electronic Documents at [www.sgs.com/terms\\_e-document.htm](http://www.sgs.com/terms_e-document.htm). Attention is drawn to the limitation of liability, indemnification and jurisdiction issues defined therein. Any holder of this document is advised that information contained hereon reflects the Company's findings at the time of its intervention only and within the limits of Client's instructions, if any. The Company's sole responsibility is to its Client and this document does not exonerate parties to a transaction from exercising all their rights and obligations under the transaction documents. This document cannot be reproduced except in full, without prior written approval of the Company. Any unauthorized alteration, forgery or falsification of the content or appearance of this document is unlawful and offenders may be prosecuted to the fullest extent of the law.

SGS Taiwan Ltd.

No.134,WuKungRoad,NewTaipeiIndustrialPark,WukuDistrict,NewTaipeiCity,Taiwan24803/新北市五股區新北產業園區五工路 134 號

台灣檢驗科技股份有限公司

t (886-2) 2299-3279

f (886-2) 2298-0488

www.tw.sgs.com

Member of SGS Group

EUT			Measurement					
Operation Band	Fundamental Frequency MHz	CH	Antenna Pol. V/H	S.G. Output dBm	Antenna Gain dBi	Cable Loss dB	EIRP dBm	Limit dBm
<b>BAND 12 BW: 5M QPSK RB: 1,0</b>	701.5	23035	V	8.58	3.08	-2.96	8.71	34.77
			H	14.53	3.08	-2.96	14.65	34.77
	707.5	23095	V	6.08	3.09	-3.03	6.13	34.77
			H	13.08	3.09	-3.03	13.14	34.77
	713.5	23155	V	6.82	3.10	-3.05	6.88	34.77
			H	14.64	3.10	-3.05	<b>14.70</b>	34.77
<b>BAND 12 BW: 5M QPSK RB: 1,24</b>	701.5	23035	V	7.02	3.09	-3.01	7.10	34.77
			H	13.64	3.09	-3.01	13.72	34.77
	707.5	23095	V	6.82	3.10	-3.04	6.88	34.77
			H	14.56	3.10	-3.05	<b>14.62</b>	34.77
	713.5	23155	V	4.81	3.11	-3.06	4.85	34.77
			H	13.77	3.11	-3.06	13.81	34.77
<b>BAND 12 BW: 5M 16QAM RB: 1,0</b>	701.5	23035	V	8.44	3.08	-2.96	8.56	34.77
			H	14.23	3.08	-2.97	14.35	34.77
	707.5	23095	V	6.13	3.09	-3.03	6.18	34.77
			H	12.99	3.09	-3.03	13.05	34.77
	713.5	23155	V	6.62	3.10	-3.05	6.67	34.77
			H	14.51	3.10	-3.05	<b>14.56</b>	34.77
<b>BAND 12 BW: 5M 16QAM RB: 1,24</b>	701.5	23035	V	6.91	3.09	-3.01	6.99	34.77
			H	13.54	3.09	-3.01	13.61	34.77
	707.5	23095	V	6.31	3.10	-3.04	6.36	34.77
			H	13.98	3.10	-3.05	<b>14.03</b>	34.77
	713.5	23155	V	4.76	3.11	-3.06	4.81	34.77
			H	13.59	3.11	-3.06	13.64	34.77

The RBW,VBW of SPA for frequency RBW= 8MHz , VBW= 8MHz

Unless otherwise stated the results shown in this test report refer only to the sample(s) tested and such sample(s) are retained for 90 days only.

除非另有說明，此報告結果僅對測試之樣品負責，同時此樣品僅保留90天。本報告未經本公司書面許可，不可部份複製。

This document is issued by the Company subject to its General Conditions of Service printed overleaf, available on request or accessible at [www.sgs.com/terms\\_and\\_conditions.htm](http://www.sgs.com/terms_and_conditions.htm) and, for electronic format documents, subject to Terms and Conditions for Electronic Documents at [www.sgs.com/terms\\_e-document.htm](http://www.sgs.com/terms_e-document.htm). Attention is drawn to the limitation of liability, indemnification and jurisdiction issues defined therein. Any holder of this document is advised that information contained hereon reflects the Company's findings at the time of its intervention only and within the limits of Client's instructions, if any. The Company's sole responsibility is to its Client and this document does not exonerate parties to a transaction from exercising all their rights and obligations under the transaction documents. This document cannot be reproduced except in full, without prior written approval of the Company. Any unauthorized alteration, forgery or falsification of the content or appearance of this document is unlawful and offenders may be prosecuted to the fullest extent of the law.

SGS Taiwan Ltd.

No.134,WuKungRoad,NewTaipeiIndustrialPark,WukuDistrict,NewTaipeiCity,Taiwan24803/新北市五股區新北產業園區五工路 134 號

台灣檢驗科技股份有限公司

t (886-2) 2299-3279

f (886-2) 2298-0488

www.tw.sgs.com

Member of SGS Group

EUT			Measurement					
Operation Band	Fundamental Frequency MHz	CH	Antenna Pol. V/H	S.G. Output dBm	Antenna Gain dBi	Cable Loss dB	EIRP dBm	Limit dBm
<b>BAND 12 BW: 10M QPSK RB: 1,0</b>	704.0	23060	V	8.54	3.08	-2.96	8.66	34.77
			H	14.76	3.08	-2.96	<b>14.88</b>	34.77
	707.5	23095	V	7.38	3.08	-3.00	7.47	34.77
			H	13.97	3.08	-3.00	14.05	34.77
	711.0	23130	V	6.23	3.09	-3.04	6.28	34.77
			H	13.30	3.09	-3.04	13.35	34.77
<b>BAND 12 BW: 10M QPSK RB: 1,49</b>	704.0	23060	V	6.58	3.10	-3.04	6.63	34.77
			H	13.94	3.10	-3.04	14.00	34.77
	707.5	23095	V	6.59	3.10	-3.05	6.64	34.77
			H	14.71	3.10	-3.05	<b>14.76</b>	34.77
	711.0	23130	V	4.88	3.11	-3.06	4.93	34.77
			H	13.63	3.11	-3.06	13.68	34.77
<b>BAND 12 BW: 10M 16QAM RB: 1,0</b>	704.0	23060	V	8.49	3.08	-2.96	8.61	34.77
			H	14.58	3.08	-2.96	<b>14.70</b>	34.77
	707.5	23095	V	7.06	3.08	-3.00	7.15	34.77
			H	13.80	3.08	-3.00	13.89	34.77
	711.0	23130	V	6.10	3.09	-3.04	6.15	34.77
			H	12.97	3.09	-3.04	13.03	34.77
<b>BAND 12 BW: 10M 16QAM RB: 1,49</b>	704.0	23060	V	6.45	3.10	-3.04	6.50	34.77
			H	13.86	3.10	-3.04	13.91	34.77
	707.5	23095	V	6.23	3.10	-3.05	6.28	34.77
			H	14.32	3.10	-3.05	<b>14.37</b>	34.77
	711.0	23130	V	4.68	3.11	-3.06	4.72	34.77
			H	13.59	3.11	-3.06	13.64	34.77

The RBW,VBW of SPA for frequency RBW= 8MHz , VBW= 8MHz

Unless otherwise stated the results shown in this test report refer only to the sample(s) tested and such sample(s) are retained for 90 days only.

除非另有說明，此報告結果僅對測試之樣品負責，同時此樣品僅保留90天。本報告未經本公司書面許可，不可部份複製。

This document is issued by the Company subject to its General Conditions of Service printed overleaf, available on request or accessible at [www.sgs.com/terms\\_and\\_conditions.htm](http://www.sgs.com/terms_and_conditions.htm) and, for electronic format documents, subject to Terms and Conditions for Electronic Documents at [www.sgs.com/terms\\_e-document.htm](http://www.sgs.com/terms_e-document.htm). Attention is drawn to the limitation of liability, indemnification and jurisdiction issues defined therein. Any holder of this document is advised that information contained hereon reflects the Company's findings at the time of its intervention only and within the limits of Client's instructions, if any. The Company's sole responsibility is to its Client and this document does not exonerate parties to a transaction from exercising all their rights and obligations under the transaction documents. This document cannot be reproduced except in full, without prior written approval of the Company. Any unauthorized alteration, forgery or falsification of the content or appearance of this document is unlawful and offenders may be prosecuted to the fullest extent of the law.

SGS Taiwan Ltd.

No.134,WuKungRoad,NewTaipeiIndustrialPark,WukuDistrict,NewTaipeiCity,Taiwan24803/新北市五股區新北產業園區五工路 134 號

台灣檢驗科技股份有限公司

t (886-2) 2299-3279

f (886-2) 2298-0488

www.tw.sgs.com

Member of SGS Group



EUT			Measurement					
Operation Band	Fundamental Frequency MHz	CH	Antenna Pol. V/H	S.G. Output dBm	Antenna Gain dBi	Cable Loss dB	EIRP dBm	Limit dBm
<b>BAND 17 BW: 5M QPSK RB: 1,0</b>	706.5	23755	V	9.76	3.09	-3.04	9.82	34.77
			H	14.31	3.09	-3.03	14.37	34.77
	710.0	23790	V	10.64	3.09	-3.04	10.70	34.77
			H	15.38	3.09	-3.04	15.43	34.77
	713.5	23825	V	11.34	3.10	-3.05	11.39	34.77
			H	16.18	3.10	-3.05	<b>16.23</b>	34.77
<b>BAND 17 BW: 5M QPSK RB: 1,24</b>	706.5	23755	V	10.68	3.10	-3.04	10.74	34.77
			H	15.49	3.10	-3.04	15.54	34.77
	710.0	23790	V	11.31	3.10	-3.05	11.36	34.77
			H	16.39	3.10	-3.05	<b>16.44</b>	34.77
	713.5	23825	V	9.67	3.11	-3.06	9.72	34.77
			H	15.34	3.11	-3.06	15.39	34.77
<b>BAND 17 BW: 5M 16QAM RB: 1,0</b>	706.5	23755	V	9.84	3.09	-3.03	9.90	34.77
			H	14.27	3.09	-3.04	14.33	34.77
	710.0	23790	V	10.65	3.09	-3.04	10.70	34.77
			H	15.29	3.09	-3.04	15.34	34.77
	713.5	23825	V	11.58	3.10	-3.05	11.64	34.77
			H	16.30	3.10	-3.05	<b>16.36</b>	34.77
<b>BAND 17 BW: 5M 16QAM RB: 1,24</b>	706.5	23755	V	10.72	3.10	-3.04	10.78	34.77
			H	15.20	3.10	-3.04	15.26	34.77
	710.0	23790	V	11.14	3.10	-3.05	11.19	34.77
			H	16.46	3.10	-3.05	<b>16.51</b>	34.77
	713.5	23825	V	9.49	3.11	-3.06	9.54	34.77
			H	15.11	3.11	-3.06	15.16	34.77

The RBW,VBW of SPA for frequency RBW= 8MHz , VBW= 8MHz

Unless otherwise stated the results shown in this test report refer only to the sample(s) tested and such sample(s) are retained for 90 days only.

除非另有說明，此報告結果僅對測試之樣品負責，同時此樣品僅保留90天。本報告未經本公司書面許可，不可部份複製。

This document is issued by the Company subject to its General Conditions of Service printed overleaf, available on request or accessible at [www.sgs.com/terms\\_and\\_conditions.htm](http://www.sgs.com/terms_and_conditions.htm) and, for electronic format documents, subject to Terms and Conditions for Electronic Documents at [www.sgs.com/terms\\_e-document.htm](http://www.sgs.com/terms_e-document.htm). Attention is drawn to the limitation of liability, indemnification and jurisdiction issues defined therein. Any holder of this document is advised that information contained hereon reflects the Company's findings at the time of its intervention only and within the limits of Client's instructions, if any. The Company's sole responsibility is to its Client and this document does not exonerate parties to a transaction from exercising all their rights and obligations under the transaction documents. This document cannot be reproduced except in full, without prior written approval of the Company. Any unauthorized alteration, forgery or falsification of the content or appearance of this document is unlawful and offenders may be prosecuted to the fullest extent of the law.

SGS Taiwan Ltd.

No.134,WuKungRoad,NewTaipeiIndustrialPark,WukuDistrict,NewTaipeiCity,Taiwan24803/新北市五股區新北產業園區五工路 134 號

台灣檢驗科技股份有限公司

t (886-2) 2299-3279

f (886-2) 2298-0488

www.tw.sgs.com

Member of SGS Group



EUT			Measurement					
Operation Band	Fundamental Frequency MHz	CH	Antenna Pol. V/H	S.G. Output dBm	Antenna Gain dBi	Cable Loss dB	EIRP dBm	Limit dBm
<b>BAND 17 BW: 10M QPSK RB: 1,0</b>	709.0	23780	V	9.82	3.09	-3.03	9.88	34.77
			H	14.19	3.09	-3.03	14.25	34.77
	710.0	23790	V	10.07	3.09	-3.03	10.12	34.77
			H	14.56	3.09	-3.03	14.62	34.77
	711.0	23800	V	10.14	3.09	-3.04	10.20	34.77
			H	14.79	3.09	-3.04	<b>14.84</b>	34.77
<b>BAND 17 BW: 10M QPSK RB: 1,49</b>	709.0	23780	V	10.62	3.11	-3.06	10.67	34.77
			H	15.95	3.11	-3.06	<b>16.00</b>	34.77
	710.0	23790	V	10.06	3.11	-3.06	10.11	34.77
			H	15.37	3.11	-3.06	15.42	34.77
	711.0	23800	V	9.63	3.11	-3.06	9.68	34.77
			H	15.18	3.11	-3.06	15.23	34.77
<b>BAND 17 BW: 10M 16QAM RB: 1,0</b>	709.0	23780	V	9.65	3.09	-3.03	9.70	34.77
			H	14.16	3.09	-3.03	14.22	34.77
	710.0	23790	V	10.04	3.09	-3.03	10.09	34.77
			H	14.63	3.09	-3.03	14.69	34.77
	711.0	23800	V	10.16	3.09	-3.04	10.22	34.77
			H	14.74	3.09	-3.04	<b>14.79</b>	34.77
<b>BAND 17 BW: 10M 16QAM RB: 1,49</b>	709.0	23780	V	10.62	3.11	-3.06	10.67	34.77
			H	15.55	3.11	-3.06	<b>15.60</b>	34.77
	710.0	23790	V	10.07	3.11	-3.06	10.12	34.77
			H	15.37	3.11	-3.06	15.42	34.77
	711.0	23800	V	9.70	3.11	-3.06	9.75	34.77
			H	15.35	3.11	-3.06	15.40	34.77

The RBW,VBW of SPA for frequency RBW= 8MHz , VBW= 8MHz

Unless otherwise stated the results shown in this test report refer only to the sample(s) tested and such sample(s) are retained for 90 days only.

除非另有說明，此報告結果僅對測試之樣品負責，同時此樣品僅保留90天。本報告未經本公司書面許可，不可部份複製。

This document is issued by the Company subject to its General Conditions of Service printed overleaf, available on request or accessible at [www.sgs.com/terms\\_and\\_conditions.htm](http://www.sgs.com/terms_and_conditions.htm) and, for electronic format documents, subject to Terms and Conditions for Electronic Documents at [www.sgs.com/terms\\_e-document.htm](http://www.sgs.com/terms_e-document.htm). Attention is drawn to the limitation of liability, indemnification and jurisdiction issues defined therein. Any holder of this document is advised that information contained hereon reflects the Company's findings at the time of its intervention only and within the limits of Client's instructions, if any. The Company's sole responsibility is to its Client and this document does not exonerate parties to a transaction from exercising all their rights and obligations under the transaction documents. This document cannot be reproduced except in full, without prior written approval of the Company. Any unauthorized alteration, forgery or falsification of the content or appearance of this document is unlawful and offenders may be prosecuted to the fullest extent of the law.

SGS Taiwan Ltd.

No.134,WuKungRoad,NewTaipeiIndustrialPark,WukuDistrict,NewTaipeiCity,Taiwan24803/新北市五股區新北產業園區五工路 134 號

台灣檢驗科技股份有限公司

t (886-2) 2299-3279

f (886-2) 2298-0488

www.tw.sgs.com

Member of SGS Group

EUT			Measurement					
Operation Band	Fundamental Frequency	CH	Antenna Pol.	S.G. Output	Antenna Gain	Cable Loss	EIRP	Limit
	MHz		V/H	dBm	dBi	dB	dBm	dBm
<b>BAND 38</b>	2572.5	37775	V	11.34	10.99	-5.34	17.00	33.00
			H	20.29	10.99	-5.34	25.94	33.00
<b>BW: 5M</b>	2595.0	38000	V	13.71	11.02	-5.34	19.39	33.00
			<b>QPSK</b>	H	22.69	11.02	-5.34	<b>28.36</b>
<b>RB: 1,0</b>	2617.5	38225	V	12.10	11.05	-5.37	17.78	33.00
			H	21.56	11.05	-5.37	27.24	33.00
<b>BAND 38</b>	2572.5	37775	V	12.59	10.99	-5.34	18.24	33.00
			H	22.06	11.00	-5.34	<b>27.72</b>	33.00
<b>BW: 5M</b>	2595.0	38000	V	13.32	11.02	-5.35	19.00	33.00
			<b>QPSK</b>	H	21.96	11.02	-5.35	27.64
<b>RB: 1,24</b>	2617.5	38225	V	12.49	11.05	-5.37	18.18	33.00
			H	21.71	11.05	-5.37	27.39	33.00
<b>BAND 38</b>	2572.5	37775	V	11.15	10.99	-5.34	16.81	33.00
			H	20.21	10.99	-5.34	25.86	33.00
<b>BW: 5M</b>	2595.0	38000	V	13.28	11.02	-5.34	18.96	33.00
			<b>16QAM</b>	H	22.21	11.02	-5.34	<b>27.89</b>
<b>RB: 1,0</b>	2617.5	38225	V	12.05	11.05	-5.37	17.73	33.00
			H	20.89	11.05	-5.37	26.57	33.00
<b>BAND 38</b>	2572.5	37775	V	12.49	10.99	-5.34	18.15	33.00
			H	21.14	10.99	-5.34	26.80	33.00
<b>BW: 5M</b>	2595.0	38000	V	13.35	11.02	-5.35	19.03	33.00
			<b>16QAM</b>	H	21.32	11.02	-5.35	<b>27.00</b>
<b>RB: 1,24</b>	2617.5	38225	V	12.42	11.05	-5.37	18.10	33.00
			H	20.72	11.05	-5.37	26.40	33.00
The RBW,VBW of SPA for frequency RBW= 8MHz , VBW= 8MHz								

Unless otherwise stated the results shown in this test report refer only to the sample(s) tested and such sample(s) are retained for 90 days only.

除非另有說明，此報告結果僅對測試之樣品負責，同時此樣品僅保留90天。本報告未經本公司書面許可，不可部份複製。

This document is issued by the Company subject to its General Conditions of Service printed overleaf, available on request or accessible at [www.sgs.com/terms\\_and\\_conditions.htm](http://www.sgs.com/terms_and_conditions.htm) and, for electronic format documents, subject to Terms and Conditions for Electronic Documents at [www.sgs.com/terms\\_e-document.htm](http://www.sgs.com/terms_e-document.htm). Attention is drawn to the limitation of liability, indemnification and jurisdiction issues defined therein. Any holder of this document is advised that information contained hereon reflects the Company's findings at the time of its intervention only and within the limits of Client's instructions, if any. The Company's sole responsibility is to its Client and this document does not exonerate parties to a transaction from exercising all their rights and obligations under the transaction documents. This document cannot be reproduced except in full, without prior written approval of the Company. Any unauthorized alteration, forgery or falsification of the content or appearance of this document is unlawful and offenders may be prosecuted to the fullest extent of the law.

SGS Taiwan Ltd.

No.134,WuKungRoad,NewTaipeiIndustrialPark,WukuDistrict,NewTaipeiCity,Taiwan24803/新北市五股區新北產業園區五工路 134 號

台灣檢驗科技股份有限公司

t (886-2) 2299-3279

f (886-2) 2298-0488

www.tw.sgs.com

Member of SGS Group

EUT			Measurement					
Operation Band	Fundamental Frequency MHz	CH	Antenna Pol. V/H	S.G. Output dBm	Antenna Gain dBi	Cable Loss dB	EIRP dBm	Limit dBm
<b>BAND 38 BW: 10M QPSK RB: 1,0</b>	2575.0	37800	V	12.56	10.99	-5.34	18.21	33.00
			H	20.72	10.99	-5.34	26.37	33.00
	2595.0	38000	V	14.13	11.02	-5.34	19.81	33.00
			H	22.24	11.02	-5.34	<b>27.92</b>	33.00
	2615.0	38200	V	13.04	11.04	-5.36	18.72	33.00
			H	21.15	11.04	-5.36	26.83	33.00
<b>BAND 38 BW: 10M QPSK RB: 1,49</b>	2575.0	37800	V	14.98	11.00	-5.34	20.64	33.00
			H	22.73	11.00	-5.34	<b>28.39</b>	33.00
	2595.0	38000	V	13.64	11.03	-5.35	19.32	33.00
			H	21.21	11.03	-5.35	26.88	33.00
	2615.0	38200	V	13.47	11.05	-5.37	19.15	33.00
			H	21.52	11.05	-5.37	27.20	33.00
<b>BAND 38 BW: 10M 16QAM RB: 1,0</b>	2575.0	37800	V	12.15	10.99	-5.34	17.81	33.00
			H	19.93	10.99	-5.34	25.58	33.00
	2595.0	38000	V	14.34	11.02	-5.34	20.02	33.00
			H	21.82	11.02	-5.34	<b>27.49</b>	33.00
	2615.0	38200	V	12.01	11.04	-5.36	17.70	33.00
			H	20.18	11.04	-5.36	25.86	33.00
<b>BAND 38 BW: 10M 16QAM RB: 1,49</b>	2575.0	37800	V	14.06	11.00	-5.34	19.72	33.00
			H	21.97	11.00	-5.34	<b>27.63</b>	33.00
	2595.0	38000	V	13.15	11.03	-5.35	18.83	33.00
			H	21.03	11.03	-5.35	26.71	33.00
	2615.0	38200	V	12.52	11.05	-5.37	18.20	33.00
			H	20.84	11.05	-5.37	26.53	33.00

The RBW,VBW of SPA for frequency RBW= 8MHz , VBW= 8MHz

Unless otherwise stated the results shown in this test report refer only to the sample(s) tested and such sample(s) are retained for 90 days only.

除非另有說明，此報告結果僅對測試之樣品負責，同時此樣品僅保留90天。本報告未經本公司書面許可，不可部份複製。

This document is issued by the Company subject to its General Conditions of Service printed overleaf, available on request or accessible at [www.sgs.com/terms\\_and\\_conditions.htm](http://www.sgs.com/terms_and_conditions.htm) and, for electronic format documents, subject to Terms and Conditions for Electronic Documents at [www.sgs.com/terms\\_e-document.htm](http://www.sgs.com/terms_e-document.htm). Attention is drawn to the limitation of liability, indemnification and jurisdiction issues defined therein. Any holder of this document is advised that information contained hereon reflects the Company's findings at the time of its intervention only and within the limits of Client's instructions, if any. The Company's sole responsibility is to its Client and this document does not exonerate parties to a transaction from exercising all their rights and obligations under the transaction documents. This document cannot be reproduced except in full, without prior written approval of the Company. Any unauthorized alteration, forgery or falsification of the content or appearance of this document is unlawful and offenders may be prosecuted to the fullest extent of the law.

SGS Taiwan Ltd.

No.134,WuKungRoad,NewTaipeiIndustrialPark,WukuDistrict,NewTaipeiCity,Taiwan24803/新北市五股區新北產業園區五工路 134 號

台灣檢驗科技股份有限公司

t (886-2) 2299-3279

f (886-2) 2298-0488

www.tw.sgs.com

Member of SGS Group

EUT			Measurement					
Operation Band	Fundamental Frequency MHz	CH	Antenna Pol. V/H	S.G. Output dBm	Antenna Gain dBi	Cable Loss dB	EIRP dBm	Limit dBm
<b>BAND 38 BW: 15M QPSK RB: 1,0</b>	2575.0	37800	V	12.40	10.99	-5.34	18.05	33.00
			H	20.14	10.99	-5.34	25.79	33.00
	2595.0	38000	V	14.47	11.02	-5.34	20.14	33.00
			H	22.10	11.02	-5.34	<b>27.77</b>	33.00
	2615.0	38200	V	12.49	11.04	-5.36	18.17	33.00
			H	20.42	11.04	-5.36	26.10	33.00
<b>BAND 38 BW: 15M QPSK RB: 1,74</b>	2575.0	37800	V	14.51	11.01	-5.34	20.18	33.00
			H	22.35	11.01	-5.34	<b>28.02</b>	33.00
	2595.0	38000	V	13.24	11.03	-5.35	18.92	33.00
			H	20.75	11.03	-5.35	26.43	33.00
	2615.0	38200	V	12.71	11.05	-5.37	18.39	33.00
			H	20.78	11.05	-5.37	26.46	33.00
<b>BAND 38 BW: 15M 16QAM RB: 1,0</b>	2575.0	37800	V	12.33	10.99	-5.34	17.99	33.00
			H	20.10	10.99	-5.34	25.75	33.00
	2595.0	38000	V	14.18	11.02	-5.34	19.86	33.00
			H	21.80	11.02	-5.34	<b>27.48</b>	33.00
	2615.0	38200	V	12.45	11.04	-5.36	18.13	33.00
			H	20.28	11.04	-5.36	25.96	33.00
<b>BAND 38 BW: 15M 16QAM RB: 1,74</b>	2575.0	37800	V	14.19	11.01	-5.34	19.85	33.00
			H	22.00	11.01	-5.34	<b>27.66</b>	33.00
	2595.0	38000	V	13.15	11.03	-5.35	18.82	33.00
			H	20.66	11.03	-5.35	26.34	33.00
	2615.0	38200	V	12.58	11.05	-5.37	18.26	33.00
			H	20.55	11.05	-5.37	26.23	33.00

The RBW,VBW of SPA for frequency RBW= 8MHz , VBW= 8MHz

Unless otherwise stated the results shown in this test report refer only to the sample(s) tested and such sample(s) are retained for 90 days only.

除非另有說明，此報告結果僅對測試之樣品負責，同時此樣品僅保留90天。本報告未經本公司書面許可，不可部份複製。

This document is issued by the Company subject to its General Conditions of Service printed overleaf, available on request or accessible at [www.sgs.com/terms\\_and\\_conditions.htm](http://www.sgs.com/terms_and_conditions.htm) and, for electronic format documents, subject to Terms and Conditions for Electronic Documents at [www.sgs.com/terms\\_e-document.htm](http://www.sgs.com/terms_e-document.htm). Attention is drawn to the limitation of liability, indemnification and jurisdiction issues defined therein. Any holder of this document is advised that information contained hereon reflects the Company's findings at the time of its intervention only and within the limits of Client's instructions, if any. The Company's sole responsibility is to its Client and this document does not exonerate parties to a transaction from exercising all their rights and obligations under the transaction documents. This document cannot be reproduced except in full, without prior written approval of the Company. Any unauthorized alteration, forgery or falsification of the content or appearance of this document is unlawful and offenders may be prosecuted to the fullest extent of the law.

SGS Taiwan Ltd.

No.134,WuKungRoad,NewTaipeiIndustrialPark,WukuDistrict,NewTaipeiCity,Taiwan24803/新北市五股區新北產業園區五工路 134 號

台灣檢驗科技股份有限公司

t (886-2) 2299-3279

f (886-2) 2298-0488

www.tw.sgs.com

Member of SGS Group

EUT			Measurement					
Operation Band	Fundamental Frequency MHz	CH	Antenna Pol. V/H	S.G. Output dBm	Antenna Gain dBi	Cable Loss dB	EIRP dBm	Limit dBm
<b>BAND 38 BW: 20M QPSK RB: 1,0</b>	2580.0	37850	V	12.48	10.99	-5.34	18.13	33.00
			H	18.86	10.99	-5.34	24.51	33.00
	2595.0	38000	V	14.64	11.01	-5.34	20.31	33.00
			H	20.91	11.01	-5.34	<b>26.58</b>	33.00
	2610.0	38150	V	13.26	11.03	-5.35	18.94	33.00
			H	19.19	11.03	-5.35	24.87	33.00
<b>BAND 38 BW: 20M QPSK RB: 1,74</b>	2580.0	37850	V	14.73	11.01	-5.34	20.40	33.00
			H	20.75	11.01	-5.34	<b>26.43</b>	33.00
	2595.0	38000	V	12.83	11.03	-5.35	18.51	33.00
			H	12.70	11.03	-5.35	18.37	33.00
	2610.0	38150	V	19.15	11.03	-5.35	24.83	33.00
			H	19.40	11.05	-5.37	25.08	33.00
<b>BAND 38 BW: 20M 16QAM RB: 1,0</b>	2580.0	37850	V	12.33	10.99	-5.34	17.98	33.00
			H	18.72	10.99	-5.34	24.37	33.00
	2595.0	38000	V	14.44	11.01	-5.34	20.11	33.00
			H	20.68	11.01	-5.34	<b>26.35</b>	33.00
	2610.0	38150	V	13.07	11.03	-5.35	18.74	33.00
			H	19.13	11.03	-5.35	24.80	33.00
<b>BAND 38 BW: 20M 16QAM RB: 1,74</b>	2580.0	37850	V	14.21	11.01	-5.34	19.88	33.00
			H	20.39	11.01	-5.34	<b>26.07</b>	33.00
	2595.0	38000	V	12.55	11.03	-5.35	18.23	33.00
			H	18.95	11.03	-5.35	24.63	33.00
	2610.0	38150	V	12.35	11.05	-5.37	18.03	33.00
			H	19.03	11.05	-5.37	24.71	33.00

The RBW,VBW of SPA for frequency RBW= 8MHz , VBW= 8MHz

Unless otherwise stated the results shown in this test report refer only to the sample(s) tested and such sample(s) are retained for 90 days only.

除非另有說明，此報告結果僅對測試之樣品負責，同時此樣品僅保留90天。本報告未經本公司書面許可，不可部份複製。

This document is issued by the Company subject to its General Conditions of Service printed overleaf, available on request or accessible at [www.sgs.com/terms\\_and\\_conditions.htm](http://www.sgs.com/terms_and_conditions.htm) and, for electronic format documents, subject to Terms and Conditions for Electronic Documents at [www.sgs.com/terms\\_e-document.htm](http://www.sgs.com/terms_e-document.htm). Attention is drawn to the limitation of liability, indemnification and jurisdiction issues defined therein. Any holder of this document is advised that information contained hereon reflects the Company's findings at the time of its intervention only and within the limits of Client's instructions, if any. The Company's sole responsibility is to its Client and this document does not exonerate parties to a transaction from exercising all their rights and obligations under the transaction documents. This document cannot be reproduced except in full, without prior written approval of the Company. Any unauthorized alteration, forgery or falsification of the content or appearance of this document is unlawful and offenders may be prosecuted to the fullest extent of the law.

SGS Taiwan Ltd.

No.134,WuKungRoad,NewTaipeiIndustrialPark,WukuDistrict,NewTaipeiCity,Taiwan24803/新北市五股區新北產業園區五工路 134 號

台灣檢驗科技股份有限公司

t (886-2) 2299-3279

f (886-2) 2298-0488

www.tw.sgs.com

Member of SGS Group

## 8. OCCUPIED BANDWIDTH MEASUREMENT

### 8.1. Standard Applicable

The occupied bandwidth is the frequency bandwidth such that, below its lower and above its upper frequency limits, the mean powers radiated are each equal to 0.5 percent of the total mean power.

### 8.2. Test Set-up

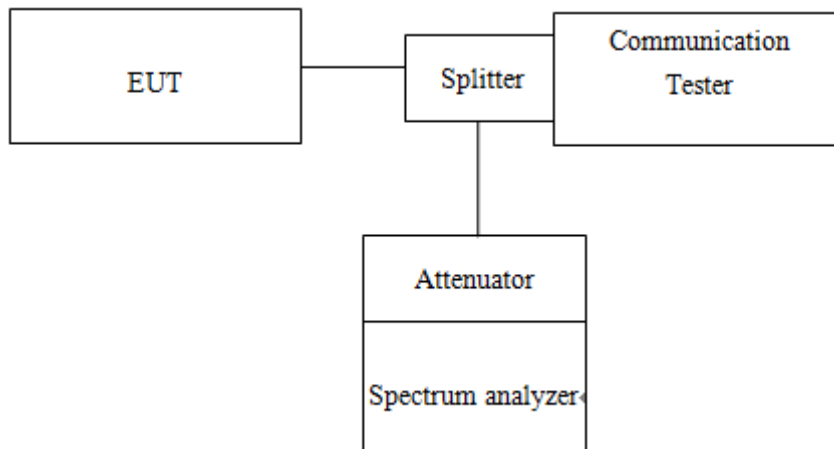

### 8.3. Measurement Procedure

#### **99% & 26dB Bandwidth with detector peak**

The EUT's output RF connector was connected with a short cable to the spectrum analyzer, RBW was set to about 1% of emission BW, VBW= 3 times RBW, -26dBc display line was placed on the screen (or 26dB bandwidth), the occupied bandwidth is the delta frequency between the two points where the display line intersects the signal trace. Then set RBW to 99% bandwidth, RBW= 1%, VBW= 3 RBW, with span > 2 \* Signal BW, set % Power = 99%.

#### **99% Bandwidth with detector sample**

The EUT's output RF connector was connected with a short cable to the spectrum analyzer, RBW was set to about 1% ~ 5% of emission BW, VBW= 3 times RBW, -20dBc display line was placed on the screen (or 20dB bandwidth). Set RBW to 99% bandwidth, RBW= 1% ~ 5%, VBW= 3 RBW, with span > 2 \* Signal BW, set % Power = 99%.

Unless otherwise stated the results shown in this test report refer only to the sample(s) tested and such sample(s) are retained for 90 days only.

除非另有說明，此報告結果僅對測試之樣品負責，同時此樣品僅保留90天。本報告未經本公司書面許可，不可部份複製。

This document is issued by the Company subject to its General Conditions of Service printed overleaf, available on request or accessible at [www.sgs.com/terms\\_and\\_conditions.htm](http://www.sgs.com/terms_and_conditions.htm) and, for electronic format documents, subject to Terms and Conditions for Electronic Documents at [www.sgs.com/terms\\_e-document.htm](http://www.sgs.com/terms_e-document.htm). Attention is drawn to the limitation of liability, indemnification and jurisdiction issues defined therein. Any holder of this document is advised that information contained hereon reflects the Company's findings at the time of its intervention only and within the limits of Client's instructions, if any. The Company's sole responsibility is to its Client and this document does not exonerate parties to a transaction from exercising all their rights and obligations under the transaction documents. This document cannot be reproduced except in full, without prior written approval of the Company. Any unauthorized alteration, forgery or falsification of the content or appearance of this document is unlawful and offenders may be prosecuted to the fullest extent of the law.

#### 8.4. Measurement Equipment Used

Conducted Emission (measured at antenna port) Test Site					
EQUIPMENT TYPE	MFR	MODEL NUMBER	SERIAL NUMBER	LAST CAL.	CAL DUE.
EXA Spectrum Analyzer	Agilent	N9030A	MY53120760	03/21/2017	03/20/2018
DC Block	Mini-Circuits	BLK-18-S+	1	01/05/2017	01/04/2018
Coaxial Cable	HUBER+SÜHNER	SUCOFLEX 102	23670/2	01/05/2017	01/04/2018
Attenuator	Mini-Circuit	BW-S10W2+	2	01/05/2017	01/04/2018
Splitter	Agilent	11636B	N/A	01/05/2017	01/04/2018
DC Power Supply	Agilent	E3640A	MY52410006	11/21/2016	11/20/2017
Temperature Chamber	TERCHY	MHG-120LF	911009	05/19/2017	05/18/2018
Radio Communication Analyzer	R&S	CMU200	102189	02/10/2017	02/09/2018
Radio Communication Analyzer	Anritsu	MT8820C	6201465317	01/03/2017	01/02/2018

Unless otherwise stated the results shown in this test report refer only to the sample(s) tested and such sample(s) are retained for 90 days only.

除非另有說明，此報告結果僅對測試之樣品負責，同時此樣品僅保留90天。本報告未經本公司書面許可，不可部份複製。

This document is issued by the Company subject to its General Conditions of Service printed overleaf, available on request or accessible at [www.sgs.com/terms\\_and\\_conditions.htm](http://www.sgs.com/terms_and_conditions.htm) and, for electronic format documents, subject to Terms and Conditions for Electronic Documents at [www.sgs.com/terms\\_e-document.htm](http://www.sgs.com/terms_e-document.htm). Attention is drawn to the limitation of liability, indemnification and jurisdiction issues defined therein. Any holder of this document is advised that information contained hereon reflects the Company's findings at the time of its intervention only and within the limits of Client's instructions, if any. The Company's sole responsibility is to its Client and this document does not exonerate parties to a transaction from exercising all their rights and obligations under the transaction documents. This document cannot be reproduced except in full, without prior written approval of the Company. Any unauthorized alteration, forgery or falsification of the content or appearance of this document is unlawful and offenders may be prosecuted to the fullest extent of the law.

SGS Taiwan Ltd.

No. 134, WuKungRoad, NewTaipeiIndustrialPark, WukuDistrict, NewTaipeiCity, Taiwan24803/新北市五股區新北產業園區五工路 134 號

台灣檢驗科技股份有限公司

t (886-2) 2299-3279

f (886-2) 2298-0488

[www.tw.sgs.com](http://www.tw.sgs.com)

Member of SGS Group



### 8.5. Measurement Result

Freq. (MHz)	CH	99% BW (MHz)			26 dB BW (MHz)		
		GSM 850	GPRS 850	EDGE 850	GPRS 850	GPRS 850	EDGE 850
824.2	128	0.24340	0.24477	0.24512	0.31770	0.32020	0.30470
836.6	190	0.24623	0.24835	0.24474	0.32000	0.31620	0.31800
848.8	251	0.24202	0.24835	0.24765	0.31180	0.31650	0.32230

Freq. (MHz)	CH	99% BW (MHz)			26 dB BW (MHz)		
		GSM 1900	GPRS 1900	EDGE 1900	GSM 1900	GPRS 1900	EDGE 1900
1850.2	512	0.24590	0.24045	0.24874	0.31610	0.31390	0.32020
1880.0	661	0.24384	0.24181	0.24071	0.31210	0.31910	0.31490
1909.8	810	0.24845	0.24374	0.24642	3.22100	0.31500	0.31880

Freq. (MHz)	CH	99% BW (MHz)			26 dB BW (MHz)		
		WCDMA II	HSDPA II	HSUPA II	WCDMA II	HSDPA II	HSUPA II
1850.20	9262	4.1554	4.1572	4.1586	4.7230	4.7230	4.7320
1880.00	9400	4.1622	4.1669	4.1561	4.7180	4.7470	4.7190
1909.80	9538	4.1438	4.1493	4.1430	4.7130	4.7170	4.7300

Freq. (MHz)	CH	99% BW (MHz)			26 dB BW (MHz)		
		WCDMA IV	HSDPA IV	HSUPA IV	WCDMA IV	HSDPA IV	HSUPA IV
1712.40	1312	4.1491	4.1638	4.1562	4.6920	4.7080	4.7070
1732.60	1413	4.1412	4.1510	4.1622	4.6950	4.7080	4.7020
1752.60	1513	4.1444	4.1609	4.1648	4.6860	4.7060	4.7140

Freq. (MHz)	CH	99% BW (MHz)			26 dB BW (MHz)		
		WCDMA V	HSDPA V	HSUPA V	WCDMA V	HSDPA V	HSUPA V
826.40	4132	4.1329	4.1502	4.1347	4.7100	4.6870	4.7050
836.60	4183	4.1432	4.1535	4.1430	4.6900	4.7130	4.7000
846.60	4233	4.1450	4.1413	4.1509	4.7070	4.7100	4.6950

Unless otherwise stated the results shown in this test report refer only to the sample(s) tested and such sample(s) are retained for 90 days only.

除非另有說明，此報告結果僅對測試之樣品負責，同時此樣品僅保留90天。本報告未經本公司書面許可，不可部份複製。

This document is issued by the Company subject to its General Conditions of Service printed overleaf, available on request or accessible at [www.sgs.com/terms\\_and\\_conditions.htm](http://www.sgs.com/terms_and_conditions.htm) and, for electronic format documents, subject to Terms and Conditions for Electronic Documents at [www.sgs.com/terms\\_e-document.htm](http://www.sgs.com/terms_e-document.htm). Attention is drawn to the limitation of liability, indemnification and jurisdiction issues defined therein. Any holder of this document is advised that information contained hereon reflects the Company's findings at the time of its intervention only and within the limits of Client's instructions, if any. The Company's sole responsibility is to its Client and this document does not exonerate parties to a transaction from exercising all their rights and obligations under the transaction documents. This document cannot be reproduced except in full, without prior written approval of the Company. Any unauthorized alteration, forgery or falsification of the content or appearance of this document is unlawful and offenders may be prosecuted to the fullest extent of the law.

LTE BAND 2 Channel bandwidth: 1.4MHz					
Freq. (MHz)	CH	99% BW (MHz)		26 dB BW (MHz)	
		QPSK	16QAM	QPSK	16QAM
1850.7	18607	1.0959	<b>1.1016</b>	1.285	1.289
1880.0	18900	<b>1.0996</b>	1.0996	<b>1.305</b>	1.287
1909.3	19193	<b>1.0996</b>	1.0996	1.297	<b>1.298</b>

LTE BAND 2 Channel bandwidth: 3MHz					
Freq. (MHz)	CH	99% BW (MHz)		26 dB BW (MHz)	
		QPSK	16QAM	QPSK	16QAM
1851.5	18615	2.7014	2.7042	<b>2.986</b>	3.003
1880.0	18900	<b>2.7034</b>	<b>2.7058</b>	2.979	<b>3.003</b>
1908.5	19185	2.7028	2.7050	2.982	2.993

LTE BAND 2 Channel bandwidth: 5MHz					
Freq. (MHz)	CH	99% BW (MHz)		26 dB BW (MHz)	
		QPSK	16QAM	QPSK	16QAM
1852.5	18625	<b>4.5123</b>	<b>4.5124</b>	<b>5.059</b>	<b>5.049</b>
1880.0	18900	4.5047	4.5106	5.025	5.015
1907.5	19175	4.5093	4.5091	5.052	5.038

LTE BAND 2 Channel bandwidth: 10MHz					
Freq. (MHz)	CH	99% BW (MHz)		26 dB BW (MHz)	
		QPSK	16QAM	QPSK	16QAM
1855.0	18650	8.9843	<b>8.9586</b>	9.894	<b>9.844</b>
1880.0	18900	<b>9.0240</b>	8.9553	<b>9.928</b>	9.807
1905.0	19150	8.9802	8.9428	9.908	9.762

LTE BAND 2 Channel bandwidth: 15MHz					
Freq. (MHz)	CH	99% BW (MHz)		26 dB BW (MHz)	
		QPSK	16QAM	QPSK	16QAM
1857.5	18675	13.482	13.466	<b>14.80</b>	<b>14.84</b>
1880.0	18900	<b>13.504</b>	<b>13.490</b>	14.73	14.78
1902.5	19125	13.494	13.477	14.73	14.83

LTE BAND 2 Channel bandwidth: 20MHz					
Freq. (MHz)	CH	99% BW (MHz)		26 dB BW (MHz)	
		QPSK	16QAM	QPSK	16QAM
1860.0	18700	17.893	17.941	19.46	<b>19.48</b>
1880.0	18900	<b>17.952</b>	<b>17.993</b>	19.52	19.41
1900.0	19100	17.951	<b>17.993</b>	<b>19.56</b>	19.41

Unless otherwise stated the results shown in this test report refer only to the sample(s) tested and such sample(s) are retained for 90 days only.

除非另有說明，此報告結果僅對測試之樣品負責，同時此樣品僅保留90天。本報告未經本公司書面許可，不可部份複製。

This document is issued by the Company subject to its General Conditions of Service printed overleaf, available on request or accessible at [www.sgs.com/terms\\_and\\_conditions.htm](http://www.sgs.com/terms_and_conditions.htm) and, for electronic format documents, subject to Terms and Conditions for Electronic Documents at [www.sgs.com/terms\\_e-document.htm](http://www.sgs.com/terms_e-document.htm). Attention is drawn to the limitation of liability, indemnification and jurisdiction issues defined therein. Any holder of this document is advised that information contained hereon reflects the Company's findings at the time of its intervention only and within the limits of Client's instructions, if any. The Company's sole responsibility is to its Client and this document does not exonerate parties to a transaction from exercising all their rights and obligations under the transaction documents. This document cannot be reproduced except in full, without prior written approval of the Company. Any unauthorized alteration, forgery or falsification of the content or appearance of this document is unlawful and offenders may be prosecuted to the fullest extent of the law.

LTE BAND 4 Channel bandwidth: 1.4MHz					
Freq. (MHz)	CH	99% BW (MHz)		26 dB BW (MHz)	
		QPSK	16QAM	QPSK	16QAM
1710.7	19957	1.0978	<b>1.1018</b>	<b>1.289</b>	1.296
1732.5	20175	<b>1.0982</b>	1.1016	1.289	1.287
1754.3	20393	<b>1.0982</b>	1.1011	1.286	<b>1.303</b>

LTE BAND 4 Channel bandwidth: 3MHz					
Freq. (MHz)	CH	99% BW (MHz)		26 dB BW (MHz)	
		QPSK	16QAM	QPSK	16QAM
1711.5	19965	2.6993	<b>2.7065</b>	2.994	<b>3.002</b>
1732.5	20175	<b>2.7050</b>	2.7049	<b>3.003</b>	2.997
1753.5	20385	2.7022	2.7026	2.988	2.999

LTE BAND 4 Channel bandwidth: 5MHz					
Freq. (MHz)	CH	99% BW (MHz)		26 dB BW (MHz)	
		QPSK	16QAM	QPSK	16QAM
1712.5	19957	<b>4.5108</b>	4.5090	5.033	5.007
1732.5	20175	4.5055	4.5071	<b>5.049</b>	<b>5.012</b>
1752.5	20375	4.5104	<b>4.5110</b>	5.046	5.011

LTE BAND 4 Channel bandwidth: 10MHz					
Freq. (MHz)	CH	99% BW (MHz)		26 dB BW (MHz)	
		QPSK	16QAM	QPSK	16QAM
1715.0	20000	<b>9.0084</b>	8.9548	<b>9.928</b>	9.857
1732.5	20175	8.9987	<b>8.9569</b>	9.908	<b>9.858</b>
1750.0	20350	8.9911	8.9534	9.885	9.826

LTE BAND 4 Channel bandwidth: 15MHz					
Freq. (MHz)	CH	99% BW (MHz)		26 dB BW (MHz)	
		QPSK	16QAM	QPSK	16QAM
1717.5	20025	13.502	13.478	14.72	14.79
1732.5	20175	13.498	13.475	14.75	14.86
1747.5	20325	<b>13.504</b>	<b>13.486</b>	<b>14.83</b>	<b>14.89</b>

LTE BAND 4 Channel bandwidth: 20MHz					
Freq. (MHz)	CH	99% BW (MHz)		26 dB BW (MHz)	
		QPSK	16QAM	QPSK	16QAM
1720.0	20050	17.937	17.942	19.57	19.54
1732.5	20175	17.923	17.930	19.50	19.50
1745.0	20300	<b>17.980</b>	<b>17.992</b>	<b>19.58</b>	<b>19.54</b>

LTE BAND 7 Channel bandwidth: 5MHz					
Freq. (MHz)	CH	99% BW (MHz)		26 dB BW (MHz)	
		QPSK	16QAM	QPSK	16QAM
2502.5	20775	4.5159	<b>4.5150</b>	5.059	5.035
2535.0	21100	4.5156	4.5131	5.059	<b>5.038</b>
2567.5	21425	<b>4.5266</b>	4.5104	<b>5.144</b>	5.034

LTE BAND 7 Channel bandwidth: 10MHz					
Freq. (MHz)	CH	99% BW (MHz)		26 dB BW (MHz)	
		QPSK	16QAM	QPSK	16QAM
2505.0	20800	9.0022	8.9572	9.945	<b>9.882</b>
2535.0	21100	<b>9.0083</b>	<b>8.9647</b>	9.913	9.856
2565.0	21400	9.0064	8.9544	<b>9.958</b>	9.841

LTE BAND 7 Channel bandwidth: 15MHz					
Freq. (MHz)	CH	99% BW (MHz)		26 dB BW (MHz)	
		QPSK	16QAM	QPSK	16QAM
2507.5	20825	<b>13.501</b>	<b>13.484</b>	14.84	14.78
2535.0	21100	13.491	13.469	<b>14.84</b>	<b>14.84</b>
2562.5	21375	13.494	13.476	14.82	14.83

LTE BAND 7 Channel bandwidth: 20MHz					
Freq. (MHz)	CH	99% BW (MHz)		26 dB BW (MHz)	
		QPSK	16QAM	QPSK	16QAM
2510.0	20850	17.936	<b>17.989</b>	<b>19.59</b>	<b>19.59</b>
2535.0	21100	<b>17.947</b>	17.959	19.47	19.50
2560.0	21350	17.900	17.966	19.49	19.53

Unless otherwise stated the results shown in this test report refer only to the sample(s) tested and such sample(s) are retained for 90 days only.

除非另有說明，此報告結果僅對測試之樣品負責，同時此樣品僅保留90天。本報告未經本公司書面許可，不可部份複製。

This document is issued by the Company subject to its General Conditions of Service printed overleaf, available on request or accessible at [www.sgs.com/terms\\_and\\_conditions.htm](http://www.sgs.com/terms_and_conditions.htm) and, for electronic format documents, subject to Terms and Conditions for Electronic Documents at [www.sgs.com/terms\\_e-document.htm](http://www.sgs.com/terms_e-document.htm). Attention is drawn to the limitation of liability, indemnification and jurisdiction issues defined therein. Any holder of this document is advised that information contained hereon reflects the Company's findings at the time of its intervention only and within the limits of Client's instructions, if any. The Company's sole responsibility is to its Client and this document does not exonerate parties to a transaction from exercising all their rights and obligations under the transaction documents. This document cannot be reproduced except in full, without prior written approval of the Company. Any unauthorized alteration, forgery or falsification of the content or appearance of this document is unlawful and offenders may be prosecuted to the fullest extent of the law.

SGS Taiwan Ltd.

No. 134, WuKungRoad, NewTaipeiIndustrialPark, WukuDistrict, NewTaipeiCity, Taiwan24803/新北市五股區新北產業園區五工路 134 號

台灣檢驗科技股份有限公司

t (886-2) 2299-3279

f (886-2) 2298-0488

www.tw.sgs.com

Member of SGS Group

LTE BAND 12 Channel bandwidth: 1.4MHz					
Freq. (MHz)	CH	99% BW (MHz)		26 dB BW (MHz)	
		QPSK	16QAM	QPSK	16QAM
699.7	23017	<b>1.1013</b>	1.0998	1.256	1.286
707.5	23095	1.0963	1.1004	1.290	1.291
715.3	23173	1.0972	<b>1.1024</b>	<b>1.294</b>	<b>1.293</b>

LTE BAND 12 Channel bandwidth: 3MHz					
Freq. (MHz)	CH	99% BW (MHz)		26 dB BW (MHz)	
		QPSK	16QAM	QPSK	16QAM
700.5	23025	2.6987	<b>2.7048</b>	2.987	<b>3.014</b>
707.5	23095	2.6832	2.7000	2.899	2.926
714.5	23165	<b>2.7047</b>	2.6985	<b>2.992</b>	2.919

LTE BAND 12 Channel bandwidth: 5MHz					
Freq. (MHz)	CH	99% BW (MHz)		26 dB BW (MHz)	
		QPSK	16QAM	QPSK	16QAM
701.5	23035	<b>4.5181</b>	4.5147	<b>5.069</b>	5.051
707.5	23095	4.5012	4.5117	4.915	5.026
713.5	23155	4.5083	<b>4.5165</b>	4.889	<b>5.052</b>

LTE BAND 12 Channel bandwidth: 10MHz					
Freq. (MHz)	CH	99% BW (MHz)		26 dB BW (MHz)	
		QPSK	16QAM	QPSK	16QAM
704.0	23060	<b>9.0295</b>	8.9495	<b>9.949</b>	9.555
707.5	23095	8.9686	<b>8.9508</b>	9.546	9.817
711.0	23130	9.0014	8.9410	9.887	<b>9.834</b>

LTE BAND 17 Channel bandwidth: 5MHz					
Freq. (MHz)	CH	99% BW (MHz)		26 dB BW (MHz)	
		QPSK	16QAM	QPSK	16QAM
706.5	23755	4.5180	<b>4.5908</b>	4.958	4.829
710.0	23790	4.5088	4.5129	5.063	5.024
713.5	23825	<b>4.5211</b>	4.5148	<b>5.077</b>	<b>5.025</b>

LTE BAND 17 Channel bandwidth: 10MHz					
Freq. (MHz)	CH	99% BW (MHz)		26 dB BW (MHz)	
		QPSK	16QAM	QPSK	16QAM
709.0	23780	9.0852	<b>9.1227</b>	9.517	9.655
710.0	23790	<b>9.1035</b>	8.9459	9.527	9.776
711.0	23780	8.9921	8.9518	<b>9.894</b>	<b>9.817</b>

LTE BAND 38 Channel bandwidth: 5MHz					
Freq. (MHz)	CH	99% BW (MHz)		26 dB BW (MHz)	
		QPSK	16QAM	QPSK	16QAM
2572.5	37775	<b>4.5239</b>	<b>4.5141</b>	5.387	<b>5.060</b>
2595.0	38000	4.5214	4.5128	5.368	5.027
2617.5	38225	4.5201	4.5119	<b>5.470</b>	5.042

LTE BAND 38 Channel bandwidth: 10MHz					
Freq. (MHz)	CH	99% BW (MHz)		26 dB BW (MHz)	
		QPSK	16QAM	QPSK	16QAM
2575.0	37800	8.9725	8.9626	<b>10.069</b>	9.813
2595.0	38000	<b>8.9864</b>	8.9622	10.033	9.939
2615.0	38200	8.9704	<b>8.9821</b>	9.928	<b>10.121</b>

LTE BAND 38 Channel bandwidth: 15MHz					
Freq. (MHz)	CH	99% BW (MHz)		26 dB BW (MHz)	
		QPSK	16QAM	QPSK	16QAM
2577.5	37825	13.495	<b>13.521</b>	15.41	<b>15.44</b>
2595.0	38000	13.493	13.512	15.61	15.37
2612.5	38175	<b>13.501</b>	13.491	<b>15.67</b>	14.77

LTE BAND 38 Channel bandwidth: 20MHz					
Freq. (MHz)	CH	99% BW (MHz)		26 dB BW (MHz)	
		QPSK	16QAM	QPSK	16QAM
2580.0	37850	<b>17.959</b>	<b>17.970</b>	21.17	19.48
2595.0	38000	17.952	17.910	20.42	19.48
2610.0	38150	17.931	17.924	19.84	<b>19.55</b>

Unless otherwise stated the results shown in this test report refer only to the sample(s) tested and such sample(s) are retained for 90 days only.

除非另有說明，此報告結果僅對測試之樣品負責，同時此樣品僅保留90天。本報告未經本公司書面許可，不可部份複製。

This document is issued by the Company subject to its General Conditions of Service printed overleaf, available on request or accessible at [www.sgs.com/terms\\_and\\_conditions.htm](http://www.sgs.com/terms_and_conditions.htm) and, for electronic format documents, subject to Terms and Conditions for Electronic Documents at [www.sgs.com/terms\\_e-document.htm](http://www.sgs.com/terms_e-document.htm). Attention is drawn to the limitation of liability, indemnification and jurisdiction issues defined therein. Any holder of this document is advised that information contained hereon reflects the Company's findings at the time of its intervention only and within the limits of Client's instructions, if any. The Company's sole responsibility is to its Client and this document does not exonerate parties to a transaction from exercising all their rights and obligations under the transaction documents. This document cannot be reproduced except in full, without prior written approval of the Company. Any unauthorized alteration, forgery or falsification of the content or appearance of this document is unlawful and offenders may be prosecuted to the fullest extent of the law.

SGS Taiwan Ltd.

No. 134, WuKungRoad, NewTaipeiIndustrialPark, WukuDistrict, NewTaipeiCity, Taiwan24803/新北市五股區新北產業園區五工路 134 號

台灣檢驗科技股份有限公司

t (886-2) 2299-3279

f (886-2) 2298-0488

www.tw.sgs.com

Member of SGS Group



GSM\_850MHz\_LowCH128-824.2

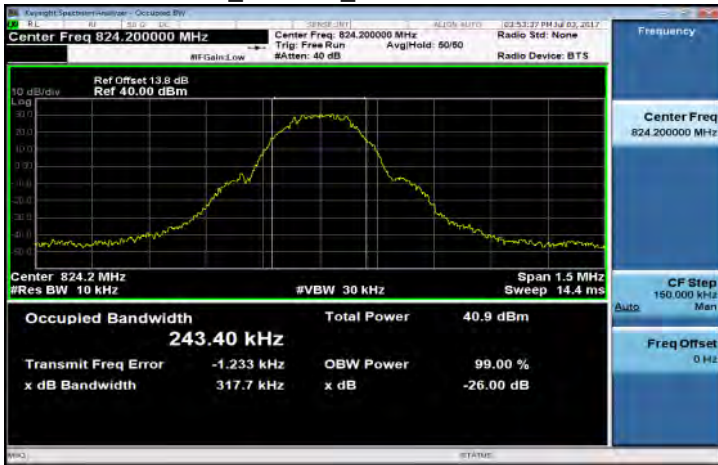

GPRS\_850MHz\_LowCH128-824.2

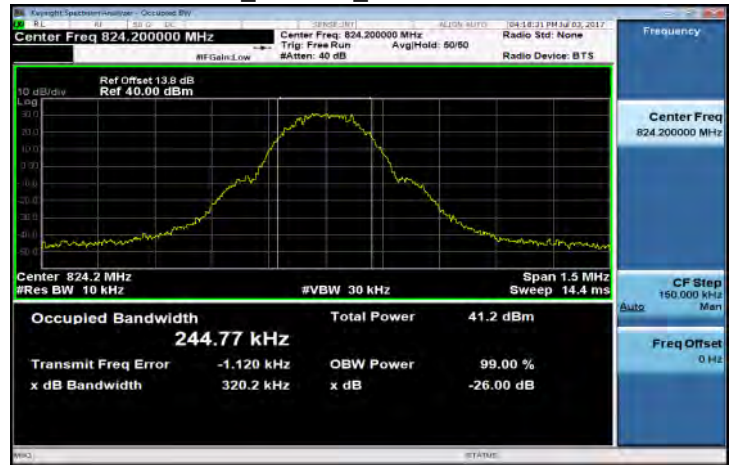

GSM\_850MHz\_MidCH190-836.6

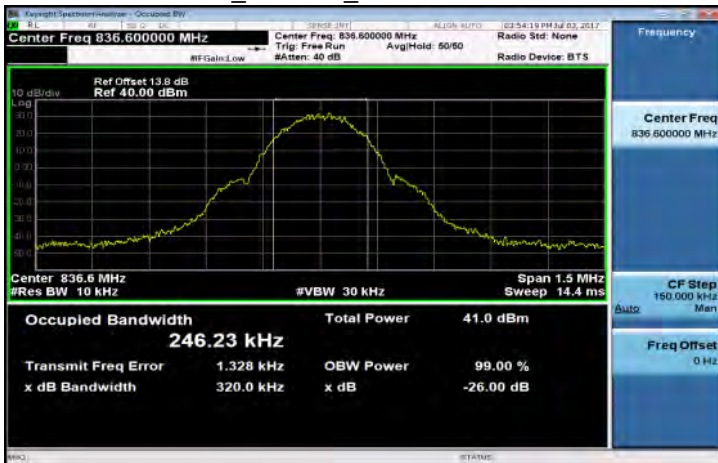

GPRS\_850MHz\_MidCH190-836.6

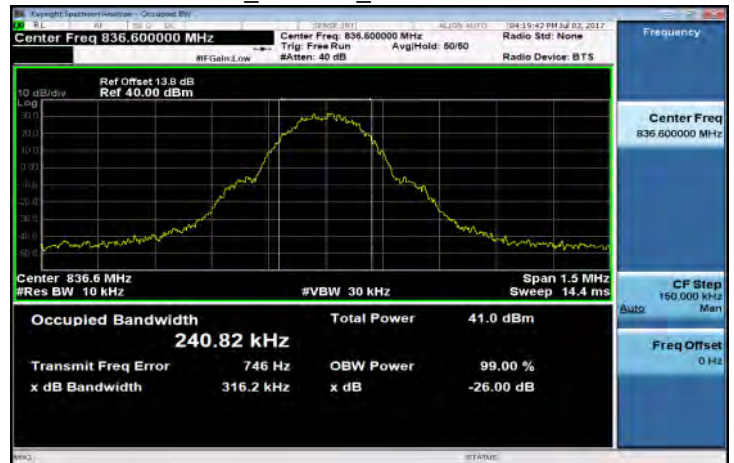

GSM\_850MHz\_HighCH251-848.8

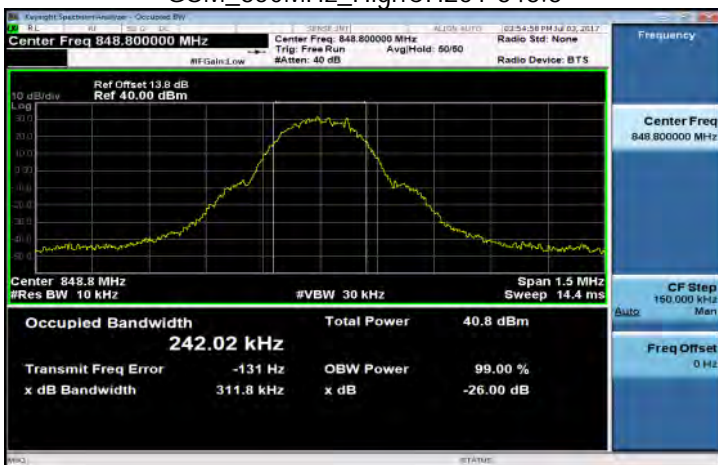

GPRS\_850MHz\_HighCH251-848.8

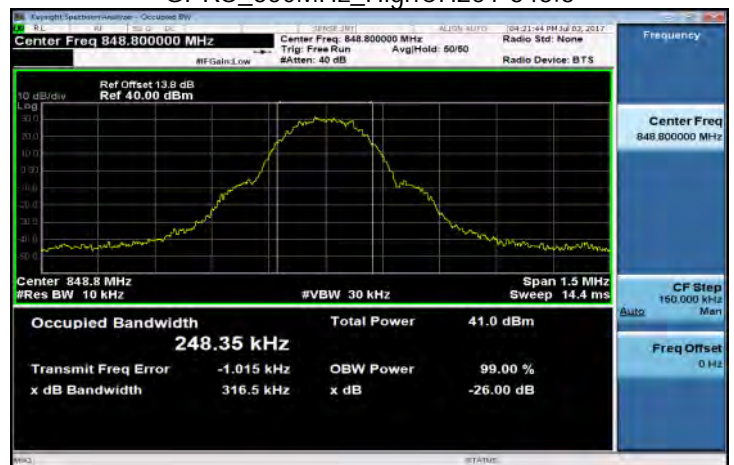

Unless otherwise stated the results shown in this test report refer only to the sample(s) tested and such sample(s) are retained for 90 days only.

除非另有說明，此報告結果僅對測試之樣品負責，同時此樣品僅保留90天。本報告未經本公司書面許可，不可部份複製。

This document is issued by the Company subject to its General Conditions of Service printed overleaf, available on request or accessible at [www.sgs.com/terms\\_and\\_conditions.htm](http://www.sgs.com/terms_and_conditions.htm) and, for electronic format documents, subject to Terms and Conditions for Electronic Documents at [www.sgs.com/terms\\_e-document.htm](http://www.sgs.com/terms_e-document.htm). Attention is drawn to the limitation of liability, indemnification and jurisdiction issues defined therein. Any holder of this document is advised that information contained hereon reflects the Company's findings at the time of its intervention only and within the limits of Client's instructions, if any. The Company's sole responsibility is to its Client and this document does not exonerate parties to a transaction from exercising all their rights and obligations under the transaction documents. This document cannot be reproduced except in full, without prior written approval of the Company. Any unauthorized alteration, forgery or falsification of the content or appearance of this document is unlawful and offenders may be prosecuted to the fullest extent of the law.

EDGE\_850MHz\_LowCH128-824.2

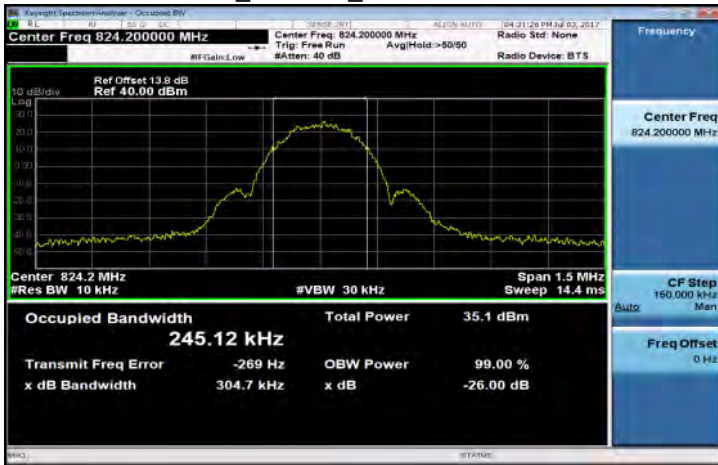

GSM\_1900MHz\_LowCH512-1850.2

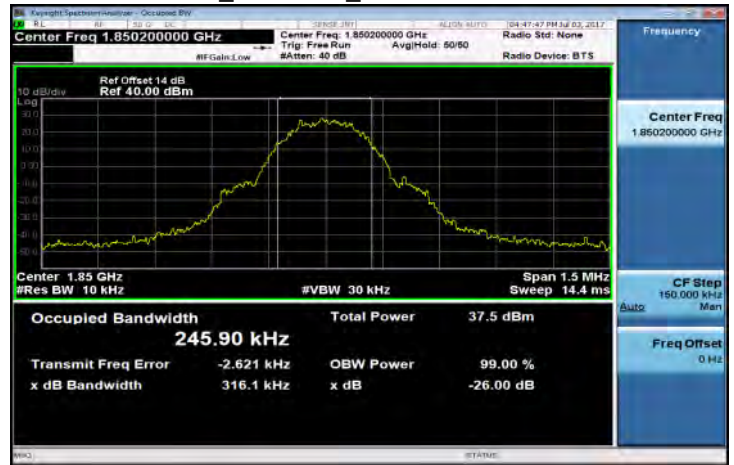

EDGE\_850MHz\_MidCH190-836.6

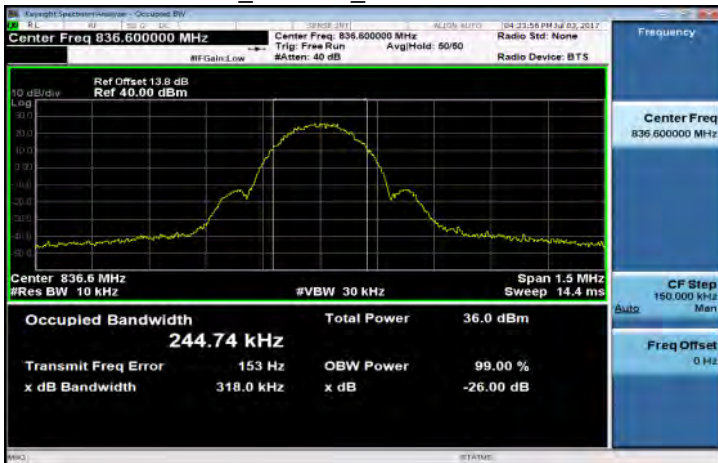

GSM\_1900MHz\_MidCH661-1880

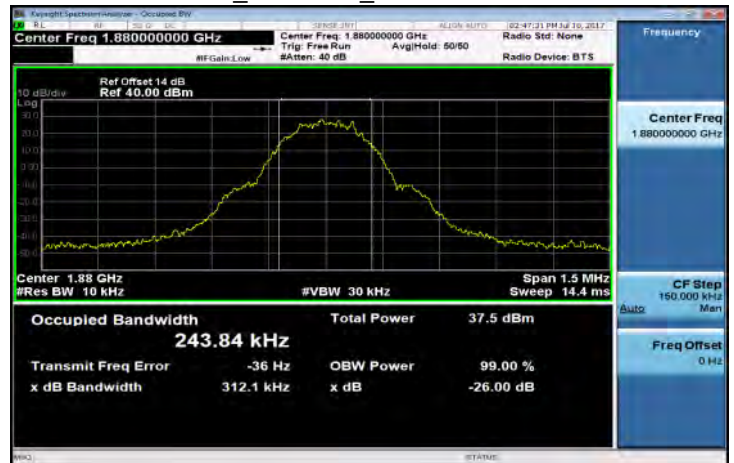

EDGE\_850MHz\_HighCH251-848.8

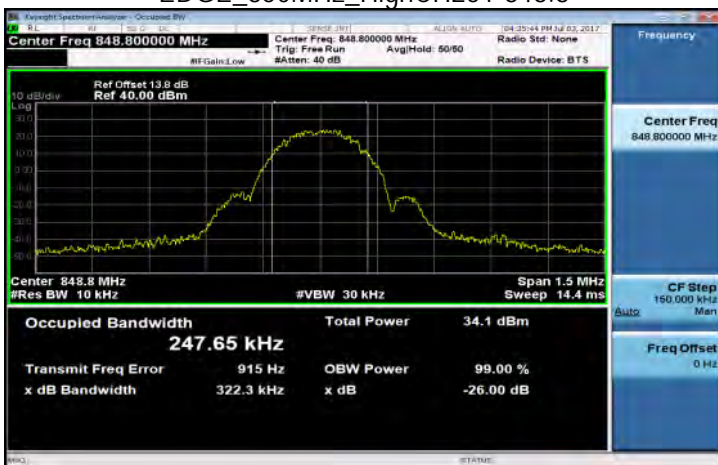

GSM\_1900MHz\_HighCH810-1909.8

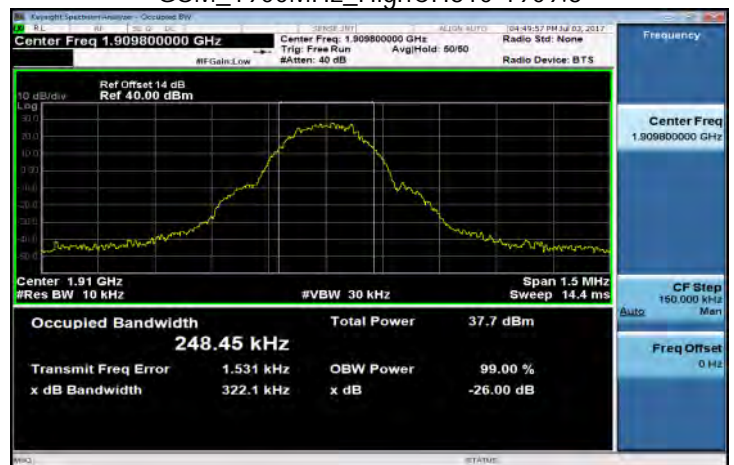

Unless otherwise stated the results shown in this test report refer only to the sample(s) tested and such sample(s) are retained for 90 days only.

除非另有說明，此報告結果僅對測試之樣品負責，同時此樣品僅保留90天。本報告未經本公司書面許可，不可部份複製。

This document is issued by the Company subject to its General Conditions of Service printed overleaf, available on request or accessible at [www.sgs.com/terms\\_and\\_conditions.htm](http://www.sgs.com/terms_and_conditions.htm) and, for electronic format documents, subject to Terms and Conditions for Electronic Documents at [www.sgs.com/terms\\_e-document.htm](http://www.sgs.com/terms_e-document.htm). Attention is drawn to the limitation of liability, indemnification and jurisdiction issues defined therein. Any holder of this document is advised that information contained hereon reflects the Company's findings at the time of its intervention only and within the limits of Client's instructions, if any. The Company's sole responsibility is to its Client and this document does not exonerate parties to a transaction from exercising all their rights and obligations under the transaction documents. This document cannot be reproduced except in full, without prior written approval of the Company. Any unauthorized alteration, forgery or falsification of the content or appearance of this document is unlawful and offenders may be prosecuted to the fullest extent of the law.



GPRS\_1900MHz\_LowCH512-1850.2

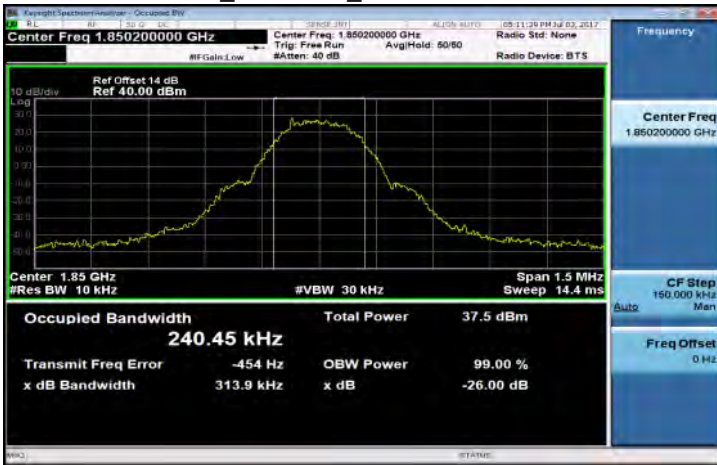

EDGE\_1900MHz\_LowCH512-1850.2

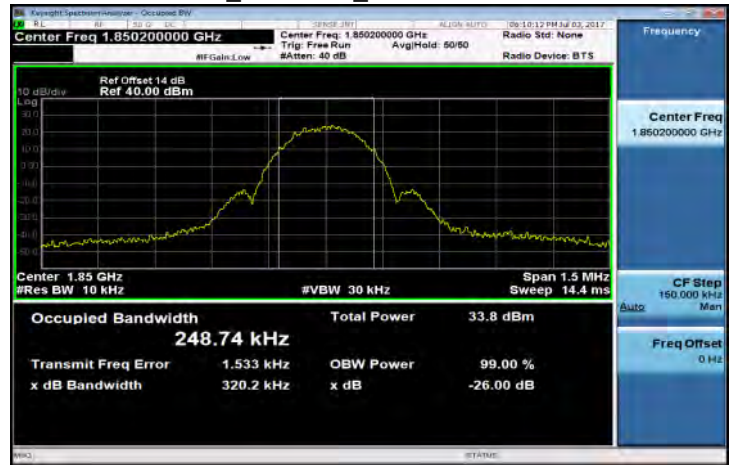

GPRS\_1900MHz\_MidCH661-1880

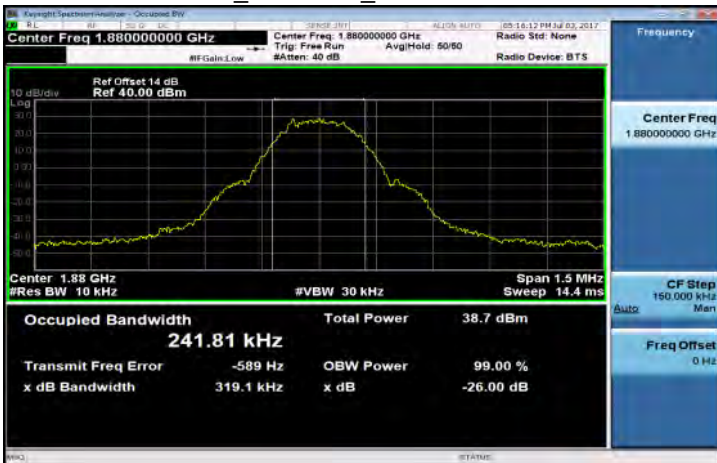

EDGE\_1900MHz\_MidCH661-1880

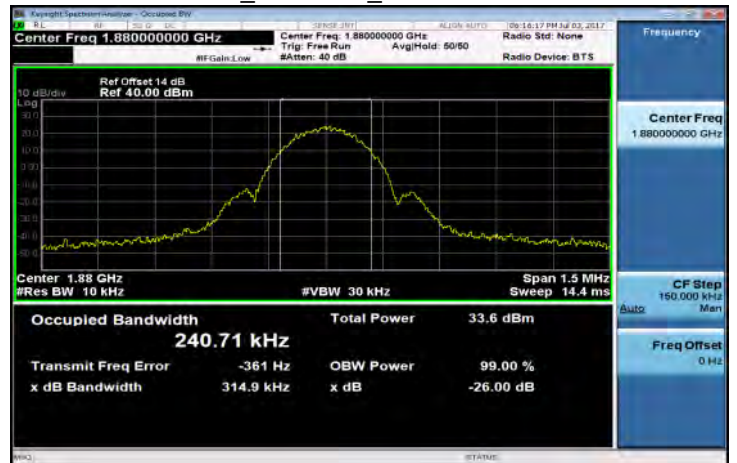

GPRS\_1900MHz\_HighCH810-1909.8

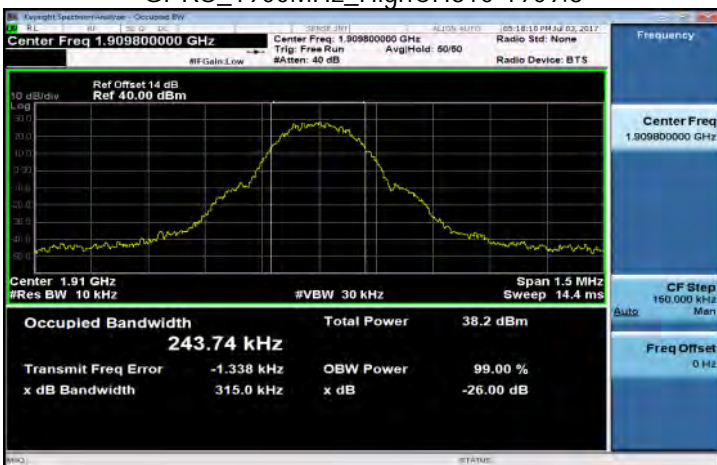

EDGE\_1900MHz\_HighCH810-1909.8

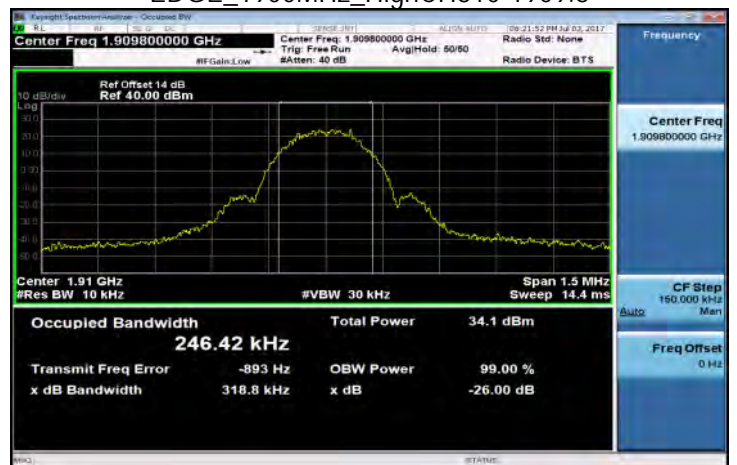

Unless otherwise stated the results shown in this test report refer only to the sample(s) tested and such sample(s) are retained for 90 days only.

除非另有說明，此報告結果僅對測試之樣品負責，同時此樣品僅保留90天。本報告未經本公司書面許可，不可部份複製。

This document is issued by the Company subject to its General Conditions of Service printed overleaf, available on request or accessible at [www.sgs.com/terms\\_and\\_conditions.htm](http://www.sgs.com/terms_and_conditions.htm) and, for electronic format documents, subject to Terms and Conditions for Electronic Documents at [www.sgs.com/terms\\_e-document.htm](http://www.sgs.com/terms_e-document.htm). Attention is drawn to the limitation of liability, indemnification and jurisdiction issues defined therein. Any holder of this document is advised that information contained hereon reflects the Company's findings at the time of its intervention only and within the limits of Client's instructions, if any. The Company's sole responsibility is to its Client and this document does not exonerate parties to a transaction from exercising all their rights and obligations under the transaction documents. This document cannot be reproduced except in full, without prior written approval of the Company. Any unauthorized alteration, forgery or falsification of the content or appearance of this document is unlawful and offenders may be prosecuted to the fullest extent of the law.



WCDMA\_B2\_LowCH9262-1852.4

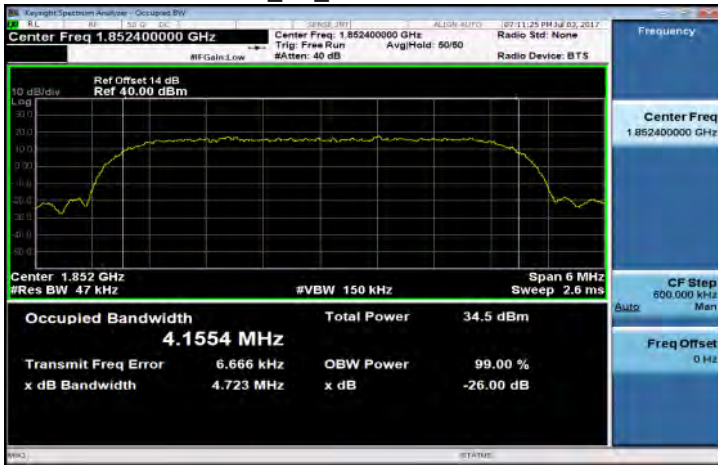

HSDPA\_B2\_LowCH9262-1852.4

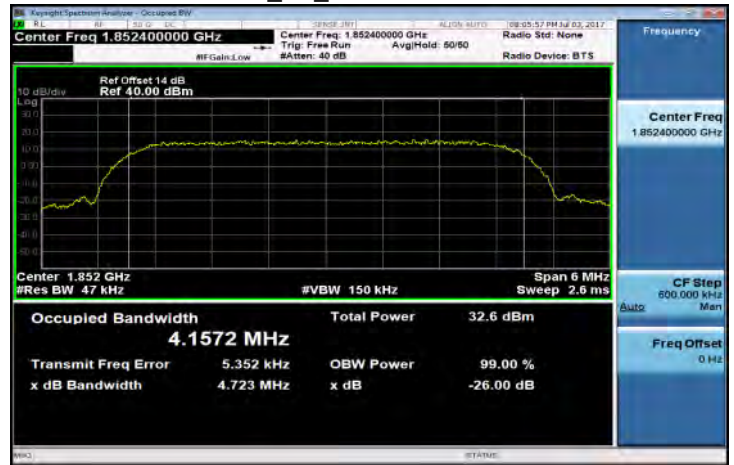

WCDMA\_B2\_MidCH9400-1880

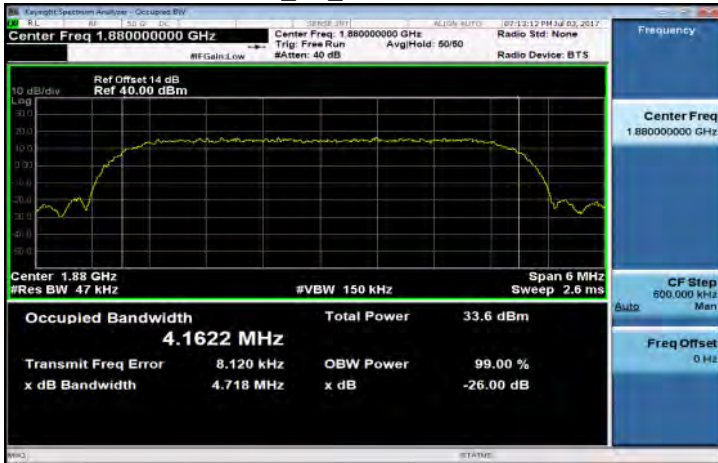

HSDPA\_B2\_MidCH9400-1880

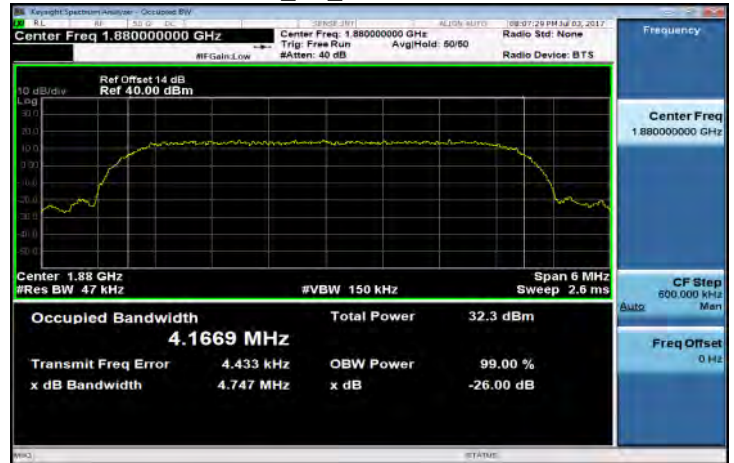

WCDMA\_B2\_HighCH9538-1907.6

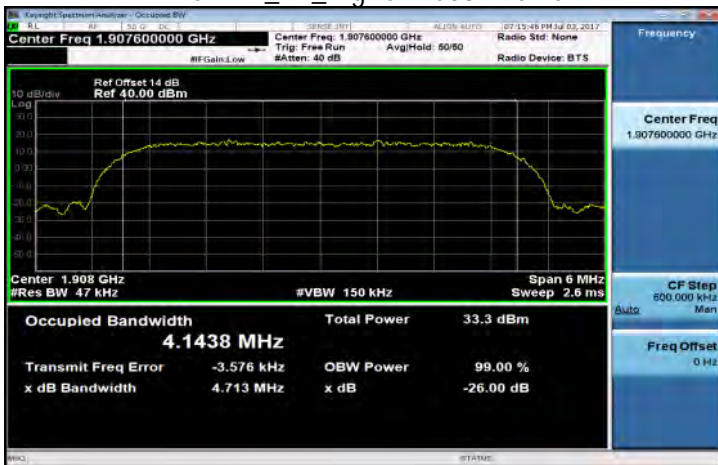

HSDPA\_B2\_HighCH9538-1907.6

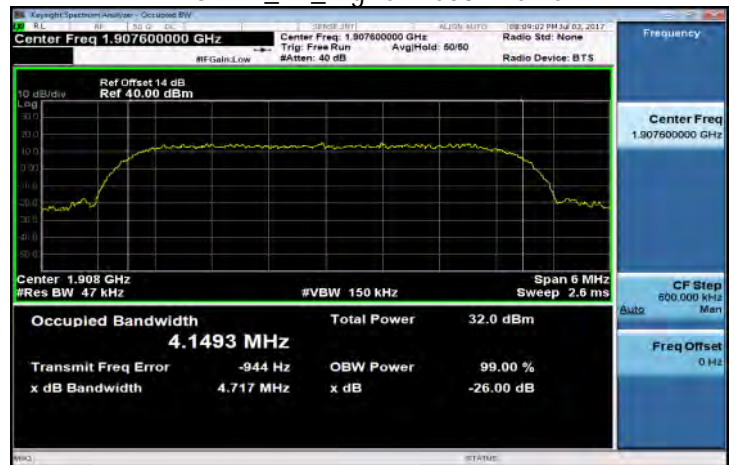

Unless otherwise stated the results shown in this test report refer only to the sample(s) tested and such sample(s) are retained for 90 days only.

除非另有說明，此報告結果僅對測試之樣品負責，同時此樣品僅保留90天。本報告未經本公司書面許可，不可部份複製。

This document is issued by the Company subject to its General Conditions of Service printed overleaf, available on request or accessible at [www.sgs.com/terms\\_and\\_conditions.htm](http://www.sgs.com/terms_and_conditions.htm) and, for electronic format documents, subject to Terms and Conditions for Electronic Documents at [www.sgs.com/terms\\_e-document.htm](http://www.sgs.com/terms_e-document.htm). Attention is drawn to the limitation of liability, indemnification and jurisdiction issues defined therein. Any holder of this document is advised that information contained hereon reflects the Company's findings at the time of its intervention only and within the limits of Client's instructions, if any. The Company's sole responsibility is to its Client and this document does not exonerate parties to a transaction from exercising all their rights and obligations under the transaction documents. This document cannot be reproduced except in full, without prior written approval of the Company. Any unauthorized alteration, forgery or falsification of the content or appearance of this document is unlawful and offenders may be prosecuted to the fullest extent of the law.

HSUPA\_B2\_LowCH9262-1852.4

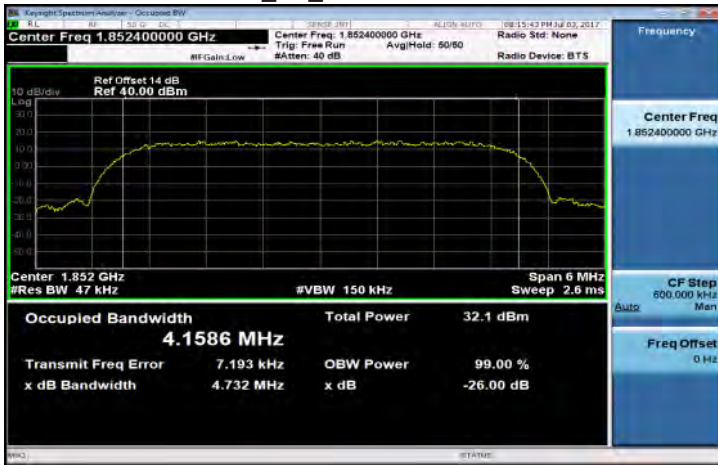

WCDMA\_B4\_LowCH1312-1712.4

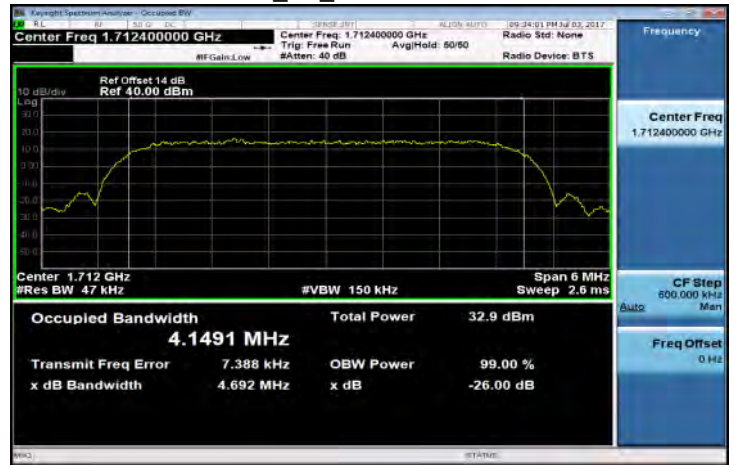

HSUPA\_B2\_MidCH9400-1880

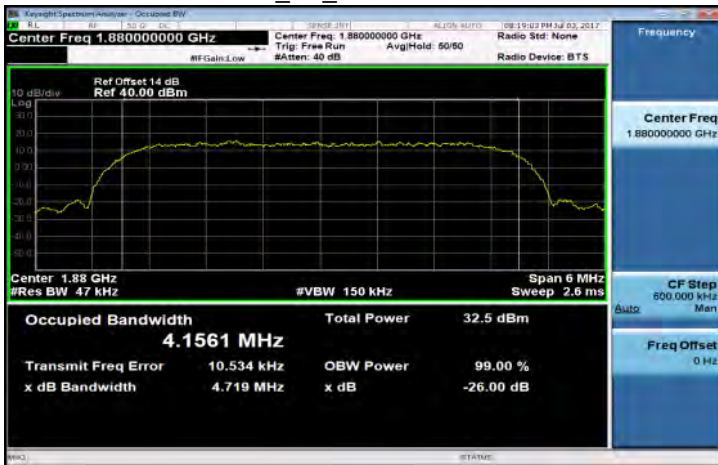

WCDMA\_B4\_MidCH1413-1732.6

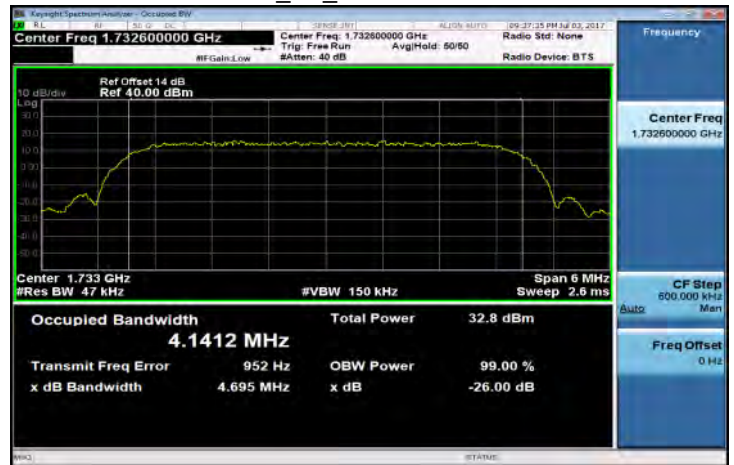

HSUPA\_B2\_HighCH9538-1907.6

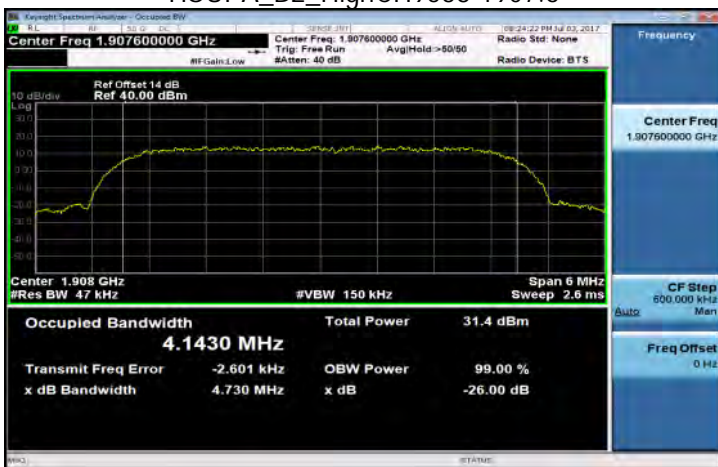

WCDMA\_B4\_HighCH1513-1752.6

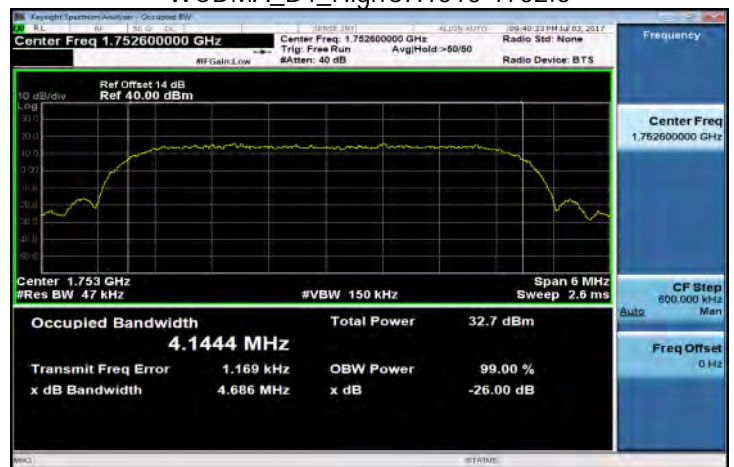

Unless otherwise stated the results shown in this test report refer only to the sample(s) tested and such sample(s) are retained for 90 days only.

除非另有說明，此報告結果僅對測試之樣品負責，同時此樣品僅保留90天。本報告未經本公司書面許可，不可部份複製。

This document is issued by the Company subject to its General Conditions of Service printed overleaf, available on request or accessible at [www.sgs.com/terms\\_and\\_conditions.htm](http://www.sgs.com/terms_and_conditions.htm) and, for electronic format documents, subject to Terms and Conditions for Electronic Documents at [www.sgs.com/terms\\_e-document.htm](http://www.sgs.com/terms_e-document.htm). Attention is drawn to the limitation of liability, indemnification and jurisdiction issues defined therein. Any holder of this document is advised that information contained hereon reflects the Company's findings at the time of its intervention only and within the limits of Client's instructions, if any. The Company's sole responsibility is to its Client and this document does not exonerate parties to a transaction from exercising all their rights and obligations under the transaction documents. This document cannot be reproduced except in full, without prior written approval of the Company. Any unauthorized alteration, forgery or falsification of the content or appearance of this document is unlawful and offenders may be prosecuted to the fullest extent of the law.



HSDPA\_B4\_LowCH1312-1712.4

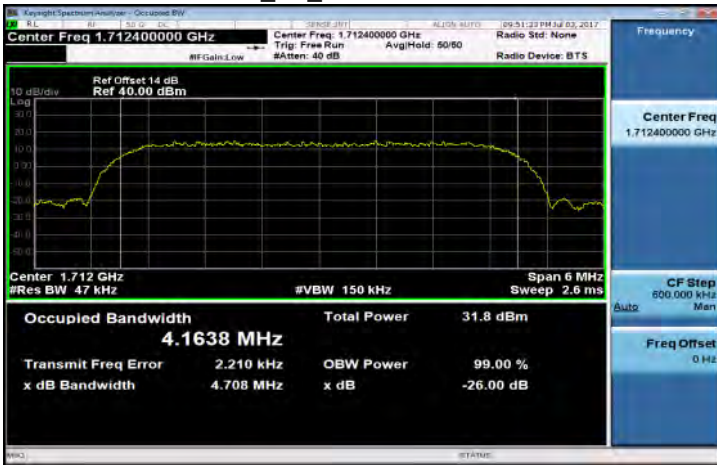

HSUPA\_B4\_LowCH1312-1712.4

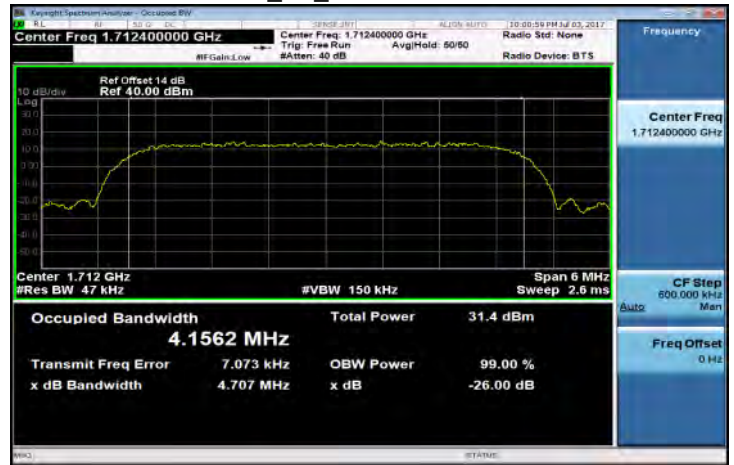

HSDPA\_B4\_MidCH1413-1732.6

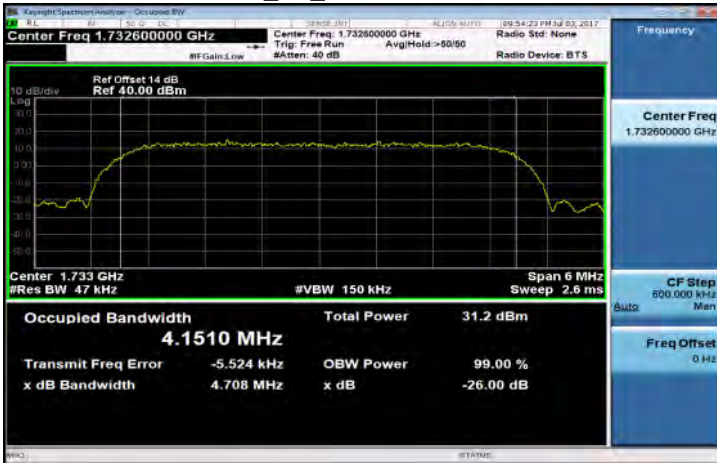

HSUPA\_B4\_MidCH1413-1732.6

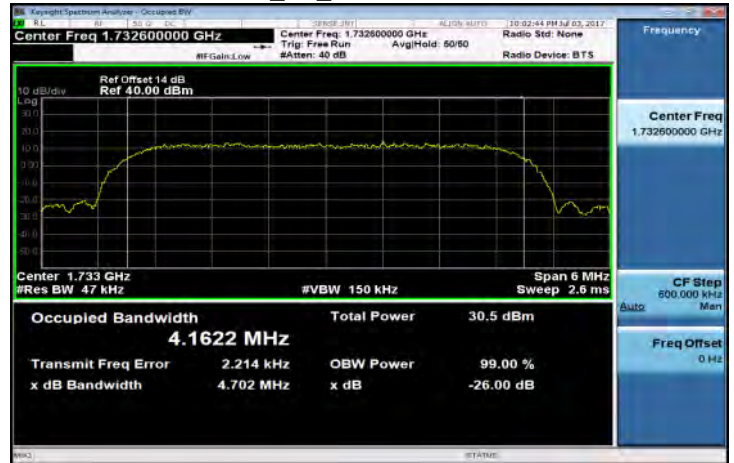

HSDPA\_B4\_HighCH1513-1752.6

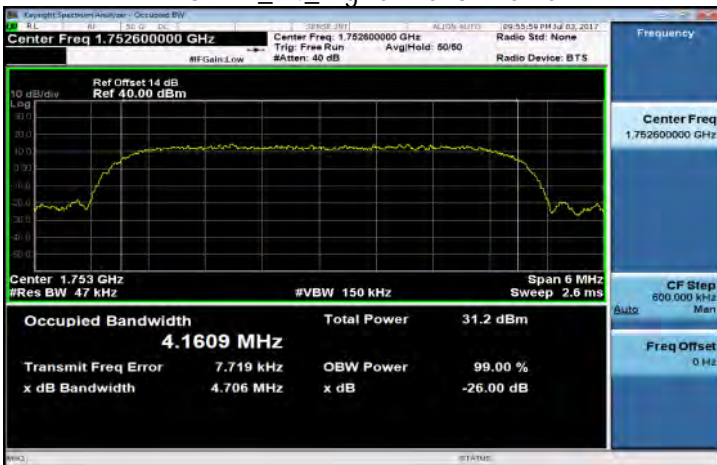

HSUPA\_B4\_HighCH1513-1752.6

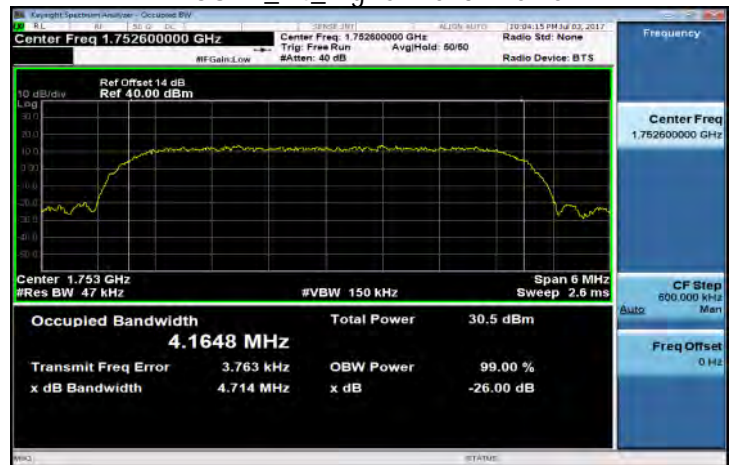

Unless otherwise stated the results shown in this test report refer only to the sample(s) tested and such sample(s) are retained for 90 days only.

除非另有說明，此報告結果僅對測試之樣品負責，同時此樣品僅保留90天。本報告未經本公司書面許可，不可部份複製。

This document is issued by the Company subject to its General Conditions of Service printed overleaf, available on request or accessible at [www.sgs.com/terms\\_and\\_conditions.htm](http://www.sgs.com/terms_and_conditions.htm) and, for electronic format documents, subject to Terms and Conditions for Electronic Documents at [www.sgs.com/terms\\_e-document.htm](http://www.sgs.com/terms_e-document.htm). Attention is drawn to the limitation of liability, indemnification and jurisdiction issues defined therein. Any holder of this document is advised that information contained hereon reflects the Company's findings at the time of its intervention only and within the limits of Client's instructions, if any. The Company's sole responsibility is to its Client and this document does not exonerate parties to a transaction from exercising all their rights and obligations under the transaction documents. This document cannot be reproduced except in full, without prior written approval of the Company. Any unauthorized alteration, forgery or falsification of the content or appearance of this document is unlawful and offenders may be prosecuted to the fullest extent of the law.

WCDMA\_B5\_LowCH4132-826.4

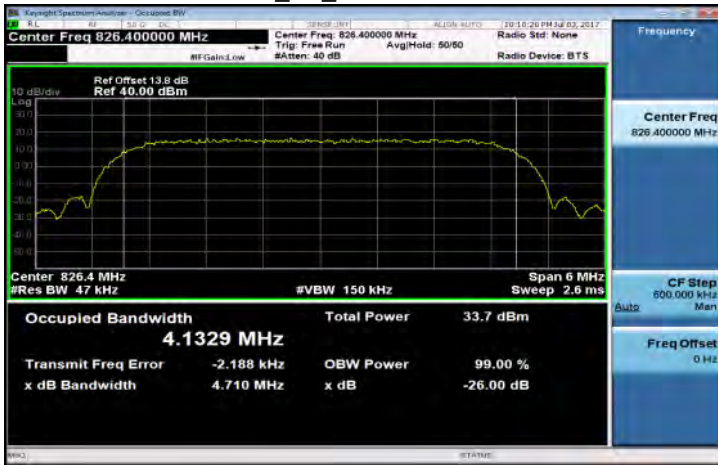

HSDPA\_B5\_LowCH4132-826.4

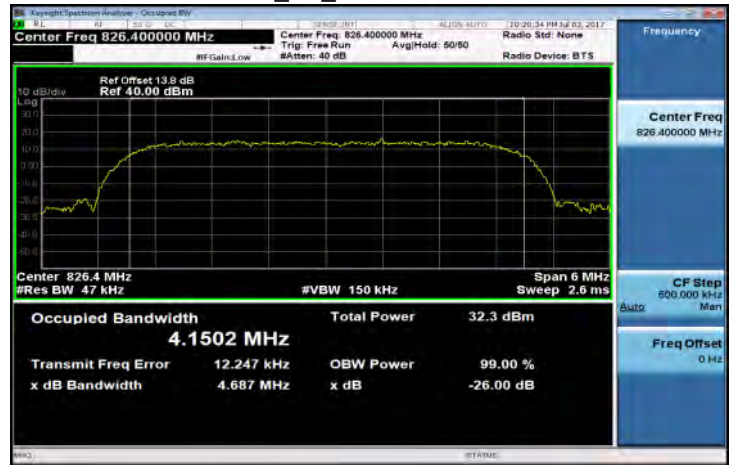

WCDMA\_B5\_MidCH4183-836.6

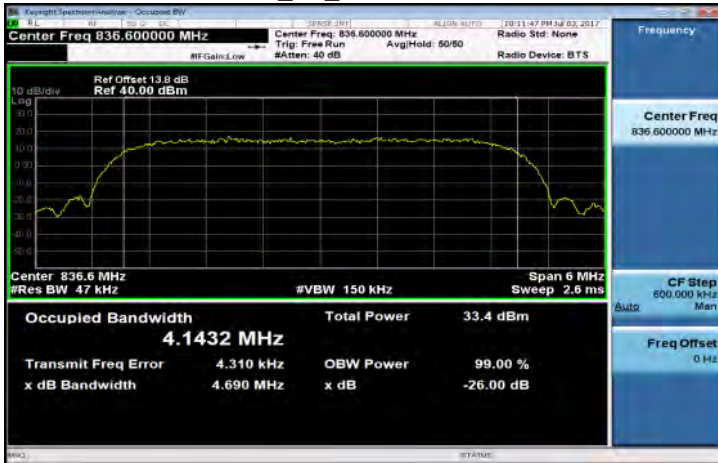

HSDPA\_B5\_MidCH4183-836.6

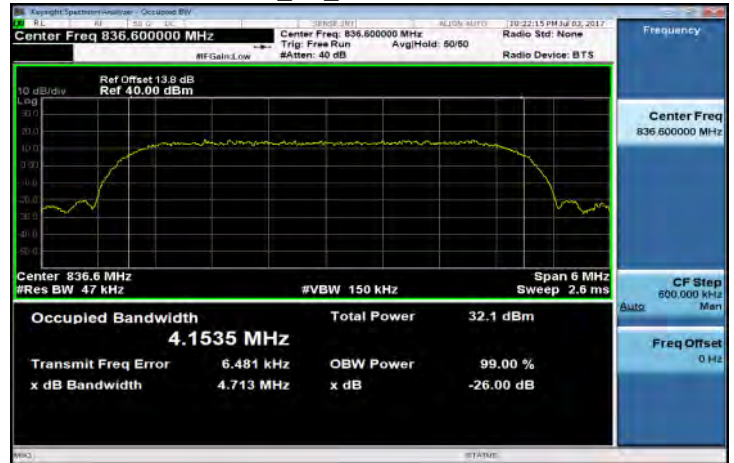

WCDMA\_B5\_HighCH4233-846.6

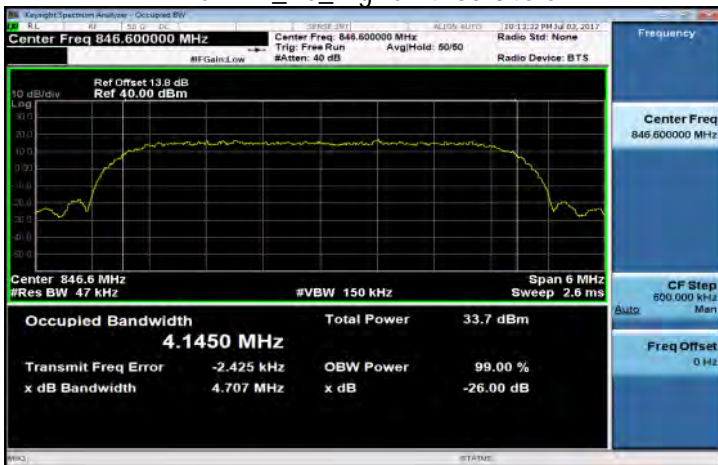

HSDPA\_B5\_HighCH4233-846.6

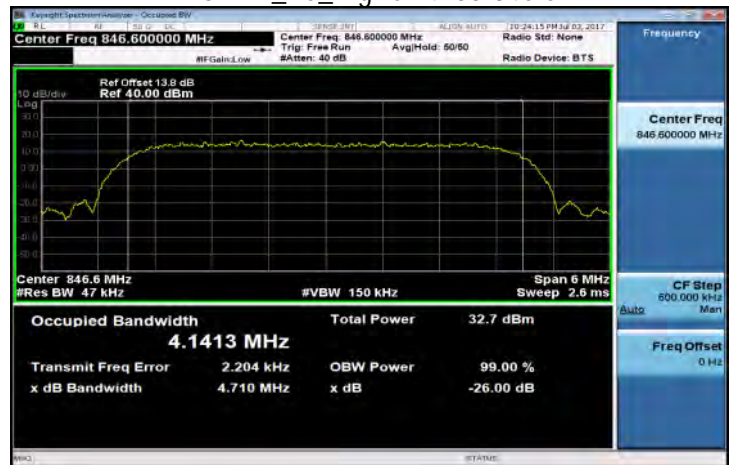

Unless otherwise stated the results shown in this test report refer only to the sample(s) tested and such sample(s) are retained for 90 days only.

除非另有說明，此報告結果僅對測試之樣品負責，同時此樣品僅保留90天。本報告未經本公司書面許可，不可部份複製。

This document is issued by the Company subject to its General Conditions of Service printed overleaf, available on request or accessible at [www.sgs.com/terms\\_and\\_conditions.htm](http://www.sgs.com/terms_and_conditions.htm) and, for electronic format documents, subject to Terms and Conditions for Electronic Documents at [www.sgs.com/terms\\_e-document.htm](http://www.sgs.com/terms_e-document.htm). Attention is drawn to the limitation of liability, indemnification and jurisdiction issues defined therein. Any holder of this document is advised that information contained hereon reflects the Company's findings at the time of its intervention only and within the limits of Client's instructions, if any. The Company's sole responsibility is to its Client and this document does not exonerate parties to a transaction from exercising all their rights and obligations under the transaction documents. This document cannot be reproduced except in full, without prior written approval of the Company. Any unauthorized alteration, forgery or falsification of the content or appearance of this document is unlawful and offenders may be prosecuted to the fullest extent of the law.



HSUPA\_B5\_LowCH4132-826.4

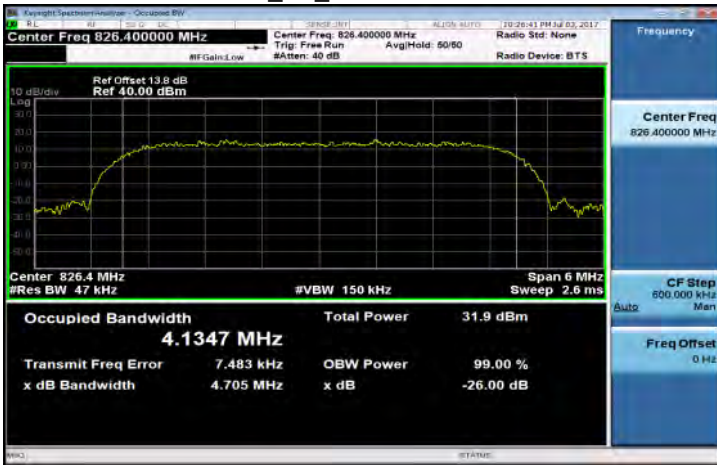

Band2\_1\_4MHz\_QPSK\_6\_0\_LowCH18607-1850.7

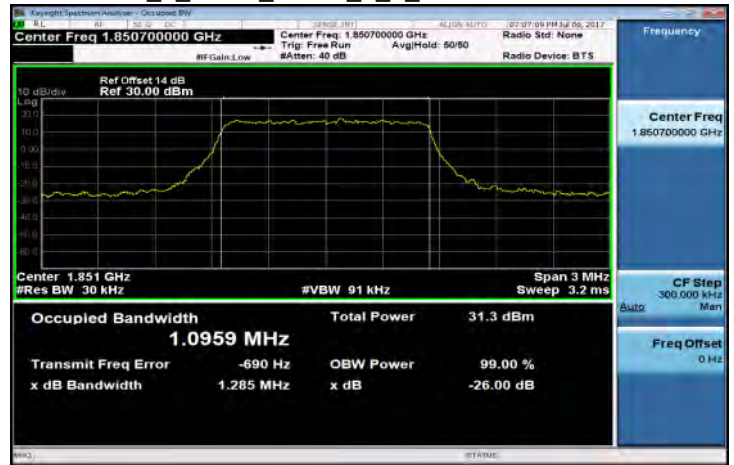

HSUPA\_B5\_MidCH4183-836.6

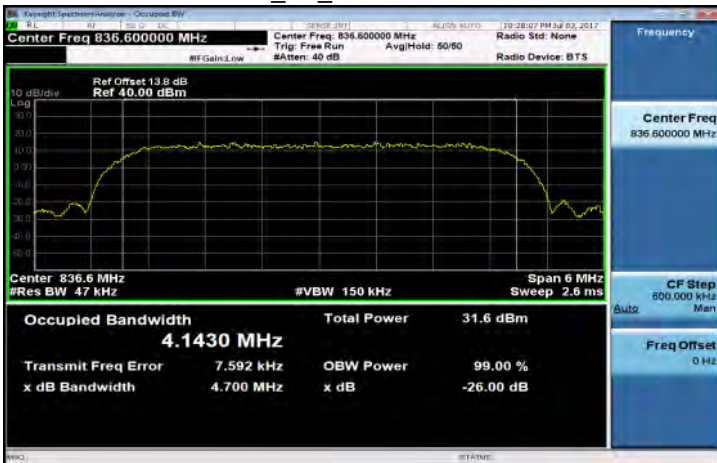

Band2\_1\_4MHz\_QPSK\_6\_0\_MidCH18900-1880

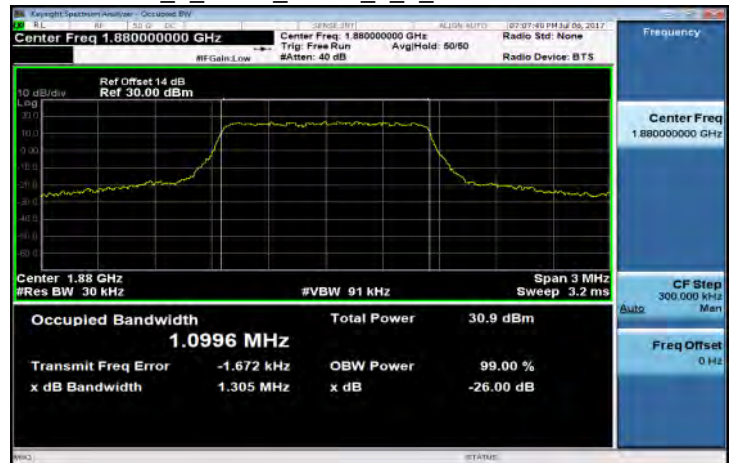

HSUPA\_B5\_HighCH4233-846.6

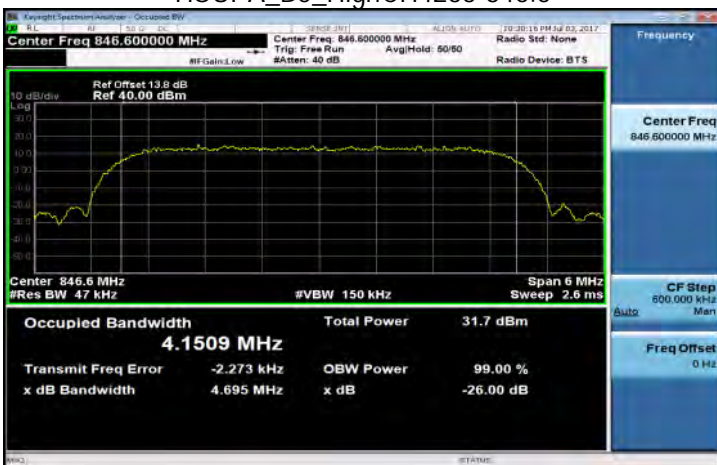

Band2\_1\_4MHz\_QPSK\_6\_0\_HighCH19193-1909.3

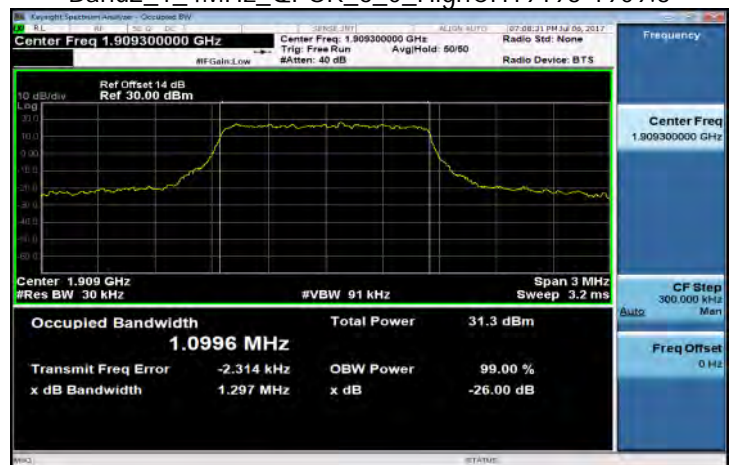

Unless otherwise stated the results shown in this test report refer only to the sample(s) tested and such sample(s) are retained for 90 days only.

除非另有說明，此報告結果僅對測試之樣品負責，同時此樣品僅保留90天。本報告未經本公司書面許可，不可部份複製。

This document is issued by the Company subject to its General Conditions of Service printed overleaf, available on request or accessible at [www.sgs.com/terms\\_and\\_conditions.htm](http://www.sgs.com/terms_and_conditions.htm) and, for electronic format documents, subject to Terms and Conditions for Electronic Documents at [www.sgs.com/terms\\_e-document.htm](http://www.sgs.com/terms_e-document.htm). Attention is drawn to the limitation of liability, indemnification and jurisdiction issues defined therein. Any holder of this document is advised that information contained hereon reflects the Company's findings at the time of its intervention only and within the limits of Client's instructions, if any. The Company's sole responsibility is to its Client and this document does not exonerate parties to a transaction from exercising all their rights and obligations under the transaction documents. This document cannot be reproduced except in full, without prior written approval of the Company. Any unauthorized alteration, forgery or falsification of the content or appearance of this document is unlawful and offenders may be prosecuted to the fullest extent of the law.

Band2\_1\_4MHz\_16QAM\_6\_0\_LowCH18607-1850.7

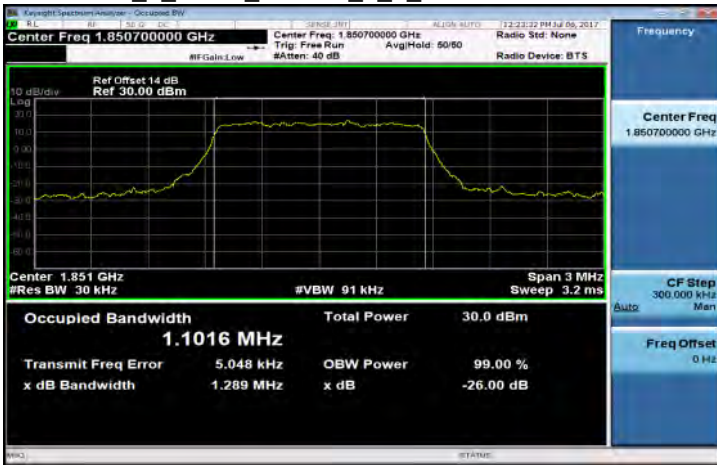

Band2\_3MHz\_QPSK\_15\_0\_LowCH18615-1851.5

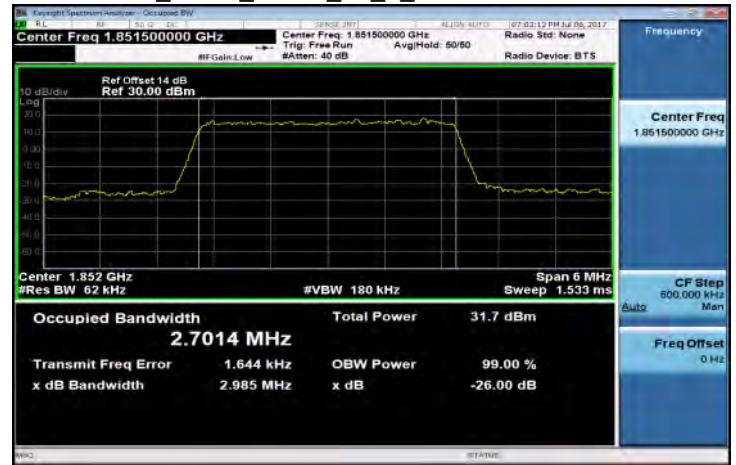

Band2\_1\_4MHz\_16QAM\_6\_0\_MidCH18900-1880

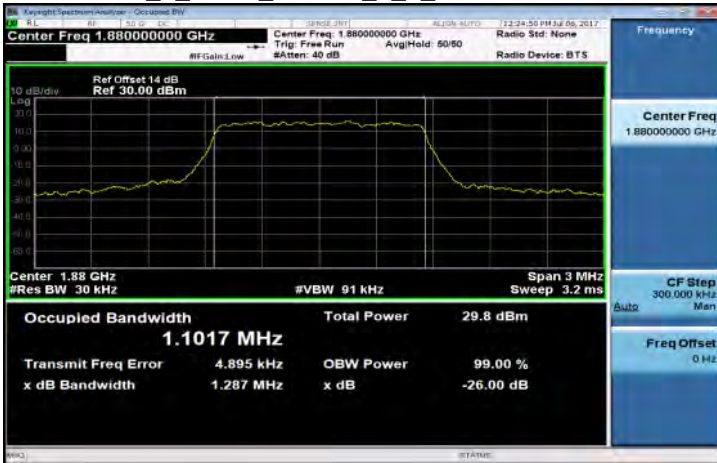

Band2\_3MHz\_QPSK\_15\_0\_MidCH18900-1880

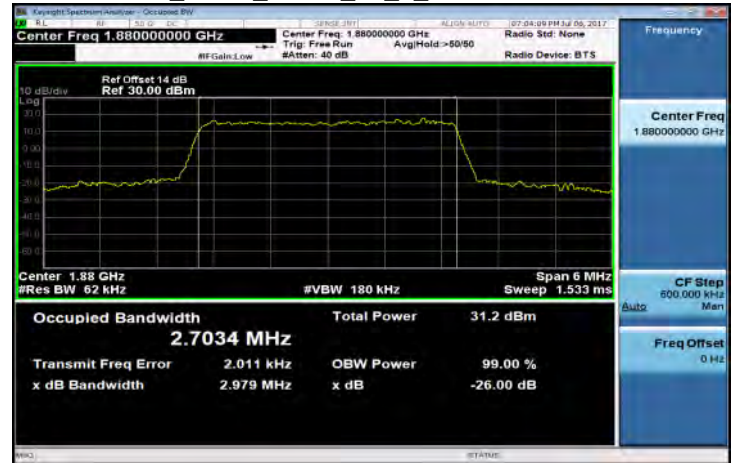

Band2\_1\_4MHz\_16QAM\_6\_0\_HighCH19193-1909.3

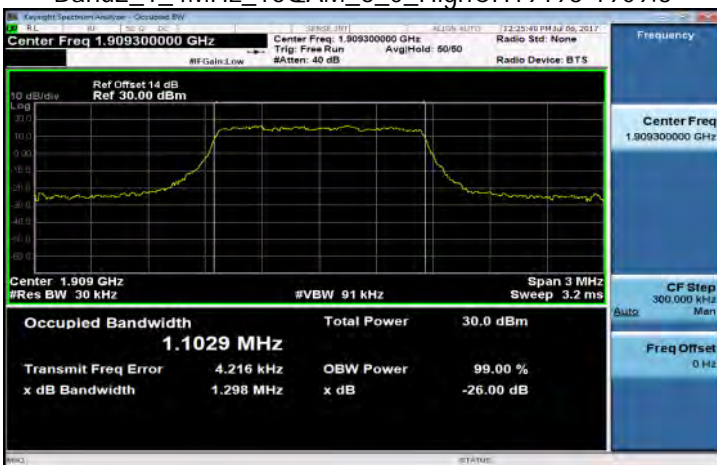

Band2\_3MHz\_QPSK\_15\_0\_HighCH19185-1908.5

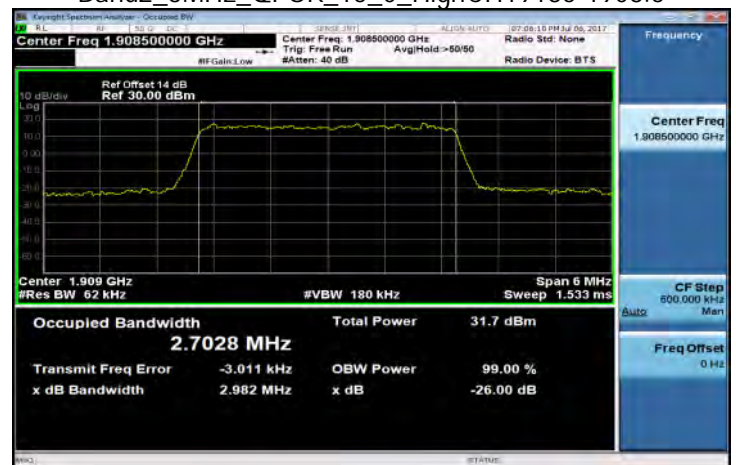

Unless otherwise stated the results shown in this test report refer only to the sample(s) tested and such sample(s) are retained for 90 days only.

除非另有說明，此報告結果僅對測試之樣品負責，同時此樣品僅保留90天。本報告未經本公司書面許可，不可部份複製。

This document is issued by the Company subject to its General Conditions of Service printed overleaf, available on request or accessible at [www.sgs.com/terms\\_and\\_conditions.htm](http://www.sgs.com/terms_and_conditions.htm) and, for electronic format documents, subject to Terms and Conditions for Electronic Documents at [www.sgs.com/terms\\_e-document.htm](http://www.sgs.com/terms_e-document.htm). Attention is drawn to the limitation of liability, indemnification and jurisdiction issues defined therein. Any holder of this document is advised that information contained hereon reflects the Company's findings at the time of its intervention only and within the limits of Client's instructions, if any. The Company's sole responsibility is to its Client and this document does not exonerate parties to a transaction from exercising all their rights and obligations under the transaction documents. This document cannot be reproduced except in full, without prior written approval of the Company. Any unauthorized alteration, forgery or falsification of the content or appearance of this document is unlawful and offenders may be prosecuted to the fullest extent of the law.



Band2\_3MHz\_16QAM\_15\_0\_LowCH18615-1851.5

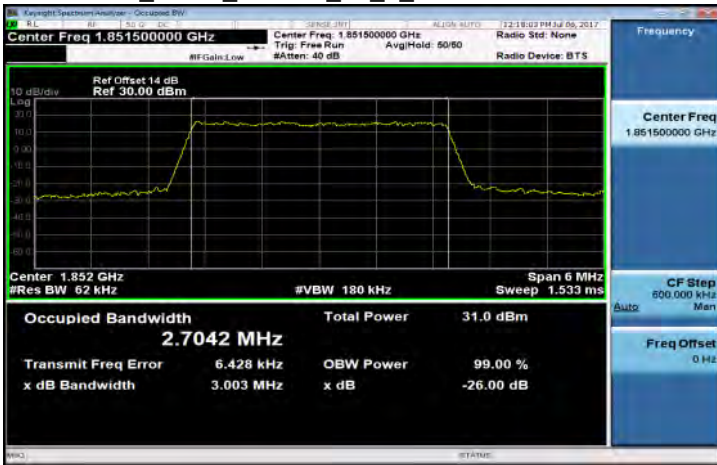

Band2\_5MHz\_QPSK\_25\_0\_LowCH18625-1852.5

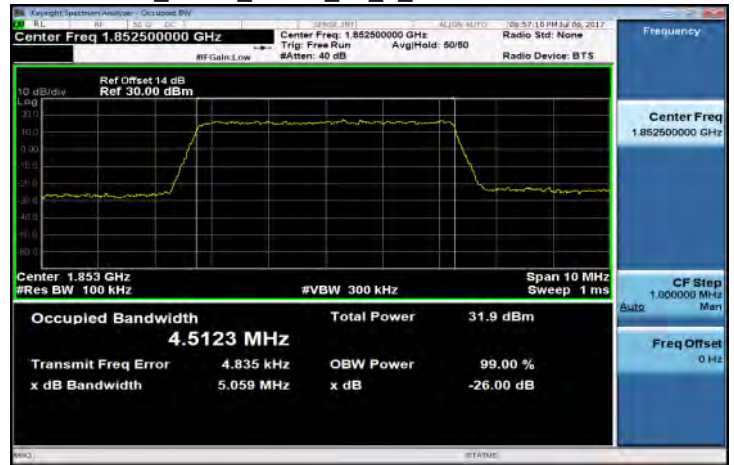

Band2\_3MHz\_16QAM\_15\_0\_MidCH18900-1880

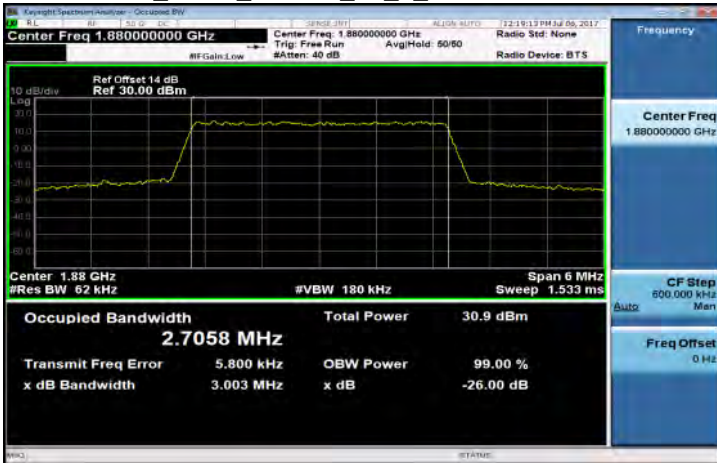

Band2\_5MHz\_QPSK\_25\_0\_MidCH18900-1880

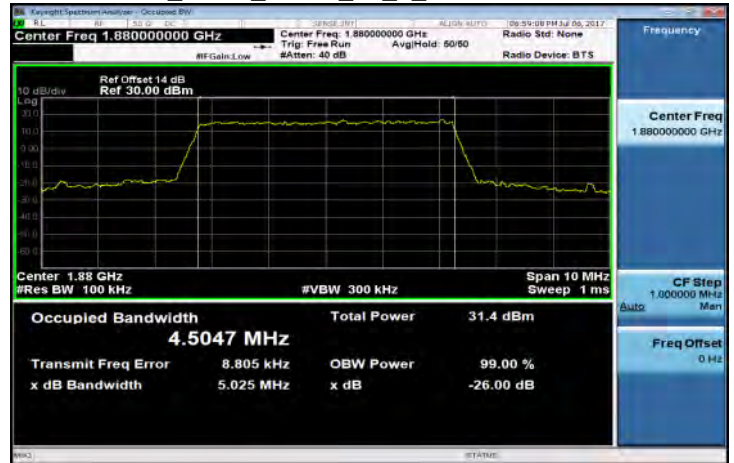

Band2\_3MHz\_16QAM\_15\_0\_HighCH19185-1908.5

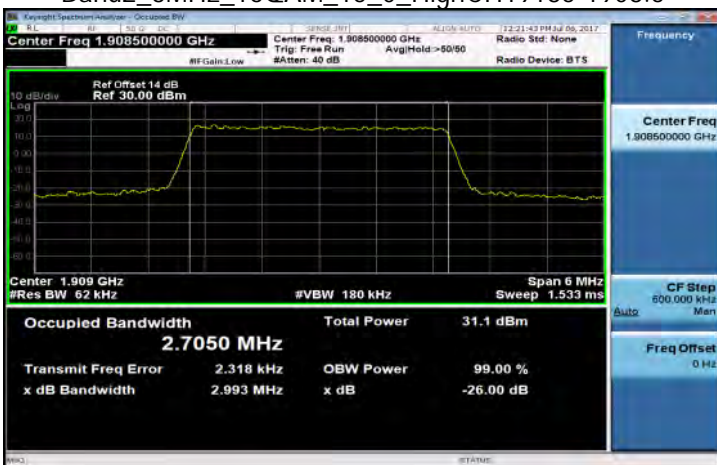

Band2\_5MHz\_QPSK\_25\_0\_HighCH19175-1907.5

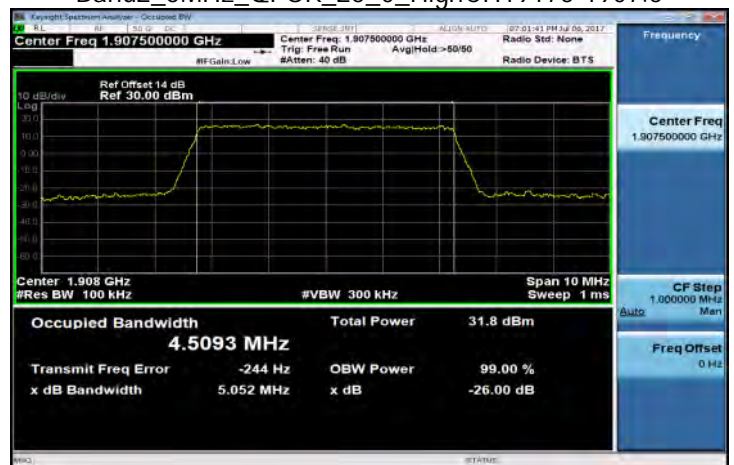

Unless otherwise stated the results shown in this test report refer only to the sample(s) tested and such sample(s) are retained for 90 days only.

除非另有說明，此報告結果僅對測試之樣品負責，同時此樣品僅保留90天。本報告未經本公司書面許可，不可部份複製。

This document is issued by the Company subject to its General Conditions of Service printed overleaf, available on request or accessible at [www.sgs.com/terms\\_and\\_conditions.htm](http://www.sgs.com/terms_and_conditions.htm) and, for electronic format documents, subject to Terms and Conditions for Electronic Documents at [www.sgs.com/terms\\_e-document.htm](http://www.sgs.com/terms_e-document.htm). Attention is drawn to the limitation of liability, indemnification and jurisdiction issues defined therein. Any holder of this document is advised that information contained hereon reflects the Company's findings at the time of its intervention only and within the limits of Client's instructions, if any. The Company's sole responsibility is to its Client and this document does not exonerate parties to a transaction from exercising all their rights and obligations under the transaction documents. This document cannot be reproduced except in full, without prior written approval of the Company. Any unauthorized alteration, forgery or falsification of the content or appearance of this document is unlawful and offenders may be prosecuted to the fullest extent of the law.



Band2\_5MHz\_16QAM\_25\_0\_LowCH18625-1852.5

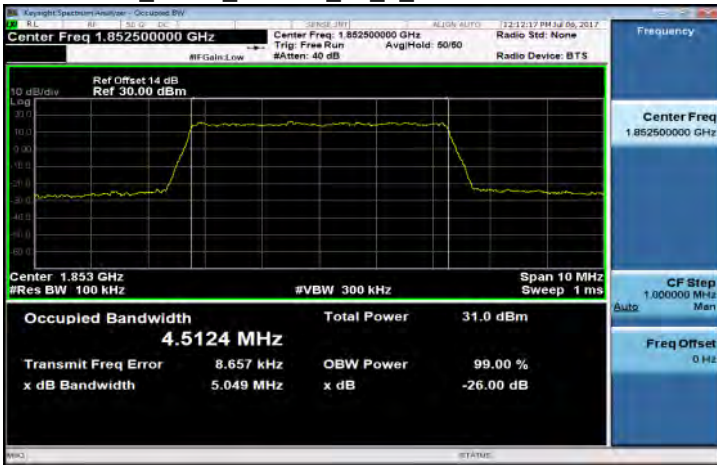

Band2\_10MHz\_QPSK\_50\_0\_LowCH18650-1855

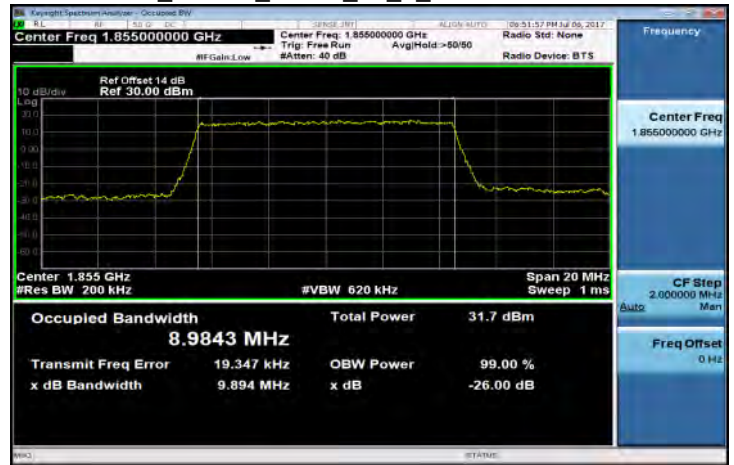

Band2\_5MHz\_16QAM\_25\_0\_MidCH18900-1880

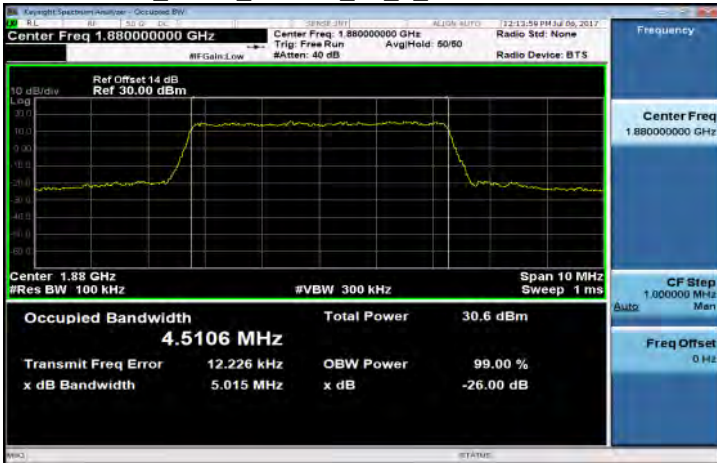

Band2\_10MHz\_QPSK\_50\_0\_MidCH18900-1880

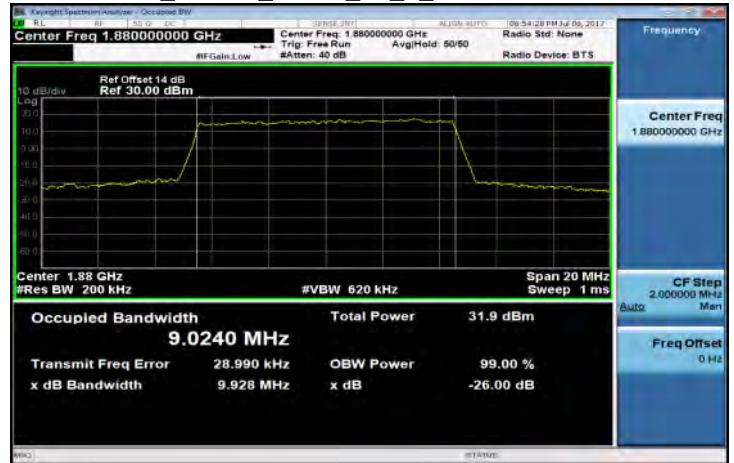

Band2\_5MHz\_16QAM\_25\_0\_HighCH19175-1907.5

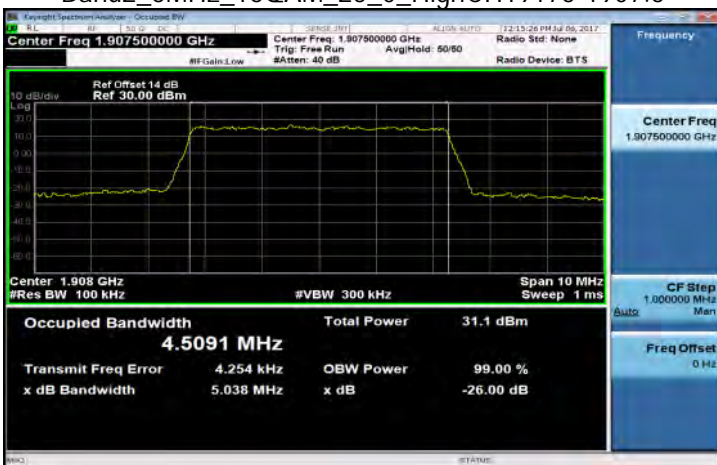

Band2\_10MHz\_QPSK\_50\_0\_HighCH19150-1905

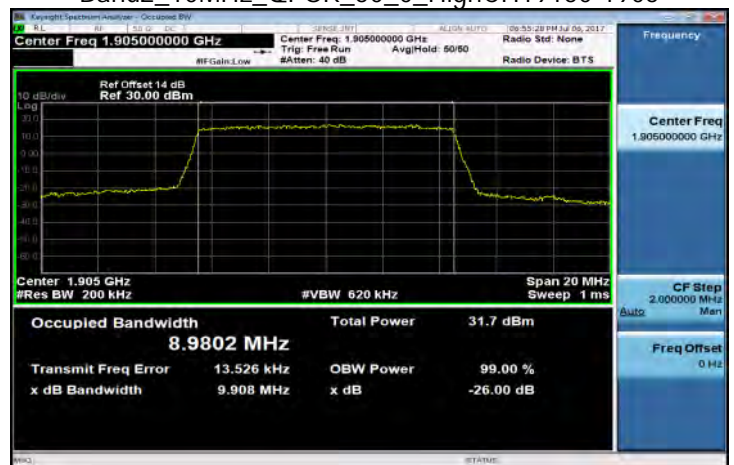

Unless otherwise stated the results shown in this test report refer only to the sample(s) tested and such sample(s) are retained for 90 days only.

除非另有說明，此報告結果僅對測試之樣品負責，同時此樣品僅保留90天。本報告未經本公司書面許可，不可部份複製。

This document is issued by the Company subject to its General Conditions of Service printed overleaf, available on request or accessible at [www.sgs.com/terms\\_and\\_conditions.htm](http://www.sgs.com/terms_and_conditions.htm) and, for electronic format documents, subject to Terms and Conditions for Electronic Documents at [www.sgs.com/terms\\_e-document.htm](http://www.sgs.com/terms_e-document.htm). Attention is drawn to the limitation of liability, indemnification and jurisdiction issues defined therein. Any holder of this document is advised that information contained hereon reflects the Company's findings at the time of its intervention only and within the limits of Client's instructions, if any. The Company's sole responsibility is to its Client and this document does not exonerate parties to a transaction from exercising all their rights and obligations under the transaction documents. This document cannot be reproduced except in full, without prior written approval of the Company. Any unauthorized alteration, forgery or falsification of the content or appearance of this document is unlawful and offenders may be prosecuted to the fullest extent of the law.

Band2\_10MHz\_16QAM\_50\_0\_LowCH18650-1855

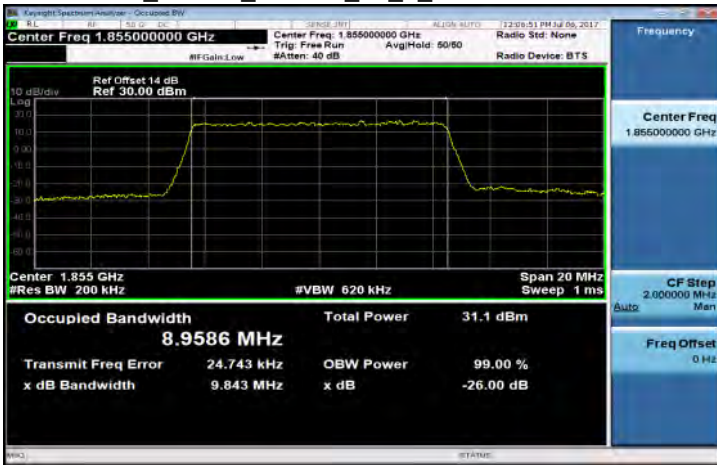

Band2\_15MHz\_QPSK\_75\_0\_LowCH18675-1857.5

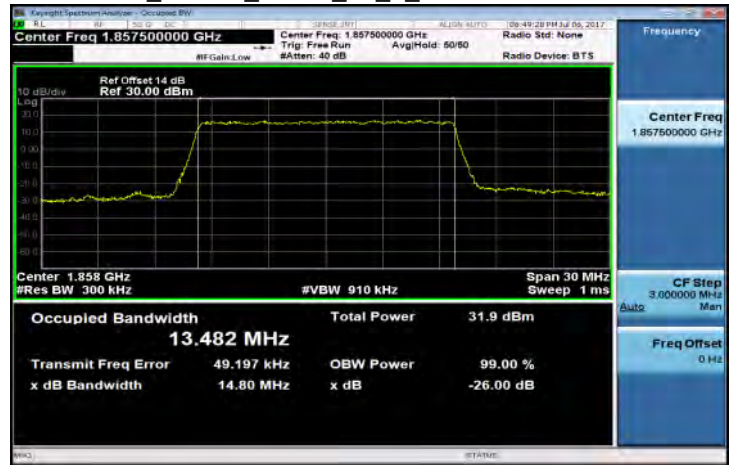

Band2\_10MHz\_16QAM\_50\_0\_MidCH18900-1880

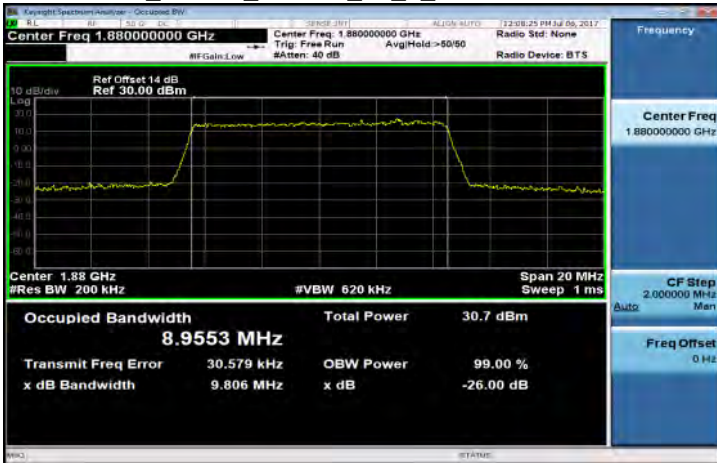

Band2\_15MHz\_QPSK\_75\_0\_MidCH18900-1880

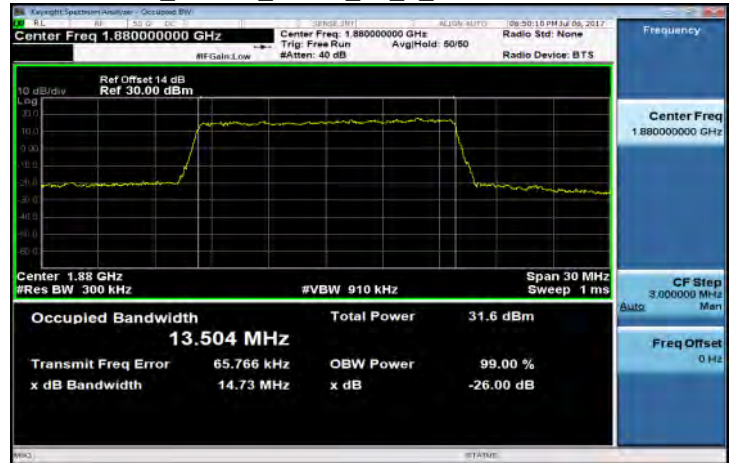

Band2\_10MHz\_16QAM\_50\_0\_HighCH19150-1905

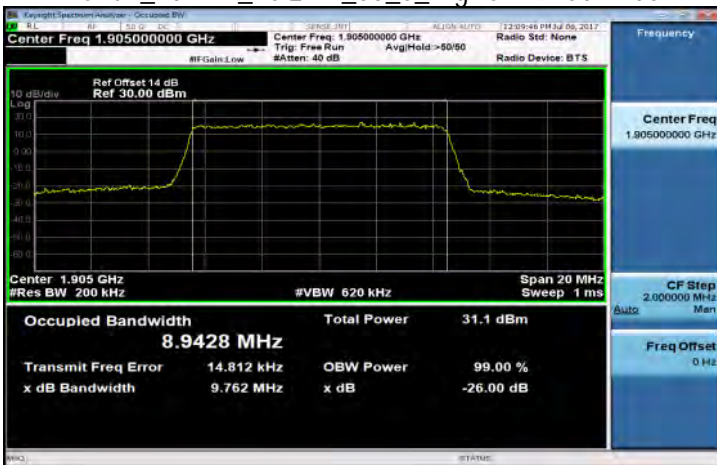

Band2\_15MHz\_QPSK\_75\_0\_HighCH19125-1902.5

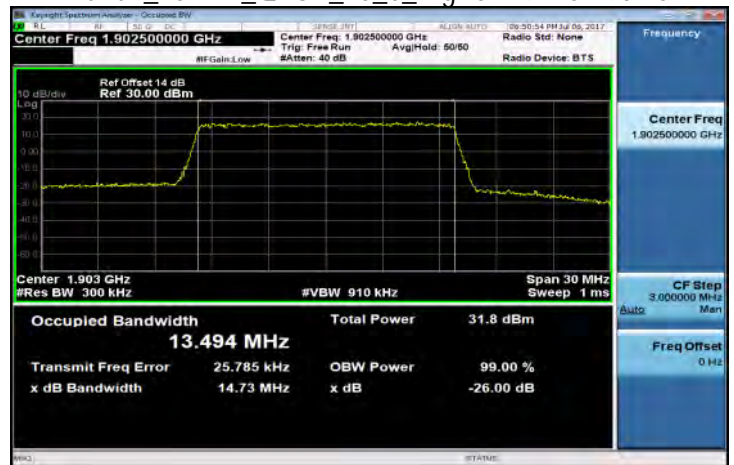

Unless otherwise stated the results shown in this test report refer only to the sample(s) tested and such sample(s) are retained for 90 days only.

除非另有說明，此報告結果僅對測試之樣品負責，同時此樣品僅保留90天。本報告未經本公司書面許可，不可部份複製。

This document is issued by the Company subject to its General Conditions of Service printed overleaf, available on request or accessible at [www.sgs.com/terms\\_and\\_conditions.htm](http://www.sgs.com/terms_and_conditions.htm) and, for electronic format documents, subject to Terms and Conditions for Electronic Documents at [www.sgs.com/terms\\_e-document.htm](http://www.sgs.com/terms_e-document.htm). Attention is drawn to the limitation of liability, indemnification and jurisdiction issues defined therein. Any holder of this document is advised that information contained hereon reflects the Company's findings at the time of its intervention only and within the limits of Client's instructions, if any. The Company's sole responsibility is to its Client and this document does not exonerate parties to a transaction from exercising all their rights and obligations under the transaction documents. This document cannot be reproduced except in full, without prior written approval of the Company. Any unauthorized alteration, forgery or falsification of the content or appearance of this document is unlawful and offenders may be prosecuted to the fullest extent of the law.



Band2\_15MHz\_16QAM\_75\_0\_LowCH18675-1857.5

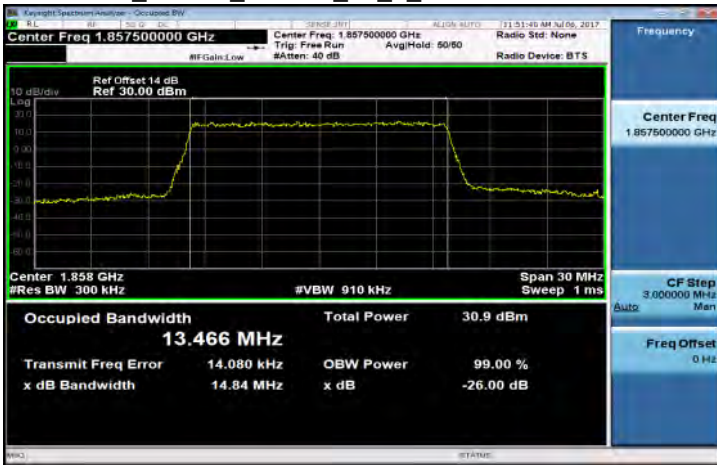

Band2\_20MHz\_QPSK\_100\_0\_LowCH18700-1860

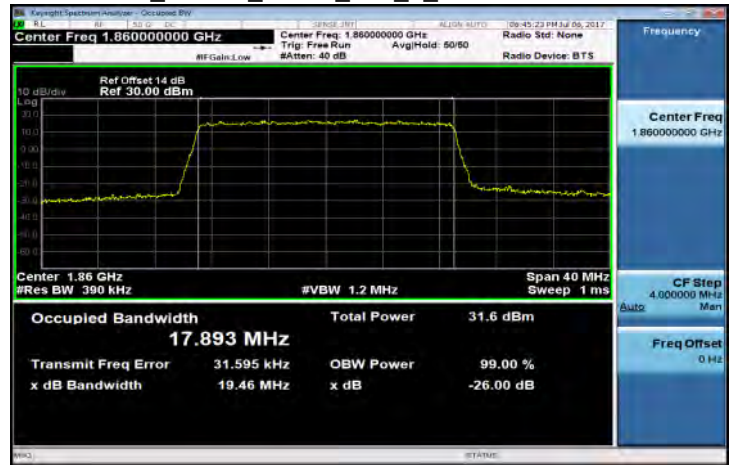

Band2\_15MHz\_16QAM\_75\_0\_MidCH18900-1880

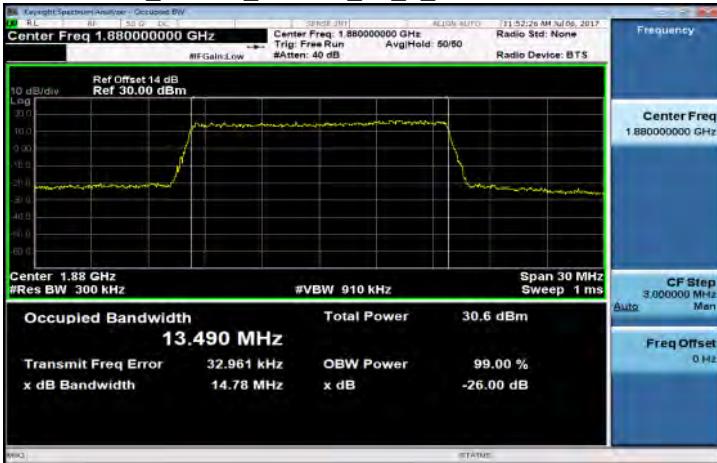

Band2\_20MHz\_QPSK\_100\_0\_MidCH18900-1880

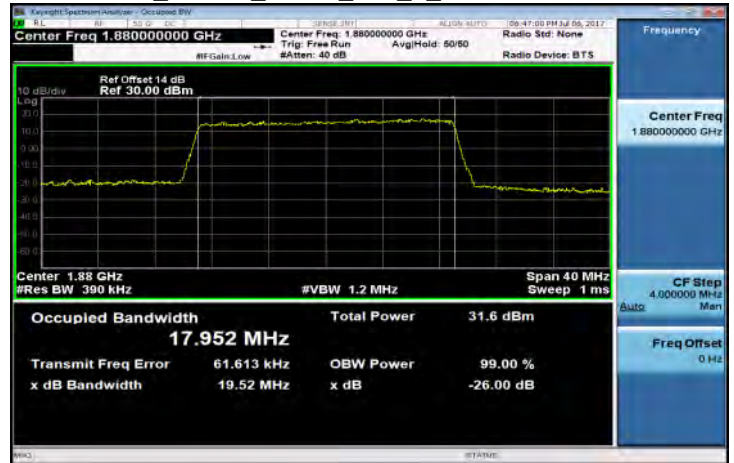

Band2\_15MHz\_16QAM\_75\_0\_HighCH19125-1902.5

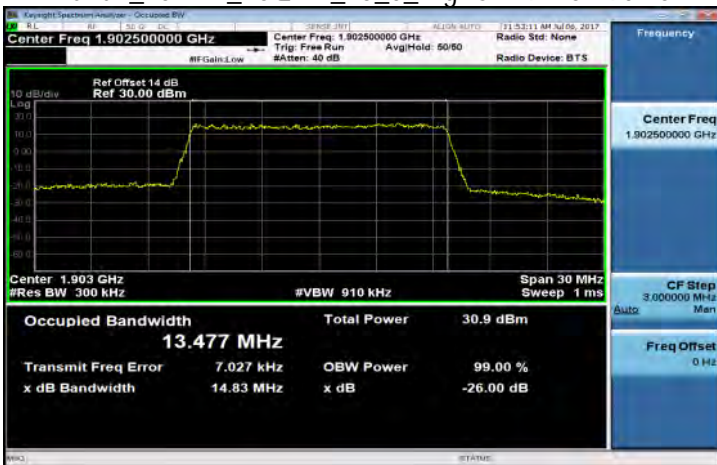

Band2\_20MHz\_QPSK\_100\_0\_HighCH19100-1900

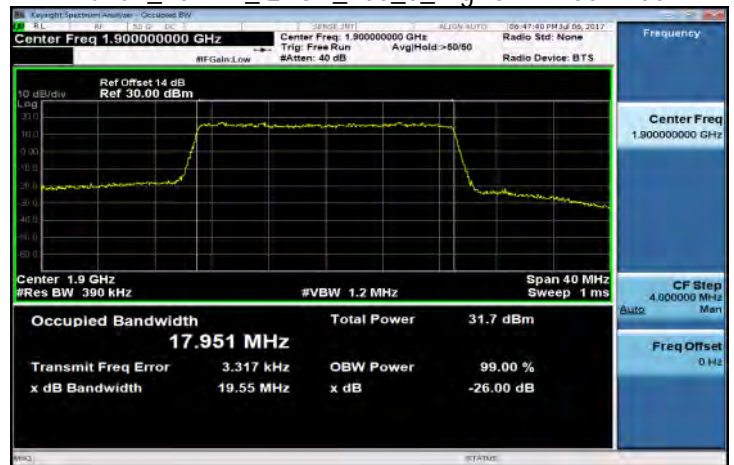

Unless otherwise stated the results shown in this test report refer only to the sample(s) tested and such sample(s) are retained for 90 days only.

除非另有說明，此報告結果僅對測試之樣品負責，同時此樣品僅保留90天。本報告未經本公司書面許可，不可部份複製。

This document is issued by the Company subject to its General Conditions of Service printed overleaf, available on request or accessible at [www.sgs.com/terms\\_and\\_conditions.htm](http://www.sgs.com/terms_and_conditions.htm) and, for electronic format documents, subject to Terms and Conditions for Electronic Documents at [www.sgs.com/terms\\_e-document.htm](http://www.sgs.com/terms_e-document.htm). Attention is drawn to the limitation of liability, indemnification and jurisdiction issues defined therein. Any holder of this document is advised that information contained hereon reflects the Company's findings at the time of its intervention only and within the limits of Client's instructions, if any. The Company's sole responsibility is to its Client and this document does not exonerate parties to a transaction from exercising all their rights and obligations under the transaction documents. This document cannot be reproduced except in full, without prior written approval of the Company. Any unauthorized alteration, forgery or falsification of the content or appearance of this document is unlawful and offenders may be prosecuted to the fullest extent of the law.

Band2\_20MHz\_16QAM\_100\_0\_LowCH18700-1860

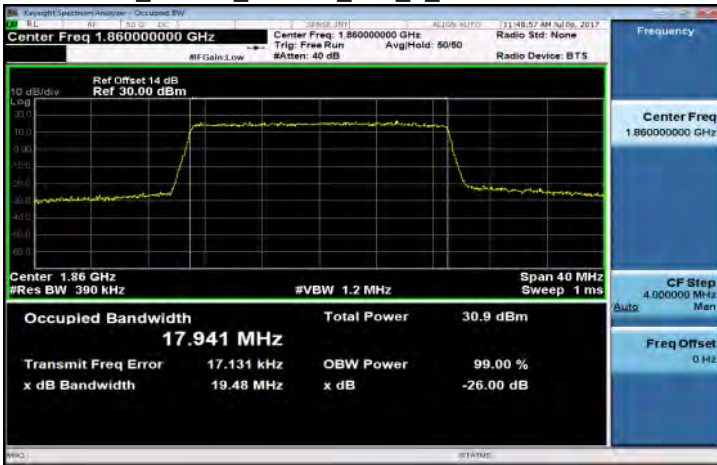

Band4\_1\_4MHz\_QPSK\_6\_0\_LowCH19957-1710.7

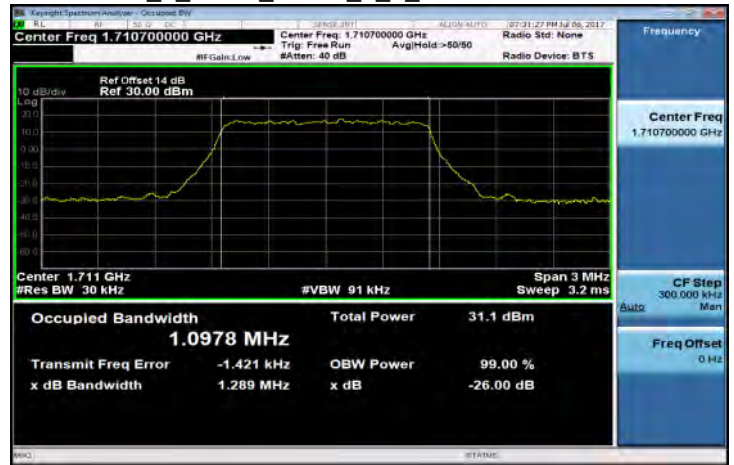

Band2\_20MHz\_16QAM\_100\_0\_MidCH18900-1880

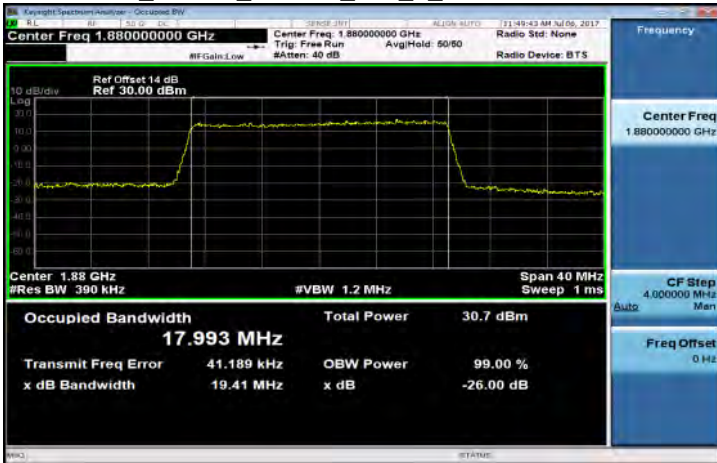

Band4\_1\_4MHz\_QPSK\_6\_0\_MidCH20175-1732.5

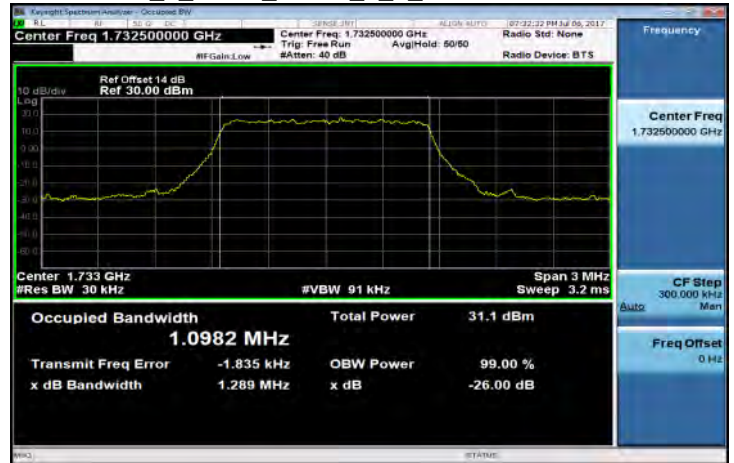

Band2\_20MHz\_16QAM\_100\_0\_HighCH19100-1900

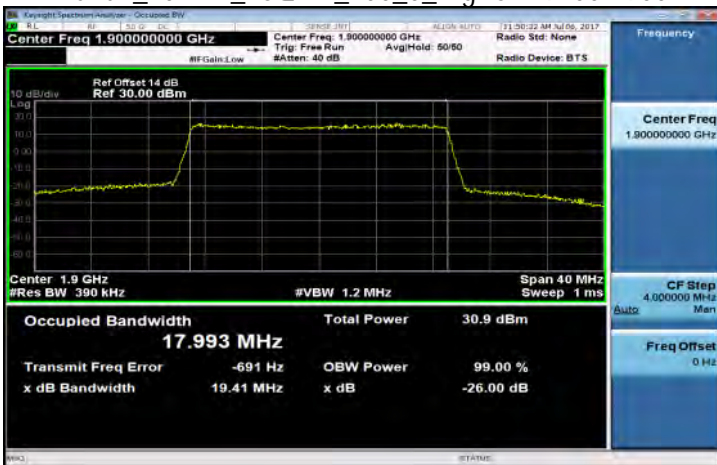

Band4\_1\_4MHz\_QPSK\_6\_0\_HighCH20393-1754.3

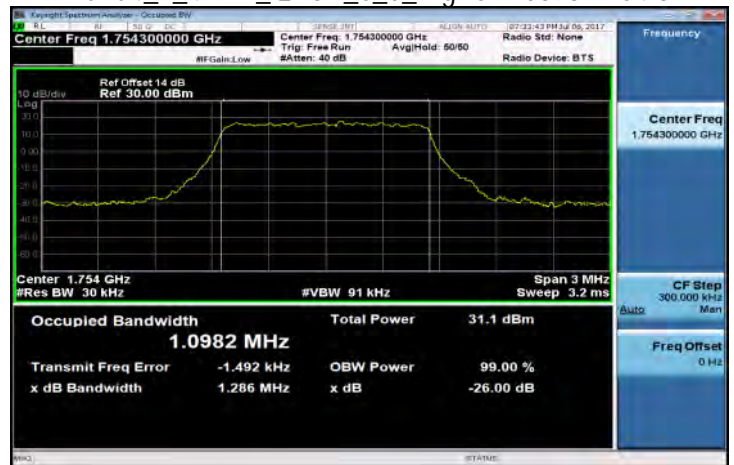

Unless otherwise stated the results shown in this test report refer only to the sample(s) tested and such sample(s) are retained for 90 days only.

除非另有說明，此報告結果僅對測試之樣品負責，同時此樣品僅保留90天。本報告未經本公司書面許可，不可部份複製。

This document is issued by the Company subject to its General Conditions of Service printed overleaf, available on request or accessible at [www.sgs.com/terms\\_and\\_conditions.htm](http://www.sgs.com/terms_and_conditions.htm) and, for electronic format documents, subject to Terms and Conditions for Electronic Documents at [www.sgs.com/terms\\_e-document.htm](http://www.sgs.com/terms_e-document.htm). Attention is drawn to the limitation of liability, indemnification and jurisdiction issues defined therein. Any holder of this document is advised that information contained hereon reflects the Company's findings at the time of its intervention only and within the limits of Client's instructions, if any. The Company's sole responsibility is to its Client and this document does not exonerate parties to a transaction from exercising all their rights and obligations under the transaction documents. This document cannot be reproduced except in full, without prior written approval of the Company. Any unauthorized alteration, forgery or falsification of the content or appearance of this document is unlawful and offenders may be prosecuted to the fullest extent of the law.



Band4\_1\_4MHz\_16QAM\_6\_0\_LowCH19957-1710.7

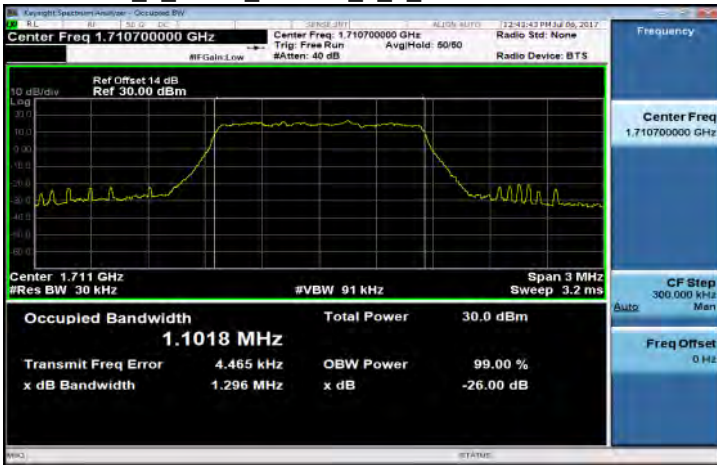

Band4\_3MHz\_QPSK\_15\_0\_LowCH19965-1711.5

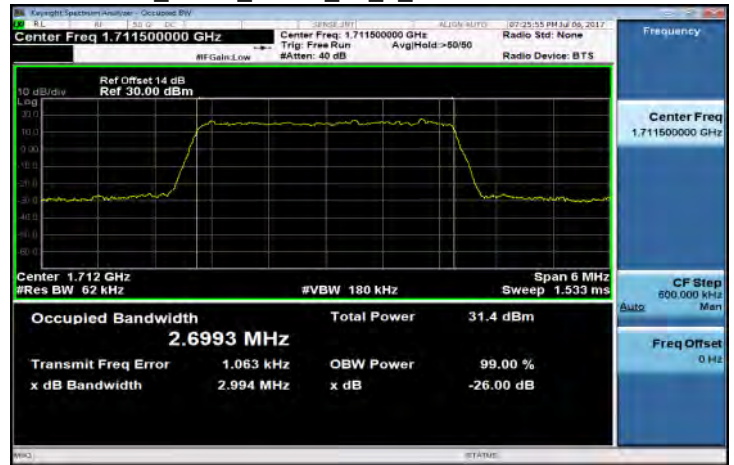

Band4\_1\_4MHz\_16QAM\_6\_0\_MidCH20175-1732.5

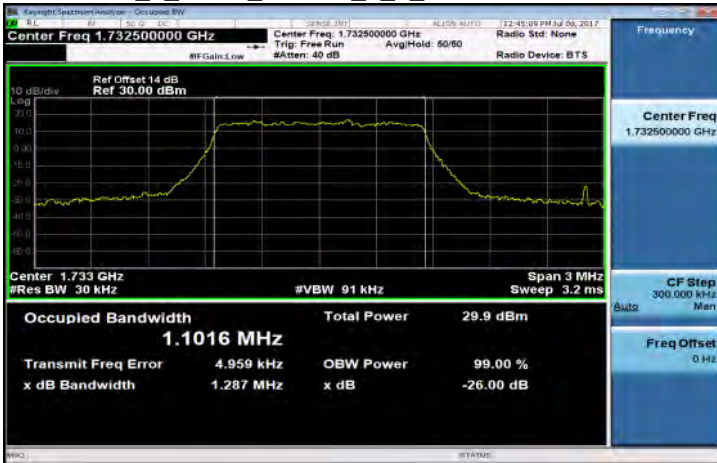

Band4\_3MHz\_QPSK\_15\_0\_MidCH20175-1732.5

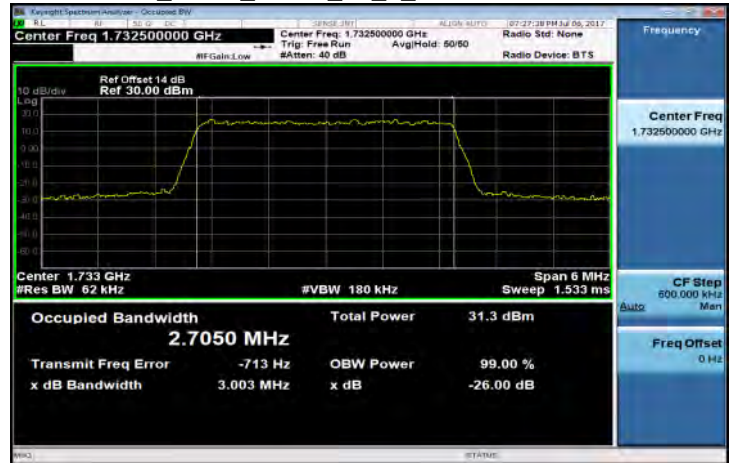

Band4\_1\_4MHz\_16QAM\_6\_0\_HighCH20393-1754.3

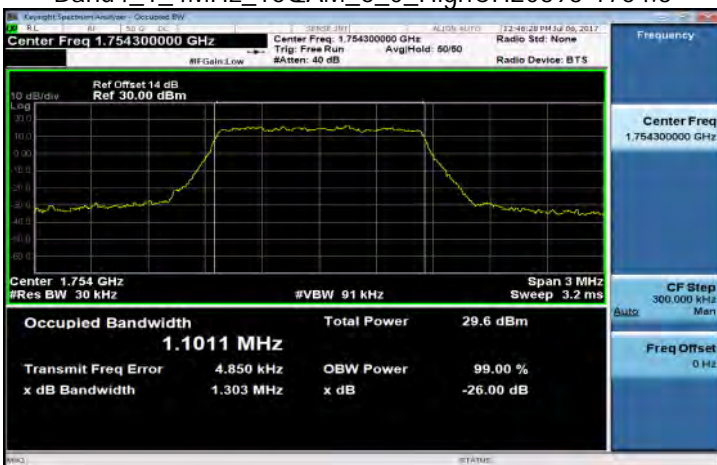

Band4\_3MHz\_QPSK\_15\_0\_HighCH20385-1753.5

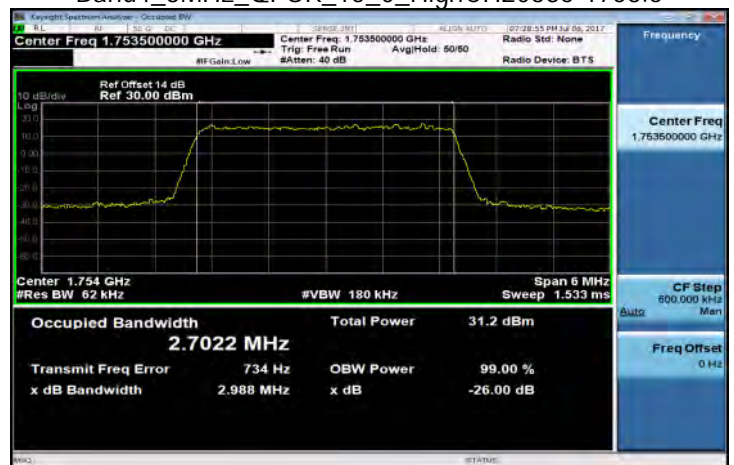

Unless otherwise stated the results shown in this test report refer only to the sample(s) tested and such sample(s) are retained for 90 days only.

除非另有說明，此報告結果僅對測試之樣品負責，同時此樣品僅保留90天。本報告未經本公司書面許可，不可部份複製。

This document is issued by the Company subject to its General Conditions of Service printed overleaf, available on request or accessible at [www.sgs.com/terms\\_and\\_conditions.htm](http://www.sgs.com/terms_and_conditions.htm) and, for electronic format documents, subject to Terms and Conditions for Electronic Documents at [www.sgs.com/terms\\_e-document.htm](http://www.sgs.com/terms_e-document.htm). Attention is drawn to the limitation of liability, indemnification and jurisdiction issues defined therein. Any holder of this document is advised that information contained hereon reflects the Company's findings at the time of its intervention only and within the limits of Client's instructions, if any. The Company's sole responsibility is to its Client and this document does not exonerate parties to a transaction from exercising all their rights and obligations under the transaction documents. This document cannot be reproduced except in full, without prior written approval of the Company. Any unauthorized alteration, forgery or falsification of the content or appearance of this document is unlawful and offenders may be prosecuted to the fullest extent of the law.

Band4\_3MHz\_16QAM\_15\_0\_LowCH1965-1711.5

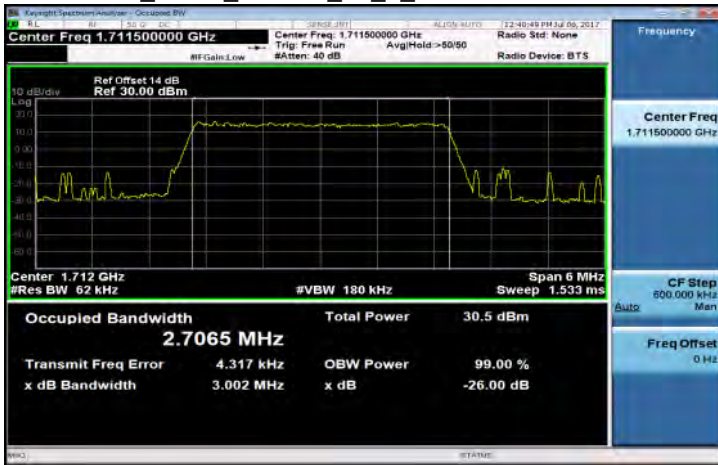

Band4\_5MHz\_QPSK\_25\_0\_LowCH1975-1712.5

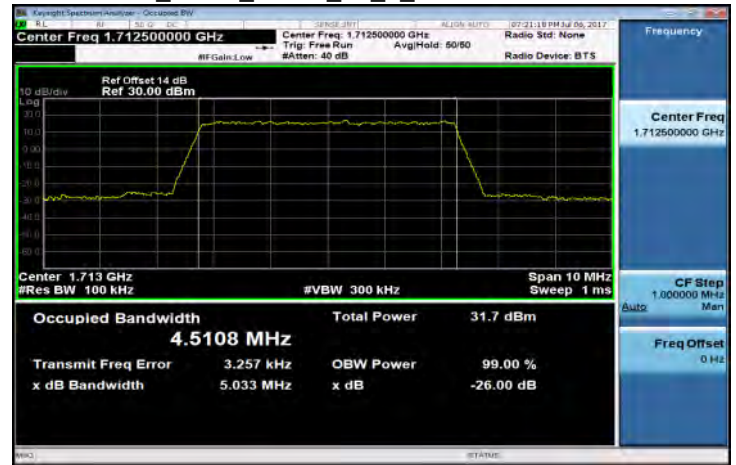

Band4\_3MHz\_16QAM\_15\_0\_MidCH20175-1732.5

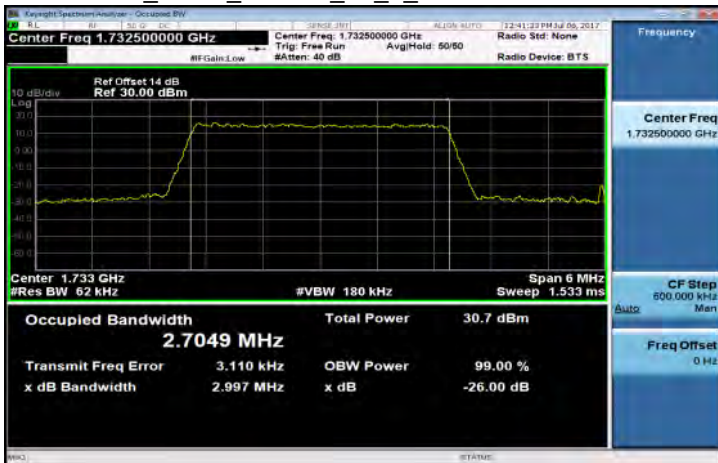

Band4\_5MHz\_QPSK\_25\_0\_MidCH20175-1732.5

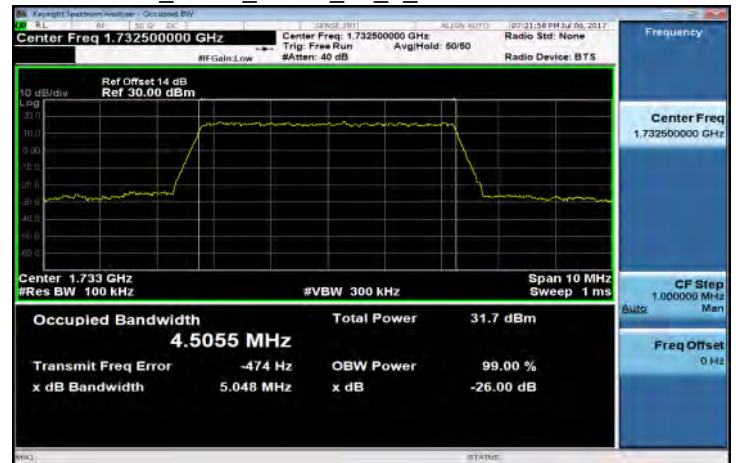

Band4\_3MHz\_16QAM\_15\_0\_HighCH20385-1753.5

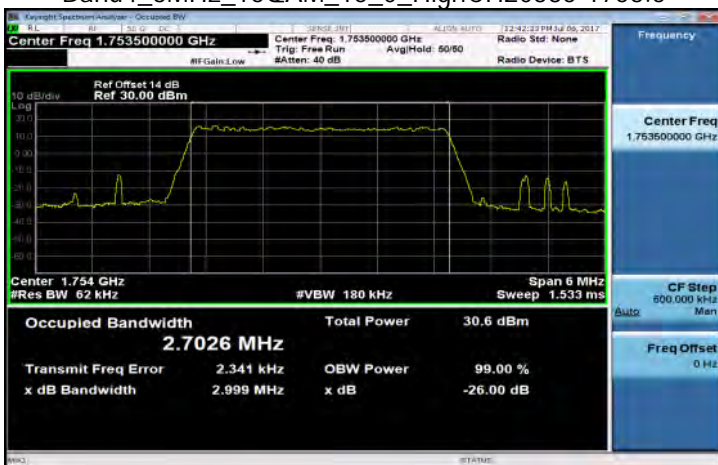

Band4\_5MHz\_QPSK\_25\_0\_HighCH20375-1752.5

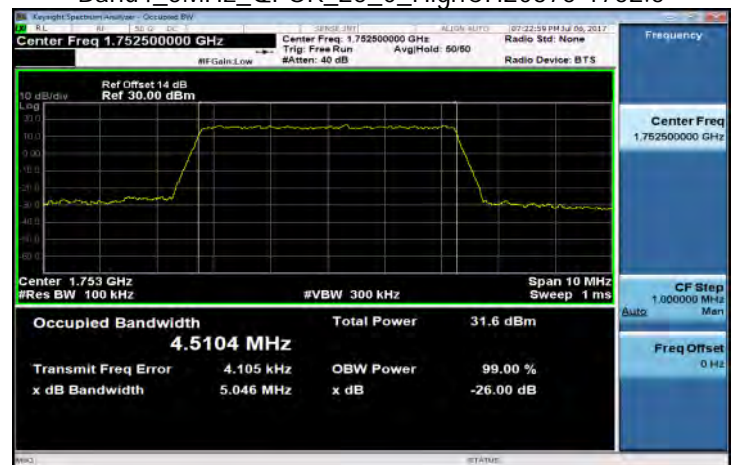

Unless otherwise stated the results shown in this test report refer only to the sample(s) tested and such sample(s) are retained for 90 days only.

除非另有說明，此報告結果僅對測試之樣品負責，同時此樣品僅保留90天。本報告未經本公司書面許可，不可部份複製。

This document is issued by the Company subject to its General Conditions of Service printed overleaf, available on request or accessible at [www.sgs.com/terms\\_and\\_conditions.htm](http://www.sgs.com/terms_and_conditions.htm) and, for electronic format documents, subject to Terms and Conditions for Electronic Documents at [www.sgs.com/terms\\_e-document.htm](http://www.sgs.com/terms_e-document.htm). Attention is drawn to the limitation of liability, indemnification and jurisdiction issues defined therein. Any holder of this document is advised that information contained hereon reflects the Company's findings at the time of its intervention only and within the limits of Client's instructions, if any. The Company's sole responsibility is to its Client and this document does not exonerate parties to a transaction from exercising all their rights and obligations under the transaction documents. This document cannot be reproduced except in full, without prior written approval of the Company. Any unauthorized alteration, forgery or falsification of the content or appearance of this document is unlawful and offenders may be prosecuted to the fullest extent of the law.



Band4\_5MHz\_16QAM\_25\_0\_LowCH1975-1712.5

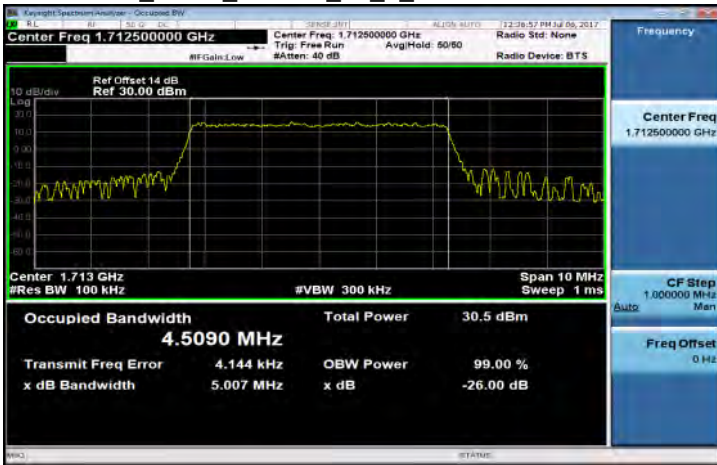

Band4\_10MHz\_QPSK\_50\_0\_LowCH2000-1715

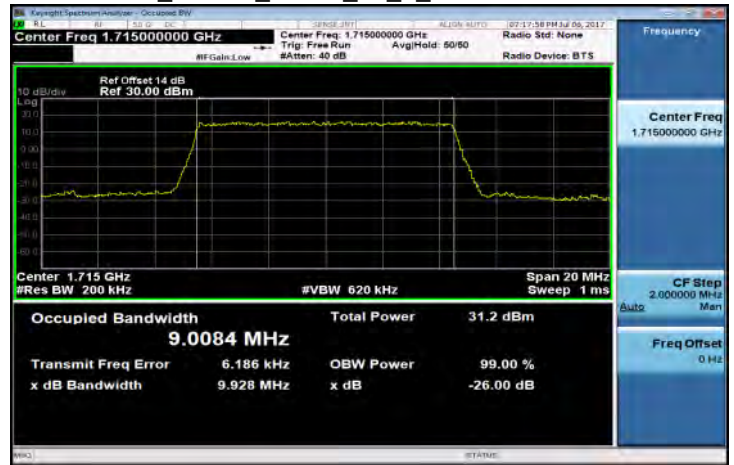

Band4\_5MHz\_16QAM\_25\_0\_MidCH20175-1732.5

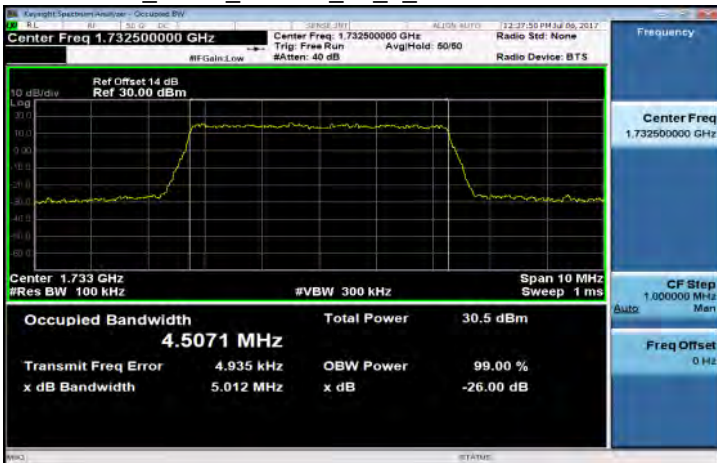

Band4\_10MHz\_QPSK\_50\_0\_MidCH20175-1732.5

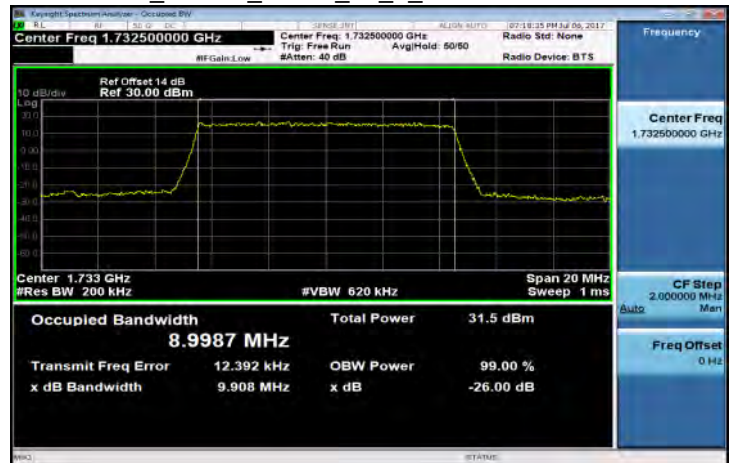

Band4\_5MHz\_16QAM\_25\_0\_HighCH20375-1752.5

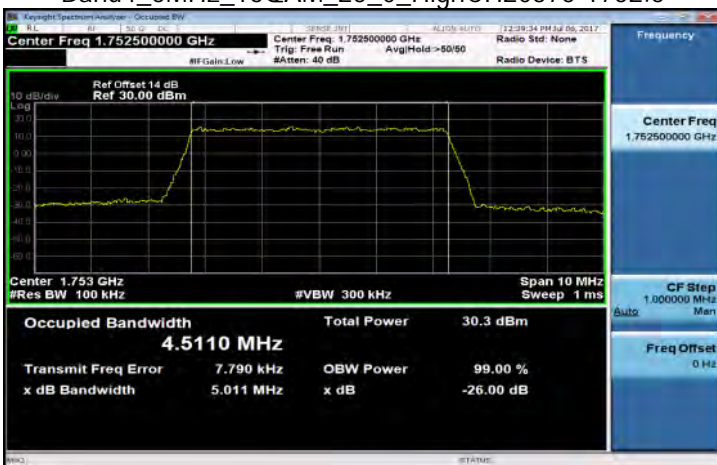

Band4\_10MHz\_QPSK\_50\_0\_HighCH20350-1750

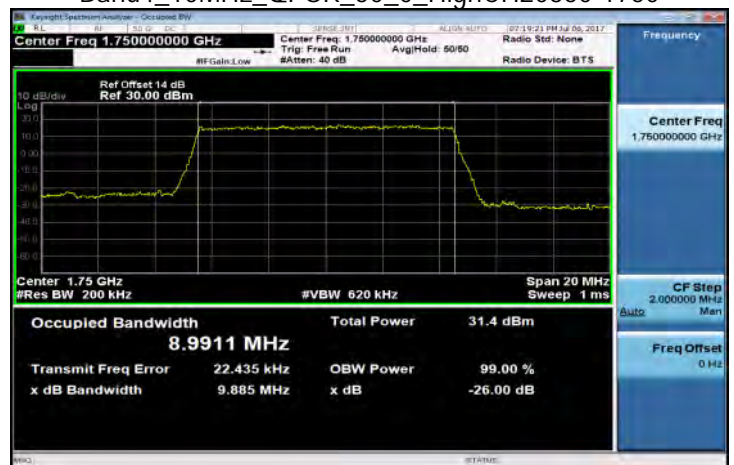

Unless otherwise stated the results shown in this test report refer only to the sample(s) tested and such sample(s) are retained for 90 days only.

除非另有說明，此報告結果僅對測試之樣品負責，同時此樣品僅保留90天。本報告未經本公司書面許可，不可部份複製。

This document is issued by the Company subject to its General Conditions of Service printed overleaf, available on request or accessible at [www.sgs.com/terms\\_and\\_conditions.htm](http://www.sgs.com/terms_and_conditions.htm) and, for electronic format documents, subject to Terms and Conditions for Electronic Documents at [www.sgs.com/terms\\_e-document.htm](http://www.sgs.com/terms_e-document.htm). Attention is drawn to the limitation of liability, indemnification and jurisdiction issues defined therein. Any holder of this document is advised that information contained hereon reflects the Company's findings at the time of its intervention only and within the limits of Client's instructions, if any. The Company's sole responsibility is to its Client and this document does not exonerate parties to a transaction from exercising all their rights and obligations under the transaction documents. This document cannot be reproduced except in full, without prior written approval of the Company. Any unauthorized alteration, forgery or falsification of the content or appearance of this document is unlawful and offenders may be prosecuted to the fullest extent of the law.



Band4\_10MHz\_16QAM\_50\_0\_LowCH20000-1715

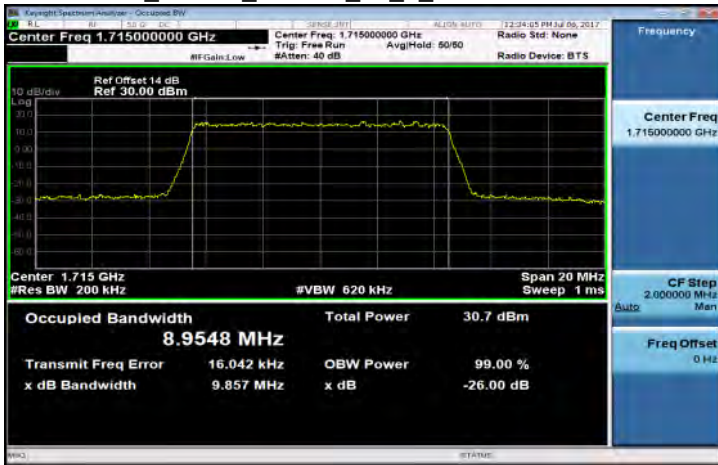

Band4\_15MHz\_QPSK\_75\_0\_LowCH20025-1717.5

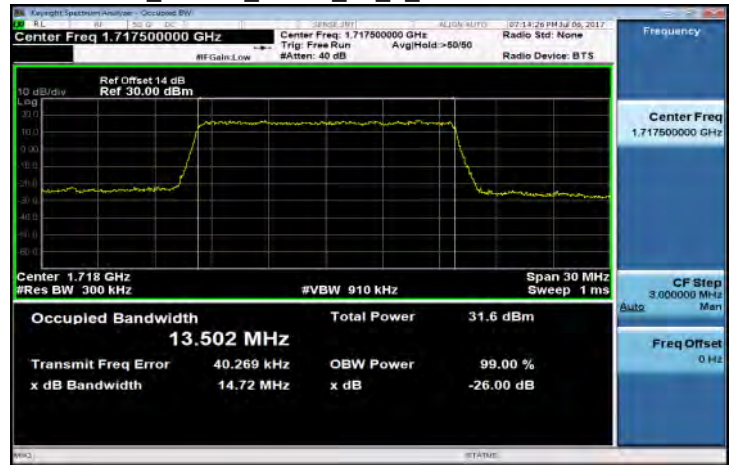

Band4\_10MHz\_16QAM\_50\_0\_MidCH20175-1732.5

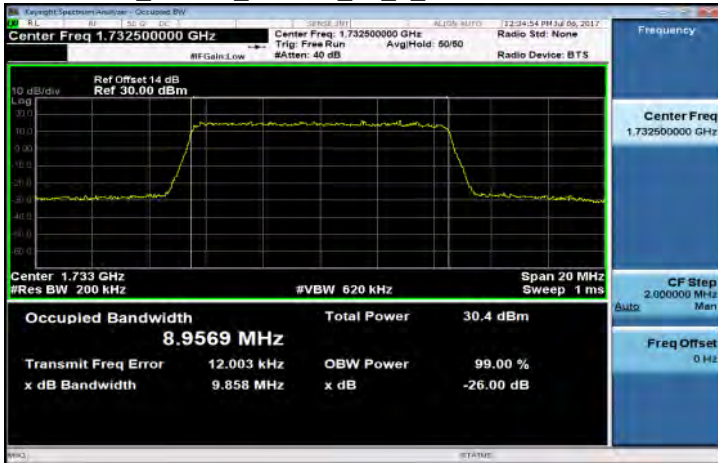

Band4\_15MHz\_QPSK\_75\_0\_MidCH20175-1732.5

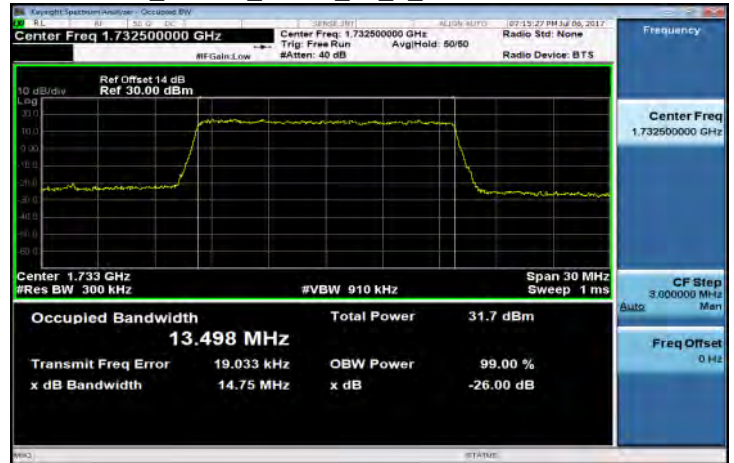

Band4\_10MHz\_16QAM\_50\_0\_HighCH20350-1750

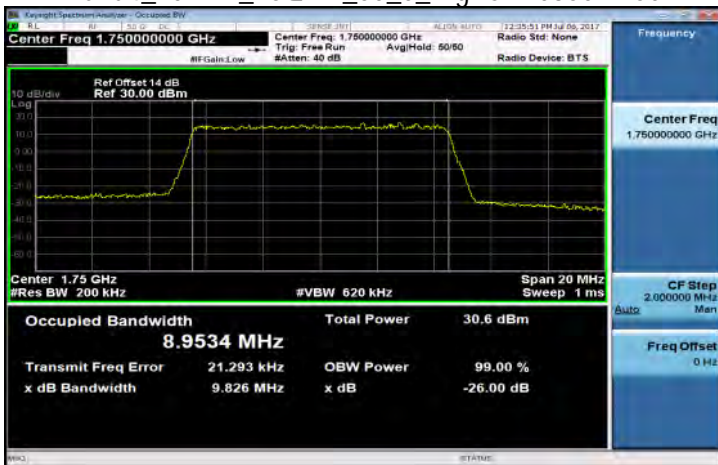

Band4\_15MHz\_QPSK\_75\_0\_HighCH20325-1747.5

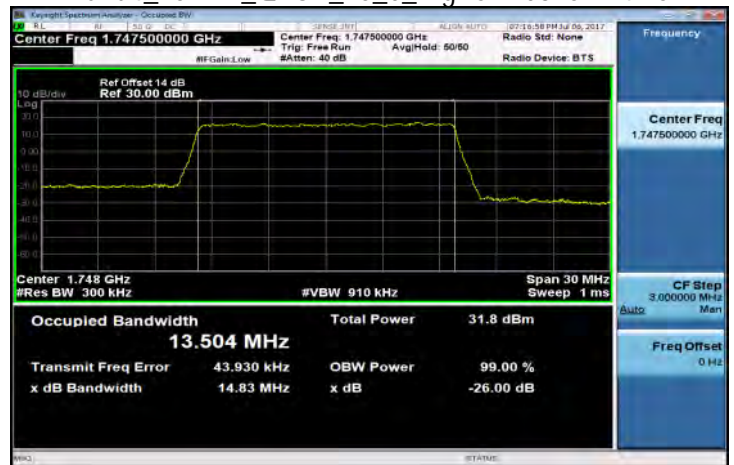

Unless otherwise stated the results shown in this test report refer only to the sample(s) tested and such sample(s) are retained for 90 days only.

除非另有說明，此報告結果僅對測試之樣品負責，同時此樣品僅保留90天。本報告未經本公司書面許可，不可部份複製。

This document is issued by the Company subject to its General Conditions of Service printed overleaf, available on request or accessible at [www.sgs.com/terms\\_and\\_conditions.htm](http://www.sgs.com/terms_and_conditions.htm) and, for electronic format documents, subject to Terms and Conditions for Electronic Documents at [www.sgs.com/terms\\_e-document.htm](http://www.sgs.com/terms_e-document.htm). Attention is drawn to the limitation of liability, indemnification and jurisdiction issues defined therein. Any holder of this document is advised that information contained hereon reflects the Company's findings at the time of its intervention only and within the limits of Client's instructions, if any. The Company's sole responsibility is to its Client and this document does not exonerate parties to a transaction from exercising all their rights and obligations under the transaction documents. This document cannot be reproduced except in full, without prior written approval of the Company. Any unauthorized alteration, forgery or falsification of the content or appearance of this document is unlawful and offenders may be prosecuted to the fullest extent of the law.

Band4\_15MHz\_16QAM\_75\_0\_LowCH20025-1717.5

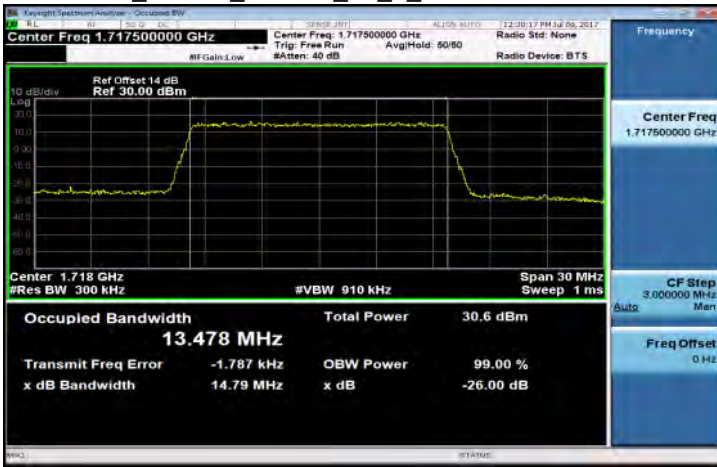

Band4\_20MHz\_QPSK\_100\_0\_LowCH20050-1720

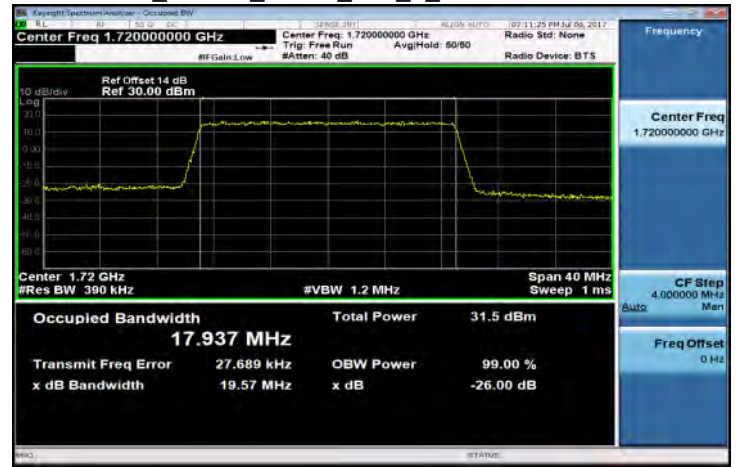

Band4\_15MHz\_16QAM\_75\_0\_MidCH20175-1732.5

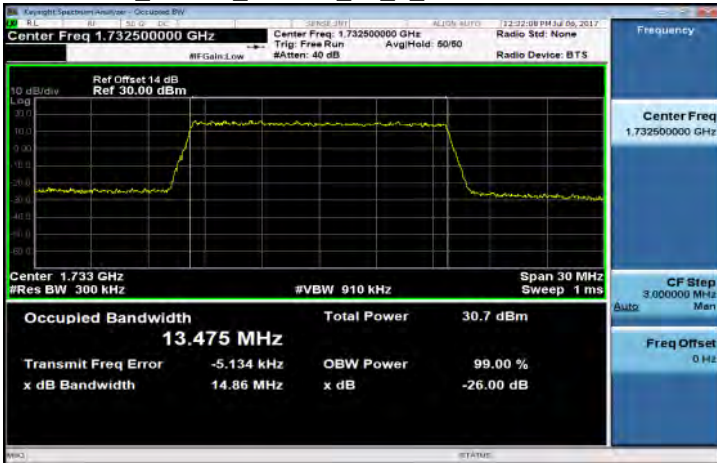

Band4\_20MHz\_QPSK\_100\_0\_MidCH20175-1732.5

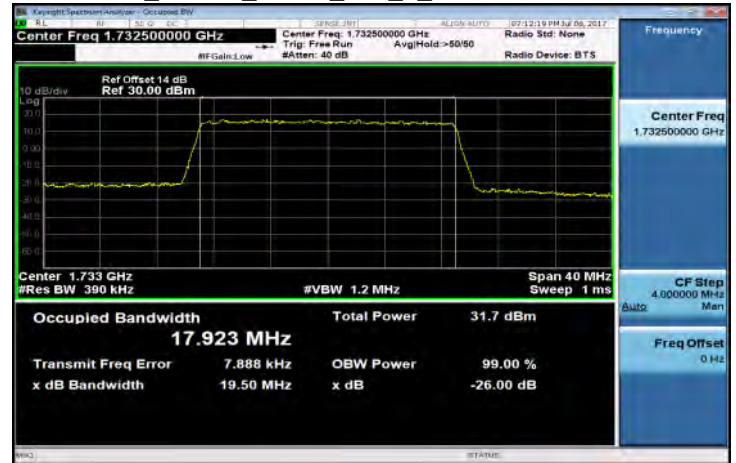

Band4\_15MHz\_16QAM\_75\_0\_HighCH20325-1747.5

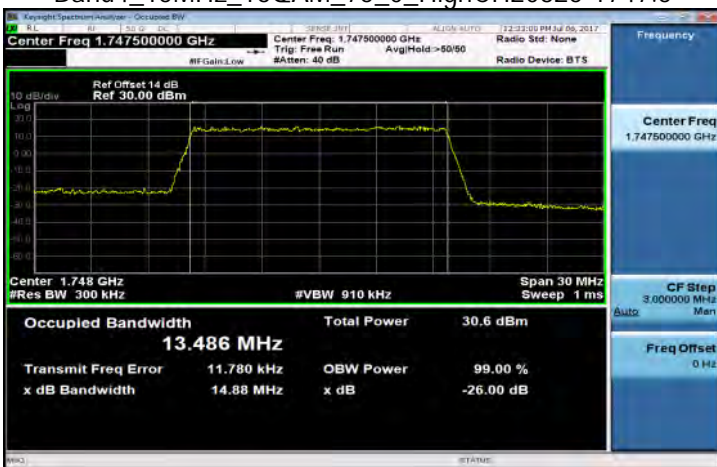

Band4\_20MHz\_QPSK\_100\_0\_HighCH20300-1745

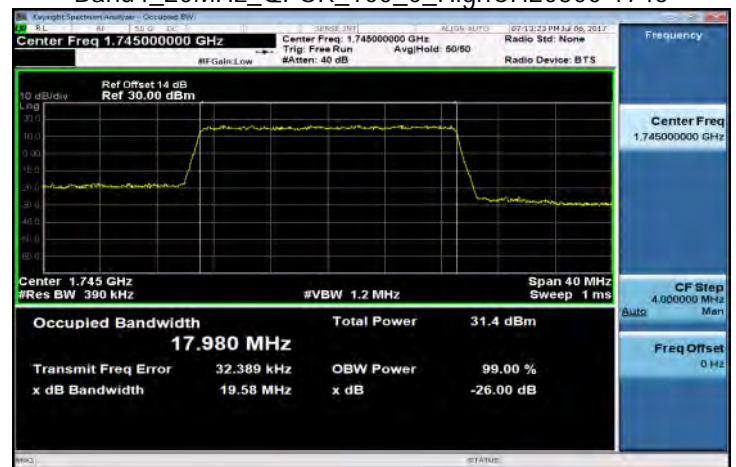

Unless otherwise stated the results shown in this test report refer only to the sample(s) tested and such sample(s) are retained for 90 days only.

除非另有說明，此報告結果僅對測試之樣品負責，同時此樣品僅保留90天。本報告未經本公司書面許可，不可部份複製。

This document is issued by the Company subject to its General Conditions of Service printed overleaf, available on request or accessible at [www.sgs.com/terms\\_and\\_conditions.htm](http://www.sgs.com/terms_and_conditions.htm) and, for electronic format documents, subject to Terms and Conditions for Electronic Documents at [www.sgs.com/terms\\_e-document.htm](http://www.sgs.com/terms_e-document.htm). Attention is drawn to the limitation of liability, indemnification and jurisdiction issues defined therein. Any holder of this document is advised that information contained hereon reflects the Company's findings at the time of its intervention only and within the limits of Client's instructions, if any. The Company's sole responsibility is to its Client and this document does not exonerate parties to a transaction from exercising all their rights and obligations under the transaction documents. This document cannot be reproduced except in full, without prior written approval of the Company. Any unauthorized alteration, forgery or falsification of the content or appearance of this document is unlawful and offenders may be prosecuted to the fullest extent of the law.



Band4\_20MHz\_16QAM\_100\_0\_LowCH20050-1720

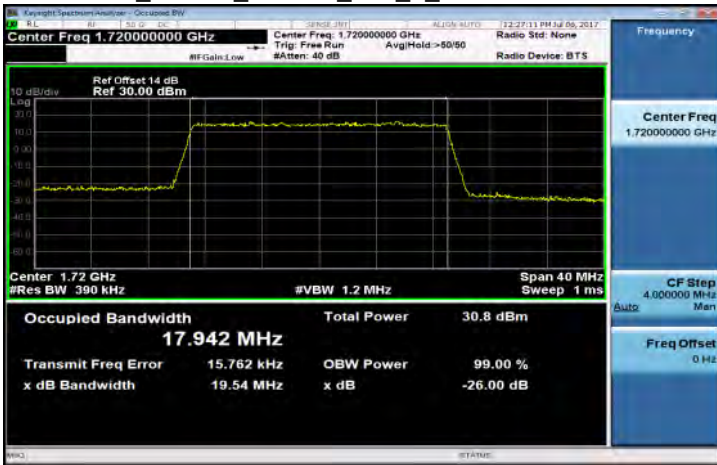

Band7\_5MHz\_QPSK\_25\_0\_LowCH20775-2502.5

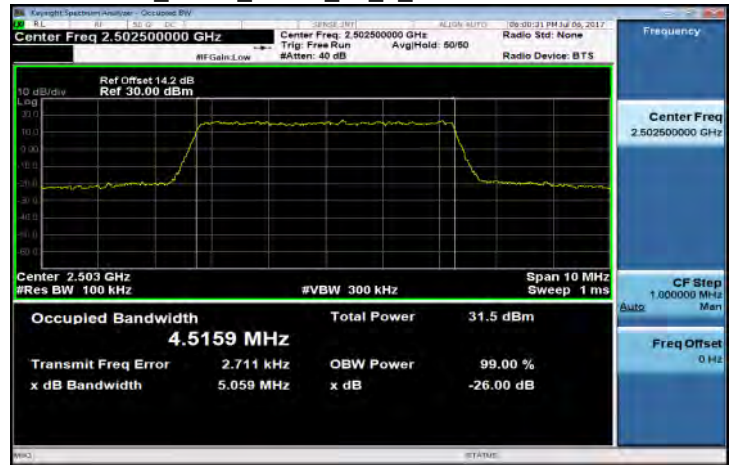

Band4\_20MHz\_16QAM\_100\_0\_MidCH20175-1732.5

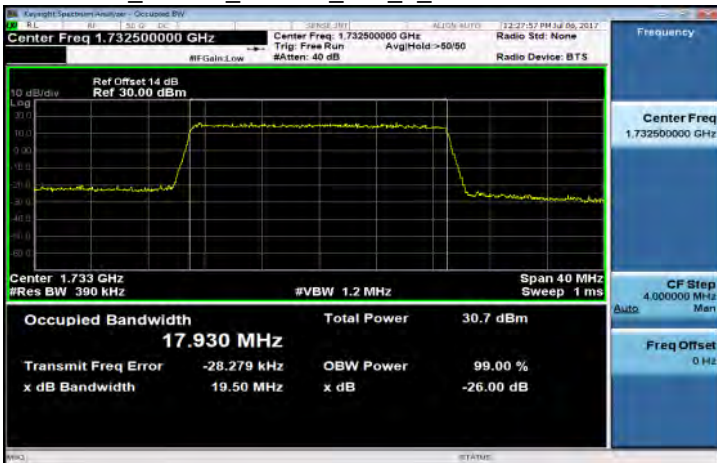

Band7\_5MHz\_QPSK\_25\_0\_MidCH21100-2535

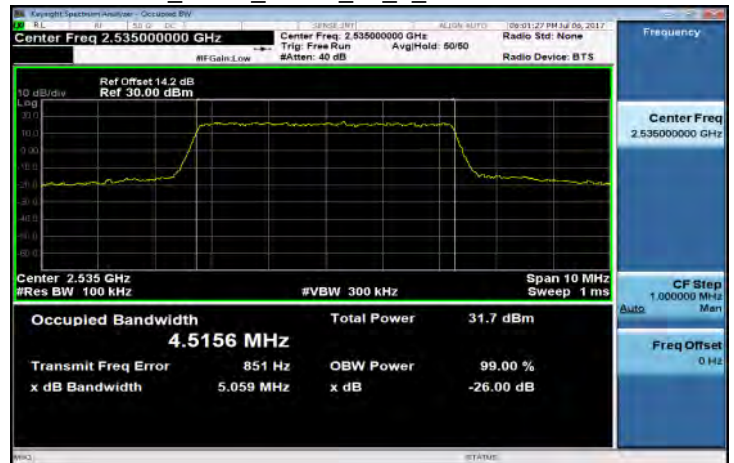

Band4\_20MHz\_16QAM\_100\_0\_HighCH20300-1745

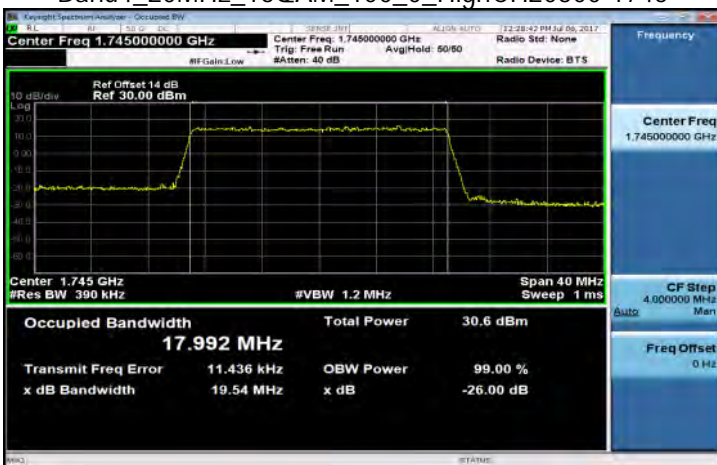

Band7\_5MHz\_QPSK\_25\_0\_HighCH21425-2567.5

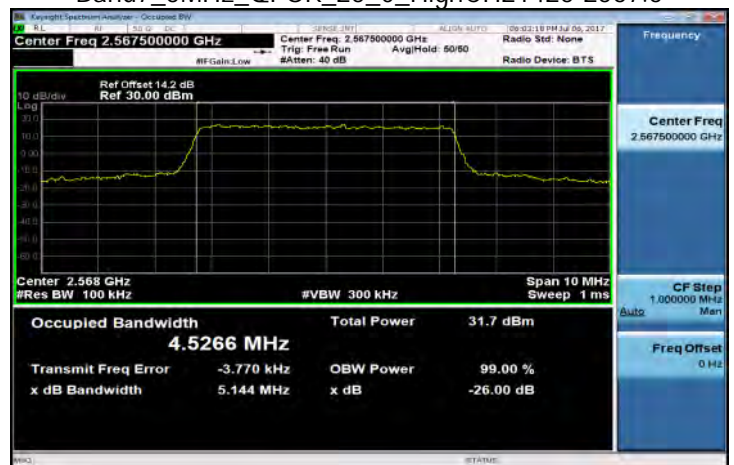

Unless otherwise stated the results shown in this test report refer only to the sample(s) tested and such sample(s) are retained for 90 days only.

除非另有說明，此報告結果僅對測試之樣品負責，同時此樣品僅保留90天。本報告未經本公司書面許可，不可部份複製。

This document is issued by the Company subject to its General Conditions of Service printed overleaf, available on request or accessible at [www.sgs.com/terms\\_and\\_conditions.htm](http://www.sgs.com/terms_and_conditions.htm) and, for electronic format documents, subject to Terms and Conditions for Electronic Documents at [www.sgs.com/terms\\_e-document.htm](http://www.sgs.com/terms_e-document.htm). Attention is drawn to the limitation of liability, indemnification and jurisdiction issues defined therein. Any holder of this document is advised that information contained hereon reflects the Company's findings at the time of its intervention only and within the limits of Client's instructions, if any. The Company's sole responsibility is to its Client and this document does not exonerate parties to a transaction from exercising all their rights and obligations under the transaction documents. This document cannot be reproduced except in full, without prior written approval of the Company. Any unauthorized alteration, forgery or falsification of the content or appearance of this document is unlawful and offenders may be prosecuted to the fullest extent of the law.

Band7\_5MHz\_16QAM\_25\_0\_LowCH20775-2502.5

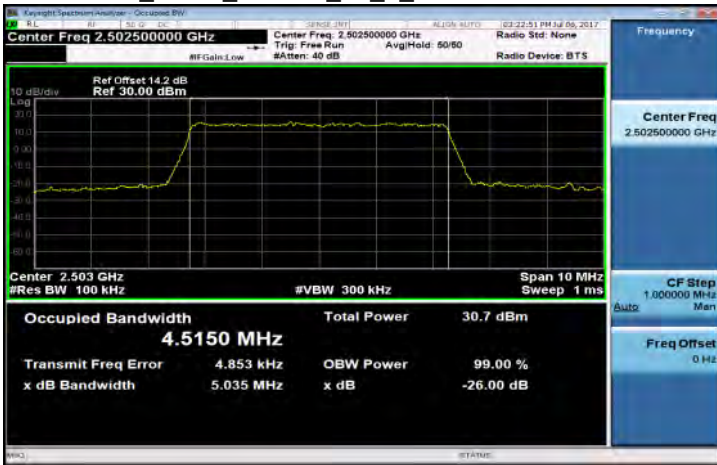

Band7\_10MHz\_QPSK\_50\_0\_LowCH20800-2505

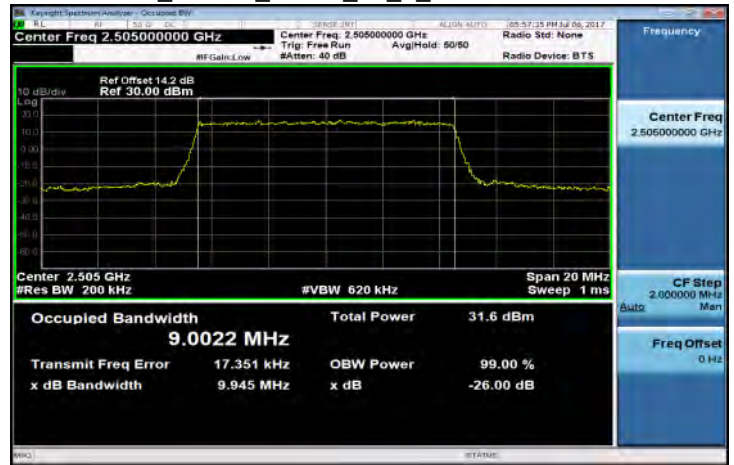

Band7\_5MHz\_16QAM\_25\_0\_MidCH21100-2535

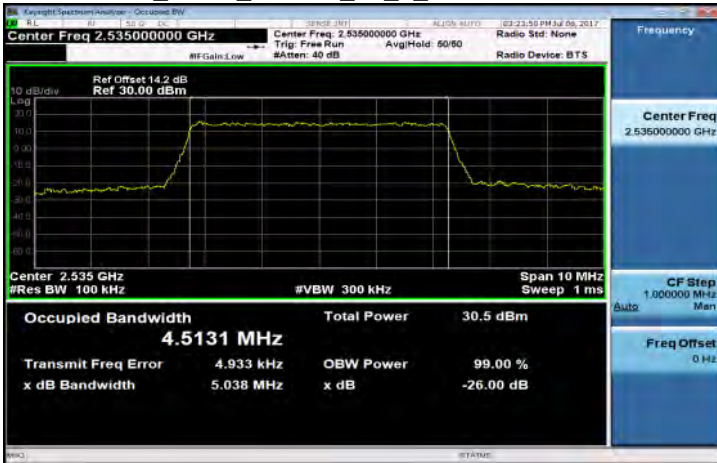

Band7\_10MHz\_QPSK\_50\_0\_MidCH21100-2535

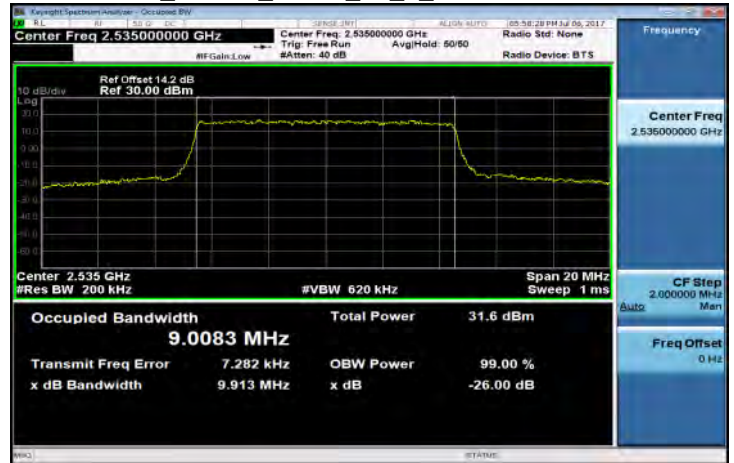

Band7\_5MHz\_16QAM\_25\_0\_HighCH21425-2567.5

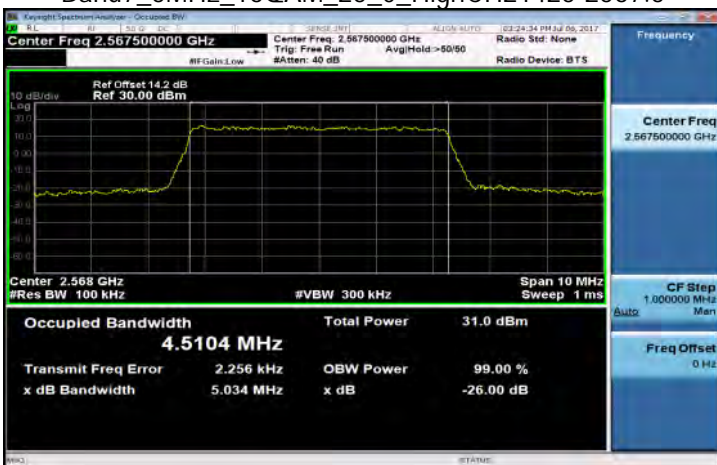

Band7\_10MHz\_QPSK\_50\_0\_HighCH21400-2565

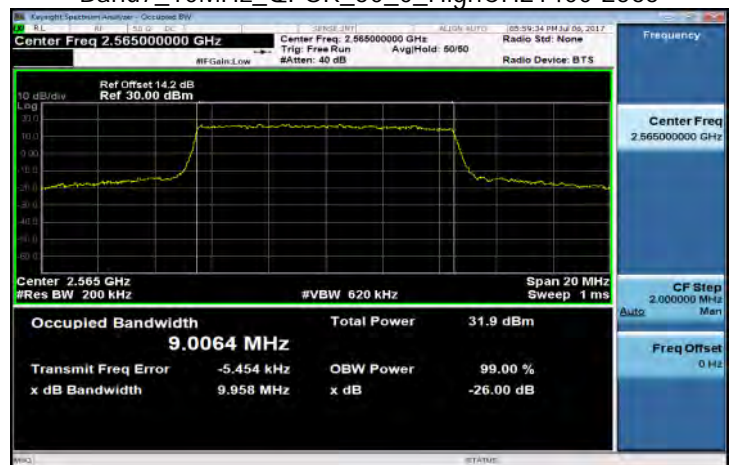

Unless otherwise stated the results shown in this test report refer only to the sample(s) tested and such sample(s) are retained for 90 days only.

除非另有說明，此報告結果僅對測試之樣品負責，同時此樣品僅保留90天。本報告未經本公司書面許可，不可部份複製。

This document is issued by the Company subject to its General Conditions of Service printed overleaf, available on request or accessible at [www.sgs.com/terms\\_and\\_conditions.htm](http://www.sgs.com/terms_and_conditions.htm) and, for electronic format documents, subject to Terms and Conditions for Electronic Documents at [www.sgs.com/terms\\_e-document.htm](http://www.sgs.com/terms_e-document.htm). Attention is drawn to the limitation of liability, indemnification and jurisdiction issues defined therein. Any holder of this document is advised that information contained hereon reflects the Company's findings at the time of its intervention only and within the limits of Client's instructions, if any. The Company's sole responsibility is to its Client and this document does not exonerate parties to a transaction from exercising all their rights and obligations under the transaction documents. This document cannot be reproduced except in full, without prior written approval of the Company. Any unauthorized alteration, forgery or falsification of the content or appearance of this document is unlawful and offenders may be prosecuted to the fullest extent of the law.



Band7\_10MHz\_16QAM\_50\_0\_LowCH20800-2505

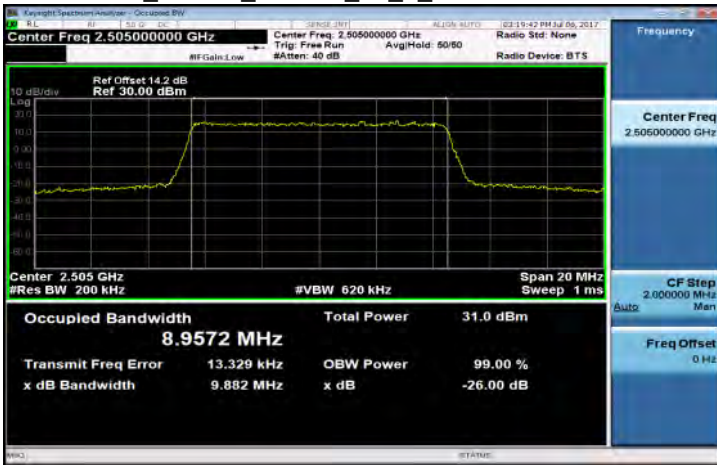

Band7\_15MHz\_QPSK\_75\_0\_LowCH20825-2507.5

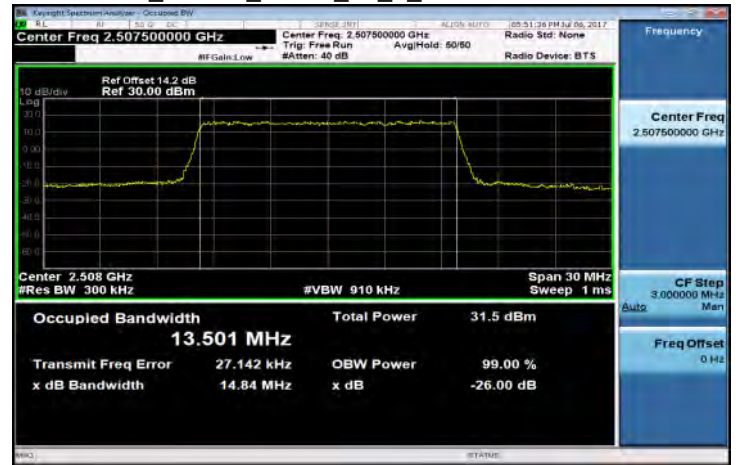

Band7\_10MHz\_16QAM\_50\_0\_MidCH21100-2535

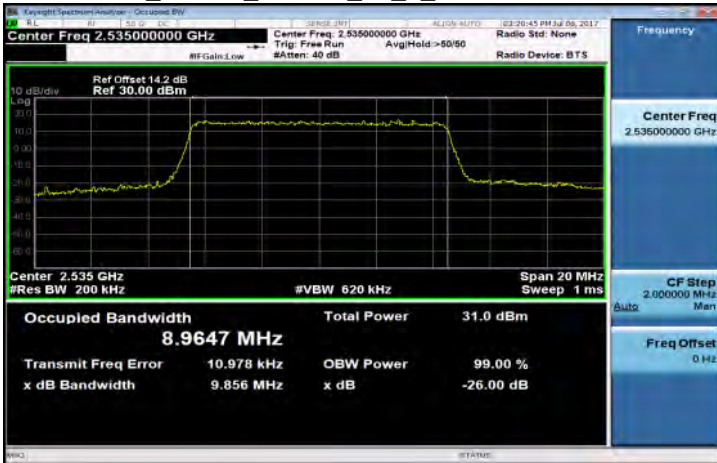

Band7\_15MHz\_QPSK\_75\_0\_MidCH21100-2535

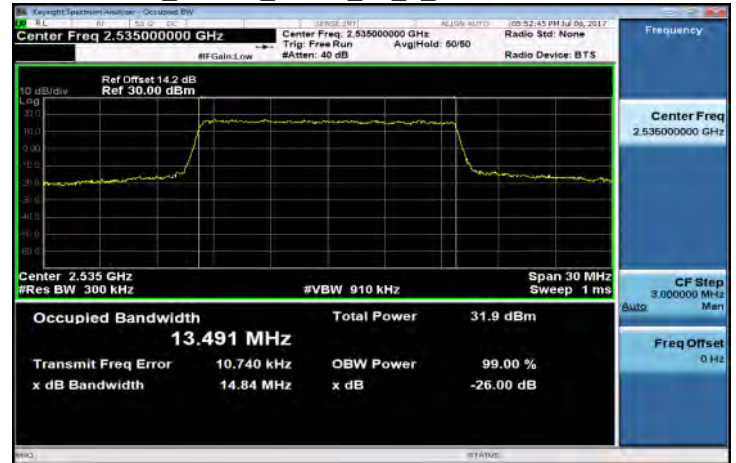

Band7\_10MHz\_16QAM\_50\_0\_HighCH21400-2565

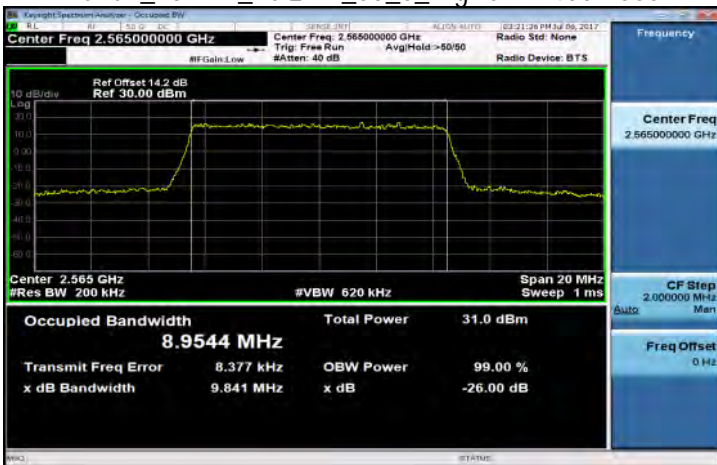

Band7\_15MHz\_QPSK\_75\_0\_HighCH21375-2562.5

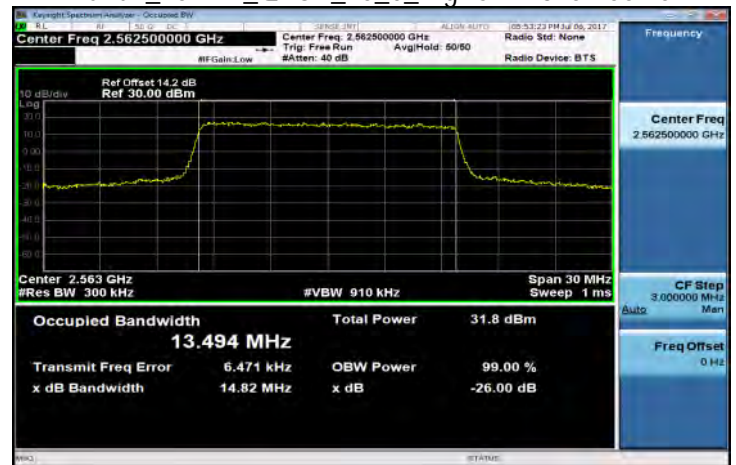

Unless otherwise stated the results shown in this test report refer only to the sample(s) tested and such sample(s) are retained for 90 days only.

除非另有說明，此報告結果僅對測試之樣品負責，同時此樣品僅保留90天。本報告未經本公司書面許可，不可部份複製。

This document is issued by the Company subject to its General Conditions of Service printed overleaf, available on request or accessible at [www.sgs.com/terms\\_and\\_conditions.htm](http://www.sgs.com/terms_and_conditions.htm) and, for electronic format documents, subject to Terms and Conditions for Electronic Documents at [www.sgs.com/terms\\_e-document.htm](http://www.sgs.com/terms_e-document.htm). Attention is drawn to the limitation of liability, indemnification and jurisdiction issues defined therein. Any holder of this document is advised that information contained hereon reflects the Company's findings at the time of its intervention only and within the limits of Client's instructions, if any. The Company's sole responsibility is to its Client and this document does not exonerate parties to a transaction from exercising all their rights and obligations under the transaction documents. This document cannot be reproduced except in full, without prior written approval of the Company. Any unauthorized alteration, forgery or falsification of the content or appearance of this document is unlawful and offenders may be prosecuted to the fullest extent of the law.

Band7\_15MHz\_16QAM\_75\_0\_LowCH20825-2507.5

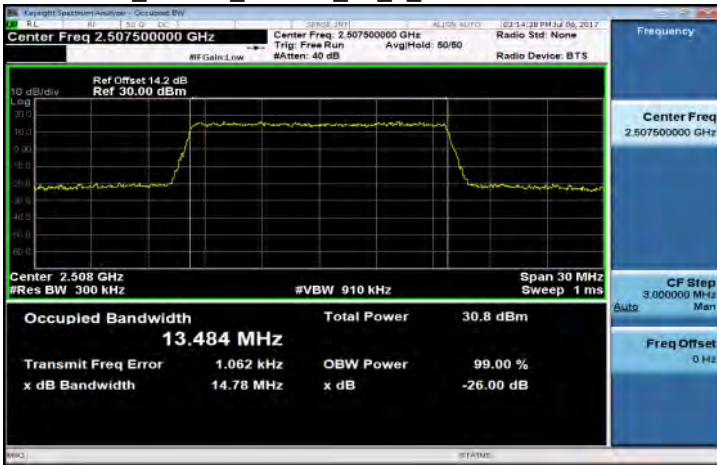

Band7\_20MHz\_QPSK\_100\_0\_LowCH20850-2510

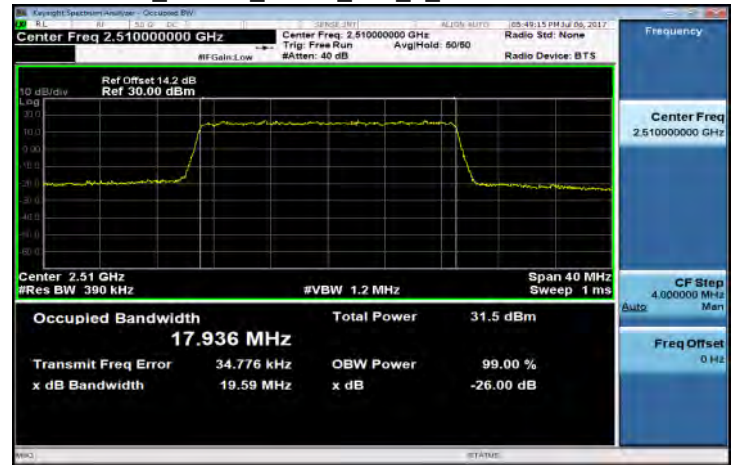

Band7\_15MHz\_16QAM\_75\_0\_MidCH21100-2535

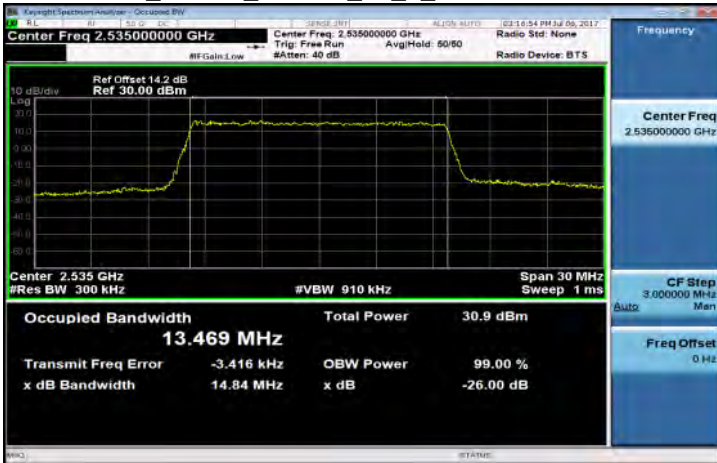

Band7\_20MHz\_QPSK\_100\_0\_MidCH21100-2535

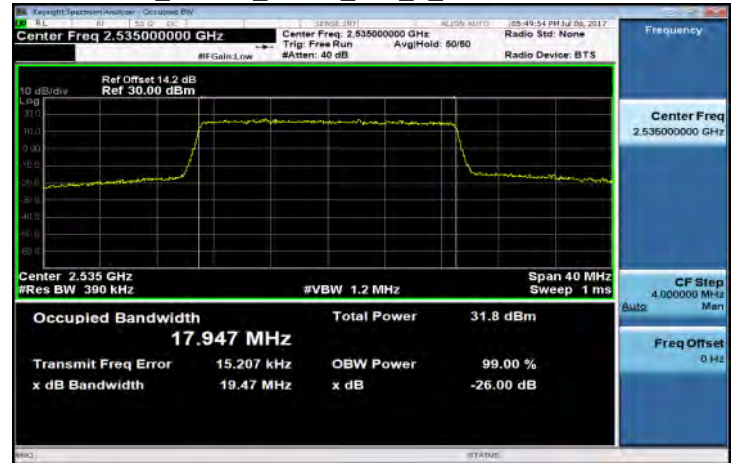

Band7\_15MHz\_16QAM\_75\_0\_HighCH21375-2562.5

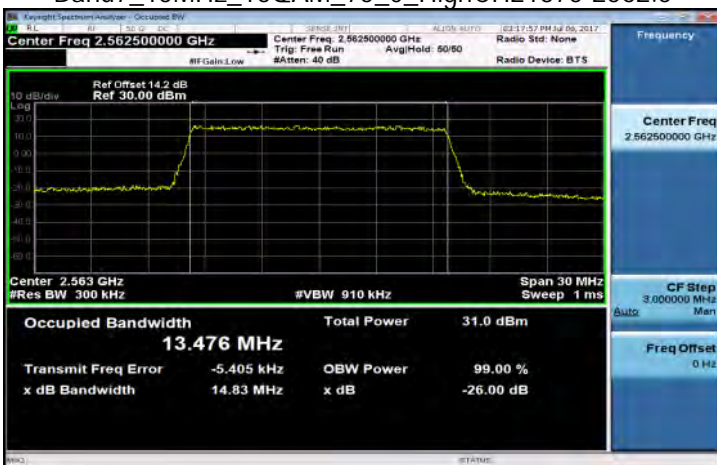

Band7\_20MHz\_QPSK\_100\_0\_HighCH21350-2560

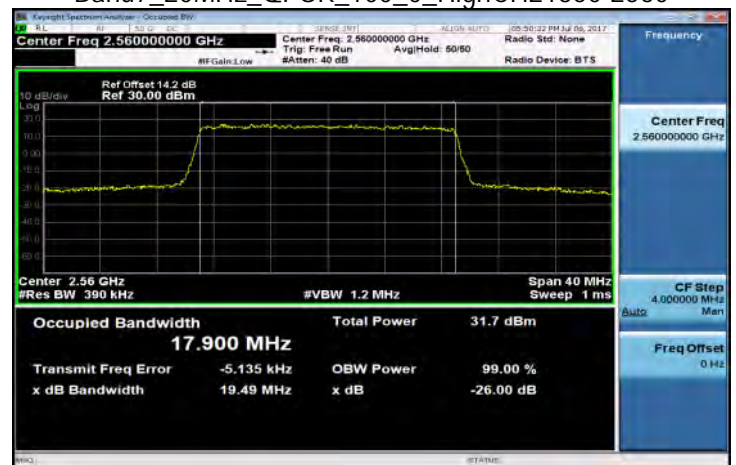

Unless otherwise stated the results shown in this test report refer only to the sample(s) tested and such sample(s) are retained for 90 days only.

除非另有說明，此報告結果僅對測試之樣品負責，同時此樣品僅保留90天。本報告未經本公司書面許可，不可部份複製。

This document is issued by the Company subject to its General Conditions of Service printed overleaf, available on request or accessible at [www.sgs.com/terms\\_and\\_conditions.htm](http://www.sgs.com/terms_and_conditions.htm) and, for electronic format documents, subject to Terms and Conditions for Electronic Documents at [www.sgs.com/terms\\_e-document.htm](http://www.sgs.com/terms_e-document.htm). Attention is drawn to the limitation of liability, indemnification and jurisdiction issues defined therein. Any holder of this document is advised that information contained hereon reflects the Company's findings at the time of its intervention only and within the limits of Client's instructions, if any. The Company's sole responsibility is to its Client and this document does not exonerate parties to a transaction from exercising all their rights and obligations under the transaction documents. This document cannot be reproduced except in full, without prior written approval of the Company. Any unauthorized alteration, forgery or falsification of the content or appearance of this document is unlawful and offenders may be prosecuted to the fullest extent of the law.



Band7\_20MHz\_16QAM\_100\_0\_LowCH20850-2510

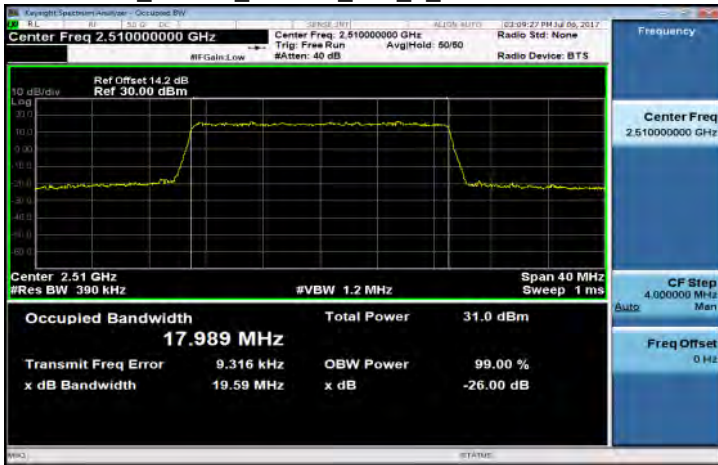

Band12\_1\_4MHz\_QPSK\_6\_0\_LowCH23017-699.7

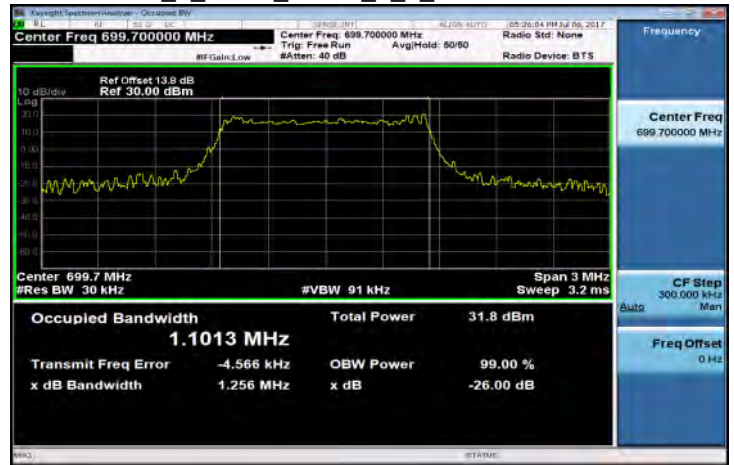

Band7\_20MHz\_16QAM\_100\_0\_MidCH21100-2535

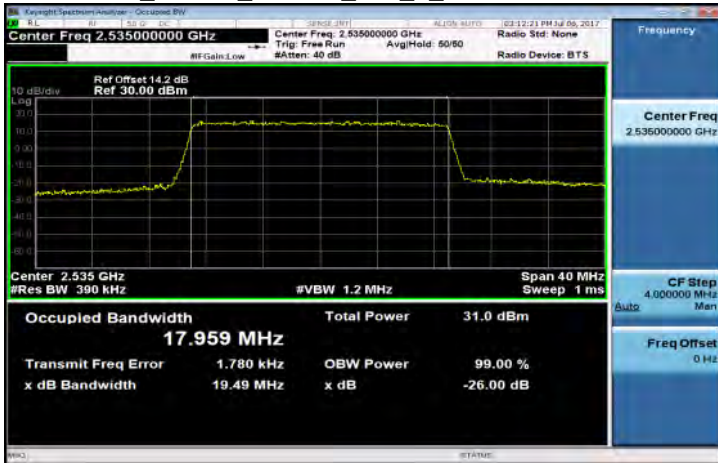

Band12\_1\_4MHz\_QPSK\_6\_0\_MidCH23095-707.5

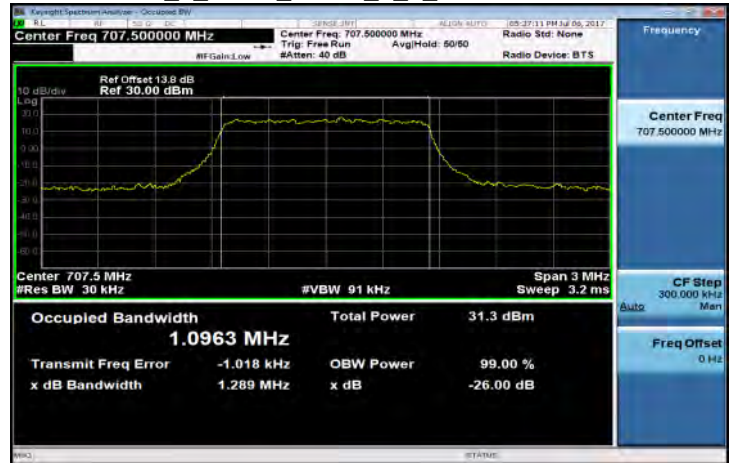

Band7\_20MHz\_16QAM\_100\_0\_HighCH21350-2560

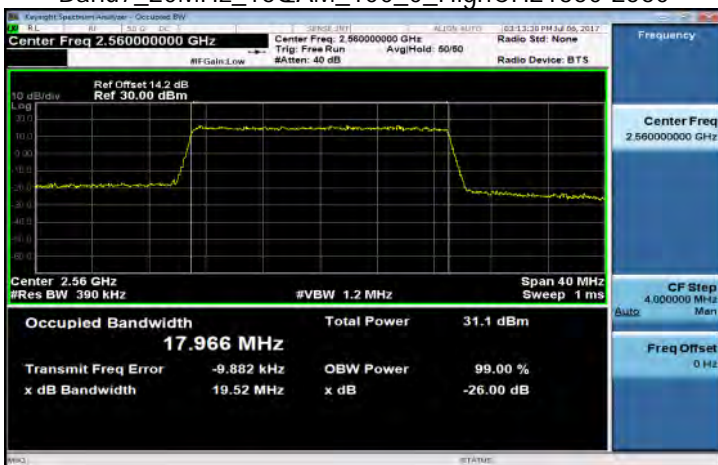

Band12\_1\_4MHz\_QPSK\_6\_0\_HighCH23173-715.3

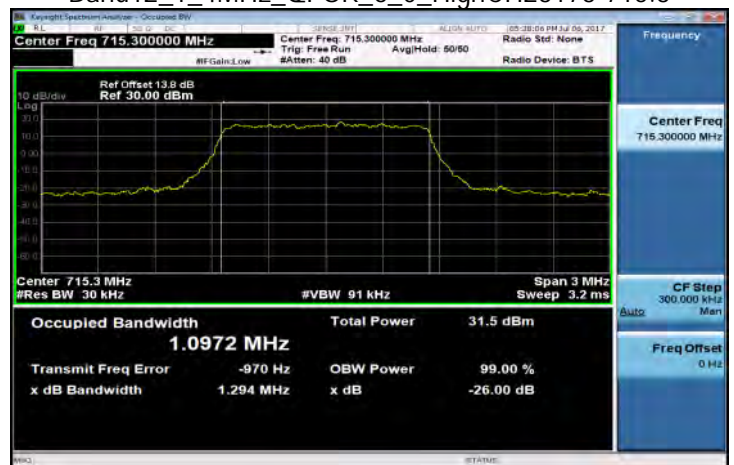

Unless otherwise stated the results shown in this test report refer only to the sample(s) tested and such sample(s) are retained for 90 days only.

除非另有說明，此報告結果僅對測試之樣品負責，同時此樣品僅保留90天。本報告未經本公司書面許可，不可部份複製。

This document is issued by the Company subject to its General Conditions of Service printed overleaf, available on request or accessible at [www.sgs.com/terms\\_and\\_conditions.htm](http://www.sgs.com/terms_and_conditions.htm) and, for electronic format documents, subject to Terms and Conditions for Electronic Documents at [www.sgs.com/terms\\_e-document.htm](http://www.sgs.com/terms_e-document.htm). Attention is drawn to the limitation of liability, indemnification and jurisdiction issues defined therein. Any holder of this document is advised that information contained hereon reflects the Company's findings at the time of its intervention only and within the limits of Client's instructions, if any. The Company's sole responsibility is to its Client and this document does not exonerate parties to a transaction from exercising all their rights and obligations under the transaction documents. This document cannot be reproduced except in full, without prior written approval of the Company. Any unauthorized alteration, forgery or falsification of the content or appearance of this document is unlawful and offenders may be prosecuted to the fullest extent of the law.

Band12\_1\_4MHz\_16QAM\_6\_0\_LowCH23017-699.7

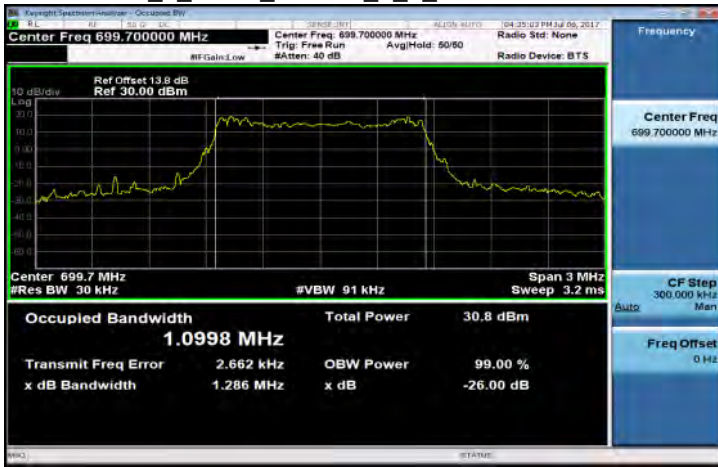

Band12\_3MHz\_QPSK\_15\_0\_LowCH23025-700.5

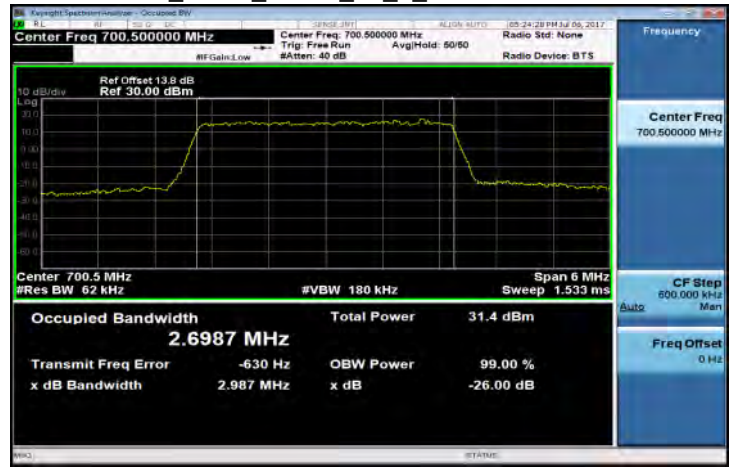

Band12\_1\_4MHz\_16QAM\_6\_0\_MidCH23095-707.5

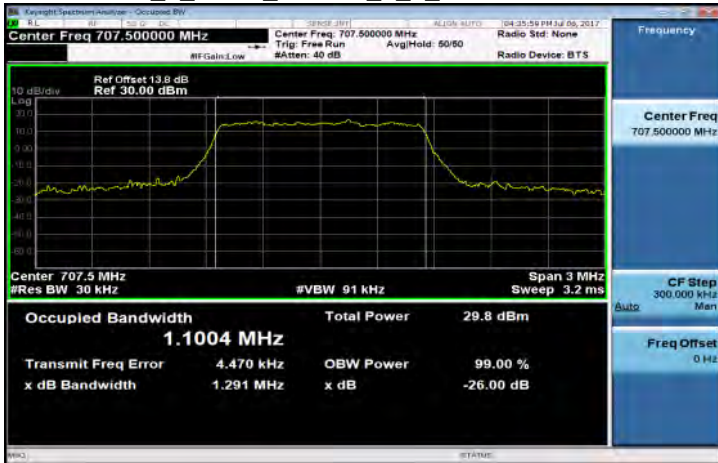

Band12\_3MHz\_QPSK\_15\_0\_MidCH23095-707.5

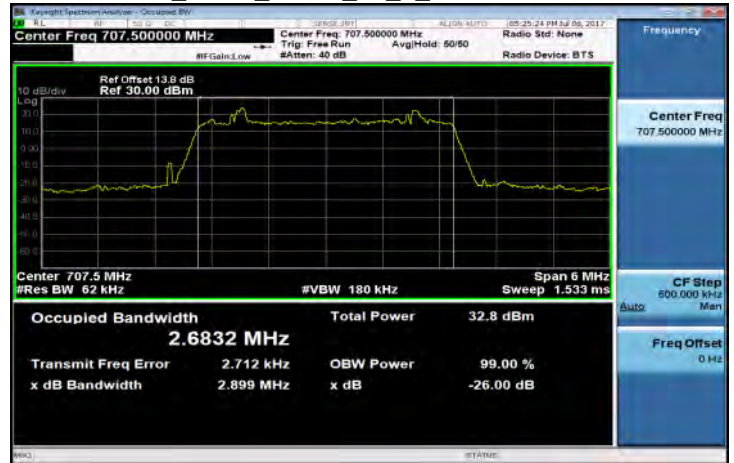

Band12\_1\_4MHz\_16QAM\_6\_0\_HighCH23173-715.3

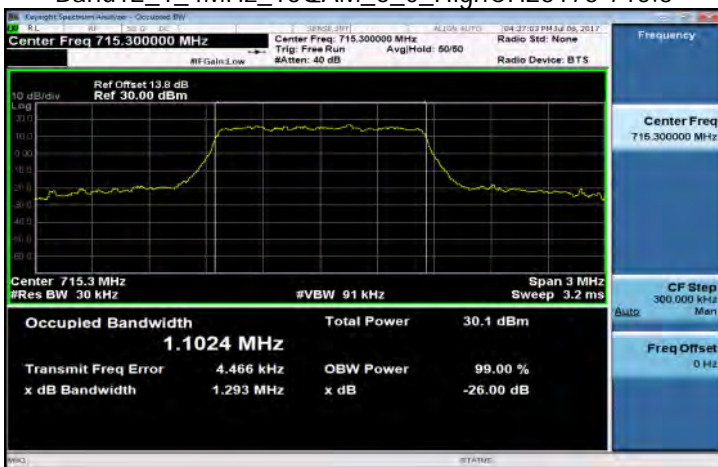

Band12\_3MHz\_QPSK\_15\_0\_HighCH23165-714.5

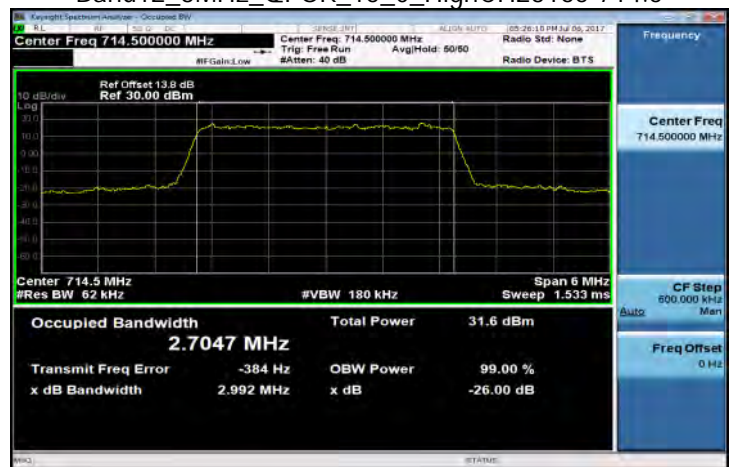

Unless otherwise stated the results shown in this test report refer only to the sample(s) tested and such sample(s) are retained for 90 days only.

除非另有說明，此報告結果僅對測試之樣品負責，同時此樣品僅保留90天。本報告未經本公司書面許可，不可部份複製。

This document is issued by the Company subject to its General Conditions of Service printed overleaf, available on request or accessible at [www.sgs.com/terms\\_and\\_conditions.htm](http://www.sgs.com/terms_and_conditions.htm) and, for electronic format documents, subject to Terms and Conditions for Electronic Documents at [www.sgs.com/terms\\_e-document.htm](http://www.sgs.com/terms_e-document.htm). Attention is drawn to the limitation of liability, indemnification and jurisdiction issues defined therein. Any holder of this document is advised that information contained hereon reflects the Company's findings at the time of its intervention only and within the limits of Client's instructions, if any. The Company's sole responsibility is to its Client and this document does not exonerate parties to a transaction from exercising all their rights and obligations under the transaction documents. This document cannot be reproduced except in full, without prior written approval of the Company. Any unauthorized alteration, forgery or falsification of the content or appearance of this document is unlawful and offenders may be prosecuted to the fullest extent of the law.



Band12\_3MHz\_16QAM\_15\_0\_LowCH23025-700.5

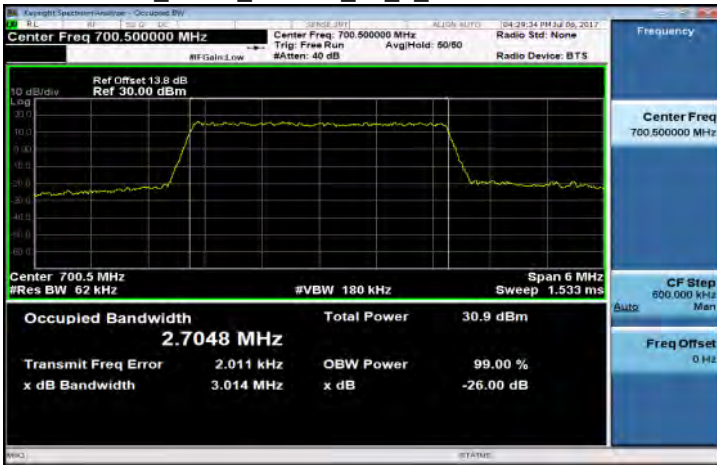

Band12\_5MHz\_QPSK\_25\_0\_LowCH23035-701.5

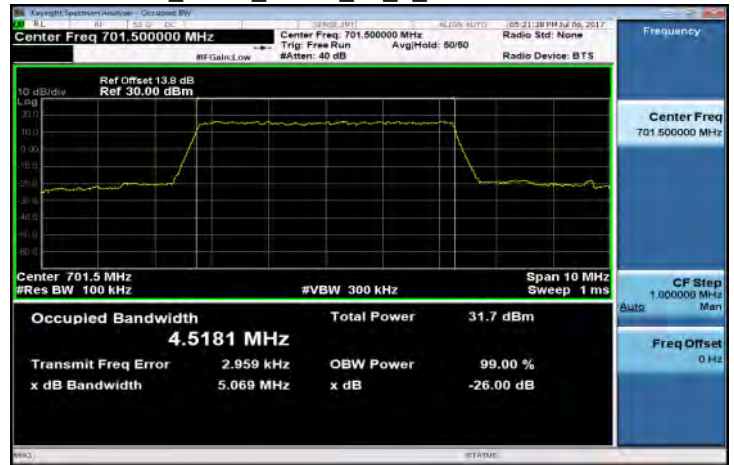

Band12\_3MHz\_16QAM\_15\_0\_MidCH23095-707.5

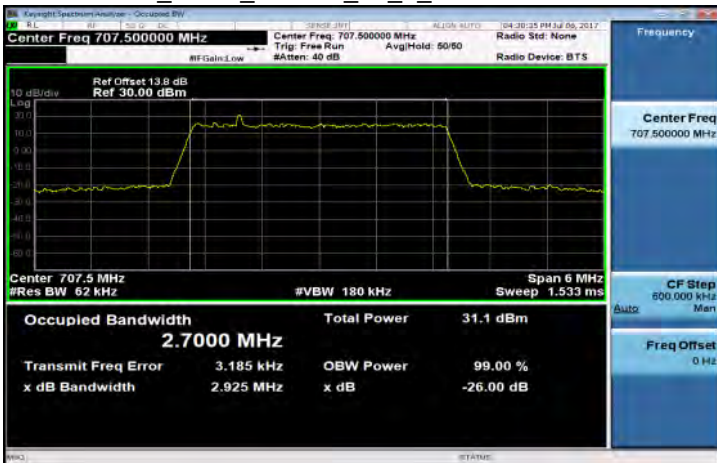

Band12\_5MHz\_QPSK\_25\_0\_MidCH23095-707.5

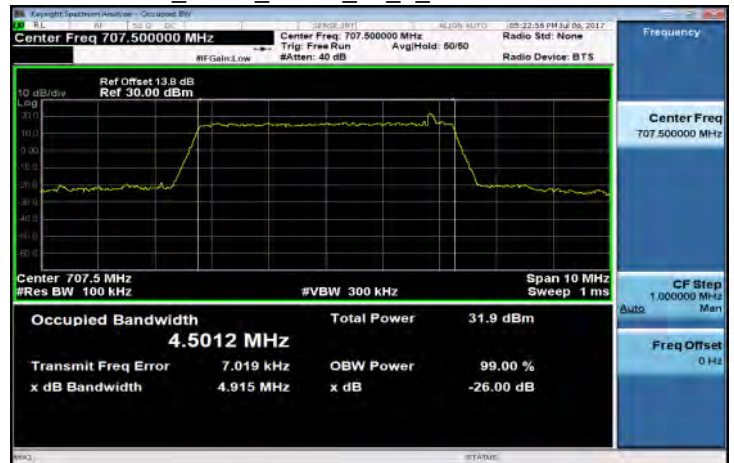

Band12\_3MHz\_16QAM\_15\_0\_HighCH23165-714.5

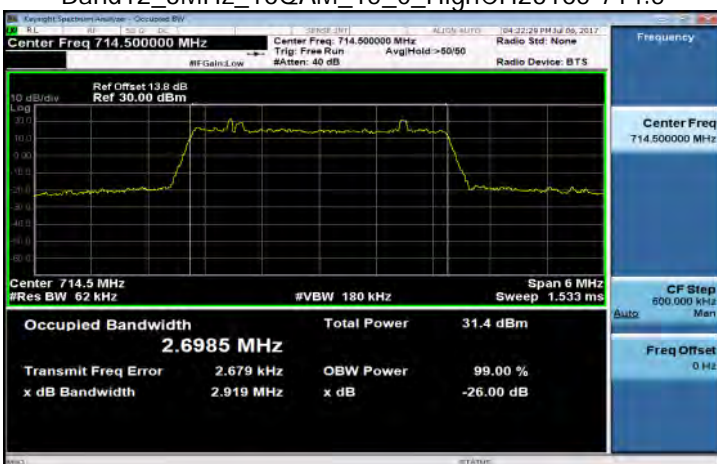

Band12\_5MHz\_QPSK\_25\_0\_HighCH23155-713.5

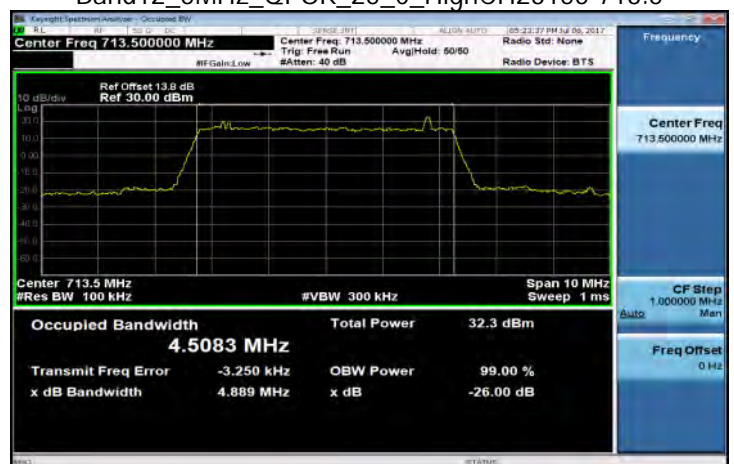

Unless otherwise stated the results shown in this test report refer only to the sample(s) tested and such sample(s) are retained for 90 days only.

除非另有說明，此報告結果僅對測試之樣品負責，同時此樣品僅保留90天。本報告未經本公司書面許可，不可部份複製。

This document is issued by the Company subject to its General Conditions of Service printed overleaf, available on request or accessible at [www.sgs.com/terms\\_and\\_conditions.htm](http://www.sgs.com/terms_and_conditions.htm) and, for electronic format documents, subject to Terms and Conditions for Electronic Documents at [www.sgs.com/terms\\_e-document.htm](http://www.sgs.com/terms_e-document.htm). Attention is drawn to the limitation of liability, indemnification and jurisdiction issues defined therein. Any holder of this document is advised that information contained hereon reflects the Company's findings at the time of its intervention only and within the limits of Client's instructions, if any. The Company's sole responsibility is to its Client and this document does not exonerate parties to a transaction from exercising all their rights and obligations under the transaction documents. This document cannot be reproduced except in full, without prior written approval of the Company. Any unauthorized alteration, forgery or falsification of the content or appearance of this document is unlawful and offenders may be prosecuted to the fullest extent of the law.

Band12\_5MHz\_16QAM\_25\_0\_LowCH23035-701.5

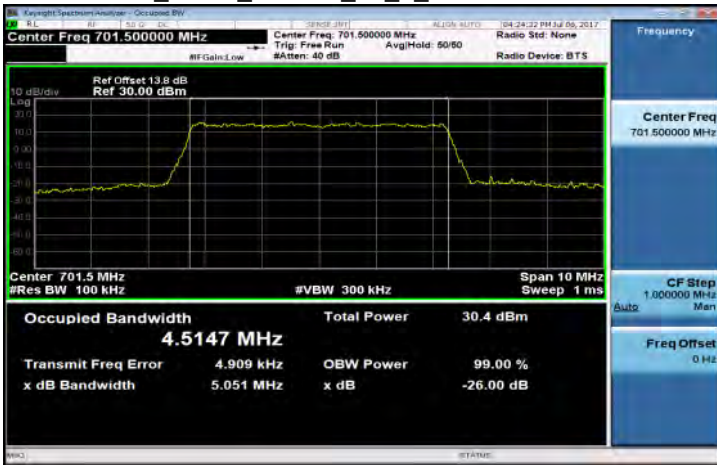

Band12\_10MHz\_QPSK\_50\_0\_LowCH23060-704

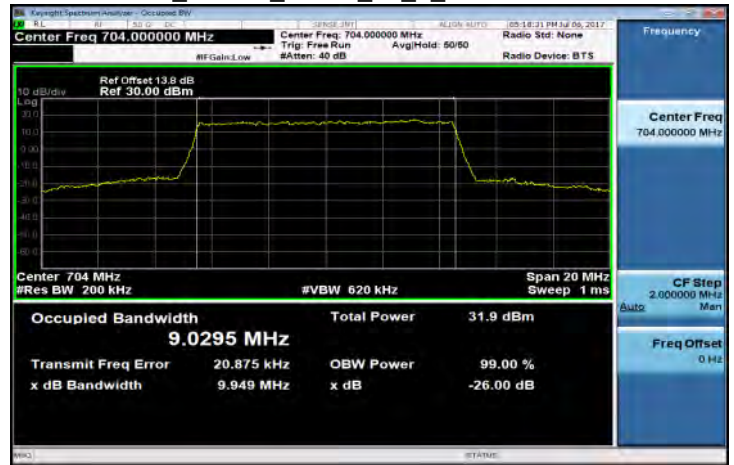

Band12\_5MHz\_16QAM\_25\_0\_MidCH23095-707.5

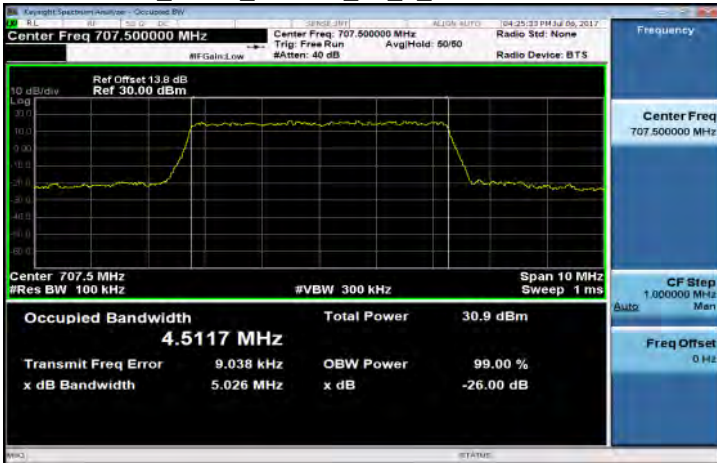

Band12\_10MHz\_QPSK\_50\_0\_MidCH23095-707.5

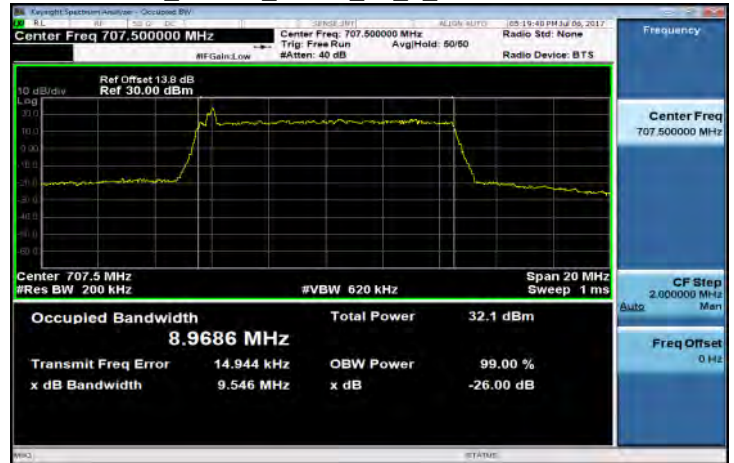

Band12\_5MHz\_16QAM\_25\_0\_HighCH23155-713.5

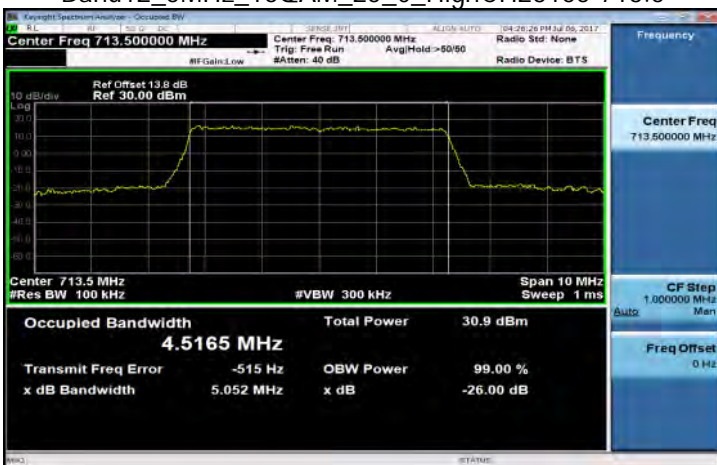

Band12\_10MHz\_QPSK\_50\_0\_HighCH23130-711

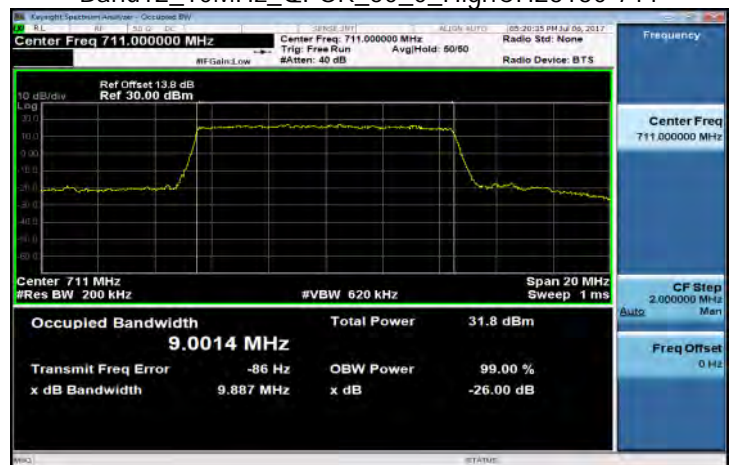

Unless otherwise stated the results shown in this test report refer only to the sample(s) tested and such sample(s) are retained for 90 days only.

除非另有說明，此報告結果僅對測試之樣品負責，同時此樣品僅保留90天。本報告未經本公司書面許可，不可部份複製。

This document is issued by the Company subject to its General Conditions of Service printed overleaf, available on request or accessible at [www.sgs.com/terms\\_and\\_conditions.htm](http://www.sgs.com/terms_and_conditions.htm) and, for electronic format documents, subject to Terms and Conditions for Electronic Documents at [www.sgs.com/terms\\_e-document.htm](http://www.sgs.com/terms_e-document.htm). Attention is drawn to the limitation of liability, indemnification and jurisdiction issues defined therein. Any holder of this document is advised that information contained hereon reflects the Company's findings at the time of its intervention only and within the limits of Client's instructions, if any. The Company's sole responsibility is to its Client and this document does not exonerate parties to a transaction from exercising all their rights and obligations under the transaction documents. This document cannot be reproduced except in full, without prior written approval of the Company. Any unauthorized alteration, forgery or falsification of the content or appearance of this document is unlawful and offenders may be prosecuted to the fullest extent of the law.



Band12\_10MHz\_16QAM\_50\_0\_LowCH23060-704

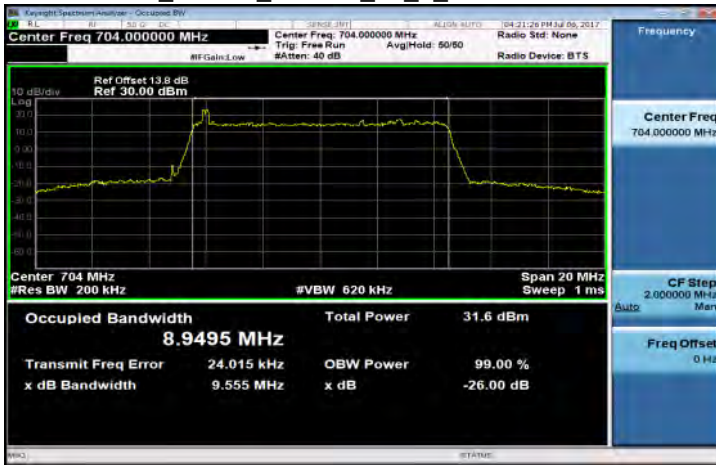

Band17\_5MHz\_QPSK\_25\_0\_LowCH23755-706.5

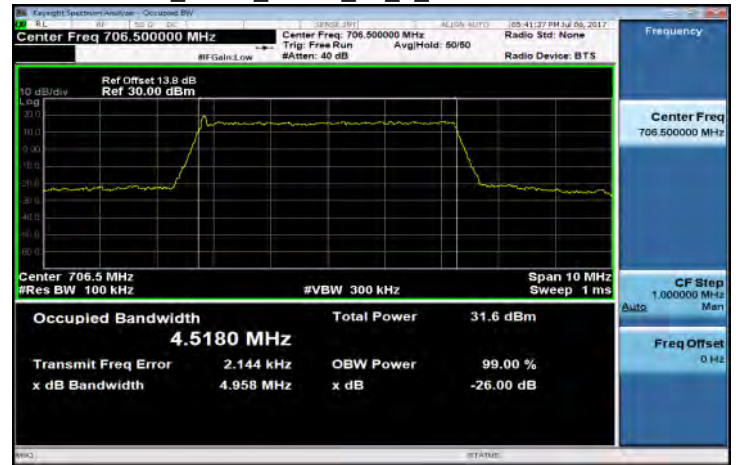

Band12\_10MHz\_16QAM\_50\_0\_MidCH23095-707.5

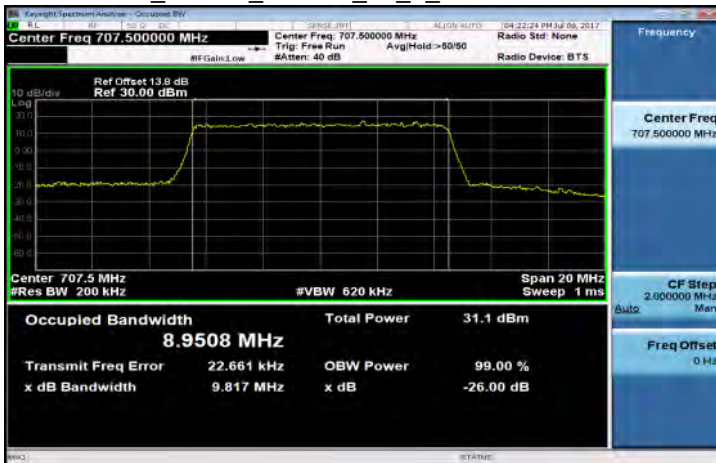

Band17\_5MHz\_QPSK\_25\_0\_MidCH23790-710

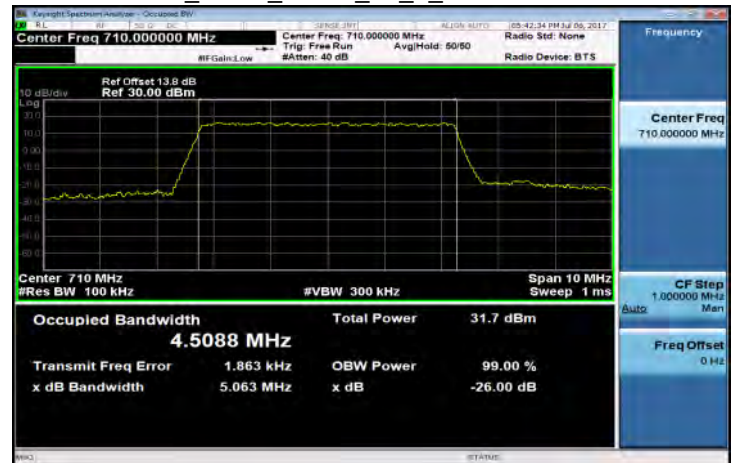

Band12\_10MHz\_16QAM\_50\_0\_HighCH23130-711

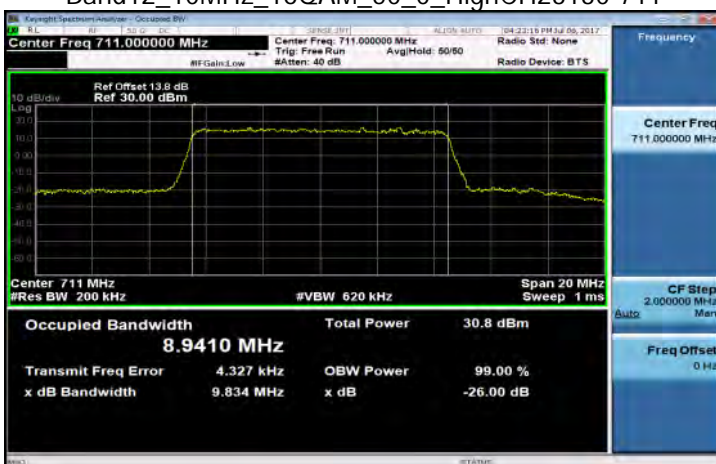

Band17\_5MHz\_QPSK\_25\_0\_HighCH23825-713.5

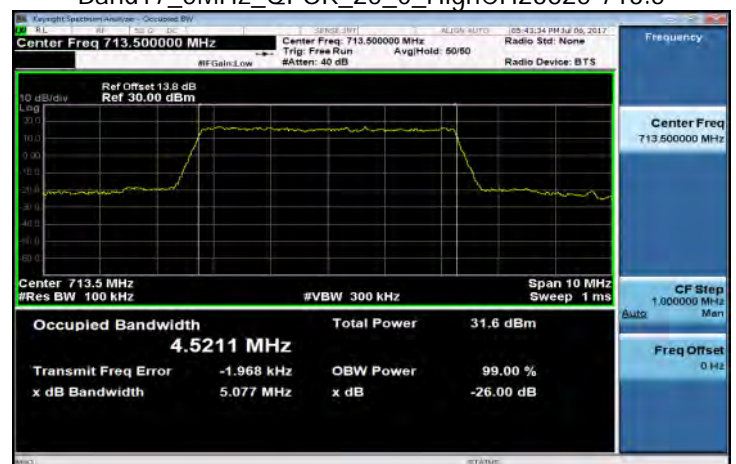

Unless otherwise stated the results shown in this test report refer only to the sample(s) tested and such sample(s) are retained for 90 days only.

除非另有說明，此報告結果僅對測試之樣品負責，同時此樣品僅保留90天。本報告未經本公司書面許可，不可部份複製。

This document is issued by the Company subject to its General Conditions of Service printed overleaf, available on request or accessible at [www.sgs.com/terms\\_and\\_conditions.htm](http://www.sgs.com/terms_and_conditions.htm) and, for electronic format documents, subject to Terms and Conditions for Electronic Documents at [www.sgs.com/terms\\_e-document.htm](http://www.sgs.com/terms_e-document.htm). Attention is drawn to the limitation of liability, indemnification and jurisdiction issues defined therein. Any holder of this document is advised that information contained hereon reflects the Company's findings at the time of its intervention only and within the limits of Client's instructions, if any. The Company's sole responsibility is to its Client and this document does not exonerate parties to a transaction from exercising all their rights and obligations under the transaction documents. This document cannot be reproduced except in full, without prior written approval of the Company. Any unauthorized alteration, forgery or falsification of the content or appearance of this document is unlawful and offenders may be prosecuted to the fullest extent of the law.



Band17\_5MHz\_16QAM\_25\_0\_LowCH23755-706.5

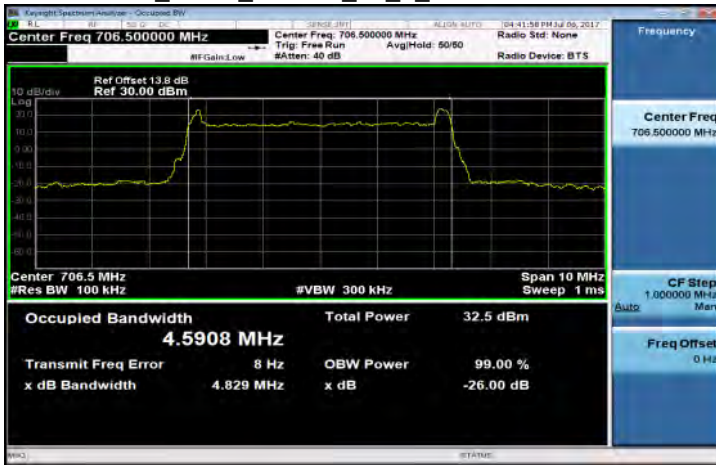

Band17\_10MHz\_QPSK\_50\_0\_LowCH23780-709

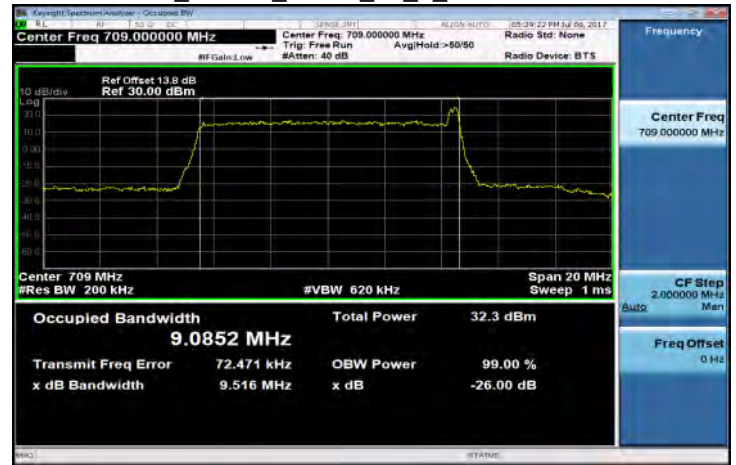

Band17\_5MHz\_16QAM\_25\_0\_MidCH23790-710

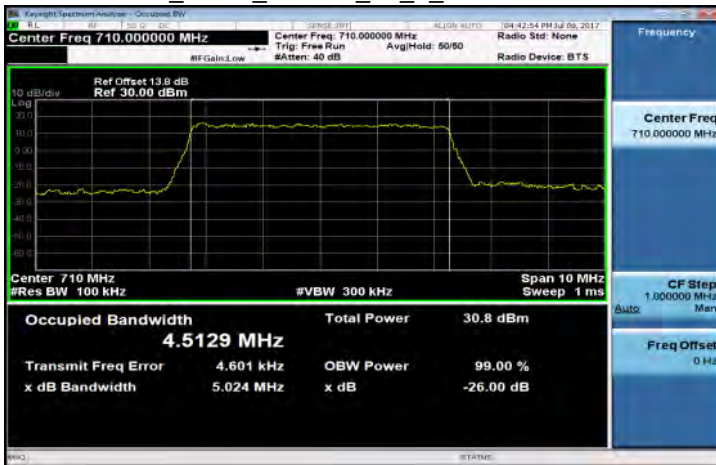

Band17\_10MHz\_QPSK\_50\_0\_MidCH23790-710

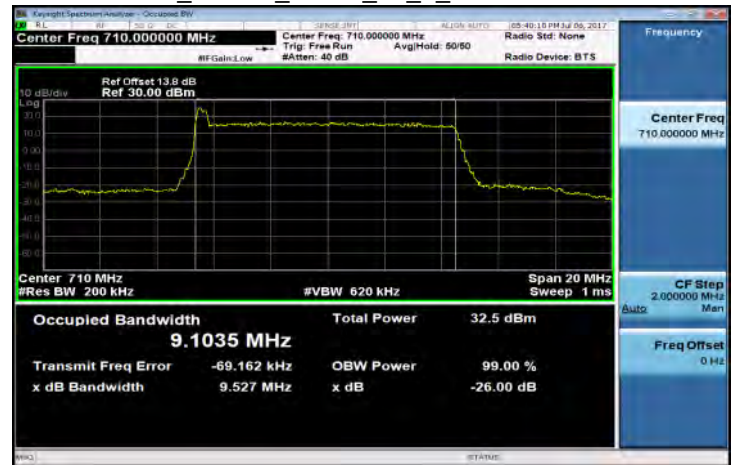

Band17\_5MHz\_16QAM\_25\_0\_HighCH23825-713.5

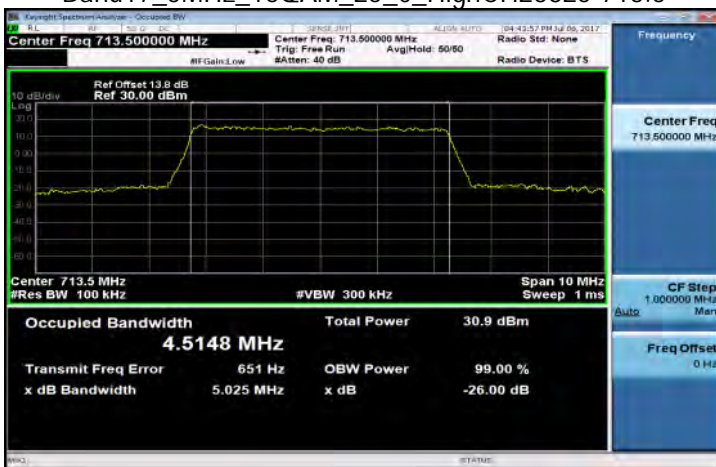

Band17\_10MHz\_QPSK\_50\_0\_HighCH23800-711

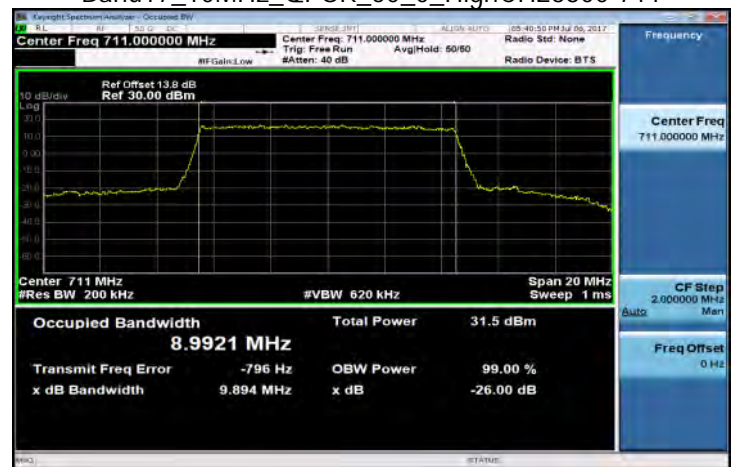

Unless otherwise stated the results shown in this test report refer only to the sample(s) tested and such sample(s) are retained for 90 days only.

除非另有說明，此報告結果僅對測試之樣品負責，同時此樣品僅保留90天。本報告未經本公司書面許可，不可部份複製。

This document is issued by the Company subject to its General Conditions of Service printed overleaf, available on request or accessible at [www.sgs.com/terms\\_and\\_conditions.htm](http://www.sgs.com/terms_and_conditions.htm) and, for electronic format documents, subject to Terms and Conditions for Electronic Documents at [www.sgs.com/terms\\_e-document.htm](http://www.sgs.com/terms_e-document.htm). Attention is drawn to the limitation of liability, indemnification and jurisdiction issues defined therein. Any holder of this document is advised that information contained hereon reflects the Company's findings at the time of its intervention only and within the limits of Client's instructions, if any. The Company's sole responsibility is to its Client and this document does not exonerate parties to a transaction from exercising all their rights and obligations under the transaction documents. This document cannot be reproduced except in full, without prior written approval of the Company. Any unauthorized alteration, forgery or falsification of the content or appearance of this document is unlawful and offenders may be prosecuted to the fullest extent of the law.

Band17\_10MHz\_16QAM\_50\_0\_LowCH23780-709

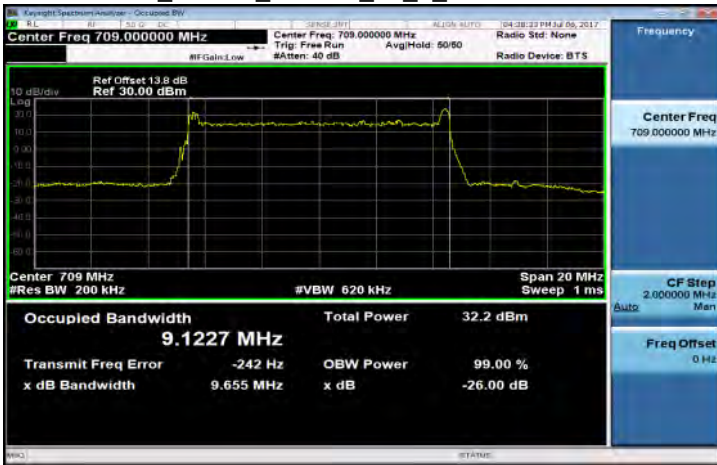

Band38\_5MHz\_QPSK\_25\_0\_LowCH37775-2572.5

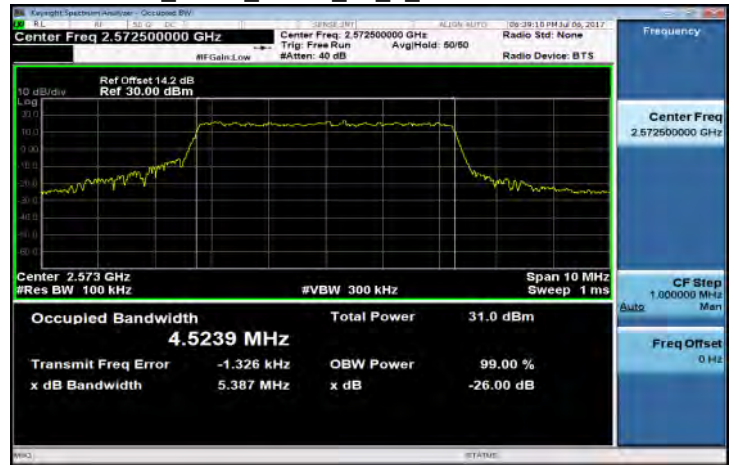

Band17\_10MHz\_16QAM\_50\_0\_MidCH23790-710

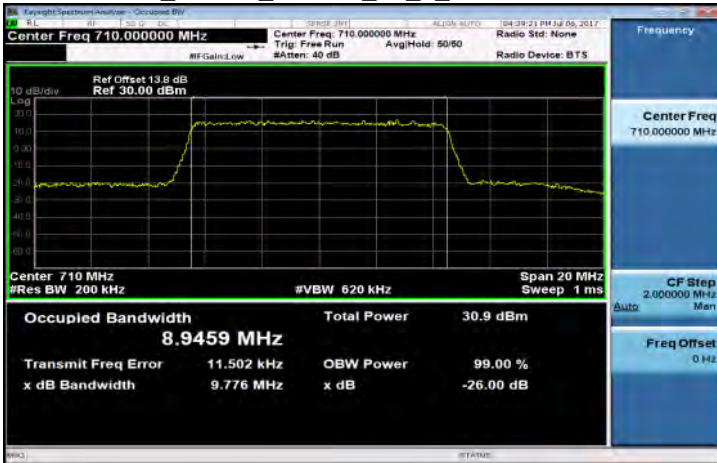

Band38\_5MHz\_QPSK\_25\_0\_MidCH38000-2595

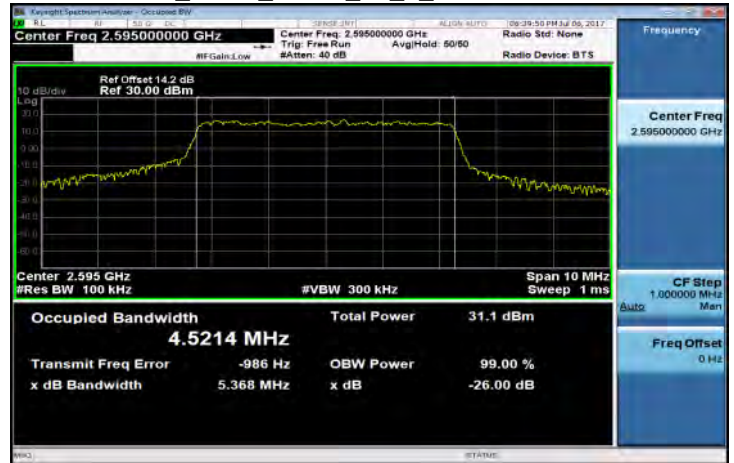

Band17\_10MHz\_16QAM\_50\_0\_HighCH23800-711

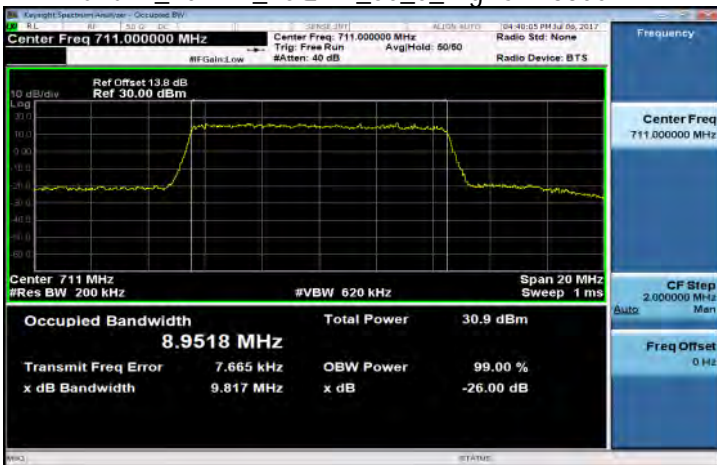

Band38\_5MHz\_QPSK\_25\_0\_HighCH38225-2617.5

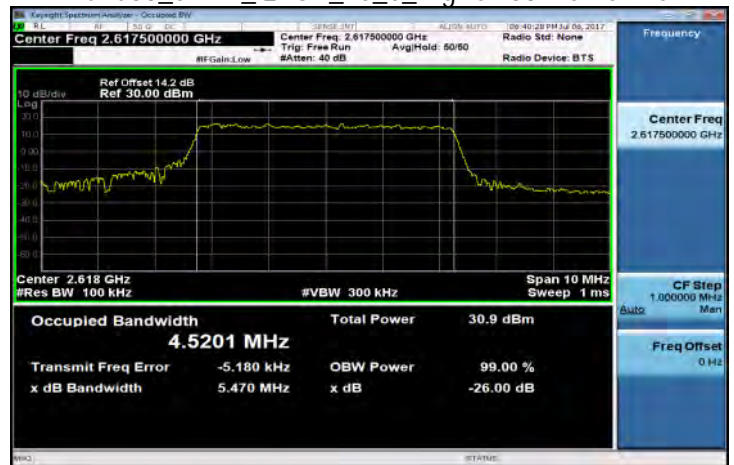

Unless otherwise stated the results shown in this test report refer only to the sample(s) tested and such sample(s) are retained for 90 days only.

除非另有說明，此報告結果僅對測試之樣品負責，同時此樣品僅保留90天。本報告未經本公司書面許可，不可部份複製。

This document is issued by the Company subject to its General Conditions of Service printed overleaf, available on request or accessible at [www.sgs.com/terms\\_and\\_conditions.htm](http://www.sgs.com/terms_and_conditions.htm) and, for electronic format documents, subject to Terms and Conditions for Electronic Documents at [www.sgs.com/terms\\_e-document.htm](http://www.sgs.com/terms_e-document.htm). Attention is drawn to the limitation of liability, indemnification and jurisdiction issues defined therein. Any holder of this document is advised that information contained hereon reflects the Company's findings at the time of its intervention only and within the limits of Client's instructions, if any. The Company's sole responsibility is to its Client and this document does not exonerate parties to a transaction from exercising all their rights and obligations under the transaction documents. This document cannot be reproduced except in full, without prior written approval of the Company. Any unauthorized alteration, forgery or falsification of the content or appearance of this document is unlawful and offenders may be prosecuted to the fullest extent of the law.



Band38\_5MHz\_16QAM\_25\_0\_LowCH37775-2572.5

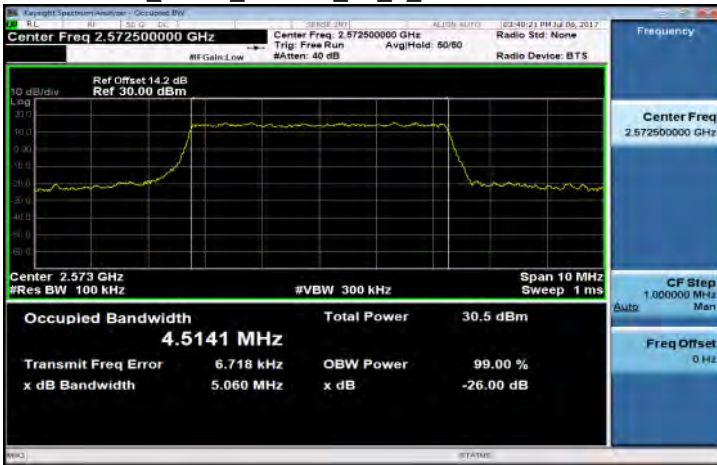

Band38\_10MHz\_QPSK\_50\_0\_LowCH37800-2575

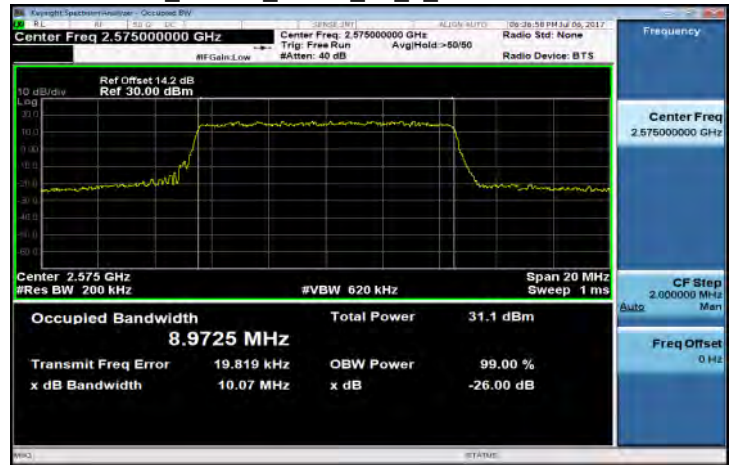

Band38\_5MHz\_16QAM\_25\_0\_MidCH38000-2595

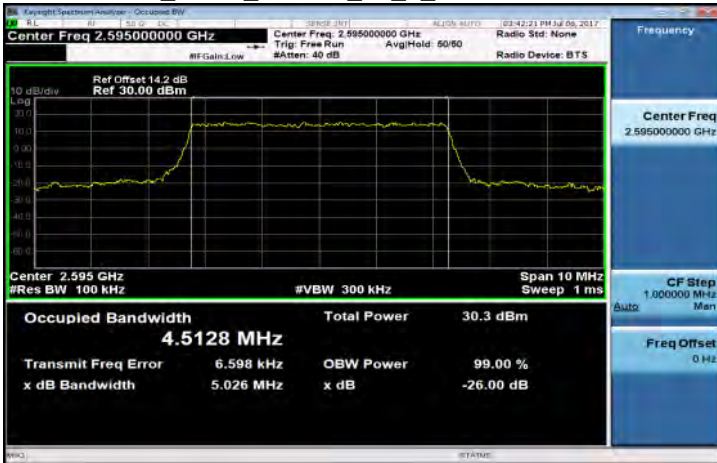

Band38\_10MHz\_QPSK\_50\_0\_MidCH38000-2595

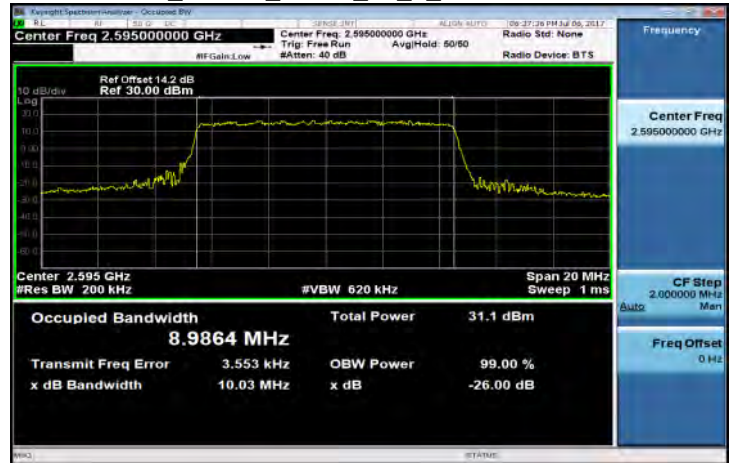

Band38\_5MHz\_16QAM\_25\_0\_HighCH38225-2617.5

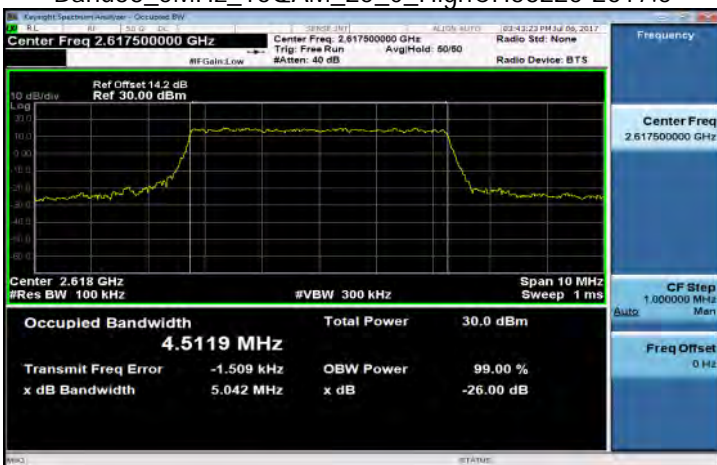

Band38\_10MHz\_QPSK\_50\_0\_HighCH38200-2615

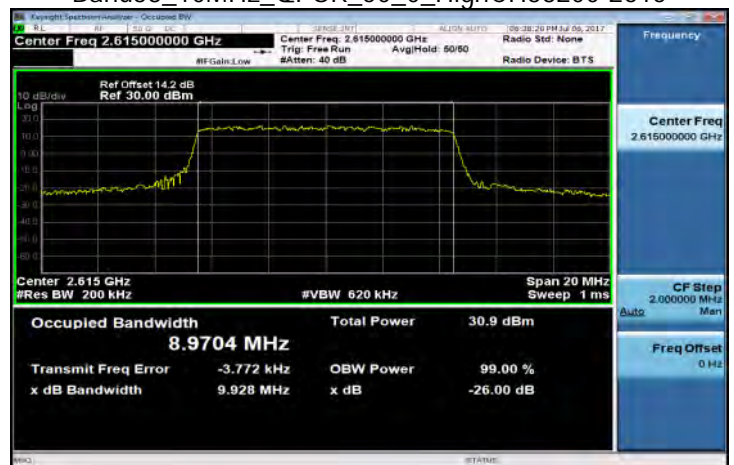

Unless otherwise stated the results shown in this test report refer only to the sample(s) tested and such sample(s) are retained for 90 days only.

除非另有說明，此報告結果僅對測試之樣品負責，同時此樣品僅保留90天。本報告未經本公司書面許可，不可部份複製。

This document is issued by the Company subject to its General Conditions of Service printed overleaf, available on request or accessible at [www.sgs.com/terms\\_and\\_conditions.htm](http://www.sgs.com/terms_and_conditions.htm) and, for electronic format documents, subject to Terms and Conditions for Electronic Documents at [www.sgs.com/terms\\_e-document.htm](http://www.sgs.com/terms_e-document.htm). Attention is drawn to the limitation of liability, indemnification and jurisdiction issues defined therein. Any holder of this document is advised that information contained hereon reflects the Company's findings at the time of its intervention only and within the limits of Client's instructions, if any. The Company's sole responsibility is to its Client and this document does not exonerate parties to a transaction from exercising all their rights and obligations under the transaction documents. This document cannot be reproduced except in full, without prior written approval of the Company. Any unauthorized alteration, forgery or falsification of the content or appearance of this document is unlawful and offenders may be prosecuted to the fullest extent of the law.



Band38\_10MHz\_16QAM\_50\_0\_LowCH37800-2575

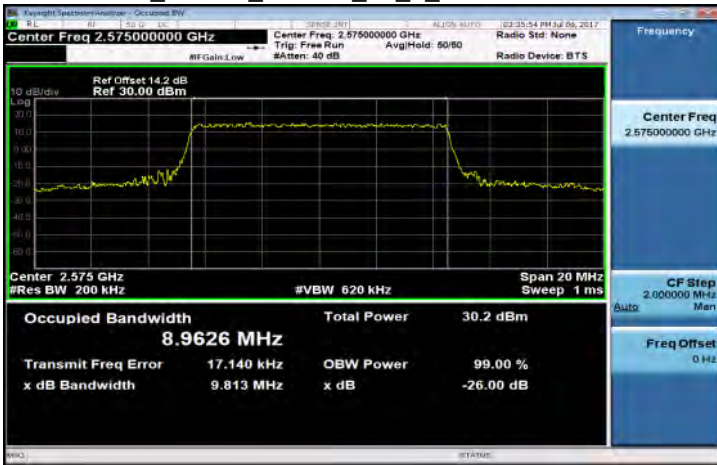

Band38\_15MHz\_QPSK\_75\_0\_LowCH37825-2577.5

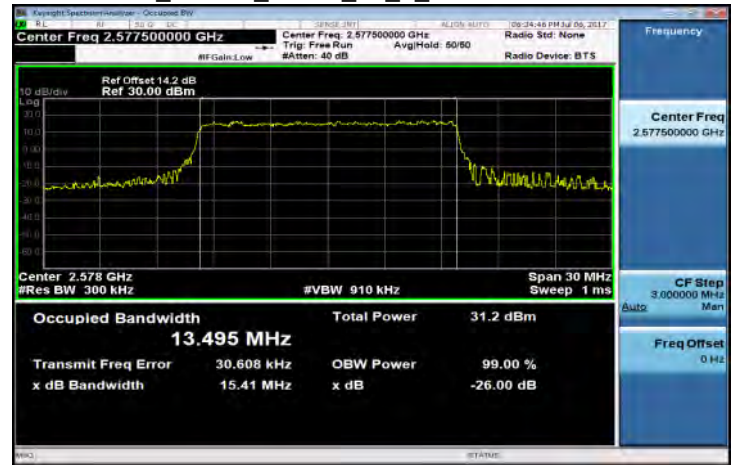

Band38\_10MHz\_16QAM\_50\_0\_MidCH38000-2595

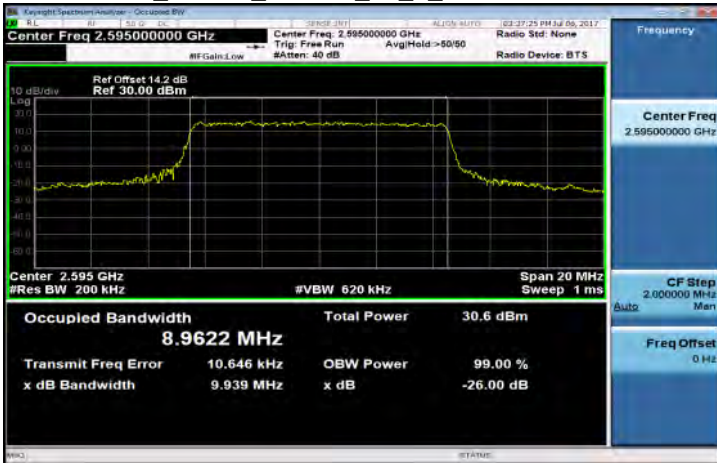

Band38\_15MHz\_QPSK\_75\_0\_MidCH38000-2595

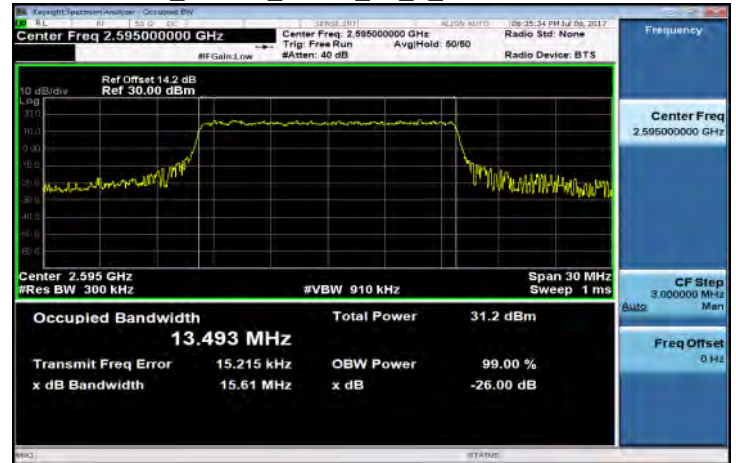

Band38\_10MHz\_16QAM\_50\_0\_HighCH38200-2615

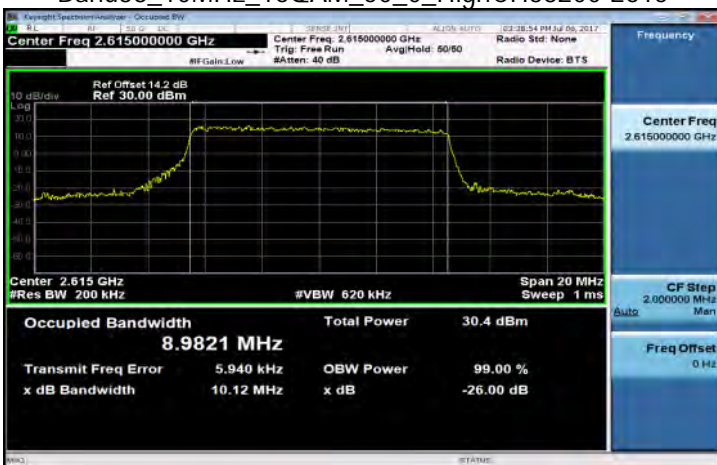

Band38\_15MHz\_QPSK\_75\_0\_HighCH38175-2612.5

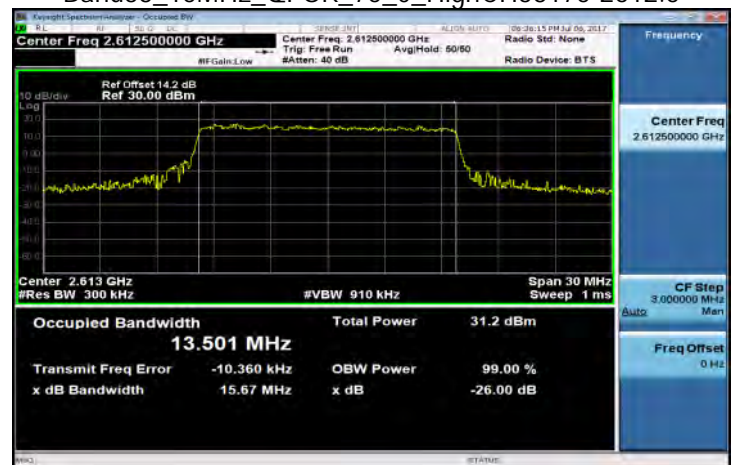

Unless otherwise stated the results shown in this test report refer only to the sample(s) tested and such sample(s) are retained for 90 days only.

除非另有說明，此報告結果僅對測試之樣品負責，同時此樣品僅保留90天。本報告未經本公司書面許可，不可部份複製。

This document is issued by the Company subject to its General Conditions of Service printed overleaf, available on request or accessible at [www.sgs.com/terms\\_and\\_conditions.htm](http://www.sgs.com/terms_and_conditions.htm) and, for electronic format documents, subject to Terms and Conditions for Electronic Documents at [www.sgs.com/terms\\_e-document.htm](http://www.sgs.com/terms_e-document.htm). Attention is drawn to the limitation of liability, indemnification and jurisdiction issues defined therein. Any holder of this document is advised that information contained hereon reflects the Company's findings at the time of its intervention only and within the limits of Client's instructions, if any. The Company's sole responsibility is to its Client and this document does not exonerate parties to a transaction from exercising all their rights and obligations under the transaction documents. This document cannot be reproduced except in full, without prior written approval of the Company. Any unauthorized alteration, forgery or falsification of the content or appearance of this document is unlawful and offenders may be prosecuted to the fullest extent of the law.



Band38\_15MHz\_16QAM\_75\_0\_LowCH37825-2577.5

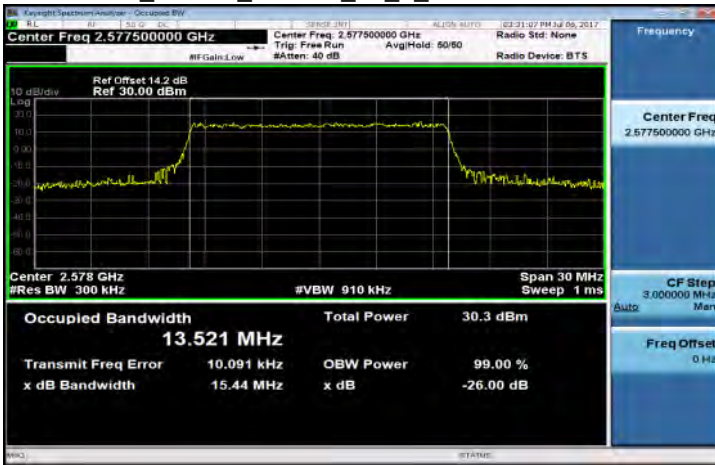

Band38\_20MHz\_QPSK\_100\_0\_LowCH37850-2580

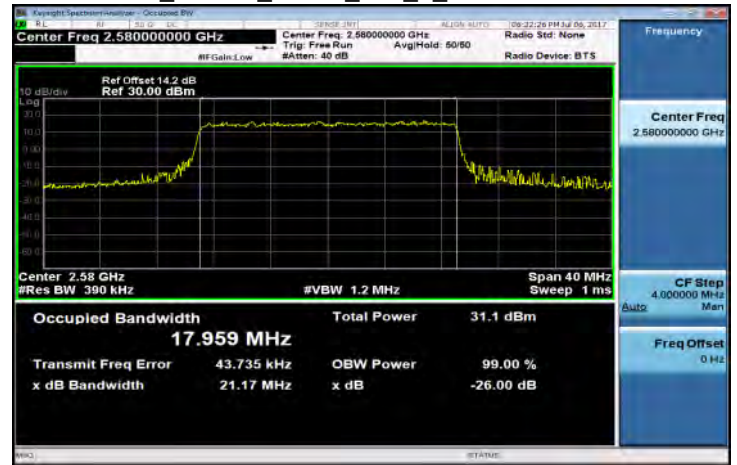

Band38\_15MHz\_16QAM\_75\_0\_MidCH38000-2595

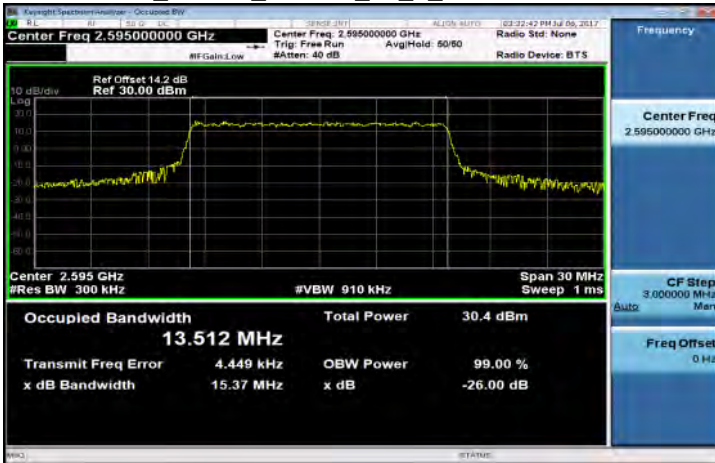

Band38\_20MHz\_QPSK\_100\_0\_MidCH38000-2595

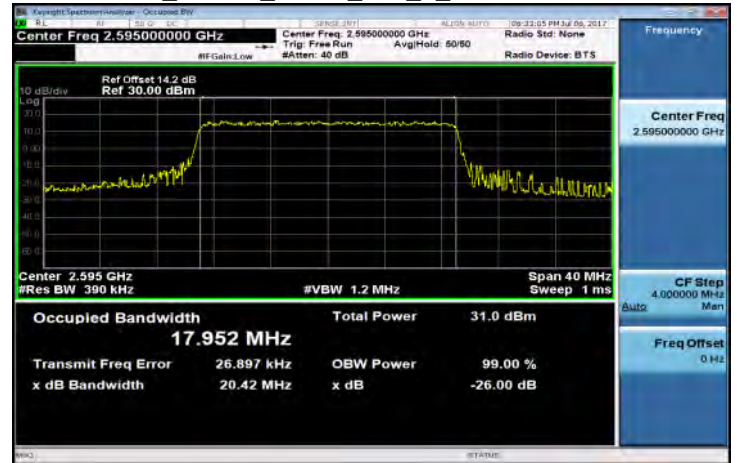

Band38\_15MHz\_16QAM\_75\_0\_HighCH38175-2612.5

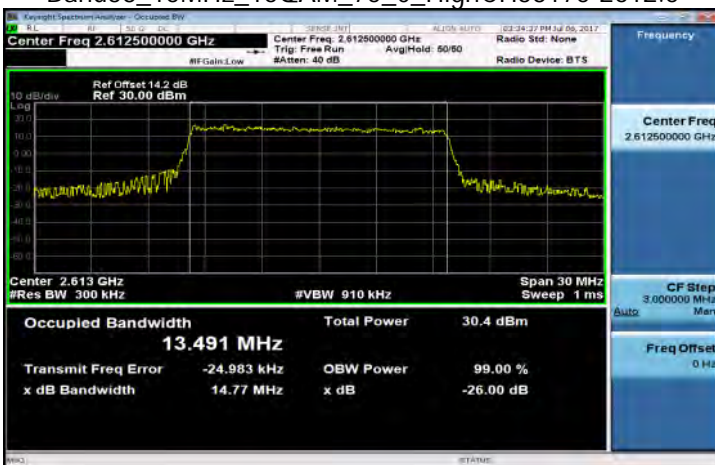

Band38\_20MHz\_QPSK\_100\_0\_HighCH38150-2610

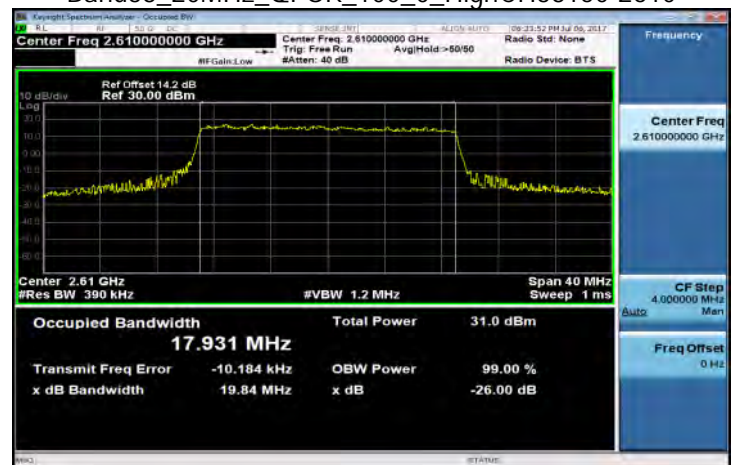

Unless otherwise stated the results shown in this test report refer only to the sample(s) tested and such sample(s) are retained for 90 days only.

除非另有說明，此報告結果僅對測試之樣品負責，同時此樣品僅保留90天。本報告未經本公司書面許可，不可部份複製。

This document is issued by the Company subject to its General Conditions of Service printed overleaf, available on request or accessible at [www.sgs.com/terms\\_and\\_conditions.htm](http://www.sgs.com/terms_and_conditions.htm) and, for electronic format documents, subject to Terms and Conditions for Electronic Documents at [www.sgs.com/terms\\_e-document.htm](http://www.sgs.com/terms_e-document.htm). Attention is drawn to the limitation of liability, indemnification and jurisdiction issues defined therein. Any holder of this document is advised that information contained hereon reflects the Company's findings at the time of its intervention only and within the limits of Client's instructions, if any. The Company's sole responsibility is to its Client and this document does not exonerate parties to a transaction from exercising all their rights and obligations under the transaction documents. This document cannot be reproduced except in full, without prior written approval of the Company. Any unauthorized alteration, forgery or falsification of the content or appearance of this document is unlawful and offenders may be prosecuted to the fullest extent of the law.

Band38\_20MHz\_16QAM\_100\_0\_LowCH37850-2580

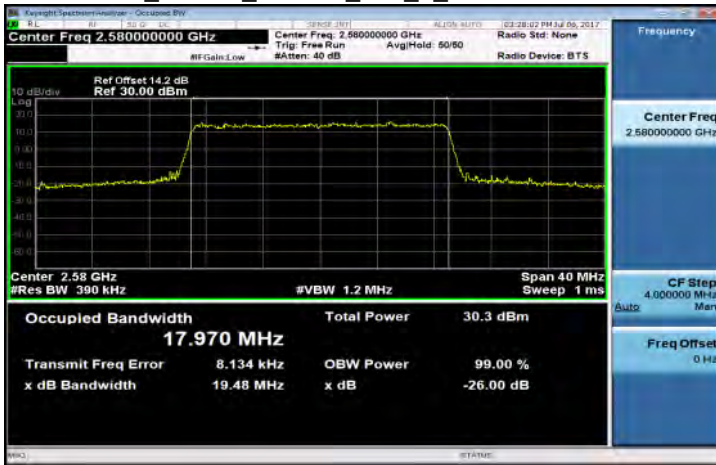

Band38\_20MHz\_16QAM\_100\_0\_HighCH38150-2610

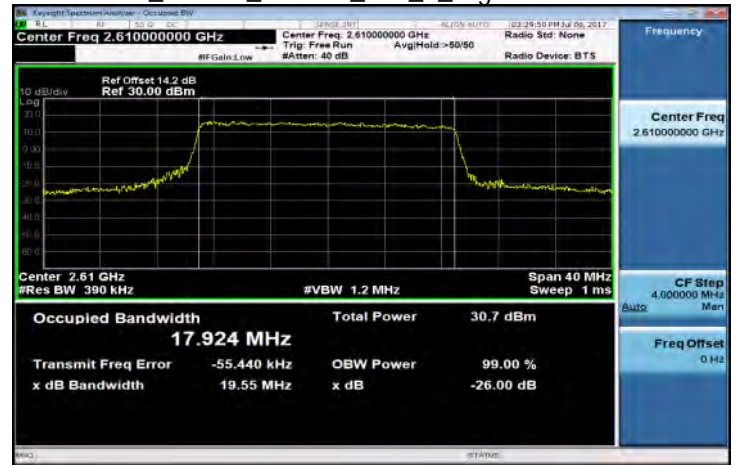

Band38\_20MHz\_16QAM\_100\_0\_MidCH38000-2595

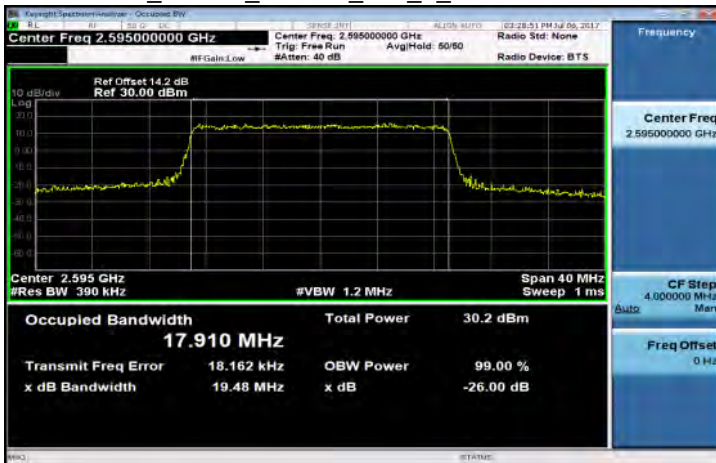

Unless otherwise stated the results shown in this test report refer only to the sample(s) tested and such sample(s) are retained for 90 days only.

除非另有說明，此報告結果僅對測試之樣品負責，同時此樣品僅保留90天。本報告未經本公司書面許可，不可部份複製。

This document is issued by the Company subject to its General Conditions of Service printed overleaf, available on request or accessible at [www.sgs.com/terms\\_and\\_conditions.htm](http://www.sgs.com/terms_and_conditions.htm) and, for electronic format documents, subject to Terms and Conditions for Electronic Documents at [www.sgs.com/terms\\_e-document.htm](http://www.sgs.com/terms_e-document.htm). Attention is drawn to the limitation of liability, indemnification and jurisdiction issues defined therein. Any holder of this document is advised that information contained hereon reflects the Company's findings at the time of its intervention only and within the limits of Client's instructions, if any. The Company's sole responsibility is to its Client and this document does not exonerate parties to a transaction from exercising all their rights and obligations under the transaction documents. This document cannot be reproduced except in full, without prior written approval of the Company. Any unauthorized alteration, forgery or falsification of the content or appearance of this document is unlawful and offenders may be prosecuted to the fullest extent of the law.

## 9. OUT OF BAND EMISSION AT ANTENNA TERMINALS

### 9.1. Standard Applicable

FCC §22.917(a), §24.238(a), §27.53(g)(h), the magnitude of each spurious and harmonic emission that can be detected when the equipment is operated under the conditions specified in the instruction manual and/ or alignment procedure, shall not be less than  $43 + 10 \log$  (mean output power in watts) dBc below the mean power output outside a license's frequency block (-13dBm).

§27.53 (m) (4) shall not be less than  $55 + 10 \log$ (mean output power in watt) dBc below the mean power output outside a license's frequency block (-25dBm).

#### FCC §27.53(g)

Compliance with this provision is based on the use of measurement instrumentation employing a resolution bandwidth of 100 kilohertz or greater. However, in the 100 kilohertz bands immediately outside and adjacent to a licensee's frequency block, a resolution bandwidth of at least 30 kHz may be employed.

#### FCC §27.53(h)

Compliance with this provision is based on the use of measurement instrumentation employing a resolution bandwidth of 1 megahertz or greater. However, in the 1 megahertz bands immediately outside and adjacent to the licensee's frequency block, a resolution bandwidth of at least one percent of the emission bandwidth of the fundamental emission of the transmitter may be employed. The emission bandwidth is defined as the width of the signal between two points, one below the carrier center frequency and one above the carrier center frequency, outside of which all emissions are attenuated at least 26 dB below the transmitter power.

Unless otherwise stated the results shown in this test report refer only to the sample(s) tested and such sample(s) are retained for 90 days only.

除非另有說明，此報告結果僅對測試之樣品負責，同時此樣品僅保留90天。本報告未經本公司書面許可，不可部份複製。

This document is issued by the Company subject to its General Conditions of Service printed overleaf, available on request or accessible at [www.sgs.com/terms\\_and\\_conditions.htm](http://www.sgs.com/terms_and_conditions.htm) and, for electronic format documents, subject to Terms and Conditions for Electronic Documents at [www.sgs.com/terms\\_e-document.htm](http://www.sgs.com/terms_e-document.htm). Attention is drawn to the limitation of liability, indemnification and jurisdiction issues defined therein. Any holder of this document is advised that information contained hereon reflects the Company's findings at the time of its intervention only and within the limits of Client's instructions, if any. The Company's sole responsibility is to its Client and this document does not exonerate parties to a transaction from exercising all their rights and obligations under the transaction documents. This document cannot be reproduced except in full, without prior written approval of the Company. Any unauthorized alteration, forgery or falsification of the content or appearance of this document is unlawful and offenders may be prosecuted to the fullest extent of the law.

SGS Taiwan Ltd.

台灣檢驗科技股份有限公司

No.134,WuKungRoad,NewTaipeiIndustrialPark,WukuDistrict,NewTaipeiCity,Taiwan24803/新北市五股區新北產業園區五工路 134 號

t (886-2) 2299-3279

f (886-2) 2298-0488

[www.tw.sgs.com](http://www.tw.sgs.com)

Member of SGS Group



FCC §27.53(m) (4) (6)

For mobile digital stations, the attenuation factor shall be not less than  $40 + 10 \log (P)$  dB on all frequencies between the channel edge and 5 megahertz from the channel edge,  $43 + 10 \log (P)$  dB on all frequencies between 5 megahertz and X megahertz from the channel edge, and  $55 + 10 \log (P)$  dB on all frequencies more than X megahertz from the channel edge, where X is the greater of 6 megahertz or the actual emission bandwidth as defined in § 27.53(m)(6). In addition, the attenuation factor shall not be less that  $43 + 10 \log (P)$  dB on all frequencies between 2490.5 MHz and 2496 MHz and  $55 + 10 \log (P)$  dB at or below 2490.5 MHz.

Measurement procedure. Compliance with these rules is based on the use of measurement instrumentation employing a resolution bandwidth of 1 megahertz or greater. However, in the 1 MHz bands immediately outside and adjacent to the frequency block a resolution bandwidth of at least one percent of the emission bandwidth of the fundamental emission of the transmitter may be employed; for mobile digital stations, in the 1 megahertz bands immediately outside and adjacent to the frequency block a resolution bandwidth of at least two percent may be employed, except when the 1 megahertz band is 2495-2496 MHz, in which case a resolution bandwidth of at least one percent may be employed. A narrower resolution bandwidth is permitted in all cases to improve measurement accuracy provided the measured power is integrated over the full required measurement bandwidth (i.e. 1 megahertz or 1 percent of emission bandwidth, as specified; or 1 megahertz or 2 percent for mobile digital stations, except in the band 2495-2496 MHz). The emission bandwidth is defined as the width of the signal between two points, one below the carrier center frequency and one above the carrier center frequency, outside of which all emissions are attenuated at least 26 dB below the transmitter power. With respect to television operations, measurements must be made of the separate visual and aural operating powers at sufficiently frequent intervals to ensure compliance with the rules.

9.2. Test SET-UP

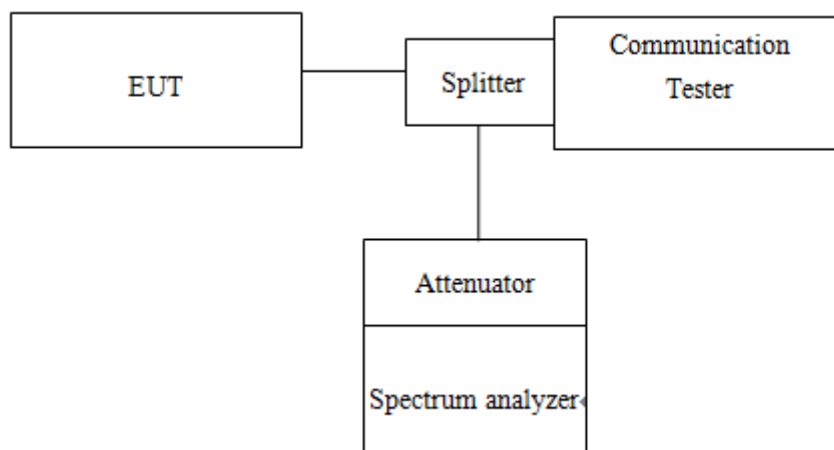

Unless otherwise stated the results shown in this test report refer only to the sample(s) tested and such sample(s) are retained for 90 days only.

除非另有說明，此報告結果僅對測試之樣品負責，同時此樣品僅保留90天。本報告未經本公司書面許可，不可部份複製。

This document is issued by the Company subject to its General Conditions of Service printed overleaf, available on request or accessible at [www.sgs.com/terms\\_and\\_conditions.htm](http://www.sgs.com/terms_and_conditions.htm) and, for electronic format documents, subject to Terms and Conditions for Electronic Documents at [www.sgs.com/terms\\_e-document.htm](http://www.sgs.com/terms_e-document.htm). Attention is drawn to the limitation of liability, indemnification and jurisdiction issues defined therein. Any holder of this document is advised that information contained hereon reflects the Company's findings at the time of its intervention only and within the limits of Client's instructions, if any. The Company's sole responsibility is to its Client and this document does not exonerate parties to a transaction from exercising all their rights and obligations under the transaction documents. This document cannot be reproduced except in full, without prior written approval of the Company. Any unauthorized alteration, forgery or falsification of the content or appearance of this document is unlawful and offenders may be prosecuted to the fullest extent of the law.



### 9.3. Measurement Procedure

#### Conducted Emission

The RF output of the transceiver was connected to a spectrum analyzer through appropriate attenuation. The resolution bandwidth of the spectrum analyzer was set at 1MHz, sufficient scans were taken to show the out of band Emissions if any up to 10th harmonic.

1. To connect Antenna Port of EUT to Spectrum.
2. Set RBW = 1MHz & VBW = 1MHz on Spectrum.
3. Allow trace to fully stabilize
4. Repeat above procedures until all default test channel measured were complete.

#### Band Edge

1. To connect Antenna Port of EUT to Spectrum.
2. The band edge of low and high channels for the highest RF powers was measured. Setting RBW  $\geq$  1% EBW.
3. Allow trace to fully stabilize
4. Repeat above procedures until all default test channel measured were complete.

Unless otherwise stated the results shown in this test report refer only to the sample(s) tested and such sample(s) are retained for 90 days only.

除非另有說明，此報告結果僅對測試之樣品負責，同時此樣品僅保留90天。本報告未經本公司書面許可，不可部份複製。

This document is issued by the Company subject to its General Conditions of Service printed overleaf, available on request or accessible at [www.sgs.com/terms\\_and\\_conditions.htm](http://www.sgs.com/terms_and_conditions.htm) and, for electronic format documents, subject to Terms and Conditions for Electronic Documents at [www.sgs.com/terms\\_e-document.htm](http://www.sgs.com/terms_e-document.htm). Attention is drawn to the limitation of liability, indemnification and jurisdiction issues defined therein. Any holder of this document is advised that information contained hereon reflects the Company's findings at the time of its intervention only and within the limits of Client's instructions, if any. The Company's sole responsibility is to its Client and this document does not exonerate parties to a transaction from exercising all their rights and obligations under the transaction documents. This document cannot be reproduced except in full, without prior written approval of the Company. Any unauthorized alteration, forgery or falsification of the content or appearance of this document is unlawful and offenders may be prosecuted to the fullest extent of the law.

SGS Taiwan Ltd.

No.134,WuKungRoad,NewTaipeiIndustrialPark,WukuDistrict,NewTaipeiCity,Taiwan24803/新北市五股區新北產業園區五工路 134 號

台灣檢驗科技股份有限公司

t (886-2) 2299-3279

f (886-2) 2298-0488

[www.tw.sgs.com](http://www.tw.sgs.com)

Member of SGS Group

#### 9.4. Measurement Equipment Used

Conducted Emission (measured at antenna port) Test Site					
EQUIPMENT TYPE	MFR	MODEL NUMBER	SERIAL NUMBER	LAST CAL.	CAL DUE.
EXA Spectrum Analyzer	Agilent	N9030A	MY53120760	03/21/2017	03/20/2018
DC Block	Mini-Circuits	BLK-18-S+	1	01/05/2017	01/04/2018
Coaxial Cable	HUBER+SUHNER	SUCOFLEX 102	23670/2	01/05/2017	01/04/2018
Attenuator	Mini-Circuit	BW-S10W2+	2	01/05/2017	01/04/2018
Splitter	Agilent	11636B	N/A	01/05/2017	01/04/2018
DC Power Supply	Agilent	E3640A	MY52410006	11/21/2016	11/20/2017
Temperature Chamber	TERCHY	MHG-120LF	911009	05/19/2017	05/18/2018
Radio Communication Analyzer	R&S	CMU200	102189	02/10/2017	02/09/2018
Radio Communication Analyer	Anritsu	MT8820C	6201465317	01/03/2017	01/02/2018

#### 9.5. Measurement Result:

Refer to next pages.

**NOTE: The occurrence of the spike on the conducted emission is the signal of the fundamental emission.**

Unless otherwise stated the results shown in this test report refer only to the sample(s) tested and such sample(s) are retained for 90 days only.

除非另有說明，此報告結果僅對測試之樣品負責，同時此樣品僅保留90天。本報告未經本公司書面許可，不可部份複製。

This document is issued by the Company subject to its General Conditions of Service printed overleaf, available on request or accessible at [www.sgs.com/terms\\_and\\_conditions.htm](http://www.sgs.com/terms_and_conditions.htm) and, for electronic format documents, subject to Terms and Conditions for Electronic Documents at [www.sgs.com/terms\\_e-document.htm](http://www.sgs.com/terms_e-document.htm). Attention is drawn to the limitation of liability, indemnification and jurisdiction issues defined therein. Any holder of this document is advised that information contained hereon reflects the Company's findings at the time of its intervention only and within the limits of Client's instructions, if any. The Company's sole responsibility is to its Client and this document does not exonerate parties to a transaction from exercising all their rights and obligations under the transaction documents. This document cannot be reproduced except in full, without prior written approval of the Company. Any unauthorized alteration, forgery or falsification of the content or appearance of this document is unlawful and offenders may be prosecuted to the fullest extent of the law.

SGS Taiwan Ltd.

No.134,WuKungRoad,NewTaipeiIndustrialPark,WukuDistrict,NewTaipeiCity,Taiwan24803/新北市五股區新北產業園區五工路 134 號

台灣檢驗科技股份有限公司

t (886-2) 2299-3279

f (886-2) 2298-0488

[www.tw.sgs.com](http://www.tw.sgs.com)

Member of SGS Group

MASK  
Band 7\_5M\_QPSK\_LOW\_RB1,0

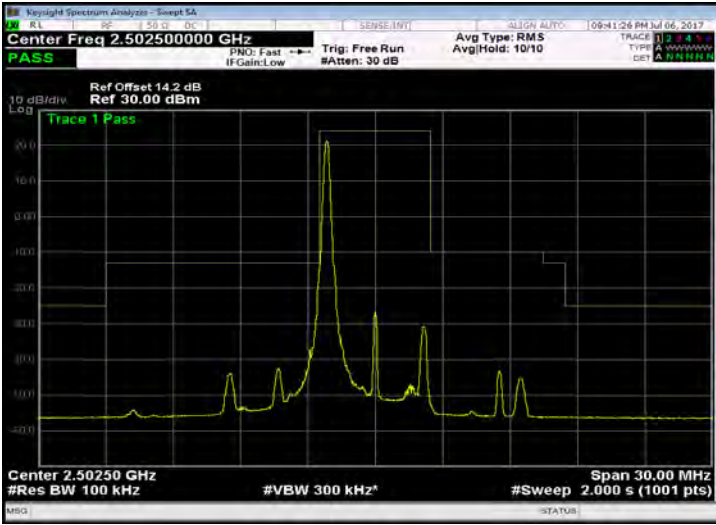

Band 7\_5M\_QPSK\_LOW\_RB1,24

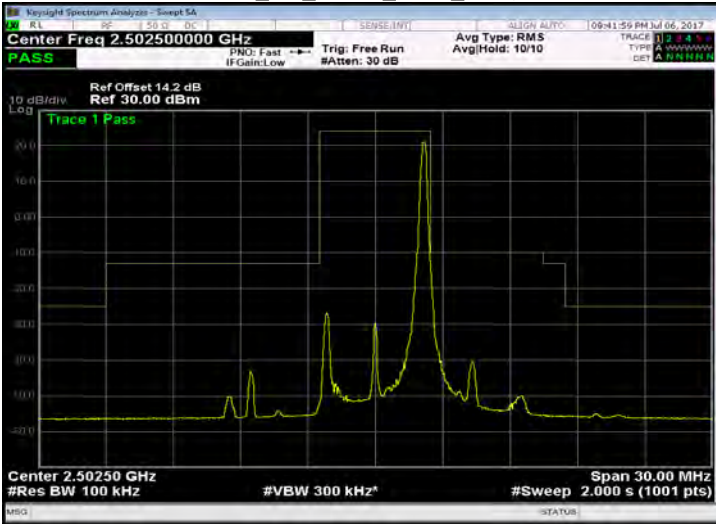

Band 7\_5M\_QPSK\_LOW\_RB25,0

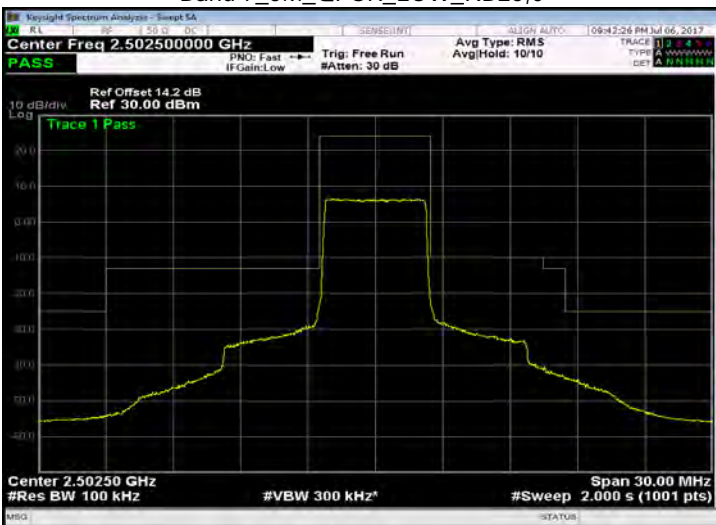

Band 7\_5M\_QPSK\_MID\_RB1,0

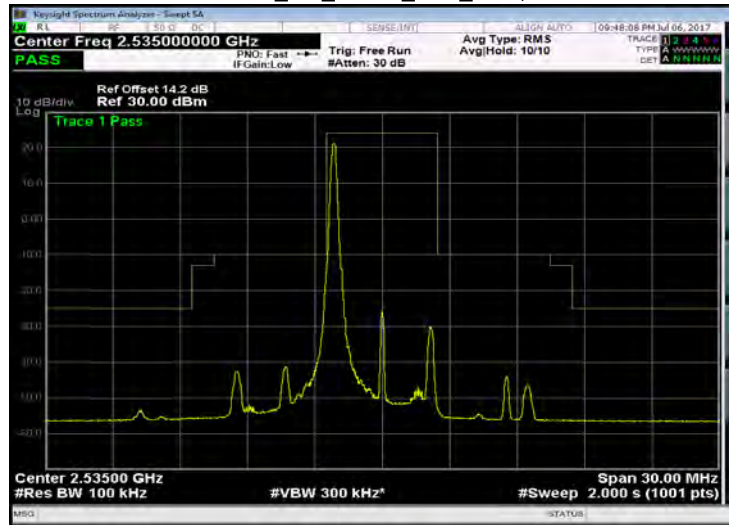

Band 7\_5M\_QPSK\_MID\_RB1,24

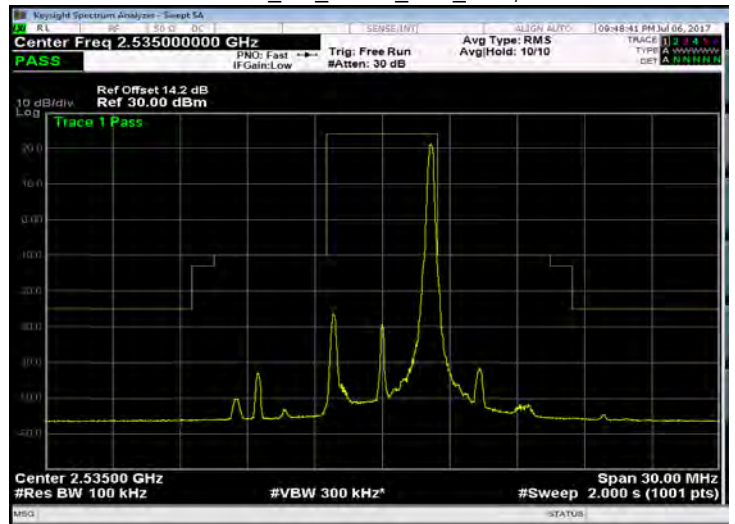

Band 7\_5M\_QPSK\_MID\_RB25,0



Unless otherwise stated the results shown in this test report refer only to the sample(s) tested and such sample(s) are retained for 90 days only.

除非另有說明，此報告結果僅對測試之樣品負責，同時此樣品僅保留90天。本報告未經本公司書面許可，不可部份複製。

This document is issued by the Company subject to its General Conditions of Service printed overleaf, available on request or accessible at [www.sgs.com/terms\\_and\\_conditions.htm](http://www.sgs.com/terms_and_conditions.htm) and, for electronic format documents, subject to Terms and Conditions for Electronic Documents at [www.sgs.com/terms\\_e-document.htm](http://www.sgs.com/terms_e-document.htm). Attention is drawn to the limitation of liability, indemnification and jurisdiction issues defined therein. Any holder of this document is advised that information contained hereon reflects the Company's findings at the time of its intervention only and within the limits of Client's instructions, if any. The Company's sole responsibility is to its Client and this document does not exonerate parties to a transaction from exercising all their rights and obligations under the transaction documents. This document cannot be reproduced except in full, without prior written approval of the Company. Any unauthorized alteration, forgery or falsification of the content or appearance of this document is unlawful and offenders may be prosecuted to the fullest extent of the law.



Band 7\_5M\_QPSK\_HIGH\_RB1,0

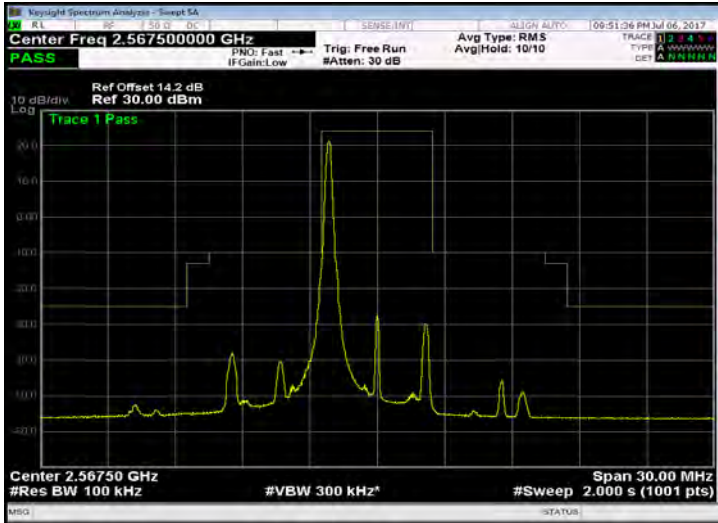

Band 7\_5M\_16QAM\_LOW\_RB1,0

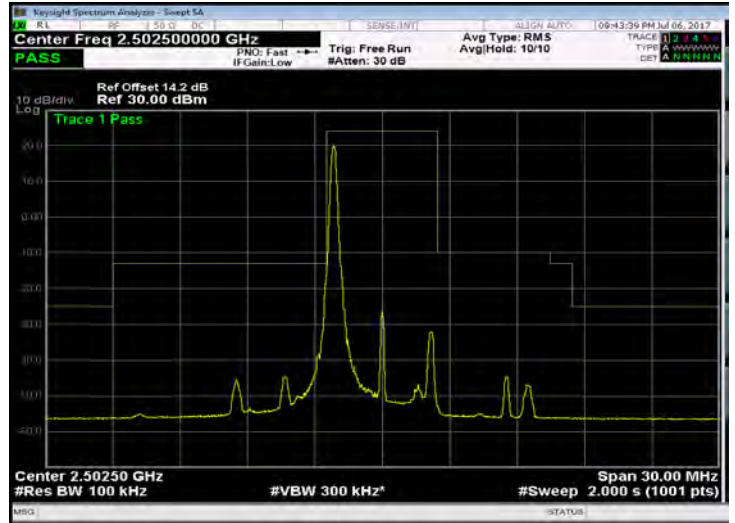

Band 7\_5M\_QPSK\_HIGH\_RB1,24



Band 7\_5M\_16QAM\_LOW\_RB1,24

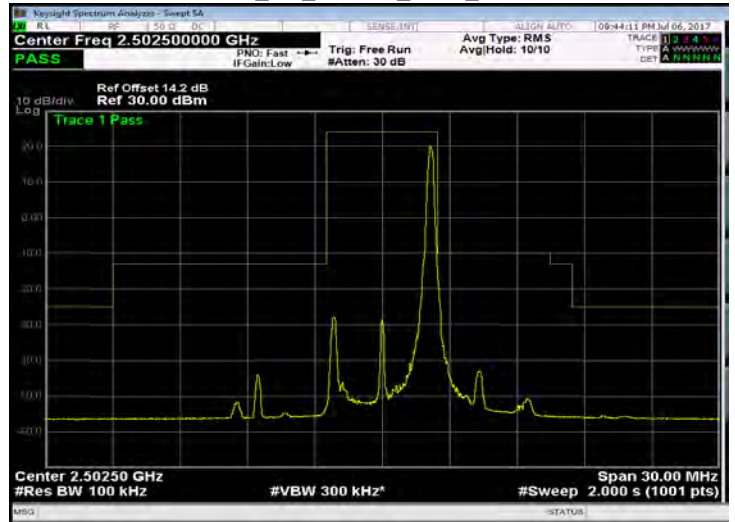

Band 7\_5M\_QPSK\_HIGH\_RB25,0



Band 7\_5M\_16QAM\_LOW\_RB25,0



Unless otherwise stated the results shown in this test report refer only to the sample(s) tested and such sample(s) are retained for 90 days only.

除非另有說明，此報告結果僅對測試之樣品負責，同時此樣品僅保留90天。本報告未經本公司書面許可，不可部份複製。

This document is issued by the Company subject to its General Conditions of Service printed overleaf, available on request or accessible at [www.sgs.com/terms\\_and\\_conditions.htm](http://www.sgs.com/terms_and_conditions.htm) and, for electronic format documents, subject to Terms and Conditions for Electronic Documents at [www.sgs.com/terms\\_e-document.htm](http://www.sgs.com/terms_e-document.htm). Attention is drawn to the limitation of liability, indemnification and jurisdiction issues defined therein. Any holder of this document is advised that information contained hereon reflects the Company's findings at the time of its intervention only and within the limits of Client's instructions, if any. The Company's sole responsibility is to its Client and this document does not exonerate parties to a transaction from exercising all their rights and obligations under the transaction documents. This document cannot be reproduced except in full, without prior written approval of the Company. Any unauthorized alteration, forgery or falsification of the content or appearance of this document is unlawful and offenders may be prosecuted to the fullest extent of the law.



Band 7\_5M\_16QAM\_MID\_RB1,0

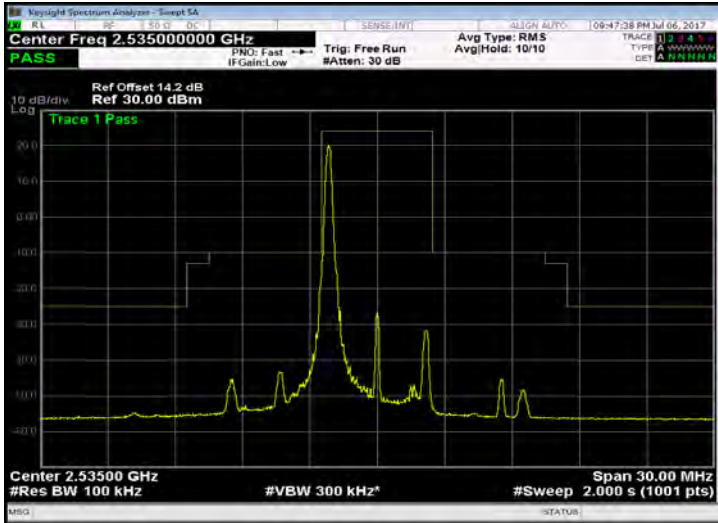

Band 7\_5M\_16QAM\_HIGH\_RB1,0

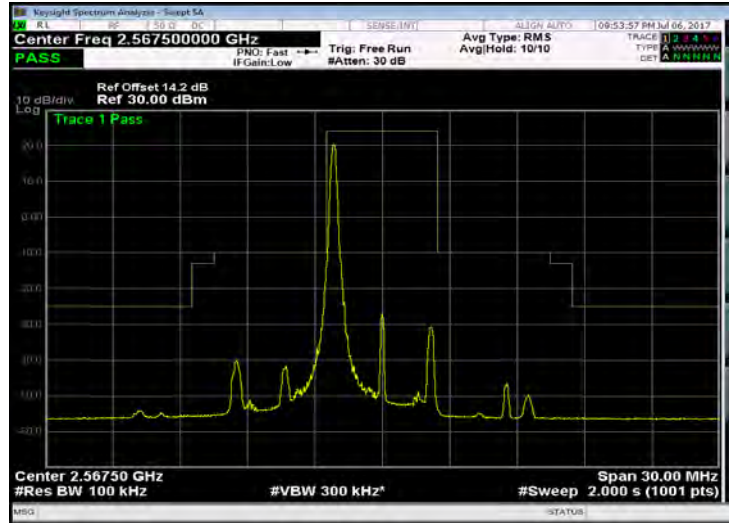

Band 7\_5M\_16QAM\_MID\_RB1,24

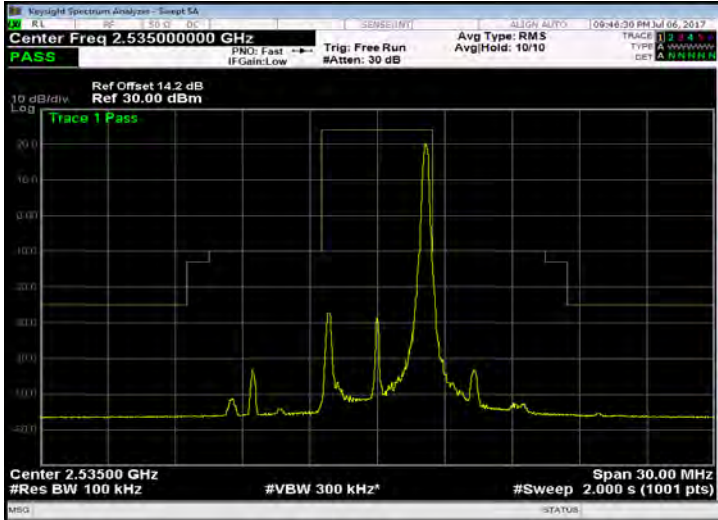

Band 7\_5M\_16QAM\_HIGH\_RB1,24

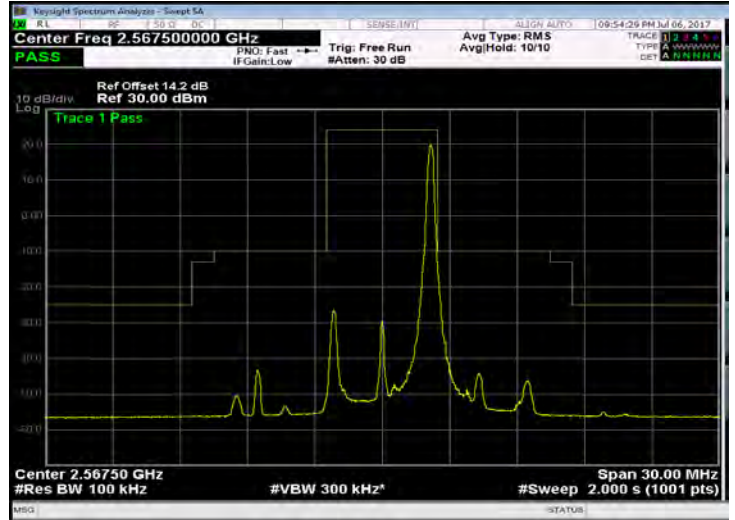

Band 7\_5M\_16QAM\_MID\_RB25,0

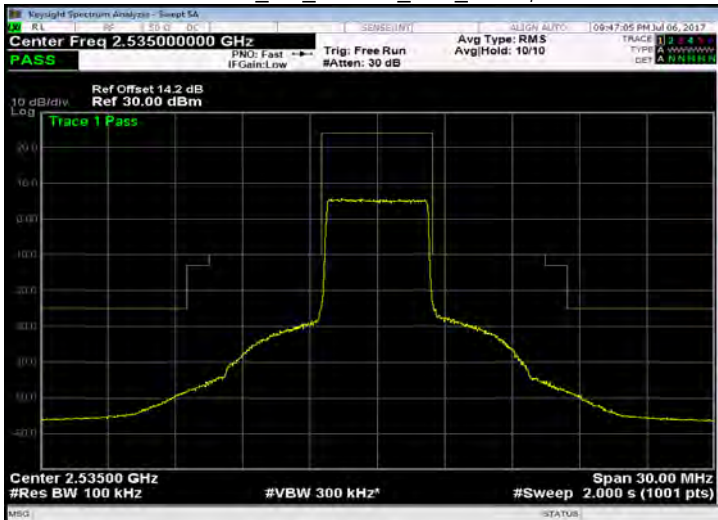

Band 7\_5M\_16QAM\_HIGH\_RB25,0



Unless otherwise stated the results shown in this test report refer only to the sample(s) tested and such sample(s) are retained for 90 days only.  
除非另有說明，此報告結果僅對測試之樣品負責，同時此樣品僅保留90天。本報告未經本公司書面許可，不可部份複製。

This document is issued by the Company subject to its General Conditions of Service printed overleaf, available on request or accessible at [www.sgs.com/terms\\_and\\_conditions.htm](http://www.sgs.com/terms_and_conditions.htm) and, for electronic format documents, subject to Terms and Conditions for Electronic Documents at [www.sgs.com/terms\\_e-document.htm](http://www.sgs.com/terms_e-document.htm). Attention is drawn to the limitation of liability, indemnification and jurisdiction issues defined therein. Any holder of this document is advised that information contained hereon reflects the Company's findings at the time of its intervention only and within the limits of Client's instructions, if any. The Company's sole responsibility is to its Client and this document does not exonerate parties to a transaction from exercising all their rights and obligations under the transaction documents. This document cannot be reproduced except in full, without prior written approval of the Company. Any unauthorized alteration, forgery or falsification of the content or appearance of this document is unlawful and offenders may be prosecuted to the fullest extent of the law.

Band 7\_10M\_QPSK\_LOW\_RB1,0

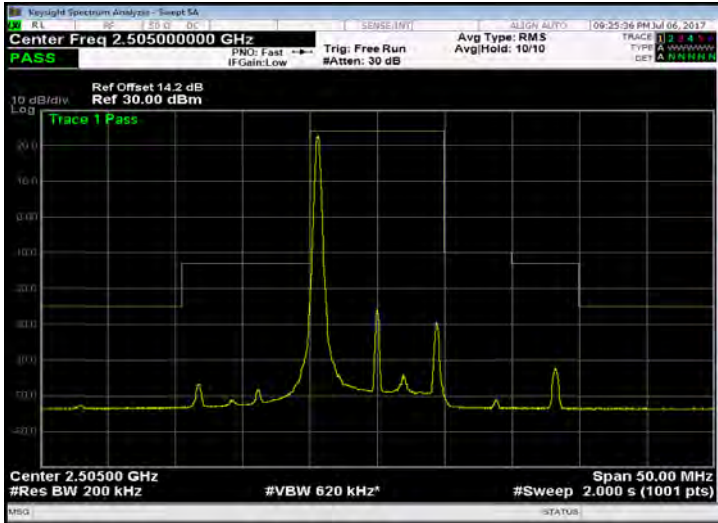

Band 7\_10M\_QPSK\_MID\_RB1,0

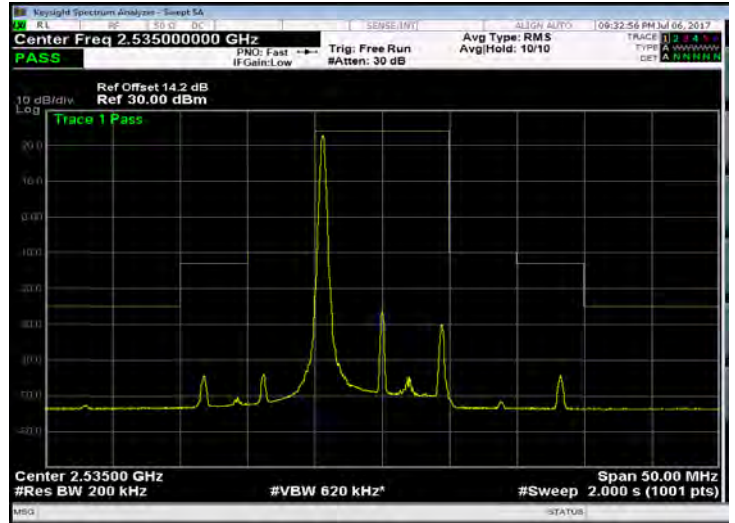

Band 7\_10M\_QPSK\_LOW\_RB1,49

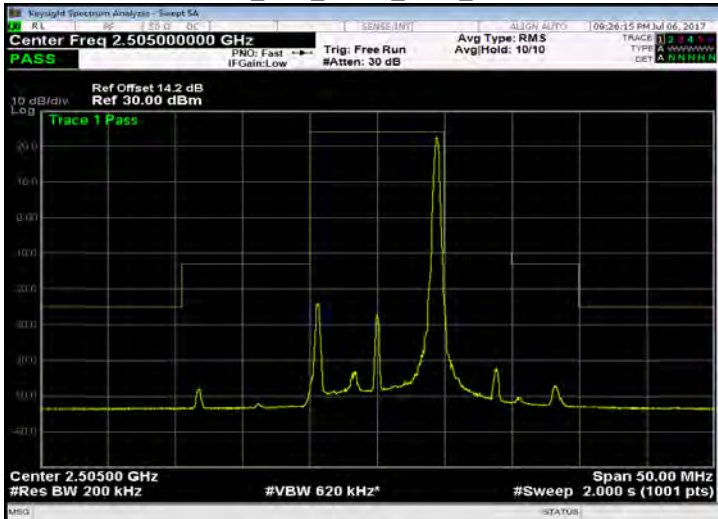

Band 7\_10M\_QPSK\_MID\_RB1,49

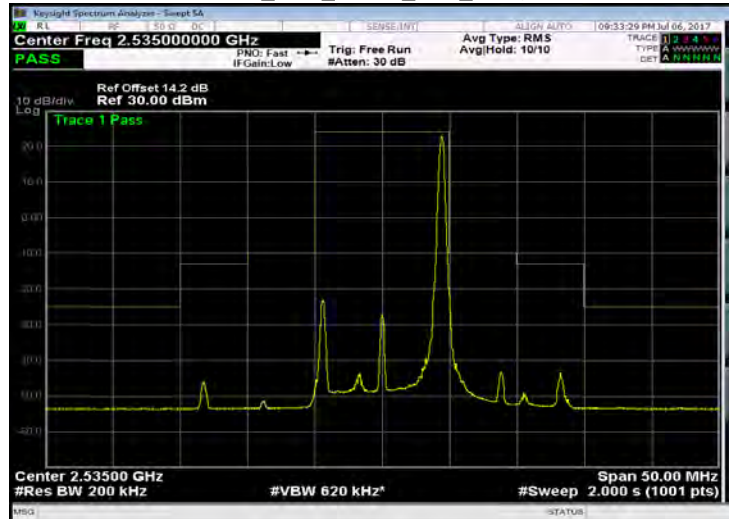

Band 7\_10M\_QPSK\_LOW\_RB50,0

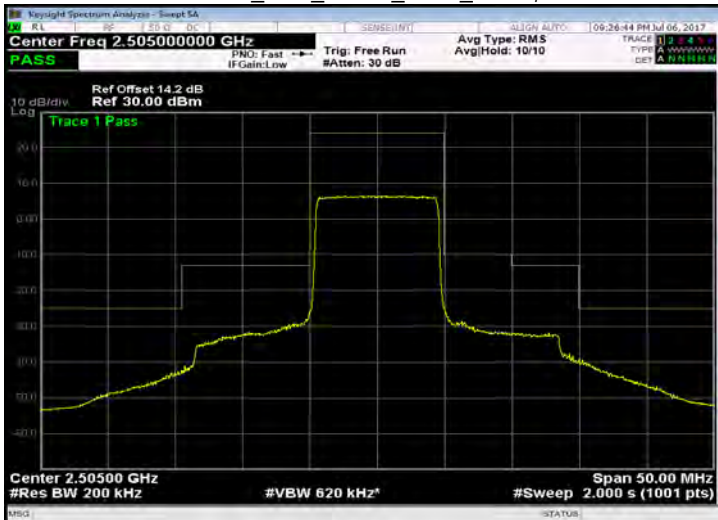

Band 7\_10M\_QPSK\_MID\_RB50,0

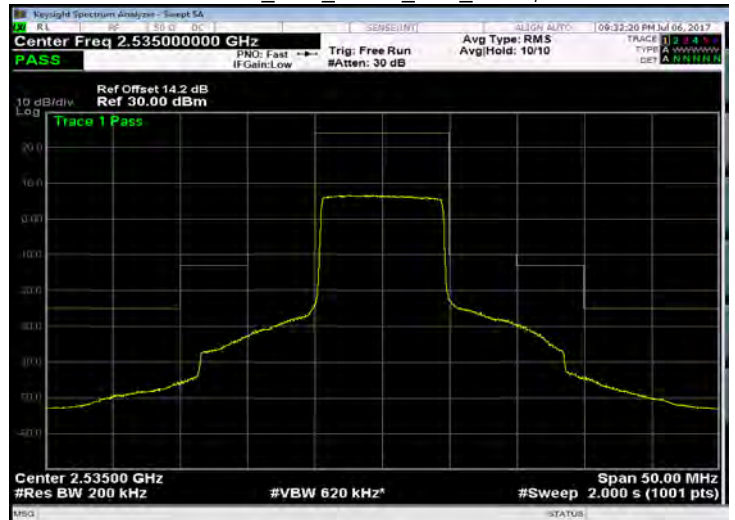

Unless otherwise stated the results shown in this test report refer only to the sample(s) tested and such sample(s) are retained for 90 days only.  
除非另有說明，此報告結果僅對測試之樣品負責，同時此樣品僅保留90天。本報告未經本公司書面許可，不可部份複製。

This document is issued by the Company subject to its General Conditions of Service printed overleaf, available on request or accessible at [www.sgs.com/terms\\_and\\_conditions.htm](http://www.sgs.com/terms_and_conditions.htm) and, for electronic format documents, subject to Terms and Conditions for Electronic Documents at [www.sgs.com/terms\\_e-document.htm](http://www.sgs.com/terms_e-document.htm). Attention is drawn to the limitation of liability, indemnification and jurisdiction issues defined therein. Any holder of this document is advised that information contained hereon reflects the Company's findings at the time of its intervention only and within the limits of Client's instructions, if any. The Company's sole responsibility is to its Client and this document does not exonerate parties to a transaction from exercising all their rights and obligations under the transaction documents. This document cannot be reproduced except in full, without prior written approval of the Company. Any unauthorized alteration, forgery or falsification of the content or appearance of this document is unlawful and offenders may be prosecuted to the fullest extent of the law.



Band 7\_10M\_QPSK\_HIGH\_RB1,0

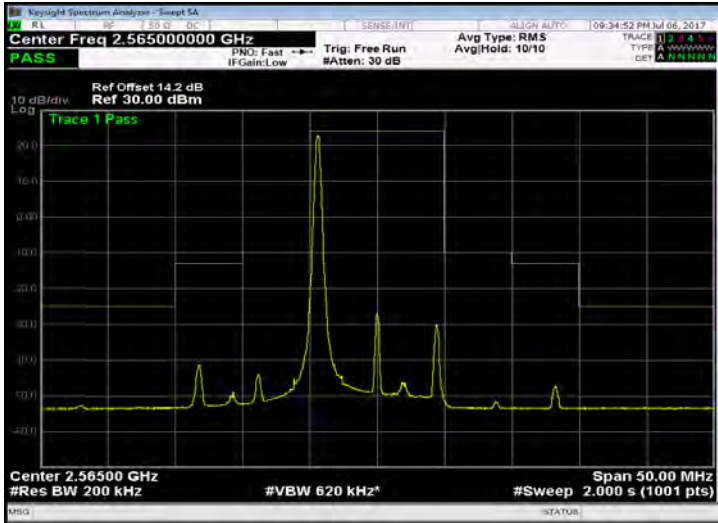

Band 7\_10M\_16QAM\_LOW\_RB1,0

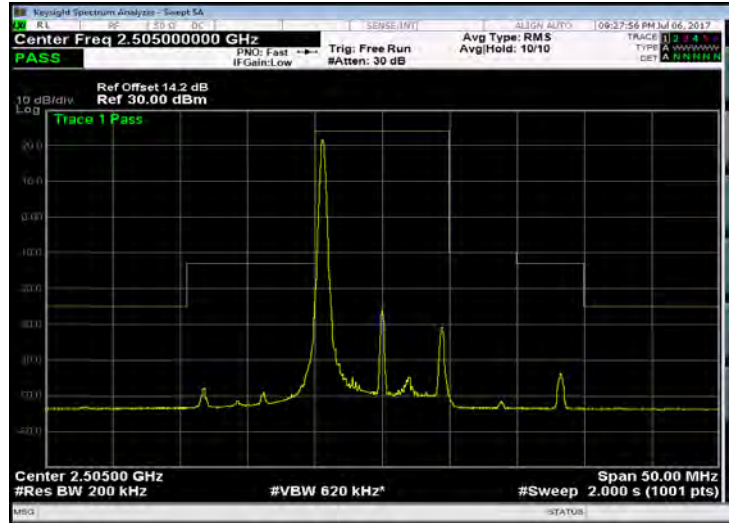

Band 7\_10M\_QPSK\_HIGH\_RB1,49

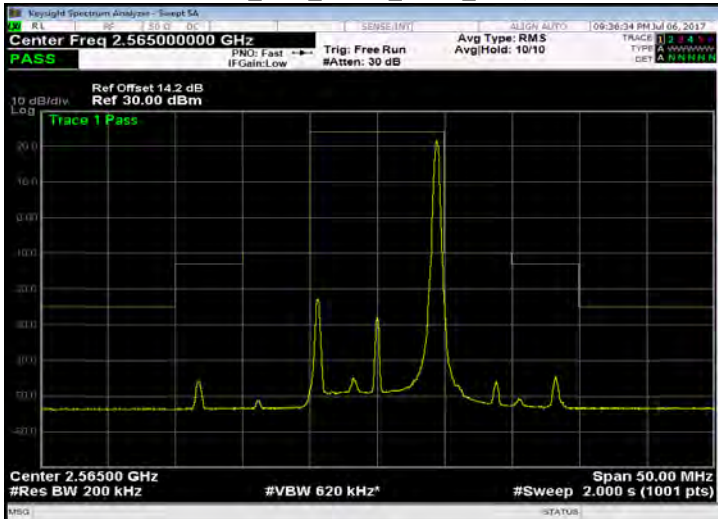

Band 7\_10M\_16QAM\_LOW\_RB1,49

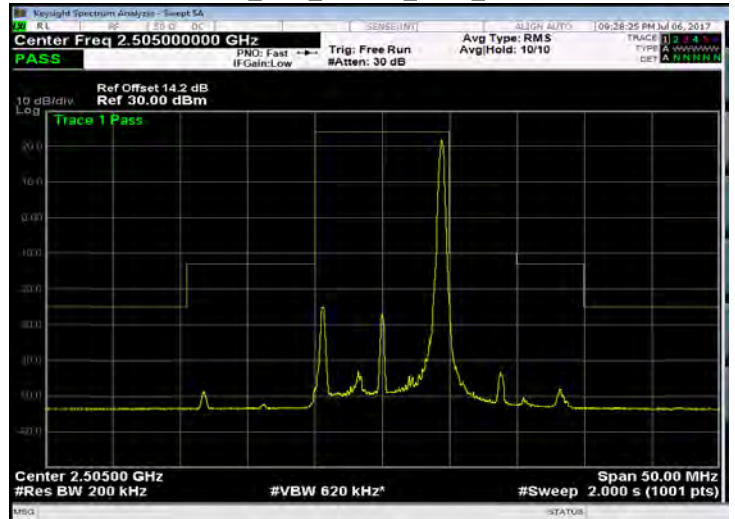

Band 7\_10M\_QPSK\_HIGH\_RB50,0



Band 7\_10M\_16QAM\_LOW\_RB50,0



Unless otherwise stated the results shown in this test report refer only to the sample(s) tested and such sample(s) are retained for 90 days only.

除非另有說明，此報告結果僅對測試之樣品負責，同時此樣品僅保留90天。本報告未經本公司書面許可，不可部份複製。

This document is issued by the Company subject to its General Conditions of Service printed overleaf, available on request or accessible at [www.sgs.com/terms\\_and\\_conditions.htm](http://www.sgs.com/terms_and_conditions.htm) and, for electronic format documents, subject to Terms and Conditions for Electronic Documents at [www.sgs.com/terms\\_e-document.htm](http://www.sgs.com/terms_e-document.htm). Attention is drawn to the limitation of liability, indemnification and jurisdiction issues defined therein. Any holder of this document is advised that information contained hereon reflects the Company's findings at the time of its intervention only and within the limits of Client's instructions, if any. The Company's sole responsibility is to its Client and this document does not exonerate parties to a transaction from exercising all their rights and obligations under the transaction documents. This document cannot be reproduced except in full, without prior written approval of the Company. Any unauthorized alteration, forgery or falsification of the content or appearance of this document is unlawful and offenders may be prosecuted to the fullest extent of the law.

Band 7\_10M\_16QAM\_MID\_RB1,0

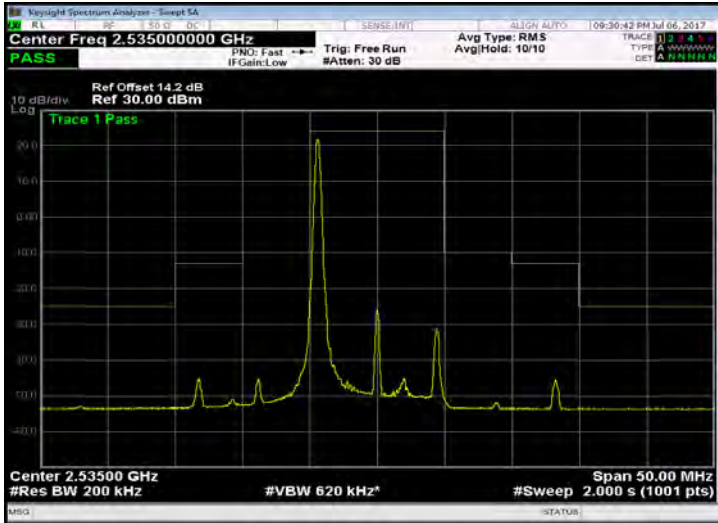

Band 7\_10M\_16QAM\_HIGH\_RB1,0

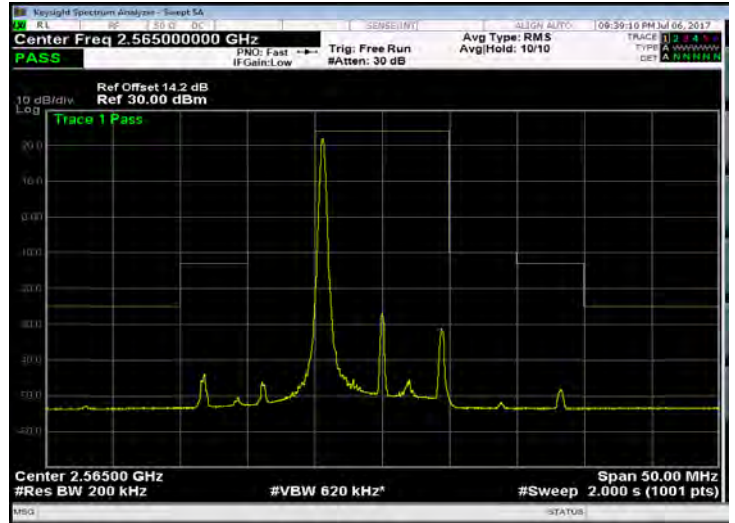

Band 7\_10M\_16QAM\_MID\_RB1,49

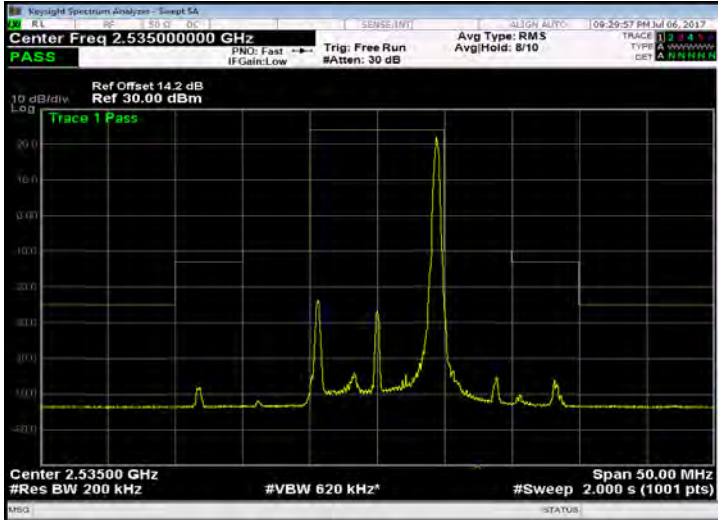

Band 7\_10M\_16QAM\_HIGH\_RB1,49

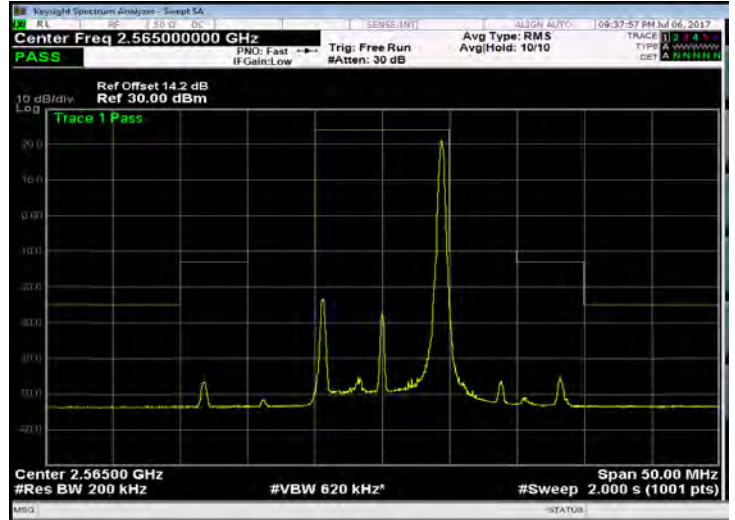

Band 7\_10M\_16QAM\_MID\_RB50,0



Band 7\_10M\_16QAM\_HIGH\_RB50,0



Unless otherwise stated the results shown in this test report refer only to the sample(s) tested and such sample(s) are retained for 90 days only.  
除非另有說明，此報告結果僅對測試之樣品負責，同時此樣品僅保留90天。本報告未經本公司書面許可，不可部份複製。

This document is issued by the Company subject to its General Conditions of Service printed overleaf, available on request or accessible at [www.sgs.com/terms\\_and\\_conditions.htm](http://www.sgs.com/terms_and_conditions.htm) and, for electronic format documents, subject to Terms and Conditions for Electronic Documents at [www.sgs.com/terms\\_e-document.htm](http://www.sgs.com/terms_e-document.htm). Attention is drawn to the limitation of liability, indemnification and jurisdiction issues defined therein. Any holder of this document is advised that information contained hereon reflects the Company's findings at the time of its intervention only and within the limits of Client's instructions, if any. The Company's sole responsibility is to its Client and this document does not exonerate parties to a transaction from exercising all their rights and obligations under the transaction documents. This document cannot be reproduced except in full, without prior written approval of the Company. Any unauthorized alteration, forgery or falsification of the content or appearance of this document is unlawful and offenders may be prosecuted to the fullest extent of the law.