



SAR TEST REPORT

No. I17Z60755-SEM05

For

HMD Global Oy

Smart Phone

Model Name: TA-1021

With

Hardware Version: 5

Software Version: 000C_3_24A

FCC ID: 2AJOTTA-1021

Issued Date: 2017-6-7



中国认可
国际互认
检测
TESTING
CNAS L0570

Note:

The test results in this test report relate only to the devices specified in this report. This report shall not be reproduced except in full without the written approval of CTTL.

Test Laboratory:

CTTL, Telecommunication Technology Labs, Academy of Telecommunication Research, MIIT
No. 51 Shouxiang Science Building, Xueyuan Road, Haidian District, Beijing, P. R. China100191
Tel:+86(0)10-62304633-2512,Fax:+86(0)10-62304633-2504
Email:cttl_terminals@catr.cn, website:www.chinattl.com



REPORT HISTORY

Report Number	Revision	Issue Date	Description
I17Z60755-SEM05	Rev.0	2017-6-7	Initial creation of test report

TABLE OF CONTENT

1	TEST LABORATORY	5
1.1	TESTING LOCATION	5
1.2	TESTING ENVIRONMENT	5
1.3	PROJECT DATA	5
1.4	SIGNATURE	5
2	STATEMENT OF COMPLIANCE	6
3	CLIENT INFORMATION	8
3.1	APPLICANT INFORMATION	8
3.2	MANUFACTURER INFORMATION	8
4	EQUIPMENT UNDER TEST (EUT) AND ANCILLARY EQUIPMENT (AE)	9
4.1	ABOUT EUT	9
4.2	INTERNAL IDENTIFICATION OF EUT USED DURING THE TEST	9
4.3	INTERNAL IDENTIFICATION OF AE USED DURING THE TEST	9
5	TEST METHODOLOGY	10
5.1	APPLICABLE LIMIT REGULATIONS	10
5.2	APPLICABLE MEASUREMENT STANDARDS	10
6	SPECIFIC ABSORPTION RATE (SAR)	11
6.1	INTRODUCTION	11
6.2	SAR DEFINITION	11
7	TISSUE SIMULATING LIQUIDS	12
7.1	TARGETS FOR TISSUE SIMULATING LIQUID	12
7.2	DIELECTRIC PERFORMANCE	12
8	SYSTEM VERIFICATION	19
8.1	SYSTEM SETUP	19
8.2	SYSTEM VERIFICATION	20
9	MEASUREMENT PROCEDURES	21
9.1	TESTS TO BE PERFORMED	21
9.2	GENERAL MEASUREMENT PROCEDURE	23
9.3	WCDMA MEASUREMENT PROCEDURES FOR SAR	24
9.4	SAR MEASUREMENT FOR LTE	25
9.5	BLUETOOTH & WI-FI MEASUREMENT PROCEDURES FOR SAR	25
9.6	POWER DRIFT	26
10	AREA SCAN BASED 1-G SAR	26
10.1	REQUIREMENT OF KDB	26
10.2	FAST SAR ALGORITHMS	26

11	CONDUCTED OUTPUT POWER.....	27
11.1	GSM MEASUREMENT RESULT	27
11.2	WCDMA MEASUREMENT RESULT.....	28
11.3	LTE MEASUREMENT RESULT	29
11.4	WI-FI AND BT MEASUREMENT RESULT	35
12	SIMULTANEOUS TX SAR CONSIDERATIONS	38
12.1	INTRODUCTION.....	38
12.2	TRANSMIT ANTENNA SEPARATION DISTANCES	38
12.3	SAR MEASUREMENT POSITIONS	39
12.4	STANDALONE SAR TEST EXCLUSION CONSIDERATIONS.....	39
13	EVALUATION OF SIMULTANEOUS.....	40
14	SAR TEST RESULT	41
14.1	EVALUATION OF MULTI-BATTERIES AND SIM SLOTS	41
14.2	SAR RESULTS	43
14.3	FULL SAR	53
14.4	WLAN EVALUATION FOR 2.4G	54
14.5	WLAN EVALUATION FOR 5G.....	57
15	SAR MEASUREMENT VARIABILITY	62
16	MEASUREMENT UNCERTAINTY	63
16.1	MEASUREMENT UNCERTAINTY FOR NORMAL SAR TESTS (300MHZ~3GHZ)	63
16.2	MEASUREMENT UNCERTAINTY FOR NORMAL SAR TESTS (3~6GHZ).....	64
16.3	MEASUREMENT UNCERTAINTY FOR FAST SAR TESTS (300MHZ~3GHZ).....	65
16.4	MEASUREMENT UNCERTAINTY FOR FAST SAR TESTS (3~6GHZ).....	67
17	MAIN TEST INSTRUMENTS.....	69
ANNEX A	GRAPH RESULTS.....	70
ANNEX B	SYSTEM VERIFICATION RESULTS.....	94
ANNEX C	SAR MEASUREMENT SETUP	119
ANNEX D	POSITION OF THE WIRELESS DEVICE IN RELATION TO THE PHANTOM	125
ANNEX E	EQUIVALENT MEDIA RECIPES	128
ANNEX F	SYSTEM VALIDATION	129
ANNEX G	PROBE CALIBRATION CERTIFICATE	130
ANNEX H	DIPOLE CALIBRATION CERTIFICATE.....	141
ANNEX I	SPOT CHECK.....	186
ANNEX J	ACCREDITATION CERTIFICATE.....	207

1 Test Laboratory

1.1 Testing Location

Company Name:	CTTL(Shouxiang)
Address:	No. 51 Shouxiang Science Building, Xueyuan Road, Haidian District, Beijing, P. R. China100191

1.2 Testing Environment

Temperature:	18°C~25 °C,
Relative humidity:	30%~ 70%
Ground system resistance:	< 0.5 Ω
Ambient noise & Reflection:	< 0.012 W/kg

1.3 Project Data

Project Leader:	Qi Dianyuan
Test Engineer:	Lin Xiaojun
Testing Start Date:	April 5, 2017
Testing End Date:	May 22, 2017

1.4 Signature



Lin Xiaojun
(Prepared this test report)

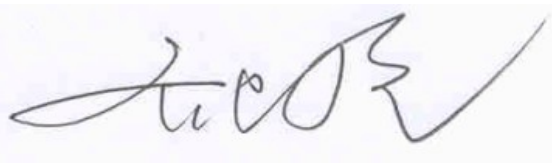

Qi Dianyuan
(Reviewed this test report)

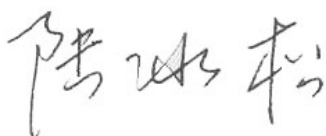

Lu Bingsong
Deputy Director of the laboratory
(Approved this test report)

2 Statement of Compliance

This EUT is a variant product and the report of original sample is No.I17Z60076-SEM04. According to the client request, we share the test results of original sample and do spot check. The results of spot check are presented in the annex I.

The maximum results of SAR found during testing for HMD Global Oy Smart Phone TA-1021 is as follows:

Table 2.1: Highest Reported SAR (1g)

Exposure Configuration	Technology Band	Highest Reported SAR 1g (W/Kg)	Equipment Class
Head (Separation Distance 0mm)	GSM 850	0.18	PCE
	PCS 1900	0.22	
	WCDMA1900	0.53	
	WCDMA850	0.23	
	LTE Band 7	0.46	
	LTE Band 38	0.25	
	LTE Band 5	0.25	
	WLAN 2.4 GHz	1.22	DTS
	WLAN 5 GHz	1.24	NII
Hotspot (Separation Distance 10mm)	GSM 850	0.33	PCE
	PCS 1900	0.58	
	WCDMA1900	0.62	
	WCDMA850	0.38	
	LTE Band 7	0.53	
	LTE Band 38	0.17	
	LTE Band 5	0.30	
	WLAN 2.4 GHz	0.09	DTS
	WLAN 5 GHz	0.06	NII

The SAR values found for the Mobile Phone are below the maximum recommended levels of 1.6 W/Kg as averaged over any 1g tissue according to the ANSI C95.1-1992.

For body worn operation, this device has been tested and meets FCC RF exposure guidelines when used with any accessory that contains no metal and which provides a minimum separation distance of 10 mm between this device and the body of the user. Use of other accessories may not ensure compliance with FCC RF exposure guidelines.

The EUT battery must be fully charged and checked periodically during the test to ascertain uniform power output.

The measurement together with the test system set-up is described in annex C of this test report. A detailed description of the equipment under test can be found in chapter 4 of this test report.

The highest reported SAR value is obtained at the case of **(Table 2.1)**, and the values are: **1.24 W/kg (1g)**.

Table 2.2: The sum of reported SAR values for main antenna and WiFi

	Position	Main antenna	WiFi	Sum
Highest reported SAR value for Head	Right hand, Touch cheek	0.34	1.22(DTS)	1.56
			1.24(NII)	1.58
Highest reported SAR value for Body	Left edge	0.62	0.03(DTS)	0.65
			0.02(NII)	0.64

Note1: we have evaluated and chose the highest value of both main antennae in the above table

Table 2.3: The sum of reported SAR values for main antenna and BT

	Position	Main antenna	BT	Sum
Maximum reported SAR value for Head	Left hand, Touch cheek	0.53	0.19	0.72
Maximum reported SAR value for Body	Left edge	0.62	0.09	0.71

[1] - Estimated SAR for Bluetooth (see the table 13.3)

According to the above tables, the highest sum of reported SAR values is **1.58 W/kg (1g)**. The detail for simultaneous transmission consideration is described in chapter 13.

3 Client Information

3.1 Applicant Information

Company Name:	HMD Global Oy
Address /Post:	Karaportti 2, 02610 Espoo, Finland
Contact Person:	Mikko Kahlos
E-mail:	mikko.kahlos@hmdglobal.com
Telephone:	+358-408036126

3.2 Manufacturer Information

Company Name:	HMD Global Oy
Address /Post:	Karaportti 2, 02610 Espoo, Finland
Contact Person:	Mikko Kahlos
E-mail:	mikko.kahlos@hmdglobal.com
Telephone:	+358-408036126

4 Equipment Under Test (EUT) and Ancillary Equipment (AE)

4.1 About EUT

Description:	Smart Phone
Model name:	TA-1021
Operating mode(s):	GSM 850/900/1800/1900 WCDMA850/900/1900/2100 LTE B1/3/5/7/8/20/28/38/40, BT, WLAN
Tested Tx Frequency:	825 – 848.8 MHz (GSM 850)
	1850.2 – 1910 MHz (GSM 1900)
	826.4–846.6 MHz (WCDMA 850 Band V)
	1852.4–1907.6 MHz (WCDMA1900 Band II)
	2502.5 – 2567.5 MHz (LTE Band 7)
	2572.5 – 2617.5 MHz (LTE Band 38)
	2412 – 2462 MHz (Wi-Fi 2.4G)
	5180 – 5825 MHz (Wi-Fi 5G)
824.7 – 848.3 MHz (LTE Band 5)	
GPRS/EGPRS Multislot Class:	33
GPRS capability Class:	33
Test device Production information:	Production unit
Device type:	Portable device
Antenna type:	Integrated antenna
Accessories/Body-worn configurations:	Headset
Hotspot mode:	Support
Product dimension	Long 154 mm ;Wide 75.8 mm ; Overall Diagonal 171.6 mm

4.2 Internal Identification of EUT used during the test

EUTID	IMEI	HW Version	SW Version
1	356021080010628	5	000C_3_24A
2	356021080010602	5	000C_3_24A
3	356020080008707	5	000C_3_24A
4	356021080009762	5	000C_3_24A

*EUT ID: is used to identify the test sample in the lab internally.

Note: It is performed to test SAR with the EUT1&2&3 and conducted power with the EUT4.

4.3 Internal Identification of AE used during the test

AE ID*	Description	Model	SN	Manufacturer
AE1	Battery	HE316	/	SCUD
AE2	Battery	HE317	/	SCUD
AE3	Headset	CAB5422B-N01-DG	/	Foxconn

*AE ID: is used to identify the test sample in the lab internally.

5 TEST METHODOLOGY

5.1 Applicable Limit Regulations

ANSI C95.1–1992: IEEE Standard for Safety Levels with Respect to Human Exposure to Radio Frequency Electromagnetic Fields, 3 kHz to 300 GHz.

It specifies the maximum exposure limit of **1.6 W/kg** as averaged over any 1 gram of tissue for portable devices being used within 20 cm of the user in the uncontrolled environment.

5.2 Applicable Measurement Standards

IEEE 1528–2013: Recommended Practice for Determining the Peak Spatial-Average Specific Absorption Rate (SAR) in the Human Head from Wireless Communications Devices: Measurement Techniques.

KDB447498 D01 General RF Exposure Guidance v06: Mobile and Portable Devices RF Exposure Procedures and Equipment Authorization Policies.

KDB648474 D04 Handset SAR v01r03: SAR Evaluation Considerations for Wireless Handsets.

KDB941225 D01 SAR test for 3G devices v03r01: SAR Measurement Procedures for 3G Devices

KDB941225 D05 SAR for LTE Devices v02r05: SAR Evaluation Considerations for LTE Devices

KDB248227 D01 802.11 Wi-Fi SAR v02r02: SAR GUIDANCE FOR IEEE 802.11 (Wi-Fi) TRANSMITTERS

KDB865664 D01 SAR measurement 100 MHz to 6 GHz v01r04: SAR Measurement Requirements for 100 MHz to 6 GHz.

KDB865664 D02 RF Exposure Reporting v01r02: RF Exposure Compliance Reporting and Documentation Considerations

6 Specific Absorption Rate (SAR)

6.1 Introduction

SAR is related to the rate at which energy is absorbed per unit mass in an object exposed to a radio field. The SAR distribution in a biological body is complicated and is usually carried out by experimental techniques or numerical modeling. The standard recommends limits for two tiers of groups, occupational/controlled and general population/uncontrolled, based on a person's awareness and ability to exercise control over his or her exposure. In general, occupational/controlled exposure limits are higher than the limits for general population/uncontrolled.

6.2 SAR Definition

The SAR definition is the time derivative (rate) of the incremental energy (dW) absorbed by (dissipated in) an incremental mass (dm) contained in a volume element (dv) of a given density (ρ). The equation description is as below:

$$SAR = \frac{d}{dt} \left(\frac{dW}{dm} \right) = \frac{d}{dt} \left(\frac{dW}{\rho dv} \right)$$

SAR is expressed in units of Watts per kilogram (W/kg)

SAR measurement can be either related to the temperature elevation in tissue by

$$SAR = c \left(\frac{\delta T}{\delta t} \right)$$

Where: C is the specific heat capacity, δT is the temperature rise and δt is the exposure duration, or related to the electrical field in the tissue by

$$SAR = \frac{\sigma |E|^2}{\rho}$$

Where: σ is the conductivity of the tissue, ρ is the mass density of tissue and E is the RMS electrical field strength.

However for evaluating SAR of low power transmitter, electrical field measurement is typically applied.

7 Tissue Simulating Liquids

7.1 Targets for tissue simulating liquid

Table 7.1: Targets for tissue simulating liquid

Frequency(MHz)	Liquid Type	Conductivity(σ)	$\pm 5\%$ Range	Permittivity(ϵ)	$\pm 5\%$ Range
835	Head	0.90	0.86~0.95	41.5	39.4~43.6
835	Body	0.97	0.92~1.02	55.2	52.4~58.0
1900	Head	1.40	1.33~1.47	40.0	38.0~42.0
1900	Body	1.52	1.44~1.60	53.3	50.6~56.0
2450	Head	1.80	1.71~1.89	39.2	37.2~41.2
2450	Body	1.95	1.85~2.05	52.7	50.1~55.3
2600	Head	1.96	1.86~2.06	39.01	37.06~40.96
2600	Body	2.16	2.05~2.27	52.5	49.9~55.1
5250	Head	4.71	4.47~4.95	35.93	34.1~37.7
5250	Body	5.36	5.09~5.63	48.9	46.5~51.3
5600	Head	5.07	4.82~5.32	35.53	33.8~37.3
5600	Body	5.77	5.48~6.06	48.5	46.1~50.9
5750	Head	5.22	4.96~5.48	35.36	33.6~37.1
5750	Body	5.94	5.64~6.24	48.3	45.9~50.7

7.2 Dielectric Performance

Table 7.2: Dielectric Performance of Tissue Simulating Liquid

Measurement Date (yyyy-mm-dd)	Type	Frequency	Permittivity ϵ	Drift (%)	Conductivity σ (S/m)	Drift (%)
2017-4-6	Head	835 MHz	41.6	0.24	0.901	0.11
	Body	835 MHz	56.1	1.63	0.988	1.86
2017-4-8	Head	1900 MHz	39.55	-1.13	1.39	-0.71
	Body	1900 MHz	53.19	-0.21	1.536	1.05
2017-4-9	Head	2450 MHz	39.05	-0.38	1.784	-0.89
	Body	2450 MHz	53.36	1.25	1.966	0.82
2017-4-10	Head	2600 MHz	39.57	1.44	1.966	0.31
	Body	2600 MHz	51.61	-1.70	2.138	-1.02
2017-4-11	Head	5250 MHz	36.28	0.97	4.726	0.34
	Body	5250 MHz	47.44	-2.99	5.259	-1.88
	Head	5600 MHz	35.73	0.56	5.199	2.54
	Body	5600 MHz	46.98	-3.13	5.708	-1.07
	Head	5750 MHz	35.38	0.06	5.414	3.72
	Body	5750 MHz	46.78	-3.15	5.992	0.88

Note: The liquid temperature is 22.0°C

Table 7.3: Dielectric Performance of Tissue Simulating Liquid for spot check

Measurement Date (yyyy-mm-dd)	Type	Frequency	Permittivity ϵ	Drift (%)	Conductivity σ (S/m)	Drift (%)
2017-5-21	Head	835 MHz	41.95	1.08	0.931	3.44
	Body	835 MHz	56.35	2.08	0.968	-0.21
2017-5-21	Head	1900 MHz	40.65	1.63	1.409	0.64
	Body	1900 MHz	52.69	-1.14	1.547	1.78
2017-5-22	Head	2450 MHz	39.46	0.66	1.764	-2.00
	Body	2450 MHz	53.16	0.87	1.977	1.38
2017-5-20	Head	2600 MHz	39.46	1.15	1.986	1.33
	Body	2600 MHz	51.82	-1.30	2.178	0.83
2017-5-22	Head	5750 MHz	35.79	1.22	5.313	1.78
	Body	5750 MHz	47.08	-2.53	5.892	-0.81

Note: The liquid temperature is 22.0°C

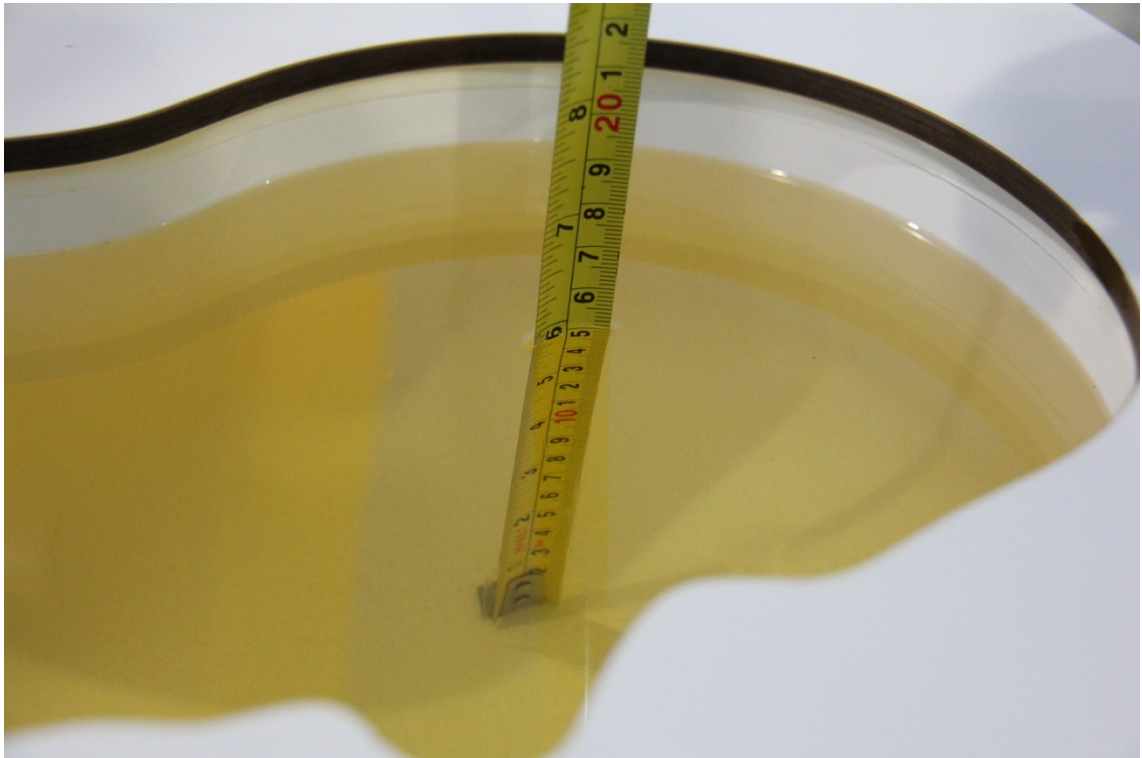

Picture 7-1 Liquid depth in the Head Phantom (835MHz)



Picture 7-2 Liquid depth in the Flat Phantom (835MHz)

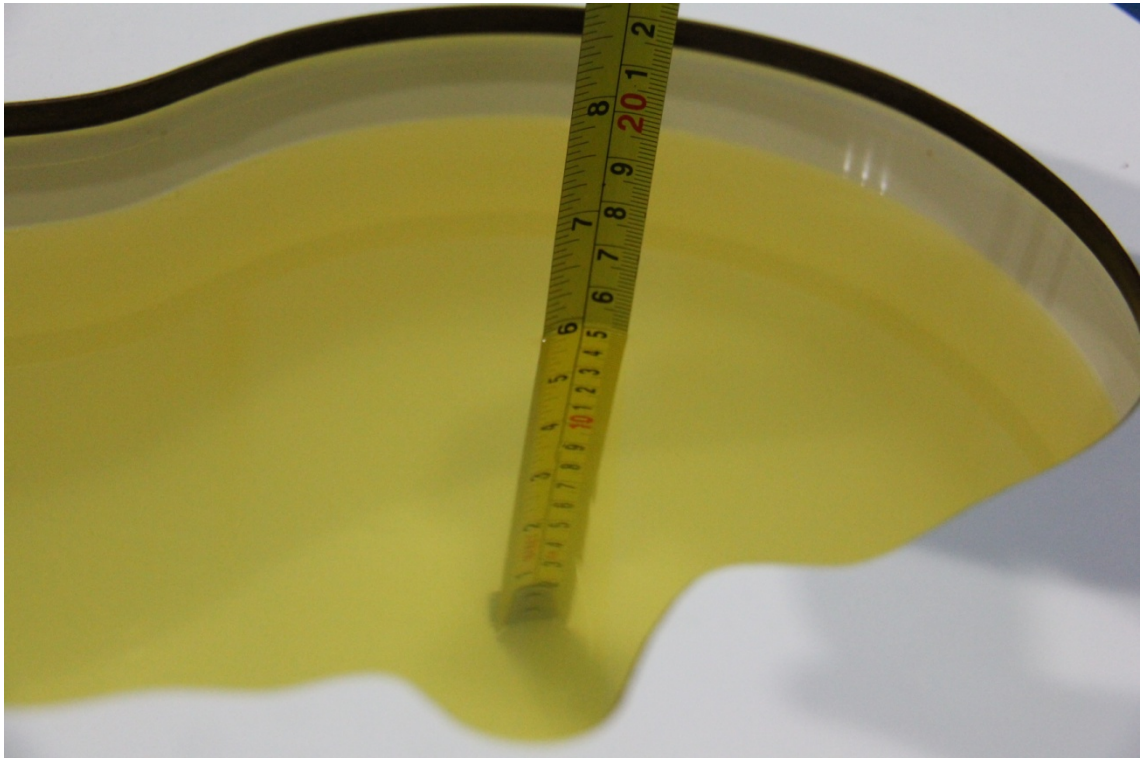

Picture 7-3 Liquid depth in the Head Phantom (1900 MHz)

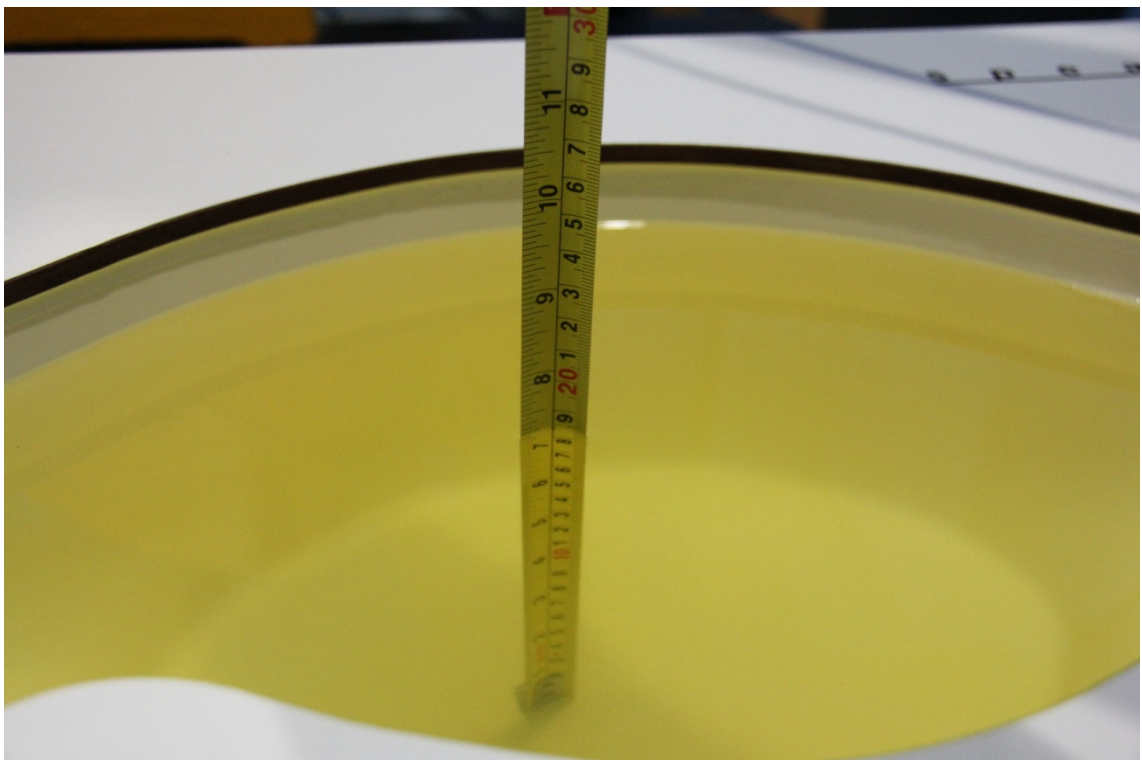

Picture 7-4 Liquid depth in the Flat Phantom (1900MHz)

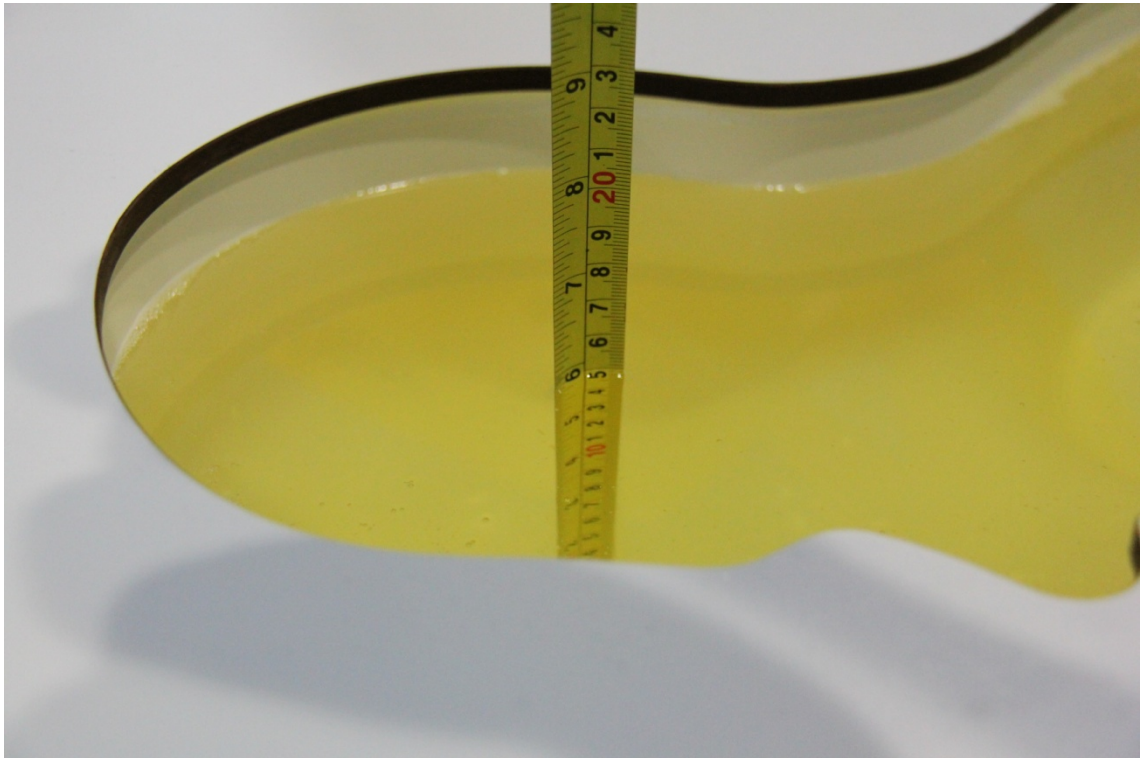

Picture 7-5 Liquid depth in the Head Phantom (2450MHz)

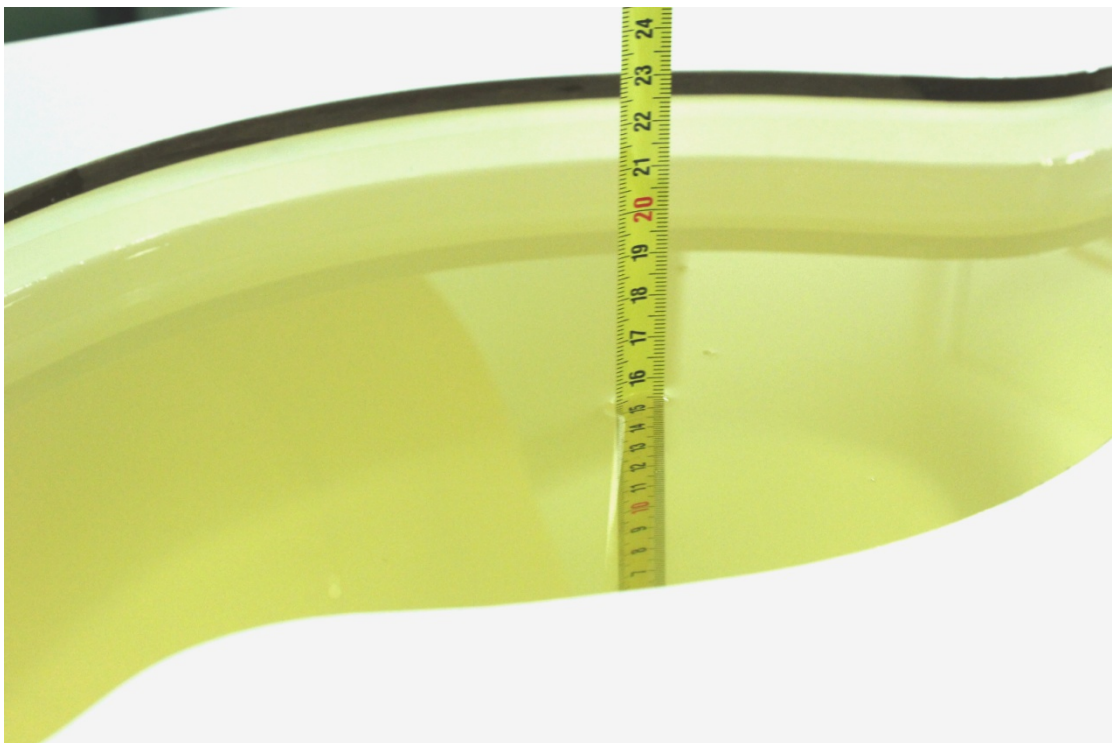

Picture 7-6 Liquid depth in the Flat Phantom (2450MHz)

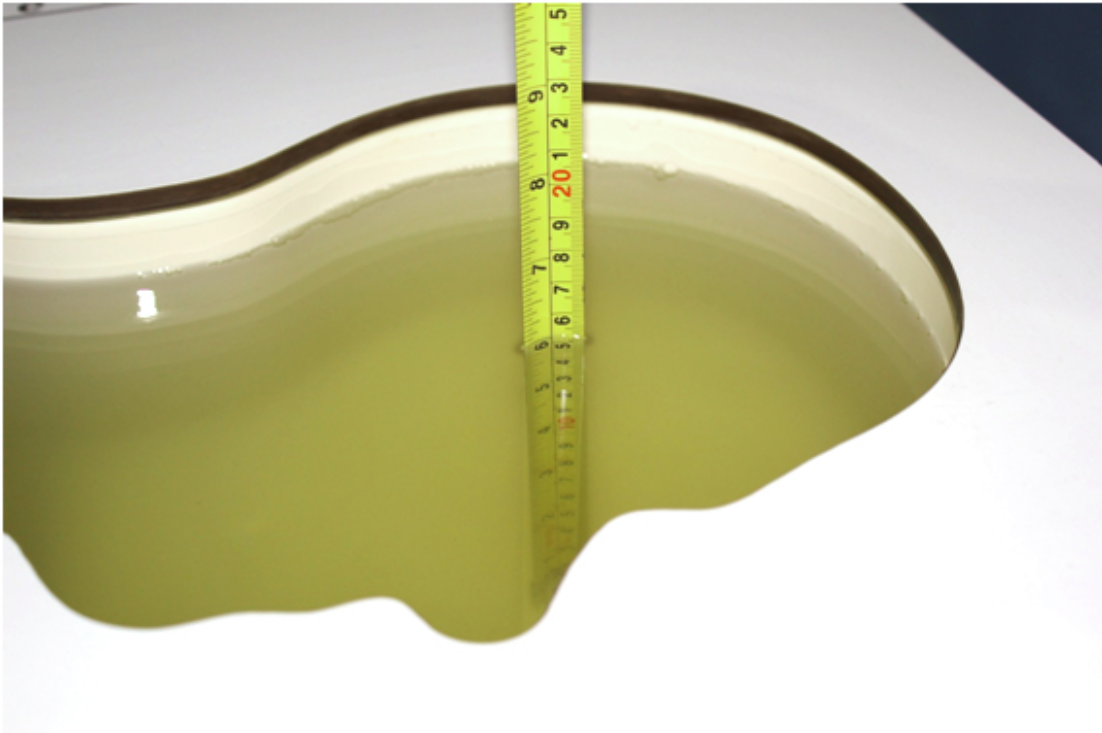

Picture 7-7 Liquid depth in the Head Phantom (2600 MHz Head)

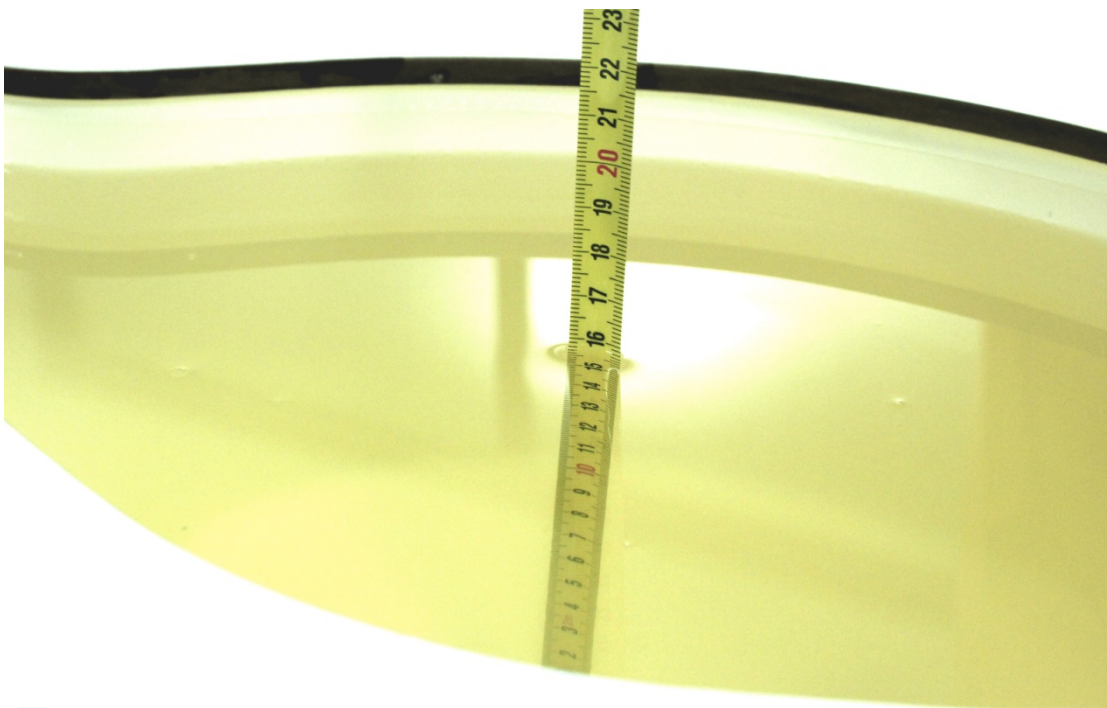

Picture 7-8 Liquid depth in the Flat Phantom (2600MHz)

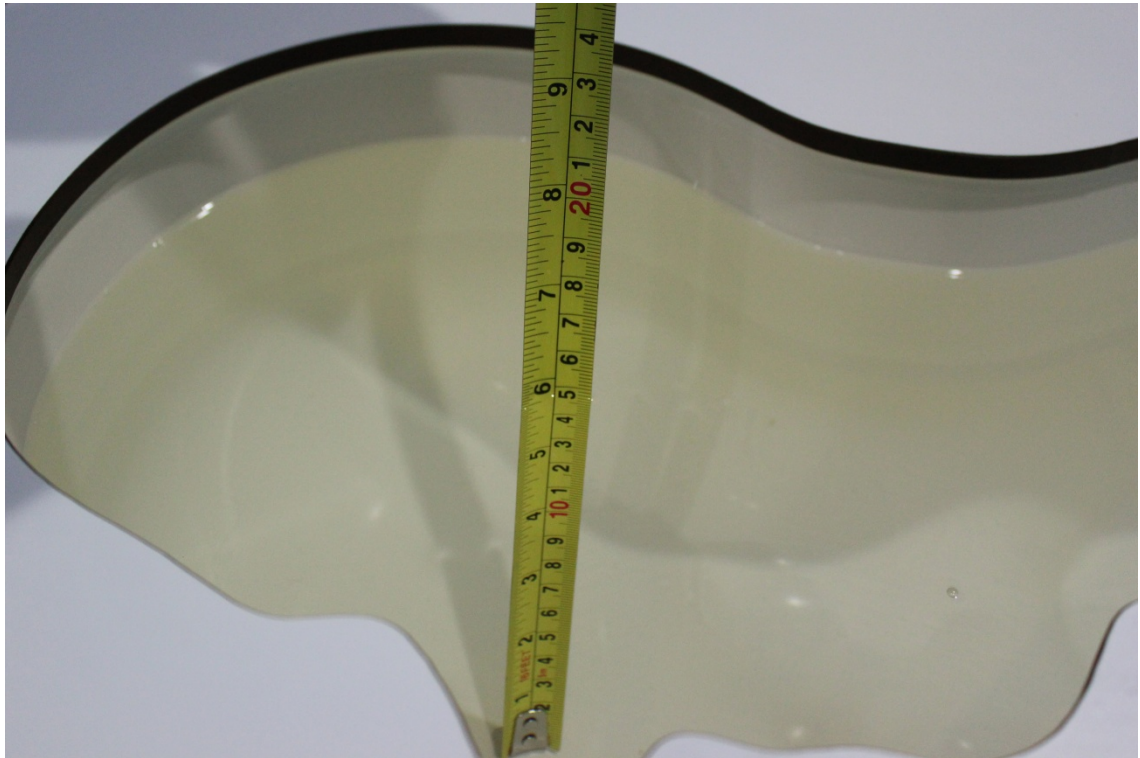

Picture 7-9 Liquid depth in the Head Phantom (5GHz)

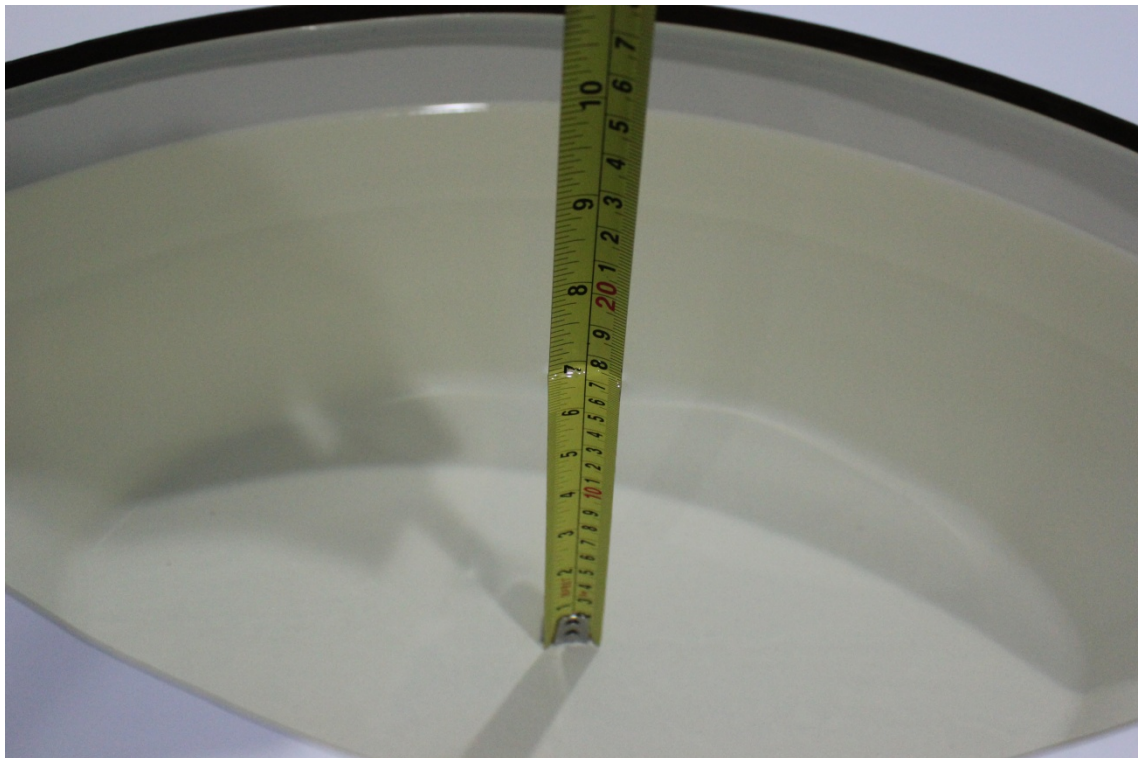

Picture 7-10 Liquid depth in the Flat Phantom (5GHz)

8 System verification

8.1 System Setup

In the simplified setup for system evaluation, the DUT is replaced by a calibrated dipole and the power source is replaced by a continuous wave that comes from a signal generator. The calibrated dipole must be placed beneath the flat phantom section of the SAM twin phantom with the correct distance holder. The distance holder should touch the phantom surface with a light pressure at the reference marking and be oriented parallel to the long side of the phantom. The equipment setup is shown below:

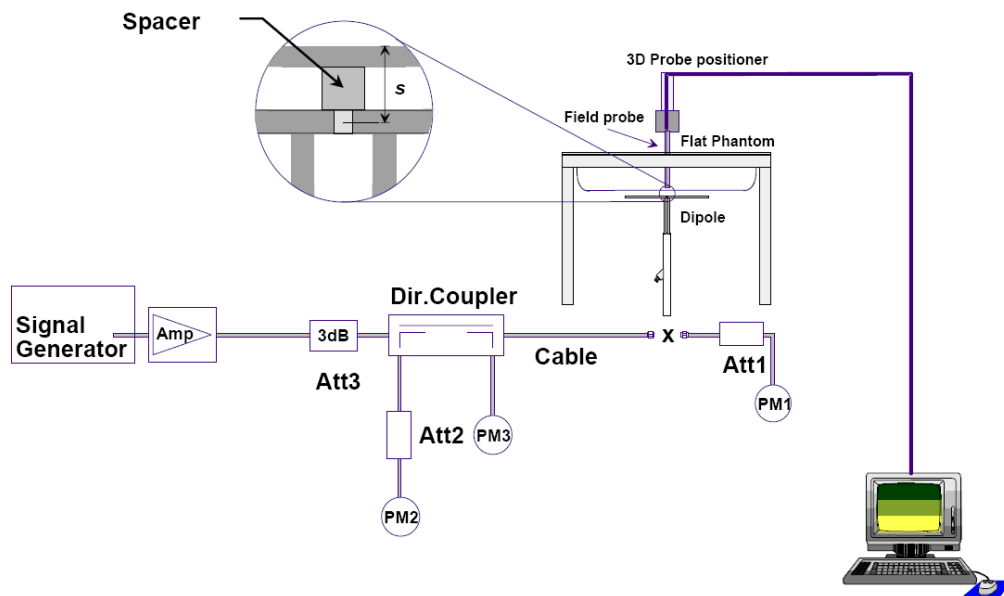

Picture 8.1 System Setup for System Evaluation

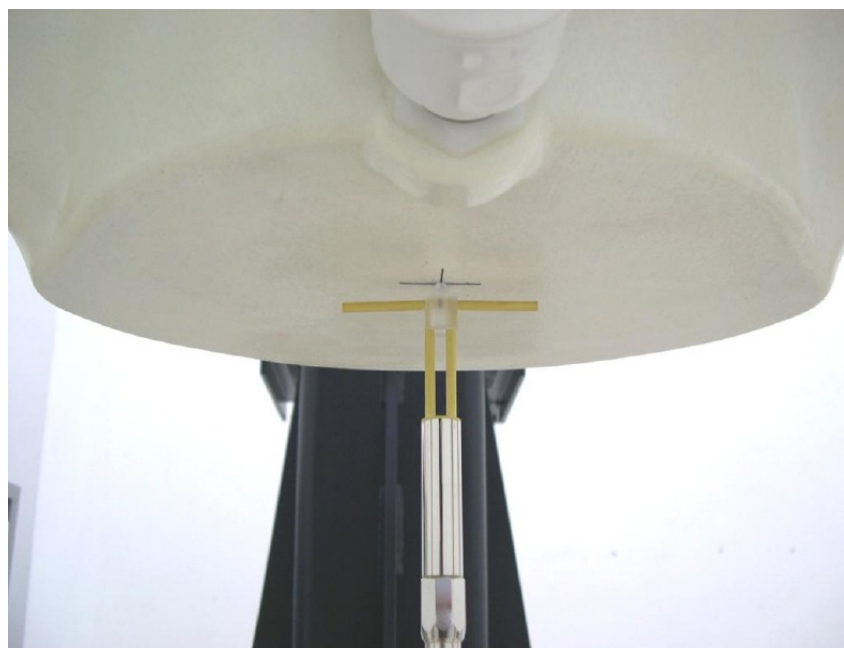

Picture 8.2 Photo of Dipole Setup

8.2 System Verification

SAR system verification is required to confirm measurement accuracy, according to the tissue dielectric media, probe calibration points and other system operating parameters required for measuring the SAR of a test device. The system verification must be performed for each frequency band and within the valid range of each probe calibration point required for testing the device.

The system verification results are required that the area scan estimated 1-g SAR is within 3% of the zoom scan 1-g SAR. The details are presented in annex B.

Table 8.1: System Verification of Head

Measurement Date (yyyy-mm-dd)	Frequency	Target value (W/kg)		Measured value(W/kg)		Deviation	
		10 g Average	1 g Average	10 g Average	1 g Average	10 g Average	1 g Average
2017-4-6	835 MHz	6.18	9.44	6.2	9.56	0.32%	1.27%
2017-4-8	1900 MHz	21.2	40.7	21	41.28	-0.94%	1.43%
2017-4-9	2450 MHz	24.6	52.8	25.04	53.76	1.79%	1.82%
2017-4-10	2600 MHz	25.2	56.7	25.36	57.6	0.63%	1.59%
2017-4-11	5250 MHz	5.46	8.33	5.4	8.32	-1.10%	-0.12%
	5600 MHz	6.18	9.44	6.2	9.56	0.32%	1.27%
	5750 MHz	19.5	36.8	19.6	36.24	0.51%	-1.52%

Table 8.2: System Verification of Head for spot check

Measurement Date (yyyy-mm-dd)	Frequency	Target value (W/kg)		Measured value(W/kg)		Deviation	
		10 g Average	1 g Average	10 g Average	1 g Average	10 g Average	1 g Average
2017-5-21	835 MHz	6.18	9.44	6.28	9.64	1.62%	2.12%
2017-5-21	1900 MHz	21.2	40.7	21.2	41.2	-0.19%	1.23%
2017-5-22	2450 MHz	24.6	52.8	25.0	53.6	1.46%	1.52%
2017-5-20	2600 MHz	25.2	56.7	25.5	57.6	1.27%	1.59%
2017-5-22	5750 MHz	19.5	36.8	23.1	81.4	1.76%	2.01%

Table 8.3: System Verification of Body

Measurement Date (yyyy-mm-dd)	Frequency	Target value (W/kg)		Measured value (W/kg)		Deviation	
		10 g Average	1 g Average	10 g Average	1 g Average	10 g Average	1 g Average
2017-4-6	835 MHz	6.36	9.69	6.20	9.64	-2.52%	-0.52%
2017-4-8	1900 MHz	21.3	40.1	21.48	41	0.85%	2.24%
2017-4-9	2450 MHz	24.1	51.2	24.72	52.76	2.57%	3.05%
2017-4-10	2600 MHz	24.8	55.3	25.24	56.8	1.77%	2.71%
2017-4-11	5250 MHz	21.2	75.6	21.30	75.40	0.47%	-0.26%
	5600 MHz	22.1	79.1	22.50	79.30	1.81%	0.25%
	5750 MHz	20.8	74.5	20.90	74.20	0.48%	-0.40%

Table 8.4: System Verification of Body for spot check

Measurement Date (yyyy-mm-dd)	Frequency	Target value (W/kg)		Measured value (W/kg)		Deviation	
		10 g Average	1 g Average	10 g Average	1 g Average	10 g Average	1 g Average
2017-5-21	835 MHz	6.36	9.69	6.32	9.40	-0.63%	-2.99%
2017-5-21	1900 MHz	21.3	40.1	21.04	40.40	-1.22%	0.75%
2017-5-22	2450 MHz	24.1	51.2	24.36	52.40	1.08%	2.34%
2017-5-20	2600 MHz	24.8	55.3	25.28	55.60	1.94%	0.54%
2017-5-22	5750 MHz	20.8	74.5	21.40	74.90	2.88%	0.54%

9 Measurement Procedures

9.1 Tests to be performed

In order to determine the highest value of the peak spatial-average SAR of a handset, all device positions, configurations and operational modes shall be tested for each frequency band according to steps 1 to 3 below. A flowchart of the test process is shown in picture 9.1.

Step 1: The tests described in 9.2 shall be performed at the channel that is closest to the center of the transmit frequency band (f_c) for:

- all device positions (cheek and tilt, for both left and right sides of the SAM phantom, as described in annex D),
- all configurations for each device position in a), e.g., antenna extended and retracted, and
- all operational modes, e.g., analogue and digital, for each device position in a) and configuration in b) in each frequency band.

If more than three frequencies need to be tested according to 11.1 (i.e., $N_c > 3$), then all frequencies, configurations and modes shall be tested for all of the above test conditions.

Step 2: For the condition providing highest peak spatial-average SAR determined in Step 1, perform all tests described in 9.2 at all other test frequencies, i.e., lowest and highest frequencies. In addition, for all other conditions (device position, configuration and operational mode) where the peak spatial-average SAR value determined in Step 1 is within 3 dB of the applicable SAR limit, it is recommended that all other test frequencies shall be tested as well.

Step 3: Examine all data to determine the highest value of the peak spatial-average SAR found in Steps 1 to 2.

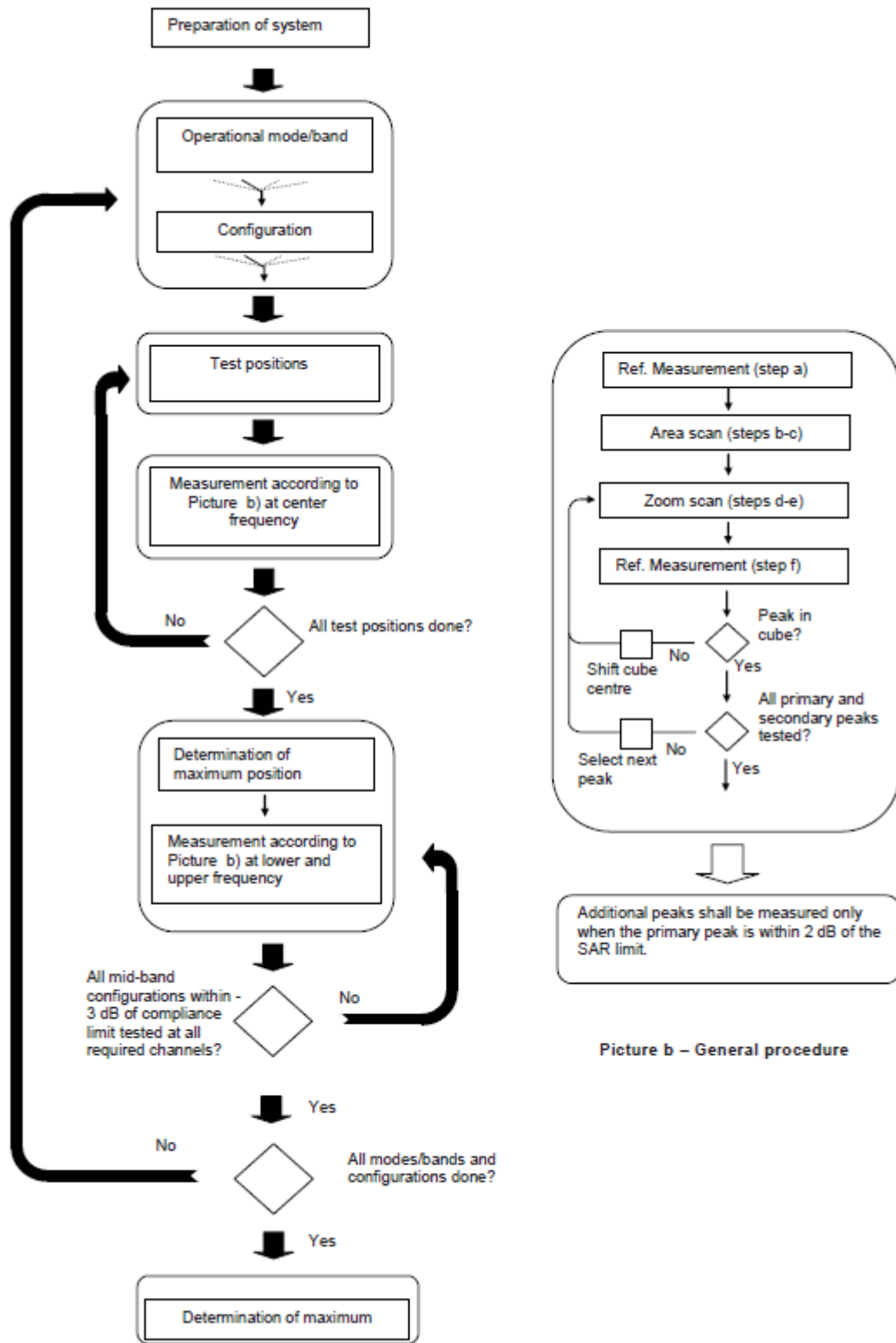

Picture a – Tests to be performed

Picture b – General procedure

Picture 9.1 Block diagram of the tests to be performed

9.2 General Measurement Procedure

The area and zoom scan resolutions specified in the table below must be applied to the SAR measurements and fully documented in SAR reports to qualify for TCB approval. Probe boundary effect error compensation is required for measurements with the probe tip closer than half a probe tip diameter to the phantom surface. Both the probe tip diameter and sensor offset distance must satisfy measurement protocols; to ensure probe boundary effect errors are minimized and the higher fields closest to the phantom surface can be correctly measured and extrapolated to the phantom surface for computing 1-g SAR. Tolerances of the post-processing algorithms must be verified by the test laboratory for the scan resolutions used in the SAR measurements, according to the reference distribution functions specified in IEEE Std 1528-2003. The results should be documented as part of the system validation records and may be requested to support test results when all the measurement parameters in the following table are not satisfied.

		≤ 3 GHz	> 3 GHz
Maximum distance from closest measurement point (geometric center of probe sensors) to phantom surface		5 ± 1 mm	$\frac{1}{2} \cdot \delta \cdot \ln(2) \pm 0.5$ mm
Maximum probe angle from probe axis to phantom surface normal at the measurement location		$30^\circ \pm 1^\circ$	$20^\circ \pm 1^\circ$
Maximum area scan spatial resolution: Δx_{Area} , Δy_{Area}		≤ 2 GHz: ≤ 15 mm 2 – 3 GHz: ≤ 12 mm	3 – 4 GHz: ≤ 12 mm 4 – 6 GHz: ≤ 10 mm
		When the x or y dimension of the test device, in the measurement plane orientation, is smaller than the above, the measurement resolution must be \leq the corresponding x or y dimension of the test device with at least one measurement point on the test device.	
Maximum zoom scan spatial resolution: Δx_{Zoom} , Δy_{Zoom}		≤ 2 GHz: ≤ 8 mm 2 – 3 GHz: ≤ 5 mm*	3 – 4 GHz: ≤ 5 mm* 4 – 6 GHz: ≤ 4 mm*
Maximum zoom scan spatial resolution, normal to phantom surface	uniform grid: $\Delta z_{Zoom}(n)$	≤ 5 mm	3 – 4 GHz: ≤ 4 mm 4 – 5 GHz: ≤ 3 mm 5 – 6 GHz: ≤ 2 mm
	graded grid	$\Delta z_{Zoom}(1)$: between 1 st two points closest to phantom surface	≤ 4 mm
		$\Delta z_{Zoom}(n>1)$: between subsequent points	$\leq 1.5 \cdot \Delta z_{Zoom}(n-1)$
Minimum zoom scan volume	x, y, z	≥ 30 mm	3 – 4 GHz: ≥ 28 mm 4 – 5 GHz: ≥ 25 mm 5 – 6 GHz: ≥ 22 mm
<p>Note: δ is the penetration depth of a plane-wave at normal incidence to the tissue medium; see draft standard IEEE P1528-2011 for details.</p> <p>* When zoom scan is required and the <i>reported</i> SAR from the area scan based 1-g SAR estimation procedures of KDB 447498 is ≤ 1.4 W/kg, ≤ 8 mm, ≤ 7 mm and ≤ 5 mm zoom scan resolution may be applied, respectively, for 2 GHz to 3 GHz, 3 GHz to 4 GHz and 4 GHz to 6 GHz.</p>			

9.3 WCDMA Measurement Procedures for SAR

The following procedures are applicable to WCDMA handsets operating under 3GPP Release99, Release 5 and Release 6. The default test configuration is to measure SAR with an established radio link between the DUT and a communication test set using a 12.2kbps RMC (reference measurement channel) configured in Test Loop Mode 1. SAR is selectively confirmed for other physical channel configurations (DPCCH & DPDCH_n), HSDPA and HSPA (HSUPA/HSDPA) modes according to output power, exposure conditions and device operating capabilities. Both uplink and downlink should be configured with the same RMC or AMR, when required. SAR for Release 5 HSDPA and Release 6 HSPA are measured using the applicable FRC (fixed reference channel) and E-DCH reference channel configurations. Maximum output power is verified according to applicable versions of 3GPP TS 34.121 and SAR must be measured according to these maximum output conditions. When Maximum Power Reduction (MPR) is not implemented according to Cubic Metric (CM) requirements for Release 6 HSPA, the following procedures do not apply.

For Release 5 HSDPA Data Devices:

Sub-test	β_c	β_d	β_d (SF)	β_c / β_d	β_{hs}	CM/dB
1	2/15	15/15	64	2/15	4/15	0.0
2	12/15	15/15	64	12/15	24/25	1.0
3	15/15	8/15	64	15/8	30/15	1.5
4	15/15	4/15	64	15/4	30/15	1.5

For Release 6 HSPA Data Devices

Sub-test	β_c	β_d	β_d (SF)	β_c / β_d	β_{hs}	β_{ec}	β_{ed}	β_{ed} (SF)	β_{ed} (codes)	CM (dB)	MPR (dB)	AG Index	E-TFCI
1	11/15	15/15	64	11/15	22/15	209/225	1039/225	4	1	1.5	1.5	20	75
2	6/15	15/15	64	6/15	12/15	12/15	12/15	4	1	1.5	1.5	12	67
3	15/15	9/15	64	15/9	30/15	30/15	$\beta_{ed1:47/15}$ $\beta_{ed2:47/15}$	4	2	1.5	1.5	15	92
4	2/15	15/15	64	2/15	4/15	4/15	56/75	4	1	1.5	1.5	17	71
5	15/15	15/15	64	15/15	24/15	30/15	134/15	4	1	1.5	1.5	21	81

Rel.8 DC-HSDPA (Cat 24)

SAR test exclusion for Rel.8 DC-HSDPA must satisfy the SAR test exclusion requirements of Rel.5 HSDPA. SAR test exclusion for DC-HSDPA devices is determined by power measurements according to the H-Set 12, Fixed Reference Channel (FRC) configuration in Table C.8.1.12 of 3GPP TS 34.121-1. A primary and a secondary serving HS-DSCH Cell are required to perform the power measurement and for the results to qualify for SAR test exclusion.

9.4 SAR Measurement for LTE

SAR tests for LTE are performed with a base station simulator, Rohde & Schwarz CMW500. Closed loop power control was used so the UE transmits with maximum output power during SAR testing. All powers were measured with the CMW 500.

It is performed for conducted power and SAR based on the KDB941225 D05.

SAR is evaluated separately according to the following procedures for the different test positions in each exposure condition – head, body, body-worn accessories and other use conditions. The procedures in the following subsections are applied separately to test each LTE frequency band.

1) QPSK with 1 RB allocation

Start with the largest channel bandwidth and measure SAR for QPSK with 1 RB allocation, using the RB offset and required test channel combination with the highest maximum output power among RB offsets at the upper edge, middle and lower edge of each required test channel. When the reported SAR is ≤ 0.8 W/kg, testing of the remaining RB offset configurations and required test channels is not required for 1 RB allocation; otherwise, SAR is required for the remaining required test channels and only for the RB offset configuration with the highest output power for that channel. When the reported SAR of a required test channel is > 1.45 W/kg, SAR is required for all three RB offset configurations for that required test channel.

2) QPSK with 50% RB allocation

The procedures required for 1 RB allocation in 1) are applied to measure the SAR for QPSK with 50% RB allocation.

3) QPSK with 100% RB allocation

For QPSK with 100% RB allocation, SAR is not required when the highest maximum output power for 100 % RB allocation is less than the highest maximum output power in 50% and 1 RB allocations and the highest reported SAR for 1 RB and 50% RB allocation in 1) and 2) are ≤ 0.8 W/kg. Otherwise, SAR is measured for the highest output power channel; and if the reported SAR is > 1.45 W/kg, the remaining required test channels must also be tested.

9.5 Bluetooth & Wi-Fi Measurement Procedures for SAR

Normal network operating configurations are not suitable for measuring the SAR of 802.11 transmitters in general. Unpredictable fluctuations in network traffic and antenna diversity conditions can introduce undesirable variations in SAR results. The SAR for these devices should be measured using chipset based test mode software to ensure that the results are consistent and reliable.

Chipset based test mode software is hardware dependent and generally varies among manufacturers. The device operating parameters established in a test mode for SAR measurements must be identical to those programmed in production units, including output power levels, amplifier gain settings and other RF performance tuning parameters. The test frequencies should correspond to actual channel frequencies defined for domestic use. SAR for devices with switched diversity should be measured with only one antenna transmitting at a time during each SAR measurement, according to a fixed modulation and data rate. The same data pattern should be used for all measurements.

9.6 Power Drift

To control the output power stability during the SAR test, DASY4 system calculates the power drift by measuring the E-field at the same location at the beginning and at the end of the measurement for each test position. These drift values can be found in section 14 labeled as: (Power Drift [dB]). This ensures that the power drift during one measurement is within 5%.

10 Area Scan Based 1-g SAR

10.1 Requirement of KDB

According to the KDB447498 D01 v05, when the implementation is based the specific polynomial fit algorithm as presented at the 29th Bioelectromagnetics Society meeting (2007) and the estimated 1-g SAR is ≤ 1.2 W/kg, a zoom scan measurement is not required provided it is also not needed for any other purpose; for example, if the peak SAR location required for simultaneous transmission SAR test exclusion can be determined accurately by the SAR system or manually to discriminate between distinctive peaks and scattered noisy SAR distributions from area scans.

There must not be any warning or alert messages due to various measurement concerns identified by the SAR system; for example, noise in measurements, peaks too close to scan boundary, peaks are too sharp, spatial resolution and uncertainty issues etc. The SAR system verification must also demonstrate that the area scan estimated 1-g SAR is within 3% of the zoom scan 1-g SAR (See Annex B). When all the SAR results for each exposure condition in a frequency band and wireless mode are based on estimated 1-g SAR, the 1-g SAR for the highest SAR configuration must be determined by a zoom scan.

10.2 Fast SAR Algorithms

The approach is based on the area scan measurement applying a frequency dependent attenuation parameter. This attenuation parameter was empirically determined by analyzing a large number of phones. The MOTOROLA FAST SAR was developed and validated by the MOTOROLA Research Group in Ft. Lauderdale.

In the initial study, an approximation algorithm based on Linear fit was developed. The accuracy of the algorithm has been demonstrated across a broad frequency range (136-2450 MHz) and for both 1- and 10-g averaged SAR using a sample of 264 SAR measurements from 55 wireless handsets. For the sample size studied, the root-mean-squared errors of the algorithm are 1.2% and 5.8% for 1- and 10-g averaged SAR, respectively. The paper describing the algorithm in detail is expected to be published in August 2004 within the Special Issue of Transactions on MTT.

In the second step, the same research group optimized the fitting algorithm to an Polynomial fit whereby the frequency validity was extended to cover the range 30-6000MHz. Details of this study can be found in the BEMS 2007 Proceedings.

Both algorithms are implemented in DASY software.

11 Conducted Output Power

11.1 GSM Measurement result

During the process of testing, the EUT was controlled via Agilent Digital Radio Communication tester (E5515C) to ensure the maximum power transmission and proper modulation. This result contains conducted output power for the EUT. In all cases, the measured peak output power should be greater and within 5% than EMI measurement.

Table 11- 1 GSM850

GSM850								
Config	Tune-up	Measured Power (dBm)			Calculation	Average Power (dBm)		
		CH251 848.8 MHz	CH190 836.6 MHz	CH128 824.2 MHz		CH251 848.8 MHz	CH190 836.6 MHz	CH128 824.2 MHz
GSM Speech	33.60	33.55	33.55	33.49				
GPRS 1 Txslot	33.60	33.46	33.47	33.43	-9.03	24.43	24.44	24.40
GPRS 2 Txslots	31.50	30.58	30.66	30.72	-6.02	24.56	24.64	24.70
GPRS 3 Txslots	30.50	29.71	29.72	30.04	-4.26	25.45	25.46	25.78
GPRS 4 Txslots	29.00	28.70	28.76	28.80	-3.01	25.69	25.75	25.79
EGPRS GMSK 1 Txslot	33.60	33.45	33.45	33.44	-9.03	24.42	24.42	24.41
EGPRS GMSK 2 Txslots	31.50	30.58	30.66	30.73	-6.02	24.56	24.64	24.71
EGPRS GMSK 3 Txslots	30.50	29.70	29.77	30.03	-4.26	25.44	25.51	25.77
EGPRS GMSK 4 Txslots	29.00	28.69	28.76	28.79	-3.01	25.68	25.75	25.78
EGPRS 8PSK 1 Txslot	29.00	28.50	28.54	28.62	-9.03	19.47	19.51	19.59
EGPRS 8PSK 2 Txslots	28.00	27.35	27.42	27.52	-6.02	21.33	21.40	21.50
EGPRS 8PSK 3 Txslots	26.50	26.28	26.33	26.38	-4.26	22.02	22.07	22.12
EGPRS 8PSK 4 Txslots	25.50	25.17	25.27	25.25	-3.01	22.16	22.26	22.24

**Table 11- 2
PCS1900**

PCS1900								
Config	Tune-up	Measured Power (dBm)			Calculation	Average Power (dBm)		
		CH810 1909.8 MHz	CH661 1880 MHz	CH512 1850.2 MHz		CH810 1909.8 MHz	CH661 1880 MHz	CH512 1850.2 MHz
GSM Speech	31.00	30.81	30.92	30.99				
GPRS 1 Txslot	31.50	30.84	30.96	31.01	-9.03	21.81	21.93	21.98
GPRS 2 Txslots	30.50	29.92	30.19	30.19	-6.02	23.90	24.17	24.17
GPRS 3 Txslots	29.50	29.07	28.95	29.00	-4.26	24.81	24.69	24.74
GPRS 4 Txslots	28.00	27.96	27.83	27.85	-3.01	24.95	24.82	24.84
EGPRS GMSK 1 Txslot	31.50	30.83	30.94	31.04	-9.03	21.80	21.91	22.01
EGPRS GMSK 2 Txslots	30.50	29.91	30.21	30.21	-6.02	23.89	24.19	24.19
EGPRS GMSK 3 Txslots	29.50	29.07	28.93	29.00	-4.26	24.81	24.67	24.74
EGPRS GMSK 4 Txslots	28.00	27.94	27.81	27.85	-3.01	24.93	24.80	24.84
EGPRS 8PSK 1 Txslot	28.00	27.86	27.83	27.83	-9.03	18.83	18.80	18.80
EGPRS 8PSK 2 Txslots	27.00	26.92	26.85	26.80	-6.02	20.90	20.83	20.78
EGPRS 8PSK 3 Txslots	26.00	25.85	25.79	25.65	-4.26	21.59	21.53	21.39
EGPRS 8PSK 4 Txslots	25.00	24.84	24.73	24.57	-3.01	21.83	21.72	21.56

NOTES:

Division Factors

To average the power, the division factor is as follows:

1TX-slot = 1 transmit time slot out of 8 time slots=> conducted power divided by (8/1) => -9.03dB

2TX-slots = 2 transmit time slots out of 8 time slots=> conducted power divided by (8/2) => -6.02dB

3TX-slots = 3 transmit time slots out of 8 time slots=> conducted power divided by (8/3) => -4.26dB

4TX-slots = 4 transmit time slots out of 8 time slots=> conducted power divided by (8/4) => -3.01dB

According to the conducted power as above, the body measurements are performed with 4Txslots for GSM850 and PCS1900.

11.2 WCDMA Measurement result

Table 11- 3
WCDMA1900-BII

WCDMA1900-BII					
Item		Tune-up	Measured Power (dBm)		
			CH9538 1907.6 MHz	CH9400 1880 MHz	CH9262 1852.4 MHz
WCDMA	RMC	24.50	24.24	23.99	24.02
HSUPA	subtest1	24.50	24.19	24.18	23.78
	subtest2	24.50	22.99	23.51	23.26
	subtest3	24.50	22.68	23.17	22.97
	subtest4	24.50	23.95	24.08	23.91
	subtest5	24.50	24.44	24.48	24.36
DC-HSDPA	subtest1	23.00	22.83	22.86	22.72
	subtest2	23.00	22.81	22.88	22.71
	subtest3	23.00	22.83	22.84	22.71
	subtest4	23.00	22.84	22.85	22.73

Table 11- 4
WCDMA850-BV

WCDMA850-BV					
Item		Tune-up	Measured Power (dBm)		
			CH4233 846.6 MHz	CH4715 835.4 MHz	CH4132 826.4 MHz
WCDMA	RMC	24.50	24.42	24.39	24.50
HSUPA	subtest1	24.50	24.09	24.14	23.72
	subtest2	24.50	23.43	23.47	23.41
	subtest3	24.50	23.01	23.06	23.02
	subtest4	24.50	23.89	23.84	23.89
	subtest5	24.50	24.34	24.31	24.30
DC-HSDPA	subtest1	23.00	22.86	22.87	22.86
	subtest2	23.00	22.84	22.88	22.85
	subtest3	23.00	22.85	22.87	22.84
	subtest4	23.00	22.87	22.86	22.83

11.3 LTE Measurement result

Table 11- 5
LTE2500-FDD7

LTE2500-FDD7								
BandWidth	RB Number/Start channel/Frequency	Tune-up	Measured Power (dBm) & MPR					
			QPSK		16QAM			
			Measured Power	MPR	Measured Power	MPR		
5MHz	1H	21425	24.5	23.41	0	22.61	1	
		21100	24.5	23.38	0	22.07	1	
		20775	24.5	23.23	0	22.34	1	
	1M	21425	24.5	23.48	0	22.74	1	
		21100	24.5	23.35	0	22.08	1	
		20775	24.5	23.51	0	22.06	1	
	1L	21425	24.5	23.38	0	22.72	1	
		21100	24.5	23.51	0	22.10	1	
		20775	24.5	23.40	0	22.23	1	
	12H	21425	24.5	22.42	1	21.56	2	
		21100	24.5	22.52	1	21.62	2	
		20775	24.5	22.44	1	21.61	2	
	12M	21425	24.5	22.47	1	21.73	2	
		21100	24.5	22.56	1	21.67	2	
		20775	24.5	22.61	1	21.68	2	
	12L	21425	24.5	22.52	1	21.68	2	
		21100	24.5	22.57	1	21.68	2	
		20775	24.5	22.51	1	21.70	2	
	25	21425	24.5	22.46	1	21.77	2	
		21100	24.5	22.58	1	21.72	2	
		20775	24.5	22.53	1	21.66	2	
	10MHz	1H	21400	24.5	23.54	0	23.10	1
			21100	24.5	23.72	0	22.70	1
			20800	24.5	23.26	0	23.03	1
1M		21400	24.5	23.77	0	23.19	1	
		21100	24.5	23.72	0	22.88	1	
		20800	24.5	23.65	0	23.11	1	
1L		21400	24.5	23.59	0	23.20	1	
		21100	24.5	23.61	0	22.85	1	
		20800	24.5	23.41	0	23.10	1	
25H		21400	24.5	22.48	1	21.68	2	
		21100	24.5	22.56	1	21.68	2	
		20800	24.5	22.57	1	21.60	2	
25M		21400	24.5	22.57	1	21.75	2	
		21100	24.5	22.59	1	21.73	2	
		20800	24.5	22.54	1	21.57	2	
25L		21400	24.5	22.45	1	21.81	2	
		21100	24.5	22.61	1	21.65	2	
		20800	24.5	22.54	1	21.56	2	
50		21400	24.5	22.51	1	21.70	2	
		21100	24.5	22.55	1	21.59	2	
		20800	24.5	22.61	1	21.54	2	
15MHz		1H	21375	24.5	23.37	0	22.73	1
			21100	24.5	23.76	0	22.96	1
			20825	24.5	23.36	0	23.20	1
	1M	21375	24.5	23.48	0	22.80	1	
		21100	24.5	23.70	0	22.86	1	
		20825	24.5	23.68	0	23.24	1	
	1L	21375	24.5	23.52	0	23.00	1	
		21100	24.5	23.57	0	22.94	1	
		20825	24.5	23.36	0	23.23	1	
	36H	21375	24.5	22.48	1	21.61	2	
		21100	24.5	22.65	1	21.66	2	
		20825	24.5	22.56	1	21.59	2	
	36M	21375	24.5	22.59	1	21.68	2	
		21100	24.5	22.56	1	21.58	2	
		20825	24.5	22.58	1	21.57	2	
	36L	21375	24.5	22.62	1	21.70	2	
		21100	24.5	22.61	1	21.72	2	
		20825	24.5	22.55	1	21.65	2	
	75	21375	24.5	22.51	1	21.60	2	
		21100	24.5	22.64	1	21.60	2	
		20825	24.5	22.62	1	21.57	2	



20MHz	1H	21350	24.5	23.69	0	22.53	1
		21100	24.5	23.53	0	22.89	1
		20850	24.5	23.48	0	22.41	1
	1M	21350	24.5	23.93	0	22.80	1
		21100	24.5	23.55	0	22.74	1
		20850	24.5	23.78	0	22.56	1
	1L	21350	24.5	23.71	0	22.78	1
		21100	24.5	23.23	0	22.88	1
		20850	24.5	23.52	0	22.61	1
	50H	21350	24.5	22.42	1	21.67	2
		21100	24.5	22.64	1	21.77	2
		20850	24.5	22.55	1	21.69	2
	50M	21350	24.5	22.66	1	21.68	2
		21100	24.5	22.52	1	21.67	2
		20850	24.5	22.58	1	21.65	2
	50L	21350	24.5	22.59	1	21.69	2
		21100	24.5	22.64	1	21.71	2
		20850	24.5	22.59	1	21.67	2
	100	21350	24.5	22.60	1	21.71	2
		21100	24.5	22.62	1	21.62	2
		20850	24.5	22.54	1	21.63	2

Table 11- 6
LTE2600-TDD38

LTE2600-TDD38								
BandWidth	RB Number/Start Channel/Frequency	Tune-up	Measured Power (dBm) & MPR					
			QPSK		16QAM			
			Measured Power	MPR	Measured Power	MPR		
5MHz	1H	38225	24.5	23.28	0	22.90	1	
		38000	24.5	23.26	0	22.52	1	
		37775	24.5	23.41	0	22.57	1	
	1M	38225	24.5	23.41	0	22.83	1	
		38000	24.5	23.45	0	22.73	1	
		37775	24.5	23.49	0	22.76	1	
	1L	38225	24.5	23.34	0	22.87	1	
		38000	24.5	23.43	0	22.79	1	
		37775	24.5	23.45	0	22.73	1	
	12H	38225	24.5	22.63	1	21.59	2	
		38000	24.5	22.43	1	21.46	2	
		37775	24.5	22.37	1	21.55	2	
	12M	38225	24.5	22.52	1	21.63	2	
		38000	24.5	22.49	1	21.54	2	
		37775	24.5	22.50	1	21.71	2	
	12L	38225	24.5	22.49	1	21.60	2	
		38000	24.5	22.45	1	21.55	2	
		37775	24.5	22.56	1	21.72	2	
	25	38225	24.5	22.45	1	21.62	2	
		38000	24.5	22.51	1	21.63	2	
		37775	24.5	22.49	1	21.59	2	
	10MHz	1H	38200	24.5	23.49	0	22.74	1
			38000	24.5	23.45	0	22.61	1
			37800	24.5	23.40	0	22.75	1
1M		38200	24.5	23.69	0	22.69	1	
		38000	24.5	23.50	0	22.88	1	
		37800	24.5	23.53	0	22.55	1	
1L		38200	24.5	23.36	0	22.67	1	
		38000	24.5	23.37	0	22.76	1	
		37800	24.5	23.48	0	22.75	1	
25H		38200	24.5	21.52	1	21.61	2	
		38000	24.5	21.53	1	21.62	2	
		37800	24.5	21.58	1	21.62	2	
25M		38200	24.5	21.60	1	21.60	2	
		38000	24.5	21.61	1	21.61	2	
		37800	24.5	21.61	1	21.61	2	
25L		38200	24.5	22.49	1	21.60	2	
		38000	24.5	22.51	1	21.77	2	
		37800	24.5	22.50	1	21.64	2	
50		38200	24.5	21.59	1	21.70	2	
		38000	24.5	21.59	1	21.59	2	
		37800	24.5	21.68	1	21.70	2	
15MHz		1H	38175	24.5	23.44	0	22.71	1
			38000	24.5	23.24	0	22.72	1
			37825	24.5	23.35	0	22.74	1
	1M	38175	24.5	23.37	0	22.57	1	
		38000	24.5	23.48	0	22.58	1	
		37825	24.5	23.39	0	22.69	1	
	1L	38175	24.5	23.43	0	22.60	1	
		38000	24.5	23.52	0	22.60	1	
		37825	24.5	23.36	0	22.62	1	
	36H	38175	24.5	22.51	1	21.55	2	
		38000	24.5	21.50	1	21.59	2	
		37825	24.5	21.61	1	21.59	2	
	36M	38175	24.5	22.60	1	21.66	2	
		38000	24.5	21.59	1	21.58	2	
		37825	24.5	21.59	1	21.58	2	
	36L	38175	24.5	22.55	1	21.59	2	
		38000	24.5	21.58	1	21.63	2	
		37825	24.5	21.58	1	21.67	2	
	75	38175	24.5	22.59	1	21.67	2	
		38000	24.5	21.76	1	21.76	2	
		37825	24.5	21.57	1	21.57	2	



20MHz	1H	38150	24.5	23.57	0	22.64	1
		38000	24.5	23.50	0	22.74	1
		37850	24.5	23.52	0	22.74	1
	1M	38150	24.5	23.74	0	22.88	1
		38000	24.5	23.40	0	22.80	1
		37850	24.5	23.42	0	22.65	1
	1L	38150	24.5	23.62	0	22.90	1
		38000	24.5	23.45	0	22.32	1
		37850	24.5	23.38	0	22.33	1
	50H	38150	24.5	22.50	1	21.24	2
		38000	24.5	22.49	1	21.31	2
		37850	24.5	22.36	1	21.50	2
	50M	38150	24.5	22.44	1	21.36	2
		38000	24.5	22.47	1	21.39	2
		37850	24.5	22.46	1	21.49	2
	50L	38150	24.5	22.51	1	21.32	2
		38000	24.5	22.44	1	21.34	2
		37850	24.5	22.53	1	21.56	2
	100	38150	24.5	22.41	1	21.46	2
		38000	24.5	22.44	1	21.48	2
		37850	24.5	22.43	1	21.22	2

Table 11- 7 LTE850-FDD5

LTE850-FDD5							
BandWidth	RB Number/Stan	channel/Frequen	Tune-up	Measured Power (dBm) & MPR			
				QPSK		16QAM	
				Measured Power	MPR	Measured Power	MPR
1.4MHz	1H	20643	24.9	24.02	0	23.09	1
		20525	24.9	23.89	0	23.61	1
		20407	24.9	23.93	0	23.55	1
	1M	20643	24.9	24.13	0	23.37	1
		20525	24.9	24.11	0	23.44	1
		20407	24.9	24.00	0	23.15	1
	1L	20643	24.9	23.99	0	23.51	1
		20525	24.9	23.91	0	23.21	1
		20407	24.9	23.76	0	22.97	1
	3H	20643	24.9	24.13	0	22.95	1
		20525	24.9	24.08	0	22.80	1
		20407	24.9	23.89	0	22.86	1
	3M	20643	24.9	24.03	0	22.88	1
		20525	24.9	24.08	0	22.67	1
		20407	24.9	23.88	0	22.64	1
	3L	20643	24.9	23.98	0	23.28	1
		20525	24.9	23.88	0	22.92	1
		20407	24.9	23.80	0	22.68	1
6	20643	24.9	22.97	1	22.02	2	
	20525	24.9	22.93	1	21.83	2	
	20407	24.9	22.86	1	21.64	2	
3MHz	1H	20635	24.9	24.13	0	23.42	1
		20525	24.9	24.02	0	23.08	1
		20415	24.9	24.00	0	23.42	1
	1M	20635	24.9	24.11	0	23.46	1
		20525	24.9	24.02	0	23.15	1
		20415	24.9	23.98	0	23.44	1
	1L	20635	24.9	24.05	0	23.43	1
		20525	24.9	23.93	0	23.02	1
		20415	24.9	23.91	0	23.35	1
	8H	20635	24.9	23.10	1	21.94	2
		20525	24.9	23.09	1	21.92	2
		20415	24.9	23.08	1	22.14	2
	8M	20635	24.9	23.03	1	21.91	2
		20525	24.9	23.01	1	21.98	2
		20415	24.9	22.94	1	22.14	2
	8L	20635	24.9	22.98	1	21.95	2
		20525	24.9	22.82	1	22.02	2
		20415	24.9	22.95	1	22.01	2
15	20635	24.9	23.08	1	22.01	2	
	20525	24.9	22.90	1	21.94	2	
	20415	24.9	22.96	1	22.11	2	

5MHz	1H	20625	24.9	23.87	0	23.19	1	
		20525	24.9	23.99	0	23.12	1	
		20425	24.9	23.88	0	23.25	1	
	1M	20625	24.9	23.78	0	23.19	1	
		20525	24.9	23.75	0	23.25	1	
		20425	24.9	23.91	0	23.22	1	
	1L	20625	24.9	23.51	0	23.10	1	
		20525	24.9	23.72	0	23.09	1	
		20425	24.9	23.75	0	23.12	1	
	12H	20625	24.9	23.04	1	22.15	2	
		20525	24.9	22.99	1	21.85	2	
		20425	24.9	23.12	1	22.25	2	
	12M	20625	24.9	22.98	1	21.92	2	
		20525	24.9	22.99	1	21.86	2	
		20425	24.9	23.05	1	21.96	2	
	12L	20625	24.9	22.86	1	21.79	2	
		20525	24.9	22.88	1	22.14	2	
		20425	24.9	22.98	1	22.25	2	
	25	20625	24.9	23.03	1	22.09	2	
		20525	24.9	22.92	1	21.98	2	
		20425	24.9	22.90	1	21.96	2	
	10MHz	1H	20600	24.9	24.06	0	23.38	1
			20525	24.9	24.05	0	23.17	1
			20450	24.9	23.81	0	23.50	1
		1M	20600	24.9	24.14	0	23.29	1
			20525	24.9	24.24	0	23.26	1
20450			24.9	23.86	0	23.45	1	
1L		20600	24.9	23.80	0	23.43	1	
		20525	24.9	23.69	0	23.19	1	
		20450	24.9	23.75	0	23.56	1	
25H		20600	24.9	23.07	1	22.08	2	
		20525	24.9	23.06	1	22.08	2	
		20450	24.9	22.97	1	21.93	2	
25M		20600	24.9	22.88	1	21.80	2	
		20525	24.9	22.93	1	21.83	2	
		20450	24.9	23.05	1	21.99	2	
25L		20600	24.9	22.81	1	21.72	2	
		20525	24.9	22.95	1	22.08	2	
		20450	24.9	22.91	1	22.04	2	
50		20600	24.9	22.88	1	21.89	2	
		20525	24.9	22.95	1	21.87	2	
		20450	24.9	22.95	1	21.97	2	

11.4 Wi-Fi and BT Measurement result

The output power of BT antenna is as following:

Table 11- 8 Bluetooth

Bluetooth Power				
Mode	Channel	Frequency	Tune-up	Measured
GFSK	78	2480 MHz	9.5	7.62
	39	2441 MHz	9.5	9.13
	0	2402 MHz	9.5	8

The average conducted power for Wi-Fi is as following:

Table 11- 9 WLAN 2450 802.11b

Channel\data rate	1Mbps	Tune up
1	15.94	16
6	15.79	16
11	15.76	16

Table 11- 10 WLAN 2450 802.11g

Channel\data rate	6Mbps	Tune up
1	12.41	12.5
6	12.31	12.5
11	12.28	12.5

Table 11- 11 WLAN 2450 802.11n - HT20

Channel\data rate	MCS0	Tune up
1	11.37	12.00
6	11.36	12.00
11	11.28	12.00

Table 11- 12 WLAN 5G 11a

Channel\data rate	6Mbps	Tune up
36(5180 MHz)	13.13	13.50
40(5200 MHz)	13.20	13.50
44(5220 MHz)	12.99	13.00
48(5240 MHz)	12.87	13.00
52(5260 MHz)	12.56	12.60
56(5280 MHz)	12.12	12.60
60(5300 MHz)	11.92	12.60
64(5320 MHz)	11.75	12.60
100(5500 MHz)	12.72	12.90

104(5520 MHz)	12.85	12.90
108(5540 MHz)	12.90	12.90
112(5560 MHz)	12.82	12.90
116(5580 MHz)	12.57	12.90
120(5600 MHz)	12.34	12.90
124(5620 MHz)	12.20	12.90
128(5640 MHz)	12.01	12.90
132(5660 MHz)	11.74	11.80
136(5680 MHz)	11.57	11.80
140(5700 MHz)	11.66	11.80
149(5745 MHz)	11.52	11.80
153(5765 MHz)	11.46	11.80
157(5785 MHz)	11.74	11.80
161(5805 MHz)	11.71	11.80
165(5825 MHz)	11.89	12.00

Table 11- 13 WLAN 5G 11n – HT20

Channel\data rate	MCS0	Tune up
36(5180 MHz)	12.07	12.50
40(5200 MHz)	11.95	12.00
44(5220 MHz)	11.94	12.00
48(5240 MHz)	11.76	12.00
52(5260 MHz)	11.51	12.00
56(5280 MHz)	11.05	12.00
60(5300 MHz)	10.86	11.00
64(5320 MHz)	10.70	11.00
100(5500 MHz)	11.54	12.00
104(5520 MHz)	11.67	12.00
108(5540 MHz)	11.71	12.00
112(5560 MHz)	11.62	12.00
116(5580 MHz)	11.48	12.00
120(5600 MHz)	11.47	12.00
124(5620 MHz)	11.28	12.00
128(5640 MHz)	11.14	12.00
132(5660 MHz)	10.87	11.00
136(5680 MHz)	10.70	11.00
140(5700 MHz)	10.53	11.00
149(5745 MHz)	10.30	11.00
153(5765 MHz)	10.43	11.00
157(5785 MHz)	10.46	11.00
161(5805 MHz)	10.44	11.00
165(5825 MHz)	10.59	11.00

Table 11- 14 WLAN 5G 11n – HT40

Channel\data rate	MCS0	Tune up
38(5190 MHz)	11.44	12.00
46(5230 MHz)	11.22	12.00
54(5270 MHz)	10.65	11.00
62(5310 MHz)	10.37	11.00
102(5510 MHz)	11.21	12.00
110(5550 MHz)	11.28	12.00
118(5590 MHz)	10.99	11.00
126(5630 MHz)	10.79	11.00
134(5670 MHz)	10.28	11.00
151(5755 MHz)	10.01	11.00
159(5795 MHz)	10.12	11.00

12 Simultaneous TX SAR Considerations

12.1 Introduction

The following procedures adopted from “FCC SAR Considerations for Cell Phones with Multiple Transmitters” are applicable to handsets with built-in unlicensed transmitters such as 802.11 a/b/g and Bluetooth devices which may simultaneously transmit with the licensed transmitter. For this device, the BT and Wi-Fi can transmit simultaneous with other transmitters.

12.2 Transmit Antenna Separation Distances

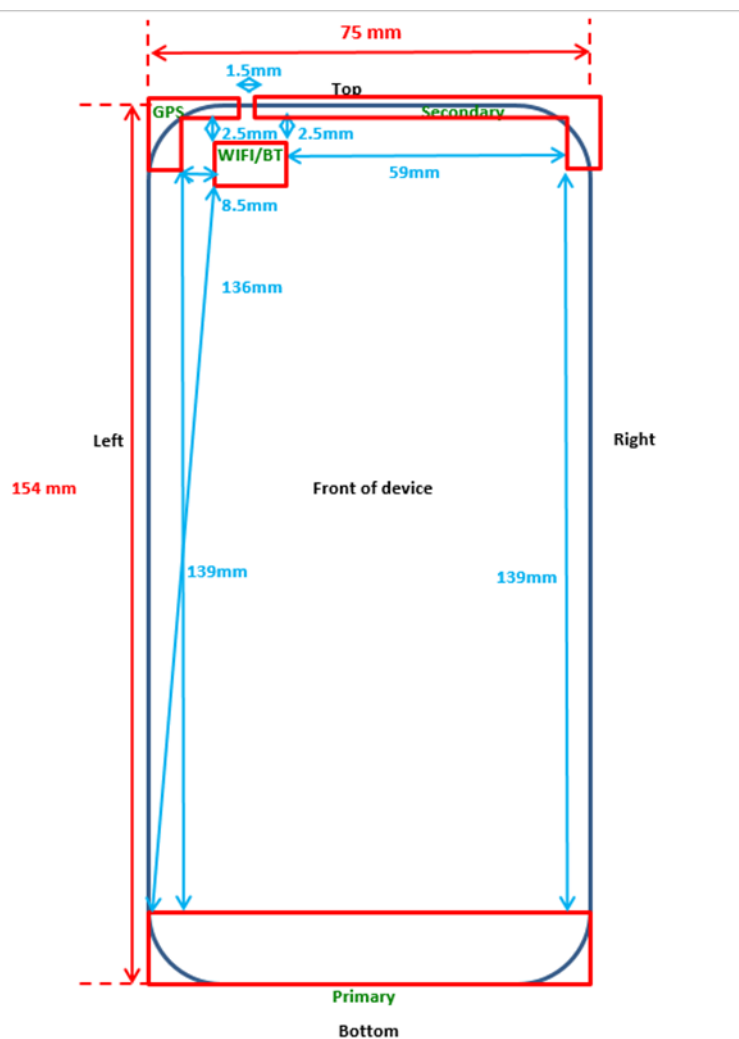

Picture 12.1 Antenna Locations

12.3 SAR Measurement Positions

According to the KDB941225 D06 Hot Spot SAR v01, the edges with less than 2.5 cm distance to the antennas need to be tested for SAR.

SAR measurement positions						
Mode	Front	Rear	Left edge	Right edge	Top edge	Bottom edge
Main antenna	Yes	Yes	Yes	Yes	No	Yes
WLAN	Yes	Yes	Yes	No	Yes	No

12.4 Standalone SAR Test Exclusion Considerations

Standalone 1-g head or body SAR evaluation by measurement or numerical simulation is not required when the corresponding SAR Exclusion Threshold condition, listed below, is satisfied.

The 1-g SAR test exclusion threshold for 100 MHz to 6 GHz at test separation distances ≤ 50 mm are determined by:

$$[(\text{max. power of channel, including tune-up tolerance, mW}) / (\text{min. test separation distance, mm})] \cdot [\sqrt{f(\text{GHz})}] \leq 3.0 \text{ for 1-g SAR, where}$$

- $f(\text{GHz})$ is the RF channel transmit frequency in GHz
- Power and distance are rounded to the nearest mW and mm before calculation
- The result is rounded to one decimal place for comparison

Table 12.1: Standalone SAR test exclusion considerations

Band/Mode	F(GHz)	Position	SAR test exclusion threshold (mW)	RF output power		SAR test exclusion
				dBm	mW	
Bluetooth	2.441	Head	9.6	9.5	8.91	Yes
		Body	9.6	9.5	8.91	Yes
2.4GHz WLAN	2.45	Head	9.58	16	39.81	No
		Body	9.58	16	39.81	No
5GHz WLAN	5.25	Head	6.58	13.5	22.39	No
		Body	13.16	13.5	22.39	No
	5.6	Head	6.34	12.9	19.50	No
		Body	12.68	12.9	19.50	No
	5.75	Head	6.23	12	15.85	No
		Body	12.46	12	15.85	No

13 Evaluation of Simultaneous

Table 13.1: The sum of reported SAR values for main antenna and WiFi

	Position	Main antenna	WiFi	Sum
Highest reported SAR value for Head	Right hand, Touch cheek	0.34	1.22(DTS)	1.56
			1.24(NII)	1.58
Highest reported SAR value for Body	Left edge	0.62	0.03(DTS)	0.65
			0.02(NII)	0.64

Note1: we have evaluated and chose the highest value of both main antennae in the above table

Table 13.2: The sum of reported SAR values for main antenna and BT

	Position	Main antenna	BT	Sum
Maximum reported SAR value for Head	Left hand, Touch cheek	0.53	0.19	0.72
Maximum reported SAR value for Body	Left edge	0.62	0.09	0.71

[1] - Estimated SAR for Bluetooth (see the table 13.3)

Table 13.3: Estimated SAR for Bluetooth

Mode/Band	F (GHz)	Position	Distance (mm)	Upper limit of power *		Estimated _{1g} (W/kg)
				dBm	mW	
Bluetooth	2.441	Head	5	9.5	8.91	0.19
Bluetooth	2.441	Body	10	9.5	8.91	0.09

* - Maximum possible output power declared by manufacturer

When standalone SAR test exclusion applies to an antenna that transmits simultaneously with other antennas, the standalone SAR must be estimated according to following to determine simultaneous transmission SAR test exclusion:

(max. power of channel, including tune-up tolerance, mW)/(min. test separation distance, mm) · [$\sqrt{f(\text{GHz})/x}$] W/kg for test separation distances ≤ 50 mm;

where $x = 7.5$ for 1-g SAR.

When the minimum test separation distance is < 5 mm, a distance of 5 mm is applied to determine SAR test exclusion

Conclusion:

According to the above tables, the sum of reported SAR values is < 1.6 W/kg. So the simultaneous transmission SAR with volume scans is not required.

14 SAR Test Result

It is determined by user manual for the distance between the EUT and the phantom bottom.

The distance is 10 mm and just applied to the condition of body worn accessory.

It is performed for all SAR measurements with area scan based 1-g SAR estimation (Fast SAR). A zoom scan measurement is added when the estimated 1-g SAR is the highest measured SAR in each exposure configuration, wireless mode and frequency band combination or more than 1.2W/kg.

The calculated SAR is obtained by the following formula:

$$\text{Reported SAR} = \text{Measured SAR} \times 10^{(P_{\text{Target}} - P_{\text{Measured}})/10}$$

Where P_{Target} is the power of manufacturing upper limit;

P_{Measured} is the measured power in chapter 11.

Mode	Duty Cycle
Speech for GSM850/1900	1:8.3
GPRS&EGPRS for GSM850/1900	1:2
WCDMA<E FDD	1:1
LTE TDD	1:1.58

14.1 Evaluation of multi-batteries and SIM slots

We'll perform the head measurement in all bands with the primary battery and SIM slot depending on the evaluation of multi-batteries and SIM slots retest on highest value point with other batteries and SIM slots. Then, repeat the measurement in the Body test.

Note:

The battery of HE316 is B1.

The battery of HE317 is B2.

The SIM1 is S1.

The SIM2 is S2.

The headset of CAB5422B-N01-DG is H1.

frequency		Mode/Band	Side	Position	BatteryType	1g SAR (W/kg)	PowerDrift
MHz	Channel						
2560	21350	LTE Band7	Left	Cheek	HE316	0.357	0.04
2560	21350	LTE Band7	Left	Cheek	HE317	0.368	0.06

Note: According to the values in the above table, the battery, HE317, is the primary battery. We'll perform the head measurement with this battery and retest on highest value point with others.

frequency		Mode/Band	Position	BatteryType	1g SAR (W/kg)	PowerDrift
MHz	Channel					
2560	21350	LTE Band7	Rear	HE316	0.329	-0.08
2560	21350	LTE Band7	Rear	HE317	0.382	-0.04

Note: According to the values in the above table, the battery, HE317, is the primary battery. We'll perform the Body measurement with this battery and retest on highest value point with others.

frequency		Mode/Band	Side	Position	SIM Card	1g SAR (W/kg)	PowerDrift
MHz	Channel						
2560	21350	LTE Band7	Left	Cheek	SIM1	0.368	0.06
2560	21350	LTE Band7	Left	Cheek	SIM2	0.361	0.01

Note: According to the values in the above table, the slot, S1, is the primary slot. We'll perform the head measurement with this slot and retest on highest value point with others.

frequency		Mode/Band	Position	SIM Card	1g SAR (W/kg)	PowerDrift
MHz	Channel					
2560	21350	LTE Band7	Rear	SIM1	0.382	-0.04
2560	21350	LTE Band7	Rear	SIM2	0.338	0.12

Note: According to the values in the above table, the slot, S1, is the primary slot. We'll perform the body measurement with this slot and retest on highest value point with others.

14.2 SAR results

**Table 14-1 GSM850
Head**

GSM850 Head									
Ambient Temperature:			22.5			Liquid Temperature:			23.3
Mode	Device orientation	SAR measurement	Measured SAR [W/kg]			Reported SAR [W/kg]			
			CH251 848.8 MHz	CH190 836.6 MHz	CH128 824.2 MHz	CH251 848.8 MHz	CH190 836.6 MHz	CH128 824.2 MHz	
GSM	Tune-up		33.60	33.60	33.60	Scaling factor*			
	Slot Average Power [dBm]		33.55	33.55	33.49	1.01	1.01	1.03	
	Left Cheek	1g SAR		0.102			0.10		
		10g SAR		0.081			0.08		
		Deviation		0.01			0.01		
	Left Tilt	1g SAR		0.066			0.07		
		10g SAR		0.053			0.05		
		Deviation		0.03			0.03		
	Right Cheek	1g SAR	0.143	0.163	0.178	0.14	0.16	0.18	
		10g SAR	0.109	0.123	0.138	0.11	0.12	0.14	
		Deviation	0.03	0.05	-0.06	0.03	0.05	-0.06	
	Right Tilt	1g SAR		0.065			0.07		
10g SAR			0.051			0.05			
Deviation			-0.09			-0.09			
GSM B1	Right Cheek	1g SAR			0.17			0.17	
		10g SAR			0.13			0.13	
		Deviation			0.12			0.12	
SIM 2	Right Cheek	1g SAR			0.162			0.17	
		10g SAR			0.121			0.12	
		Deviation			0.04			0.04	

Table 14-2 GSM850 Body

GSM850 Body									
Ambient Temperature:			22.5			Liquid Temperature:			23.3
Mode	Device orientation	SAR measurement	Measured SAR [W/kg]			Reported SAR [W/kg]			
			CH251 848.8 MHz	CH190 836.6 MHz	CH128 824.2 MHz	CH251 848.8 MHz	CH190 836.6 MHz	CH128 824.2 MHz	
GPRS 4 Txslots	Tune-up		29.00	29.00	29.00	Scaling factor*			
	Slot Average Power [dBm]		28.70	28.76	28.80	1.07	1.06	1.05	
	Front	1g SAR		0.187			0.20		
		10g SAR		0.118			0.12		
		Deviation		-0.09			-0.09		
	Rear	1g SAR		0.141			0.15		
		10g SAR		0.112			0.12		
		Deviation		-0.16			-0.16		
	Bottom edge	1g SAR		0.158			0.17		
		10g SAR		0.0842			0.09		
		Deviation		0.11			0.11		
	Left edge	1g SAR		0.131			0.14		
		10g SAR		0.0904			0.10		
		Deviation		0.16			0.16		
	Right edge	1g SAR	0.121	0.236	0.305	0.13	0.25	0.32	
		10g SAR	0.139	0.167	0.209	0.15	0.18	0.22	
		Deviation	0.1	0.14	0.08	0.10	0.14	0.08	
	EGPRS GMSK 4 Txslots	Tune-up		29.00	29.00	29.00	Scaling factor*		
		Slot Average Power [dBm]		28.69	28.76	28.79	1.07	1.06	1.05
		Right edge	1g SAR			0.265			0.28
			10g SAR			0.175			0.18
Deviation				0.08			0.08		
GSM B1	Right edge	1g SAR			0.299			0.31	
		10g SAR			0.202			0.21	
		Deviation			0.1			0.10	
SIM 2	Right edge	1g SAR			0.288			0.30	
		10g SAR			0.193			0.20	
		Deviation			-0.09			-0.09	

**Table 14-3 PCS1900
Head**

PCS1900 Head									
Ambient Temperature:			22.5			Liquid Temperature:			23.3
Mode	Device orientation	SAR measurement	Measured SAR [W/kg]			Reported SAR [W/kg]			
			CH810 1909.8 MHz	CH661 1880 MHz	CH512 1850.2 MHz	CH810 1909.8 MHz	CH661 1880 MHz	CH512 1850.2 MHz	
GSM	Tune-up		31.00	31.00	31.00	Scaling factor*			
	Slot Average Power [dBm]		30.81	30.92	30.99	1.05	1.02	1.00	
	Left Cheek	1g SAR	0.176	0.19	0.184	0.18	0.19	0.18	
		10g SAR	0.112	0.122	0.118	0.12	0.12	0.12	
		Deviation	0.11	-0.02	0.09	0.11	-0.02	0.09	
	Left Tilt	1g SAR		0.046			0.05		
		10g SAR		0.031			0.03		
		Deviation		0.14			0.14		
	Right Cheek	1g SAR		0.089			0.09		
		10g SAR		0.061			0.06		
		Deviation		-0.08			-0.08		
	Right Tilt	1g SAR		0.052			0.05		
10g SAR			0.043			0.04			
Deviation			0.1			0.10			
GSM B1	Left Cheek	1g SAR		0.181			0.18		
		10g SAR		0.119			0.12		
		Deviation		0.06			0.06		
SIM 2	Left Cheek	1g SAR		0.179			0.18		
		10g SAR		0.115			0.12		
		Deviation		0.12			0.12		

Table 14-4 PCS1900 Body

PCS1900 Body									
Ambient Temperature:			22.5			Liquid Temperature:			23.3
Mode	Device orientation	SAR measurement	Measured SAR [W/kg]			Reported SAR [W/kg]			
			CH810 1909.8 MHz	CH661 1880 MHz	CH512 1850.2 MHz	CH810 1909.8 MHz	CH661 1880 MHz	CH512 1850.2 MHz	
GPRS 4 Txslots	Tune-up		28.00	28.00	28.00	Scaling factor*			
	Slot Average Power [dBm]		27.96	27.83	27.85	1.01	1.04	1.03	
	Front	1g SAR		0.402			0.42		
		10g SAR		0.238			0.25		
		Deviation		0.01			0.01		
	Rear	1g SAR		0.522			0.54		
		10g SAR		0.307			0.32		
		Deviation		0.14			0.14		
	Bottom edge	1g SAR		0.513			0.53		
		10g SAR		0.271			0.28		
		Deviation		0.12			0.12		
	Left edge	1g SAR	0.496	0.53	0.558	0.50	0.55	0.58	
		10g SAR	0.286	0.302	0.338	0.29	0.31	0.35	
		Deviation	-0.03	0.07	-0.12	-0.03	0.07	-0.12	
	Right edge	1g SAR		0.0495			0.05		
		10g SAR		0.0271			0.03		
		Deviation		0.13			0.13		
	EGPRS GMSK 4 Txslots	Tune-up		28.00	28.00	28.00	Scaling factor*		
Slot Average Power [dBm]		27.94	27.81	27.85	1.01	1.05	1.04		
Left edge		1g SAR			0.527			0.55	
		10g SAR			0.291			0.30	
	Deviation			-0.11			-0.11		
GSM B1	Left edge	1g SAR			0.521			0.54	
		10g SAR			0.282			0.29	
		Deviation			-0.04			-0.04	
SIM 2	Left edge	1g SAR			0.522			0.54	
		10g SAR			0.284			0.29	
		Deviation			-0.06			-0.06	

**Table 14-5 WCDMA1900-BII
Head**

WCDMA1900-BII Head								
Ambient Temperature: 22.5						Liquid Temperature: 23.3		
Mode	Device orientation	SAR measurement	Measured SAR [W/kg]			Reported SAR [W/kg]		
			CH9538 1907.6 MHz	CH9400 1880 MHz	CH9262 1852.4 MHz	CH9538 1907.6 MHz	CH9400 1880 MHz	CH9262 1852.4 MHz
RMC	Tune-up		24.50	24.50	24.50	Scaling factor*		
	Slot Average Power [dBm]		24.24	23.99	24.02	1.06	1.12	1.12
	Left Cheek	1g SAR	0.499	0.466	0.47	0.53	0.52	0.52
		10g SAR	0.315	0.264	0.269	0.33	0.30	0.30
		Deviation	0.06	0.11	0.04	0.06	0.11	0.04
	Left Tilt	1g SAR		0.164			0.18	
		10g SAR		0.1			0.11	
		Deviation		-0.1			-0.10	
	Right Cheek	1g SAR		0.304			0.34	
		10g SAR		0.239			0.27	
		Deviation		0.09			0.09	
	Right Tilt	1g SAR		0.145			0.16	
		10g SAR		0.092			0.10	
		Deviation		0.16			0.16	
RMC B1	Left Cheek	1g SAR	0.472			0.50		
		10g SAR	0.273			0.29		
		Deviation	-0.08			-0.08		
SIM 2	Left Cheek	1g SAR	0.466			0.50		
		10g SAR	0.265			0.28		
		Deviation	-0.12			-0.12		

Table 14-6 WCDMA1900-BII Body

WCDMA1900-BII Body									
Ambient Temperature: 22.5						Liquid Temperature: 23.3			
Mode	Device orientation	SAR measurement	Measured SAR [W/kg]			Reported SAR [W/kg]			
			CH9538 1907.6 MHz	CH9400 1880 MHz	CH9262 1852.4 MHz	CH9538 1907.6 MHz	CH9400 1880 MHz	CH9262 1852.4 MHz	
RMC	Tune-up		24.50	24.50	24.50	Scaling factor*			
	Slot Average Power [dBm]		24.24	23.99	24.02	1.06	1.12	1.12	
	Front	1g SAR		0.526			0.59		
		10g SAR		0.291			0.33		
		Deviation		0.01			0.01		
	Rear	1g SAR		0.464			0.52		
		10g SAR		0.245			0.28		
		Deviation		-0.06			-0.06		
	Bottom edge	1g SAR		0.465			0.52		
		10g SAR		0.231			0.26		
		Deviation		0.17			0.17		
	Left edge	1g SAR	0.416	0.549	0.502	0.44	0.62	0.56	
		10g SAR	0.136	0.332	0.275	0.14	0.37	0.31	
		Deviation	0.04	-0.16	0.18	0.04	-0.16	0.18	
	Right edge	1g SAR		0.0674			0.08		
		10g SAR		0.0366			0.04		
		Deviation		0.09			0.09		
	RMC B1	Left edge	1g SAR		0.526			0.59	
			10g SAR		0.291			0.33	
			Deviation		0.09			0.09	
	SIM 2	Left edge	1g SAR		0.515			0.58	
10g SAR				0.285			0.32		
Deviation				-0.01			-0.01		

**Table 14-7 WCDMA850-BV
Head**

WCDMA850-BV Head									
Ambient Temperature:			22.5			Liquid Temperature:			23.3
Mode	Device orientation	SAR measurement	Measured SAR [W/kg]			Reported SAR [W/kg]			
			CH4233 846.6 MHz	CH4715 835.4 MHz	CH4132 826.4 MHz	CH4233 846.6 MHz	CH4715 835.4 MHz	CH4132 826.4 MHz	
RMC	Tune-up		24.50	24.50	24.50	Scaling factor*			
	Slot Average Power [dBm]		24.42	24.39	24.50	1.02	1.02	1.00	
	Left Cheek	1g SAR		0.145			0.15		
		10g SAR		0.106			0.11		
		Deviation		0.03			0.03		
	Left Tilt	1g SAR		0.136			0.14		
		10g SAR		0.075			0.08		
		Deviation		-0.01			-0.01		
	Right Cheek	1g SAR	0.174	0.22	0.209	0.18	0.23	0.21	
		10g SAR	0.121	0.17	0.146	0.12	0.17	0.15	
		Deviation	0.09	-0.05	0.03	0.09	-0.05	0.03	
	Right Tilt	1g SAR		0.086			0.09		
		10g SAR		0.04			0.04		
		Deviation		0.12			0.12		
	RMC B1	Right Cheek	1g SAR		0.203			0.21	
10g SAR				0.116			0.12		
Deviation				0.01			0.01		
SIM 2	Right Cheek	1g SAR		0.198			0.20		
		10g SAR		0.113			0.12		
		Deviation		0.03			0.03		

Table 14-8 WCDMA850-BV Body

WCDMA850-BV Body									
Ambient Temperature:			22.5			Liquid Temperature:			23.3
Mode	Device orientation	SAR measurement	Measured SAR [W/kg]			Reported SAR [W/kg]			
			CH4233 846.6 MHz	CH4715 835.4 MHz	CH4132 826.4 MHz	CH4233 846.6 MHz	CH4715 835.4 MHz	CH4132 826.4 MHz	
RMC	Tune-up		24.50	24.50	24.50	Scaling factor*			
	Slot Average Power [dBm]		24.42	24.39	24.50	1.02	1.02	1.00	
	Front	1g SAR		0.244			0.25		
		10g SAR		0.182			0.19		
		Deviation		0.1			0.10		
	Rear	1g SAR		0.268			0.27		
		10g SAR		0.201			0.21		
		Deviation		0.08			0.08		
	Bottom edge	1g SAR		0.216			0.22		
		10g SAR		0.107			0.11		
		Deviation		0.16			0.16		
	Left edge	1g SAR		0.191			0.20		
		10g SAR		0.126			0.13		
		Deviation		0.03			0.03		
	Right edge	1g SAR	0.331	0.374	0.318	0.34	0.38	0.32	
		10g SAR	0.219	0.256	0.211	0.22	0.26	0.21	
		Deviation	-0.1	-0.12	0.08	-0.10	-0.12	0.08	
	SIM2	Right edge	1g SAR		0.348			0.36	
			10g SAR		0.227			0.23	
			Deviation		-0.07			-0.07	
	RMC B1	Right edge	1g SAR		0.359			0.37	
			10g SAR		0.237			0.24	
			Deviation		0.1			0.10	

**Table 14-9 LTE2500-FDD7
Head**

LTE2500-FDD7 Head								
Ambient Temperature: 22.5			Liquid Temperature: 23.3					
Mode	Device orientation	SAR measurement	Measured SAR [W/kg]			Reported SAR [W/kg]		
			21350 M	21100 M	20850 M	21350 M	21100 M	20850 M
20MHz QPSK1RB	Tune-up		24.50	24.50	24.50	Scaling factor*		
	Measured Power [dBm]		23.93	23.55	23.78	1.14	1.25	1.18
	Left Cheek	1g SAR	0.368			0.42		
		10g SAR	0.206			0.23		
		Deviation	0.06			0.06		
	Left Tilt	1g SAR	0.09			0.10		
		10g SAR	0.043			0.05		
		Deviation	0.04			0.04		
	Right Cheek	1g SAR	0.203			0.23		
		10g SAR	0.117			0.13		
		Deviation	-0.09			-0.09		
	Right Tilt	1g SAR	0.162			0.18		
		10g SAR	0.066			0.08		
Deviation		0.01			0.01			
TRUE	Device orientation	SAR measurement	Measured SAR [W/kg]			Reported SAR [W/kg]		
			21350 M	21100 H	20850 L	21350 M	21100 H	20850 L
20MHz QPSK50%RB	Tune-up		23.50	23.50	23.50	Scaling factor*		
	Measured Power [dBm]		22.66	22.64	22.59	1.21	1.22	1.23
	Left Cheek	1g SAR	0.283			0.34		
		10g SAR	0.152			0.18		
		Deviation	0.17			0.17		
	Left Tilt	1g SAR	0.073			0.09		
		10g SAR	0.034			0.04		
		Deviation	0.04			0.04		
	Right Cheek	1g SAR	0.154			0.19		
		10g SAR	0.089			0.11		
		Deviation	0.09			0.09		
	Right Tilt	1g SAR	0.13			0.16		
		10g SAR	0.053			0.06		
Deviation		0.01			0.01			
Mode	Device orientation	SAR measurement	Measured SAR [W/kg]			Reported SAR [W/kg]		
			21350	21100	20850	21350	21100	20850
20MHz QPSK100%RB	Tune-up		23.50	23.50	23.50	Scaling factor*		
	Measured Power [dBm]		22.60	22.62	22.54	1.23	1.22	1.25
	Left Cheek	1g SAR						
		10g SAR						
Deviation								
20MHz QPSK1RB B1	Left Cheek	1g SAR	0.334			0.38		
		10g SAR	0.171			0.19		
		Deviation	-0.05			-0.05		
SIM 2	Left Cheek	1g SAR	0.364			0.41		
		10g SAR	0.193			0.22		
		Deviation	0.1			0.10		



Table 14-10 LTE2500-FDD7 Body

LTE2500-FDD7 Body								
Ambient Temperature: 22.5			Liquid Temperature: 23.3					
Mode	Device orientation	SAR measurement	Measured SAR [W/kg]			Reported SAR [W/kg]		
			21350	21100	20850	21350	21100	20850
			M	M	M	M	M	M
20MHz QPSK1RB	Tune-up		24.50	24.50	24.50	Scaling factor*		
	Measured Power [dBm]		23.93	23.55	23.78	1.14	1.25	1.18
	Front	1g SAR	0.335			0.38		
		10g SAR	0.181			0.21		
		Deviation	-0.1			-0.10		
	Rear	1g SAR	0.382			0.44		
		10g SAR	0.215			0.25		
		Deviation	-0.04			-0.04		
	Bottom edge	1g SAR	0.324			0.37		
		10g SAR	0.144			0.16		
		Deviation	0.09			0.09		
	Left edge	1g SAR	0.461			0.53		
		10g SAR	0.247			0.28		
		Deviation	0.05			0.05		
	Right edge	1g SAR	0.0561			0.06		
10g SAR		0.0327			0.04			
Deviation		0.07			0.07			
Mode	Device orientation	SAR measurement	Measured SAR [W/kg]			Reported SAR [W/kg]		
			21350	21100	20850	21350	21100	20850
			M	H	L			
20MHz QPSK50%RB	Tune-up		23.50	23.50	23.50	Scaling factor*		
	Measured Power [dBm]		22.66	22.64	22.59	1.21	1.22	1.23
	Front	1g SAR	0.292			0.35		
		10g SAR	0.167			0.20		
		Deviation	0.14			0.14		
	Rear	1g SAR	0.304			0.37		
		10g SAR	0.179			0.22		
		Deviation	0.02			0.02		
	Bottom edge	1g SAR	0.243			0.30		
		10g SAR	0.108			0.13		
		Deviation	-0.09			-0.09		
	Left edge	1g SAR	0.326			0.40		
		10g SAR	0.173			0.21		
		Deviation	-0.1			-0.10		
	Right edge	1g SAR	0.0506			0.06		
10g SAR		0.0266			0.03			
Deviation		0.19			0.19			
Mode	Device orientation	SAR measurement	Measured SAR [W/kg]			Reported SAR [W/kg]		
			21350	21100	20850	21350	21100	20850
20MHz QPSK100%RB	Tune-up		23.50	23.50	23.50	Scaling factor*		
	Measured Power [dBm]		22.60	22.62	22.54	1.23	1.22	1.25
	Front	1g SAR						
		10g SAR						
Deviation								
20MHz QPSK1RB B1	Left edge	1g SAR	0.418			0.48		
		10g SAR	0.224			0.26		
		Deviation	0.1			0.10		
SIM 2	Left edge	1g SAR	0.405			0.46		
		10g SAR	0.219			0.25		
		Deviation	0.16			0.16		

Table 14-11 LTE2600-FDD38 Head

LTE2600-TDD38 Head								
Ambient Temperature: 22.5						Liquid Temperature: 23.3		
Mode	Device orientation	SAR measurement	Measured SAR [W/kg]			Reported SAR [W/kg]		
			38150	38000	37850	38150	38000	37850
			M	H	H	M	H	H
20MHz QPSK1RB	Tune-up		24.50	24.50	24.50	Scaling factor*		
	Measured Power [dBm]		23.74	23.50	23.52	1.19	1.26	1.25
	Left Cheek	1g SAR	0.2			0.24		
		10g SAR	0.101			0.12		
		Deviation	0.02			0.02		
	Left Tilt	1g SAR	0.051			0.06		
		10g SAR	0.026			0.03		
		Deviation	0.12			0.12		
	Right Cheek	1g SAR	0.081			0.10		
		10g SAR	0.046			0.05		
		Deviation	0.09			0.09		
	Right Tilt	1g SAR	0.055			0.07		
		10g SAR	0.028			0.03		
		Deviation	-0.14			-0.14		
TRUE	Device orientation	SAR measurement	Measured SAR [W/kg]			Reported SAR [W/kg]		
			38150	38000	37850	38150	38000	37850
			L	H	L	L	H	L
20MHz QPSK50%RB	Tune-up		23.50	23.50	23.50	Scaling factor*		
	Measured Power [dBm]		22.51	22.49	22.53	1.26	1.26	1.25
	Left Cheek	1g SAR			0.144			0.18
		10g SAR			0.077			0.10
		Deviation			0.08			0.08
	Left Tilt	1g SAR			0.09			0.11
		10g SAR			0.042			0.05
		Deviation			0.06			0.06
	Right Cheek	1g SAR			0.065			0.08
		10g SAR			0.037			0.05
		Deviation			-0.05			-0.05
	Right Tilt	1g SAR			0.07			0.09
		10g SAR			0.033			0.04
		Deviation			0.03			0.03
Mode	Device orientation	SAR measurement	Measured SAR [W/kg]			Reported SAR [W/kg]		
			38150	38000	37850	38150	38000	37850
20MHz QPSK100%RB	Tune-up		23.50	23.50	23.50	Scaling factor*		
	Measured Power [dBm]		22.41	22.44	22.43	1.29	1.28	1.28
	Left Cheek	1g SAR						
		10g SAR						
Deviation								
20MHz QPSK1RB B1	Left Cheek	1g SAR	0.164			0.20		
		10g SAR	0.084			0.10		
		Deviation	0.08			0.08		
SIM2	Left Cheek	1g SAR	0.151			0.18		
		10g SAR	0.082			0.10		
		Deviation	0.01			0.01		

Table 14-12 LTE2600-FDD38 Body

LTE2600-TDD38 Body								
Ambient Temperature: 22.5			Liquid Temperature: 23.3					
Mode	Device orientation	SAR measurement	Measured SAR [W/kg]			Reported SAR [W/kg]		
			38150	38000	37850	38150	38000	37850
			M	H	H	M	H	H
20MHz QPSK1RB	Tune-up		24.50	24.50	24.50	Scaling factor*		
	Measured Power [dBm]		23.74	23.50	23.52	1.19	1.26	1.25
	Front	1g SAR	0.146			0.17		
		10g SAR	0.083			0.10		
		Deviation	0.05			0.05		
	Rear	1g SAR	0.104			0.12		
		10g SAR	0.064			0.08		
		Deviation	0.08			0.08		
	Bottom edge	1g SAR	0.106			0.13		
		10g SAR	0.052			0.06		
		Deviation	0.03			0.03		
	Left edge	1g SAR	0.12			0.14		
		10g SAR	0.069			0.08		
		Deviation	-0.01			-0.01		
	Right edge	1g SAR	0.024			0.03		
10g SAR		0.012			0.01			
Deviation		-0.03			-0.03			
Mode	Device orientation	SAR measurement	Measured SAR [W/kg]			Reported SAR [W/kg]		
			38150	38000	37850	38150	38000	37850
			L	H	L			
20MHz QPSK50%RB	Tune-up		23.50	23.50	23.50	Scaling factor*		
	Measured Power [dBm]		22.51	22.49	22.53	1.26	1.26	1.25
	Front	1g SAR			0.087			0.11
		10g SAR			0.05			0.06
		Deviation			0.01			0.01
	Rear	1g SAR			0.084			0.11
		10g SAR			0.053			0.07
		Deviation			0.09			0.09
	Bottom edge	1g SAR			0.065			0.08
		10g SAR			0.034			0.04
		Deviation			0.01			0.01
	Left edge	1g SAR			0.091			0.11
		10g SAR			0.052			0.07
		Deviation			0.05			0.05
	Right edge	1g SAR			0.019			0.02
10g SAR				0.009			0.01	
Deviation				-0.08			-0.08	
Mode	Device orientation	SAR measurement	Measured SAR [W/kg]			Reported SAR [W/kg]		
			38150	38000	37850	38150	38000	37850
20MHz QPSK100%RB	Tune-up		23.50	23.50	23.50	Scaling factor*		
	Measured Power [dBm]		22.41	22.44	22.43	1.29	1.28	1.28
	Front	1g SAR						
10g SAR								
Deviation								
20MHz QPSK1RB B1	Front	1g SAR	0.122			0.15		
		10g SAR	0.071			0.08		
		Deviation	0.12			0.12		
SIM 2	Front	1g SAR	0.124			0.15		
		10g SAR	0.072			0.09		
		Deviation	-0.09			-0.09		

Table 14-13 LTE850-FDD5 Head

LTE850-FDD5 Head								
Ambient Temperature: 22.5						Liquid Temperature: 23.3		
Mode	Device orientation	SAR measurement	Measured SAR [W/kg]			Reported SAR [W/kg]		
			20600	20525	20450	20600	20525	20450
			M	M	M	M	M	M
10MHz QPSK1RB	Tune-up		24.90	24.90	24.90	Scaling factor*		
	Measured Power [dBm]		24.14	24.24	23.86	1.19	1.16	1.27
	Left Cheek	1g SAR		0.133			0.15	
		10g SAR		0.108			0.13	
		Deviation		-0.03			-0.03	
	Left Tilt	1g SAR		0.124			0.14	
		10g SAR		0.073			0.08	
		Deviation		-0.01			-0.01	
	Right Cheek	1g SAR		0.199			0.23	
		10g SAR		0.152			0.18	
		Deviation		0.14			0.14	
	Right Tilt	1g SAR		0.115			0.13	
10g SAR			0.094			0.11		
Deviation			0.05			0.05		
TRUE	Device orientation	SAR measurement	Measured SAR [W/kg]			Reported SAR [W/kg]		
			20600	20525	20450	20600	20525	20450
			H	H	M	H	H	M
10MHz QPSK50%RB	Tune-up		23.90	23.90	23.90	Scaling factor*		
	Measured Power [dBm]		23.07	23.06	23.05	1.21	1.21	1.22
	Left Cheek	1g SAR	0.093			0.11		
		10g SAR	0.074			0.09		
		Deviation	-0.03			-0.03		
	Left Tilt	1g SAR	0.097			0.12		
		10g SAR	0.057			0.07		
		Deviation	-0.08			-0.08		
	Right Cheek	1g SAR	0.137			0.17		
		10g SAR	0.106			0.13		
		Deviation	0.02			0.02		
	Right Tilt	1g SAR	0.082			0.10		
10g SAR		0.066			0.08			
Deviation		0.01			0.01			
Mode	Device orientation	SAR measurement	Measured SAR [W/kg]			Reported SAR [W/kg]		
			20600	20525	20450	20600	20525	20450
10MHz QPSK100%R B	Tune-up		23.90	23.90	23.90	Scaling factor*		
	Measured Power [dBm]		22.88	22.95	22.95	1.26	1.24	1.24
	Left Cheek	1g SAR						
		10g SAR						
Deviation								
10MHz QPSK1RB B1	Right Cheek	1g SAR		0.187			0.22	
		10g SAR		0.139			0.16	
		Deviation		-0.04			-0.04	
SIM 2	Right Cheek	1g SAR		0.19			0.22	
		10g SAR		0.129			0.15	
		Deviation		0.04			0.04	

Table 14-14 LTE850-FDD5 Body

LTE850-FDD5 Body								
Ambient Temperature: 22.5			Liquid Temperature: 23.3					
Mode	Device orientation	SAR measurement	Measured SAR [W/kg]			Reported SAR [W/kg]		
			20600	20525	20450	20600	20525	20450
			M	M	M	M	M	M
10MHz QPSK1RB	Tune-up		24.90	24.90	24.90	Scaling factor*		
	Measured Power [dBm]		24.14	24.24	23.86	1.19	1.16	1.27
	Front	1g SAR		0.246			0.29	
		10g SAR		0.158			0.18	
		Deviation		-0.01			-0.01	
	Rear	1g SAR		0.184			0.21	
		10g SAR		0.142			0.17	
		Deviation		0.13			0.13	
	Bottom edge	1g SAR		0.157			0.18	
		10g SAR		0.082			0.10	
		Deviation		0.19			0.19	
	Left edge	1g SAR		0.101			0.12	
		10g SAR		0.069			0.08	
		Deviation		-0.14			-0.14	
Right edge	1g SAR		0.256			0.30		
	10g SAR		0.175			0.20		
	Deviation		-0.06			-0.06		
Mode	Device orientation	SAR measurement	Measured SAR [W/kg]			Reported SAR [W/kg]		
			20600	20525	20450	20600	20525	20450
			H	H	M			
10MHz QPSK50%RB	Tune-up		23.90	23.90	23.90	Scaling factor*		
	Measured Power [dBm]		23.07	23.06	23.05	1.21	1.21	1.22
	Front	1g SAR	0.201			0.24		
		10g SAR	0.128			0.15		
		Deviation	-0.03			-0.03		
	Rear	1g SAR	0.142			0.17		
		10g SAR	0.109			0.13		
		Deviation	0.17			0.17		
	Bottom edge	1g SAR	0.127			0.15		
		10g SAR	0.066			0.08		
		Deviation	0.11			0.11		
	Left edge	1g SAR	0.094			0.11		
		10g SAR	0.059			0.07		
		Deviation	0.05			0.05		
Right edge	1g SAR	0.203			0.25			
	10g SAR	0.138			0.17			
	Deviation	0.09			0.09			
Mode	Device orientation	SAR measurement	Measured SAR [W/kg]			Reported SAR [W/kg]		
			20600	20525	20450	20600	20525	20450
10MHz QPSK100%RB	Tune-up		23.90	23.90	23.90	Scaling factor*		
	Measured Power [dBm]		22.88	22.95	22.95	1.26	1.24	1.24
	Front	1g SAR						
10g SAR								
Deviation								
10MHz QPSK1RB B1	Right edge	1g SAR		0.236			0.27	
		10g SAR		0.152			0.18	
		Deviation		-0.08			-0.08	
SIM 2	Right edge	1g SAR		0.241			0.28	
		10g SAR		0.154			0.18	
		Deviation		0.03			0.03	



14.3 Full SAR

Test Band	Channel	Frequency	Tune-Up	Measured Power	Test Position	Measured 10g SAR	Measured 1g SAR	Reported 10g SAR	Reported 1g SAR	Power Drift	Figure
GSM850	128	824.2 MHz	33.6	33.49	Right Cheek	0.138	0.178	0.14	0.18	-0.06	Fig A.1
GSM850	128	824.2 MHz	29	28.80	Right edge	0.209	0.305	0.22	0.32	0.08	Fig A.2
PCS1900	661	1880 MHz	31	30.92	Left Cheek	0.122	0.19	0.12	0.19	-0.02	Fig A.3
PCS1900	512	1850.2 MHz	28	27.85	Left edge	0.338	0.558	0.35	0.58	-0.12	Fig A.4
WCDMA1900-BII	9538	1907.6 MHz	24.5	24.24	Left Cheek	0.315	0.499	0.33	0.53	0.06	Fig A.5
WCDMA1900-BII	9400	1880 MHz	24.5	23.99	Left edge	0.332	0.549	0.37	0.62	-0.16	Fig A.6
WCDMA850-BV	4715	835.4 MHz	24.5	24.39	Right Cheek	0.17	0.22	0.17	0.23	-0.05	Fig A.7
WCDMA850-BV	4715	835.4 MHz	24.5	24.39	Right edge	0.256	0.374	0.26	0.38	-0.12	Fig A.8
LTE2500-FDD7	21350	2560 MHz	24.5	23.93	Left Cheek	0.206	0.368	0.23	0.42	0.06	Fig A.9
LTE2500-FDD7	21350	2560 MHz	24.5	23.93	Left edge	0.247	0.461	0.28	0.53	0.05	Fig A.10
LTE2600-TDD38	38150	2610 MHz	24.5	23.74	Left Cheek	0.101	0.2	0.12	0.24	0.02	Fig A.11
LTE2600-TDD38	38150	2610 MHz	24.5	23.74	Front	0.083	0.146	0.10	0.17	0.05	Fig A.12
LTE850-FDD5	20520	836.5 MHz	24.9	24.24	Right Cheek	0.152	0.199	0.18	0.23	0.14	Fig A.13
LTE850-FDD5	20520	836.5 MHz	24.9	24.24	Right edge	0.175	0.256	0.20	0.30	-0.06	Fig A.14

14.4 WLAN Evaluation For 2.4G

According to the KDB248227 D01, SAR is measured for 802.11b DSSS using the initial test position procedure.

Note1: When the reported SAR of the initial test position is > 0.4 W/kg, SAR is repeated for the 802.11 transmission mode configuration tested in the initial test position using subsequent highest estimated 1-g SAR conditions determined by area scans, on the highest maximum output power channel, until the reported SAR is ≤ 0.8 W/kg.

Note2: For all positions/configurations tested using the initial test position and subsequent test positions, when the reported SAR is > 0.8 W/kg, SAR is measured for these test positions/configurations on the subsequent next highest measured output power channel until the reported SAR is ≤ 1.2 W/kg or all required channels are tested.

Note3: According to the KDB248227 D01, The reported SAR must be scaled to 100% transmission duty factor to determine compliance at the maximum tune-up tolerance limit.

Table 14.4-1 WLAN 2450 head

WLAN 2450 Head Fast SAR								
Ambient Temperature: 22.5				Liquid Temperature: 23.3				
Rate	Device orientation	SAR measurement	Measured SAR [W/kg]			Reported SAR [W/kg]		
			11 2462 MHz	6 2437 MHz	1 2412 MHz	11	6	1
802.11b 1Mbps	Tune up		16	16	16	Scaling factor*		
	Slot Average Power [dBm]		15.76	15.79	15.94	1.06	1.05	1.01
	Left Cheek	1g Fast SAR			0.553			0.56
		10g SAR			0.286			0.29
		Deviation			0.08			0.08
	Left Tilt	1g Fast SAR			0.435			0.44
		10g SAR			0.202			0.20
		Deviation			0.19			0.19
	Right Cheek	1g Fast SAR			1.03			1.04
		10g SAR			0.478			0.48
		Deviation			0.04			0.04
	Right Tilt	1g Fast SAR			0.704			0.71
		10g SAR			0.317			0.32
		Deviation			-0.14			-0.14
	B1	Right Cheek	1g Fast SAR			0.976		
10g SAR					0.452			0.46
Deviation					-0.03			-0.03
SIM 1	Right Cheek	1g Fast SAR			0.962			0.98
		10g SAR			0.449			0.46
		Deviation			-0.01			-0.01

WLAN 2450 Head Full SAR								
Ambient Temperature: 22.5				Liquid Temperature: 23.3				
Rate	Device orientation	SAR measurement	Measured SAR [W/kg]			Reported SAR [W/kg]		
			11 2462 MHz	6 2437 MHz	1 2412 MHz	11	6	1
802.11b 1Mbps	Tune up		16	16	16	Scaling factor*		
	Slot Average Power [dBm]		15.76	15.79	15.94	1.06	1.05	1.01
	Right Cheek	1g Full SAR		1.13	1.16		1.19	1.18
		10g SAR		0.466	0.48		0.49	0.49
		Deviation		-0.09	0.04		-0.09	0.04
	Right Tilt	1g Full SAR			0.642			0.65
		10g SAR			0.278			0.28
		Deviation			-0.14			-0.14

According to the KDB248227 D01, The reported SAR must be scaled to 100% transmission duty factor to determine compliance at the maximum tune-up tolerance limit. The scaled reported SAR is presented as below:

Frequency		Side	Test Position	Actual duty factor	maximum duty factor	Reported SAR	Scaled reported SAR (1g) (W/kg)	Figure
MHz	Ch.					(1g) (W/kg)		
2437	6	Right	Touch	97.73%	100%	1.19	1.22	Fig.15

SAR is not required for OFDM because the 802.11b adjusted by the ratio of OFDM to DSSS specified maximum output power and the adjusted SAR is ≤ 1.2 W/kg.

Table 14.4-2 WLAN 2450 body

WLAN 2450 Body Fast SAR								
Ambient Temperature: 22.5						Liquid Temperature: 23.3		
Rate	Device orientation	SAR measurement	Measured SAR [W/kg]			Reported SAR [W/kg]		
			11 2462 MHz	6 2437 MHz	1 2412 MHz	11	6	1
802.11b 1Mbps	Tune up		16	16	16	Scaling factor*		
	Slot Average Power [dBm]		15.76	15.79	15.94	1.06	1.05	1.01
	Front	1g Fast SAR			0.084			0.09
		10g SAR			0.047			0.05
		Deviation			0.02			0.02
	Rear	1g Fast SAR			0.08			0.08
		10g SAR			0.043			0.04
		Deviation			0.04			0.04
	Top edge	1g Fast SAR			0.083			0.08
		10g SAR			0.035			0.04
		Deviation			-0.02			-0.02
	Left edge	1g Fast SAR			0.029			0.03
		10g SAR			0.014			0.01
		Deviation			0.1			0.10
	Right edge	1g Fast SAR			0.026			0.03
		10g SAR			0.013			0.01
		Deviation			0.17			0.17
	B1	Front	1g Fast SAR			0.082		
10g SAR					0.044			0.04
Deviation					0.15			0.15
SIM 2	Front	1g Fast SAR			0.081			0.08
		10g SAR			0.045			0.05
		Deviation			0.07			0.07

WLAN 2450 Body Full SAR								
Ambient Temperature: 22.5						Liquid Temperature: 23.3		
Rate	Device orientation	SAR measurement	Measured SAR [W/kg]			Reported SAR [W/kg]		
			11 2462 MHz	6 2437 MHz	1 2412 MHz	11	6	1
802.11b 1Mbps	Tune up		16	16	16	Scaling factor*		
	Slot Average Power [dBm]		15.76	15.79	15.94	1.06	1.05	1.01
	Front	1g Full SAR			0.086			0.09
		10g SAR			0.047			0.05
		Deviation			0.02			0.02

According to the KDB248227 D01, The reported SAR must be scaled to 100% transmission duty factor to determine compliance at the maximum tune-up tolerance limit. The scaled reported SAR is presented as below:

Frequency		Test position	Actual duty factor	maximum duty factor	Reported SAR	Scaled reported SAR (1g) (W/kg)	Figure
MHz	Ch.				(1g) (W/kg)	(1g) (W/kg)	
2412	1	Front	97.44%	100%	0.09	0.09	Fig.16
2412	1	Left	97.44%	100%	0.03	0.03	/

SAR is not required for OFDM because the 802.11b adjusted SAR \leq 1.2 W/kg.

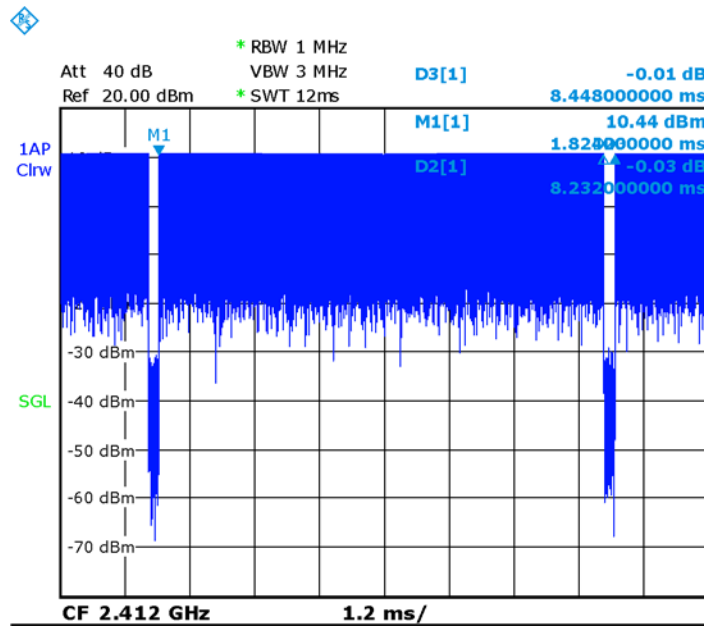

Picture 14.1 Duty factor plot for CH.1

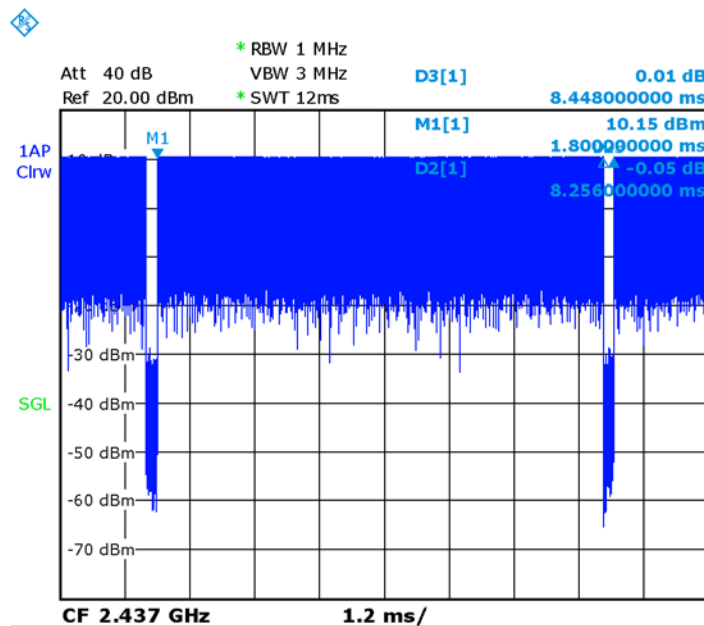

Picture 14.2 Duty factor plot for CH.6

14.5 WLAN Evaluation For 5G

Table 14.5-1: OFDM mode specified maximum output power of WLAN antenna

802.11 mode	a	g	n		ac			
Ch. BW(MHz)	20	20	20	40	20	40	80	160
U-NII-1	X		X	X				
U-NII-2A	X		X	X				
U-NII-2C	X		X	X				
U-NII-3	X		X	X				
§ 15.247 (5.8 GHz)								

X: maximum(conducted) output power(mW), including tolerance, specified for production units

Table 14.5-2: Maximum output power specified of WLAN antenna

802.11 mode	a	g	n		ac			
Ch. BW(MHz)	20	20	20	40	20	40	80	160
U-NII-1	22							
U-NII-2A	18							
U-NII-2C	19							
U-NII-3	16							
§ 15.247 (5.8 GHz)								

- The maximum output power specified for production units is the same for all channels, modulations and data rates in each channel bandwidth configuration of the 802.11a/g/n/ac modes.
- The **blue highlighted** cells represent highest output configurations in each standalone or aggregated frequency band, with tune-up tolerance included.

Table 14.5-3: Maximum output power measured of WLAN antenna, for the applicable OFDM configurations according to the default power measurement procedures for selection initial test configurations

802.11 mode	a	n		ac		
BW(MHz)	20	20	40	20	40	80
U-NII-1	36/40/44/48 21/21/20/19	36/40/44/48 Lower power	38/46 Lower power	/	/	/
U-NII-2A	52/56/60/64 18/16/16/15	52/56/60/64 Lower power	54/62 Lower power	/	/	/
U-NII-2C	100/104/108/112 19/19/19/19 116/120/124/128 18/17/17/16 132/136/140 15/14/15	100/104/108/112 116/132/136/140 Lower power	102/110/134 Lower power	/	/	/
U-NII-3	149/153/157/161/165 14/14/15/15/15	149/153/157/161/165 Lower power	151/159 Lower power	/	/	/

- Channels with measured maximum power within 0.25dB are considered to have the same measured output.
Channels selected for initial test configuration are **highlighted in yellow**.

Table 14.5-4: Reported SAR of initial test configuration for Head

802.11 mode	a	n		ac		
		20	40	20	40	80
U-NII-1	36/40/44/48 U-NII-2A exclusion applied	36/40/44/48	38/46	/	/	/
U-NII-2A	52/56/60/64 0.63	52/56/60/64	54/62	/	/	/
U-NII-2C	100/104/108/112 116/120/124/128 132/136/140 0.79	100/104/108/112 116/132/136/140	102/110/118/ 126/134	/	/	/
U-NII-3	149/153/157/161/165 1.08	149/153/157/161/ 165	151/159	/	/	/

U-NII-1 and U-NII-2A bands have the same specified maximum output and tolerance; SAR is measured for U-NII-2A band first. Adjusted SAR of U-NII-2A band is $\leq 1.2W/kg$, SAR is not required for U-NII-1 band.

Table 14.5-5: Reported SAR of initial test configuration for Body

802.11 mode	a	n		ac		
		20	40	20	40	80
U-NII-1	36/40/44/48 U-NII-2A exclusion applied	36/40/44/48	38/46	/	/	/
U-NII-2A	52/56/60/64 0.02	52/56/60/64	54/62	/	/	/
U-NII-2C	100/104/108/112 116/120/124/128 132/136/140 0.04	100/104/108/112 116/132/136/140	102/110/118/126/ 134	/	/	/
U-NII-3	149/153/157/161/165 0.05	149/153/157/161/ 165	151/159	/	/	/

U-NII-1 and U-NII-2A bands have the same specified maximum output and tolerance; SAR is measured for U-NII-2A band first. Adjusted SAR of U-NII-2A band is $\leq 1.2W/kg$, SAR is not required for U-NII-1 band.

Table 14.5-6: SAR Values (WLAN - Head) – 802.11a 6Mbps

Frequency		Side	Test Position	Figure No.	Conducted Power (dBm)	Max. tune-up Power (dBm)	Measured SAR(10g) (W/kg)	Reported SAR(10g) (W/kg)	Measured SAR(1g) (W/kg)	Reported SAR(1g) (W/kg)	Power Drift (dB)
MHz	Ch.										
5260	52	Left	Touch	/	12.56	12.6	0.0694	0.07	0.181	0.18	0.13
5260	52	Left	Tilt	/	12.56	12.6	0.0586	0.06	0.165	0.17	0.14
5260	52	Right	Touch	/	12.56	12.6	0.168	0.17	0.624	0.63	0.04
5260	52	Right	Tilt	/	12.56	12.6	0.133	0.13	0.389	0.39	0.02
5560	112	Left	Touch	/	12.82	12.9	0.106	0.11	0.266	0.27	0.12
5560	112	Left	Tilt	/	12.82	12.9	0.0855	0.09	0.25	0.25	0.01
5560	112	Right	Touch	/	12.82	12.9	0.22	0.22	0.779	0.79	-0.05
5560	112	Right	Tilt	/	12.82	12.9	0.202	0.21	0.651	0.66	0.05
5785	157	Left	Touch	/	11.74	11.8	0.132	0.13	0.328	0.33	-0.15
5785	157	Left	Tilt	/	11.74	11.8	0.148	0.15	0.409	0.41	0.11
5785	157	Right	Touch	Fig.17	11.74	11.8	0.299	0.30	1.07	1.08	0.1
5785	157	Right	Tilt	/	11.74	11.8	0.215	0.22	0.684	0.69	-0.04
5805	161	Right	Touch	/	11.71	11.8	0.217	0.22	0.654	0.67	0.09
5785	157	Right	Touch	B1	11.74	11.8	0.223	0.23	0.745	0.76	0.01
5785	157	Right	Touch	S2	11.74	11.8	0.235	0.24	0.772	0.78	0.07

Table 14.5-7: SAR Values (WLAN - Body) – 802.11a 6Mbps

Frequency		Test Position	D (mm)	Figure No.	Conducted Power (dBm)	Max. tune-up Power (dBm)	Measured SAR(10g) (W/kg)	Reported SAR(10g) (W/kg)	Measured SAR(1g) (W/kg)	Reported SAR(1g) (W/kg)	Power Drift (dB)
MHz	Ch.										
5260	52	Front	10	/	12.56	12.6	0.004	<0.01	0.01	0.01	-0.03
5260	52	Rear	10	/	12.56	12.6	0.005	0.01	0.016	0.02	0.02
5260	52	Left	10	/	12.56	12.6	0.003	<0.01	0.001	<0.01	0.01
5260	52	Top	10	/	12.56	12.6	0.004	<0.01	0.012	0.01	0.05
5560	112	Front	10	/	12.82	12.9	0.007	0.01	0.022	0.02	-0.02
5560	112	Rear	10	/	12.82	12.9	0.012	0.01	0.035	0.04	0.04
5560	112	Left	10	/	12.82	12.9	0.002	<0.01	0.012	0.01	0.09
5560	112	Top	10	/	12.82	12.9	0.014	0.01	0.043	0.04	0.01
5785	157	Front	10	/	11.74	11.8	0.011	0.01	0.036	0.04	0.01
5785	157	Rear	10	/	11.74	11.8	0.014	0.01	0.038	0.04	0.04
5785	157	Left	10	/	11.74	11.8	0.005	0.01	0.016	0.02	0.07
5785	157	Top	10	Fig.18	11.74	11.8	0.018	0.02	0.051	0.05	0.04
5785	157	Top	10	B1	11.74	11.8	0.017	0.02	0.043	0.04	0.06
5785	157	Top	10	S2	11.74	11.8	0.016	0.02	0.044	0.04	-0.15

According to the KDB248227 D01, The reported SAR must be scaled to 100% transmission duty factor to determine compliance at the maximum tune-up tolerance limit. The scaled reported SAR is presented as below.

Table 14.5-8: SAR Values (WLAN - Head) – 802.11a 6Mbps (Scaled Reported SAR)

Frequency		Side	Test Position	Actual duty factor	maximum duty factor	Reported SAR (1g) (W/kg)	Scaled reported SAR (1g) (W/kg)
MHz	Ch.						
5785	157	Right	Touch	87.36%	100%	1.08	1.24

Table 14.5-9: SAR Values (WLAN - Body) – 802.11a 6Mbps (Scaled Reported SAR)

Frequency		Test Position	D (mm)	Actual duty factor	maximum duty factor	Reported SAR (1g) (W/kg)	Scaled reported SAR (1g) (W/kg)
MHz	Ch.						
5785	157	Top	10	87.36%	100%	0.05	0.06

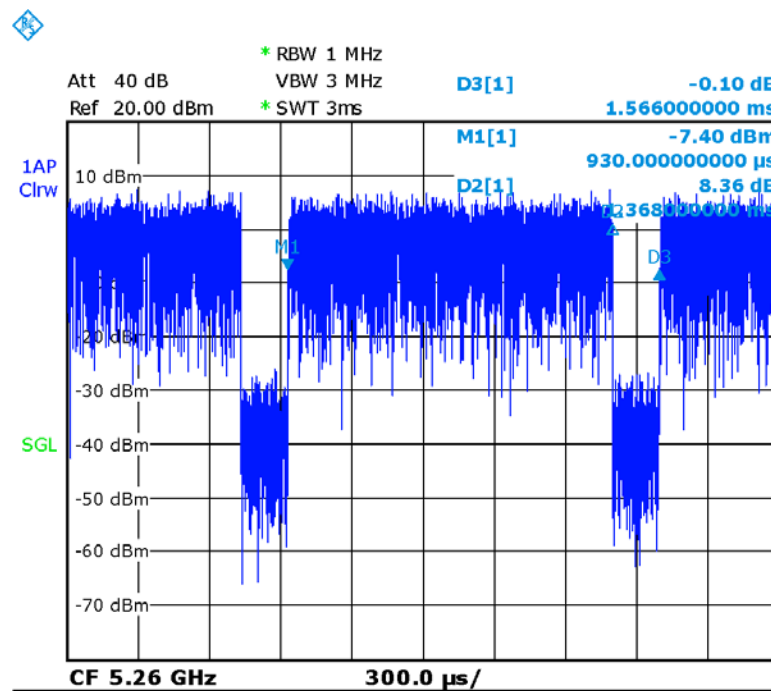

Picture 14.3 The plot of duty factor for CH.52