

FCC SAR Test Report

APPLICANT : HMD Global Oy
EQUIPMENT : Smart Phone
BRAND NAME : NOKIA
MODEL NAME : TA-1004
FCC ID : 2AJOTTA-1004
STANDARD : FCC 47 CFR Part 2 (2.1093)
ANSI/IEEE C95.1-1992
IEEE 1528-2013

We, SPORTON INTERNATIONAL INC., would like to declare that the tested sample has been evaluated in accordance with the procedures and had been in compliance with the applicable technical standards.

The test results in this report apply exclusively to the tested model / sample. Without written approval of SPORTON INTERNATIONAL INC., the test report shall not be reproduced except in full.

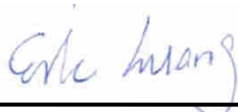

Reviewed by: Eric Huang / Manager



Approved by: Jones Tsai / Manager



SPORTON INTERNATIONAL INC.

No.52, Hwa Ya 1st Rd., Hwa Ya Technology Park, Kwei-Shan District, Taoyuan City, Taiwan (R.O.C.)



Table of Contents

1. Statement of Compliance 4
2. Administration Data 5
3. Guidance Applied..... 5
4. Equipment Under Test (EUT) Information 6
4.1 General Information 6
5. RF Exposure Limits..... 7
5.1 Uncontrolled Environment..... 7
5.2 Controlled Environment..... 7
6. Specific Absorption Rate (SAR)..... 8
6.1 Introduction 8
6.2 SAR Definition..... 8
7. System Description and Setup 9
7.1 E-Field Probe 10
7.2 Data Acquisition Electronics (DAE) 10
7.3 Phantom..... 11
7.4 Device Holder..... 12
8. Measurement Procedures 13
8.1 Spatial Peak SAR Evaluation 13
8.2 Power Reference Measurement..... 14
8.3 Area Scan 14
8.4 Zoom Scan..... 15
8.5 Volume Scan Procedures..... 15
8.6 Power Drift Monitoring..... 15
9. Test Equipment List 16
10. System Verification 17
10.1 Tissue Simulating Liquids..... 17
10.2 Tissue Verification 18
10.3 System Performance Check Results..... 19
11. RF Exposure Positions 20
11.1 Ear and handset reference point 20
11.2 Definition of the cheek position..... 21
11.3 Definition of the tilt position..... 22
11.4 Body Worn Accessory 22
11.5 Wireless Router..... 23
11.6 Product Specific Exposure 23
12. Conducted RF Output Power (Unit: dBm)..... 24
13. ANT+ Exclusions Applied..... 28
14. Antenna Location 29
15. SAR Test Results 30
15.1 Head SAR 31
15.2 Hotspot SAR 31
15.3 Body Worn Accessory SAR..... 31
15.4 Repeated SAR Measurement 31
16. Simultaneous Transmission Analysis..... 32
16.1 Head Exposure Conditions 33
16.2 Hotspot Exposure Conditions..... 33
16.3 Product Specific Exposure Conditions 33
16.4 Body-Worn Accessory Exposure Conditions 33
16.5 SPLSR Evaluation and Analysis..... 34
17. Uncertainty Assessment 35
18. References..... 38
Appendix A. Plots of System Performance Check
Appendix B. Plots of High SAR Measurement
Appendix C. DASYS Calibration Certificate
Appendix D. Reference Report
Appendix E. Test Setup Photos



Revision History

REPORT NO.	VERSION	DESCRIPTION	ISSUED DATE
FA783101	Rev. 01	Initial issue of report	Sep. 08, 2017



1. Statement of Compliance

The maximum results of Specific Absorption Rate (SAR) found during testing for HMD Global Oy, Smart Phone, TA-1004, are as follows.

Equipment Class	Frequency Band	Highest SAR Summary				Highest Simultaneous Transmission 1g SAR (W/kg)
		Head (Separation 0mm)	Body-worn (Separation 15mm)	Hotspot (Separation 10mm)	Product Specific (Separation 0mm)	
		1g SAR (W/kg)			10g SAR (W/kg)	
Licensed	WCDMA IV	0.07	0.38	1.01		1.57
Date of Testing:		2017/9/4				

This device is in compliance with Specific Absorption Rate (SAR) for general population/uncontrolled exposure limits (1.6 W/kg for Partial-Body, 4.0 W/kg for Product Specific) specified in FCC 47 CFR part 2 (2.1093) and ANSI/IEEE C95.1-1992, and had been tested in accordance with the measurement methods and procedures specified in IEEE 1528-2013 and FCC KDB publications



2. Administration Data

Testing Laboratory	
Test Site	SPORTON INTERNATIONAL INC.
Test Site Location	No.52, Hwa Ya 1st Rd., Hwa Ya Technology Park, Kwei-Shan District, Taoyuan City, Taiwan (R.O.C.) TEL: +886-3-327-3456 FAX: +886-3-328-4978

Applicant	
Company Name	HMD Global Oy
Address	Karaportti 2, 02610 Espoo, Finland

Manufacturer	
Company Name	HMD Global Oy
Address	Karaportti 2, 02610 Espoo, Finland

3. Guidance Applied

The Specific Absorption Rate (SAR) testing specification, method, and procedure for this device is in accordance with the following standards:

- FCC 47 CFR Part 2 (2.1093)
- ANSI/IEEE C95.1-1992
- IEEE 1528-2013
- FCC KDB 865664 D01 SAR Measurement 100 MHz to 6 GHz v01r04
- FCC KDB 865664 D02 SAR Reporting v01r02
- FCC KDB 447498 D01 General RF Exposure Guidance v06
- FCC KDB 648474 D04 SAR Evaluation Considerations for Wireless Handsets v01r03
- FCC KDB 248227 D01 802.11 Wi-Fi SAR v02r02
- FCC KDB 941225 D01 3G SAR Procedures v03r01
- FCC KDB 941225 D05 SAR for LTE Devices v02r05
- FCC KDB 941225 D06 Hotspot Mode SAR v02r01



4. Equipment Under Test (EUT) Information

4.1 General Information

Product Feature & Specification	
Equipment Name	Smart Phone
Brand Name	NOKIA
Model Name	TA-1004
FCC ID	2AJOTTA-1004
IMEI	SIM 1 : 004400152020002 SIM 2 : 004400152020002
Wireless Technology and Frequency Range	GSM850: 824.2 MHz ~ 848.8 MHz GSM1900: 1850.2 MHz ~ 1909.8 MHz WCDMA Band II: 1852.4 MHz ~ 1907.6 MHz WCDMA Band IV: 1712.4 MHz ~ 1752.6 MHz WCDMA Band V: 826.4 MHz ~ 846.6 MHz LTE Band 2: 1850.7 MHz ~ 1909.3 MHz LTE Band 4: 1710.7 MHz ~ 1754.3 MHz LTE Band 5: 824.7 MHz ~ 848.3 MHz LTE Band 7: 2502.5 MHz ~ 2567.5 MHz LTE Band 38: 2572.5 MHz ~ 2617.5 MHz LTE Band 41: 2498.5 MHz ~ 2687.5 MHz WLAN 2.4GHz Band: 2412 MHz ~ 2462 MHz WLAN 5.2GHz Band: 5180 MHz ~ 5240 MHz WLAN 5.3GHz Band: 5260 MHz ~ 5320 MHz WLAN 5.5GHz Band: 5500 MHz ~ 5720 MHz WLAN 5.8GHz Band: 5745 MHz ~ 5825 MHz Bluetooth: 2402 MHz ~ 2480 MHz NFC : 13.56 MHz ANT+: 2402 MHz ~ 2480 MHz
Mode	GSM/GPRS/EGPRS/DTM RMC/AMR 12.2Kbps HSDPA HSUPA DC-HSDPA LTE: QPSK, 16QAM WLAN 2.4GHz : 802.11b/g/n HT20 WLAN 5GHz : 802.11a/n/ac HT20/HT40/VHT20/VHT40/VHT80 Bluetooth BR/EDR/LE NFC:ASK ANT+: GFSK
HW Version	170
SW Version	V2.500
GSM / (E)GPRS Dual Transfer mode	Class A – EUT can support Packet Switched and Circuit Switched Network simultaneously.
EUT Stage	Identical Prototype
Remark:	
<ol style="list-style-type: none"> This is a variant report and the detail changes please refer to "PED". This report only has WCDMA Band IV test record, for other frequency test records please refer to Sporton FCC SAR Test Report, Report No.: FA712102 as Appendix D. 	



5. RF Exposure Limits

5.1 Uncontrolled Environment

Uncontrolled Environments are defined as locations where there is the exposure of individuals who have no knowledge or control of their exposure. The general population/uncontrolled exposure limits are applicable to situations in which the general public may be exposed or in which persons who are exposed as a consequence of their employment may not be made fully aware of the potential for exposure or cannot exercise control over their exposure. Members of the general public would come under this category when exposure is not employment-related; for example, in the case of a wireless transmitter that exposes persons in its vicinity.

5.2 Controlled Environment

Controlled Environments are defined as locations where there is exposure that may be incurred by persons who are aware of the potential for exposure, (i.e. as a result of employment or occupation). In general, occupational/controlled exposure limits are applicable to situations in which persons are exposed as a consequence of their employment, who have been made fully aware of the potential for exposure and can exercise control over their exposure. The exposure category is also applicable when the exposure is of a transient nature due to incidental passage through a location where the exposure levels may be higher than the general population/uncontrolled limits, but the exposed person is fully aware of the potential for exposure and can exercise control over his or her exposure by leaving the area or by some other appropriate means.

Limits for Occupational/Controlled Exposure (W/kg)

Whole-Body	Partial-Body	Hands, Wrists, Feet and Ankles
0.4	8.0	20.0

Limits for General Population/Uncontrolled Exposure (W/kg)

Whole-Body	Partial-Body	Hands, Wrists, Feet and Ankles
0.08	1.6	4.0

1. Whole-Body SAR is averaged over the entire body, partial-body SAR is averaged over any 1gram of tissue defined as a tissue volume in the shape of a cube. SAR for hands, wrists, feet and ankles is averaged over any 10 grams of tissue defined as a tissue volume in the shape of a cube.



6. Specific Absorption Rate (SAR)

6.1 Introduction

SAR is related to the rate at which energy is absorbed per unit mass in an object exposed to a radio field. The SAR distribution in a biological body is complicated and is usually carried out by experimental techniques or numerical modeling. The standard recommends limits for two tiers of groups, occupational/controlled and general population/uncontrolled, based on a person's awareness and ability to exercise control over his or her exposure. In general, occupational/controlled exposure limits are higher than the limits for general population/uncontrolled.

6.2 SAR Definition

The SAR definition is the time derivative (rate) of the incremental energy (dW) absorbed by (dissipated in) an incremental mass (dm) contained in a volume element (dv) of a given density (ρ). The equation description is as below:

$$SAR = \frac{d}{dt} \left(\frac{dW}{dm} \right) = \frac{d}{dt} \left(\frac{dW}{\rho dv} \right)$$

SAR is expressed in units of Watts per kilogram (W/kg)

$$SAR = \frac{\sigma |E|^2}{\rho}$$

Where: σ is the conductivity of the tissue, ρ is the mass density of the tissue and E is the RMS electrical field strength.

7. System Description and Setup

The DASY system used for performing compliance tests consists of the following items:

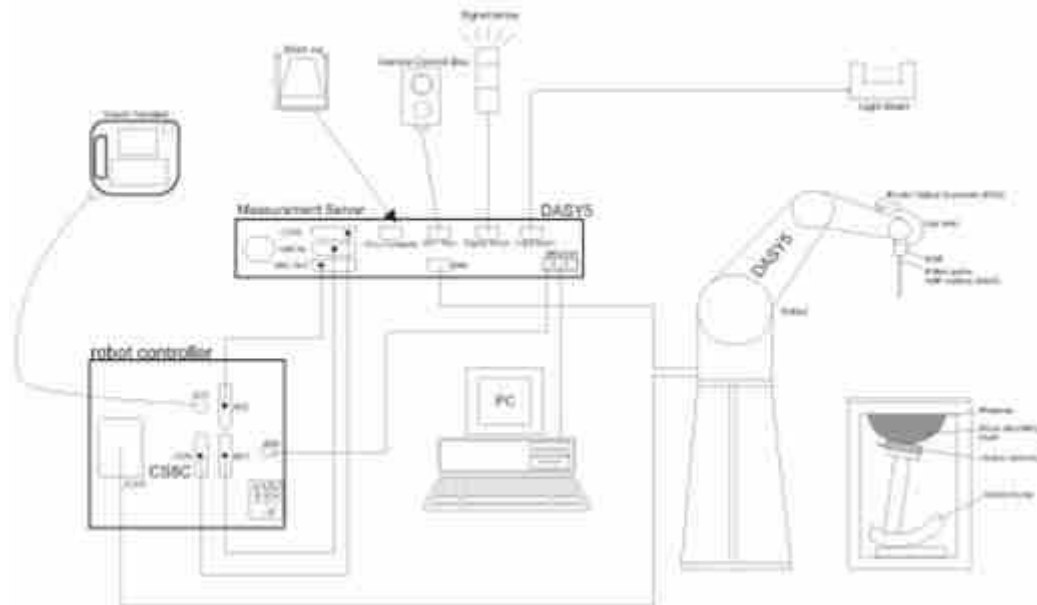

- A standard high precision 6-axis robot with controller, teach pendant and software. An arm extension for accommodating the data acquisition electronics (DAE).
- An isotropic Field probe optimized and calibrated for the targeted measurement.
- A data acquisition electronics (DAE) which performs the signal amplification, signal multiplexing, AD-conversion, offset measurements, mechanical surface detection, collision detection, etc. The unit is battery powered with standard or rechargeable batteries. The signal is optically transmitted to the EOC.
- The Electro-optical converter (EOC) performs the conversion from optical to electrical signals for the digital communication to the DAE. To use optical surface detection, a special version of the EOC is required. The EOC signal is transmitted to the measurement server.
- The function of the measurement server is to perform the time critical tasks such as signal filtering, control of the robot operation and fast movement interrupts.
- The Light Beam used is for probe alignment. This improves the (absolute) accuracy of the probe positioning.
- A computer running WinXP or Win7 and the DASY5 software.
- Remote control and teach pendant as well as additional circuitry for robot safety such as warning lamps, etc.
- The phantom, the device holder and other accessories according to the targeted measurement.

7.1 E-Field Probe

The SAR measurement is conducted with the dosimetric probe (manufactured by SPEAG). The probe is specially designed and calibrated for use in liquid with high permittivity. The dosimetric probe has special calibration in liquid at different frequency. This probe has a built in optical surface detection system to prevent from collision with phantom.

<ES3DV3 Probe>

Construction	Symmetric design with triangular core Interleaved sensors Built-in shielding against static charges PEEK enclosure material (resistant to organic solvents, e.g., DGBE)	
Frequency	10 MHz – 4 GHz; Linearity: ± 0.2 dB (30 MHz – 4 GHz)	
Directivity	± 0.2 dB in TSL (rotation around probe axis) ± 0.3 dB in TSL (rotation normal to probe axis)	
Dynamic Range	5 μ W/g – >100 mW/g; Linearity: ± 0.2 dB	
Dimensions	Overall length: 337 mm (tip: 20 mm) Tip diameter: 3.9 mm (body: 12 mm) Distance from probe tip to dipole centers: 3.0 mm	

<EX3DV4 Probe>

Construction	Symmetric design with triangular core Built-in shielding against static charges PEEK enclosure material (resistant to organic solvents, e.g., DGBE)	
Frequency	10 MHz – >6 GHz Linearity: ± 0.2 dB (30 MHz – 6 GHz)	
Directivity	± 0.3 dB in TSL (rotation around probe axis) ± 0.5 dB in TSL (rotation normal to probe axis)	
Dynamic Range	10 μ W/g – >100 mW/g Linearity: ± 0.2 dB (noise: typically <1 μ W/g)	
Dimensions	Overall length: 337 mm (tip: 20 mm) Tip diameter: 2.5 mm (body: 12 mm) Typical distance from probe tip to dipole centers: 1 mm	

7.2 Data Acquisition Electronics (DAE)

The data acquisition electronics (DAE) consists of a highly sensitive electrometer-grade preamplifier with auto-zeroing, a channel and gain-switching multiplexer, a fast 16 bit AD-converter and a command decoder and control logic unit. Transmission to the measurement server is accomplished through an optical downlink for data and status information as well as an optical uplink for commands and the clock.

The input impedance of the DAE is 200 MOhm; the inputs are symmetrical and floating. Common mode rejection is above 80 dB.



Fig 5.1 Photo of DAE

7.3 Phantom

<SAM Twin Phantom>

Shell Thickness	2 ± 0.2 mm; Center ear point: 6 ± 0.2 mm	
Filling Volume	Approx. 25 liters	
Dimensions	Length: 1000 mm; Width: 500 mm; Height: adjustable feet	
Measurement Areas	Left Hand, Right Hand, Flat Phantom	

The bottom plate contains three pair of bolts for locking the device holder. The device holder positions are adjusted to the standard measurement positions in the three sections. A white cover is provided to tap the phantom during off-periods to prevent water evaporation and changes in the liquid parameters. On the phantom top, three reference markers are provided to identify the phantom position with respect to the robot.

<ELI Phantom>

Shell Thickness	2 ± 0.2 mm (sagging: <1%)	
Filling Volume	Approx. 30 liters	
Dimensions	Major ellipse axis: 600 mm Minor axis: 400 mm	

The ELI phantom is intended for compliance testing of handheld and body-mounted wireless devices in the frequency range of 30 MHz to 6 GHz. ELI4 is fully compatible with standard and all known tissue simulating liquids.

7.4 Device Holder

<Mounting Device for Hand-Held Transmitter>

In combination with the Twin SAM V5.0/V5.0c or ELI phantoms, the Mounting Device for Hand-Held Transmitters enables rotation of the mounted transmitter device to specified spherical coordinates. At the heads, the rotation axis is at the ear opening. Transmitter devices can be easily and accurately positioned according to IEC 62209-1, IEEE 1528, FCC, or other specifications. The device holder can be locked for positioning at different phantom sections (left head, right head, flat). And upgrade kit to Mounting Device to enable easy mounting of wider devices like big smart-phones, e-books, small tablets, etc. It holds devices with width up to 140 mm.



Mounting Device for Hand-Held Transmitters



Mounting Device Adaptor for Wide-Phones

<Mounting Device for Laptops and other Body-Worn Transmitters>

The extension is lightweight and made of POM, acrylic glass and foam. It fits easily on the upper part of the mounting device in place of the phone positioned. The extension is fully compatible with the SAM Twin and ELI phantoms.



Mounting Device for Laptops



8. Measurement Procedures

The measurement procedures are as follows:

<Conducted power measurement>

- (a) For WWAN power measurement, use base station simulator to configure EUT WWAN transmission in conducted connection with RF cable, at maximum power in each supported wireless interface and frequency band.
- (b) Read the WWAN RF power level from the base station simulator.
- (c) For WLAN/BT power measurement, use engineering software to configure EUT WLAN/BT continuously transmission, at maximum RF power in each supported wireless interface and frequency band
- (d) Connect EUT RF port through RF cable to the power meter, and measure WLAN/BT output power

<SAR measurement>

- (a) Use base station simulator to configure EUT WWAN transmission in radiated connection, and engineering software to configure EUT WLAN/BT continuously transmission, at maximum RF power, in the highest power channel.
- (b) Place the EUT in the positions as Appendix D demonstrates.
- (c) Set scan area, grid size and other setting on the DASY software.
- (d) Measure SAR results for the highest power channel on each testing position.
- (e) Find out the largest SAR result on these testing positions of each band
- (f) Measure SAR results for other channels in worst SAR testing position if the reported SAR of highest power channel is larger than 0.8 W/kg

According to the test standard, the recommended procedure for assessing the peak spatial-average SAR value consists of the following steps:

- (a) Power reference measurement
- (b) Area scan
- (c) Zoom scan
- (d) Power drift measurement

8.1 Spatial Peak SAR Evaluation

The procedure for spatial peak SAR evaluation has been implemented according to the test standard. It can be conducted for 1g and 10g, as well as for user-specific masses. The DASY software includes all numerical procedures necessary to evaluate the spatial peak SAR value.

The base for the evaluation is a "cube" measurement. The measured volume must include the 1g and 10g cubes with the highest averaged SAR values. For that purpose, the center of the measured volume is aligned to the interpolated peak SAR value of a previously performed area scan.

The entire evaluation of the spatial peak values is performed within the post-processing engine (SEMCAD). The system always gives the maximum values for the 1g and 10g cubes. The algorithm to find the cube with highest averaged SAR is divided into the following stages:

- (a) Extraction of the measured data (grid and values) from the Zoom Scan
- (b) Calculation of the SAR value at every measurement point based on all stored data (A/D values and measurement parameters)
- (c) Generation of a high-resolution mesh within the measured volume
- (d) Interpolation of all measured values from the measurement grid to the high-resolution grid
- (e) Extrapolation of the entire 3-D field distribution to the phantom surface over the distance from sensor to surface
- (f) Calculation of the averaged SAR within masses of 1g and 10g

8.2 Power Reference Measurement

The Power Reference Measurement and Power Drift Measurements are for monitoring the power drift of the device under test in the batch process. The minimum distance of probe sensors to surface determines the closest measurement point to phantom surface. This distance cannot be smaller than the distance of sensor calibration points to probe tip as defined in the probe properties.

8.3 Area Scan

The area scan is used as a fast scan in two dimensions to find the area of high field values, before doing a fine measurement around the hot spot. The sophisticated interpolation routines implemented in DASY software can find the maximum found in the scanned area, within a range of the global maximum. The range (in dB0 is specified in the standards for compliance testing. For example, a 2 dB range is required in IEEE standard 1528 and IEC 62209 standards, whereby 3 dB is a requirement when compliance is assessed in accordance with the ARIB standard (Japan), if only one zoom scan follows the area scan, then only the absolute maximum will be taken as reference. For cases where multiple maximums are detected, the number of zoom scans has to be increased accordingly.

Area scan parameters extracted from FCC KDB 865664 D01v01r04 SAR measurement 100 MHz to 6 GHz.

	≤ 3 GHz	> 3 GHz
Maximum distance from closest measurement point (geometric center of probe sensors) to phantom surface	5 ± 1 mm	$\frac{1}{2} \cdot \delta \cdot \ln(2) \pm 0.5$ mm
Maximum probe angle from probe axis to phantom surface normal at the measurement location	30° ± 1°	20° ± 1°
Maximum area scan spatial resolution: $\Delta x_{Area}, \Delta y_{Area}$	≤ 2 GHz: ≤ 15 mm 2 – 3 GHz: ≤ 12 mm	3 – 4 GHz: ≤ 12 mm 4 – 6 GHz: ≤ 10 mm
	When the x or y dimension of the test device, in the measurement plane orientation, is smaller than the above, the measurement resolution must be ≤ the corresponding x or y dimension of the test device with at least one measurement point on the test device.	

8.4 Zoom Scan

Zoom scans are used to assess the peak spatial SAR values within a cubic averaging volume containing 1 gram and 10 gram of simulated tissue. The zoom scan measures points (refer to table below) within a cube whose base faces are centered on the maxima found in a preceding area scan job within the same procedure. When the measurement is done, the zoom scan evaluates the averaged SAR for 1 gram and 10 gram and displays these values next to the job's label.

Zoom scan parameters extracted from FCC KDB 865664 D01v01r04 SAR measurement 100 MHz to 6 GHz.

		≤ 3 GHz	> 3 GHz	
Maximum zoom scan spatial resolution: $\Delta x_{Zoom}, \Delta y_{Zoom}$		≤ 2 GHz: ≤ 8 mm 2 – 3 GHz: ≤ 5 mm*	3 – 4 GHz: ≤ 5 mm* 4 – 6 GHz: ≤ 4 mm*	
Maximum zoom scan spatial resolution, normal to phantom surface	uniform grid: $\Delta z_{Zoom}(n)$	≤ 5 mm	3 – 4 GHz: ≤ 4 mm 4 – 5 GHz: ≤ 3 mm 5 – 6 GHz: ≤ 2 mm	
	graded grid	$\Delta z_{Zoom}(1)$: between 1 st two points closest to phantom surface	≤ 4 mm	3 – 4 GHz: ≤ 3 mm 4 – 5 GHz: ≤ 2.5 mm 5 – 6 GHz: ≤ 2 mm
		$\Delta z_{Zoom}(n>1)$: between subsequent points	$\leq 1.5 \cdot \Delta z_{Zoom}(n-1)$	
Minimum zoom scan volume	x, y, z	≥ 30 mm	3 – 4 GHz: ≥ 28 mm 4 – 5 GHz: ≥ 25 mm 5 – 6 GHz: ≥ 22 mm	
Note: δ is the penetration depth of a plane-wave at normal incidence to the tissue medium; see draft standard IEEE P1528-2011 for details. * When zoom scan is required and the <i>reported</i> SAR from the <i>area scan based 1-g SAR estimation</i> procedures of KDB 447498 is ≤ 1.4 W/kg, ≤ 8 mm, ≤ 7 mm and ≤ 5 mm zoom scan resolution may be applied, respectively, for 2 GHz to 3 GHz, 3 GHz to 4 GHz and 4 GHz to 6 GHz.				

8.5 Volume Scan Procedures

The volume scan is used to assess overlapping SAR distributions for antennas transmitting in different frequency bands. It is equivalent to an oversized zoom scan used in standalone measurements. The measurement volume will be used to enclose all the simultaneous transmitting antennas. For antennas transmitting simultaneously in different frequency bands, the volume scan is measured separately in each frequency band. In order to sum correctly to compute the 1g aggregate SAR, the EUT remain in the same test position for all measurements and all volume scan use the same spatial resolution and grid spacing. When all volume scan were completed, the software, SEMCAD postprocessor can combine and subsequently superpose these measurement data to calculating the multiband SAR.

8.6 Power Drift Monitoring

All SAR testing is under the EUT install full charged battery and transmit maximum output power. In DASy measurement software, the power reference measurement and power drift measurement procedures are used for monitoring the power drift of EUT during SAR test. Both these procedures measure the field at a specified reference position before and after the SAR testing. The software will calculate the field difference in dB. If the power drifts more than 5%, the SAR will be retested.



9. Test Equipment List

Manufacturer	Name of Equipment	Type/Model	Serial Number	Calibration	
				Last Cal.	Due Date
SPEAG	1750MHz System Validation Kit	D1750V2	1068	Nov. 16, 2016	Nov. 15, 2017
SPEAG	Data Acquisition Electronics	DAE4	854	May. 02, 2017	May. 01, 2018
SPEAG	Dosimetric E-Field Probe	EX3DV4	7306	Jul. 24, 2017	Jul. 23, 2018
Wisewind	Thermometer	HTC-1	TM225	Oct. 12, 2016	Oct. 11, 2017
Anritsu	Radio Communication Analyzer	MT8820C	6201341950	Dec. 14, 2016	Dec. 13, 2017
SPEAG	Device Holder	N/A	N/A	N/A	N/A
Anritsu	Signal Generator	MG3710A	6201502524	Dec. 09, 2016	Dec. 08, 2017
Agilent	ENA Network Analyzer	E5071C	MY46316648	Jan. 04, 2017	Jan. 03, 2018
SPEAG	Dielectric Probe Kit	DAK-3.5	1146	Jul. 18, 2017	Jul. 17, 2018
LINE SEIKI	Digital Thermometer	LKMelectronic	DTM3000SPEZIAL	Sep. 05, 2016	Sep. 04, 2017
Anritsu	Power Meter	ML2495A	1438002	Dec. 06, 2016	Dec. 05, 2017
Anritsu	Power Sensor	MA2411B	1339195	Dec. 06, 2016	Dec. 05, 2017
Anritsu	Spectrum Analyzer	MS2830A	6201396378	Jun. 26, 2017	Jun. 25, 2018
Mini-Circuits	Power Amplifier	ZVE-8G+	D120604	Mar. 09, 2017	Mar. 08, 2018
Mini-Circuits	Power Amplifier	ZHL-42W+	QA1344002	Mar. 09, 2017	Mar. 08, 2018
ATM	Dual Directional Coupler	C122H-10	P610410z-02	Note 1	
Woken	Attenuator 1	WK0602-XX	N/A	Note 1	
PE	Attenuator 2	PE7005-10	N/A	Note 1	
PE	Attenuator 3	PE7005- 3	N/A	Note 1	

General Note:

1. Prior to system verification and validation, the path loss from the signal generator to the system check source and the power meter, which includes the amplifier, cable, attenuator and directional coupler, was measured by the network analyzer. The reading of the power meter was offset by the path loss difference between the path to the power meter and the path to the system check source to monitor the actual power level fed to the system check source.

10. System Verification

10.1 Tissue Simulating Liquids

For the measurement of the field distribution inside the SAM phantom with DASY, the phantom must be filled with around 25 liters of homogeneous body tissue simulating liquid. For head SAR testing, the liquid height from the ear reference point (ERP) of the phantom to the liquid top surface is larger than 15 cm, which is shown in Fig. 10.1. For body SAR testing, the liquid height from the center of the flat phantom to the liquid top surface is larger than 15 cm, which is shown in Fig. 10.2.



Fig 10.1 Photo of Liquid Height for Head SAR

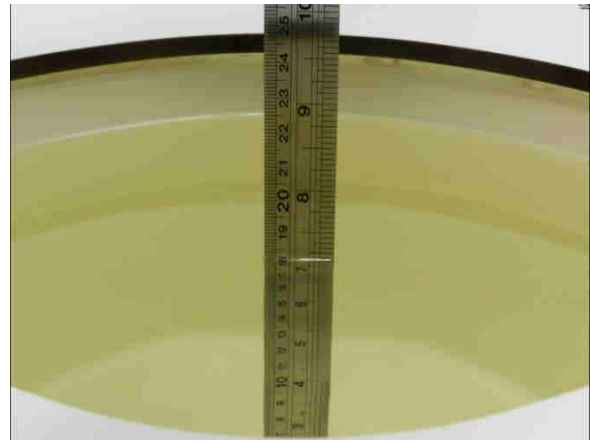

Fig 10.2 Photo of Liquid Height for Body SAR



10.2 Tissue Verification

The following tissue formulations are provided for reference only as some of the parameters have not been thoroughly verified. The composition of ingredients may be modified accordingly to achieve the desired target tissue parameters required for routine SAR evaluation.

Frequency (MHz)	Water (%)	Sugar (%)	Cellulose (%)	Salt (%)	Preventol (%)	DGBE (%)	Conductivity (σ)	Permittivity (ϵ_r)
For Head								
750	41.1	57.0	0.2	1.4	0.2	0	0.89	41.9
835	40.3	57.9	0.2	1.4	0.2	0	0.90	41.5
900	40.3	57.9	0.2	1.4	0.2	0	0.97	41.5
1800, 1900, 2000	55.2	0	0	0.3	0	44.5	1.40	40.0
2450	55.0	0	0	0	0	45.0	1.80	39.2
2600	54.8	0	0	0.1	0	45.1	1.96	39.0
For Body								
750	51.7	47.2	0	0.9	0.1	0	0.96	55.5
835	50.8	48.2	0	0.9	0.1	0	0.97	55.2
900	50.8	48.2	0	0.9	0.1	0	1.05	55.0
1800, 1900, 2000	70.2	0	0	0.4	0	29.4	1.52	53.3
2450	68.6	0	0	0	0	31.4	1.95	52.7
2600	68.1	0	0	0.1	0	31.8	2.16	52.5

Simulating Liquid for 5GHz, Manufactured by SPEAG

Ingredients	(% by weight)
Water	64~78%
Mineral oil	11~18%
Emulsifiers	9~15%
Additives and Salt	2~3%

<Tissue Dielectric Parameter Check Results>

Frequency (MHz)	Tissue Type	Liquid Temp. (°C)	Conductivity (σ)	Permittivity (ϵ_r)	Conductivity Target (σ)	Permittivity Target (ϵ_r)	Delta (σ) (%)	Delta (ϵ_r) (%)	Limit (%)	Date
1750	HSL	22.6	1.379	38.785	1.37	40.10	0.66	-3.28	±5	2017/9/4
1750	MSL	22.6	1.450	55.244	1.49	53.40	-2.68	3.45	±5	2017/9/4

10.3 System Performance Check Results

Comparing to the original SAR value provided by SPEAG, the verification data should be within its specification of 10 %. Below table shows the target SAR and measured SAR after normalized to 1W input power. The table below indicates the system performance check can meet the variation criterion and the plots can be referred to Appendix A of this report.

Date	Frequency (MHz)	Tissue Type	Input Power (mW)	Dipole S/N	Probe S/N	DAE S/N	Measured 1g SAR (W/kg)	Targeted 1g SAR (W/kg)	Normalized 1g SAR (W/kg)	Deviation (%)
2017/9/4	1750	HSL	250	D1750V2-1068	EX3DV4 - SN7306	DAE4 Sn854	8.72	36.60	34.88	-4.70
2017/9/4	1750	MSL	250	D1750V2-1068	EX3DV4 - SN7306	DAE4 Sn854	8.49	36.20	33.96	-6.19

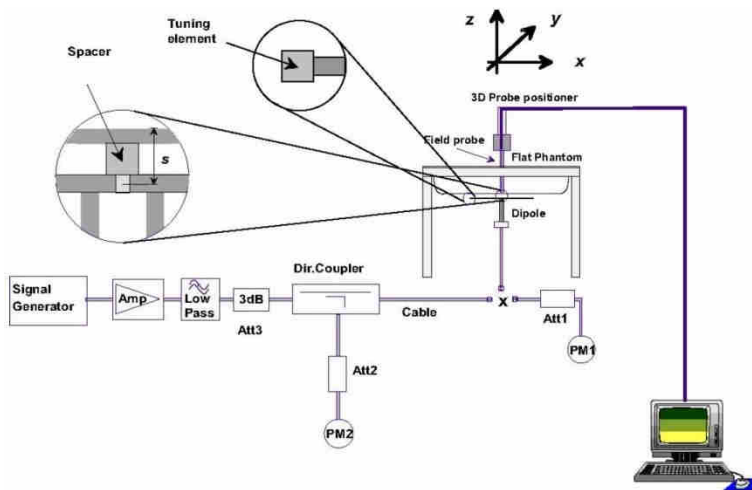

Fig 8.3.1 System Performance Check Setup



Fig 8.3.2 Setup Photo

11. RF Exposure Positions

11.1 Ear and handset reference point

Figure 9.1.1 shows the front, back, and side views of the SAM phantom. The center-of-mouth reference point is labeled “M,” the left ear reference point (ERP) is marked “LE,” and the right ERP is marked “RE.” Each ERP is 15 mm along the B-M (back-mouth) line behind the entrance-to-ear-canal (EEC) point, as shown in Figure 9.1.2 The Reference Plane is defined as passing through the two ear reference points and point M. The line N-F (neck-front), also called the reference pivoting line, is normal to the Reference Plane and perpendicular to both a line passing through RE and LE and the B-M line (see Figure 9.1.3). Both N-F and B-M lines should be marked on the exterior of the phantom shell to facilitate handset positioning. Posterior to the N-F line the ear shape is a flat surface with 6 mm thickness at each ERP, and forward of the N-F line the ear is truncated, as illustrated in Figure 9.1.2. The ear truncation is introduced to preclude the ear lobe from interfering with handset tilt, which could lead to unstable positioning at the cheek.

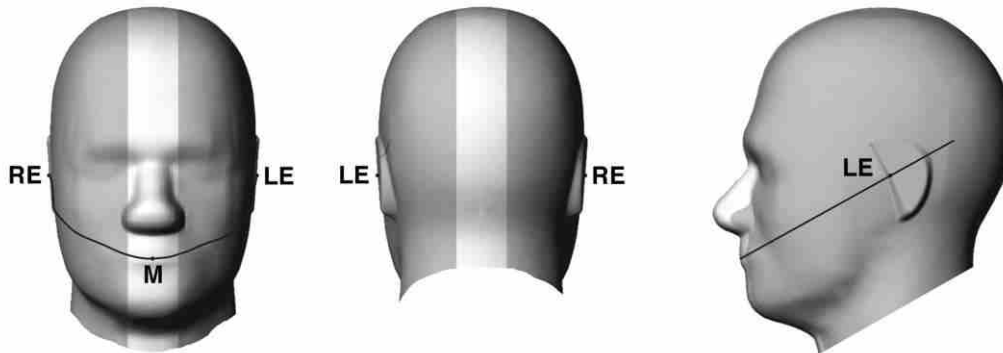

Fig 9.1.1 Front, back, and side views of SAM twin phantom

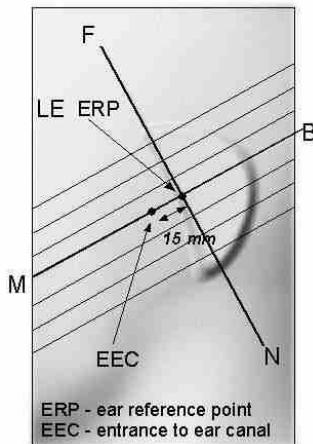

Fig 9.1.2 Close-up side view of phantom showing the ear region.

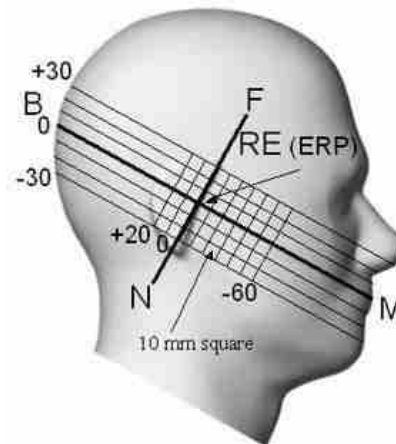

Fig 9.1.3 Side view of the phantom showing relevant markings and seven cross-sectional plane locations

11.2 Definition of the cheek position

1. Ready the handset for talk operation, if necessary. For example, for handsets with a cover piece (flip cover), open the cover. If the handset can transmit with the cover closed, both configurations must be tested.
2. Define two imaginary lines on the handset—the vertical centerline and the horizontal line. The vertical centerline passes through two points on the front side of the handset—the midpoint of the width w_t of the handset at the level of the acoustic output (point A in Figure 9.2.1 and Figure 9.2.2), and the midpoint of the width w_b of the bottom of the handset (point B). The horizontal line is perpendicular to the vertical centerline and passes through the center of the acoustic output (see Figure 9.2.1). The two lines intersect at point A. Note that for many handsets, point A coincides with the center of the acoustic output; however, the acoustic output may be located elsewhere on the horizontal line. Also note that the vertical centerline is not necessarily parallel to the front face of the handset (see Figure 9.2.2), especially for clamshell handsets, handsets with flip covers, and other irregularly-shaped handsets.
3. Position the handset close to the surface of the phantom such that point A is on the (virtual) extension of the line passing through points RE and LE on the phantom (see Figure 9.2.3), such that the plane defined by the vertical centerline and the horizontal line of the handset is approximately parallel to the sagittal plane of the phantom.
4. Translate the handset towards the phantom along the line passing through RE and LE until handset point A touches the pinna at the ERP.
5. While maintaining the handset in this plane, rotate it around the LE-RE line until the vertical centerline is in the plane normal to the plane containing B-M and N-F lines, i.e., the Reference Plane.
6. Rotate the handset around the vertical centerline until the handset (horizontal line) is parallel to the N-F line.
7. While maintaining the vertical centerline in the Reference Plane, keeping point A on the line passing through RE and LE, and maintaining the handset contact with the pinna, rotate the handset about the N-F line until any point on the handset is in contact with a phantom point below the pinna on the cheek. See Figure 9.2.3. The actual rotation angles should be documented in the test report.

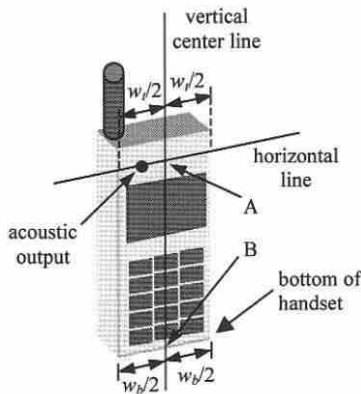

Fig 9.2.1 Handset vertical and horizontal reference lines—“fixed case”

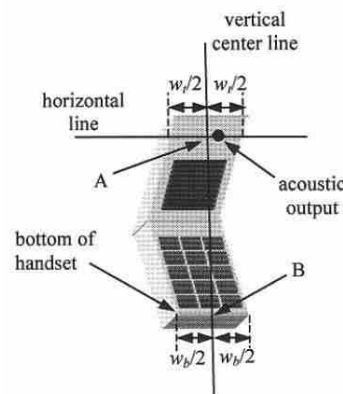

Fig 9.2.2 Handset vertical and horizontal reference lines—“clam-shell case”

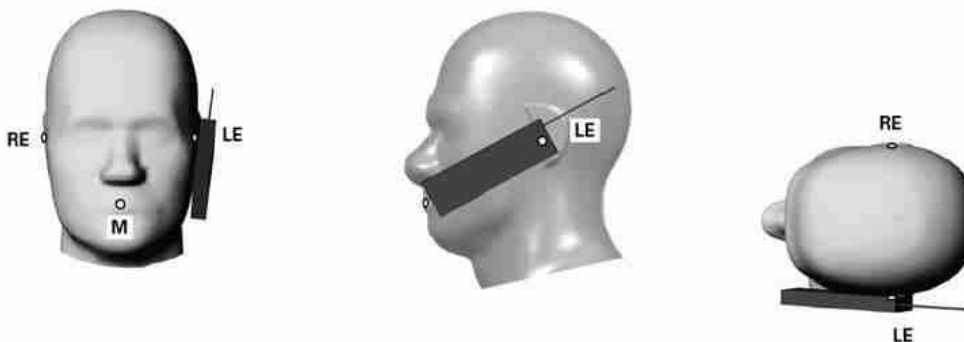

Fig 9.2.3 cheek or touch position. The reference points for the right ear (RE), left ear (LE), and mouth (M), which establish the Reference Plane for handset positioning, are indicated.

11.3 Definition of the tilt position

1. Ready the handset for talk operation, if necessary. For example, for handsets with a cover piece (flip cover), open the cover. If the handset can transmit with the cover closed, both configurations must be tested.
2. While maintaining the orientation of the handset, move the handset away from the pinna along the line passing through RE and LE far enough to allow a rotation of the handset away from the cheek by 15°.
3. Rotate the handset around the horizontal line by 15°.
4. While maintaining the orientation of the handset, move the handset towards the phantom on the line passing through RE and LE until any part of the handset touches the ear. The tilt position is obtained when the contact point is on the pinna. See Figure 9.3.1. If contact occurs at any location other than the pinna, e.g., the antenna at the back of the phantom head, the angle of the handset should be reduced. In this case, the tilt position is obtained if any point on the handset is in contact with the pinna and a second point

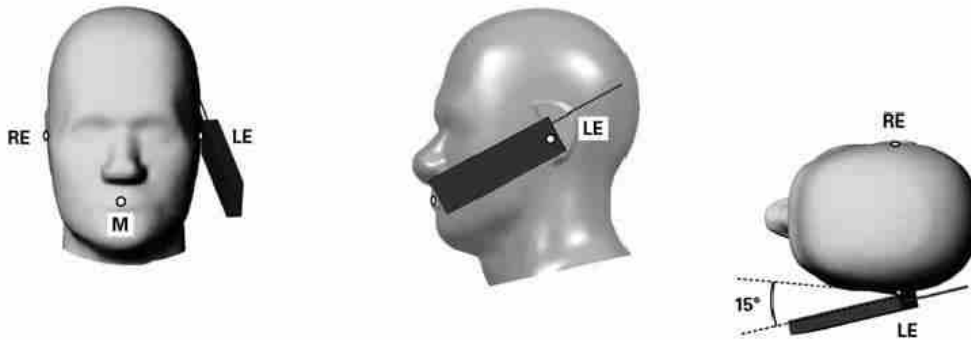

Fig 9.3.1 Tilt position. The reference points for the right ear (RE), left ear (LE), and mouth (M), which define the Reference Plane for handset positioning, are indicated.

11.4 Body Worn Accessory

Body-worn operating configurations are tested with the belt-clips and holsters attached to the device and positioned against a flat phantom in a normal use configuration (see Figure 9.4). Per KDB648474 D04v01r03, body-worn accessory exposure is typically related to voice mode operations when handsets are carried in body-worn accessories. The body-worn accessory procedures in FCC KDB 447498 D01v06 should be used to test for body-worn accessory SAR compliance, without a headset connected to it. This enables the test results for such configuration to be compatible with that required for hotspot mode when the body-worn accessory test separation distance is greater than or equal to that required for hotspot mode, when applicable. When the reported SAR for body-worn accessory, measured without a headset connected to the handset is > 1.2 W/kg, the highest reported SAR configuration for that wireless mode and frequency band should be repeated for that body-worn accessory with a handset attached to the handset.

Accessories for body-worn operation configurations are divided into two categories: those that do not contain metallic components and those that do contain metallic components. When multiple accessories that do not contain metallic components are supplied with the device, the device is tested with only the accessory that dictates the closest spacing to the body. Then multiple accessories that contain metallic components are test with the device with each accessory. If multiple accessories share an identical metallic component (i.e. the same metallic belt-chip used with different holsters with no other metallic components) only the accessory that dictates the closest spacing to the body is tested.

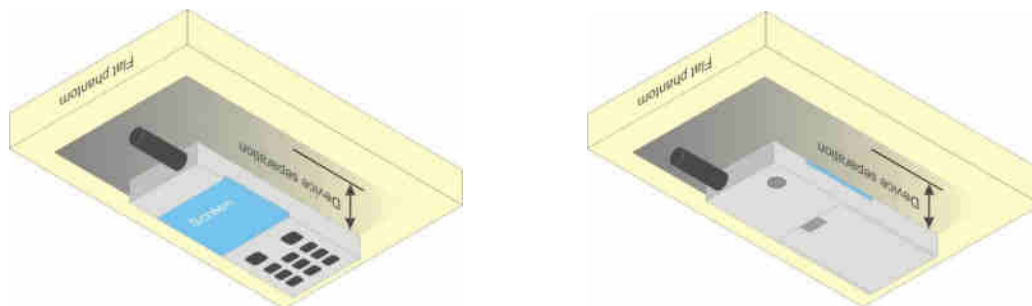

Fig 9.4 Body Worn Position



11.5 Wireless Router

Some battery-operated handsets have the capability to transmit and receive user through simultaneous transmission of WIFI simultaneously with a separate licensed transmitter. The FCC has provided guidance in FCC KDB Publication 941225 D06 v02r01 where SAR test considerations for handsets ($L \times W \geq 9 \text{ cm} \times 5 \text{ cm}$) are based on a composite test separation distance of 10mm from the front, back and edges of the device containing transmitting antennas within 2.5cm of their edges, determined from general mixed use conditions for this type of devices. Since the hotspot SAR results may overlap with the body-worn accessory SAR requirements, the more conservative configurations can be considered, thus excluding some body-worn accessory SAR tests.

When the user enables the personal wireless router functions for the handset, actual operations include simultaneous transmission of both the WIFI transmitter and another licensed transmitter. Both transmitters often do not transmit at the same transmitting frequency and thus cannot be evaluated for SAR under actual use conditions due to the limitations of the SAR assessment probes. Therefore, SAR must be evaluated for each frequency transmission and mode separately and spatially summed with the WIFI transmitter according to FCC KDB Publication 447498 D01v06 publication procedures. The "Portable Hotspot" feature on the handset was NOT activated during SAR assessments, to ensure the SAR measurements were evaluated for a single transmission frequency RF signal at a time.

11.6 Product Specific Exposure

For smart phones with a display diagonal dimension $> 15.0 \text{ cm}$ or an overall diagonal dimension $> 16.0 \text{ cm}$ that provide similar mobile web access and multimedia support found in mini-tablets or UMPC mini-tablets that support voice calls next to the ear, According to KDB648474 D04v01r03, the following phablet procedures should be applied to evaluate SAR compliance for each applicable wireless modes and frequency band. Devices marketed as phablets, regardless of form factors and operating characteristics must be tested as a phablet to determine SAR compliance

1. The normally required head and body-worn accessory SAR test procedures for handsets, including hotspot mode, must be applied.
2. The UMPC mini-tablet procedures must also be applied to test the SAR of all surfaces and edges with an antenna located at $\leq 25 \text{ mm}$ from that surface or edge, in direct contact with a flat phantom, for 10-g Product Specific SAR according to the body-equivalent tissue dielectric parameters in KDB 865664 to address interactive hand use exposure conditions.6 The UMPC mini-tablet 1-g SAR at 5 mm is not required. When hotspot mode applies, 10-g Product Specific SAR is required only for the surfaces and edges with hotspot mode 1-g reported SAR $> 1.2 \text{ W/kg}$.

12. Conducted RF Output Power (Unit: dBm)

<WCDMA Conducted Power>

1. The following tests were conducted according to the test requirements outlines in 3GPP TS 34.121 specification.
2. The procedures in KDB 941225 D01v03r01 are applied for 3GPP Rel. 6 HSPA to configure the device in the required sub-test mode(s) to determine SAR test exclusion.
3. For DC-HSDPA, the device was configured according to the H-Set 12, Fixed Reference Channel (FRC) configuration in Table C.8.1.12 of 3GPP TS 34.121-1, with the primary and the secondary serving HS-DSCH Cell enabled during the power measurement.

A summary of these settings are illustrated below:

HSDPA Setup Configuration:

- a. The EUT was connected to Base Station Agilent E5515C referred to the Setup Configuration.
- b. The RF path losses were compensated into the measurements.
- c. A call was established between EUT and Base Station with following setting:
 - i. Set Gain Factors (β_c and β_d) and parameters were set according to each
 - ii. Specific sub-test in the following table, C10.1.4, quoted from the TS 34.121
 - iii. Set RMC 12.2Kbps + HSDPA mode.
 - iv. Set Cell Power = -86 dBm
 - v. Set HS-DSCH Configuration Type to FRC (H-set 1, QPSK)
 - vi. Select HSDPA Uplink Parameters
 - vii. Set Delta ACK, Delta NACK and Delta CQI = 8
 - viii. Set Ack-Nack Repetition Factor to 3
 - ix. Set CQI Feedback Cycle (k) to 4 ms
 - x. Set CQI Repetition Factor to 2
 - xi. Power Ctrl Mode = All Up bits
- d. The transmitted maximum output power was recorded.

Table C.10.1.4: β values for transmitter characteristics tests with HS-DPCCH

Sub-test	β_c	β_d	β_d (SF)	β_c/β_d	β_{HS} (Note 1, Note 2)	CM (dB) (Note 3)	MPR (dB) (Note 3)
1	2/15	15/15	64	2/15	4/15	0.0	0.0
2	12/15 (Note 4)	15/15 (Note 4)	64	12/15 (Note 4)	24/15	1.0	0.0
3	15/15	8/15	64	15/8	30/15	1.5	0.5
4	15/15	4/15	64	15/4	30/15	1.5	0.5

Note 1: Δ_{ACK} , Δ_{NACK} and $\Delta_{CQI} = 30/15$ with $\beta_{HS} = 30/15 * \beta_c$.

Note 2: For the HS-DPCCH power mask requirement test in clause 5.2C, 5.7A, and the Error Vector Magnitude (EVM) with HS-DPCCH test in clause 5.13.1A, and HSDPA EVM with phase discontinuity in clause 5.13.1AA, Δ_{ACK} and $\Delta_{NACK} = 30/15$ with $\beta_{HS} = 30/15 * \beta_c$, and $\Delta_{CQI} = 24/15$ with $\beta_{HS} = 24/15 * \beta_c$.

Note 3: CM = 1 for $\beta_c/\beta_d = 12/15$, $\beta_{HS}/\beta_c = 24/15$. For all other combinations of DPCCH, DPCCCH and HS-DPCCH the MPR is based on the relative CM difference. This is applicable for only UEs that support HSDPA in release 6 and later releases.

Note 4: For subtest 2 the β_c/β_d ratio of 12/15 for the TFC during the measurement period (TF1, TF0) is achieved by setting the signalled gain factors for the reference TFC (TF1, TF1) to $\beta_c = 11/15$ and $\beta_d = 15/15$.

Setup Configuration

HSUPA Setup Configuration:

- a. The EUT was connected to Base Station Agilent E5515C referred to the Setup Configuration.
- b. The RF path losses were compensated into the measurements.
- c. A call was established between EUT and Base Station with following setting * :
 - i. Call Configs = 5.2B, 5.9B, 5.10B, and 5.13.2B with QPSK
 - ii. Set the Gain Factors (β_c and β_d) and parameters (AG Index) were set according to each specific sub-test in the following table, C11.1.3, quoted from the TS 34.121
 - iii. Set Cell Power = -86 dBm
 - iv. Set Channel Type = 12.2k + HSPA
 - v. Set UE Target Power
 - vi. Power Ctrl Mode= Alternating bits
 - vii. Set and observe the E-TFCl
 - viii. Confirm that E-TFCl is equal to the target E-TFCl of 75 for sub-test 1, and other subtest's E-TFCl
- d. The transmitted maximum output power was recorded.

Table C.11.1.3: β values for transmitter characteristics tests with HS-DPCCH and E-DCH

Sub-test	β_c	β_d	β_d (SF)	β_c/β_d	β_{HS} (Note 1)	β_{ec}	β_{ed} (Note 5) (Note 6)	β_{ed} (SF)	β_{ed} (Codes)	CM (dB) (Note 2)	MPR (dB) (Note 2)	AG Index (Note 6)	E-TFCl
1	11/15 (Note 3)	15/15 (Note 3)	64	11/15 (Note 3)	22/15	209/225	1309/225	4	1	1.0	0.0	20	75
2	6/15	15/15	64	6/15	12/15	12/15	94/75	4	1	3.0	2.0	12	67
3	15/15	9/15	64	15/9	30/15	30/15	β_{ed1} : 47/15 β_{ed2} : 47/15	4 4	2	2.0	1.0	15	92
4	2/15	15/15	64	2/15	4/15	2/15	56/75	4	1	3.0	2.0	17	71
5	15/15 (Note 4)	15/15 (Note 4)	64	15/15 (Note 4)	30/15	24/15	134/15	4	1	1.0	0.0	21	81

Note 1: $\Delta_{ACK}, \Delta_{NACK}$ and $\Delta_{CQI} = 30/15$ with $\beta_{hs} = 30/15 * \beta_c$.

Note 2: CM = 1 for $\beta_c/\beta_d = 12/15, \beta_{hs}/\beta_c = 24/15$. For all other combinations of DPDCH, DPCCH, HS-DPCCH, E-DPDCH and E-DPCCH the MPR is based on the relative CM difference.

Note 3: For subtest 1 the β_c/β_d ratio of 11/15 for the TFC during the measurement period (TF1, TF0) is achieved by setting the signalled gain factors for the reference TFC (TF1, TF1) to $\beta_c = 10/15$ and $\beta_d = 15/15$.

Note 4: For subtest 5 the β_c/β_d ratio of 15/15 for the TFC during the measurement period (TF1, TF0) is achieved by setting the signalled gain factors for the reference TFC (TF1, TF1) to $\beta_c = 14/15$ and $\beta_d = 15/15$.

Note 5: In case of testing by UE using E-DPDCH Physical Layer category 1, Sub-test 3 is omitted according to TS25.306 Table 5.1g.

Note 6: β_{ed} can not be set directly, it is set by Absolute Grant Value.

Setup Configuration

DC-HSDPA 3GPP release 8 Setup Configuration:

- a. The EUT was connected to Base Station Agilent E5515C referred to the Setup Configuration below
- b. The RF path losses were compensated into the measurements.
- c. A call was established between EUT and Base Station with following setting:
 - i. Set RMC 12.2Kbps + HSDPA mode.
 - ii. Set Cell Power = -25 dBm
 - iii. Set HS-DSCH Configuration Type to FRC (H-set 12, QPSK)
 - iv. Select HSDPA Uplink Parameters
 - v. Set Gain Factors (β_c and β_d) and parameters were set according to each Specific sub-test in the following table, C10.1.4, quoted from the TS 34.121
 - a). Subtest 1: $\beta_c/\beta_d=2/15$
 - b). Subtest 2: $\beta_c/\beta_d=12/15$
 - c). Subtest 3: $\beta_c/\beta_d=15/8$
 - d). Subtest 4: $\beta_c/\beta_d=15/4$
 - vi. Set Delta ACK, Delta NACK and Delta CQI = 8
 - vii. Set Ack-Nack Repetition Factor to 3
 - viii. Set CQI Feedback Cycle (k) to 4 ms
 - ix. Set CQI Repetition Factor to 2
 - x. Power Ctrl Mode = All Up bits
- d. The transmitted maximum output power was recorded.

The following tests were conducted according to the test requirements outlines in 3GPP TS 34.121 specification. A summary of these settings are illustrated below:

C.8.1.12 Fixed Reference Channel Definition H-Set 12

Table C.8.1.12: Fixed Reference Channel H-Set 12

Parameter	Unit	Value
Nominal Avg. Inf. Bit Rate	kbps	60
Inter-TTI Distance	TTI's	1
Number of HARQ Processes	Processes	6
Information Bit Payload (N_{INF})	Bits	120
Number Code Blocks	Blocks	1
Binary Channel Bits Per TTI	Bits	960
Total Available SML's in UE	SML's	19200
Number of SML's per HARQ Proc.	SML's	3200
Coding Rate		0.15
Number of Physical Channel Codes	Codes	1
Modulation		QPSK
Note 1: The RMC is intended to be used for DC-HSDPA mode and both cells shall transmit with identical parameters as listed in the table. Note 2: Maximum number of transmission is limited to 1, i.e., retransmission is not allowed. The redundancy and constellation version 0 shall be used.		

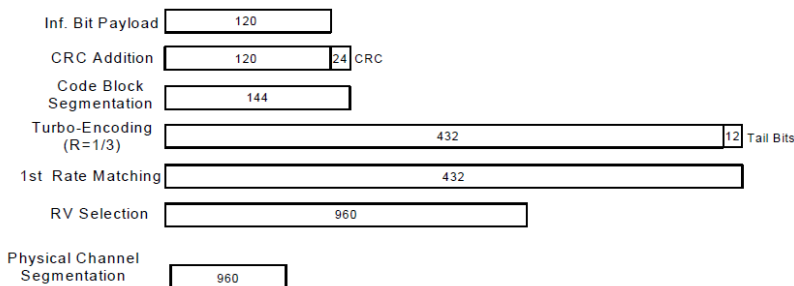

Figure C.8.19: Coding rate for Fixed reference Channel H-Set 12 (QPSK)

Setup Configuration



<WCDMA Conducted Power>

General Note:

1. Per KDB 941225 D01v03r01, for SAR testing is measured using a 12.2 kbps RMC with TPC bits configured to all "1's".
2. Per KDB 941225 D01v03r01, RMC 12.2kbps setting is used to evaluate SAR. The maximum output power and tune-up tolerance specified for production units in HSDPA / HSUPA / DC-HSDPA is ≤ ¼ dB higher than RMC 12.2Kbps or when the highest reported SAR of the RMC12.2Kbps is scaled by the ratio of specified maximum output power and tune-up tolerance of HSDPA / HSUPA / DC-HSDPA to RMC12.2Kbps and the adjusted SAR is ≤ 1.2 W/kg, SAR measurement is not required for HSDPA / HSUPA / DC-HSDPA, and according to the following RF output power, the output power results of the secondary modes (HSUPA, HSDPA, DC-HSDPA) are less than ¼ dB higher than the primary modes; therefore, SAR measurement is not required for HSDPA / HSUPA / DC-HSDPA.

Band		WCDMA IV			Tune-up Limit (dBm)
TX Channel		1312	1413	1513	
Rx Channel		1537	1638	1738	
Frequency (MHz)		1712.4	1732.6	1752.6	
3GPP Rel 99	AMR 12.2Kbps	23.76	23.77	23.70	24.00
3GPP Rel 99	RMC 12.2Kbps	23.86	23.76	23.88	24.00
3GPP Rel 6	HSDPA Subtest-1	22.85	22.78	22.81	23.00
3GPP Rel 6	HSDPA Subtest-2	22.78	22.82	22.90	23.00
3GPP Rel 6	HSDPA Subtest-3	22.13	22.31	22.32	22.50
3GPP Rel 6	HSDPA Subtest-4	22.26	22.32	22.22	22.50
3GPP Rel 8	DC-HSDPA Subtest-1	22.70	22.73	22.72	23.00
3GPP Rel 8	DC-HSDPA Subtest-2	22.58	22.64	22.83	23.00
3GPP Rel 8	DC-HSDPA Subtest-3	22.07	22.14	22.31	22.50
3GPP Rel 8	DC-HSDPA Subtest-4	22.21	22.27	22.22	22.50
3GPP Rel 6	HSUPA Subtest-1	22.63	22.59	22.70	23.00
3GPP Rel 6	HSUPA Subtest-2	20.63	20.60	20.68	21.00
3GPP Rel 6	HSUPA Subtest-3	21.60	21.63	21.72	22.00
3GPP Rel 6	HSUPA Subtest-4	20.64	20.61	20.71	21.00
3GPP Rel 6	HSUPA Subtest-5	22.64	22.80	22.53	23.00

13. ANT+ Exclusions Applied

Mode Band	Average power(dBm)
	GFSK
ANT+	-4

Note:

- Per KDB 447498 D01v06, the 1-g and 10-g SAR test exclusion thresholds for 100 MHz to 6 GHz at *test separation distances* ≤ 50 mm are determined by:

$$[(\text{max. power of channel, including tune-up tolerance, mW}) / (\text{min. test separation distance, mm})] \cdot [\sqrt{f(\text{GHz})}] \leq 3.0$$
 for 1-g SAR and ≤ 7.5 for 10-g Product Specific SAR
 - f(GHz) is the RF channel transmit frequency in GHz
 - Power and distance are rounded to the nearest mW and mm before calculation
 - The result is rounded to one decimal place for comparison

ANT+ Max Power (dBm)	Separation Distance (mm)	Frequency (GHz)	exclusion thresholds
-4	15	2.48	0

Note:

Per KDB 447498 D01v06, when the minimum test separation distance is 15 mm which is applied to determine SAR test exclusion. The test exclusion threshold is 0 which is ≤ 3, SAR testing is not required.

14. Antenna Location

<Mobile Phone>

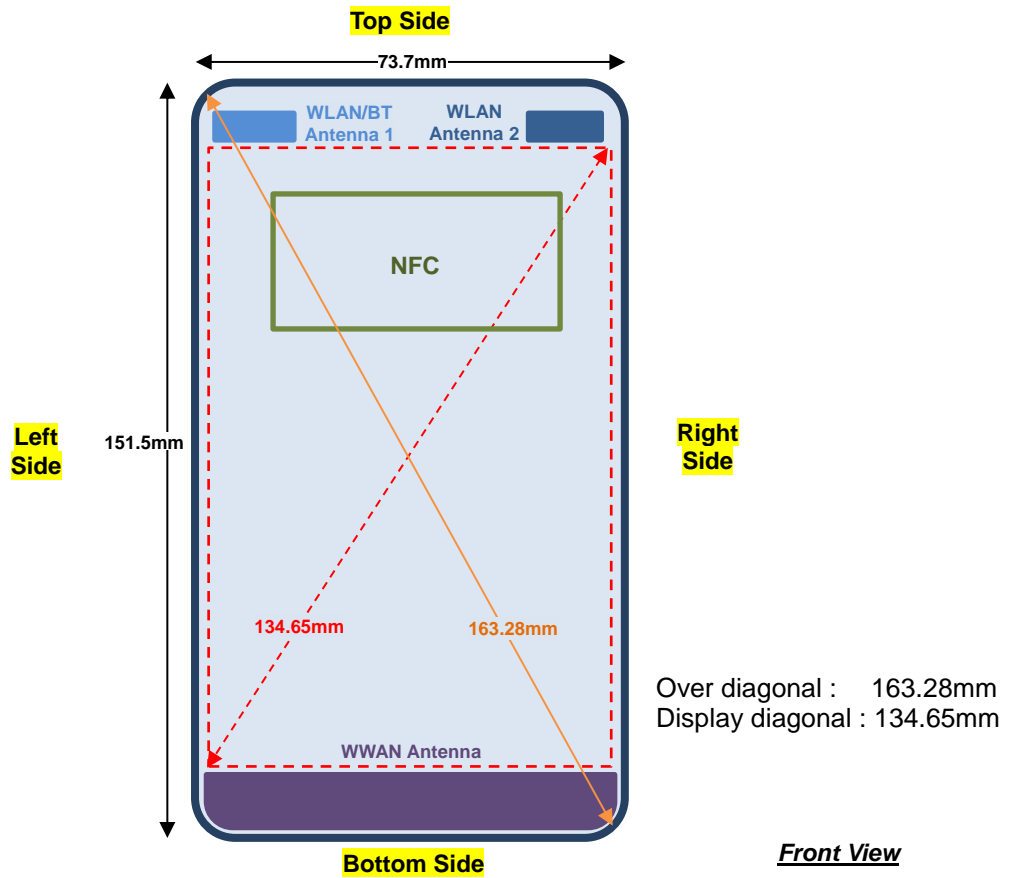

Distance of the Antenna to the EUT surface/edge						
Antennas	Back	Front	Top Side	Bottom Side	Right Side	Left Side
WWAN Antenna	≤ 25mm	≤ 25mm	>25 mm	≤ 25mm	≤ 25mm	≤ 25mm
BT&WLAN Antenna 1	≤ 25mm	≤ 25mm	≤ 25mm	>25 mm	>25 mm	≤ 25mm
WLAN Antenna 2	≤ 25mm	≤ 25mm	≤ 25mm	>25 mm	≤ 25mm	>25 mm

Positions for SAR tests; Hotspot mode						
Antennas	Back	Front	Top Side	Bottom Side	Right Side	Left Side
WWAN Antenna	Yes	Yes	No	Yes	Yes	Yes
BT&WLAN Antenna 1	Yes	Yes	Yes	No	No	Yes
WLAN Antenna 2	Yes	Yes	Yes	No	Yes	No

General Note:

- Referring to KDB 941225 D06 v02r01, when the overall device length and width are ≥ 9cm*5cm, the test distance is 10 mm. SAR must be measured for all sides and surfaces with a transmitting antenna located within 25mm from that surface or edge



15. SAR Test Results

General Note:

1. Per KDB 447498 D01v06, the reported SAR is the measured SAR value adjusted for maximum tune-up tolerance.
 - a. Tune-up scaling Factor = tune-up limit power (mW) / EUT RF power (mW), where tune-up limit is the maximum rated power among all production units.
 - b. For WWAN: Reported SAR(W/kg)= Measured SAR(W/kg)*Tune-up Scaling Factor
2. Per KDB 447498 D01v06, for each exposure position, testing of other required channels within the operating mode of a frequency band is not required when the *reported* 1-g or 10-g SAR for the mid-band or highest output power channel is:
 - ≤ 0.8 W/kg or 2.0 W/kg, for 1-g or 10-g respectively, when the transmission band is ≤ 100 MHz
 - ≤ 0.6 W/kg or 1.5 W/kg, for 1-g or 10-g respectively, when the transmission band is between 100 MHz and 200 MHz
 - ≤ 0.4 W/kg or 1.0 W/kg, for 1-g or 10-g respectively, when the transmission band is ≥ 200 MHz
3. Per KDB 865664 D01v01r04, for each frequency band, repeated SAR measurement is required only when the measured SAR is ≥ 0.8 W/kg.
4. Per KDB 648474 D04v01r03, when the reported SAR for a body-worn accessory measured without a headset connected to the handset is ≤ 1.2 W/kg, SAR testing with a headset connected to the handset is not required.

UMTS Note:

1. Per KDB 941225 D01v03r01, for SAR testing is measured using a 12.2 kbps RMC with TPC bits configured to all "1's".
2. Per KDB 941225 D01v03r01, RMC 12.2kbps setting is used to evaluate SAR. The maximum output power and tune-up tolerance specified for production units in HSDPA / HSUPA / DC-HSDPA is $\leq 1/4$ dB higher than RMC 12.2Kbps or when the highest reported SAR of the RMC12.2Kbps is scaled by the ratio of specified maximum output power and tune-up tolerance of HSDPA / HSUPA / DC-HSDPA to RMC12.2Kbps and the adjusted SAR is ≤ 1.2 W/kg, SAR measurement is not required for HSDPA / HSUPA / DC-HSDPA, and according to the following RF output power, the output power results of the secondary modes (HSUPA, HSDPA, DC-HSDPA) are less than $1/4$ dB higher than the primary modes; therefore, SAR measurement is not required for HSDPA / HSUPA / DC-HSDPA.



15.1 Head SAR

<WCDMA SAR>

Plot No.	Band	Mode	Test Position	Gap (mm)	Ch.	Freq. (MHz)	Average Power (dBm)	Tune-Up Limit (dBm)	Tune-up Scaling Factor	Power Drift (dB)	Measured 1g SAR (W/kg)	Reported 1g SAR (W/kg)
	WCDMA IV	RMC 12.2Kbps	Right Cheek	0mm	1513	1752.6	23.88	24.00	1.028	-0.13	0.023	0.024
	WCDMA IV	RMC 12.2Kbps	Right Tilted	0mm	1513	1752.6	23.88	24.00	1.028	0.04	0.020	0.021
01	WCDMA IV	RMC 12.2Kbps	Left Cheek	0mm	1513	1752.6	23.88	24.00	1.028	0.07	0.070	0.072
	WCDMA IV	RMC 12.2Kbps	Left Tilted	0mm	1513	1752.6	23.88	24.00	1.028	0.14	0.006	0.006

15.2 Hotspot SAR

<WCDMA SAR>

Plot No.	Band	Mode	Test Position	Gap (mm)	Ch.	Freq. (MHz)	Average Power (dBm)	Tune-Up Limit (dBm)	Tune-up Scaling Factor	Power Drift (dB)	Measured 1g SAR (W/kg)	Reported 1g SAR (W/kg)
	WCDMA IV	RMC 12.2Kbps	Front	10mm	1513	1752.6	23.88	24.00	1.028	-0.02	0.806	0.829
02	WCDMA IV	RMC 12.2Kbps	Front	10mm	1312	1712.4	23.86	24.00	1.033	0.02	0.976	1.008
	WCDMA IV	RMC 12.2Kbps	Front	10mm	1413	1732.6	23.76	24.00	1.057	0.02	0.909	0.961
	WCDMA IV	RMC 12.2Kbps	Back	10mm	1513	1752.6	23.88	24.00	1.028	-0.03	0.112	0.115
	WCDMA IV	RMC 12.2Kbps	Left Side	10mm	1513	1752.6	23.88	24.00	1.028	-0.1	0.084	0.086
	WCDMA IV	RMC 12.2Kbps	Right Side	10mm	1513	1752.6	23.88	24.00	1.028	0	0.001	0.001
	WCDMA IV	RMC 12.2Kbps	Bottom Side	10mm	1513	1752.6	23.88	24.00	1.028	-0.05	0.834	0.857
	WCDMA IV	RMC 12.2Kbps	Bottom Side	10mm	1312	1712.4	23.86	24.00	1.033	-0.02	0.944	0.975
	WCDMA IV	RMC 12.2Kbps	Bottom Side	10mm	1413	1732.6	23.76	24.00	1.057	-0.09	0.918	0.970

15.3 Body Worn Accessory SAR

<WCDMA SAR>

Plot No.	Band	Mode	Test Position	Gap (mm)	Ch.	Freq. (MHz)	Average Power (dBm)	Tune-Up Limit (dBm)	Tune-up Scaling Factor	Power Drift (dB)	Measured 1g SAR (W/kg)	Reported 1g SAR (W/kg)
03	WCDMA IV	RMC 12.2Kbps	Front	15mm	1513	1752.6	23.88	24.00	1.028	-0.16	0.372	0.382
	WCDMA IV	RMC 12.2Kbps	Back	15mm	1513	1752.6	23.88	24.00	1.028	-0.04	0.033	0.034

15.4 Repeated SAR Measurement

No.	Band	Mode	Test Position	Gap (mm)	Ch.	Freq. (MHz)	Average Power (dBm)	Tune-Up Limit (dBm)	Tune-up Scaling Factor	Power Drift (dB)	Measured 1g SAR (W/kg)	Ratio	Reported 1g SAR (W/kg)
1st	WCDMA IV	RMC 12.2Kbps	Front	10mm	1312	1712.4	23.86	24.00	1.033	0.02	0.976		1.008
2nd	WCDMA IV	RMC 12.2Kbps	Front	10mm	1312	1712.4	23.86	24.00	1.033	-0.12	0.956	1.02	0.987

General Note:

- Per KDB 865664 D01v01r04, for each frequency band, repeated SAR measurement is required only when the measured SAR is ≥ 0.8 W/kg.
- Per KDB 865664 D01v01r04, if the ratio among the repeated measurement is ≤ 1.2 and the measured SAR < 1.45 W/kg, only one repeated measurement is required.
- The ratio is the difference in percentage between original and repeated *measured SAR*.
- All measurement SAR result is scaled-up to account for tune-up tolerance and is compliant.

16. Simultaneous Transmission Analysis

NO.	Simultaneous Transmission Configurations	Portable Handset			
		Head	Body-worn	Hotspot	Product Specific
1.	WWAN (Voice) + WLAN Ant 1 + WLAN Ant 2	Yes	Yes		Yes
2.	WWAN (Data) + WLAN Ant 1 + WLAN Ant 2	Yes	Yes	Yes	Yes
3.	WWAN (Voice) + Bluetooth Ant 1 + WLAN Ant 2		Yes		Yes
4.	WWAN (Data) + Bluetooth Ant 1 + WLAN Ant 2		Yes		Yes

General Note:

1. In this report, the WLAN/BT SAR results are referenced from Sporton FCC SAR Report, Report No: FA712102 as appendix D.
2. This device 2.4GHz / 5.2GHz / 5.8GHz WLAN supports Hotspot operation.
3. The Scaled SAR summation is calculated based on the same configuration and test position.
4. Per KDB 447498 D01v06, simultaneous transmission SAR is compliant if,
 - i) Scalar SAR summation < 1.6W/kg.
 - ii) $SPLSR = (SAR1 + SAR2)^{1.5} / (\text{min. separation distance, mm})$, and the peak separation distance is determined from the square root of $[(x1-x2)^2 + (y1-y2)^2 + (z1-z2)^2]$, where (x1, y1, z1) and (x2, y2, z2) are the coordinates of the extrapolated peak SAR locations in the zoom scan.
 - iii) If $SPLSR \leq 0.04$, simultaneously transmission SAR measurement is not necessary.
 - iv) Simultaneously transmission SAR measurement, and the reported multi-band SAR < 1.6W/kg.
 - v) The SPLSR calculated results please refer to section 16.5.



16.1 Head Exposure Conditions

WWAN Band	Exposure Position	1	2	3	4	5	1+2+3 Summed 1g SAR (W/kg)	1+2+5 Summed 1g SAR (W/kg)	1+3+4 Summed 1g SAR (W/kg)	1+4+5 Summed 1g SAR (W/kg)	SPLSR	Case No	
		WWAN	2.4GHz WLAN Ant 1	2.4GHz WLAN Ant 2	5GHz WLAN Ant 1	5GHz WLAN Ant 2							
		1g SAR (W/kg)	1g SAR (W/kg)	1g SAR (W/kg)	1g SAR (W/kg)	1g SAR (W/kg)							
WCDMA	WCDMA IV	Right Cheek	0.024	0.774	0.121	1.089	0.364	0.92	1.16	1.23	1.48		
		Right Tilted	0.021	0.582	0.080	0.942	0.354	0.68	0.96	1.04	1.32		
		Left Cheek	0.072	0.326	0.450	0.777	0.860	0.85	1.26	1.30	1.71	0.04	Case 1
		Left Tilted	0.006	0.259	0.279	0.544	0.667	0.54	0.93	0.83	1.22		

16.2 Hotspot Exposure Conditions

WWAN Band	Exposure Position	1	2	3	4	5	1+2+3 Summed 1g SAR (W/kg)	1+2+5 Summed 1g SAR (W/kg)	1+3+4 Summed 1g SAR (W/kg)	1+4+5 Summed 1g SAR (W/kg)	
		WWAN	2.4GHz WLAN Ant 1	2.4GHz WLAN Ant 2	5GHz WLAN Ant 1	5GHz WLAN Ant 2					
		1g SAR (W/kg)	1g SAR (W/kg)	1g SAR (W/kg)	1g SAR (W/kg)	1g SAR (W/kg)					
WCDMA	WCDMA IV	Front	1.008	0.201	0.084	0.361	0.203	1.29	1.41	1.45	1.57
		Back	0.115	0.073	0.039	0.035	0.034	0.23	0.22	0.19	0.18
		Left side	0.086	0.092		0.105		0.18	0.18	0.19	0.19
		Right side	0.001		0.034		0.038	0.04	0.04	0.04	0.04
		Top side		0.054	0.028	0.123	0.085	0.08	0.14	0.15	0.21
		Bottom side	0.975					0.98	0.98	0.98	0.98

16.3 Product Specific Exposure Conditions

Exposure Position	1	2	3	4	5	6	1+2+3 Summed 10g SAR (W/kg)	1+2+5 Summed 10g SAR (W/kg)	1+3+4 Summed 10g SAR (W/kg)	1+4+5 Summed 10g SAR (W/kg)	1+3+6 Summed 10g SAR (W/kg)	1+5+6 Summed 10g SAR (W/kg)
	WWAN	2.4GHz WLAN Ant 1	2.4GHz WLAN Ant 2	5GHz WLAN Ant 1	5GHz WLAN Ant 2	Bluetooth Ant 1						
	10g SAR (W/kg)	10g SAR (W/kg)	10g SAR (W/kg)	10g SAR (W/kg)	10g SAR (W/kg)	Estimated 10g SAR (W/kg)						
Product Specific	-	-	-	0.365	1.015	0.235	-	1.11	0.37	1.38	0.24	1.25

Remark:

- The worst case 5GHz WLAN results are taking from 5.3GHz (U-NII-2A) and 5.5GHz (U-NII-2C) perform product specific simultaneous transmission analysis.
- According to KDB 648474 D04v01r01, for WWAN / 2.4GHz WLAN hand SAR ("-") was excluded, since WWAN / 2.4GHz WLAN hotspot SAR was < 1.2W/kg.

16.4 Body-Worn Accessory Exposure Conditions

WWAN Band	Exposure Position	1	2	3	4	5	1+2+3 Summed 1g SAR (W/kg)	1+2+5 Summed 1g SAR (W/kg)	1+3+4 Summed 1g SAR (W/kg)	1+4+5 Summed 1g SAR (W/kg)	
		WWAN	2.4GHz WLAN Ant 1	2.4GHz WLAN Ant 2	5GHz WLAN Ant 1	5GHz WLAN Ant 2					
		1g SAR (W/kg)	1g SAR (W/kg)	1g SAR (W/kg)	1g SAR (W/kg)	1g SAR (W/kg)					
WCDMA	WCDMA IV	Front	0.382	0.133	0.030	0.216	0.148	0.55	0.66	0.63	0.75
		Back	0.034	0.065	0.021	0.030	0.038	0.12	0.14	0.09	0.10

WWAN Band	Exposure Position	1	3	5	6	1+3+6 Summed 1g SAR (W/kg)	1+5+6 Summed 1g SAR (W/kg)	
		WWAN	2.4GHz WLAN Ant 2	5GHz WLAN Ant 2	Bluetooth Ant 1			
		1g SAR (W/kg)	1g SAR (W/kg)	1g SAR (W/kg)	Estimated 1g SAR (W/kg)			
WCDMA	WCDMA IV	Front	0.382	0.030	0.148	0.196	0.61	0.73
		Back	0.034	0.021	0.038	0.196	0.25	0.27

16.5 SPLSR Evaluation and Analysis

General Note:

- SPLSR = $(SAR_1 + SAR_2)^{1.5} / (min. \text{ separation distance, mm})$. If $SPLSR \leq 0.04$, simultaneously transmission SAR measurement is not necessary

	Band	Position	SAR (W/kg)	Gap (cm)	SAR peak location (m)			3D distance (mm)	Summed SAR (W/kg)	SPLSR Results	Simultaneous SAR
					X	Y	Z				
Case 1	WCDMA IV	Left Cheek	0.072	0	3.28	-5.29	-0.34	59.1	0.85	0.01	Not required
	WLAN5GHz Ant 1		0.777	0	-1.92	-2.59	0.47				
	WCDMA IV	Left Cheek	0.072	0	3.28	-5.29	-0.34	78.8	0.93	0.01	Not required
	WLAN5GHz Ant 2		0.86	0	0.62	2.12	-0.21				
	WLAN5GHz Ant 1	Left Cheek	0.777	0	-1.92	-2.59	0.47	53.9	1.64	0.04	Not required
	WLAN5GHz Ant 2		0.86	0	0.62	2.12	-0.21				

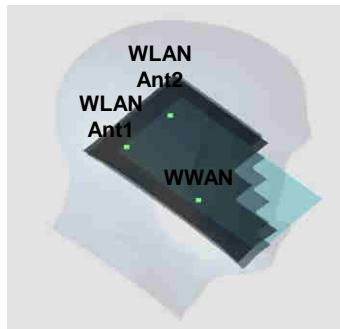

Test Engineer : Steven Chang

17. Uncertainty Assessment

The component of uncertainty may generally be categorized according to the methods used to evaluate them. The evaluation of uncertainty by the statistical analysis of a series of observations is termed a Type A evaluation of uncertainty. The evaluation of uncertainty by means other than the statistical analysis of a series of observation is termed a Type B evaluation of uncertainty. Each component of uncertainty, however evaluated, is represented by an estimated standard deviation, termed standard uncertainty, which is determined by the positive square root of the estimated variance.

A Type A evaluation of standard uncertainty may be based on any valid statistical method for treating data. This includes calculating the standard deviation of the mean of a series of independent observations; using the method of least squares to fit a curve to the data in order to estimate the parameter of the curve and their standard deviations; or carrying out an analysis of variance in order to identify and quantify random effects in certain kinds of measurement.

A type B evaluation of standard uncertainty is typically based on scientific judgment using all of the relevant information available. These may include previous measurement data, experience, and knowledge of the behavior and properties of relevant materials and instruments, manufacture’s specification, data provided in calibration reports and uncertainties assigned to reference data taken from handbooks. Broadly speaking, the uncertainty is either obtained from an outdoor source or obtained from an assumed distribution, such as the normal distribution, rectangular or triangular distributions indicated in table below.

Uncertainty Distributions	Normal	Rectangular	Triangular	U-Shape
Multi-plying Factor ^(a)	1/k ^(b)	1/√3	1/√6	1/√2

(a) standard uncertainty is determined as the product of the multiplying factor and the estimated range of variations in the measured quantity

(b) κ is the coverage factor

Table 17.1. Standard Uncertainty for Assumed Distribution

The combined standard uncertainty of the measurement result represents the estimated standard deviation of the result. It is obtained by combining the individual standard uncertainties of both Type A and Type B evaluation using the usual “root-sum-squares” (RSS) methods of combining standard deviations by taking the positive square root of the estimated variances.

Expanded uncertainty is a measure of uncertainty that defines an interval about the measurement result within which the measured value is confidently believed to lie. It is obtained by multiplying the combined standard uncertainty by a coverage factor. Typically, the coverage factor ranges from 2 to 3. Using a coverage factor allows the true value of a measured quantity to be specified with a defined probability within the specified uncertainty range. For purpose of this document, a coverage factor two is used, which corresponds to confidence interval of about 95 %. The DASY uncertainty Budget is shown in the following tables.



Error Description	Uncertainty Value (±%)	Probability	Divisor	(Ci) 1g	(Ci) 10g	Standard Uncertainty (1g) (±%)	Standard Uncertainty (10g) (±%)
Measurement System							
Probe Calibration	6.00	N	1	1	1	6.0	6.0
Axial Isotropy	4.70	R	1.732	0.7	0.7	1.9	1.9
Hemispherical Isotropy	9.60	R	1.732	0.7	0.7	3.9	3.9
Boundary Effects	1.00	R	1.732	1	1	0.6	0.6
Linearity	4.70	R	1.732	1	1	2.7	2.7
System Detection Limits	1.00	R	1.732	1	1	0.6	0.6
Modulation Response	4.68	R	1.732	1	1	2.7	2.7
Readout Electronics	0.30	N	1	1	1	0.3	0.3
Response Time	0.00	R	1.732	1	1	0.0	0.0
Integration Time	2.60	R	1.732	1	1	1.5	1.5
RF Ambient Noise	3.00	R	1.732	1	1	1.7	1.7
RF Ambient Reflections	3.00	R	1.732	1	1	1.7	1.7
Probe Positioner	0.40	R	1.732	1	1	0.2	0.2
Probe Positioning	2.90	R	1.732	1	1	1.7	1.7
Max. SAR Eval.	2.00	R	1.732	1	1	1.2	1.2
Test Sample Related							
Device Positioning	3.03	N	1	1	1	3.0	3.0
Device Holder	3.60	N	1	1	1	3.6	3.6
Power Drift	5.00	R	1.732	1	1	2.9	2.9
Power Scaling	0.00	R	1.732	1	1	0.0	0.0
Phantom and Setup							
Phantom Uncertainty	6.10	R	1.732	1	1	3.5	3.5
SAR correction	0.00	R	1.732	1	0.84	0.0	0.0
Liquid Conductivity Repeatability	0.03	N	1	0.78	0.71	0.0	0.0
Liquid Conductivity (target)	5.00	R	1.732	0.78	0.71	2.3	2.0
Liquid Conductivity (mea.)	2.50	R	1.732	0.78	0.71	1.1	1.0
Temp. unc. - Conductivity	3.68	R	1.732	0.78	0.71	1.7	1.5
Liquid Permittivity Repeatability	0.02	N	1	0.23	0.26	0.0	0.0
Liquid Permittivity (target)	5.00	R	1.732	0.23	0.26	0.7	0.8
Liquid Permittivity (mea.)	2.50	R	1.732	0.23	0.26	0.3	0.4
Temp. unc. - Permittivity	0.84	R	1.732	0.23	0.26	0.1	0.1
Combined Std. Uncertainty						11.6%	11.6%
Coverage Factor for 95 %						K=2	K=2
Expanded STD Uncertainty						23.2%	23.1%

Table 17.2. Uncertainty Budget for frequency range 300 MHz to 3 GHz



Error Description	Uncertainty Value (±%)	Probability	Divisor	(Ci) 1g	(Ci) 10g	Standard Uncertainty (1g) (±%)	Standard Uncertainty (10g) (±%)
Measurement System							
Probe Calibration	6.55	N	1	1	1	6.6	6.6
Axial Isotropy	4.70	R	1.732	0.7	0.7	1.9	1.9
Hemispherical Isotropy	9.60	R	1.732	0.7	0.7	3.9	3.9
Boundary Effects	2.00	R	1.732	1	1	1.2	1.2
Linearity	4.70	R	1.732	1	1	2.7	2.7
System Detection Limits	1.00	R	1.732	1	1	0.6	0.6
Modulation Response	4.68	R	1.732	1	1	2.7	2.7
Readout Electronics	0.30	N	1	1	1	0.3	0.3
Response Time	0.00	R	1.732	1	1	0.0	0.0
Integration Time	2.60	R	1.732	1	1	1.5	1.5
RF Ambient Noise	3.00	R	1.732	1	1	1.7	1.7
RF Ambient Reflections	3.00	R	1.732	1	1	1.7	1.7
Probe Positioner	0.40	R	1.732	1	1	0.2	0.2
Probe Positioning	6.70	R	1.732	1	1	3.9	3.9
Max. SAR Eval.	4.00	R	1.732	1	1	2.3	2.3
Test Sample Related							
Device Positioning	3.03	N	1	1	1	3.0	3.0
Device Holder	3.60	N	1	1	1	3.6	3.6
Power Drift	5.00	R	1.732	1	1	2.9	2.9
Power Scaling	0.00	R	1.732	1	1	0.0	0.0
Phantom and Setup							
Phantom Uncertainty	6.60	R	1.732	1	1	3.8	3.8
SAR correction	0.00	R	1.732	1	0.84	0.0	0.0
Liquid Conductivity Repeatability	0.03	N	1	0.78	0.71	0.0	0.0
Liquid Conductivity (target)	5.00	R	1.732	0.78	0.71	2.3	2.0
Liquid Conductivity (mea.)	2.50	R	1.732	0.78	0.71	1.1	1.0
Temp. unc. - Conductivity	3.68	R	1.732	0.78	0.71	1.7	1.5
Liquid Permittivity Repeatability	0.02	N	1	0.23	0.26	0.0	0.0
Liquid Permittivity (target)	5.00	R	1.732	0.23	0.26	0.7	0.8
Liquid Permittivity (mea.)	2.50	R	1.732	0.23	0.26	0.3	0.4
Temp. unc. - Permittivity	0.84	R	1.732	0.23	0.26	0.1	0.1
Combined Std. Uncertainty						12.7%	12.6%
Coverage Factor for 95 %						K=2	K=2
Expanded STD Uncertainty						25.4%	25.3%

Table 17.3. Uncertainty Budget for frequency range 3 GHz to 6 GHz



18. References

- [1] FCC 47 CFR Part 2 "Frequency Allocations and Radio Treaty Matters; General Rules and Regulations"
- [2] ANSI/IEEE Std. C95.1-1992, "IEEE Standard for Safety Levels with Respect to Human Exposure to Radio Frequency Electromagnetic Fields, 3 kHz to 300 GHz", September 1992
- [3] IEEE Std. 1528-2013, "IEEE Recommended Practice for Determining the Peak Spatial-Average Specific Absorption Rate (SAR) in the Human Head from Wireless Communications Devices: Measurement Techniques", Sep 2013
- [4] SPEAG DASY System Handbook
- [5] FCC KDB 248227 D01 v02r02, "SAR Guidance for IEEE 802.11 (WiFi) Transmitters", Oct 2015.
- [6] FCC KDB 447498 D01 v06, "Mobile and Portable Device RF Exposure Procedures and Equipment Authorization Policies", Oct 2015
- [7] FCC KDB 648474 D04 v01r03, "SAR Evaluation Considerations for Wireless Handsets", Oct 2015.
- [8] FCC KDB 941225 D01 v03r01, "3G SAR MEAUREMENT PROCEDURES", Oct 2015
- [9] FCC KDB 941225 D05 v02r05, "SAR Evaluation Considerations for LTE Devices", Dec 2015
- [10] FCC KDB 941225 D06 v02r01, "SAR Evaluation Procedures for Portable Devices with Wireless Router Capabilities", Oct 2015.
- [11] FCC KDB 865664 D01 v01r04, "SAR Measurement Requirements for 100 MHz to 6 GHz", Aug 2015.
- [12] FCC KDB 865664 D02 v01r02, "RF Exposure Compliance Reporting and Documentation Considerations" Oct 2015.



Appendix A. Plots of System Performance Check

The plots are shown as follows.

System Check_Head_1750MHz

DUT: D1750V2-1068

Communication System: CW; Frequency: 1750 MHz; Duty Cycle: 1:1
Medium: HSL_1750_170904 Medium parameters used: $f = 1750$ MHz; $\sigma = 1.379$ S/m; $\epsilon_r = 38.785$;
 $\rho = 1000$ kg/m³
Ambient Temperature : 23.6 °C ; Liquid Temperature : 22.6 °C

DASY5 Configuration:

- Probe: EX3DV4 - SN7306; ConvF(8.64, 8.64, 8.64); Calibrated: 2017/7/24;
- Sensor-Surface: 1.4mm (Mechanical Surface Detection)
- Electronics: DAE4 Sn854; Calibrated: 2017/5/2
- Phantom: SAM_Left; Type: QD000P40CD; Serial: TP:1431
- Measurement SW: DASY52, Version 52.8 (8); SEMCAD X Version 14.6.10 (7373)

Pin=250mW/Area Scan (61x61x1): Interpolated grid: dx=1.500 mm, dy=1.500 mm
Maximum value of SAR (interpolated) = 13.4 W/kg

Pin=250mW/Zoom Scan (5x5x7)/Cube 0: Measurement grid: dx=8mm, dy=8mm, dz=5mm
Reference Value = 74.43 V/m; Power Drift = 0.19 dB
Peak SAR (extrapolated) = 15.6 W/kg
SAR(1 g) = 8.72 W/kg; SAR(10 g) = 4.66 W/kg
Maximum value of SAR (measured) = 13.3 W/kg

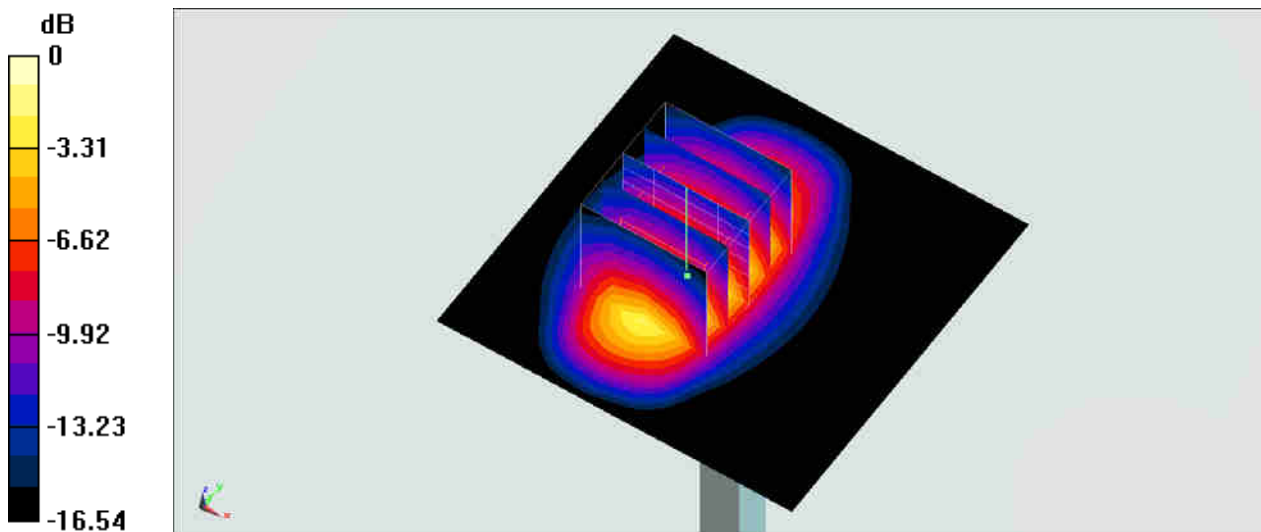

0 dB = 13.3 W/kg = 11.24 dBW/kg

System Check_Body_1750MHz

DUT: D1750V2-1068

Communication System: CW ; Frequency: 1750 MHz;Duty Cycle: 1:1

Medium: MSL_1750_170904 Medium parameters used: $f = 1750$ MHz; $\sigma = 1.45$ S/m; $\epsilon_r = 55.244$; $\rho = 1000$ kg/m³

Ambient Temperature : 23.6 °C ; Liquid Temperature : 22.6 °C

DASY5 Configuration:

- Probe: EX3DV4 - SN7306; ConvF(8.29, 8.29, 8.29); Calibrated: 2017/7/24;
- Sensor-Surface: 1.4mm (Mechanical Surface Detection)
- Electronics: DAE4 Sn854; Calibrated: 2017/5/2
- Phantom: SAM_Left; Type: QD000P40CD; Serial: TP:1431
- Measurement SW: DASY52, Version 52.8 (8);SEMCAD X Version 14.6.10 (7373)

Pin=250mW/Area Scan (61x61x1): Interpolated grid: dx=1.500 mm, dy=1.500 mm

Maximum value of SAR (interpolated) = 13.9 W/kg

Pin=250mW/Zoom Scan (5x5x7)/Cube 0: Measurement grid: dx=8mm, dy=8mm, dz=5mm

Reference Value = 96.89 V/m; Power Drift = -0.02 dB

Peak SAR (extrapolated) = 14.5 W/kg

SAR(1 g) = 8.49 W/kg; SAR(10 g) = 4.65 W/kg

Maximum value of SAR (measured) = 12.3 W/kg

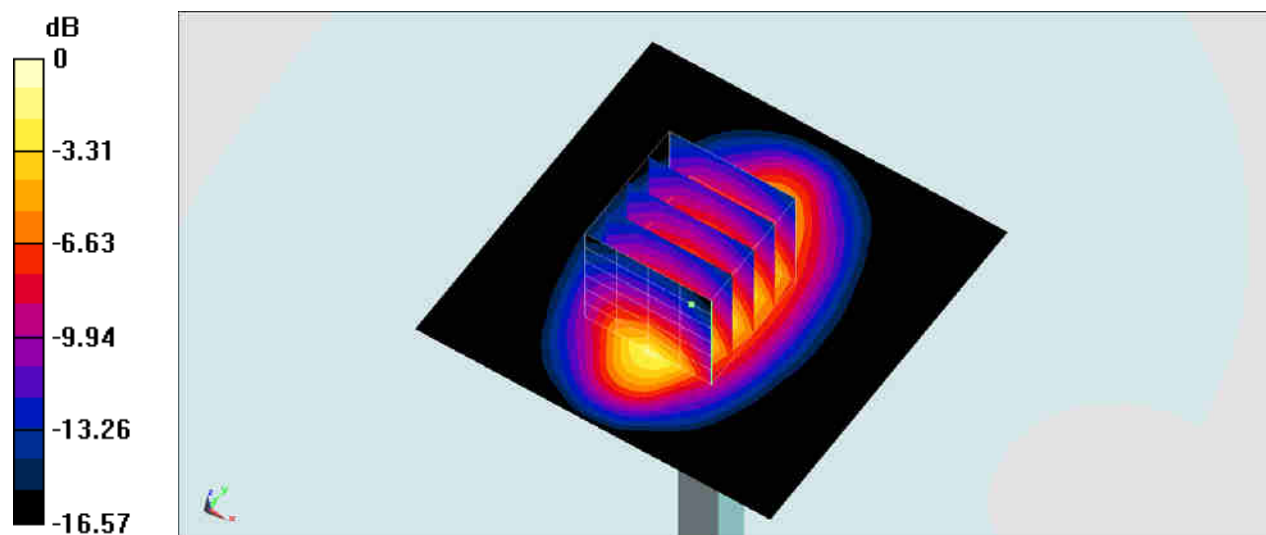

0 dB = 12.3 W/kg = 10.90 dBW/kg



Appendix B. Plots of SAR Measurement

The plots are shown as follows.

#01_WCDMA IV_RMC 12.2Kbps_Left Cheek_Ch1513

Communication System: WCDMA; Frequency: 1752.6 MHz; Duty Cycle: 1:1
 Medium: HSL_1750_170904 Medium parameters used: $f = 1753 \text{ MHz}$; $\sigma = 1.381 \text{ S/m}$; $\epsilon_r = 38.777$;
 $\rho = 1000 \text{ kg/m}^3$
 Ambient Temperature : $23.6 \text{ }^\circ\text{C}$; Liquid Temperature : $22.6 \text{ }^\circ\text{C}$

DASY5 Configuration:

- Probe: EX3DV4 - SN7306; ConvF(8.64, 8.64, 8.64); Calibrated: 2017/7/24;
- Sensor-Surface: 1.4mm (Mechanical Surface Detection)
- Electronics: DAE4 Sn854; Calibrated: 2017/5/2
- Phantom: SAM_Left; Type: QD000P40CD; Serial: TP:1431
- Measurement SW: DASY52, Version 52.8 (8); SEMCAD X Version 14.6.10 (7373)

Area Scan (71x121x1): Interpolated grid: $dx=1.500 \text{ mm}$, $dy=1.500 \text{ mm}$
 Maximum value of SAR (interpolated) = 0.138 W/kg

Zoom Scan (5x5x7)/Cube 0: Measurement grid: $dx=8\text{mm}$, $dy=8\text{mm}$, $dz=5\text{mm}$
 Reference Value = 8.422 V/m ; Power Drift = 0.07 dB
 Peak SAR (extrapolated) = 0.108 W/kg
SAR(1 g) = 0.070 W/kg ; SAR(10 g) = 0.037 W/kg
 Maximum value of SAR (measured) = 0.0947 W/kg

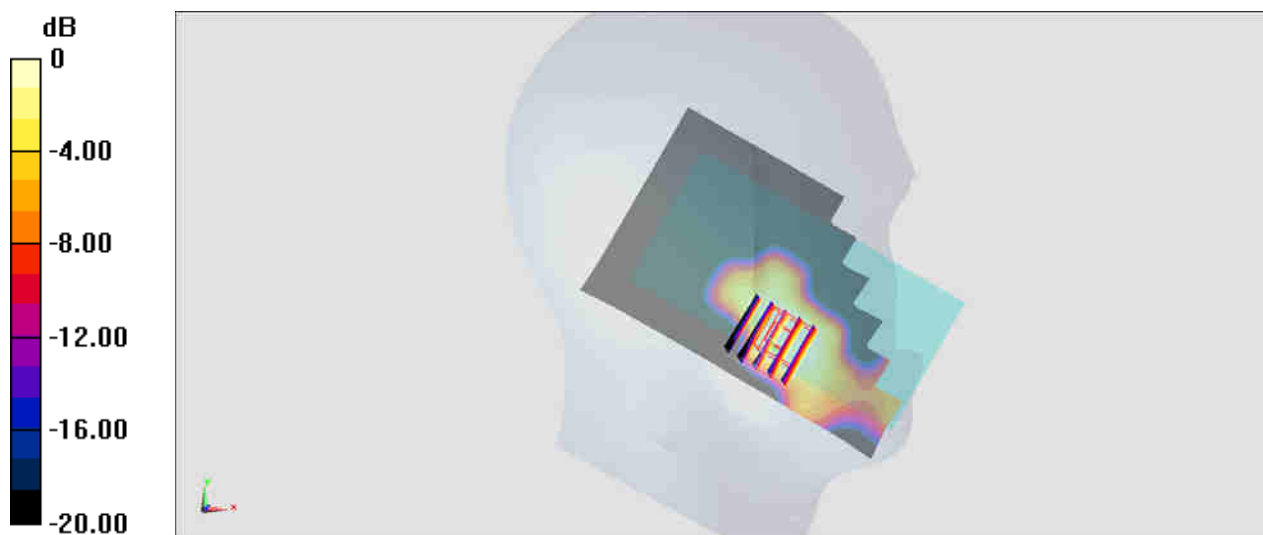

$0 \text{ dB} = 0.0947 \text{ W/kg} = -10.24 \text{ dBW/kg}$

#02_WCDMA IV_RMC 12.2Kbps_Front_10mm_Ch1312

Communication System: WCDMA ; Frequency: 1712.4 MHz;Duty Cycle: 1:1
Medium: MSL_1750_170904 Medium parameters used : $f = 1712.4$ MHz; $\sigma = 1.407$ S/m; $\epsilon_r = 55.391$; $\rho = 1000$ kg/m³
Ambient Temperature : 23.6 °C ; Liquid Temperature : 22.6 °C

DASY5 Configuration:

- Probe: EX3DV4 - SN7306; ConvF(8.29, 8.29, 8.29); Calibrated: 2017/7/24;
- Sensor-Surface: 1.4mm (Mechanical Surface Detection)
- Electronics: DAE4 Sn854; Calibrated: 2017/5/2
- Phantom: SAM_Left; Type: QD000P40CD; Serial: TP:1431
- Measurement SW: DASY52, Version 52.8 (8);SEMCAD X Version 14.6.10 (7373)

Area Scan (71x121x1): Interpolated grid: dx=1.500 mm, dy=1.500 mm
Maximum value of SAR (interpolated) = 1.38 W/kg

Zoom Scan (5x5x7)/Cube 0: Measurement grid: dx=8mm, dy=8mm, dz=5mm
Reference Value = 18.14 V/m; Power Drift = 0.02 dB
Peak SAR (extrapolated) = 1.77 W/kg
SAR(1 g) = 0.976 W/kg; SAR(10 g) = 0.498 W/kg
Maximum value of SAR (measured) = 1.47 W/kg

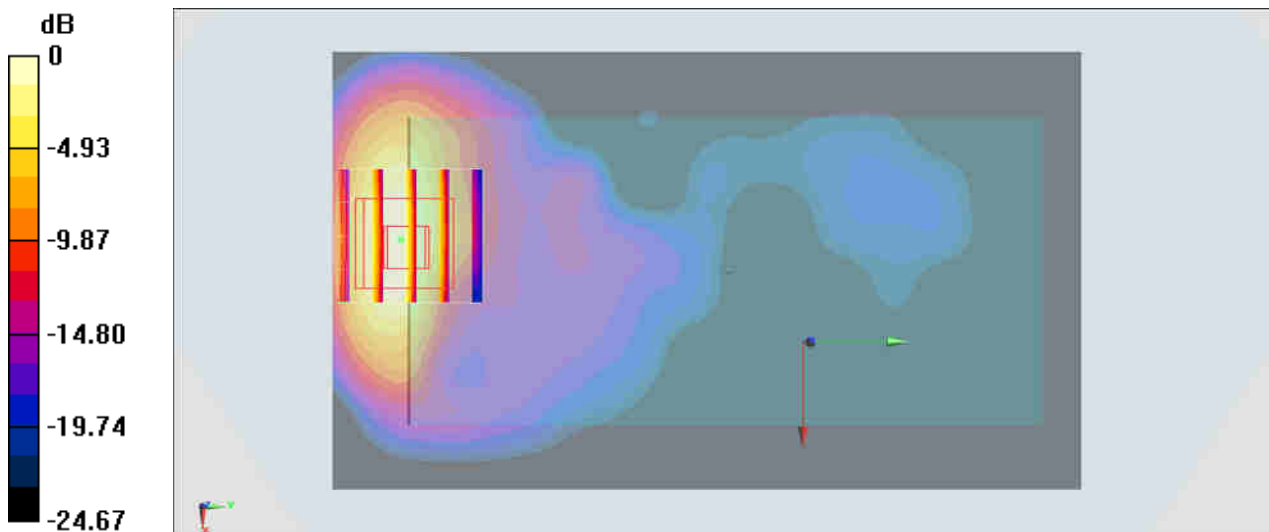

0 dB = 1.47 W/kg = 1.67 dBW/kg

#03_WCDMA IV_RMC 12.2Kbps_Front_15mm_Ch1513

Communication System: WCDMA ; Frequency: 1752.6 MHz;Duty Cycle: 1:1
Medium: MSL_1750_170904 Medium parameters used: $f = 1753$ MHz; $\sigma = 1.453$ S/m; $\epsilon_r = 55.233$;
 $\rho = 1000$ kg/m³
Ambient Temperature : 23.6 °C ; Liquid Temperature : 22.6 °C

DASY5 Configuration:

- Probe: EX3DV4 - SN7306; ConvF(8.29, 8.29, 8.29); Calibrated: 2017/7/24;
- Sensor-Surface: 1.4mm (Mechanical Surface Detection)
- Electronics: DAE4 Sn854; Calibrated: 2017/5/2
- Phantom: SAM_Left; Type: QD000P40CD; Serial: TP:1431
- Measurement SW: DASY52, Version 52.8 (8);SEMCAD X Version 14.6.10 (7373)

Area Scan (71x121x1): Interpolated grid: dx=1.500 mm, dy=1.500 mm
Maximum value of SAR (interpolated) = 0.559 W/kg

Zoom Scan (5x5x7)/Cube 0: Measurement grid: dx=8mm, dy=8mm, dz=5mm
Reference Value = 14.61 V/m; Power Drift = -0.16 dB
Peak SAR (extrapolated) = 0.635 W/kg
SAR(1 g) = 0.372 W/kg; SAR(10 g) = 0.201 W/kg
Maximum value of SAR (measured) = 0.531 W/kg

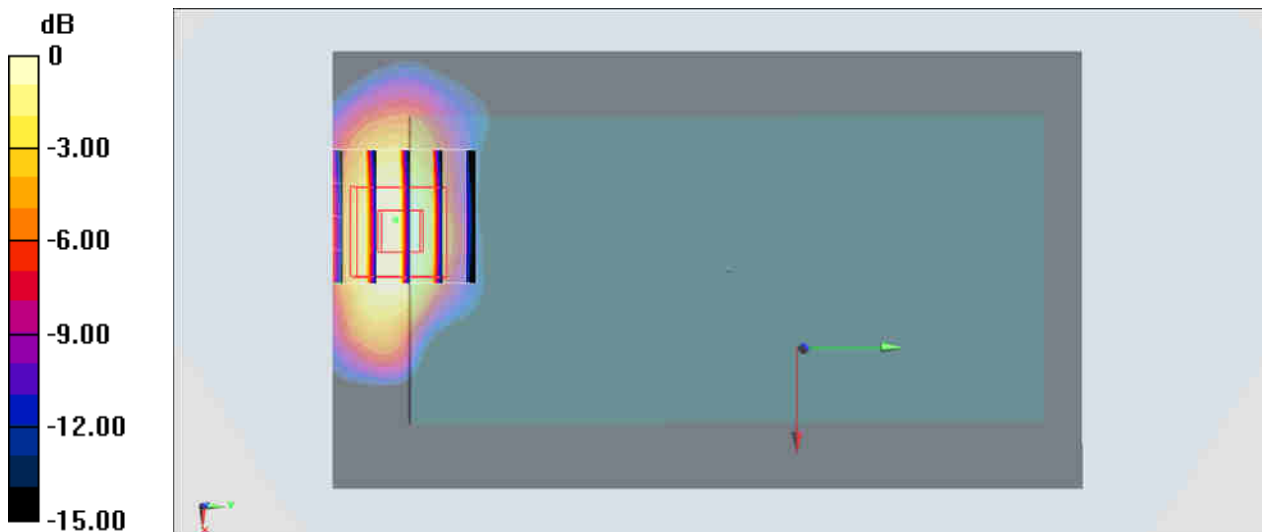

0 dB = 0.531 W/kg = -2.75 dBW/kg



Appendix C. DAS Y Calibration Certificate

The DAS Y calibration certificates are shown as follows.



Accredited by the Swiss Accreditation Service (SAS)
The Swiss Accreditation Service is one of the signatories to the EA
Multilateral Agreement for the recognition of calibration certificates

Accreditation No.: **SCS 0108**

Client **Sporton-TW (Auden)**

Certificate No: **D1750V2-1068_Nov16**

CALIBRATION CERTIFICATE

Object **D1750V2 - SN:1068**

Calibration procedure(s) **QA CAL-05.v9
Calibration procedure for dipole validation kits above 700 MHz**

Calibration date: **November 16, 2016**

This calibration certificate documents the traceability to national standards, which realize the physical units of measurements (SI).
The measurements and the uncertainties with confidence probability are given on the following pages and are part of the certificate.

All calibrations have been conducted in the closed laboratory facility: environment temperature (22 ± 3)°C and humidity < 70%.

Calibration Equipment used (M&TE critical for calibration)

Primary Standards	ID #	Cal Date (Certificate No.)	Scheduled Calibration
Power meter NRP	SN: 104778	06-Apr-16 (No. 217-02288/02289)	Apr-17
Power sensor NRP-Z91	SN: 103244	06-Apr-16 (No. 217-02288)	Apr-17
Power sensor NRP-Z91	SN: 103245	06-Apr-16 (No. 217-02289)	Apr-17
Reference 20 dB Attenuator	SN: 5058 (20k)	05-Apr-16 (No. 217-02292)	Apr-17
Type-N mismatch combination	SN: 5047.2 / 06327	05-Apr-16 (No. 217-02295)	Apr-17
Reference Probe EX3DV4	SN: 7349	15-Jun-16 (No. EX3-7349_Jun16)	Jun-17
DAE4	SN: 601	30-Dec-15 (No. DAE4-601_Dec15)	Dec-16

Secondary Standards	ID #	Check Date (in house)	Scheduled Check
Power meter EPM-442A	SN: GB37480704	07-Oct-15 (in house check Oct-16)	In house check: Oct-18
Power sensor HP 8481A	SN: US37292783	07-Oct-15 (in house check Oct-16)	In house check: Oct-18
Power sensor HP 8481A	SN: MY41092317	07-Oct-15 (in house check Oct-16)	In house check: Oct-18
RF generator R&S SMT-06	SN: 100972	15-Jun-15 (in house check Oct-16)	In house check: Oct-18
Network Analyzer HP 8753E	SN: US37390585	18-Oct-01 (in house check Oct-16)	In house check: Oct-17

Calibrated by: **Claudio Leubler** Name: Claudio Leubler Function: Laboratory Technician

Approved by: **Katja Pokovic** Name: Katja Pokovic Function: Technical Manager

Signature

Issued: November 17, 2016

This calibration certificate shall not be reproduced except in full without written approval of the laboratory.



Accredited by the Swiss Accreditation Service (SAS)

Accreditation No.: **SCS 0108**

The Swiss Accreditation Service is one of the signatories to the EA Multilateral Agreement for the recognition of calibration certificates

Glossary:

TSL	tissue simulating liquid
ConvF	sensitivity in TSL / NORM x,y,z
N/A	not applicable or not measured

Calibration is Performed According to the Following Standards:

- a) IEEE Std 1528-2013, "IEEE Recommended Practice for Determining the Peak Spatial-Averaged Specific Absorption Rate (SAR) in the Human Head from Wireless Communications Devices: Measurement Techniques", June 2013
- b) IEC 62209-1, "Procedure to measure the Specific Absorption Rate (SAR) for hand-held devices used in close proximity to the ear (frequency range of 300 MHz to 3 GHz)", February 2005
- c) IEC 62209-2, "Procedure to determine the Specific Absorption Rate (SAR) for wireless communication devices used in close proximity to the human body (frequency range of 30 MHz to 6 GHz)", March 2010
- d) KDB 865664, "SAR Measurement Requirements for 100 MHz to 6 GHz"

Additional Documentation:

- e) DASY4/5 System Handbook

Methods Applied and Interpretation of Parameters:

- *Measurement Conditions:* Further details are available from the Validation Report at the end of the certificate. All figures stated in the certificate are valid at the frequency indicated.
- *Antenna Parameters with TSL:* The dipole is mounted with the spacer to position its feed point exactly below the center marking of the flat phantom section, with the arms oriented parallel to the body axis.
- *Feed Point Impedance and Return Loss:* These parameters are measured with the dipole positioned under the liquid filled phantom. The impedance stated is transformed from the measurement at the SMA connector to the feed point. The Return Loss ensures low reflected power. No uncertainty required.
- *Electrical Delay:* One-way delay between the SMA connector and the antenna feed point. No uncertainty required.
- *SAR measured:* SAR measured at the stated antenna input power.
- *SAR normalized:* SAR as measured, normalized to an input power of 1 W at the antenna connector.
- *SAR for nominal TSL parameters:* The measured TSL parameters are used to calculate the nominal SAR result.

The reported uncertainty of measurement is stated as the standard uncertainty of measurement multiplied by the coverage factor $k=2$, which for a normal distribution corresponds to a coverage probability of approximately 95%.

Measurement Conditions

DASY system configuration, as far as not given on page 1.

DASY Version	DASY5	V52.8.8
Extrapolation	Advanced Extrapolation	
Phantom	Modular Flat Phantom	
Distance Dipole Center - TSL	10 mm	with Spacer
Zoom Scan Resolution	dx, dy, dz = 5 mm	
Frequency	1750 MHz \pm 1 MHz	

Head TSL parameters

The following parameters and calculations were applied.

	Temperature	Permittivity	Conductivity
Nominal Head TSL parameters	22.0 °C	40.1	1.37 mho/m
Measured Head TSL parameters	(22.0 \pm 0.2) °C	39.1 \pm 6 %	1.37 mho/m \pm 6 %
Head TSL temperature change during test	< 0.5 °C	----	----

SAR result with Head TSL

SAR averaged over 1 cm ³ (1 g) of Head TSL	Condition	
SAR measured	250 mW input power	9.20 W/kg
SAR for nominal Head TSL parameters	normalized to 1W	36.6 W/kg \pm 17.0 % (k=2)

SAR averaged over 10 cm ³ (10 g) of Head TSL	condition	
SAR measured	250 mW input power	4.88 W/kg
SAR for nominal Head TSL parameters	normalized to 1W	19.5 W/kg \pm 16.5 % (k=2)

Body TSL parameters

The following parameters and calculations were applied.

	Temperature	Permittivity	Conductivity
Nominal Body TSL parameters	22.0 °C	53.4	1.49 mho/m
Measured Body TSL parameters	(22.0 \pm 0.2) °C	53.7 \pm 6 %	1.49 mho/m \pm 6 %
Body TSL temperature change during test	< 0.5 °C	----	----

SAR result with Body TSL

SAR averaged over 1 cm ³ (1 g) of Body TSL	Condition	
SAR measured	250 mW input power	9.04 W/kg
SAR for nominal Body TSL parameters	normalized to 1W	36.2 W/kg \pm 17.0 % (k=2)

SAR averaged over 10 cm ³ (10 g) of Body TSL	condition	
SAR measured	250 mW input power	4.85 W/kg
SAR for nominal Body TSL parameters	normalized to 1W	19.4 W/kg \pm 16.5 % (k=2)

Appendix (Additional assessments outside the scope of SCS 0108)

Antenna Parameters with Head TSL

Impedance, transformed to feed point	51.4 Ω + 3.9 j Ω
Return Loss	- 27.9 dB

Antenna Parameters with Body TSL

Impedance, transformed to feed point	47.1 Ω + 2.7 j Ω
Return Loss	- 27.8 dB

General Antenna Parameters and Design

Electrical Delay (one direction)	1.221 ns
----------------------------------	----------

After long term use with 100W radiated power, only a slight warming of the dipole near the feedpoint can be measured.

The dipole is made of standard semirigid coaxial cable. The center conductor of the feeding line is directly connected to the second arm of the dipole. The antenna is therefore short-circuited for DC-signals. On some of the dipoles, small end caps are added to the dipole arms in order to improve matching when loaded according to the position as explained in the "Measurement Conditions" paragraph. The SAR data are not affected by this change. The overall dipole length is still according to the Standard.

No excessive force must be applied to the dipole arms, because they might bend or the soldered connections near the feedpoint may be damaged.

Additional EUT Data

Manufactured by	SPEAG
Manufactured on	June 15, 2010

DASY5 Validation Report for Head TSL

Date: 16.11.2016

Test Laboratory: SPEAG, Zurich, Switzerland

DUT: Dipole 1750 MHz; Type: D1750V2; Serial: D1750V2 - SN:1068

Communication System: UID 0 - CW; Frequency: 1750 MHz

Medium parameters used: $f = 1750$ MHz; $\sigma = 1.37$ S/m; $\epsilon_r = 39.1$; $\rho = 1000$ kg/m³

Phantom section: Flat Section

Measurement Standard: DASY5 (IEEE/IEC/ANSI C63.19-2011)

DASY52 Configuration:

- Probe: EX3DV4 - SN7349; ConvF(8.46, 8.46, 8.46); Calibrated: 15.06.2016;
- Sensor-Surface: 1.4mm (Mechanical Surface Detection)
- Electronics: DAE4 Sn601; Calibrated: 30.12.2015
- Phantom: Flat Phantom 5.0 (front); Type: QD000P50AA; Serial: 1001
- DASY52 52.8.8(1258); SEMCAD X 14.6.10(7372)

Dipole Calibration for Head Tissue/Pin=250 mW, d=10mm/Zoom Scan (7x7x7)/Cube 0:

Measurement grid: dx=5mm, dy=5mm, dz=5mm

Reference Value = 103.4 V/m; Power Drift = 0.01 dB

Peak SAR (extrapolated) = 16.8 W/kg

SAR(1 g) = 9.2 W/kg; SAR(10 g) = 4.88 W/kg

Maximum value of SAR (measured) = 14.0 W/kg

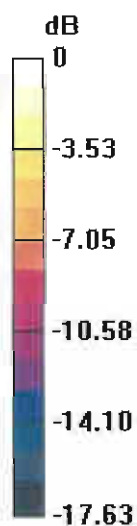

0 dB = 14.0 W/kg = 11.46 dBW/kg

Impedance Measurement Plot for Head TSL

16 Nov 2016 17:15:04

CH1 S11 1 U FS 1: 51.379 Ω 3.9633 Ω 351.35 μ H 1 750.000 000 MHz

*
De1
Cor
Avg
16
H1 d

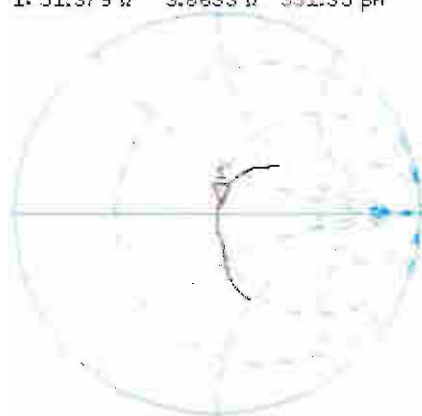

CH2 S11 LOG 5 dB/REF -20 dB 1: -27.851 dB 1 750.000 000 MHz

Cor
Avg
16
H1 d

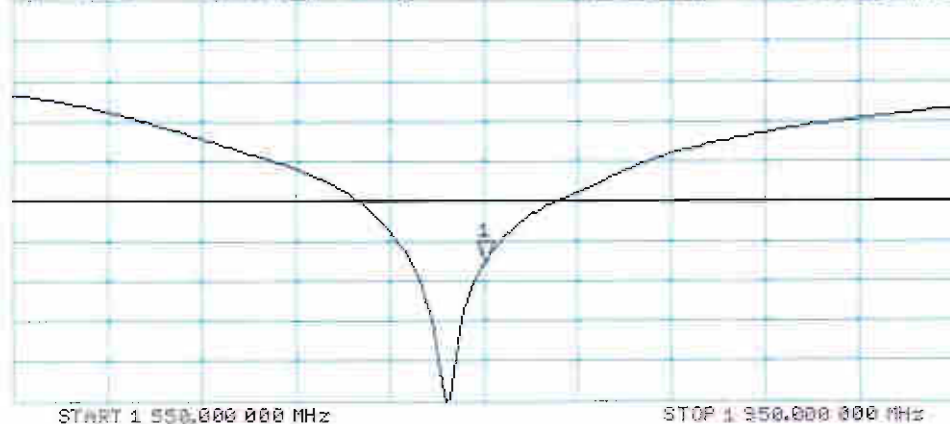

DASY5 Validation Report for Body TSL

Date: 16.11.2016

Test Laboratory: SPEAG, Zurich, Switzerland

DUT: Dipole 1750 MHz; Type: D1750V2; Serial: D1750V2 - SN:1068

Communication System: UID 0 - CW; Frequency: 1750 MHz

Medium parameters used: $f = 1750$ MHz; $\sigma = 1.49$ S/m; $\epsilon_r = 53.7$; $\rho = 1000$ kg/m³

Phantom section: Flat Section

Measurement Standard: DASY5 (IEEE/IEC/ANSI C63.19-2011)

DASY52 Configuration:

- Probe: EX3DV4 - SN7349; ConvF(8.25, 8.25, 8.25); Calibrated: 15.06.2016;
- Sensor-Surface: 1.4mm (Mechanical Surface Detection)
- Electronics: DAE4 Sn601; Calibrated: 30.12.2015
- Phantom: Flat Phantom 5.0 (back); Type: QD000P50AA; Serial: 1002
- DASY52 52.8.8(1258); SEMCAD X 14.6.10(7372)

Dipole Calibration for Body Tissue/Pin=250 mW, d=10mm/Zoom Scan (7x7x7)/Cube 0:

Measurement grid: dx=5mm, dy=5mm, dz=5mm

Reference Value = 99.57 V/m; Power Drift = -0.06 dB

Peak SAR (extrapolated) = 15.8 W/kg

SAR(1 g) = 9.04 W/kg; SAR(10 g) = 4.85 W/kg

Maximum value of SAR (measured) = 13.5 W/kg



0 dB = 13.5 W/kg = 11.30 dBW/kg

Impedance Measurement Plot for Body TSL

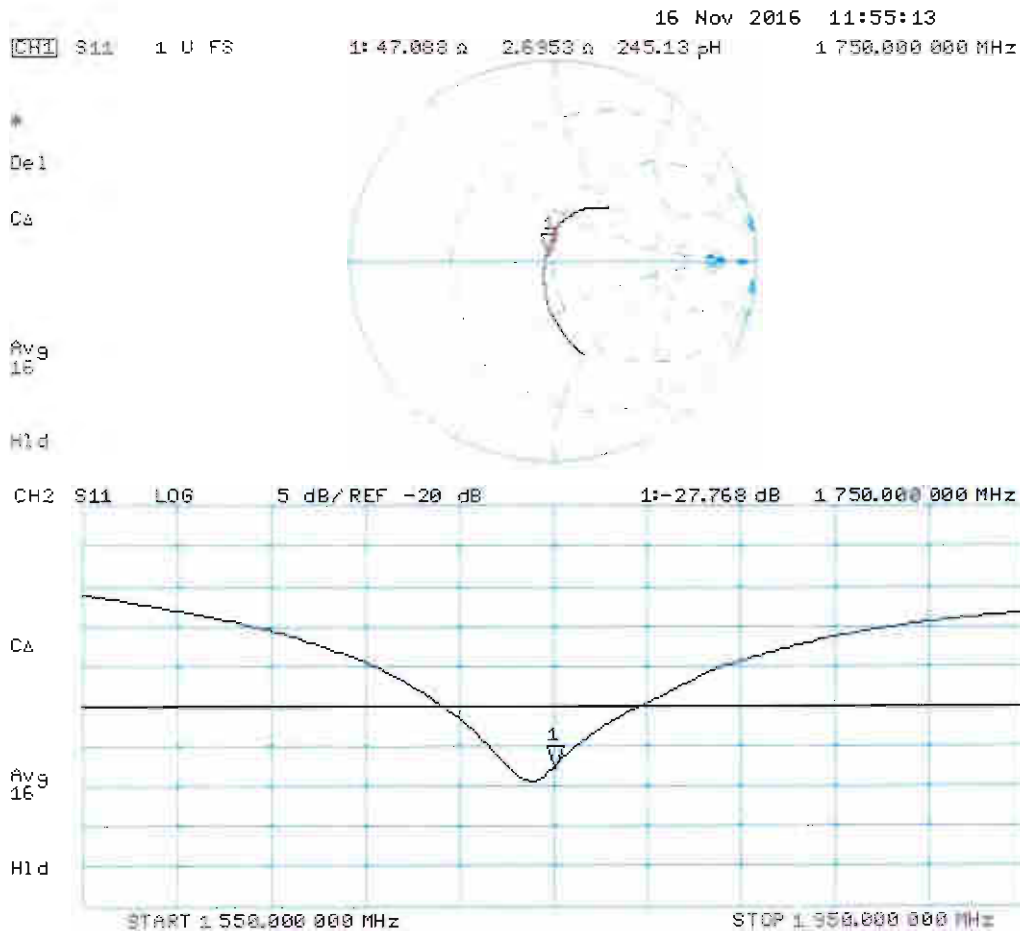



In Collaboration with
s p e a g
CALIBRATION LABORATORY



中国认可
国际互认
校准
CALIBRATION
CNAS L0570

Add: No.51 Xueyuan Road, Haidian District, Beijing, 100191, China
Tel: +86-10-62304633-2218 Fax: +86-10-62304633-2209
E-mail: cttl@chinattl.com [Http://www.chinattl.cn](http://www.chinattl.cn)

Client : **sporton**

Certificate No: **Z17-97055**

CALIBRATION CERTIFICATE

Object: **DAE4 - SN: 854**

Calibration Procedure(s): **FF-Z11-002-01**
Calibration Procedure for the Data Acquisition Electronics (DAEx)

Calibration date: **May 02, 2017**

This calibration Certificate documents the traceability to national standards, which realize the physical units of measurements(SI). The measurements and the uncertainties with confidence probability are given on the following pages and are part of the certificate.

All calibrations have been conducted in the closed laboratory facility: environment temperature(22±3)°C and humidity<70%.

Calibration Equipment used (M&TE critical for calibration)

Primary Standards	ID #	Cal Date(Calibrated by, Certificate No.)	Scheduled Calibration
Process Calibrator 753	1971018	27-June-16 (CTTL, No:J16X04778)	June-17

	Name	Function	Signature
Calibrated by:	Yu Zongying	SAR Test Engineer	
Reviewed by:	Lin Hao	SAR Test Engineer	
Approved by:	Qi Dianyuan	SAR Project Leader	

Issued: May 03, 2017

This calibration certificate shall not be reproduced except in full without written approval of the laboratory.



In Collaboration with

s p e a g

CALIBRATION LABORATORY

Add: No.51 Xueyuan Road, Haidian District, Beijing, 100191, China

Tel: +86-10-62304633-2218

Fax: +86-10-62304633-2209

E-mail: cttl@chinattl.com

[Http://www.chinattl.cn](http://www.chinattl.cn)

Glossary:

DAE data acquisition electronics
Connector angle information used in DASY system to align probe sensor X
to the robot coordinate system.

Methods Applied and Interpretation of Parameters:

- *DC Voltage Measurement:* Calibration Factor assessed for use in DASY system by comparison with a calibrated instrument traceable to national standards. The figure given corresponds to the full scale range of the voltmeter in the respective range.
- *Connector angle:* The angle of the connector is assessed measuring the angle mechanically by a tool inserted. Uncertainty is not required.
- The report provide only calibration results for DAE, it does not contain other performance test results.



In Collaboration with

s p e a g
CALIBRATION LABORATORY

Add: No.51 Xueyuan Road, Haidian District, Beijing, 100191, China

Tel: +86-10-62304633-2218

Fax: +86-10-62304633-2209

E-mail: cttl@chinattl.com

Http://www.chinattl.cn

DC Voltage Measurement

A/D - Converter Resolution nominal

High Range: 1LSB = 6.1μV, full range = -100...+300 mV

Low Range: 1LSB = 61nV, full range = -1.....+3mV

DASY measurement parameters: Auto Zero Time: 3 sec; Measuring time: 3 sec

Calibration Factors	X	Y	Z
High Range	405.005 ± 0.15% (k=2)	404.208 ± 0.15% (k=2)	405.318 ± 0.15% (k=2)
Low Range	3.96053 ± 0.7% (k=2)	3.94760 ± 0.7% (k=2)	3.96516 ± 0.7% (k=2)

Connector Angle

Connector Angle to be used in DASY system	325.5° ± 1 °
---	--------------



Accredited by the Swiss Accreditation Service (SAS)
The Swiss Accreditation Service is one of the signatories to the EA
Multilateral Agreement for the recognition of calibration certificates

Accreditation No.: **SCS 0108**

Client **Sporton (Auden)**

Certificate No: **EX3-7306_Jul17**

CALIBRATION CERTIFICATE

Object **EX3DV4 - SN:7306**

Calibration procedure(s) **A CAL-01.v9, QA CAL-14.v4, QA CAL-23.v5, QA CAL-25.v6**
Calibration procedure for dosimetric E-field probes

Calibration date: **July 24, 2017**

This calibration certificate documents the traceability to national standards, which realize the physical units of measurements (SI).
The measurements and the uncertainties with confidence probability are given on the following pages and are part of the certificate.

All calibrations have been conducted in the closed laboratory facility: environment temperature $(22 \pm 3)^\circ\text{C}$ and humidity $< 70\%$.

Calibration Equipment used (M&TE critical for calibration)

Primary Standards	ID	Cal Date (Certificate No.)	Scheduled Calibration
Power meter NRP	SN: 104778	04-Apr-17 (No. 217-02521/02522)	Apr-18
Power sensor NRP-Z91	SN: 103244	04-Apr-17 (No. 217-02521)	Apr-18
Power sensor NRP-Z91	SN: 103245	04-Apr-17 (No. 217-02525)	Apr-18
Reference 20 dB Attenuator	SN: S5277 (20x)	07-Apr-17 (No. 217-02528)	Apr-18
Reference Probe ES3DV2	SN: 3013	31-Dec-16 (No. ES3-3013_Dec16)	Dec-17
DAE4	SN: 660	7-Dec-16 (No. DAE4-660_Dec16)	Dec-17
Secondary Standards	ID	Check Date (in house)	Scheduled Check
Power meter E4419B	SN: GB41293874	06-Apr-16 (in house check Jun-16)	In house check: Jun-18
Power sensor E4412A	SN: MY41498087	06-Apr-16 (in house check Jun-16)	In house check: Jun-18
Power sensor E4412A	SN: 000110210	06-Apr-16 (in house check Jun-16)	In house check: Jun-18
RF generator HP 8648C	SN: US3642U01700	04-Aug-99 (in house check Jun-16)	In house check: Jun-18
Network Analyzer HP 8753E	SN: US37390585	18-Oct-01 (in house check Oct-16)	In house check: Oct-17

Calibrated by:	Name Michael Weber	Function Laboratory Technician	Signature
Approved by:	Name Katja Pokovic	Function Technical Manager	Signature

Issued: July 25, 2017

This calibration certificate shall not be reproduced except in full without written approval of the laboratory.



Accredited by the Swiss Accreditation Service (SAS)
The Swiss Accreditation Service is one of the signatories to the EA
Multilateral Agreement for the recognition of calibration certificates

Accreditation No.: **SCS 0108**

Glossary:

TSL	tissue simulating liquid
NORM _{x,y,z}	sensitivity in free space
ConvF	sensitivity in TSL / NORM _{x,y,z}
DCP	diode compression point
CF	crest factor (1/duty_cycle) of the RF signal
A, B, C, D	modulation dependent linearization parameters
Polarization φ	φ rotation around probe axis
Polarization ϑ	ϑ rotation around an axis that is in the plane normal to probe axis (at measurement center), i.e., $\vartheta = 0$ is normal to probe axis
Connector Angle	information used in DASY system to align probe sensor X to the robot coordinate system

Calibration is Performed According to the Following Standards:

- IEEE Std 1528-2013, "IEEE Recommended Practice for Determining the Peak Spatial-Averaged Specific Absorption Rate (SAR) in the Human Head from Wireless Communications Devices: Measurement Techniques", June 2013
- IEC 62209-1, "Measurement procedure for the assessment of Specific Absorption Rate (SAR) from hand-held and body-mounted devices used next to the ear (frequency range of 300 MHz to 6 GHz)", July 2016
- IEC 62209-2, "Procedure to determine the Specific Absorption Rate (SAR) for wireless communication devices used in close proximity to the human body (frequency range of 30 MHz to 6 GHz)", March 2010
- KDB 865664, "SAR Measurement Requirements for 100 MHz to 6 GHz"

Methods Applied and Interpretation of Parameters:

- NORM_{x,y,z}**: Assessed for E-field polarization $\vartheta = 0$ ($f \leq 900$ MHz in TEM-cell; $f > 1800$ MHz: R22 waveguide). NORM_{x,y,z} are only intermediate values, i.e., the uncertainties of NORM_{x,y,z} does not affect the E²-field uncertainty inside TSL (see below *ConvF*).
- NORM(f)_{x,y,z}** = NORM_{x,y,z} * frequency_response (see Frequency Response Chart). This linearization is implemented in DASY4 software versions later than 4.2. The uncertainty of the frequency response is included in the stated uncertainty of *ConvF*.
- DCP_{x,y,z}**: DCP are numerical linearization parameters assessed based on the data of power sweep with CW signal (no uncertainty required). DCP does not depend on frequency nor media.
- PAR**: PAR is the Peak to Average Ratio that is not calibrated but determined based on the signal characteristics
- A_{x,y,z}; B_{x,y,z}; C_{x,y,z}; D_{x,y,z}; VR_{x,y,z}**: A, B, C, D are numerical linearization parameters assessed based on the data of power sweep for specific modulation signal. The parameters do not depend on frequency nor media. VR is the maximum calibration range expressed in RMS voltage across the diode.
- ConvF and Boundary Effect Parameters**: Assessed in flat phantom using E-field (or Temperature Transfer Standard for $f \leq 800$ MHz) and inside waveguide using analytical field distributions based on power measurements for $f > 800$ MHz. The same setups are used for assessment of the parameters applied for boundary compensation (alpha, depth) of which typical uncertainty values are given. These parameters are used in DASY4 software to improve probe accuracy close to the boundary. The sensitivity in TSL corresponds to NORM_{x,y,z} * ConvF whereby the uncertainty corresponds to that given for ConvF. A frequency dependent ConvF is used in DASY version 4.4 and higher which allows extending the validity from ± 50 MHz to ± 100 MHz.
- Spherical isotropy (3D deviation from isotropy)**: in a field of low gradients realized using a flat phantom exposed by a patch antenna.
- Sensor Offset**: The sensor offset corresponds to the offset of virtual measurement center from the probe tip (on probe axis). No tolerance required.
- Connector Angle**: The angle is assessed using the information gained by determining the NORM_x (no uncertainty required).

Probe EX3DV4

SN:7306

Manufactured:	March 11, 2014
Repaired:	July 17, 2017
Calibrated:	July 24, 2017

Calibrated for DASY/EASY Systems
(Note: non-compatible with DASY2 system!)

DASY/EASY - Parameters of Probe: EX3DV4 - SN:7306

Basic Calibration Parameters

	Sensor X	Sensor Y	Sensor Z	Unc (k=2)
Norm ($\mu\text{V}/(\text{V}/\text{m})^2$) ^A	0.49	0.58	0.46	$\pm 10.1 \%$
DCP (mV) ^B	99.6	93.5	97.4	

Modulation Calibration Parameters

UID	Communication System Name		A dB	B dB $\sqrt{\mu\text{V}}$	C	D dB	VR mV	Unc ^E (k=2)
0	CW	X	0.0	0.0	1.0	0.00	142.9	$\pm 3.5 \%$
		Y	0.0	0.0	1.0		146.1	
		Z	0.0	0.0	1.0		142.3	

The reported uncertainty of measurement is stated as the standard uncertainty of measurement multiplied by the coverage factor k=2, which for a normal distribution corresponds to a coverage probability of approximately 95%.

^A The uncertainties of Norm X,Y,Z do not affect the E²-field uncertainty inside TSL (see Pages 5 and 6).

^B Numerical linearization parameter: uncertainty not required.

^E Uncertainty is determined using the max. deviation from linear response applying rectangular distribution and is expressed for the square of the field value.

DASY/EASY - Parameters of Probe: EX3DV4 - SN:7306

Calibration Parameter Determined in Head Tissue Simulating Media

f (MHz) ^C	Relative Permittivity ^F	Conductivity (S/m) ^F	ConvF X	ConvF Y	ConvF Z	Alpha ^G	Depth ^G (mm)	Unc (k=2)
750	41.9	0.89	9.96	9.96	9.96	0.48	0.80	± 12.0 %
835	41.5	0.90	9.79	9.79	9.79	0.45	0.80	± 12.0 %
900	41.5	0.97	9.50	9.50	9.50	0.34	0.98	± 12.0 %
1750	40.1	1.37	8.64	8.64	8.64	0.36	0.80	± 12.0 %
1900	40.0	1.40	8.34	8.34	8.34	0.32	0.80	± 12.0 %
2000	40.0	1.40	8.32	8.32	8.32	0.35	0.86	± 12.0 %
2450	39.2	1.80	7.49	7.49	7.49	0.36	0.80	± 12.0 %
2600	39.0	1.96	7.36	7.36	7.36	0.37	0.80	± 12.0 %
5250	35.9	4.71	5.58	5.58	5.58	0.35	1.80	± 13.1 %
5600	35.5	5.07	4.73	4.73	4.73	0.40	1.80	± 13.1 %
5750	35.4	5.22	5.10	5.10	5.10	0.40	1.80	± 13.1 %

^C Frequency validity above 300 MHz of ± 100 MHz only applies for DASY v4.4 and higher (see Page 2), else it is restricted to ± 50 MHz. The uncertainty is the RSS of the ConvF uncertainty at calibration frequency and the uncertainty for the indicated frequency band. Frequency validity below 300 MHz is ± 10, 25, 40, 50 and 70 MHz for ConvF assessments at 30, 64, 128, 150 and 220 MHz respectively. Above 5 GHz frequency validity can be extended to ± 110 MHz.

^F At frequencies below 3 GHz, the validity of tissue parameters (ϵ and σ) can be relaxed to ± 10% if liquid compensation formula is applied to measured SAR values. At frequencies above 3 GHz, the validity of tissue parameters (ϵ and σ) is restricted to ± 5%. The uncertainty is the RSS of the ConvF uncertainty for indicated target tissue parameters.

^G Alpha/Depth are determined during calibration. SPEAG warrants that the remaining deviation due to the boundary effect after compensation is always less than ± 1% for frequencies below 3 GHz and below ± 2% for frequencies between 3-6 GHz at any distance larger than half the probe tip diameter from the boundary.

DASY/EASY - Parameters of Probe: EX3DV4 - SN:7306

Calibration Parameter Determined in Body Tissue Simulating Media

f (MHz) ^C	Relative Permittivity ^F	Conductivity (S/m) ^F	ConvF X	ConvF Y	ConvF Z	Alpha ^G	Depth (mm) ^G	Unc (k=2)
750	55.5	0.96	10.09	10.09	10.09	0.47	0.84	± 12.0 %
835	55.2	0.97	9.85	9.85	9.85	0.42	0.80	± 12.0 %
1750	53.4	1.49	8.29	8.29	8.29	0.44	0.80	± 12.0 %
1900	53.3	1.52	7.98	7.98	7.98	0.43	0.80	± 12.0 %
2450	52.7	1.95	7.73	7.73	7.73	0.32	0.90	± 12.0 %
2600	52.5	2.16	7.46	7.46	7.46	0.26	0.96	± 12.0 %
5250	48.9	5.36	5.05	5.05	5.05	0.35	1.90	± 13.1 %
5600	48.5	5.77	4.29	4.29	4.29	0.40	1.90	± 13.1 %
5750	48.3	5.94	4.47	4.47	4.47	0.45	1.90	± 13.1 %

^C Frequency validity above 300 MHz of ± 100 MHz only applies for DASY v4.4 and higher (see Page 2), else it is restricted to ± 50 MHz. The uncertainty is the RSS of the ConvF uncertainty at calibration frequency and the uncertainty for the indicated frequency band. Frequency validity below 300 MHz is ± 10, 25, 40, 50 and 70 MHz for ConvF assessments at 30, 64, 128, 150 and 220 MHz respectively. Above 5 GHz frequency validity can be extended to ± 110 MHz.

^F At frequencies below 3 GHz, the validity of tissue parameters (ϵ and σ) can be relaxed to ± 10% if liquid compensation formula is applied to measured SAR values. At frequencies above 3 GHz, the validity of tissue parameters (ϵ and σ) is restricted to ± 5%. The uncertainty is the RSS of the ConvF uncertainty for indicated target tissue parameters.

^G Alpha/Depth are determined during calibration. SPEAG warrants that the remaining deviation due to the boundary effect after compensation is always less than ± 1% for frequencies below 3 GHz and below ± 2% for frequencies between 3-6 GHz at any distance larger than half the probe tip diameter from the boundary.

Frequency Response of E-Field (TEM-Cell:ifi110 EXX, Waveguide: R22)

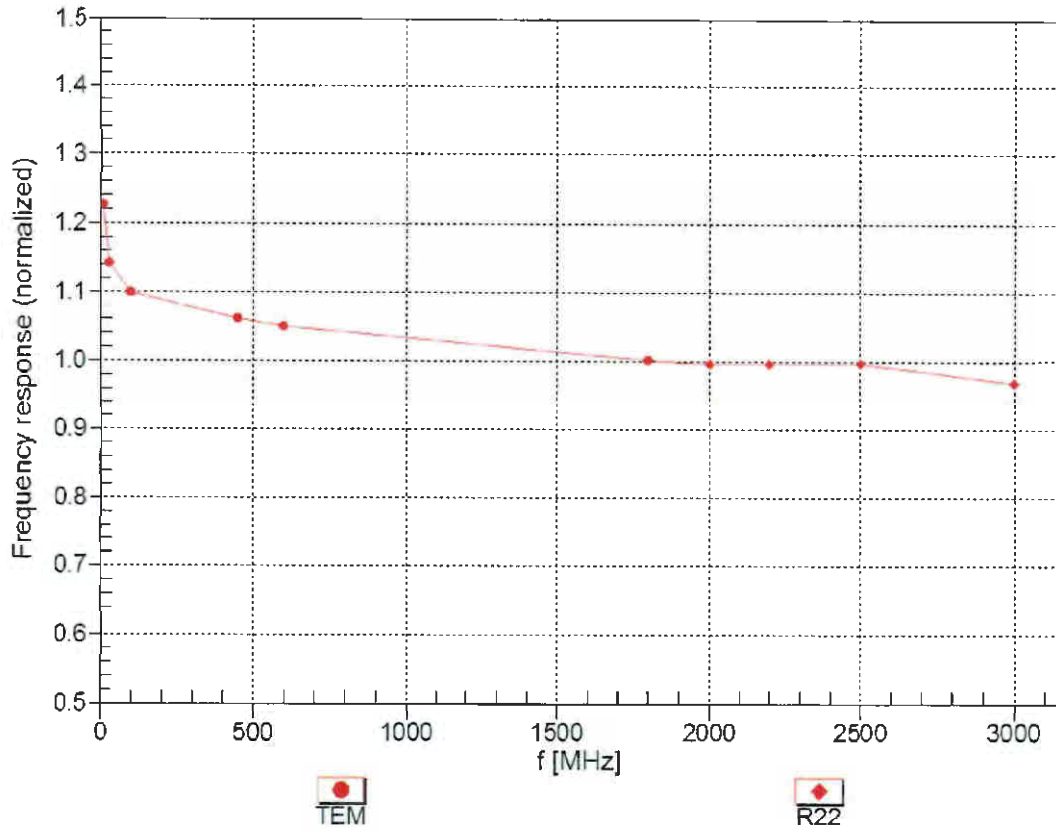

Uncertainty of Frequency Response of E-field: $\pm 6.3\%$ (k=2)

Receiving Pattern (ϕ), $\theta = 0^\circ$

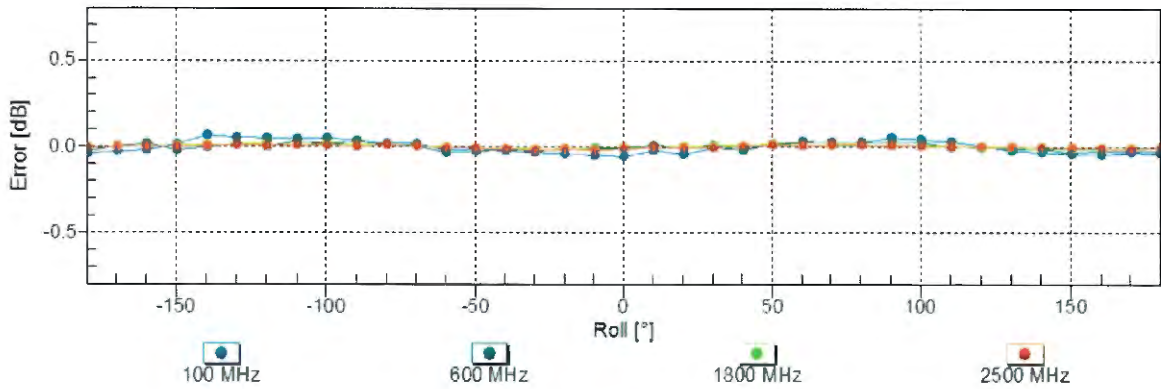
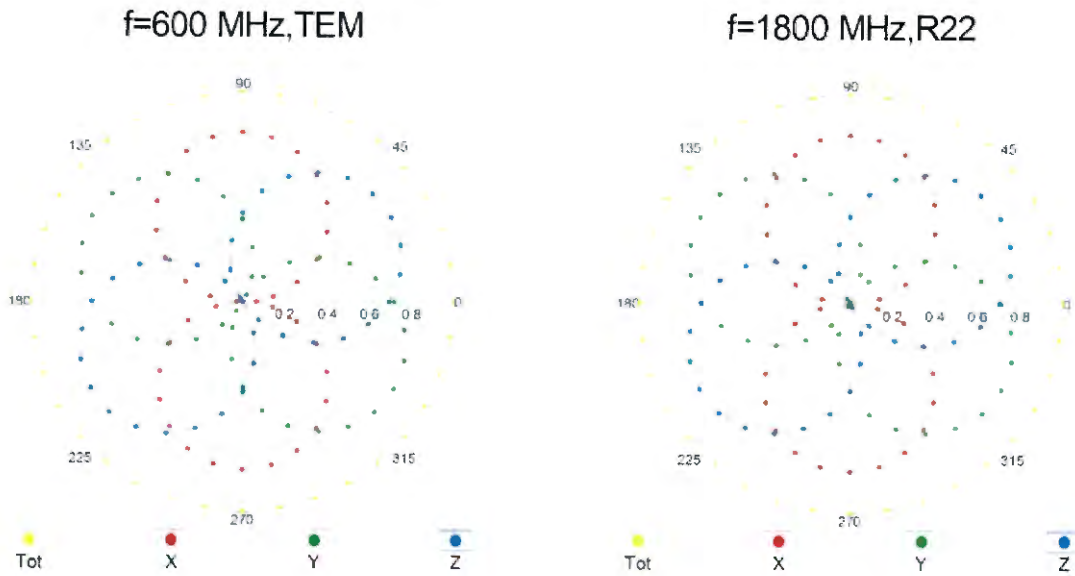

Uncertainty of Axial Isotropy Assessment: $\pm 0.5\%$ ($k=2$)

Dynamic Range $f(SAR_{head})$ (TEM cell , $f_{eval}= 1900$ MHz)

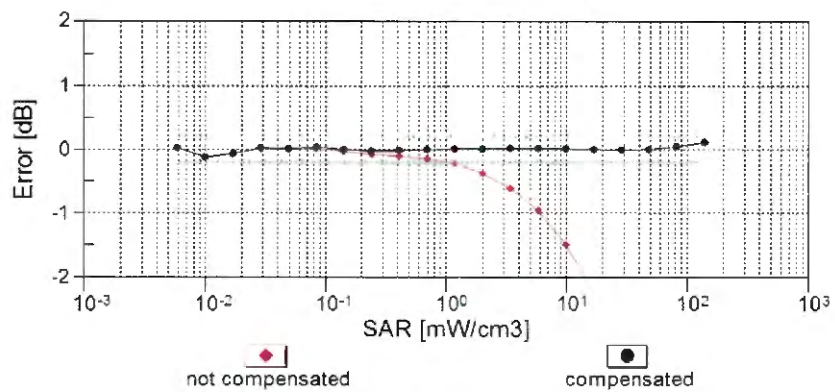
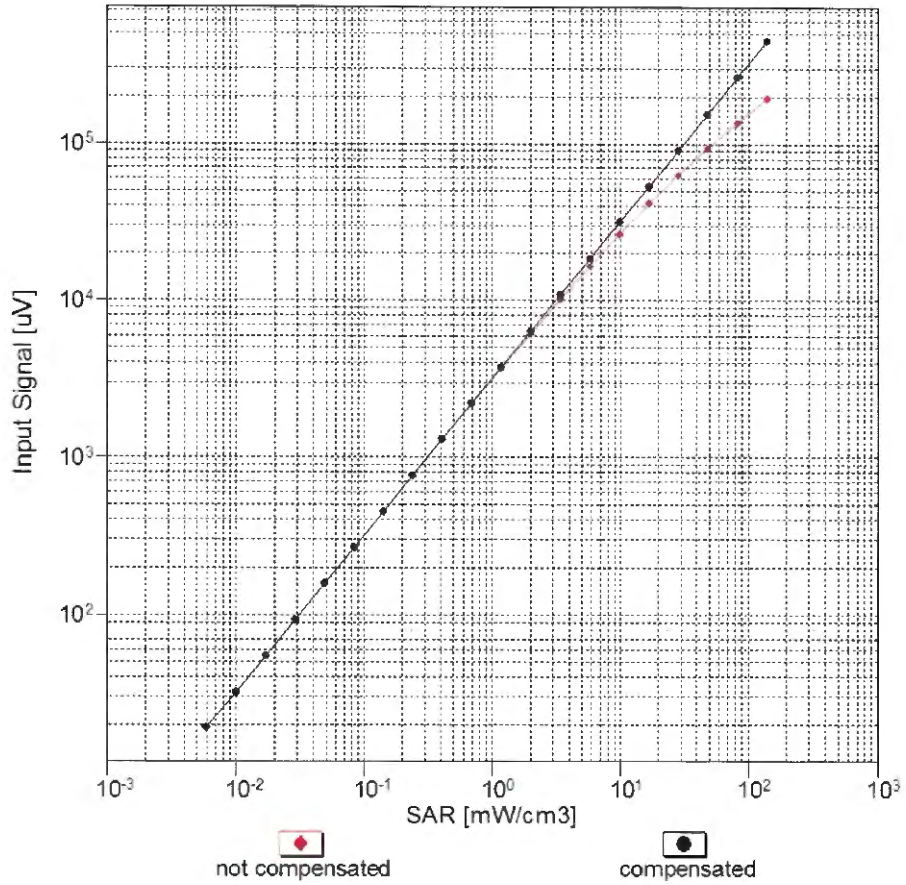

Uncertainty of Linearity Assessment: $\pm 0.6\%$ (k=2)

Conversion Factor Assessment

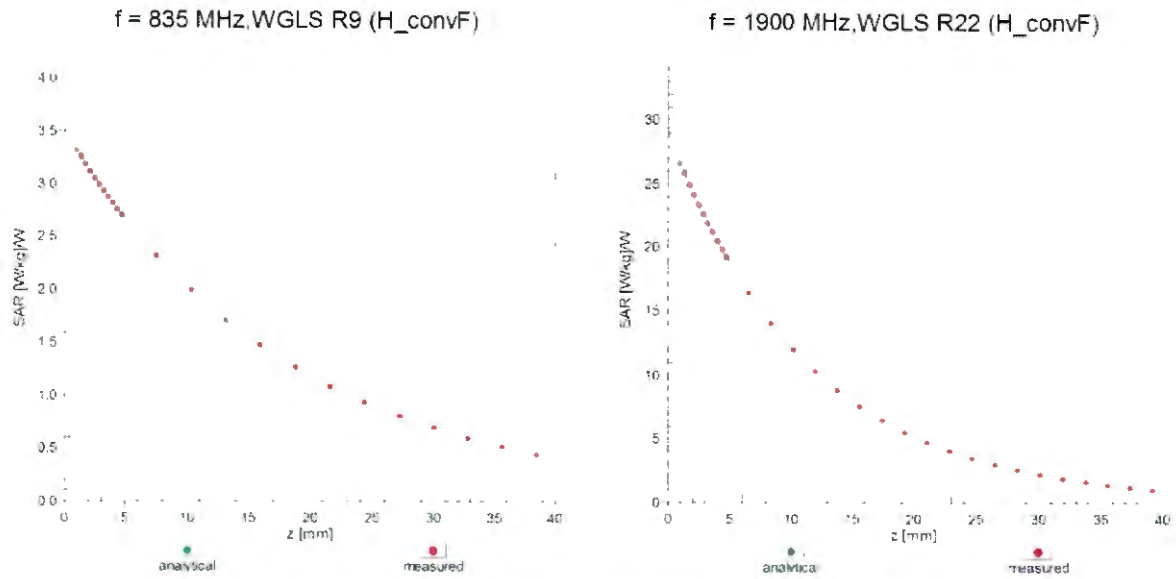

Deviation from Isotropy in Liquid Error (ϕ, θ), $f = 900 \text{ MHz}$

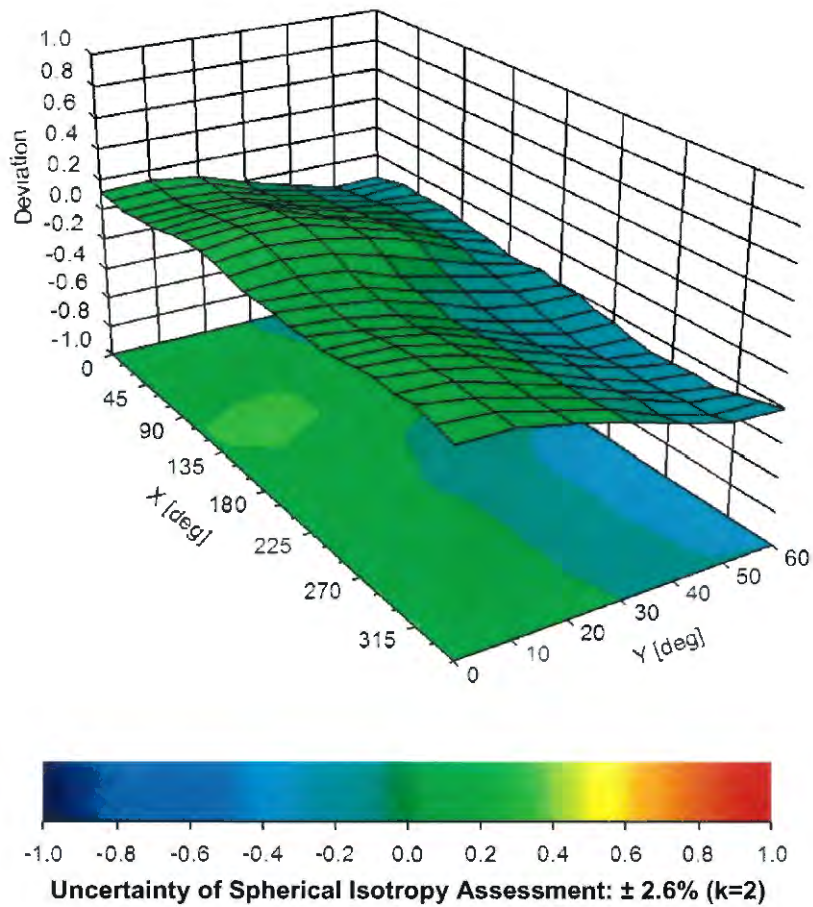

DASY/EASY - Parameters of Probe: EX3DV4 - SN:7306

Other Probe Parameters

Sensor Arrangement	Triangular
Connector Angle (°)	50.4
Mechanical Surface Detection Mode	enabled
Optical Surface Detection Mode	disabled
Probe Overall Length	337 mm
Probe Body Diameter	10 mm
Tip Length	9 mm
Tip Diameter	2.5 mm
Probe Tip to Sensor X Calibration Point	1 mm
Probe Tip to Sensor Y Calibration Point	1 mm
Probe Tip to Sensor Z Calibration Point	1 mm
Recommended Measurement Distance from Surface	1.4 mm



Appendix D. Reference Report

The report is shown as follows.

FCC SAR Test Report

APPLICANT : HMD Global Oy
EQUIPMENT : Smart Phone
BRAND NAME : NOKIA
MODEL NAME : TA-1004
FCC ID : 2AJOTTA-1004
STANDARD : FCC 47 CFR Part 2 (2.1093)
ANSI/IEEE C95.1-1992
IEEE 1528-2013

We, SPORTON INTERNATIONAL INC., would like to declare that the tested sample has been evaluated in accordance with the procedures and had been in compliance with the applicable technical standards.

The test results in this report apply exclusively to the tested model / sample. Without written approval of SPORTON INTERNATIONAL INC., the test report shall not be reproduced except in full.

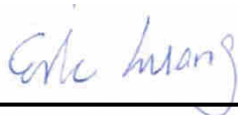

Reviewed by: Eric Huang / Manager



Approved by: Jones Tsai / Manager



SPORTON INTERNATIONAL INC.

No.52, Hwa Ya 1st Rd., Hwa Ya Technology Park, Kwei-Shan District, Taoyuan City, Taiwan (R.O.C.)



Table of Contents

1. Statement of Compliance 4
2. Administration Data 5
3. Guidance Applied..... 5
4. Equipment Under Test (EUT) Information 6
4.1 General Information 6
4.2 General LTE SAR Test and Reporting Considerations 7
5. RF Exposure Limits..... 9
5.1 Uncontrolled Environment..... 9
5.2 Controlled Environment..... 9
6. Specific Absorption Rate (SAR).....10
6.1 Introduction10
6.2 SAR Definition.....10
7. System Description and Setup11
7.1 E-Field Probe12
7.2 Data Acquisition Electronics (DAE)12
7.3 Phantom.....13
7.4 Device Holder.....14
8. Measurement Procedures15
8.1 Spatial Peak SAR Evaluation15
8.2 Power Reference Measurement.....16
8.3 Area Scan16
8.4 Zoom Scan.....17
8.5 Volume Scan Procedures.....17
8.6 Power Drift Monitoring.....17
9. Test Equipment List18
10. System Verification19
10.1 Tissue Simulating Liquids.....19
10.2 Tissue Verification20
10.3 System Performance Check Results.....21
11. RF Exposure Positions22
11.1 Ear and handset reference point22
11.2 Definition of the cheek position.....23
11.3 Definition of the tilt position.....24
11.4 Body Worn Accessory24
11.5 Wireless Router.....25
11.6 Product Specific Exposure25
12. Conducted RF Output Power (Unit: dBm).....26
13. Bluetooth Exclusions Applied62
14. Antenna Location63
15. SAR Test Results64
15.1 Head SAR66
15.2 Hotspot SAR69
15.3 Product Specific SAR.....72
15.4 Body Worn Accessory SAR.....73
15.5 Repeated SAR Measurement75
16. Simultaneous Transmission Analysis76
16.1 Head Exposure Conditions77
16.2 Hotspot Exposure Conditions.....78
16.3 Product Specific Exposure Conditions79
16.4 Body-Worn Accessory Exposure Conditions80
16.5 SPLSR Evaluation and Analysis.....81
17. Uncertainty Assessment88
18. References.....91
Appendix A. Plots of System Performance Check
Appendix B. Plots of High SAR Measurement
Appendix C. DASy Calibration Certificate
Appendix D. Test Setup Photos



Revision History

REPORT NO.	VERSION	DESCRIPTION	ISSUED DATE
FA712102	Rev. 01	Initial issue of report	May 25, 2017



1. Statement of Compliance

The maximum results of Specific Absorption Rate (SAR) found during testing for HMD Global Oy, Smart Phone, TA-1004, are as follows.

Equipment Class	Frequency Band	Highest SAR Summary				Highest Simultaneous Transmission 1g SAR (W/kg)
		Head (Separation 0mm)	Body-worn (Separation 15mm)	Hotspot (Separation 10mm)	Product Specific (Separation 0mm)	
		1g SAR (W/kg)			10g SAR (W/kg)	
Licensed	GSM850	0.13	0.19	0.25		1.59
	GSM1900	0.18	0.49	1.20		
	WCDMA II	0.24	0.33	0.78		
	WCDMA V	0.14	0.17	0.26		
	LTE Band 2	0.16	0.35	0.90		
	LTE Band 4	0.14	0.39	0.91		
	LTE Band 5	0.18	0.22	0.31		
	LTE Band 7	0.18	0.48	1.13		
LTE Band 38 / 41	0.12	0.20	0.40			
DTS	2.4GHz WLAN	0.77	0.13	0.20		1.58
NII	5GHz WLAN	1.09	0.22	0.36	1.02	1.59
Date of Testing:		2017/3/21 ~ 2017/4/21				

Remark :

1. LTE band 38 SAR test was covered by Band 41; according to April 2015 TCB workshop, SAR test for overlapping LTE bands can be reduced if
 - a. the maximum output power, including tolerance, for the smaller band is ≤ the larger band to qualify for the SAR test exclusion
 - b. the channel bandwidth and other operating parameters for the smaller band are fully supported by the larger band

This device is in compliance with Specific Absorption Rate (SAR) for general population/uncontrolled exposure limits (1.6 W/kg for Partial-Body, 4.0 W/kg for Product Specific) specified in FCC 47 CFR part 2 (2.1093) and ANSI/IEEE C95.1-1992, and had been tested in accordance with the measurement methods and procedures specified in IEEE 1528-2013 and FCC KDB publications



2. Administration Data

Testing Laboratory	
Test Site	SPORTON INTERNATIONAL INC.
Test Site Location	No.52, Hwa Ya 1st Rd., Hwa Ya Technology Park, Kwei-Shan District, Taoyuan City, Taiwan (R.O.C.) TEL: +886-3-327-3456 FAX: +886-3-328-4978

Applicant	
Company Name	HMD Global Oy
Address	Karaportti 2, 02610 Espoo, Finland

Manufacturer	
Company Name	HMD Global Oy
Address	Karaportti 2, 02610 Espoo, Finland

3. Guidance Applied

The Specific Absorption Rate (SAR) testing specification, method, and procedure for this device is in accordance with the following standards:

- FCC 47 CFR Part 2 (2.1093)
- ANSI/IEEE C95.1-1992
- IEEE 1528-2013
- FCC KDB 865664 D01 SAR Measurement 100 MHz to 6 GHz v01r04
- FCC KDB 865664 D02 SAR Reporting v01r02
- FCC KDB 447498 D01 General RF Exposure Guidance v06
- FCC KDB 648474 D04 SAR Evaluation Considerations for Wireless Handsets v01r03
- FCC KDB 248227 D01 802.11 Wi-Fi SAR v02r02
- FCC KDB 941225 D01 3G SAR Procedures v03r01
- FCC KDB 941225 D05 SAR for LTE Devices v02r05
- FCC KDB 941225 D06 Hotspot Mode SAR v02r01



4. Equipment Under Test (EUT) Information

4.1 General Information

Product Feature & Specification	
Equipment Name	Smart Phone
Brand Name	NOKIA
Model Name	TA-1004
FCC ID	2AJOTTA-1004
IMEI	For WWAN Band : SIM 1 : 356027080013165 SIM 2 : 356027080013173 For WLAN Band : SIM 1 : 356027080014189 SIM 2 : 356027080014197
Wireless Technology and Frequency Range	GSM850: 824.2 MHz ~ 848.8 MHz GSM1900: 1850.2 MHz ~ 1909.8 MHz WCDMA Band II: 1852.4 MHz ~ 1907.6 MHz WCDMA Band V: 826.4 MHz ~ 846.6 MHz LTE Band 2: 1850.7 MHz ~ 1909.3 MHz LTE Band 4: 1710.7 MHz ~ 1754.3 MHz LTE Band 5: 824.7 MHz ~ 848.3 MHz LTE Band 7: 2502.5 MHz ~ 2567.5 MHz LTE Band 38: 2572.5 MHz ~ 2617.5 MHz LTE Band 41: 2498.5 MHz ~ 2687.5 MHz WLAN 2.4GHz Band: 2412 MHz ~ 2462 MHz WLAN 5.2GHz Band: 5180 MHz ~ 5240 MHz WLAN 5.3GHz Band: 5260 MHz ~ 5320 MHz WLAN 5.5GHz Band: 5500 MHz ~ 5720 MHz WLAN 5.8GHz Band: 5745 MHz ~ 5825 MHz Bluetooth: 2402 MHz ~ 2480 MHz NFC : 13.56 MHz
Mode	GSM/GPRS/EGPRS/DTM RMC/AMR 12.2Kbps HSDPA HSUPA DC-HSDPA LTE: QPSK, 16QAM WLAN 2.4GHz : 802.11b/g/n HT20 WLAN 5GHz : 802.11a/n/ac HT20/HT40/VHT20/VHT40/VHT80 Bluetooth BR/EDR/LE NFC:ASK
HW Version	170
SW Version	V2.500
GSM / (E)GPRS Dual Transfer mode	Class A – EUT can support Packet Switched and Circuit Switched Network simultaneously.
EUT Stage	Identical Prototype
Remark:	
<ol style="list-style-type: none"> This device 2.4GHz / 5.2GHz / 5.8GHz WLAN supports Hotspot operation. This device has 2 SIM slots and supports Dual SIM Dual Standby. The WWAN radio transmission will be enabled by either one SIM at a time (Single active). Power reduction for head exposure conditions of WLAN transmitter : Once the voice call or VoIP call (either through WWAN bearer, or WLAN bearer) is established, upper layer will determine whether the audio is actively routed through the earpiece receiver. If yes, and will notify the WLAN side to enter the reduced power for WLAN. 	



4.2 General LTE SAR Test and Reporting Considerations

Summarized necessary items addressed in KDB 941225 D05 v02r05																																							
FCC ID	2AJOTTA-1004																																						
Equipment Name	Smart Phone																																						
Operating Frequency Range of each LTE transmission band	LTE Band 2: 1850.7 MHz ~ 1909.3 MHz LTE Band 4: 1710.7 MHz ~ 1754.3 MHz LTE Band 5: 824.7 MHz ~ 848.3 MHz LTE Band 7: 2502.5 MHz ~ 2567.5 MHz LTE Band 38: 2572.5 MHz ~ 2617.5 MHz LTE Band 41: 2498.5 MHz ~ 2687.5 MHz																																						
Channel Bandwidth	LTE Band 02: 1.4MHz, 3MHz, 5MHz, 10MHz, 15MHz, 20MHz LTE Band 04: 1.4MHz, 3MHz, 5MHz, 10MHz, 15MHz, 20MHz LTE Band 05: 1.4MHz, 3MHz, 5MHz, 10MHz LTE Band 07: 5MHz, 10MHz, 15MHz, 20MHz LTE Band 38: 5MHz, 10MHz, 15MHz, 20MHz LTE Band 41: 5MHz, 10MHz, 15MHz, 20MHz																																						
uplink modulations used	QPSK, and 16QAM																																						
LTE Voice / Data requirements	Voice and Data																																						
LTE MPR permanently built-in by design	<p style="text-align: center;">Table 6.2.3-1: Maximum Power Reduction (MPR) for Power Class 3</p> <table border="1"> <thead> <tr> <th rowspan="2">Modulation</th> <th colspan="6">Channel bandwidth / Transmission bandwidth (RB)</th> <th rowspan="2">MPR (dB)</th> </tr> <tr> <th>1.4 MHz</th> <th>3.0 MHz</th> <th>5 MHz</th> <th>10 MHz</th> <th>15 MHz</th> <th>20 MHz</th> </tr> </thead> <tbody> <tr> <td>QPSK</td> <td>> 5</td> <td>> 4</td> <td>> 8</td> <td>> 12</td> <td>> 16</td> <td>> 18</td> <td>≤ 1</td> </tr> <tr> <td>16 QAM</td> <td>≤ 5</td> <td>≤ 4</td> <td>≤ 8</td> <td>≤ 12</td> <td>≤ 16</td> <td>≤ 18</td> <td>≤ 1</td> </tr> <tr> <td>16 QAM</td> <td>> 5</td> <td>> 4</td> <td>> 8</td> <td>> 12</td> <td>> 16</td> <td>> 18</td> <td>≤ 2</td> </tr> </tbody> </table>	Modulation	Channel bandwidth / Transmission bandwidth (RB)						MPR (dB)	1.4 MHz	3.0 MHz	5 MHz	10 MHz	15 MHz	20 MHz	QPSK	> 5	> 4	> 8	> 12	> 16	> 18	≤ 1	16 QAM	≤ 5	≤ 4	≤ 8	≤ 12	≤ 16	≤ 18	≤ 1	16 QAM	> 5	> 4	> 8	> 12	> 16	> 18	≤ 2
Modulation	Channel bandwidth / Transmission bandwidth (RB)						MPR (dB)																																
	1.4 MHz	3.0 MHz	5 MHz	10 MHz	15 MHz	20 MHz																																	
QPSK	> 5	> 4	> 8	> 12	> 16	> 18	≤ 1																																
16 QAM	≤ 5	≤ 4	≤ 8	≤ 12	≤ 16	≤ 18	≤ 1																																
16 QAM	> 5	> 4	> 8	> 12	> 16	> 18	≤ 2																																
LTE A-MPR	In the base station simulator configuration, Network Setting value is set to NS_01 to disable A-MPR during SAR testing and the LTE SAR tests was transmitting on all TTI frames (Maximum TTI)																																						
Spectrum plots for RB configuration	A properly configured base station simulator was used for the SAR and power measurement; therefore, spectrum plots for each RB allocation and offset configuration are not included in the SAR report.																																						



Transmission (H, M, L) channel numbers and frequencies in each LTE band												
LTE Band 2												
	Bandwidth 1.4 MHz		Bandwidth 3 MHz		Bandwidth 5 MHz		Bandwidth 10 MHz		Bandwidth 15 MHz		Bandwidth 20 MHz	
	Ch. #	Freq. (MHz)	Ch. #	Freq. (MHz)	Ch. #	Freq. (MHz)	Ch. #	Freq. (MHz)	Ch. #	Freq. (MHz)	Ch. #	Freq. (MHz)
L	18607	1850.7	18615	1851.5	18625	1852.5	18650	1855	18675	1857.5	18700	1860
M	18900	1880	18900	1880	18900	1880	18900	1880	18900	1880	18900	1880
H	19193	1909.3	19185	1908.5	19175	1907.5	19150	1905	19125	1902.5	19100	1900
LTE Band 4												
	Bandwidth 1.4 MHz		Bandwidth 3 MHz		Bandwidth 5 MHz		Bandwidth 10 MHz		Bandwidth 15 MHz		Bandwidth 20 MHz	
	Ch. #	Freq. (MHz)	Ch. #	Freq. (MHz)	Ch. #	Freq. (MHz)	Ch. #	Freq. (MHz)	Ch. #	Freq. (MHz)	Ch. #	Freq. (MHz)
L	19957	1710.7	19965	1711.5	19975	1712.5	20000	1715	20025	1717.5	20050	1720
M	20175	1732.5	20175	1732.5	20175	1732.5	20175	1732.5	20175	1732.5	20175	1732.5
H	20393	1754.3	20385	1753.5	20375	1752.5	20350	1750	20325	1747.5	20300	1745
LTE Band 5												
	Bandwidth 1.4 MHz		Bandwidth 3 MHz		Bandwidth 5 MHz		Bandwidth 10 MHz		Bandwidth 15 MHz		Bandwidth 20 MHz	
	Ch. #	Freq. (MHz)	Ch. #	Freq. (MHz)	Ch. #	Freq. (MHz)	Ch. #	Freq. (MHz)	Ch. #	Freq. (MHz)	Ch. #	Freq. (MHz)
L	20407	824.7	20415	825.5	20425	826.5	20450	829	20450	829	20450	829
M	20525	836.5	20525	836.5	20525	836.5	20525	836.5	20525	836.5	20525	836.5
H	20643	848.3	20635	847.5	20625	846.5	20600	844	20600	844	20600	844
LTE Band 7												
	Bandwidth 5 MHz		Bandwidth 10 MHz		Bandwidth 15 MHz		Bandwidth 20 MHz		Bandwidth 15 MHz		Bandwidth 20 MHz	
	Ch. #	Freq. (MHz)	Ch. #	Freq. (MHz)	Ch. #	Freq. (MHz)	Ch. #	Freq. (MHz)	Ch. #	Freq. (MHz)	Ch. #	Freq. (MHz)
L	20775	2502.5	20800	2505	20825	2507.5	20850	2510	20850	2510	20850	2510
M	21100	2535	21100	2535	21100	2535	21100	2535	21100	2535	21100	2535
H	21425	2567.5	21400	2565	21375	2562.5	21350	2560	21350	2560	21350	2560
LTE Band 38												
	Bandwidth 5 MHz		Bandwidth 10 MHz		Bandwidth 15 MHz		Bandwidth 20 MHz		Bandwidth 15 MHz		Bandwidth 20 MHz	
	Ch. #	Freq. (MHz)	Ch. #	Freq. (MHz)	Ch. #	Freq. (MHz)	Ch. #	Freq. (MHz)	Ch. #	Freq. (MHz)	Ch. #	Freq. (MHz)
L	37775	2572.5	37800	2575	37825	2577.5	37850	2580	37850	2580	37850	2580
M	38000	2595	38000	2595	38000	2595	38000	2595	38000	2595	38000	2595
H	38225	2617.5	38200	2615	38175	2612.5	38150	2610	38150	2610	38150	2610
LTE Band 41												
	Bandwidth 5 MHz		Bandwidth 10 MHz		Bandwidth 15 MHz		Bandwidth 20 MHz		Bandwidth 15 MHz		Bandwidth 20 MHz	
	Ch. #	Freq. (MHz)	Ch. #	Freq. (MHz)	Ch. #	Freq. (MHz)	Ch. #	Freq. (MHz)	Ch. #	Freq. (MHz)	Ch. #	Freq. (MHz)
L	39675	2498.5	39700	2501	39725	2503.5	39750	2506	39750	2506	39750	2506
L	40148	2545.8	40160	2547	40173	2548.3	40185	2549.5	40185	2549.5	40185	2549.5
M	40620	2593	40620	2593	40620	2593	40620	2593	40620	2593	40620	2593
H	41093	2640.3	41080	2639	41068	2637.8	41055	2636.5	41055	2636.5	41055	2636.5
H	41565	2687.5	41540	2685	41515	2682.5	41490	2680	41490	2680	41490	2680



5. RF Exposure Limits

5.1 Uncontrolled Environment

Uncontrolled Environments are defined as locations where there is the exposure of individuals who have no knowledge or control of their exposure. The general population/uncontrolled exposure limits are applicable to situations in which the general public may be exposed or in which persons who are exposed as a consequence of their employment may not be made fully aware of the potential for exposure or cannot exercise control over their exposure. Members of the general public would come under this category when exposure is not employment-related; for example, in the case of a wireless transmitter that exposes persons in its vicinity.

5.2 Controlled Environment

Controlled Environments are defined as locations where there is exposure that may be incurred by persons who are aware of the potential for exposure, (i.e. as a result of employment or occupation). In general, occupational/controlled exposure limits are applicable to situations in which persons are exposed as a consequence of their employment, who have been made fully aware of the potential for exposure and can exercise control over their exposure. The exposure category is also applicable when the exposure is of a transient nature due to incidental passage through a location where the exposure levels may be higher than the general population/uncontrolled limits, but the exposed person is fully aware of the potential for exposure and can exercise control over his or her exposure by leaving the area or by some other appropriate means.

Limits for Occupational/Controlled Exposure (W/kg)

Whole-Body	Partial-Body	Hands, Wrists, Feet and Ankles
0.4	8.0	20.0

Limits for General Population/Uncontrolled Exposure (W/kg)

Whole-Body	Partial-Body	Hands, Wrists, Feet and Ankles
0.08	1.6	4.0

1. Whole-Body SAR is averaged over the entire body, partial-body SAR is averaged over any 1gram of tissue defined as a tissue volume in the shape of a cube. SAR for hands, wrists, feet and ankles is averaged over any 10 grams of tissue defined as a tissue volume in the shape of a cube.

6. Specific Absorption Rate (SAR)

6.1 Introduction

SAR is related to the rate at which energy is absorbed per unit mass in an object exposed to a radio field. The SAR distribution in a biological body is complicated and is usually carried out by experimental techniques or numerical modeling. The standard recommends limits for two tiers of groups, occupational/controlled and general population/uncontrolled, based on a person's awareness and ability to exercise control over his or her exposure. In general, occupational/controlled exposure limits are higher than the limits for general population/uncontrolled.

6.2 SAR Definition

The SAR definition is the time derivative (rate) of the incremental energy (dW) absorbed by (dissipated in) an incremental mass (dm) contained in a volume element (dv) of a given density (ρ). The equation description is as below:

$$SAR = \frac{d}{dt} \left(\frac{dW}{dm} \right) = \frac{d}{dt} \left(\frac{dW}{\rho dv} \right)$$

SAR is expressed in units of Watts per kilogram (W/kg)

$$SAR = \frac{\sigma |E|^2}{\rho}$$

Where: σ is the conductivity of the tissue, ρ is the mass density of the tissue and E is the RMS electrical field strength.

7. System Description and Setup

The DASY system used for performing compliance tests consists of the following items:

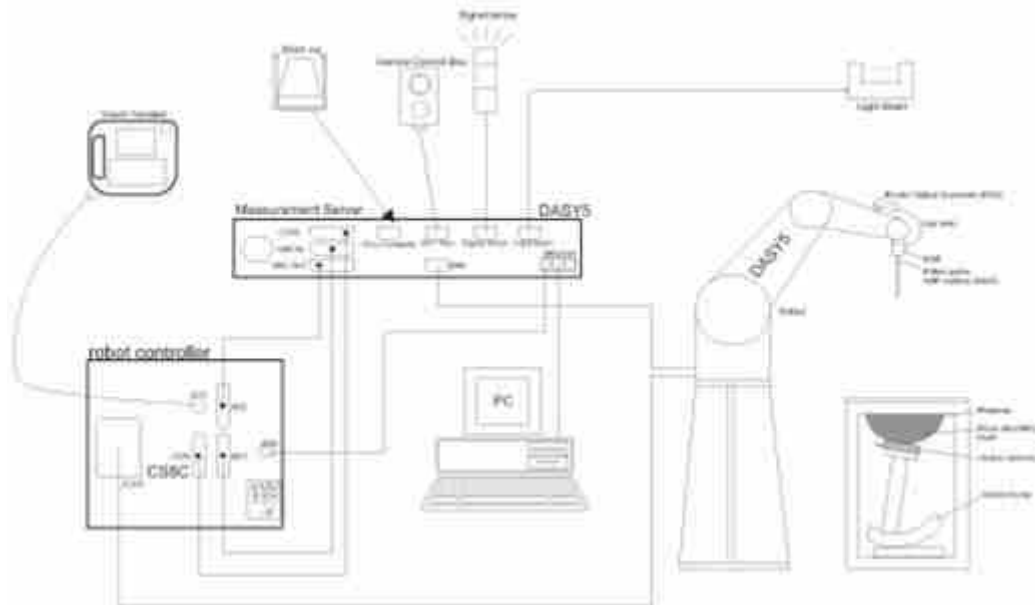

- A standard high precision 6-axis robot with controller, teach pendant and software. An arm extension for accommodating the data acquisition electronics (DAE).
- An isotropic Field probe optimized and calibrated for the targeted measurement.
- A data acquisition electronics (DAE) which performs the signal amplification, signal multiplexing, AD-conversion, offset measurements, mechanical surface detection, collision detection, etc. The unit is battery powered with standard or rechargeable batteries. The signal is optically transmitted to the EOC.
- The Electro-optical converter (EOC) performs the conversion from optical to electrical signals for the digital communication to the DAE. To use optical surface detection, a special version of the EOC is required. The EOC signal is transmitted to the measurement server.
- The function of the measurement server is to perform the time critical tasks such as signal filtering, control of the robot operation and fast movement interrupts.
- The Light Beam used is for probe alignment. This improves the (absolute) accuracy of the probe positioning.
- A computer running WinXP or Win7 and the DASY5 software.
- Remote control and teach pendant as well as additional circuitry for robot safety such as warning lamps, etc.
- The phantom, the device holder and other accessories according to the targeted measurement.

7.1 E-Field Probe

The SAR measurement is conducted with the dosimetric probe (manufactured by SPEAG). The probe is specially designed and calibrated for use in liquid with high permittivity. The dosimetric probe has special calibration in liquid at different frequency. This probe has a built in optical surface detection system to prevent from collision with phantom.

<ES3DV3 Probe>

Construction	Symmetric design with triangular core Interleaved sensors Built-in shielding against static charges PEEK enclosure material (resistant to organic solvents, e.g., DGBE)	
Frequency	10 MHz – 4 GHz; Linearity: ± 0.2 dB (30 MHz – 4 GHz)	
Directivity	± 0.2 dB in TSL (rotation around probe axis) ± 0.3 dB in TSL (rotation normal to probe axis)	
Dynamic Range	5 μ W/g – >100 mW/g; Linearity: ± 0.2 dB	
Dimensions	Overall length: 337 mm (tip: 20 mm) Tip diameter: 3.9 mm (body: 12 mm) Distance from probe tip to dipole centers: 3.0 mm	

<EX3DV4 Probe>

Construction	Symmetric design with triangular core Built-in shielding against static charges PEEK enclosure material (resistant to organic solvents, e.g., DGBE)	
Frequency	10 MHz – >6 GHz Linearity: ± 0.2 dB (30 MHz – 6 GHz)	
Directivity	± 0.3 dB in TSL (rotation around probe axis) ± 0.5 dB in TSL (rotation normal to probe axis)	
Dynamic Range	10 μ W/g – >100 mW/g Linearity: ± 0.2 dB (noise: typically <1 μ W/g)	
Dimensions	Overall length: 337 mm (tip: 20 mm) Tip diameter: 2.5 mm (body: 12 mm) Typical distance from probe tip to dipole centers: 1 mm	

7.2 Data Acquisition Electronics (DAE)

The data acquisition electronics (DAE) consists of a highly sensitive electrometer-grade preamplifier with auto-zeroing, a channel and gain-switching multiplexer, a fast 16 bit AD-converter and a command decoder and control logic unit. Transmission to the measurement server is accomplished through an optical downlink for data and status information as well as an optical uplink for commands and the clock.

The input impedance of the DAE is 200 MOhm; the inputs are symmetrical and floating. Common mode rejection is above 80 dB.



Fig 5.1 Photo of DAE

7.3 Phantom

<SAM Twin Phantom>

Shell Thickness	2 ± 0.2 mm; Center ear point: 6 ± 0.2 mm	
Filling Volume	Approx. 25 liters	
Dimensions	Length: 1000 mm; Width: 500 mm; Height: adjustable feet	
Measurement Areas	Left Hand, Right Hand, Flat Phantom	

The bottom plate contains three pair of bolts for locking the device holder. The device holder positions are adjusted to the standard measurement positions in the three sections. A white cover is provided to tap the phantom during off-periods to prevent water evaporation and changes in the liquid parameters. On the phantom top, three reference markers are provided to identify the phantom position with respect to the robot.

<ELI Phantom>

Shell Thickness	2 ± 0.2 mm (sagging: <1%)	
Filling Volume	Approx. 30 liters	
Dimensions	Major ellipse axis: 600 mm Minor axis: 400 mm	

The ELI phantom is intended for compliance testing of handheld and body-mounted wireless devices in the frequency range of 30 MHz to 6 GHz. ELI4 is fully compatible with standard and all known tissue simulating liquids.

7.4 Device Holder

<Mounting Device for Hand-Held Transmitter>

In combination with the Twin SAM V5.0/V5.0c or ELI phantoms, the Mounting Device for Hand-Held Transmitters enables rotation of the mounted transmitter device to specified spherical coordinates. At the heads, the rotation axis is at the ear opening. Transmitter devices can be easily and accurately positioned according to IEC 62209-1, IEEE 1528, FCC, or other specifications. The device holder can be locked for positioning at different phantom sections (left head, right head, flat). And upgrade kit to Mounting Device to enable easy mounting of wider devices like big smart-phones, e-books, small tablets, etc. It holds devices with width up to 140 mm.



Mounting Device for Hand-Held Transmitters



Mounting Device Adaptor for Wide-Phones

<Mounting Device for Laptops and other Body-Worn Transmitters>

The extension is lightweight and made of POM, acrylic glass and foam. It fits easily on the upper part of the mounting device in place of the phone positioned. The extension is fully compatible with the SAM Twin and ELI phantoms.



Mounting Device for Laptops



8. Measurement Procedures

The measurement procedures are as follows:

<Conducted power measurement>

- (a) For WWAN power measurement, use base station simulator to configure EUT WWAN transmission in conducted connection with RF cable, at maximum power in each supported wireless interface and frequency band.
- (b) Read the WWAN RF power level from the base station simulator.
- (c) For WLAN/BT power measurement, use engineering software to configure EUT WLAN/BT continuously transmission, at maximum RF power in each supported wireless interface and frequency band
- (d) Connect EUT RF port through RF cable to the power meter, and measure WLAN/BT output power

<SAR measurement>

- (a) Use base station simulator to configure EUT WWAN transmission in radiated connection, and engineering software to configure EUT WLAN/BT continuously transmission, at maximum RF power, in the highest power channel.
- (b) Place the EUT in the positions as Appendix D demonstrates.
- (c) Set scan area, grid size and other setting on the DASY software.
- (d) Measure SAR results for the highest power channel on each testing position.
- (e) Find out the largest SAR result on these testing positions of each band
- (f) Measure SAR results for other channels in worst SAR testing position if the reported SAR of highest power channel is larger than 0.8 W/kg

According to the test standard, the recommended procedure for assessing the peak spatial-average SAR value consists of the following steps:

- (a) Power reference measurement
- (b) Area scan
- (c) Zoom scan
- (d) Power drift measurement

8.1 Spatial Peak SAR Evaluation

The procedure for spatial peak SAR evaluation has been implemented according to the test standard. It can be conducted for 1g and 10g, as well as for user-specific masses. The DASY software includes all numerical procedures necessary to evaluate the spatial peak SAR value.

The base for the evaluation is a "cube" measurement. The measured volume must include the 1g and 10g cubes with the highest averaged SAR values. For that purpose, the center of the measured volume is aligned to the interpolated peak SAR value of a previously performed area scan.

The entire evaluation of the spatial peak values is performed within the post-processing engine (SEMCAD). The system always gives the maximum values for the 1g and 10g cubes. The algorithm to find the cube with highest averaged SAR is divided into the following stages:

- (a) Extraction of the measured data (grid and values) from the Zoom Scan
- (b) Calculation of the SAR value at every measurement point based on all stored data (A/D values and measurement parameters)
- (c) Generation of a high-resolution mesh within the measured volume
- (d) Interpolation of all measured values from the measurement grid to the high-resolution grid
- (e) Extrapolation of the entire 3-D field distribution to the phantom surface over the distance from sensor to surface
- (f) Calculation of the averaged SAR within masses of 1g and 10g

8.2 Power Reference Measurement

The Power Reference Measurement and Power Drift Measurements are for monitoring the power drift of the device under test in the batch process. The minimum distance of probe sensors to surface determines the closest measurement point to phantom surface. This distance cannot be smaller than the distance of sensor calibration points to probe tip as defined in the probe properties.

8.3 Area Scan

The area scan is used as a fast scan in two dimensions to find the area of high field values, before doing a fine measurement around the hot spot. The sophisticated interpolation routines implemented in DASY software can find the maximum found in the scanned area, within a range of the global maximum. The range (in dB0 is specified in the standards for compliance testing. For example, a 2 dB range is required in IEEE standard 1528 and IEC 62209 standards, whereby 3 dB is a requirement when compliance is assessed in accordance with the ARIB standard (Japan), if only one zoom scan follows the area scan, then only the absolute maximum will be taken as reference. For cases where multiple maximums are detected, the number of zoom scans has to be increased accordingly.

Area scan parameters extracted from FCC KDB 865664 D01v01r04 SAR measurement 100 MHz to 6 GHz.

	≤ 3 GHz	> 3 GHz
Maximum distance from closest measurement point (geometric center of probe sensors) to phantom surface	5 ± 1 mm	$\frac{1}{2} \cdot \delta \cdot \ln(2) \pm 0.5$ mm
Maximum probe angle from probe axis to phantom surface normal at the measurement location	30° ± 1°	20° ± 1°
Maximum area scan spatial resolution: Δx_{Area} , Δy_{Area}	≤ 2 GHz: ≤ 15 mm 2 – 3 GHz: ≤ 12 mm	3 – 4 GHz: ≤ 12 mm 4 – 6 GHz: ≤ 10 mm
	When the x or y dimension of the test device, in the measurement plane orientation, is smaller than the above, the measurement resolution must be ≤ the corresponding x or y dimension of the test device with at least one measurement point on the test device.	

8.4 Zoom Scan

Zoom scans are used to assess the peak spatial SAR values within a cubic averaging volume containing 1 gram and 10 gram of simulated tissue. The zoom scan measures points (refer to table below) within a cube whose base faces are centered on the maxima found in a preceding area scan job within the same procedure. When the measurement is done, the zoom scan evaluates the averaged SAR for 1 gram and 10 gram and displays these values next to the job's label.

Zoom scan parameters extracted from FCC KDB 865664 D01v01r04 SAR measurement 100 MHz to 6 GHz.

		≤ 3 GHz	> 3 GHz	
Maximum zoom scan spatial resolution: $\Delta x_{Zoom}, \Delta y_{Zoom}$		≤ 2 GHz: ≤ 8 mm 2 – 3 GHz: ≤ 5 mm*	3 – 4 GHz: ≤ 5 mm* 4 – 6 GHz: ≤ 4 mm*	
Maximum zoom scan spatial resolution, normal to phantom surface	uniform grid: $\Delta z_{Zoom}(n)$	≤ 5 mm	3 – 4 GHz: ≤ 4 mm 4 – 5 GHz: ≤ 3 mm 5 – 6 GHz: ≤ 2 mm	
	graded grid	$\Delta z_{Zoom}(1)$: between 1 st two points closest to phantom surface	≤ 4 mm	3 – 4 GHz: ≤ 3 mm 4 – 5 GHz: ≤ 2.5 mm 5 – 6 GHz: ≤ 2 mm
		$\Delta z_{Zoom}(n>1)$: between subsequent points	$\leq 1.5 \cdot \Delta z_{Zoom}(n-1)$	
Minimum zoom scan volume	x, y, z	≥ 30 mm	3 – 4 GHz: ≥ 28 mm 4 – 5 GHz: ≥ 25 mm 5 – 6 GHz: ≥ 22 mm	
Note: δ is the penetration depth of a plane-wave at normal incidence to the tissue medium; see draft standard IEEE P1528-2011 for details. * When zoom scan is required and the <i>reported</i> SAR from the <i>area scan based 1-g SAR estimation</i> procedures of KDB 447498 is ≤ 1.4 W/kg, ≤ 8 mm, ≤ 7 mm and ≤ 5 mm zoom scan resolution may be applied, respectively, for 2 GHz to 3 GHz, 3 GHz to 4 GHz and 4 GHz to 6 GHz.				

8.5 Volume Scan Procedures

The volume scan is used to assess overlapping SAR distributions for antennas transmitting in different frequency bands. It is equivalent to an oversized zoom scan used in standalone measurements. The measurement volume will be used to enclose all the simultaneous transmitting antennas. For antennas transmitting simultaneously in different frequency bands, the volume scan is measured separately in each frequency band. In order to sum correctly to compute the 1g aggregate SAR, the EUT remain in the same test position for all measurements and all volume scan use the same spatial resolution and grid spacing. When all volume scan were completed, the software, SEMCAD postprocessor can combine and subsequently superpose these measurement data to calculating the multiband SAR.

8.6 Power Drift Monitoring

All SAR testing is under the EUT install full charged battery and transmit maximum output power. In DASy measurement software, the power reference measurement and power drift measurement procedures are used for monitoring the power drift of EUT during SAR test. Both these procedures measure the field at a specified reference position before and after the SAR testing. The software will calculate the field difference in dB. If the power drifts more than 5%, the SAR will be retested.



9. Test Equipment List

Manufacturer	Name of Equipment	Type/Model	Serial Number	Calibration	
				Last Cal.	Due Date
SPEAG	835MHz System Validation Kit	D835V2	4d200	Aug. 23, 2016	Aug. 22, 2017
SPEAG	1750MHz System Validation Kit	D1750V2	1068	Nov. 16, 2016	Nov. 15, 2017
SPEAG	1900MHz System Validation Kit	D1900V2	5d041	Sep. 30, 2016	Sep. 29, 2017
SPEAG	2450MHz System Validation Kit	D2450V2	736	Aug. 30, 2016	Aug. 29, 2017
SPEAG	2600MHz System Validation Kit	D2600V2	1008	Aug. 30, 2016	Aug. 29, 2017
SPEAG	5GHz System Validation Kit	D5GHzV2	1006	Sep. 27, 2016	Sep. 26, 2017
SPEAG	Data Acquisition Electronics	DAE4	1424	Feb. 16, 2017	Feb. 15, 2018
SPEAG	Data Acquisition Electronics	DAE3	495	May. 27, 2016	May. 26, 2017
SPEAG	Data Acquisition Electronics	DAE4	1399	Nov. 17, 2016	Nov. 16, 2017
SPEAG	Data Acquisition Electronics	DAE4	778	May. 12, 2016	May. 11, 2017
SPEAG	Data Acquisition Electronics	DAE3	577	Sep. 28, 2016	Sep. 27, 2017
SPEAG	Dosimetric E-Field Probe	EX3DV4	3976	Feb. 21, 2017	Feb. 20, 2018
SPEAG	Dosimetric E-Field Probe	EX3DV4	3925	May. 26, 2016	May. 25, 2017
SPEAG	Dosimetric E-Field Probe	EX3DV4	3955	Nov. 24, 2016	Nov. 23, 2017
SPEAG	Dosimetric E-Field Probe	ES3DV3	3270	Aug. 26, 2016	Aug. 25, 2017
SPEAG	Dosimetric E-Field Probe	EX3DV4	3931	Oct. 03, 2016	Oct. 02, 2017
WonDer	Thermometer	WD-5015	TM685	Oct. 12, 2016	Oct. 11, 2017
WonDer	Thermometer	WD-5015	TM642	Oct. 12, 2016	Oct. 11, 2017
WonDer	Thermometer	WD-5015	TM281	Oct. 12, 2016	Oct. 11, 2017
Wisewind	Thermometer	HTC-1	TM560	Oct. 12, 2016	Oct. 11, 2017
Wisewind	Thermometer	HTC-1	TM225	Oct. 12, 2016	Oct. 11, 2017
Anritsu	Radio Communication Analyzer	MT8820C	6201381760	May. 10, 2016	May. 09, 2017
Agilent	Wireless Communication Test Set	E5515C	MY50266977	May. 17, 2016	May. 16, 2017
SPEAG	Device Holder	N/A	N/A	N/A	N/A
Anritsu	Signal Generator	MG3710A	6201502524	Dec. 09, 2016	Dec. 08, 2017
Agilent	ENA Network Analyzer	E5071C	MY46316648	Jan. 04, 2017	Jan. 03, 2018
SPEAG	Dielectric Probe Kit	DAK-3.5	1126	Jul. 19, 2016	Jul. 18, 2017
LINE SEIKI	Digital Thermometer	LKMelectronic	DTM3000SPEZIAL	Sep. 05, 2016	Sep. 04, 2017
Anritsu	Power Meter	ML2495A	1419002	May. 10, 2016	May. 09, 2017
Anritsu	Power Meter	ML2495A	1438002	Dec. 06, 2016	Dec. 05, 2017
Anritsu	Power Sensor	MA2411B	1339124	May. 10, 2016	May. 09, 2017
Anritsu	Power Sensor	MA2411B	1339195	Dec. 06, 2016	Dec. 05, 2017
Anritsu	Spectrum Analyzer	MS2830A	6201396378	Jun. 21, 2016	Jun. 20, 2017
Mini-Circuits	Power Amplifier	ZVE-8G+	D120604	Mar. 09, 2017	Mar. 08, 2018
Mini-Circuits	Power Amplifier	ZHL-42W+	QA1344002	Mar. 09, 2017	Mar. 08, 2018
ATM	Dual Directional Coupler	C122H-10	P610410z-02	Note 1	
Woken	Attenuator 1	WK0602-XX	N/A	Note 1	
PE	Attenuator 2	PE7005-10	N/A	Note 1	
PE	Attenuator 3	PE7005- 3	N/A	Note 1	

General Note:

1. Prior to system verification and validation, the path loss from the signal generator to the system check source and the power meter, which includes the amplifier, cable, attenuator and directional coupler, was measured by the network analyzer. The reading of the power meter was offset by the path loss difference between the path to the power meter and the path to the system check source to monitor the actual power level fed to the system check source.

10. System Verification

10.1 Tissue Simulating Liquids

For the measurement of the field distribution inside the SAM phantom with DASY, the phantom must be filled with around 25 liters of homogeneous body tissue simulating liquid. For head SAR testing, the liquid height from the ear reference point (ERP) of the phantom to the liquid top surface is larger than 15 cm, which is shown in Fig. 10.1. For body SAR testing, the liquid height from the center of the flat phantom to the liquid top surface is larger than 15 cm, which is shown in Fig. 10.2.



Fig 10.1 Photo of Liquid Height for Head SAR

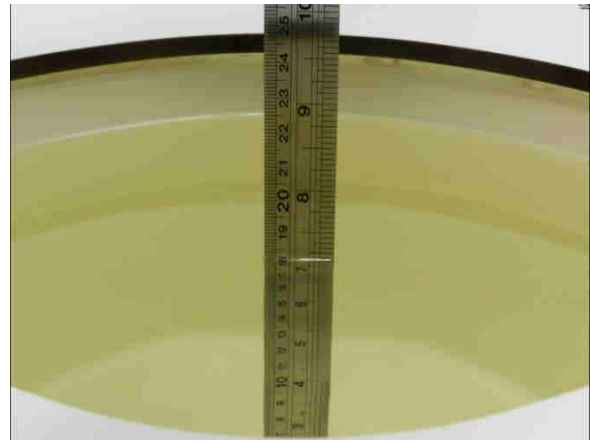

Fig 10.2 Photo of Liquid Height for Body SAR



10.2 Tissue Verification

The following tissue formulations are provided for reference only as some of the parameters have not been thoroughly verified. The composition of ingredients may be modified accordingly to achieve the desired target tissue parameters required for routine SAR evaluation.

Frequency (MHz)	Water (%)	Sugar (%)	Cellulose (%)	Salt (%)	Preventol (%)	DGBE (%)	Conductivity (σ)	Permittivity (ε _r)
For Head								
750	41.1	57.0	0.2	1.4	0.2	0	0.89	41.9
835	40.3	57.9	0.2	1.4	0.2	0	0.90	41.5
900	40.3	57.9	0.2	1.4	0.2	0	0.97	41.5
1800, 1900, 2000	55.2	0	0	0.3	0	44.5	1.40	40.0
2450	55.0	0	0	0	0	45.0	1.80	39.2
2600	54.8	0	0	0.1	0	45.1	1.96	39.0
For Body								
750	51.7	47.2	0	0.9	0.1	0	0.96	55.5
835	50.8	48.2	0	0.9	0.1	0	0.97	55.2
900	50.8	48.2	0	0.9	0.1	0	1.05	55.0
1800, 1900, 2000	70.2	0	0	0.4	0	29.4	1.52	53.3
2450	68.6	0	0	0	0	31.4	1.95	52.7
2600	68.1	0	0	0.1	0	31.8	2.16	52.5

Simulating Liquid for 5GHz, Manufactured by SPEAG

Ingredients	(% by weight)
Water	64~78%
Mineral oil	11~18%
Emulsifiers	9~15%
Additives and Salt	2~3%

<Tissue Dielectric Parameter Check Results>

Frequency (MHz)	Tissue Type	Liquid Temp. (°C)	Conductivity (σ)	Permittivity (ε _r)	Conductivity Target (σ)	Permittivity Target (ε _r)	Delta (σ) (%)	Delta (ε _r) (%)	Limit (%)	Date
835	HSL	22.5	0.876	40.791	0.90	41.50	-2.67	-1.71	±5	2017/3/31
835	MSL	22.4	0.951	56.030	0.97	55.20	-1.96	1.50	±5	2017/3/23
1750	HSL	22.4	1.382	41.201	1.37	40.10	0.88	2.75	±5	2017/3/31
1750	MSL	22.2	1.527	54.161	1.49	53.40	2.48	1.43	±5	2017/3/23
1900	HSL	22.6	1.406	41.568	1.40	40.00	0.43	3.92	±5	2017/3/30
1900	MSL	22.3	1.540	54.718	1.52	53.30	1.32	2.66	±5	2017/3/22
2450	HSL	22.4	1.805	40.668	1.80	39.20	0.28	3.74	±5	2017/4/9
2450	MSL	22.9	1.952	54.941	1.95	52.70	0.10	4.25	±5	2017/4/9
2600	HSL	22.3	1.970	38.700	1.96	39.00	0.51	-0.77	±5	2017/3/29
2600	HSL	22.5	2.027	39.813	1.96	39.00	3.42	2.08	±5	2017/4/21
2600	MSL	22.7	2.164	51.469	2.16	52.50	0.19	-1.96	±5	2017/3/21
2600	MSL	22.5	2.166	52.736	2.16	52.50	0.28	0.45	±5	2017/4/21
5250	HSL	22.6	4.717	37.312	4.71	35.95	0.15	3.79	±5	2017/4/13
5250	MSL	22.7	5.439	47.661	5.36	48.95	1.47	-2.63	±5	2017/4/6
5600	HSL	22.6	5.074	36.786	5.07	35.50	0.08	3.62	±5	2017/4/13
5600	MSL	22.7	5.895	47.057	5.77	48.50	2.17	-2.98	±5	2017/4/6
5750	HSL	22.6	5.236	36.587	5.22	35.35	0.31	3.50	±5	2017/4/13
5750	MSL	22.5	6.203	46.594	5.94	48.28	4.43	-3.49	±5	2017/4/8

10.3 System Performance Check Results

Comparing to the original SAR value provided by SPEAG, the verification data should be within its specification of 10 %. Below table shows the target SAR and measured SAR after normalized to 1W input power. The table below indicates the system performance check can meet the variation criterion and the plots can be referred to Appendix A of this report.

Date	Frequency (MHz)	Tissue Type	Input Power (mW)	Dipole S/N	Probe S/N	DAE S/N	Measured 1g SAR (W/kg)	Targeted 1g SAR (W/kg)	Normalized 1g SAR (W/kg)	Deviation (%)
2017/3/31	835	HSL	250	D835V2-4d200	EX3DV4 - SN3955	DAE4 Sn1399	2.31	9.39	9.24	-1.60
2017/3/23	835	MSL	250	D835V2-4d200	EX3DV4 - SN3925	DAE3 Sn495	2.47	9.65	9.88	2.38
2017/3/31	1750	HSL	250	D1750V2-1068	EX3DV4 - SN3955	DAE4 Sn1399	9.17	36.60	36.68	0.22
2017/3/23	1750	MSL	250	D1750V2-1068	EX3DV4 - SN3925	DAE3 Sn495	9.19	36.20	36.76	1.55
2017/3/30	1900	HSL	250	D1900V2-5d041	EX3DV4 - SN3955	DAE4 Sn1399	10.20	40.50	40.80	0.74
2017/3/22	1900	MSL	250	D1900V2-5d041	EX3DV4 - SN3925	DAE3 Sn495	10.00	38.80	40.00	3.09
2017/4/9	2450	HSL	250	D2450V2-736	EX3DV4 - SN3955	DAE4 Sn1399	14.10	53.10	56.40	6.21
2017/4/9	2450	MSL	250	D2450V2-736	EX3DV4 - SN3955	DAE4 Sn1399	13.60	52.10	54.40	4.41
2017/3/29	2600	HSL	250	D2600V2-1008	EX3DV4 - SN3976	DAE4 Sn1424	14.30	56.80	57.20	0.70
2017/4/21	2600	HSL	250	D2600V2-1008	ES3DV3 - SN3270	DAE4 Sn778	14.60	56.80	58.40	2.82
2017/3/21	2600	MSL	250	D2600V2-1008	EX3DV4 - SN3925	DAE3 Sn495	13.20	55.20	52.80	-4.35
2017/4/21	2600	MSL	250	D2600V2-1008	ES3DV3 - SN3270	DAE4 Sn778	14.20	55.20	56.80	2.90
2017/4/13	5250	HSL	100	D5GHzV2-1006	EX3DV4 - SN3931	DAE3 Sn577	7.92	80.60	79.20	-1.74
2017/4/6	5250	MSL	100	D5GHzV2-1006	EX3DV4 - SN3955	DAE4 Sn1399	7.79	75.50	77.90	3.18
2017/4/13	5600	HSL	100	D5GHzV2-1006	EX3DV4 - SN3931	DAE3 Sn577	8.80	83.80	88.00	5.01
2017/4/6	5600	MSL	100	D5GHzV2-1006	EX3DV4 - SN3955	DAE4 Sn1399	8.37	78.60	83.70	6.49
2017/4/13	5750	HSL	100	D5GHzV2-1006	EX3DV4 - SN3931	DAE3 Sn577	7.98	80.50	79.80	-0.87
2017/4/8	5750	MSL	100	D5GHzV2-1006	EX3DV4 - SN3955	DAE4 Sn1399	7.93	74.60	79.30	6.30

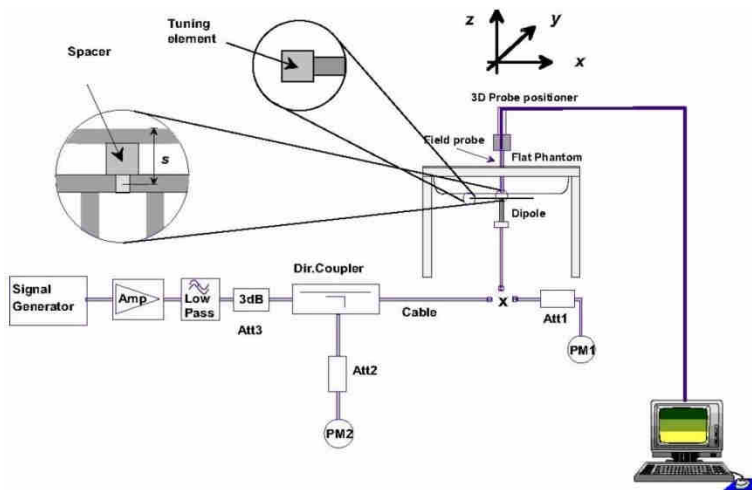

Fig 8.3.1 System Performance Check Setup



Fig 8.3.2 Setup Photo

11. RF Exposure Positions

11.1 Ear and handset reference point

Figure 9.1.1 shows the front, back, and side views of the SAM phantom. The center-of-mouth reference point is labeled “M,” the left ear reference point (ERP) is marked “LE,” and the right ERP is marked “RE.” Each ERP is 15 mm along the B-M (back-mouth) line behind the entrance-to-ear-canal (EEC) point, as shown in Figure 9.1.2 The Reference Plane is defined as passing through the two ear reference points and point M. The line N-F (neck-front), also called the reference pivoting line, is normal to the Reference Plane and perpendicular to both a line passing through RE and LE and the B-M line (see Figure 9.1.3). Both N-F and B-M lines should be marked on the exterior of the phantom shell to facilitate handset positioning. Posterior to the N-F line the ear shape is a flat surface with 6 mm thickness at each ERP, and forward of the N-F line the ear is truncated, as illustrated in Figure 9.1.2. The ear truncation is introduced to preclude the ear lobe from interfering with handset tilt, which could lead to unstable positioning at the cheek.

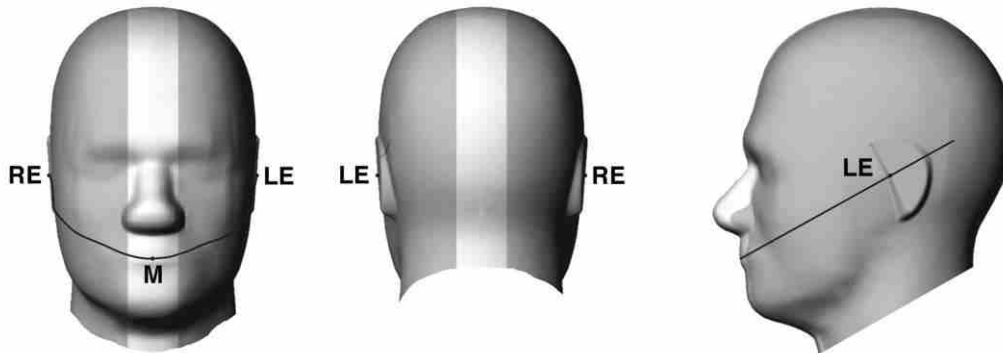

Fig 9.1.1 Front, back, and side views of SAM twin phantom

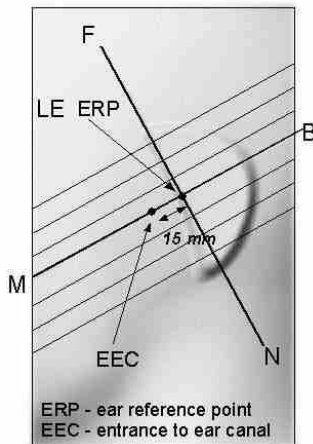

Fig 9.1.2 Close-up side view of phantom showing the ear region.

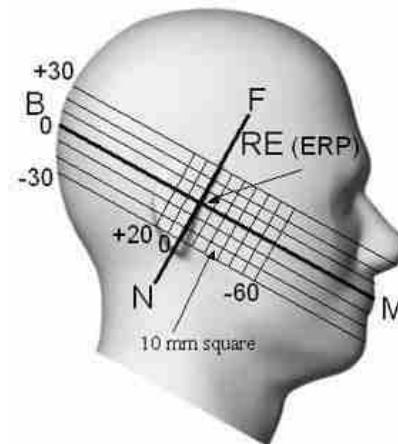

Fig 9.1.3 Side view of the phantom showing relevant markings and seven cross-sectional plane locations

11.2 Definition of the cheek position

1. Ready the handset for talk operation, if necessary. For example, for handsets with a cover piece (flip cover), open the cover. If the handset can transmit with the cover closed, both configurations must be tested.
2. Define two imaginary lines on the handset—the vertical centerline and the horizontal line. The vertical centerline passes through two points on the front side of the handset—the midpoint of the width w_t of the handset at the level of the acoustic output (point A in Figure 9.2.1 and Figure 9.2.2), and the midpoint of the width w_b of the bottom of the handset (point B). The horizontal line is perpendicular to the vertical centerline and passes through the center of the acoustic output (see Figure 9.2.1). The two lines intersect at point A. Note that for many handsets, point A coincides with the center of the acoustic output; however, the acoustic output may be located elsewhere on the horizontal line. Also note that the vertical centerline is not necessarily parallel to the front face of the handset (see Figure 9.2.2), especially for clamshell handsets, handsets with flip covers, and other irregularly-shaped handsets.
3. Position the handset close to the surface of the phantom such that point A is on the (virtual) extension of the line passing through points RE and LE on the phantom (see Figure 9.2.3), such that the plane defined by the vertical centerline and the horizontal line of the handset is approximately parallel to the sagittal plane of the phantom.
4. Translate the handset towards the phantom along the line passing through RE and LE until handset point A touches the pinna at the ERP.
5. While maintaining the handset in this plane, rotate it around the LE-RE line until the vertical centerline is in the plane normal to the plane containing B-M and N-F lines, i.e., the Reference Plane.
6. Rotate the handset around the vertical centerline until the handset (horizontal line) is parallel to the N-F line.
7. While maintaining the vertical centerline in the Reference Plane, keeping point A on the line passing through RE and LE, and maintaining the handset contact with the pinna, rotate the handset about the N-F line until any point on the handset is in contact with a phantom point below the pinna on the cheek. See Figure 9.2.3. The actual rotation angles should be documented in the test report.

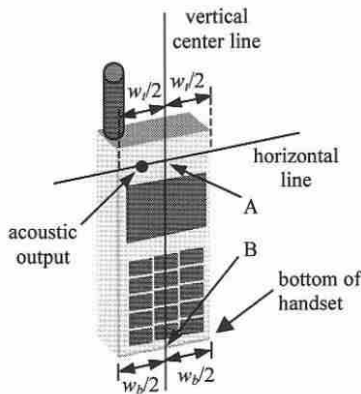

Fig 9.2.1 Handset vertical and horizontal reference lines—“fixed case”

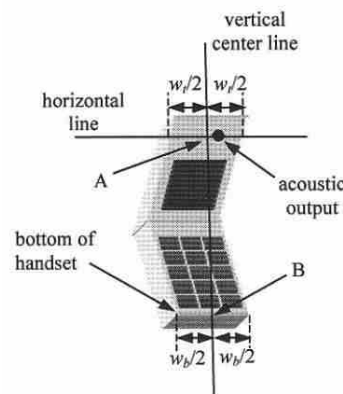

Fig 9.2.2 Handset vertical and horizontal reference lines—“clam-shell case”

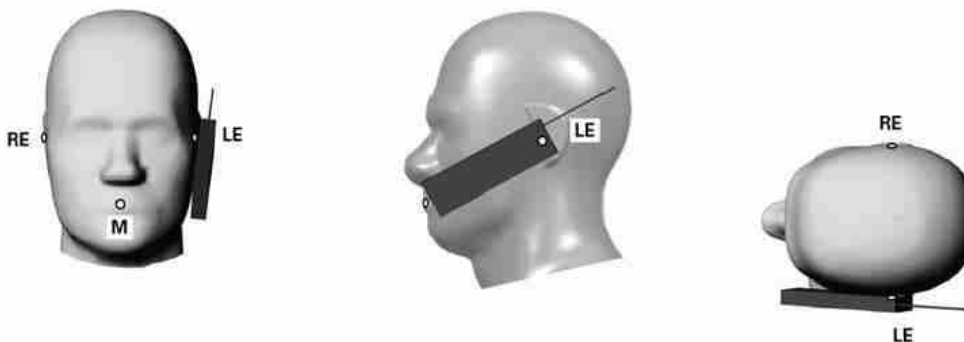

Fig 9.2.3 cheek or touch position. The reference points for the right ear (RE), left ear (LE), and mouth (M), which establish the Reference Plane for handset positioning, are indicated.

11.3 Definition of the tilt position

1. Ready the handset for talk operation, if necessary. For example, for handsets with a cover piece (flip cover), open the cover. If the handset can transmit with the cover closed, both configurations must be tested.
2. While maintaining the orientation of the handset, move the handset away from the pinna along the line passing through RE and LE far enough to allow a rotation of the handset away from the cheek by 15°.
3. Rotate the handset around the horizontal line by 15°.
4. While maintaining the orientation of the handset, move the handset towards the phantom on the line passing through RE and LE until any part of the handset touches the ear. The tilt position is obtained when the contact point is on the pinna. See Figure 9.3.1. If contact occurs at any location other than the pinna, e.g., the antenna at the back of the phantom head, the angle of the handset should be reduced. In this case, the tilt position is obtained if any point on the handset is in contact with the pinna and a second point

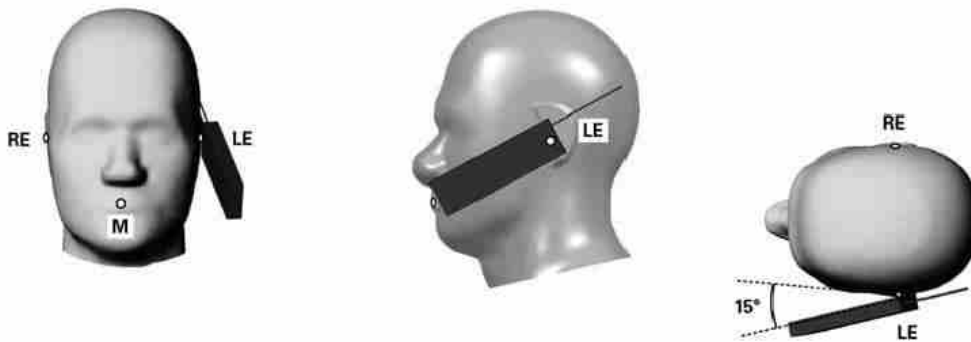

Fig 9.3.1 Tilt position. The reference points for the right ear (RE), left ear (LE), and mouth (M), which define the Reference Plane for handset positioning, are indicated.

11.4 Body Worn Accessory

Body-worn operating configurations are tested with the belt-clips and holsters attached to the device and positioned against a flat phantom in a normal use configuration (see Figure 9.4). Per KDB648474 D04v01r03, body-worn accessory exposure is typically related to voice mode operations when handsets are carried in body-worn accessories. The body-worn accessory procedures in FCC KDB 447498 D01v06 should be used to test for body-worn accessory SAR compliance, without a headset connected to it. This enables the test results for such configuration to be compatible with that required for hotspot mode when the body-worn accessory test separation distance is greater than or equal to that required for hotspot mode, when applicable. When the reported SAR for body-worn accessory, measured without a headset connected to the handset is > 1.2 W/kg, the highest reported SAR configuration for that wireless mode and frequency band should be repeated for that body-worn accessory with a handset attached to the handset.

Accessories for body-worn operation configurations are divided into two categories: those that do not contain metallic components and those that do contain metallic components. When multiple accessories that do not contain metallic components are supplied with the device, the device is tested with only the accessory that dictates the closest spacing to the body. Then multiple accessories that contain metallic components are test with the device with each accessory. If multiple accessories share an identical metallic component (i.e. the same metallic belt-chip used with different holsters with no other metallic components) only the accessory that dictates the closest spacing to the body is tested.

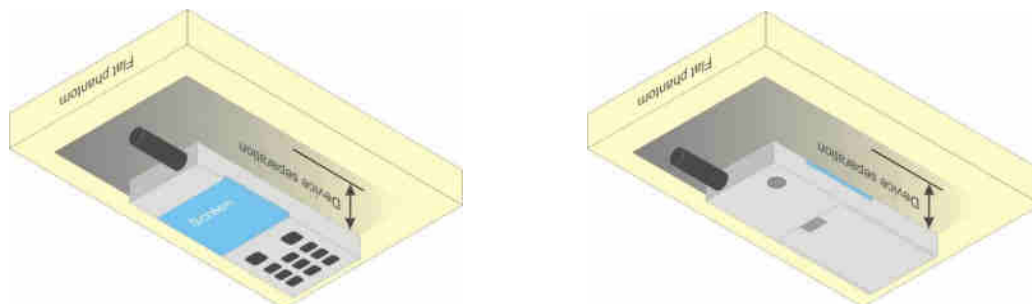

Fig 9.4 Body Worn Position



11.5 Wireless Router

Some battery-operated handsets have the capability to transmit and receive user through simultaneous transmission of WIFI simultaneously with a separate licensed transmitter. The FCC has provided guidance in FCC KDB Publication 941225 D06 v02r01 where SAR test considerations for handsets ($L \times W \geq 9 \text{ cm} \times 5 \text{ cm}$) are based on a composite test separation distance of 10mm from the front, back and edges of the device containing transmitting antennas within 2.5cm of their edges, determined from general mixed use conditions for this type of devices. Since the hotspot SAR results may overlap with the body-worn accessory SAR requirements, the more conservative configurations can be considered, thus excluding some body-worn accessory SAR tests.

When the user enables the personal wireless router functions for the handset, actual operations include simultaneous transmission of both the WIFI transmitter and another licensed transmitter. Both transmitters often do not transmit at the same transmitting frequency and thus cannot be evaluated for SAR under actual use conditions due to the limitations of the SAR assessment probes. Therefore, SAR must be evaluated for each frequency transmission and mode separately and spatially summed with the WIFI transmitter according to FCC KDB Publication 447498 D01v06 publication procedures. The "Portable Hotspot" feature on the handset was NOT activated during SAR assessments, to ensure the SAR measurements were evaluated for a single transmission frequency RF signal at a time.

11.6 Product Specific Exposure

For smart phones with a display diagonal dimension $> 15.0 \text{ cm}$ or an overall diagonal dimension $> 16.0 \text{ cm}$ that provide similar mobile web access and multimedia support found in mini-tablets or UMPC mini-tablets that support voice calls next to the ear, According to KDB648474 D04v01r03, the following phablet procedures should be applied to evaluate SAR compliance for each applicable wireless modes and frequency band. Devices marketed as phablets, regardless of form factors and operating characteristics must be tested as a phablet to determine SAR compliance

1. The normally required head and body-worn accessory SAR test procedures for handsets, including hotspot mode, must be applied.
2. The UMPC mini-tablet procedures must also be applied to test the SAR of all surfaces and edges with an antenna located at $\leq 25 \text{ mm}$ from that surface or edge, in direct contact with a flat phantom, for 10-g Product Specific SAR according to the body-equivalent tissue dielectric parameters in KDB 865664 to address interactive hand use exposure conditions.6 The UMPC mini-tablet 1-g SAR at 5 mm is not required. When hotspot mode applies, 10-g Product Specific SAR is required only for the surfaces and edges with hotspot mode 1-g reported SAR $> 1.2 \text{ W/kg}$.



12. Conducted RF Output Power (Unit: dBm)

<GSM Conducted Power>

- For DTM multi-slot class mode, the device was linked with base station simulator (Agilent E5515C) and transmit maximum power on maximum number of TX slots, i.e. one CS timeslot, and additional PS timeslots (1 for DTM class 5 and 9, 2 for DTM class 11) in one TDMA frame.
- Agilent E5515C was used to setup the device operated under DTM mode for power measurement and SAR testing. For conducted power, the power of the burst for voice and the power of the bursts for data was reported separately in the table above, and the frame-average power is derived below to determine SAR testing.

$$DTM \text{ frame average power (dBm)} = 10 * \log [\sum(\text{power of each slot, in mW})/8]$$

- Per KDB 447498 D01v06, the maximum output power channel is used for SAR testing and for further SAR test reduction.
- Per KDB 941225 D01v03r01, for SAR test reduction for GSM / GPRS / EDGE / DTM modes is determined by the source-based time-averaged output power including tune-up tolerance. The mode with highest specified time-averaged output power should be tested for SAR compliance in the applicable exposure conditions. For modes with the same specified maximum output power and tolerance, the higher number time-slot configuration should be tested. Therefore, the GPRS (4Tx slots) for GSM850/GSM1900 is considered as the primary mode.
- Other configurations of GSM / GPRS / EDGE / DTM are considered as secondary modes. The 3G SAR test reduction procedure is applied, when the maximum output power and tune-up tolerance specified for production units in a secondary mode is $\leq \frac{1}{4}$ dB higher than the primary mode, SAR measurement is not required for the secondary mode

GSM850		Burst Average Power (dBm)			Tune-up Limit (dBm)	Frame-Average Power (dBm)			Tune-up Limit (dBm)
TX Channel		128	189	251		128	189	251	
Frequency (MHz)		824.2	836.4	848.8		824.2	836.4	848.8	
GSM 1 Tx slot		32.39	32.38	32.38	33.50	23.39	23.38	23.38	24.50
GPRS 1 Tx slot		32.37	32.44	32.34	33.50	23.37	23.44	23.34	24.50
GPRS 2 Tx slots		29.73	29.70	29.63	30.50	23.73	23.70	23.63	24.50
GPRS 3 Tx slots		28.32	28.36	28.35	28.70	24.06	24.10	24.09	24.44
GPRS 4 Tx slots		26.85	26.92	26.91	27.50	23.85	23.92	23.91	24.50
EDGE 1 Tx slot		26.61	26.76	26.76	28.00	17.61	17.76	17.76	19.00
EDGE 2 Tx slots		23.40	23.54	23.56	25.00	17.40	17.54	17.56	19.00
EDGE 3 Tx slots		22.19	22.29	22.28	23.20	17.93	18.03	18.02	18.94
EDGE 4 Tx slots		20.88	21.05	21.08	22.00	17.88	18.05	18.08	19.00
DTM Multi-slot class 5	GSM 1 Tx slot	29.50	29.51	29.46	30.50	23.42	23.43	23.37	24.48
	GPRS 1 Tx slot	29.38	29.39	29.33	30.50				
DTM Multi-slot class 9	GSM 1 Tx slot	29.50	29.51	29.45	30.50	23.41	23.42	23.36	24.48
	GPRS 1 Tx slot	29.37	29.38	29.32	30.50				
DTM Multi-slot class 11	GSM 1 Tx slot	28.16	28.16	28.11	28.70	23.89	23.83	23.78	24.44
	GPRS 2 Tx slots	28.14	28.05	28.00	28.70				
DTM Multi-slot class 5	GSM 1 Tx slot	29.63	29.64	29.59	30.50	21.52	21.56	21.52	22.55
	EDGE 1 Tx slot	23.36	23.52	23.52	25.00				
DTM Multi-slot class 9	GSM 1 Tx slot	29.71	29.73	29.66	30.50	21.57	21.62	21.56	22.55
	EDGE 1 Tx slot	23.30	23.44	23.43	25.00				
DTM Multi-slot class 11	GSM 1 Tx slot	28.35	28.40	28.35	28.70	20.99	21.07	21.05	21.61
	EDGE 2 Tx slots	22.05	22.21	22.23	23.20				



GSM1900		Burst Average Power (dBm)			Tune-up Limit (dBm)	Frame-Average Power (dBm)			Tune-up Limit (dBm)
TX Channel		512	661	810		512	661	810	
Frequency (MHz)		1850.2	1880	1909.8		1850.2	1880	1909.8	
GSM 1 Tx slot		29.51	29.71	29.85	31.00	20.51	20.71	20.85	22.00
GPRS 1 Tx slot		29.58	29.70	29.85	31.00	20.58	20.70	20.85	22.00
GPRS 2 Tx slots		26.48	26.52	26.61	28.00	20.48	20.52	20.61	22.00
GPRS 3 Tx slots		25.28	25.36	25.38	26.20	21.02	21.10	21.12	21.94
GPRS 4 Tx slots		24.02	23.91	23.94	25.00	21.02	20.91	20.94	22.00
EDGE 1 Tx slot		25.35	25.43	25.53	27.00	16.35	16.43	16.53	18.00
EDGE 2 Tx slots		22.27	22.27	22.37	24.00	16.27	16.27	16.37	18.00
EDGE 3 Tx slots		21.14	21.23	21.27	22.20	16.88	16.97	17.01	17.94
EDGE 4 Tx slots		20.05	19.98	20.09	21.00	17.05	16.98	17.09	18.00
DTM Multi-slot class 5	GSM 1 Tx slot	26.44	26.50	26.60	28.00	20.39	20.45	20.55	21.98
	GPRS 1 Tx slot	26.39	26.45	26.55	28.00				
DTM Multi-slot class 9	GSM 1 Tx slot	26.43	26.52	26.61	28.00	20.38	20.46	20.56	21.98
	GPRS 1 Tx slot	26.38	26.45	26.56	28.00				
DTM Multi-slot class 11	GSM 1 Tx slot	25.30	25.34	25.33	26.20	20.99	21.03	21.02	21.94
	GPRS 2 Tx slots	25.23	25.27	25.25	26.20				
DTM Multi-slot class 5	GSM 1 Tx slot	26.42	26.49	26.59	28.00	18.80	18.86	18.95	20.42
	EDGE 1 Tx slot	22.27	22.28	22.37	24.00				
DTM Multi-slot class 9	GSM 1 Tx slot	26.44	26.50	26.61	28.00	18.81	18.86	18.96	20.42
	EDGE 1 Tx slot	22.24	22.26	22.35	24.00				
DTM Multi-slot class 11	GSM 1 Tx slot	25.27	25.35	25.37	26.20	18.74	18.80	18.83	19.71
	EDGE 2 Tx slots	21.18	21.21	21.26	22.20				

<WCDMA Conducted Power>

1. The following tests were conducted according to the test requirements outlines in 3GPP TS 34.121 specification.
2. The procedures in KDB 941225 D01v03r01 are applied for 3GPP Rel. 6 HSPA to configure the device in the required sub-test mode(s) to determine SAR test exclusion.
3. For DC-HSDPA, the device was configured according to the H-Set 12, Fixed Reference Channel (FRC) configuration in Table C.8.1.12 of 3GPP TS 34.121-1, with the primary and the secondary serving HS-DSCH Cell enabled during the power measurement.

A summary of these settings are illustrated below:

HSDPA Setup Configuration:

- a. The EUT was connected to Base Station Agilent E5515C referred to the Setup Configuration.
- b. The RF path losses were compensated into the measurements.
- c. A call was established between EUT and Base Station with following setting:
 - i. Set Gain Factors (β_c and β_d) and parameters were set according to each
 - ii. Specific sub-test in the following table, C10.1.4, quoted from the TS 34.121
 - iii. Set RMC 12.2Kbps + HSDPA mode.
 - iv. Set Cell Power = -86 dBm
 - v. Set HS-DSCH Configuration Type to FRC (H-set 1, QPSK)
 - vi. Select HSDPA Uplink Parameters
 - vii. Set Delta ACK, Delta NACK and Delta CQI = 8
 - viii. Set Ack-Nack Repetition Factor to 3
 - ix. Set CQI Feedback Cycle (k) to 4 ms
 - x. Set CQI Repetition Factor to 2
 - xi. Power Ctrl Mode = All Up bits
- d. The transmitted maximum output power was recorded.

Table C.10.1.4: β values for transmitter characteristics tests with HS-DPCCH

Sub-test	β_c	β_d	β_d (SF)	β_c/β_d	β_{HS} (Note 1, Note 2)	CM (dB) (Note 3)	MPR (dB) (Note 3)
1	2/15	15/15	64	2/15	4/15	0.0	0.0
2	12/15 (Note 4)	15/15 (Note 4)	64	12/15 (Note 4)	24/15	1.0	0.0
3	15/15	8/15	64	15/8	30/15	1.5	0.5
4	15/15	4/15	64	15/4	30/15	1.5	0.5

Note 1: Δ_{ACK} , Δ_{NACK} and $\Delta_{CQI} = 30/15$ with $\beta_{HS} = 30/15 * \beta_c$.

Note 2: For the HS-DPCCH power mask requirement test in clause 5.2C, 5.7A, and the Error Vector Magnitude (EVM) with HS-DPCCH test in clause 5.13.1A, and HSDPA EVM with phase discontinuity in clause 5.13.1AA, Δ_{ACK} and $\Delta_{NACK} = 30/15$ with $\beta_{HS} = 30/15 * \beta_c$, and $\Delta_{CQI} = 24/15$ with $\beta_{HS} = 24/15 * \beta_c$.

Note 3: CM = 1 for $\beta_c/\beta_d = 12/15$, $\beta_{HS}/\beta_c = 24/15$. For all other combinations of DPDCCH, DPCCH and HS-DPCCH the MPR is based on the relative CM difference. This is applicable for only UEs that support HSDPA in release 6 and later releases.

Note 4: For subtest 2 the β_c/β_d ratio of 12/15 for the TFC during the measurement period (TF1, TF0) is achieved by setting the signalled gain factors for the reference TFC (TF1, TF1) to $\beta_c = 11/15$ and $\beta_d = 15/15$.

Setup Configuration

HSUPA Setup Configuration:

- a. The EUT was connected to Base Station Agilent E5515C referred to the Setup Configuration.
- b. The RF path losses were compensated into the measurements.
- c. A call was established between EUT and Base Station with following setting * :
 - i. Call Configs = 5.2B, 5.9B, 5.10B, and 5.13.2B with QPSK
 - ii. Set the Gain Factors (β_c and β_d) and parameters (AG Index) were set according to each specific sub-test in the following table, C11.1.3, quoted from the TS 34.121
 - iii. Set Cell Power = -86 dBm
 - iv. Set Channel Type = 12.2k + HSPA
 - v. Set UE Target Power
 - vi. Power Ctrl Mode= Alternating bits
 - vii. Set and observe the E-TFCl
 - viii. Confirm that E-TFCl is equal to the target E-TFCl of 75 for sub-test 1, and other subtest's E-TFCl
- d. The transmitted maximum output power was recorded.

Table C.11.1.3: β values for transmitter characteristics tests with HS-DPCCH and E-DCH

Sub-test	β_c	β_d	β_d (SF)	β_c/β_d	β_{HS} (Note 1)	β_{ec}	β_{ed} (Note 5) (Note 6)	β_{ed} (SF)	β_{ed} (Codes)	CM (dB) (Note 2)	MPR (dB) (Note 2)	AG Index (Note 6)	E-TFCl
1	11/15 (Note 3)	15/15 (Note 3)	64	11/15 (Note 3)	22/15	209/225	1309/225	4	1	1.0	0.0	20	75
2	6/15	15/15	64	6/15	12/15	12/15	94/75	4	1	3.0	2.0	12	67
3	15/15	9/15	64	15/9	30/15	30/15	β_{ed1} : 47/15 β_{ed2} : 47/15	4 4	2	2.0	1.0	15	92
4	2/15	15/15	64	2/15	4/15	2/15	56/75	4	1	3.0	2.0	17	71
5	15/15 (Note 4)	15/15 (Note 4)	64	15/15 (Note 4)	30/15	24/15	134/15	4	1	1.0	0.0	21	81

Note 1: $\Delta_{ACK}, \Delta_{NACK}$ and $\Delta_{CQI} = 30/15$ with $\beta_{hs} = 30/15 * \beta_c$.

Note 2: CM = 1 for $\beta_c/\beta_d = 12/15, \beta_{hs}/\beta_c = 24/15$. For all other combinations of DPDCH, DPCCH, HS- DPCCH, E-DPDCH and E-DPCCH the MPR is based on the relative CM difference.

Note 3: For subtest 1 the β_c/β_d ratio of 11/15 for the TFC during the measurement period (TF1, TF0) is achieved by setting the signalled gain factors for the reference TFC (TF1, TF1) to $\beta_c = 10/15$ and $\beta_d = 15/15$.

Note 4: For subtest 5 the β_c/β_d ratio of 15/15 for the TFC during the measurement period (TF1, TF0) is achieved by setting the signalled gain factors for the reference TFC (TF1, TF1) to $\beta_c = 14/15$ and $\beta_d = 15/15$.

Note 5: In case of testing by UE using E-DPDCH Physical Layer category 1, Sub-test 3 is omitted according to TS25.306 Table 5.1g.

Note 6: β_{ed} can not be set directly, it is set by Absolute Grant Value.

Setup Configuration

DC-HSDPA 3GPP release 8 Setup Configuration:

- a. The EUT was connected to Base Station Agilent E5515C referred to the Setup Configuration below
- b. The RF path losses were compensated into the measurements.
- c. A call was established between EUT and Base Station with following setting:
 - i. Set RMC 12.2Kbps + HSDPA mode.
 - ii. Set Cell Power = -25 dBm
 - iii. Set HS-DSCH Configuration Type to FRC (H-set 12, QPSK)
 - iv. Select HSDPA Uplink Parameters
 - v. Set Gain Factors (β_c and β_d) and parameters were set according to each Specific sub-test in the following table, C10.1.4, quoted from the TS 34.121
 - a). Subtest 1: $\beta_c/\beta_d=2/15$
 - b). Subtest 2: $\beta_c/\beta_d=12/15$
 - c). Subtest 3: $\beta_c/\beta_d=15/8$
 - d). Subtest 4: $\beta_c/\beta_d=15/4$
 - vi. Set Delta ACK, Delta NACK and Delta CQI = 8
 - vii. Set Ack-Nack Repetition Factor to 3
 - viii. Set CQI Feedback Cycle (k) to 4 ms
 - ix. Set CQI Repetition Factor to 2
 - x. Power Ctrl Mode = All Up bits
- d. The transmitted maximum output power was recorded.

The following tests were conducted according to the test requirements outlines in 3GPP TS 34.121 specification. A summary of these settings are illustrated below:

C.8.1.12 Fixed Reference Channel Definition H-Set 12

Table C.8.1.12: Fixed Reference Channel H-Set 12

Parameter	Unit	Value
Nominal Avg. Inf. Bit Rate	kbps	60
Inter-TTI Distance	TTI's	1
Number of HARQ Processes	Processes	6
Information Bit Payload (N_{INF})	Bits	120
Number Code Blocks	Blocks	1
Binary Channel Bits Per TTI	Bits	960
Total Available SML's in UE	SML's	19200
Number of SML's per HARQ Proc.	SML's	3200
Coding Rate		0.15
Number of Physical Channel Codes	Codes	1
Modulation		QPSK
Note 1: The RMC is intended to be used for DC-HSDPA mode and both cells shall transmit with identical parameters as listed in the table. Note 2: Maximum number of transmission is limited to 1, i.e., retransmission is not allowed. The redundancy and constellation version 0 shall be used.		

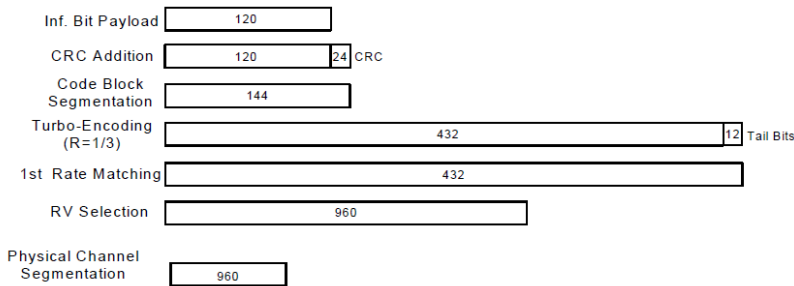

Figure C.8.19: Coding rate for Fixed reference Channel H-Set 12 (QPSK)

Setup Configuration



<WCDMA Conducted Power>

General Note:

1. Per KDB 941225 D01v03r01, for SAR testing is measured using a 12.2 kbps RMC with TPC bits configured to all "1's".
2. Per KDB 941225 D01v03r01, RMC 12.2kbps setting is used to evaluate SAR. The maximum output power and tune-up tolerance specified for production units in HSDPA / HSUPA / DC-HSDPA is $\leq \frac{1}{4}$ dB higher than RMC 12.2Kbps or when the highest reported SAR of the RMC12.2Kbps is scaled by the ratio of specified maximum output power and tune-up tolerance of HSDPA / HSUPA / DC-HSDPA to RMC12.2Kbps and the adjusted SAR is ≤ 1.2 W/kg, SAR measurement is not required for HSDPA / HSUPA / DC-HSDPA, and according to the following RF output power, the output power results of the secondary modes (HSUPA, HSDPA, DC-HSDPA) are less than $\frac{1}{4}$ dB higher than the primary modes; therefore, SAR measurement is not required for HSDPA / HSUPA / DC-HSDPA.

Band		WCDMA II			Tune-up Limit (dBm)	WCDMA V			Tune-up Limit (dBm)
TX Channel		9262	9400	9538		4132	4182	4233	
Rx Channel		9662	9800	9938		4357	4407	4458	
Frequency (MHz)		1852.4	1880	1907.6		826.4	836.4	846.6	
3GPP Rel 99	AMR 12.2Kbps	23.84	23.79	23.62	24.00	23.01	23.05	23.28	24.00
3GPP Rel 99	RMC 12.2Kbps	23.85	23.80	23.64	24.00	23.01	23.06	23.29	24.00
3GPP Rel 6	HSDPA Subtest-1	22.84	22.81	22.55	23.00	22.01	21.94	22.10	23.00
3GPP Rel 6	HSDPA Subtest-2	22.86	22.82	22.49	23.00	21.95	21.98	22.13	23.00
3GPP Rel 6	HSDPA Subtest-3	22.37	22.31	22.00	22.50	21.46	21.49	21.65	22.50
3GPP Rel 6	HSDPA Subtest-4	22.38	22.30	22.01	22.50	21.45	21.50	21.64	22.50
3GPP Rel 8	DC-HSDPA Subtest-1	22.82	22.79	22.53	23.00	21.98	21.92	22.08	23.00
3GPP Rel 8	DC-HSDPA Subtest-2	22.82	22.79	22.46	23.00	21.93	21.95	22.10	23.00
3GPP Rel 8	DC-HSDPA Subtest-3	22.35	22.30	21.97	22.50	21.44	21.47	21.63	22.50
3GPP Rel 8	DC-HSDPA Subtest-4	22.35	22.28	21.99	22.50	21.43	21.45	21.62	22.50
3GPP Rel 6	HSUPA Subtest-1	22.82	22.79	22.46	23.00	21.89	21.94	22.10	23.00
3GPP Rel 6	HSUPA Subtest-2	20.87	20.80	20.50	22.00	19.96	19.97	20.11	22.00
3GPP Rel 6	HSUPA Subtest-3	21.86	21.82	21.50	22.00	20.94	20.97	21.12	22.00
3GPP Rel 6	HSUPA Subtest-4	20.84	20.81	20.48	22.00	19.93	19.97	20.11	22.00
3GPP Rel 6	HSUPA Subtest-5	22.86	22.81	22.59	23.00	21.95	21.95	22.11	23.00



<LTE Conducted Power>

General Note:

2. Anritsu MT8820C base station simulator was used to setup the connection with EUT; the frequency band, channel bandwidth, RB allocation configuration, modulation type are set in the base station simulator to configure EUT transmitting at maximum power and at different configurations which are requested to be reported to FCC, for conducted power measurement and SAR testing.
3. Per KDB 941225 D05v02r05, when a properly configured base station simulator is used for the SAR and power measurements, spectrum plots for each RB allocation and offset configuration is not required.
4. Per KDB 941225 D05v02r05, start with the largest channel bandwidth and measure SAR for QPSK with 1 RB allocation, using the RB offset and required test channel combination with the highest maximum output power for RB offsets at the upper edge, middle and lower edge of each required test channel.
5. Per KDB 941225 D05v02r05, 50% RB allocation for QPSK SAR testing follows 1RB QPSK allocation procedure.
6. Per KDB 941225 D05v02r05, For QPSK with 100% RB allocation, SAR is not required when the highest maximum output power for 100 % RB allocation is less than the highest maximum output power in 50% and 1 RB allocations and the highest reported SAR for 1 RB and 50% RB allocation are ≤ 0.8 W/kg. Otherwise, SAR is measured for the highest output power channel; and if the reported SAR is > 1.45 W/kg, the remaining required test channels must also be tested.
7. Per KDB 941225 D05v02r05, 16QAM output power for each RB allocation configuration is $>$ not $\frac{1}{2}$ dB higher than the same configuration in QPSK and the reported SAR for the QPSK configuration is ≤ 1.45 W/kg; Per KDB 941225 D05v02r05, 16QAM SAR testing is not required.
8. Per KDB 941225 D05v02r05, Smaller bandwidth output power for each RB allocation configuration is $>$ not $\frac{1}{2}$ dB higher than the same configuration in the largest supported bandwidth, and the reported SAR for the largest supported bandwidth is ≤ 1.45 W/kg; Per KDB 941225 D05v02r05, smaller bandwidth SAR testing is not required.
9. For LTE B5 / B4 the maximum bandwidth does not support three non-overlapping channels, per KDB 941225 D05v02r05, when a device supports overlapping channel assignment in a channel bandwidth configuration, the middle channel of the group of overlapping channels should be selected for testing.
10. LTE band 38 SAR test was covered by Band 41; according to April 2015 TCB workshop, SAR test for overlapping LTE bands can be reduced if
 - c. the maximum output power, including tolerance, for the smaller band is \leq the larger band to qualify for the SAR test exclusion
 - d. the channel bandwidth and other operating parameters for the smaller band are fully supported by the larger band



<LTE Band 2>

BW [MHz]	Modulation	RB Size	RB Offset	Power Low Ch. / Freq.	Power Middle Ch. / Freq.	Power High Ch. / Freq.	Tune-up limit (dBm)	MPR (dB)
Channel				18700	18900	19100		
Frequency (MHz)				1860	1880	1900		
20	QPSK	1	0	23.68	23.51	23.42	24	0
20	QPSK	1	49	23.26	23.08	23.13		
20	QPSK	1	99	23.28	23.09	23.01		
20	QPSK	50	0	22.46	22.30	22.34	23	1
20	QPSK	50	24	22.38	22.19	22.25		
20	QPSK	50	50	22.33	22.15	22.06		
20	QPSK	100	0	22.40	22.23	22.15		
20	16QAM	1	0	22.98	22.80	22.73	23	1
20	16QAM	1	49	22.57	22.42	22.48		
20	16QAM	1	99	22.56	22.40	22.30		
20	16QAM	50	0	21.50	21.30	21.39	22	2
20	16QAM	50	24	21.38	21.23	21.31		
20	16QAM	50	50	21.30	21.15	21.11		
20	16QAM	100	0	21.35	21.20	21.19		
Channel				18675	18900	19125		
Frequency (MHz)				1857.5	1880	1902.5		
15	QPSK	1	0	23.49	23.29	23.34	24	0
15	QPSK	1	37	23.22	23.08	23.02		
15	QPSK	1	74	23.21	23.07	22.98		
15	QPSK	36	0	22.41	22.27	22.27	23	1
15	QPSK	36	20	22.37	22.18	22.11		
15	QPSK	36	39	22.28	22.16	22.07		
15	QPSK	75	0	22.34	22.22	22.13		
15	16QAM	1	0	22.78	22.62	22.65	23	1
15	16QAM	1	37	22.55	22.42	22.38		
15	16QAM	1	74	22.53	22.39	22.31		
15	16QAM	36	0	21.44	21.25	21.32	22	2
15	16QAM	36	20	21.38	21.19	21.14		
15	16QAM	36	39	21.32	21.12	21.07		
15	16QAM	75	0	21.37	21.19	21.12		
Channel				18650	18900	19150		
Frequency (MHz)				1855	1880	1905		
10	QPSK	1	0	23.59	23.37	23.24	24	0
10	QPSK	1	25	23.24	23.08	23.01		
10	QPSK	1	49	23.40	23.27	22.97		
10	QPSK	25	0	22.32	22.19	22.12	23	1
10	QPSK	25	12	22.29	22.12	22.06		
10	QPSK	25	25	22.28	22.12	22.04		
10	QPSK	50	0	22.32	22.16	22.06		
10	16QAM	1	0	22.86	22.72	22.54	23	1
10	16QAM	1	25	22.50	22.36	22.31		
10	16QAM	1	49	22.68	22.55	22.28		
10	16QAM	25	0	21.37	21.18	21.13	22	2
10	16QAM	25	12	21.34	21.18	21.09		
10	16QAM	25	25	21.26	21.12	21.04		
10	16QAM	50	0	21.35	21.15	21.10		



Channel				18625	18900	19175	Tune-up limit (dBm)	MPR (dB)
Frequency (MHz)				1852.5	1880	1907.5		
5	QPSK	1	0	23.31	23.14	23.07	24	0
5	QPSK	1	12	23.19	23.06	22.96		
5	QPSK	1	24	23.23	23.08	22.96		
5	QPSK	12	0	22.34	22.15	22.06	23	1
5	QPSK	12	7	22.30	22.14	22.06		
5	QPSK	12	13	22.26	22.10	22.04		
5	QPSK	25	0	22.29	22.13	22.05		
5	16QAM	1	0	22.64	22.47	22.44	23	1
5	16QAM	1	12	22.54	22.42	22.33		
5	16QAM	1	24	22.55	22.42	22.29		
5	16QAM	12	0	21.34	21.16	21.08	22	2
5	16QAM	12	7	21.36	21.14	21.11		
5	16QAM	12	13	21.32	21.13	21.03		
5	16QAM	25	0	21.30	21.13	21.05		
Channel				18615	18900	19185	Tune-up limit (dBm)	MPR (dB)
Frequency (MHz)				1851.5	1880	1908.5		
3	QPSK	1	0	23.26	23.10	23.00	24	0
3	QPSK	1	8	23.23	23.04	22.98		
3	QPSK	1	14	23.22	23.05	22.96		
3	QPSK	8	0	22.32	22.13	22.03	23	1
3	QPSK	8	4	22.31	22.14	22.02		
3	QPSK	8	7	22.24	22.12	21.99		
3	QPSK	15	0	22.27	22.13	22.03		
3	16QAM	1	0	22.57	22.44	22.33	23	1
3	16QAM	1	8	22.55	22.42	22.27		
3	16QAM	1	14	22.53	22.38	22.25		
3	16QAM	8	0	21.33	21.18	21.09	22	2
3	16QAM	8	4	21.36	21.20	21.13		
3	16QAM	8	7	21.33	21.16	21.06		
3	16QAM	15	0	21.32	21.12	21.05		
Channel				18607	18900	19193	Tune-up limit (dBm)	MPR (dB)
Frequency (MHz)				1850.7	1880	1909.3		
1.4	QPSK	1	0	23.20	23.02	22.92	24	0
1.4	QPSK	1	3	23.25	23.08	22.97		
1.4	QPSK	1	5	23.18	23.01	22.88		
1.4	QPSK	3	0	23.22	23.09	22.95		
1.4	QPSK	3	1	23.27	23.10	23.01		
1.4	QPSK	3	3	23.23	23.07	22.97		
1.4	QPSK	6	0	22.22	22.02	21.95	23	1
1.4	16QAM	1	0	22.50	22.32	22.21	23	1
1.4	16QAM	1	3	22.58	22.42	22.29		
1.4	16QAM	1	5	22.47	22.31	22.21		
1.4	16QAM	3	0	22.27	22.11	21.97		
1.4	16QAM	3	1	22.31	22.16	22.03		
1.4	16QAM	3	3	22.24	22.07	21.97		
1.4	16QAM	6	0	21.29	21.11	21.04	22	2



<LTE Band 4>

BW [MHz]	Modulation	RB Size	RB Offset	Power Low Ch. / Freq.	Power Middle Ch. / Freq.	Power High Ch. / Freq.	Tune-up limit (dBm)	MPR (dB)
Channel				20050	20175	20300		
Frequency (MHz)				1720	1732.5	1745		
20	QPSK	1	0	23.51	23.66	23.71	24	0
20	QPSK	1	49	23.35	23.42	23.44		
20	QPSK	1	99	23.49	23.33	23.40		
20	QPSK	50	0	22.49	22.55	22.62	23	1
20	QPSK	50	24	22.47	22.52	22.59		
20	QPSK	50	50	22.46	22.44	22.49		
20	QPSK	100	0	22.50	22.54	22.61		
20	16QAM	1	0	22.71	22.96	22.79	23	1
20	16QAM	1	49	22.66	22.65	22.67		
20	16QAM	1	99	22.75	22.49	22.73		
20	16QAM	50	0	21.49	21.57	21.59	22	2
20	16QAM	50	24	21.46	21.53	21.59		
20	16QAM	50	50	21.48	21.46	21.50		
20	16QAM	100	0	21.47	21.54	21.60		
Channel				20025	20175	20325		
Frequency (MHz)				1717.5	1732.5	1747.5		
15	QPSK	1	0	23.39	23.60	23.50	24	0
15	QPSK	1	37	23.27	23.37	23.42		
15	QPSK	1	74	23.45	23.33	23.43		
15	QPSK	36	0	22.42	22.60	22.64	23	1
15	QPSK	36	20	22.33	22.49	22.57		
15	QPSK	36	39	22.41	22.42	22.49		
15	QPSK	75	0	22.37	22.50	22.55		
15	16QAM	1	0	22.66	22.94	22.76	23	1
15	16QAM	1	37	22.60	22.69	22.72		
15	16QAM	1	74	22.74	22.55	22.76		
15	16QAM	36	0	21.47	21.62	21.65	22	2
15	16QAM	36	20	21.40	21.53	21.57		
15	16QAM	36	39	21.40	21.44	21.47		
15	16QAM	75	0	21.35	21.51	21.58		
Channel				20000	20175	20350		
Frequency (MHz)				1715	1732.5	1750		
10	QPSK	1	0	23.33	23.49	23.70	24	0
10	QPSK	1	25	23.30	23.40	23.55		
10	QPSK	1	49	23.34	23.37	23.48		
10	QPSK	25	0	22.40	22.52	22.65	23	1
10	QPSK	25	12	22.38	22.49	22.61		
10	QPSK	25	25	22.33	22.44	22.56		
10	QPSK	50	0	22.34	22.47	22.60		
10	16QAM	1	0	22.58	22.76	22.85	23	1
10	16QAM	1	25	22.57	22.65	22.80		
10	16QAM	1	49	22.65	22.52	22.79		
10	16QAM	25	0	21.37	21.53	21.64	22	2
10	16QAM	25	12	21.35	21.49	21.60		
10	16QAM	25	25	21.28	21.42	21.53		
10	16QAM	50	0	21.38	21.49	21.62		



Channel				19975	20175	20375	Tune-up limit (dBm)	MPR (dB)
Frequency (MHz)				1712.5	1732.5	1752.5		
5	QPSK	1	0	23.24	23.48	23.55	24	0
5	QPSK	1	12	23.18	23.40	23.46		
5	QPSK	1	24	23.28	23.38	23.48		
5	QPSK	12	0	22.21	22.47	22.56	23	1
5	QPSK	12	7	22.21	22.45	22.56		
5	QPSK	12	13	22.28	22.42	22.49		
5	QPSK	25	0	22.23	22.42	22.51		
5	16QAM	1	0	22.52	22.73	22.87	23	1
5	16QAM	1	12	22.47	22.65	22.82		
5	16QAM	1	24	22.55	22.57	22.82		
5	16QAM	12	0	21.24	21.49	21.56	22	2
5	16QAM	12	7	21.23	21.48	21.57		
5	16QAM	12	13	21.30	21.42	21.52		
5	16QAM	25	0	21.23	21.44	21.52		
Channel				19965	20175	20385	Tune-up limit (dBm)	MPR (dB)
Frequency (MHz)				1711.5	1732.5	1753.5		
3	QPSK	1	0	23.18	23.40	23.49	24	0
3	QPSK	1	8	23.15	23.37	23.46		
3	QPSK	1	14	23.25	23.36	23.47		
3	QPSK	8	0	22.21	22.43	22.50	23	1
3	QPSK	8	4	22.21	22.46	22.51		
3	QPSK	8	7	22.19	22.42	22.48		
3	QPSK	15	0	22.17	22.41	22.49		
3	16QAM	1	0	22.43	22.62	22.78	23	1
3	16QAM	1	8	22.44	22.63	22.80		
3	16QAM	1	14	22.53	22.55	22.76		
3	16QAM	8	0	21.26	21.48	21.56	22	2
3	16QAM	8	4	21.26	21.51	21.59		
3	16QAM	8	7	21.25	21.47	21.54		
3	16QAM	15	0	21.20	21.45	21.52		
Channel				19957	20175	20393	Tune-up limit (dBm)	MPR (dB)
Frequency (MHz)				1710.7	1732.5	1754.3		
1.4	QPSK	1	0	23.08	23.33	23.33	24	0
1.4	QPSK	1	3	23.15	23.37	23.41		
1.4	QPSK	1	5	23.06	23.32	23.33		
1.4	QPSK	3	0	23.14	23.40	23.38		
1.4	QPSK	3	1	23.19	23.43	23.44		
1.4	QPSK	3	3	23.16	23.38	23.36	23	1
1.4	QPSK	6	0	22.13	22.36	22.36		
1.4	16QAM	1	0	22.34	22.56	22.69	23	1
1.4	16QAM	1	3	22.42	22.62	22.74		
1.4	16QAM	1	5	22.35	22.53	22.66		
1.4	16QAM	3	0	22.18	22.40	22.42		
1.4	16QAM	3	1	22.22	22.43	22.44		
1.4	16QAM	3	3	22.16	22.38	22.38		
1.4	16QAM	6	0	21.22	21.42	21.44	22	2



<LTE Band 5>

BW [MHz]	Modulation	RB Size	RB Offset	Power Low Ch. / Freq.	Power Middle Ch. / Freq.	Power High Ch. / Freq.	Tune-up limit (dBm)	MPR (dB)
Channel				20450	20525	20600		
Frequency (MHz)				829	836.5	844		
10	QPSK	1	0	22.66	22.73	22.88	24.5	0
10	QPSK	1	25	22.51	22.64	22.71		
10	QPSK	1	49	22.58	22.62	22.81		
10	QPSK	25	0	21.58	21.65	21.84	23.5	1
10	QPSK	25	12	21.52	21.56	21.81		
10	QPSK	25	25	21.56	21.64	21.83		
10	QPSK	50	0	21.50	21.68	21.87		
10	16QAM	1	0	21.72	21.83	21.97	23.5	1
10	16QAM	1	25	21.73	21.92	22.02		
10	16QAM	1	49	21.90	21.94	22.10		
10	16QAM	25	0	20.55	20.63	20.80	22.5	2
10	16QAM	25	12	20.53	20.60	20.82		
10	16QAM	25	25	20.57	20.63	20.80		
10	16QAM	50	0	20.52	20.71	20.89		
Channel				20425	20525	20625	Tune-up limit (dBm)	MPR (dB)
Frequency (MHz)				826.5	836.5	846.5		
5	QPSK	1	0	22.55	22.54	22.82	24.5	0
5	QPSK	1	12	22.51	22.61	22.73		
5	QPSK	1	24	22.55	22.61	22.79		
5	QPSK	12	0	21.51	21.57	21.84	23.5	1
5	QPSK	12	7	21.52	21.66	21.82		
5	QPSK	12	13	21.51	21.65	21.85		
5	QPSK	25	0	21.50	21.63	21.78		
5	16QAM	1	0	21.71	21.87	22.10	23.5	1
5	16QAM	1	12	21.84	21.92	22.07		
5	16QAM	1	24	21.80	21.88	22.09		
5	16QAM	12	0	20.50	20.62	20.87	22.5	2
5	16QAM	12	7	20.56	20.68	20.83		
5	16QAM	12	13	20.55	20.67	20.88		
5	16QAM	25	0	20.52	20.66	20.79		
Channel				20415	20525	20635	Tune-up limit (dBm)	MPR (dB)
Frequency (MHz)				825.5	836.5	847.5		
3	QPSK	1	0	22.51	22.53	22.74	24.5	0
3	QPSK	1	8	22.52	22.58	22.81		
3	QPSK	1	14	22.51	22.57	22.78		
3	QPSK	8	0	21.55	21.55	21.90	23.5	1
3	QPSK	8	4	21.51	21.66	21.88		
3	QPSK	8	7	21.51	21.63	21.85		
3	QPSK	15	0	21.52	21.64	21.84		
3	16QAM	1	0	21.71	21.83	22.04	23.5	1
3	16QAM	1	8	21.73	21.90	22.09		
3	16QAM	1	14	21.82	21.87	22.05		
3	16QAM	8	0	20.50	20.60	20.93	22.5	2
3	16QAM	8	4	20.51	20.71	20.94		
3	16QAM	8	7	20.59	20.68	20.90		
3	16QAM	15	0	20.56	20.66	20.89		



Channel				20407	20525	20643	Tune-up limit (dBm)	MPR (dB)
Frequency (MHz)				824.7	836.5	848.3		
1.4	QPSK	1	0	22.56	22.55	22.76	24.5	0
1.4	QPSK	1	3	22.52	22.61	22.76		
1.4	QPSK	1	5	22.51	22.54	22.69		
1.4	QPSK	3	0	22.53	22.50	22.81		
1.4	QPSK	3	1	22.50	22.54	22.87		
1.4	QPSK	3	3	22.52	22.59	22.79		
1.4	QPSK	6	0	21.50	21.55	21.77	23.5	1
1.4	16QAM	1	0	21.66	21.75	22.04	23.5	1
1.4	16QAM	1	3	21.73	21.92	22.08		
1.4	16QAM	1	5	21.65	21.84	21.98		
1.4	16QAM	3	0	21.55	21.52	21.81		
1.4	16QAM	3	1	21.52	21.58	21.86		
1.4	16QAM	3	3	21.53	21.63	21.80		
1.4	16QAM	6	0	20.51	20.65	20.87	22.5	2



<LTE Band 7>

BW [MHz]	Modulation	RB Size	RB Offset	Power Low Ch. / Freq.	Power Middle Ch. / Freq.	Power High Ch. / Freq.	Tune-up limit (dBm)	MPR (dB)
Channel				20850	21100	21350		
Frequency (MHz)				2510	2535	2560		
20	QPSK	1	0	23.46	23.65	24.00	24.5	0
20	QPSK	1	49	23.23	23.51	23.81		
20	QPSK	1	99	23.35	23.59	23.88		
20	QPSK	50	0	22.41	22.66	23.00	23.5	1
20	QPSK	50	24	22.34	22.58	22.93		
20	QPSK	50	50	22.35	22.54	22.83		
20	QPSK	100	0	22.34	22.64	22.92		
20	16QAM	1	0	22.58	22.91	23.00	23.5	1
20	16QAM	1	49	22.53	22.83	22.99		
20	16QAM	1	99	22.72	22.96	22.95		
20	16QAM	50	0	21.39	21.57	21.90	22.5	2
20	16QAM	50	24	21.34	21.64	21.92		
20	16QAM	50	50	21.37	21.68	22.00		
20	16QAM	100	0	21.33	21.59	21.91		
Channel				20825	21100	21375	Tune-up limit (dBm)	MPR (dB)
Frequency (MHz)				2507.5	2535	2562.5		
15	QPSK	1	0	23.39	23.55	23.84	24.5	0
15	QPSK	1	37	23.31	23.49	23.77		
15	QPSK	1	74	23.45	23.62	23.91		
15	QPSK	36	0	22.45	22.52	22.91	23.5	1
15	QPSK	36	20	22.44	22.64	22.90		
15	QPSK	36	39	22.48	22.67	22.97		
15	QPSK	75	0	22.40	22.59	22.86		
15	16QAM	1	0	22.66	22.86	23.00	23.5	1
15	16QAM	1	37	22.63	22.80	22.89		
15	16QAM	1	74	22.75	22.93	22.95		
15	16QAM	36	0	21.49	21.54	21.94	22.5	2
15	16QAM	36	20	21.43	21.59	21.92		
15	16QAM	36	39	21.50	21.69	21.97		
15	16QAM	75	0	21.43	21.60	21.89		
Channel				20800	21100	21400	Tune-up limit (dBm)	MPR (dB)
Frequency (MHz)				2505	2535	2565		
10	QPSK	1	0	23.35	23.48	23.87	24.5	0
10	QPSK	1	25	23.34	23.55	23.90		
10	QPSK	1	49	23.34	23.61	23.91		
10	QPSK	25	0	22.30	22.58	22.88	23.5	1
10	QPSK	25	12	22.40	22.55	22.97		
10	QPSK	25	25	22.38	22.55	22.98		
10	QPSK	50	0	22.40	22.58	22.95		
10	16QAM	1	0	22.57	22.78	22.95	23.5	1
10	16QAM	1	25	22.62	22.80	22.99		
10	16QAM	1	49	22.59	22.90	23.00		
10	16QAM	25	0	21.33	21.58	21.86	22.5	2
10	16QAM	25	12	21.44	21.61	21.99		
10	16QAM	25	25	21.37	21.55	21.98		
10	16QAM	50	0	21.41	21.56	21.96		



Channel				20775	21100	21425	Tune-up limit (dBm)	MPR (dB)
Frequency (MHz)				2502.5	2535	2567.5		
5	QPSK	1	0	23.28	23.55	23.90	24.5	0
5	QPSK	1	12	23.24	23.50	23.89		
5	QPSK	1	24	23.31	23.48	23.89		
5	QPSK	12	0	22.32	22.58	22.94	23.5	1
5	QPSK	12	7	22.31	22.61	22.96		
5	QPSK	12	13	22.40	22.53	22.92		
5	QPSK	25	0	22.27	22.57	22.95		
5	16QAM	1	0	22.53	22.81	23.00	23.5	1
5	16QAM	1	12	22.51	22.79	22.95		
5	16QAM	1	24	22.59	22.77	22.94		
5	16QAM	12	0	21.31	21.57	21.97	22.5	2
5	16QAM	12	7	21.36	21.59	22.00		
5	16QAM	12	13	21.39	21.55	21.94		
5	16QAM	25	0	21.29	21.53	21.95		

<TDD LTE SAR Measurement>

TDD LTE configuration setup for SAR measurement

SAR was tested with a fixed periodic duty factor according to the highest transmission duty factor implemented for the device and supported by 3GPP.

- a. 3GPP TS 36.211 section 4.2 for Type 2 Frame Structure and Table 4.2-2 for uplink-downlink configurations
- b. "special subframe S" contains both uplink and downlink transmissions, it has been taken into consideration to determine the transmission duty factor according to the worst case uplink and downlink cyclic prefix requirements for UpPTS
- c. Establishing connections with base station simulators ensure a consistent means for testing SAR and recommended for evaluating SAR. The Anritsu MT8820C (firmware: #22.52#004) was used for LTE output power measurements and SAR testing.

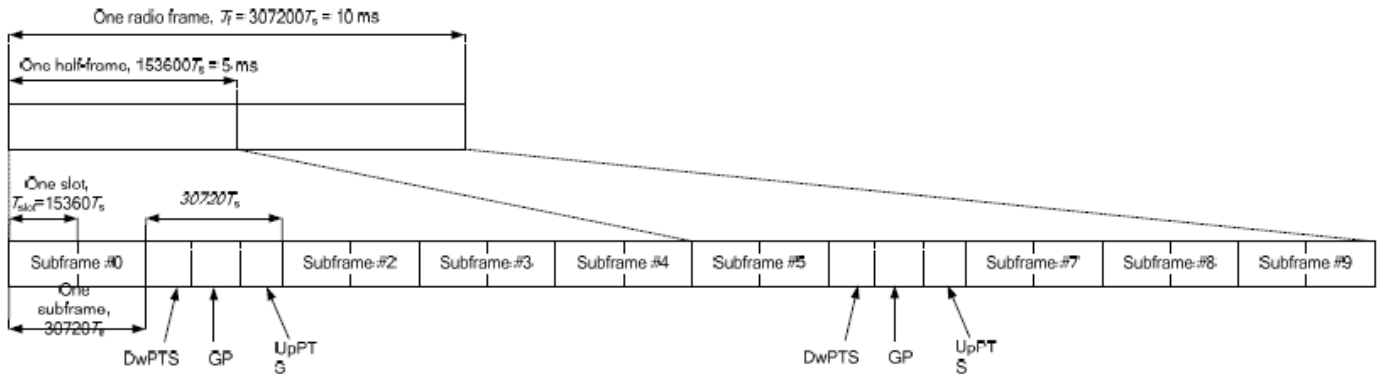

Figure 4.2-1: Frame structure type 2 (for 5 ms switch-point periodicity).

Table 4.2-2: Uplink-downlink configurations.

Uplink-downlink configuration	Downlink-to-Uplink Switch-point periodicity	Subframe number									
		0	1	2	3	4	5	6	7	8	9
0	5 ms	D	S	U	U	U	D	S	U	U	U
1	5 ms	D	S	U	U	D	D	S	U	U	D
2	5 ms	D	S	U	D	D	D	S	U	D	D
3	10 ms	D	S	U	U	U	D	D	D	D	D
4	10 ms	D	S	U	U	D	D	D	D	D	D
5	10 ms	D	S	U	D	D	D	D	D	D	D
6	5 ms	D	S	U	U	U	D	S	U	U	D

Table 4.2-1: Configuration of special subframe (lengths of DwPTS/GP/UpPTS).

Special subframe configuration	Normal cyclic prefix in downlink			Extended cyclic prefix in downlink				
	DwPTS	UpPTS		DwPTS	UpPTS			
		Normal cyclic prefix in uplink	Extended cyclic prefix in uplink		Normal cyclic prefix in uplink	Extended cyclic prefix in uplink		
0	6592 · Ts	2192 · Ts	2560 · Ts	7680 · Ts	2192 · Ts	2560 · Ts		
1	19760 · Ts			20480 · Ts				
2	21952 · Ts			23040 · Ts				
3	24144 · Ts			25600 · Ts				
4	26336 · Ts			7680 · Ts				
5	6592 · Ts	4384 · Ts	5120 · Ts	20480 · Ts	4384 · Ts	5120 · Ts		
6	19760 · Ts			23040 · Ts				
7	21952 · Ts			12800 · Ts				
8	24144 · Ts			-			-	-
9	13168 · Ts			-			-	-

Special subframe (30720·T_s): Normal cyclic prefix in downlink (UpPTS)			
	Special subframe configuration	Normal cyclic prefix in uplink	Extended cyclic prefix in uplink
Uplink duty factor in one special subframe	0~4	7.13%	8.33%
	5~9	14.3%	16.7%

Special subframe(30720·T_s): Extended cyclic prefix in downlink (UpPTS)			
	Special subframe configuration	Normal cyclic prefix in uplink	Extended cyclic prefix in uplink
Uplink duty factor in one special subframe	0~3	7.13%	8.33%
	4~7	14.3%	16.7%

The highest duty factor is resulted from:

- i. Uplink-downlink configuration: 0. In a half-frame consisted of 5 subframes, uplink operation is in 3 uplink subframes and 1 special subframe.
- ii. special subframe configuration: 5-9 for normal cyclic prefix in downlink, 4-7 for extended cyclic prefix in downlink
- iii. for special subframe with extended cyclic prefix in uplink, the total uplink duty factor in one half-frame is: $(3+0.167)/5 = 63.3\%$
- iv. for special subframe with normal cyclic prefix in uplink, the total uplink duty factor in one half-frame is: $(3+0.143)/5 = 62.9\%$
- v. For TDD LTE SAR measurement, the duty cycle 1:1.59 (62.9 %) was used perform testing and considering the theoretical duty cycle of 63.3% for extended cyclic prefix in the uplink, and the theoretical duty cycle of 62.9% for normal cyclic prefix in uplink, a scaling factor of extended cyclic prefix $63.3\%/62.9\% = 1.006$ is applied to scale-up the measured SAR result. The scaled TDD LTE SAR = measured SAR (W/kg)* Tune-up Scaling Factor* scaling factor for extended cyclic prefix.



<LTE Band 38>

BW [MHz]	Modulation	RB Size	RB Offset	Power Low Ch. / Freq.	Power Middle Ch. / Freq.	Power High Ch. / Freq.	Tune-up limit (dBm)	MPR (dB)
Channel				37850	38000	38150		
Frequency (MHz)				2580	2595	2610		
20	QPSK	1	0	23.96	23.92	24.00	24	0
20	QPSK	1	49	23.81	23.80	23.79		
20	QPSK	1	99	23.90	23.80	23.91		
20	QPSK	50	0	22.98	22.99	23.00	23	1
20	QPSK	50	24	22.97	22.95	22.97		
20	QPSK	50	50	22.94	22.89	22.95		
20	QPSK	100	0	22.99	22.95	23.00		
20	16QAM	1	0	23.00	22.91	22.98	23	1
20	16QAM	1	49	22.85	22.85	22.81		
20	16QAM	1	99	22.87	22.86	22.85		
20	16QAM	50	0	21.75	21.80	21.75	22	2
20	16QAM	50	24	21.76	21.72	21.70		
20	16QAM	50	50	21.67	21.67	21.79		
20	16QAM	100	0	21.71	21.74	21.69		
Channel				37825	38000	38175		
Frequency (MHz)				2577.5	2595	2612.5		
15	QPSK	1	0	23.98	23.99	23.89	24	0
15	QPSK	1	37	23.92	23.90	23.87		
15	QPSK	1	74	23.92	23.94	23.90		
15	QPSK	36	0	22.94	23.00	22.96	23	1
15	QPSK	36	20	23.00	22.96	22.97		
15	QPSK	36	39	22.93	22.93	23.00		
15	QPSK	75	0	23.00	22.94	22.96		
15	16QAM	1	0	22.95	22.97	22.94	23	1
15	16QAM	1	37	22.91	22.85	22.82		
15	16QAM	1	74	22.83	22.88	22.86		
15	16QAM	36	0	21.71	21.68	21.70	22	2
15	16QAM	36	20	21.73	21.65	21.68		
15	16QAM	36	39	21.67	21.62	21.73		
15	16QAM	75	0	21.73	21.65	21.68		
Channel				37800	38000	38200		
Frequency (MHz)				2575	2595	2615		
10	QPSK	1	0	23.90	23.86	23.75	24	0
10	QPSK	1	25	23.81	23.84	23.83		
10	QPSK	1	49	23.89	23.80	23.81		
10	QPSK	25	0	22.96	22.98	22.83	23	1
10	QPSK	25	12	22.96	22.93	22.92		
10	QPSK	25	25	22.98	22.91	22.88		
10	QPSK	50	0	22.96	22.92	22.92		
10	16QAM	1	0	22.93	22.90	22.78	23	1
10	16QAM	1	25	22.87	22.84	22.81		
10	16QAM	1	49	22.86	22.76	22.77		
10	16QAM	25	0	21.71	21.74	21.59	22	2
10	16QAM	25	12	21.69	21.73	21.70		
10	16QAM	25	25	21.70	21.65	21.63		
10	16QAM	50	0	21.67	21.69	21.66		



Channel				37775	38000	38225	Tune-up limit (dBm)	MPR (dB)
Frequency (MHz)				2572.5	2595	2617.5		
5	QPSK	1	0	23.88	23.85	23.82	24	0
5	QPSK	1	12	23.82	23.85	23.79		
5	QPSK	1	24	23.78	23.78	23.78		
5	QPSK	12	0	22.97	22.96	22.94	23	1
5	QPSK	12	7	22.98	22.96	22.97		
5	QPSK	12	13	22.93	22.96	22.94		
5	QPSK	25	0	22.95	22.94	22.91		
5	16QAM	1	0	22.88	22.84	22.78	23	1
5	16QAM	1	12	22.90	22.85	22.80		
5	16QAM	1	24	22.83	22.79	22.75		
5	16QAM	12	0	21.70	21.72	21.68	22	2
5	16QAM	12	7	21.75	21.75	21.74		
5	16QAM	12	13	21.70	21.69	21.67		
5	16QAM	25	0	21.72	21.69	21.68		



<LTE Band 41>

BW [MHz]	Modulation	RB Size	RB Offset	Power Low Ch. / Freq.	Power Low Middle Ch. / Freq.	Power Middle Ch. / Freq.	Power High Middle Ch. / Freq.	Power High Ch. / Freq.	Tune-up limit (dBm)	MPR (dB)
Channel				39750	40185	40620	41055	41490		
Frequency (MHz)				2506	2549.5	2593	2636.5	2680		
20	QPSK	1	0	22.96	23.00	23.34	23.58	23.26	24	0
20	QPSK	1	49	22.77	22.96	23.27	23.49	23.11		
20	QPSK	1	99	22.71	22.97	23.33	23.50	23.18		
20	QPSK	50	0	22.01	22.17	22.42	22.72	22.35	23	1
20	QPSK	50	24	21.95	22.16	22.41	22.71	22.33		
20	QPSK	50	50	21.81	22.04	22.41	22.56	22.29		
20	QPSK	100	0	21.95	22.14	22.46	22.70	22.35	23	1
20	16QAM	1	0	22.31	22.35	22.59	22.88	22.55		
20	16QAM	1	49	22.13	22.35	22.60	22.79	22.43		
20	16QAM	1	99	22.03	22.29	22.63	22.70	22.42	22	2
20	16QAM	50	0	21.05	21.19	21.44	21.71	21.40		
20	16QAM	50	24	20.95	21.18	21.54	21.73	21.37		
20	16QAM	50	50	20.86	21.08	21.54	21.63	21.37	22	2
20	16QAM	100	0	20.92	21.15	21.48	21.72	21.37		
Channel				39725	40173	40620	41068	41515	Tune-up limit (dBm)	MPR (dB)
Frequency (MHz)				2503.5	2548.3	2593	2637.8	2682.5		
15	QPSK	1	0	23.04	23.05	23.42	23.57	23.25	24	0
15	QPSK	1	37	22.93	22.97	23.35	23.43	23.20		
15	QPSK	1	74	22.70	22.98	23.40	23.48	23.19		
15	QPSK	36	0	21.99	22.08	22.37	22.70	22.34	23	1
15	QPSK	36	20	21.92	22.01	22.44	22.57	22.37		
15	QPSK	36	39	21.87	22.08	22.45	22.56	22.34		
15	QPSK	75	0	21.90	22.00	22.44	22.58	22.34	23	1
15	16QAM	1	0	22.22	22.30	22.65	22.82	22.49		
15	16QAM	1	37	22.07	22.25	22.62	22.72	22.42		
15	16QAM	1	74	21.98	22.19	22.64	22.69	22.45	22	2
15	16QAM	36	0	20.98	21.09	21.37	21.68	21.35		
15	16QAM	36	20	20.93	21.06	21.42	21.56	21.32		
15	16QAM	36	39	20.82	21.04	21.47	21.60	21.34	22	2
15	16QAM	75	0	20.98	21.08	21.45	21.59	21.38		
Channel				39700	40160	40620	41080	41540	Tune-up limit (dBm)	MPR (dB)
Frequency (MHz)				2501	2547	2593	2639	2685		
10	QPSK	1	0	22.85	22.83	23.25	23.57	23.18	24	0
10	QPSK	1	25	22.79	22.91	23.32	23.42	23.18		
10	QPSK	1	49	22.75	22.88	23.34	23.48	23.21		
10	QPSK	25	0	21.94	22.03	22.43	22.67	22.36	23	1
10	QPSK	25	12	21.95	22.02	22.46	22.60	22.34		
10	QPSK	25	25	21.87	22.03	22.38	22.54	22.34		
10	QPSK	50	0	21.93	21.99	22.40	22.59	22.33	23	1
10	16QAM	1	0	22.20	22.19	22.59	22.81	22.53		
10	16QAM	1	25	22.13	22.25	22.60	22.70	22.49		
10	16QAM	1	49	22.07	22.21	22.63	22.66	22.45	22	2
10	16QAM	25	0	21.02	21.08	21.49	21.74	21.40		
10	16QAM	25	12	20.99	21.05	21.51	21.67	21.40		
10	16QAM	25	25	20.92	21.06	21.40	21.58	21.37	22	2
10	16QAM	50	0	20.94	21.00	21.45	21.60	21.42		



Channel				39675	40148	40620	41093	41565	Tune-up limit (dBm)	MPR (dB)
Frequency (MHz)				2498.5	2545.8	2593	2640.30	2687.5		
5	QPSK	1	0	22.78	22.92	23.33	23.45	23.51	24	0
5	QPSK	1	12	22.77	22.88	23.25	23.42	23.51		
5	QPSK	1	24	22.69	22.81	23.23	23.39	23.44		
5	QPSK	12	0	21.97	22.05	22.44	22.59	22.82	23	1
5	QPSK	12	7	21.96	22.03	22.42	22.61	22.84		
5	QPSK	12	13	21.88	21.96	22.36	22.58	22.81		
5	QPSK	25	0	21.91	21.99	22.38	22.54	22.81		
5	16QAM	1	0	22.08	22.22	22.60	22.66	22.85	23	1
5	16QAM	1	12	22.08	22.22	22.59	22.67	22.91		
5	16QAM	1	24	22.03	22.16	22.54	22.67	22.87		
5	16QAM	12	0	20.99	21.06	21.46	21.61	21.88	22	2
5	16QAM	12	7	20.97	21.07	21.48	21.65	21.88		
5	16QAM	12	13	20.93	21.01	21.43	21.64	21.86		
5	16QAM	25	0	21.01	21.09	21.47	21.61	21.86		

**<WLAN Conducted Power>****General Note:**

1. For each antenna, transmit power in SISO operation is larger than (or equal to) the power in MIMO operation, RF exposure compliance of MIMO mode can be deduced from the compliance simultaneous transmission of antennas operating in SISO mode.
2. Per KDB 248227 D01v02r02, the simultaneous SAR provisions in KDB publication 447498 should be applied to determine simultaneous transmission SAR test exclusion for WiFi MIMO. If the sum of 1g single transmission chain SAR measurements is $< 1.6\text{W/kg}$ and SAR peak to location ratio ≤ 0.04 , no additional SAR measurements for MIMO.
3. Per KDB 248227 D01v02r02, SAR test reduction is determined according to 802.11 transmission mode configurations and certain exposure conditions with multiple test positions. In the 2.4 GHz band, separate SAR procedures are applied to DSSS and OFDM configurations to simplify DSSS test requirements. For OFDM, in both 2.4 and 5 GHz bands, an initial test configuration must be determined for each standalone and aggregated frequency band, according to the transmission mode configuration with the highest maximum output power specified for production units to perform SAR measurements. If the same highest maximum output power applies to different combinations of channel bandwidths, modulations and data rates, additional procedures are applied to determine which test configurations require SAR measurement. When applicable, an initial test position may be applied to reduce the number of SAR measurements required for next to the ear, UMPC mini-tablet or hotspot mode configurations with multiple test positions.
4. For 2.4 GHz 802.11b DSSS, either the initial test position procedure for multiple exposure test positions or the DSSS procedure for fixed exposure position is applied; these are mutually exclusive. For 2.4 GHz and 5 GHz OFDM configurations, the initial test configuration is applied to measure SAR using either the initial test position procedure for multiple exposure test position configurations or the initial test configuration procedures for fixed exposure test conditions. Based on the reported SAR of the measured configurations and maximum output power of the transmission mode configurations that are not included in the initial test configuration, the subsequent test configuration and initial test position procedures are applied to determine if SAR measurements are required for the remaining OFDM transmission configurations. In general, the number of test channels that require SAR measurement is minimized based on maximum output power measured for the test sample(s).
5. For OFDM transmission configurations in the 2.4 GHz and 5 GHz bands, When the same maximum power is specified for multiple transmission modes in a frequency band, the largest channel bandwidth, lowest order modulation, lowest data rate and lowest order 802.11a/g/n/ac mode is used for SAR measurement, on the highest measured output power channel for each frequency band.
6. DSSS and OFDM configurations are considered separately according to the required SAR procedures. SAR is measured in the initial test position using the 802.11 transmission mode configuration required by the DSSS procedure or initial test configuration and subsequent test configuration(s) according to the OFDM procedures.18 The initial test position procedure is described in the following:
 - a. When the reported SAR of the initial test position is $\leq 0.4\text{ W/kg}$, further SAR measurement is not required for the other test positions in that exposure configuration and 802.11 transmission mode combinations within the frequency band or aggregated band.
 - b. When the reported SAR of the test position is $> 0.4\text{ W/kg}$, SAR is repeated for the 802.11 transmission mode configuration tested in the initial test position to measure the subsequent next closet/smallest test separation distance and maximum coupling test position on the highest maximum output power channel, until the report SAR is $\leq 0.8\text{ W/kg}$ or all required test position are tested.
 - c. For all positions/configurations, when the reported SAR is $> 0.8\text{ W/kg}$, SAR is measured for these test positions/configurations on the subsequent next highest measured output power channel(s) until the reported SAR is $\leq 1.2\text{ W/kg}$ or all required channels are tested.



<Default Power Mode>

<2.4GHz WLAN ANT 1>

Mode	Channel	Frequency (MHz)	Average power (dBm)	Tune-Up Limit	Duty Cycle %
802.11b 1Mbps	1	2412	17.81	18.00	98.54
	6	2437	17.57	18.00	
	11	2462	17.53	18.00	
802.11g 6Mbps	1	2412	15.58	16.00	93.52
	6	2437	15.50	16.00	
	11	2462	15.67	16.00	
802.11n-HT20 MCS0	1	2412	15.51	16.00	93.07
	6	2437	15.75	16.00	
	11	2462	15.54	16.00	

<2.4GHz WLAN ANT 2>

Mode	Channel	Frequency (MHz)	Average power (dBm)	Tune-Up Limit	Duty Cycle %
802.11b 1Mbps	1	2412	17.74	18.00	99.03
	6	2437	17.62	18.00	
	11	2462	17.72	18.00	
802.11g 6Mbps	1	2412	15.72	16.00	93.52
	6	2437	15.69	16.00	
	11	2462	15.81	16.00	
802.11n-HT20 MCS0	1	2412	15.62	16.00	94.00
	6	2437	15.75	16.00	
	11	2462	15.70	16.00	

<2.4GHz WLAN ANT 1+2>

Mode	Channel	Frequency (MHz)	Average power (dBm)	Tune-Up Limit	Duty Cycle %
802.11b 1Mbps	1	2412	20.82	21.00	98.54
	6	2437	20.64	21.00	
	11	2462	20.73	21.00	
802.11g 6Mbps	1	2412	18.74	19.00	93.52
	6	2437	18.71	19.00	
	11	2462	18.96	19.00	
802.11n-HT20 MCS0	1	2412	18.69	19.00	93.07
	6	2437	18.96	19.00	
	11	2462	18.89	19.00	



<5GHz WLAN ANT1>

5.2GHz WLAN	Mode	Channel	Frequency (MHz)	Average power (dBm)	Tune-Up Limit	Duty Cycle %
	802.11a 6Mbps	36	5180	16.90	17.00	94.95
		40	5200	16.66	17.00	
		44	5220	16.77	17.00	
		48	5240	16.74	17.00	
	802.11n-HT20 MCS0	36	5180	16.77	17.00	94.15
		40	5200	16.66	17.00	
		44	5220	16.56	17.00	
		48	5240	16.64	17.00	
	802.11n-HT40 MCS0	38	5190	16.70	17.00	90.29
46		5230	16.64	17.00		
802.11ac-VHT20 MCS0	36	5180	15.78	16.00	94.18	
	40	5200	15.75	16.00		
	44	5220	15.72	16.00		
	48	5240	15.58	16.00		
802.11ac-VHT40 MCS0	38	5190	15.84	16.00	90.34	
	46	5230	15.62	16.00		
802.11ac-VHT80 MCS0	42	5210	14.69	15.00	81.56	

5.3GHz WLAN	Mode	Channel	Frequency (MHz)	Average power (dBm)	Tune-Up Limit	Duty Cycle %
	802.11a 6Mbps	52	5260	16.66	17.00	94.95
		56	5280	16.72	17.00	
		60	5300	16.82	17.00	
		64	5320	16.89	17.00	
	802.11n-HT20 MCS0	52	5260	16.84	17.00	94.15
		56	5280	16.75	17.00	
		60	5300	16.72	17.00	
		64	5320	16.71	17.00	
	802.11n-HT40 MCS0	54	5270	16.50	17.00	90.29
62		5310	16.54	17.00		
802.11ac-VHT20 MCS0	52	5260	15.51	16.00	94.18	
	56	5280	15.55	16.00		
	60	5300	15.56	16.00		
	64	5320	15.76	16.00		
802.11ac-VHT40 MCS0	54	5270	15.78	16.00	90.34	
	62	5310	15.79	16.00		
802.11ac-VHT80 MCS0	58	5290	14.52	15.00	81.56	



5.5GHz WLAN	Mode	Channel	Frequency (MHz)	Average power (dBm)	Tune-Up Limit	Duty Cycle %
	802.11a 6Mbps	100	5500	16.82	17.00	94.95
		116	5580	16.72	17.00	
		124	5620	16.70	17.00	
		132	5660	16.67	17.00	
		140	5700	16.64	17.00	
		144	5720	16.50	17.00	
	802.11n-HT20 MCS0	100	5500	16.71	17.00	94.15
		116	5580	16.80	17.00	
		124	5620	16.66	17.00	
132		5660	16.64	17.00		
140		5700	16.68	17.00		
802.11n-HT40 MCS0	102	5510	16.52	17.00	90.29	
	110	5550	16.50	17.00		
	126	5630	16.45	17.00		
	134	5670	16.51	17.00		
802.11ac-VHT20 MCS0	100	5500	15.63	16.00	94.18	
	116	5580	15.76	16.00		
	124	5620	15.70	16.00		
	132	5660	15.75	16.00		
	140	5700	15.55	16.00		
802.11ac-VHT40 MCS0	102	5510	15.89	16.00	90.34	
	110	5550	15.84	16.00		
	126	5630	15.60	16.00		
	134	5670	15.86	16.00		
802.11ac-VHT80 MCS0	106	5530	14.54	15.00	81.56	
	122	5610	14.50	15.00		
	138	5690	14.67	15.00		

5.8GHz WLAN	Mode	Channel	Frequency (MHz)	Average power (dBm)	Tune-Up Limit	Duty Cycle %
	802.11a MCS0	149	5745	16.72	17.00	94.95
		157	5785	16.68	17.00	
		165	5825	16.87	17.00	
	802.11n-HT20 MCS0	149	5745	16.61	17.00	94.15
		157	5785	16.62	17.00	
	802.11n-HT40 MCS0	149	5745	16.61	17.00	90.29
		157	5785	16.62	17.00	
	802.11ac-VHT20 MCS0	149	5745	15.59	16.00	94.18
		157	5785	15.91	16.00	
165		5825	15.71	16.00		
802.11ac-VHT40 MCS0	151	5755	15.69	16.00	90.34	
	159	5795	15.73	16.00		
802.11ac-VHT80 MCS0	155	5775	14.51	15.00	81.56	



<5GHz WLAN ANT2>

	Mode	Channel	Frequency (MHz)	Average power (dBm)	Tune-Up Limit	Duty Cycle %
5.2GHz WLAN	802.11a 6Mbps	36	5180	16.84	17.00	94.55
		40	5200	16.77	17.00	
		44	5220	16.76	17.00	
		48	5240	16.74	17.00	
	802.11n-HT20 MCS0	36	5180	16.74	17.00	94.15
		40	5200	16.70	17.00	
		44	5220	16.57	17.00	
		48	5240	16.61	17.00	
	802.11n-HT40 MCS0	38	5190	16.64	17.00	89.71
		46	5230	16.63	17.00	
	802.11ac-VHT20 MCS0	36	5180	15.69	16.00	94.63
		40	5200	15.50	16.00	
		44	5220	15.53	16.00	
		48	5240	15.63	16.00	
	802.11ac-VHT40 MCS0	38	5190	15.75	16.00	89.49
		46	5230	15.63	16.00	
802.11ac-VHT80 MCS0	42	5210	14.53	15.00	81.69	

	Mode	Channel	Frequency (MHz)	Average power (dBm)	Tune-Up Limit	Duty Cycle %
5.3GHz WLAN	802.11a 6Mbps	52	5260	16.64	17.00	94.55
		56	5280	16.70	17.00	
		60	5300	16.74	17.00	
		64	5320	16.75	17.00	
	802.11n-HT20 MCS0	52	5260	16.70	17.00	94.15
		56	5280	16.65	17.00	
		60	5300	16.51	17.00	
		64	5320	16.71	17.00	
	802.11n-HT40 MCS0	54	5270	16.57	17.00	89.71
		62	5310	16.63	17.00	
	802.11ac-VHT20 MCS0	52	5260	15.63	16.00	94.63
		56	5280	15.60	16.00	
		60	5300	15.67	16.00	
		64	5320	15.68	16.00	
	802.11ac-VHT40 MCS0	54	5270	15.62	16.00	89.49
		62	5310	15.73	16.00	
802.11ac-VHT80 MCS0	58	5290	14.62	15.00	81.69	



5.5GHz WLAN	Mode	Channel	Frequency (MHz)	Average power (dBm)	Tune-Up Limit	Duty Cycle %
	802.11a 6Mbps		100	5500	16.77	17.00
116			5580	16.76	17.00	
124			5620	16.70	17.00	
132			5660	16.58	17.00	
140			5700	16.53	17.00	
144			5720	16.50	17.00	
802.11n-HT20 MCS0		100	5500	16.72	17.00	94.15
		116	5580	16.70	17.00	
		124	5620	16.65	17.00	
		132	5660	16.62	17.00	
		140	5700	16.50	17.00	
		144	5720	16.70	17.00	
802.11n-HT40 MCS0		102	5510	16.72	17.00	89.71
		110	5550	16.71	17.00	
		126	5630	16.65	17.00	
		134	5670	16.70	17.00	
		142	5710	16.50	17.00	
		100	5500	15.72	16.00	
116	5580	15.67	16.00			
124	5620	15.70	16.00			
132	5660	15.65	16.00			
140	5700	15.74	16.00			
144	5720	15.66	16.00			
802.11ac-VHT20 MCS0		102	5510	15.83	16.00	89.49
		110	5550	15.50	16.00	
		126	5630	15.66	16.00	
		134	5670	15.80	16.00	
		142	5710	15.52	16.00	
		106	5530	14.63	15.00	
122	5610	14.61	15.00			
138	5690	14.58	15.00			

5.8GHz WLAN	Mode	Channel	Frequency (MHz)	Average power (dBm)	Tune-Up Limit	Duty Cycle %
	802.11a MCS0		149	5745	16.69	17.00
157			5785	16.74	17.00	
165			5825	16.83	17.00	
802.11n-HT20 MCS0		149	5745	16.64	17.00	94.15
		157	5785	16.67	17.00	
		165	5825	16.68	17.00	
802.11n-HT40 MCS0		151	5755	16.62	17.00	89.71
		159	5795	16.67	17.00	
802.11ac-VHT20 MCS0		149	5745	15.55	16.00	94.63
		157	5785	15.56	16.00	
		165	5825	15.70	16.00	
802.11ac-VHT40 MCS0		151	5755	15.73	16.00	89.49
		159	5795	15.67	16.00	
802.11ac-VHT80 MCS0		155	5775	14.74	15.00	81.69



<5GHz WLAN ANT1+2>

5.2GHz WLAN	Mode	Channel	Frequency (MHz)	Average power (dBm)	Tune-Up Limit	Duty Cycle %
	802.11a 6Mbps	36	5180	19.98	20.00	94.09
		40	5200	19.80	20.00	
		44	5220	19.85	20.00	
		48	5240	19.77	20.00	
	802.11n-HT20 MCS0	36	5180	19.89	20.00	93.69
		40	5200	19.70	20.00	
		44	5220	19.64	20.00	
		48	5240	19.65	20.00	
	802.11n-HT40 MCS0	38	5190	19.93	20.00	89.71
46		5230	19.65	20.00		
802.11ac-VHT20 MCS0	36	5180	18.85	19.00	93.95	
	40	5200	18.80	19.00		
	44	5220	18.79	19.00		
	48	5240	18.65	19.00		
802.11ac-VHT40 MCS0	38	5190	18.88	19.00	89.77	
	46	5230	18.84	19.00		
802.11ac-VHT80 MCS0	42	5210	17.79	18.00	79.86	

5.3GHz WLAN	Mode	Channel	Frequency (MHz)	Average power (dBm)	Tune-Up Limit	Duty Cycle %
	802.11a 6Mbps	52	5260	19.67	20.00	94.09
		56	5280	19.79	20.00	
		60	5300	19.85	20.00	
		64	5320	19.95	20.00	
	802.11n-HT20 MCS0	52	5260	19.95	20.00	93.69
		56	5280	19.80	20.00	
		60	5300	19.74	20.00	
		64	5320	19.82	20.00	
	802.11n-HT40 MCS0	54	5270	19.60	20.00	89.71
62		5310	19.88	20.00		
802.11ac-VHT20 MCS0	52	5260	18.67	19.00	93.95	
	56	5280	18.55	19.00		
	60	5300	18.71	19.00		
	64	5320	18.80	19.00		
802.11ac-VHT40 MCS0	54	5270	18.83	19.00	89.77	
	62	5310	18.85	19.00		
802.11ac-VHT80 MCS0	58	5290	17.73	18.00	79.86	



5.5GHz WLAN	Mode	Channel	Frequency (MHz)	Average power (dBm)	Tune-Up Limit	Duty Cycle %
	802.11a 6Mbps	100	5500	19.84	20.00	94.09
		116	5580	19.79	20.00	
		124	5620	19.75	20.00	
		132	5660	19.78	20.00	
		140	5700	19.65	20.00	
		144	5720	19.78	20.00	
802.11n-HT20 MCS0	100	5500	19.75	20.00	93.69	
	116	5580	19.87	20.00		
	124	5620	19.78	20.00		
	132	5660	19.77	20.00		
	140	5700	19.70	20.00		
	144	5720	19.98	20.00		
802.11n-HT40 MCS0	102	5510	19.77	20.00	89.71	
	110	5550	19.76	20.00		
	126	5630	19.70	20.00		
	134	5670	19.75	20.00		
	142	5710	19.81	20.00		
	100	5500	18.79	19.00		93.95
802.11ac-VHT20 MCS0	116	5580	18.83	19.00		
	124	5620	18.76	19.00		
	132	5660	18.75	19.00		
	140	5700	18.76	19.00		
	144	5720	18.94	19.00		
	802.11ac-VHT40 MCS0	102	5510	18.92	19.00	89.77
110		5550	18.89	19.00		
126		5630	18.70	19.00		
134		5670	18.91	19.00		
142		5710	18.73	19.00		
802.11ac-VHT80 MCS0		106	5530	17.77	18.00	
	122	5610	17.75	18.00		
	138	5690	17.79	18.00		

5.8GHz WLAN	Mode	Channel	Frequency (MHz)	Average power (dBm)	Tune-Up Limit	Duty Cycle %
	802.11a MCS0	149	5745	19.79	20.00	94.09
		157	5785	19.88	20.00	
		165	5825	19.90	20.00	
	802.11n-HT20 MCS0	149	5745	19.97	20.00	93.69
		157	5785	19.93	20.00	
		165	5825	19.72	20.00	
	802.11n-HT40 MCS0	151	5755	19.70	20.00	89.71
		159	5795	19.85	20.00	
	802.11ac-VHT20 MCS0	149	5745	18.78	19.00	93.95
		157	5785	18.96	19.00	
		165	5825	18.73	19.00	
	802.11ac-VHT40 MCS0	151	5755	18.74	19.00	89.77
		159	5795	18.76	19.00	
802.11ac-VHT80 MCS0	155	5775	17.77	18.00	79.86	



<Reduce Power Mode>

<2.4GHz WLAN ANT 1>

	Mode	Channel	Frequency (MHz)	Average power (dBm)	Tune-Up Limit	Duty Cycle %
2.4GHz WLAN	802.11b 1Mbps	1	2412	16.25	16.50	98.54
		6	2437	16.31	16.50	
		11	2462	16.21	16.50	
	802.11g 6Mbps	1	2412	15.58	16.00	93.52
		6	2437	15.50	16.00	
		11	2462	15.67	16.00	
	802.11n-HT20 MCS0	1	2412	15.51	16.00	93.07
		6	2437	15.75	16.00	
		11	2462	15.54	16.00	

<2.4GHz WLAN ANT 2>

	Mode	Channel	Frequency (MHz)	Average power (dBm)	Tune-Up Limit	Duty Cycle %
2.4GHz WLAN	802.11b 1Mbps	1	2412	16.34	16.50	99.03
		6	2437	16.33	16.50	
		11	2462	16.30	16.50	
	802.11g 6Mbps	1	2412	15.72	16.00	93.52
		6	2437	15.69	16.00	
		11	2462	15.81	16.00	
	802.11n-HT20 MCS0	1	2412	15.62	16.00	94.00
		6	2437	15.75	16.00	
		11	2462	15.70	16.00	

<2.4GHz WLAN ANT 1+2>

	Mode	Channel	Frequency (MHz)	Average power (dBm)	Tune-Up Limit	Duty Cycle %
2.4GHz WLAN	802.11b 1Mbps	1	2412	19.39	19.50	98.54
		6	2437	19.34	19.50	
		11	2462	19.45	19.50	
	802.11g 6Mbps	1	2412	18.74	19.00	93.52
		6	2437	18.71	19.00	
		11	2462	18.96	19.00	
	802.11n-HT20 MCS0	1	2412	18.69	19.00	93.07
		6	2437	18.96	19.00	
		11	2462	18.89	19.00	



<5GHz WLAN ANT1>

	Mode	Channel	Frequency (MHz)	Average power (dBm)	Tune-Up Limit	Duty Cycle %
5.2GHz WLAN	802.11a 6Mbps	36	5180	12.97	13.00	94.95
		40	5200	12.91	13.00	
		44	5220	12.87	13.00	
		48	5240	12.85	13.00	
	802.11n-HT20 MCS0	36	5180	12.98	13.00	94.15
		40	5200	12.87	13.00	
		44	5220	12.80	13.00	
		48	5240	12.79	13.00	
	802.11n-HT40 MCS0	38	5190	12.96	13.00	90.29
		46	5230	12.87	13.00	
	802.11ac-VHT20 MCS0	36	5180	12.99	13.00	94.18
		40	5200	12.86	13.00	
44		5220	12.81	13.00		
48		5240	12.80	13.00		
802.11ac-VHT40 MCS0	38	5190	12.79	13.00	90.34	
	46	5230	12.90	13.00		
802.11ac-VHT80 MCS0	42	5210	12.49	12.50	81.56	

	Mode	Channel	Frequency (MHz)	Average power (dBm)	Tune-Up Limit	Duty Cycle %
5.3GHz WLAN	802.11a 6Mbps	52	5260	12.92	13.00	94.95
		56	5280	12.86	13.00	
		60	5300	12.84	13.00	
		64	5320	12.97	13.00	
	802.11n-HT20 MCS0	52	5260	12.90	13.00	94.15
		56	5280	12.84	13.00	
		60	5300	12.76	13.00	
		64	5320	12.96	13.00	
	802.11n-HT40 MCS0	54	5270	12.77	13.00	90.29
		62	5310	12.75	13.00	
	802.11ac-VHT20 MCS0	52	5260	12.91	13.00	94.18
		56	5280	12.86	13.00	
60		5300	12.81	13.00		
64		5320	12.71	13.00		
802.11ac-VHT40 MCS0	54	5270	12.64	13.00	90.34	
	62	5310	12.71	13.00		
802.11ac-VHT80 MCS0	58	5290	12.34	12.50	81.56	



5.5GHz WLAN	Mode	Channel	Frequency (MHz)	Average power (dBm)	Tune-Up Limit	Duty Cycle %
	802.11a 6Mbps	100	5500	14.82	15.00	94.95
		116	5580	14.73	15.00	
		124	5620	14.71	15.00	
		132	5660	14.70	15.00	
		140	5700	14.67	15.00	
		144	5720	14.66	15.00	
802.11n-HT20 MCS0	100	5500	14.99	15.00	94.15	
	116	5580	14.96	15.00		
	124	5620	14.93	15.00		
	132	5660	14.91	15.00		
	140	5700	14.94	15.00		
	144	5720	14.92	15.00		
802.11n-HT40 MCS0	102	5510	14.97	15.00	90.29	
	110	5550	14.95	15.00		
	126	5630	14.83	15.00		
	134	5670	14.74	15.00		
	142	5710	14.78	15.00		
802.11ac-VHT20 MCS0	100	5500	14.78	15.00	94.18	
	116	5580	14.70	15.00		
	124	5620	14.72	15.00		
	132	5660	14.73	15.00		
	140	5700	14.74	15.00		
	144	5720	14.75	15.00		
802.11ac-VHT40 MCS0	102	5510	14.72	15.00	90.34	
	110	5550	14.73	15.00		
	126	5630	14.67	15.00		
	134	5670	14.61	15.00		
	142	5710	14.70	15.00		
802.11ac-VHT80 MCS0	106	5530	14.37	14.50	81.56	
	122	5610	14.41	14.50		
	138	5690	14.27	14.50		

5.8GHz WLAN	Mode	Channel	Frequency (MHz)	Average power (dBm)	Tune-Up Limit	Duty Cycle %
	802.11a MCS0	149	5745	13.44	13.50	94.95
		157	5785	13.49	13.50	
		165	5825	13.48	13.50	
	802.11n-HT20 MCS0	149	5745	13.33	13.50	94.15
		157	5785	13.44	13.50	
		165	5825	13.36	13.50	
	802.11n-HT40 MCS0	151	5755	13.32	13.50	90.29
		159	5795	13.38	13.50	
	802.11ac-VHT20 MCS0	149	5745	13.38	13.50	94.18
		157	5785	13.44	13.50	
		165	5825	13.36	13.50	
	802.11ac-VHT40 MCS0	151	5755	13.36	13.50	90.34
		159	5795	13.41	13.50	
802.11ac-VHT80 MCS0	155	5775	12.90	13.00	81.56	



<5GHz WLAN ANT2>

	Mode	Channel	Frequency (MHz)	Average power (dBm)	Tune-Up Limit	Duty Cycle %
5.2GHz WLAN	802.11a 6Mbps	36	5180	12.96	13.00	94.55
		40	5200	12.93	13.00	
		44	5220	12.94	13.00	
		48	5240	12.91	13.00	
	802.11n-HT20 MCS0	36	5180	12.96	13.00	94.15
		40	5200	12.79	13.00	
		44	5220	12.72	13.00	
		48	5240	12.67	13.00	
	802.11n-HT40 MCS0	38	5190	12.67	13.00	89.71
		46	5230	12.64	13.00	
	802.11ac-VHT20 MCS0	36	5180	12.97	13.00	94.63
		40	5200	12.75	13.00	
44		5220	12.74	13.00		
48		5240	12.69	13.00		
802.11ac-VHT40 MCS0	38	5190	12.54	13.00	89.49	
	46	5230	12.58	13.00		
802.11ac-VHT80 MCS0	42	5210	12.43	12.50	81.69	

	Mode	Channel	Frequency (MHz)	Average power (dBm)	Tune-Up Limit	Duty Cycle %
5.3GHz WLAN	802.11a 6Mbps	CH 52	5260	12.67	13.00	94.55
		56	5280	12.65	13.00	
		60	5300	12.61	13.00	
		64	5320	12.95	13.00	
	802.11n-HT20 MCS0	52	5260	12.80	13.00	94.15
		56	5280	12.64	13.00	
		60	5300	12.70	13.00	
		64	5320	12.82	13.00	
	802.11n-HT40 MCS0	54	5270	12.79	13.00	89.71
		62	5310	12.77	13.00	
	802.11ac-VHT20 MCS0	52	5260	12.86	13.00	94.63
		56	5280	12.82	13.00	
60		5300	12.84	13.00		
64		5320	12.79	13.00		
802.11ac-VHT40 MCS0	54	5270	12.66	13.00	89.49	
	62	5310	12.71	13.00		
802.11ac-VHT80 MCS0	58	5290	12.24	12.50	81.69	



5.5GHz WLAN	Mode	Channel	Frequency (MHz)	Average power (dBm)	Tune-Up Limit	Duty Cycle %
	802.11a 6Mbps	100	5500	14.64	15.00	94.55
		116	5580	14.60	15.00	
		124	5620	14.58	15.00	
		132	5660	14.56	15.00	
		140	5700	14.59	15.00	
		144	5720	14.60	15.00	
802.11n-HT20 MCS0	100	5500	14.98	15.00	94.15	
	116	5580	14.89	15.00		
	124	5620	14.87	15.00		
	132	5660	14.85	15.00		
	140	5700	14.88	15.00		
	144	5720	14.85	15.00		
802.11n-HT40 MCS0	102	5510	14.94	15.00	89.71	
	110	5550	14.92	15.00		
	126	5630	14.89	15.00		
	134	5670	14.87	15.00		
	142	5710	14.50	15.00		
802.11ac-VHT20 MCS0	100	5500	14.72	15.00	94.63	
	116	5580	14.68	15.00		
	124	5620	14.66	15.00		
	132	5660	14.65	15.00		
	140	5700	14.64	15.00		
	144	5720	14.86	15.00		
802.11ac-VHT40 MCS0	102	5510	14.60	15.00	89.49	
	110	5550	14.70	15.00		
	126	5630	14.65	15.00		
	134	5670	14.63	15.00		
	142	5710	14.52	15.00		
802.11ac-VHT80 MCS0	106	5530	14.38	14.50	81.69	
	122	5610	14.40	14.50		
	138	5690	14.08	14.50		

5.8GHz WLAN	Mode	Channel	Frequency (MHz)	Average power (dBm)	Tune-Up Limit	Duty Cycle %
	802.11a MCS0	149	5745	13.45	13.50	94.55
		157	5785	13.39	13.50	
		165	5825	13.44	13.50	
	802.11n-HT20 MCS0	149	5745	13.31	13.50	94.15
		157	5785	13.30	13.50	
		165	5825	13.27	13.50	
	802.11n-HT40 MCS0	151	5755	13.18	13.50	89.71
		159	5795	13.19	13.50	
	802.11ac-VHT20 MCS0	149	5745	13.33	13.50	94.63
		157	5785	13.26	13.50	
		165	5825	13.28	13.50	
	802.11ac-VHT40 MCS0	151	5755	13.18	13.50	89.49
		159	5795	13.25	13.50	
802.11ac-VHT80 MCS0	155	5775	12.98	13.00	81.69	



<5GHz WLAN ANT1+2>

	Mode	Channel	Frequency (MHz)	Average power (dBm)	Tune-Up Limit	Duty Cycle %
5.2GHz WLAN	802.11a 6Mbps	36	5180	15.70	16.00	94.09
		40	5200	15.43	16.00	
		44	5220	15.36	16.00	
		48	5240	15.28	16.00	
	802.11n-HT20 MCS0	36	5180	15.89	16.00	93.69
		40	5200	15.70	16.00	
		44	5220	15.54	16.00	
		48	5240	15.52	16.00	
	802.11n-HT40 MCS0	38	5190	15.87	16.00	89.71
		46	5230	15.85	16.00	
	802.11ac-VHT20 MCS0	36	5180	15.90	16.00	93.95
		40	5200	15.67	16.00	
44		5220	15.55	16.00		
48		5240	15.53	16.00		
802.11ac-VHT40 MCS0	38	5190	15.73	16.00	89.77	
	46	5230	15.85	16.00		
802.11ac-VHT80 MCS0	42	5210	15.20	15.50	79.86	

	Mode	Channel	Frequency (MHz)	Average power (dBm)	Tune-Up Limit	Duty Cycle %
5.3GHz WLAN	802.11a 6Mbps	52	5260	15.39	16.00	94.09
		56	5280	15.35	16.00	
		60	5300	15.31	16.00	
		64	5320	15.94	16.00	
	802.11n-HT20 MCS0	52	5260	15.44	16.00	93.69
		56	5280	15.38	16.00	
		60	5300	15.32	16.00	
		64	5320	15.79	16.00	
	802.11n-HT40 MCS0	54	5270	15.97	16.00	89.71
		62	5310	15.93	16.00	
	802.11ac-VHT20 MCS0	52	5260	15.62	16.00	93.95
		56	5280	15.58	16.00	
60		5300	15.57	16.00		
64		5320	15.82	16.00		
802.11ac-VHT40 MCS0	54	5270	15.80	16.00	89.77	
	62	5310	15.78	16.00		
802.11ac-VHT80 MCS0	58	5290	15.21	15.50	79.86	



5.5GHz WLAN	Mode	Channel	Frequency (MHz)	Average power (dBm)	Tune-Up Limit	Duty Cycle %
	802.11a 6Mbps	100	5500	17.83	18.00	94.09
		116	5580	17.71	18.00	
		124	5620	17.58	18.00	
		132	5660	17.65	18.00	
		140	5700	17.47	18.00	
		144	5720	17.53	18.00	
802.11n-HT20 MCS0	100	5500	17.73	18.00	93.69	
	116	5580	17.68	18.00		
	124	5620	17.64	18.00		
	132	5660	17.55	18.00		
	140	5700	17.52	18.00		
	144	5720	17.60	18.00		
802.11n-HT40 MCS0	102	5510	17.70	18.00	89.71	
	110	5550	17.64	18.00		
	126	5630	17.62	18.00		
	134	5670	17.61	18.00		
	142	5710	17.64	18.00		
802.11ac-VHT20 MCS0	100	5500	17.74	18.00	93.95	
	116	5580	17.75	18.00		
	124	5620	17.70	18.00		
	132	5660	17.64	18.00		
	140	5700	17.60	18.00		
	144	5720	17.63	18.00		
802.11ac-VHT40 MCS0	102	5510	17.76	18.00	89.77	
	110	5550	17.75	18.00		
	126	5630	17.76	18.00		
	134	5670	17.83	18.00		
	142	5710	17.84	18.00		
802.11ac-VHT80 MCS0	106	5530	17.07	17.50	79.86	
	122	5610	17.23	17.50		
	138	5690	17.29	17.50		

5.8GHz WLAN	Mode	Channel	Frequency (MHz)	Average power (dBm)	Tune-Up Limit	Duty Cycle %
	802.11a MCS0	149	5745	16.47	16.50	94.09
		157	5785	16.35	16.50	
		165	5825	16.49	16.50	
	802.11n-HT20 MCS0	149	5745	16.48	16.50	93.69
		157	5785	16.39	16.50	
		165	5825	16.49	16.50	
	802.11n-HT40 MCS0	151	5755	16.20	16.50	89.71
		159	5795	16.08	16.50	
	802.11ac-VHT20 MCS0	149	5745	16.46	16.50	93.95
		157	5785	16.41	16.50	
		165	5825	16.48	16.50	
	802.11ac-VHT40 MCS0	151	5755	16.21	16.50	89.77
		159	5795	16.02	16.50	
802.11ac-VHT80 MCS0	155	5775	15.72	16.00	79.86	



13. Bluetooth Exclusions Applied

Mode Band	Average power(dBm)	
	Bluetooth-BR/EDR	Bluetooth-LE
2.4GHz Bluetooth	11.5	1.5

Note:

- Per KDB 447498 D01v06, the 1-g and 10-g SAR test exclusion thresholds for 100 MHz to 6 GHz at *test separation distances* ≤ 50 mm are determined by:

$$[(\text{max. power of channel, including tune-up tolerance, mW}) / (\text{min. test separation distance, mm})] \cdot [\sqrt{f(\text{GHz})}] \leq 3.0$$
for 1-g SAR and ≤ 7.5 for 10-g Product Specific SAR
 - f(GHz) is the RF channel transmit frequency in GHz
 - Power and distance are rounded to the nearest mW and mm before calculation
 - The result is rounded to one decimal place for comparison

Bluetooth Max Power (dBm)	Separation Distance (mm)	Frequency (GHz)	exclusion thresholds
11.5	15	2.48	1.47

Note:

Per KDB 447498 D01v06, when the minimum test separation distance is 15 mm which is applied to determine SAR test exclusion. The test exclusion threshold is 1.47 which is ≤ 3, SAR testing is not required.

14. Antenna Location

<Mobile Phone>

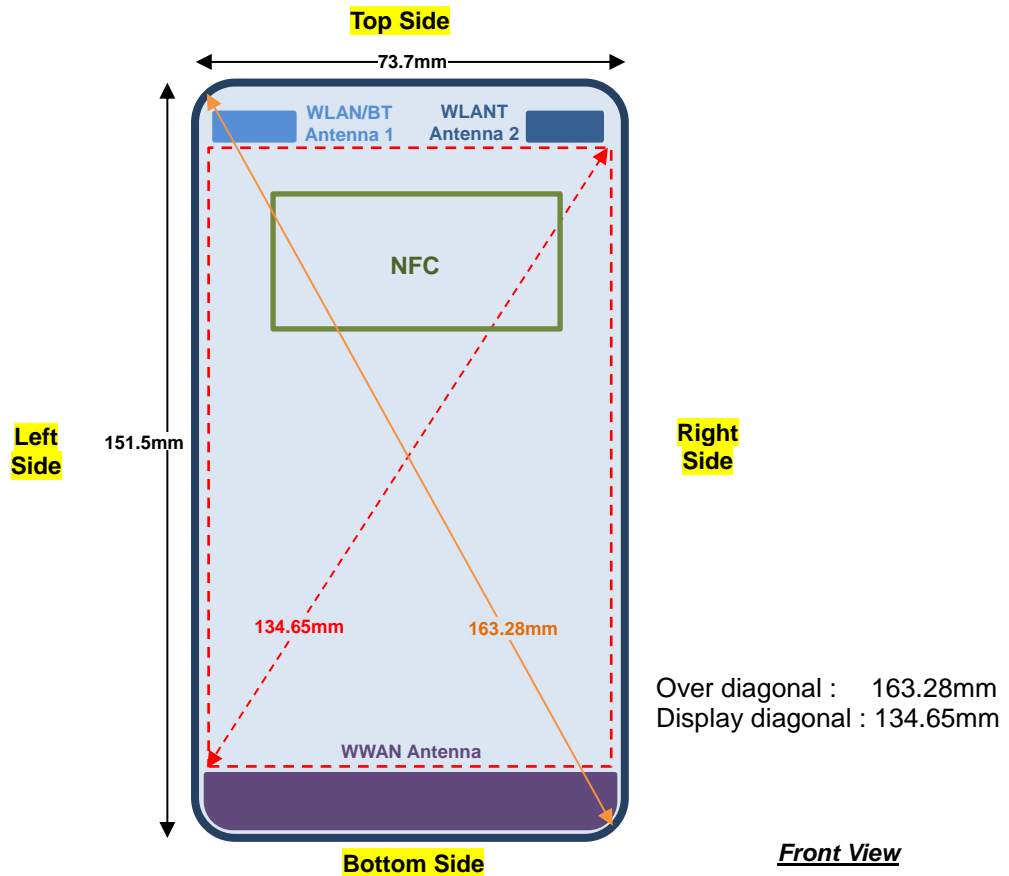

Distance of the Antenna to the EUT surface/edge						
Antennas	Back	Front	Top Side	Bottom Side	Right Side	Left Side
WWAN Antenna	≤ 25mm	≤ 25mm	>25 mm	≤ 25mm	≤ 25mm	≤ 25mm
BT&WLAN Antenna 1	≤ 25mm	≤ 25mm	≤ 25mm	>25 mm	>25 mm	≤ 25mm
WLAN Antenna 2	≤ 25mm	≤ 25mm	≤ 25mm	>25 mm	≤ 25mm	>25 mm

Positions for SAR tests; Hotspot mode						
Antennas	Back	Front	Top Side	Bottom Side	Right Side	Left Side
WWAN Antenna	Yes	Yes	No	Yes	Yes	Yes
BT&WLAN Antenna 1	Yes	Yes	Yes	No	No	Yes
WLAN Antenna 2	Yes	Yes	Yes	No	Yes	No

General Note:

- Referring to KDB 941225 D06 v02r01, when the overall device length and width are ≥ 9cm*5cm, the test distance is 10 mm. SAR must be measured for all sides and surfaces with a transmitting antenna located within 25mm from that surface or edge



15. SAR Test Results

General Note:

1. Per KDB 447498 D01v06, the reported SAR is the measured SAR value adjusted for maximum tune-up tolerance.
 - a. Tune-up scaling Factor = tune-up limit power (mW) / EUT RF power (mW), where tune-up limit is the maximum rated power among all production units.
 - b. For SAR testing of WLAN signal with non-100% duty cycle, the measured SAR is scaled-up by the duty cycle scaling factor which is equal to "1/(duty cycle)"
 - c. For WWAN: Reported SAR(W/kg)= Measured SAR(W/kg)*Tune-up Scaling Factor
 - d. For WLAN: Reported SAR(W/kg)= Measured SAR(W/kg)* Duty Cycle scaling factor * Tune-up scaling factor
 - e. For TDD LTE SAR measurement, the duty cycle 1:1.59 (62.9 %) was used perform testing and considering the theoretical duty cycle of 63.3% for extended cyclic prefix in the uplink, and the theoretical duty cycle of 62.9% for normal cyclic prefix in uplink, a scaling factor of extended cyclic prefix 63.3%/62.9% = 1.006 is applied to scale-up the measured SAR result. The Reported TDD LTE SAR = measured SAR (W/kg) * Tune-up Scaling Factor* scaling factor for extended cyclic prefix.
2. Per KDB 447498 D01v06, for each exposure position, testing of other required channels within the operating mode of a frequency band is not required when the *reported* 1-g or 10-g SAR for the mid-band or highest output power channel is:
 - ≤ 0.8 W/kg or 2.0 W/kg, for 1-g or 10-g respectively, when the transmission band is ≤ 100 MHz
 - ≤ 0.6 W/kg or 1.5 W/kg, for 1-g or 10-g respectively, when the transmission band is between 100 MHz and 200 MHz
 - ≤ 0.4 W/kg or 1.0 W/kg, for 1-g or 10-g respectively, when the transmission band is ≥ 200 MHz
3. Per KDB 865664 D01v01r04, for each frequency band, repeated SAR measurement is required only when the measured SAR is ≥ 0.8 W/kg.
4. Per KDB 648474 D04v01r03, when the reported SAR for a body-worn accessory measured without a headset connected to the handset is ≤ 1.2 W/kg, SAR testing with a headset connected to the handset is not required.
5. Per KDB648474 D04v01r03, for smart phones with a display diagonal dimension > 15.0 cm or an overall diagonal dimension > 16.0 cm, when hotspot mode applies, 10-g Product Specific SAR is required only for the surfaces and edges with hotspot mode 1-g reported SAR > 1.2 W/kg, however, when power reduction applies to hotspot mode the measured SAR must be scaled to the maximum output power, including tolerance, allowed for phablet modes to compare with the 1.2 W/kg SAR test reduction threshold.
6. For 5.3GHz / 5.5GHz WLAN product specific SAR is necessary, due to an overall diagonal dimension is > 16cm.
7. Power reduction for head exposure conditions of WLAN transmitter :

Once the voice call or VoIP call (either through WWAN bearer, or WLAN bearer) is established, upper layer will determine whether the audio is actively routed through the earpiece receiver. If yes, and will notify the WLAN side to enter the reduced power for WLAN.

GSM Note:

1. Per KDB 941225 D01v03r01, for SAR test reduction for GSM / GPRS / EDGE / DTM modes is determined by the source-based time-averaged output power including tune-up tolerance. The mode with highest specified time-averaged output power should be tested for SAR compliance in the applicable exposure conditions. For modes with the same specified maximum output power and tolerance, the higher number time-slot configuration should be tested. Therefore, the GPRS (4Tx slots) for GSM850/GSM1900 is considered as the primary mode.
2. Other configurations of GSM / GPRS / EDGE / DTM are considered as secondary modes. The 3G SAR test reduction procedure is applied, when the maximum output power and tune-up tolerance specified for production units in a secondary mode is $\leq 1/4$ dB higher than the primary mode, SAR measurement is not required for the secondary mode.

UMTS Note:

1. Per KDB 941225 D01v03r01, for SAR testing is measured using a 12.2 kbps RMC with TPC bits configured to all "1's".
2. Per KDB 941225 D01v03r01, RMC 12.2kbps setting is used to evaluate SAR. The maximum output power and tune-up tolerance specified for production units in HSDPA / HSUPA / DC-HSDPA is $\leq 1/4$ dB higher than RMC 12.2Kbps or when the highest reported SAR of the RMC12.2Kbps is scaled by the ratio of specified maximum output power and tune-up tolerance of HSDPA / HSUPA / DC-HSDPA to RMC12.2Kbps and the adjusted SAR is ≤ 1.2 W/kg, SAR measurement is not required for HSDPA / HSUPA / DC-HSDPA, and according to the following RF output power, the output power results of the secondary modes (HSUPA, HSDPA, DC-HSDPA) are less than $1/4$ dB higher than the primary modes; therefore, SAR measurement is not required for HSDPA / HSUPA / DC-HSDPA.

**LTE Note:**

1. Per KDB 941225 D05v02r05, start with the largest channel bandwidth and measure SAR for QPSK with 1 RB allocation, using the RB offset and required test channel combination with the highest maximum output power for RB offsets at the upper edge, middle and lower edge of each required test channel.
2. Per KDB 941225 D05v02r05, 50% RB allocation for QPSK SAR testing follows 1RB QPSK allocation procedure.
3. Per KDB 941225 D05v02r05, For QPSK with 100% RB allocation, SAR is not required when the highest maximum output power for 100 % RB allocation is less than the highest maximum output power in 50% and 1 RB allocations and the highest reported SAR for 1 RB and 50% RB allocation are ≤ 0.8 W/kg. Otherwise, SAR is measured for the highest output power channel; and if the reported SAR is > 1.45 W/kg, the remaining required test channels must also be tested.
4. Per KDB 941225 D05v02r05, 16QAM output power for each RB allocation configuration is $>$ not $\frac{1}{2}$ dB higher than the same configuration in QPSK and the reported SAR for the QPSK configuration is ≤ 1.45 W/kg; Per KDB 941225 D05v02r05, 16QAM SAR testing is not required.
5. Per KDB 941225 D05v02r05, Smaller bandwidth output power for each RB allocation configuration is $>$ not $\frac{1}{2}$ dB higher than the same configuration in the largest supported bandwidth, and the reported SAR for the largest supported bandwidth is ≤ 1.45 W/kg; Per KDB 941225 D05v02r05, smaller bandwidth SAR testing is not required.
6. For LTE B5 / B4 the maximum bandwidth does not support three non-overlapping channels, per KDB 941225 D05v02r05, when a device supports overlapping channel assignment in a channel bandwidth configuration, the middle channel of the group of overlapping channels should be selected for testing.
7. LTE band 38 SAR test was covered by Band 41; according to TCB workshop, SAR test for overlapping LTE bands can be reduced if
 - a. The maximum output power, including tolerance, for the smaller band is \leq the larger band to qualify for the SAR test exclusion.
 - b. The channel bandwidth and other operating parameters for the smaller band are fully supported by the larger band.

WLAN Note:

1. Per KDB 248227 D01v02r02, for 2.4GHz 802.11g/n SAR testing is not required when the highest reported SAR for DSSS is adjusted by the ratio of OFDM to DSSS specified maximum output power and the adjusted SAR is ≤ 1.2 W/kg.
2. Per KDB 248227 D01v02r02, U-NII-1 SAR testing is not required when the U-NII-2A band highest reported SAR for a test configuration is ≤ 1.2 W/kg, SAR is not required for U-NII-1 band.
3. When the reported SAR of the test position is > 0.4 W/kg, SAR is repeated for the 802.11 transmission mode configuration tested in the initial test position to measure the subsequent next closet/smallest test separation distance and maximum coupling test position on the highest maximum output power channel, until the report SAR is ≤ 0.8 W/kg or all required test position are tested.
4. For all positions / configurations, when the reported SAR is > 0.8 W/kg, SAR is measured for these test positions / configurations on the subsequent next highest measured output power channel(s) until the reported SAR is ≤ 1.2 W/kg or all required channels are tested.
5. For WLAN SAR testing was performed on single antenna RF power in SISO mode is larger or equal to the single antenna RF power in MIMO mode, and for RF exposure assessment of MIMO mode simultaneous transmission exclusion analysis was performed with SAR test results of each antenna in SISO mode.
6. Per KDB 248227 D01v02r02, the simultaneous SAR provisions in KDB publication 447498 should be applied to determine simultaneous transmission SAR test exclusion for WiFi MIMO. If the sum of 1g single transmission chain SAR measurements is < 1.6 W/kg and SAR peak to location ratio ≤ 0.04 , no additional SAR measurements for MIMO.
7. During SAR testing the WLAN transmission was verified using a spectrum analyzer.



15.1 Head SAR

<GSM SAR>

Plot No.	Band	Mode	Test Position	Gap (mm)	Ch.	Freq. (MHz)	Average Power (dBm)	Tune-Up Limit (dBm)	Tune-up Scaling Factor	Power Drift (dB)	Measured 1g SAR (W/kg)	Reported 1g SAR (W/kg)
01	GSM850	GPRS (4 Tx slots)	Right Cheek	0mm	189	836.4	26.92	27.50	1.143	-0.12	0.115	0.131
	GSM850	GPRS (4 Tx slots)	Right Tilted	0mm	189	836.4	26.92	27.50	1.143	-0.15	0.061	0.070
	GSM850	GPRS (4 Tx slots)	Left Cheek	0mm	189	836.4	26.92	27.50	1.143	0.1	0.109	0.125
	GSM850	GPRS (4 Tx slots)	Left Tilted	0mm	189	836.4	26.92	27.50	1.143	0.11	0.076	0.087
	GSM1900	GPRS (4 Tx slots)	Right Cheek	0mm	512	1850.2	24.02	25.00	1.253	0.15	0.070	0.088
	GSM1900	GPRS (4 Tx slots)	Right Tilted	0mm	512	1850.2	24.02	25.00	1.253	0.14	0.061	0.076
02	GSM1900	GPRS (4 Tx slots)	Left Cheek	0mm	512	1850.2	24.02	25.00	1.253	0	0.145	0.182
	GSM1900	GPRS (4 Tx slots)	Left Tilted	0mm	512	1850.2	24.02	25.00	1.253	-0.1	0.050	0.063

<WCDMA SAR>

Plot No.	Band	Mode	Test Position	Gap (mm)	Ch.	Freq. (MHz)	Average Power (dBm)	Tune-Up Limit (dBm)	Tune-up Scaling Factor	Power Drift (dB)	Measured 1g SAR (W/kg)	Reported 1g SAR (W/kg)
	WCDMA II	RMC 12.2Kbps	Right Cheek	0mm	9262	1852.4	23.85	24.00	1.035	-0.1	0.103	0.107
	WCDMA II	RMC 12.2Kbps	Right Tilted	0mm	9262	1852.4	23.85	24.00	1.035	0.01	0.095	0.098
03	WCDMA II	RMC 12.2Kbps	Left Cheek	0mm	9262	1852.4	23.85	24.00	1.035	-0.09	0.236	0.244
	WCDMA II	RMC 12.2Kbps	Left Tilted	0mm	9262	1852.4	23.85	24.00	1.035	0.1	0.078	0.081
04	WCDMA V	RMC 12.2Kbps	Right Cheek	0mm	4233	846.6	23.29	24.00	1.178	0.17	0.120	0.141
	WCDMA V	RMC 12.2Kbps	Right Tilted	0mm	4233	846.6	23.29	24.00	1.178	0.16	0.059	0.069
	WCDMA V	RMC 12.2Kbps	Left Cheek	0mm	4233	846.6	23.29	24.00	1.178	-0.13	0.099	0.117
	WCDMA V	RMC 12.2Kbps	Left Tilted	0mm	4233	846.6	23.29	24.00	1.178	0.11	0.063	0.074



<FDD LTE SAR>

Plot No.	Band	BW (MHz)	Modulation	RB Size	RB offset	Test Position	Gap (mm)	Ch.	Freq. (MHz)	Average Power (dBm)	Tune-Up Limit (dBm)	Tune-up Scaling Factor	Power Drift (dB)	Measured 1g SAR (W/kg)	Reported 1g SAR (W/kg)
	LTE Band 2	20M	QPSK	1	0	Right Cheek	0mm	18700	1860	23.68	24.00	1.076	-0.16	0.065	0.070
	LTE Band 2	20M	QPSK	50	0	Right Cheek	0mm	18700	1860	22.46	23.00	1.132	0.13	0.050	0.057
	LTE Band 2	20M	QPSK	1	0	Right Tilted	0mm	18700	1860	23.68	24.00	1.076	0.04	0.052	0.056
	LTE Band 2	20M	QPSK	50	0	Right Tilted	0mm	18700	1860	22.46	23.00	1.132	-0.19	0.040	0.045
05	LTE Band 2	20M	QPSK	1	0	Left Cheek	0mm	18700	1860	23.68	24.00	1.076	-0.02	0.145	0.156
	LTE Band 2	20M	QPSK	50	0	Left Cheek	0mm	18700	1860	22.46	23.00	1.132	0.09	0.112	0.127
	LTE Band 2	20M	QPSK	1	0	Left Tilted	0mm	18700	1860	23.68	24.00	1.076	-0.06	0.049	0.053
	LTE Band 2	20M	QPSK	50	0	Left Tilted	0mm	18700	1860	22.46	23.00	1.132	0.13	0.035	0.040
	LTE Band 4	20M	QPSK	1	0	Right Cheek	0mm	20175	1732.5	23.66	24.00	1.081	0.12	0.056	0.061
	LTE Band 4	20M	QPSK	50	0	Right Cheek	0mm	20175	1732.5	22.55	23.00	1.109	-0.06	0.044	0.049
	LTE Band 4	20M	QPSK	1	0	Right Tilted	0mm	20175	1732.5	23.66	24.00	1.081	-0.11	0.046	0.050
	LTE Band 4	20M	QPSK	50	0	Right Tilted	0mm	20175	1732.5	22.55	23.00	1.109	-0.01	0.035	0.039
06	LTE Band 4	20M	QPSK	1	0	Left Cheek	0mm	20175	1732.5	23.66	24.00	1.081	-0.01	0.130	0.141
	LTE Band 4	20M	QPSK	50	0	Left Cheek	0mm	20175	1732.5	22.55	23.00	1.109	0.06	0.103	0.114
	LTE Band 4	20M	QPSK	1	0	Left Tilted	0mm	20175	1732.5	23.66	24.00	1.081	0.05	0.050	0.054
	LTE Band 4	20M	QPSK	50	0	Left Tilted	0mm	20175	1732.5	22.55	23.00	1.109	-0.12	0.037	0.041
07	LTE Band 5	10M	QPSK	1	0	Right Cheek	0mm	20525	836.5	22.73	24.50	1.503	0.05	0.117	0.176
	LTE Band 5	10M	QPSK	25	0	Right Cheek	0mm	20525	836.5	21.65	23.50	1.531	0.08	0.091	0.139
	LTE Band 5	10M	QPSK	1	0	Right Tilted	0mm	20525	836.5	22.73	24.50	1.503	-0.03	0.046	0.069
	LTE Band 5	10M	QPSK	25	0	Right Tilted	0mm	20525	836.5	21.65	23.50	1.531	-0.01	0.034	0.052
	LTE Band 5	10M	QPSK	1	0	Left Cheek	0mm	20525	836.5	22.73	24.50	1.503	-0.05	0.107	0.161
	LTE Band 5	10M	QPSK	25	0	Left Cheek	0mm	20525	836.5	21.65	23.50	1.531	-0.02	0.084	0.129
	LTE Band 5	10M	QPSK	1	0	Left Tilted	0mm	20525	836.5	22.73	24.50	1.503	0.03	0.062	0.093
	LTE Band 5	10M	QPSK	25	0	Left Tilted	0mm	20525	836.5	21.65	23.50	1.531	0.09	0.049	0.075
08	LTE Band 7	20M	QPSK	1	0	Right Cheek	0mm	21350	2560	24.00	24.50	1.122	-0.066	0.159	0.178
	LTE Band 7	20M	QPSK	50	0	Right Cheek	0mm	21350	2560	23.00	23.50	1.122	0.082	0.063	0.071
	LTE Band 7	20M	QPSK	1	0	Right Tilted	0mm	21350	2560	24.00	24.50	1.122	0.082	0.063	0.071
	LTE Band 7	20M	QPSK	50	0	Right Tilted	0mm	21350	2560	23.00	23.50	1.122	-0.149	0.046	0.052
	LTE Band 7	20M	QPSK	1	0	Left Cheek	0mm	21350	2560	24.00	24.50	1.122	0.028	0.157	0.176
	LTE Band 7	20M	QPSK	50	0	Left Cheek	0mm	21350	2560	23.00	23.50	1.122	0.077	0.121	0.136
	LTE Band 7	20M	QPSK	1	0	Left Tilted	0mm	21350	2560	24.00	24.50	1.122	-0.09	0.124	0.139
	LTE Band 7	20M	QPSK	50	0	Left Tilted	0mm	21350	2560	23.00	23.50	1.122	-0.11	0.095	0.107

<TDD LTE SAR>

Plot No.	Band	BW (MHz)	Modulation	RB Size	RB offset	Test Position	Gap (mm)	Ch.	Freq. (MHz)	Average Power (dBm)	Tune-Up Limit (dBm)	Tune-up Scaling Factor	Duty Cycle %	Duty Cycle Scaling Factor	Power Drift (dB)	Measured 1g SAR (W/kg)	Reported 1g SAR (W/kg)
09	LTE Band 41	20M	QPSK	1	0	Right Cheek	0mm	41055	2636.5	23.58	24.00	1.102	62.9	1.006	-0.18	0.112	0.124
	LTE Band 41	20M	QPSK	50	0	Right Cheek	0mm	41055	2636.5	22.72	23.00	1.067	62.9	1.006	0.08	0.088	0.094
	LTE Band 41	20M	QPSK	1	0	Right Tilted	0mm	41055	2636.5	23.58	24.00	1.102	62.9	1.006	0.19	0.037	0.041
	LTE Band 41	20M	QPSK	50	0	Right Tilted	0mm	41055	2636.5	22.72	23.00	1.067	62.9	1.006	0.14	0.031	0.033
	LTE Band 41	20M	QPSK	1	0	Left Cheek	0mm	41055	2636.5	23.58	24.00	1.102	62.9	1.006	0.07	0.083	0.092
	LTE Band 41	20M	QPSK	50	0	Left Cheek	0mm	41055	2636.5	22.72	23.00	1.067	62.9	1.006	0.06	0.064	0.069
	LTE Band 41	20M	QPSK	1	0	Left Tilted	0mm	41055	2636.5	23.58	24.00	1.102	62.9	1.006	-0.08	0.065	0.072
	LTE Band 41	20M	QPSK	50	0	Left Tilted	0mm	41055	2636.5	22.72	23.00	1.067	62.9	1.006	0.02	0.053	0.057



<WLAN SAR>

Plot No.	Band	Mode	Test Position	Gap (mm)	Antenna	Power Reduction	Ch.	Freq. (MHz)	Average Power (dBm)	Tune-Up Limit (dBm)	Tune-up Scaling Factor	Duty Cycle %	Duty Cycle Scaling Factor	Power Drift (dB)	Measured 1g SAR (W/kg)	Reported 1g SAR (W/kg)
10	WLAN2.4GHz	802.11b 1Mbps	Right Cheek	0mm	Ant 1	ON	6	2437	16.31	16.50	1.044	98.54	1.015	-0.06	0.731	0.774
	WLAN2.4GHz	802.11b 1Mbps	Right Tilted	0mm	Ant 1	ON	6	2437	16.31	16.50	1.044	98.54	1.015	0.12	0.549	0.582
	WLAN2.4GHz	802.11b 1Mbps	Left Cheek	0mm	Ant 1	ON	6	2437	16.31	16.50	1.044	98.54	1.015	0.1	0.308	0.326
	WLAN2.4GHz	802.11b 1Mbps	Left Tilted	0mm	Ant 1	ON	6	2437	16.31	16.50	1.044	98.54	1.015	-0.05	0.244	0.259
	WLAN2.4GHz	802.11b 1Mbps	Right Cheek	0mm	Ant 2	ON	1	2412	16.34	16.50	1.037	99.03	1.010	0.11	0.116	0.121
	WLAN2.4GHz	802.11b 1Mbps	Right Tilted	0mm	Ant 2	ON	1	2412	16.34	16.50	1.037	99.03	1.010	0.04	0.076	0.080
	WLAN2.4GHz	802.11b 1Mbps	Left Cheek	0mm	Ant 2	ON	1	2412	16.34	16.50	1.037	99.03	1.010	0.06	0.430	0.450
	WLAN2.4GHz	802.11b 1Mbps	Left Tilted	0mm	Ant 2	ON	1	2412	16.34	16.50	1.037	99.03	1.010	0.11	0.266	0.279
	WLAN5GHz	802.11n-HT40 MCS0	Right Cheek	0mm	Ant 1	ON	54	5270	12.77	13.00	1.053	90.29	1.108	0.02	0.351	0.410
	WLAN5GHz	802.11n-HT40 MCS0	Right Tilted	0mm	Ant 1	ON	54	5270	12.77	13.00	1.053	90.29	1.108	0.16	0.271	0.316
	WLAN5GHz	802.11n-HT40 MCS0	Left Cheek	0mm	Ant 1	ON	54	5270	12.77	13.00	1.053	90.29	1.108	-0.18	0.189	0.221
	WLAN5GHz	802.11n-HT40 MCS0	Left Tilted	0mm	Ant 1	ON	54	5270	12.77	13.00	1.053	90.29	1.108	-0.04	0.143	0.167
	WLAN5GHz	802.11n-HT40 MCS0	Right Cheek	0mm	Ant 2	ON	54	5270	12.79	13.00	1.049	89.71	1.115	0.06	0.311	0.364
	WLAN5GHz	802.11n-HT40 MCS0	Right Tilted	0mm	Ant 2	ON	54	5270	12.79	13.00	1.049	89.71	1.115	0.11	0.303	0.354
	WLAN5GHz	802.11n-HT40 MCS0	Left Cheek	0mm	Ant 2	ON	54	5270	12.79	13.00	1.049	89.71	1.115	-0.11	0.706	0.826
11	WLAN5GHz	802.11n-HT40 MCS0	Left Cheek	0mm	Ant 2	ON	62	5310	12.77	13.00	1.054	89.71	1.115	-0.14	0.732	0.860
	WLAN5GHz	802.11n-HT40 MCS0	Left Tilted	0mm	Ant 2	ON	54	5270	12.79	13.00	1.049	89.71	1.115	-0.11	0.570	0.667
	WLAN5GHz	802.11n-HT40 MCS0	Right Cheek	0mm	Ant 1	ON	102	5510	14.97	15.00	1.006	90.29	1.108	0.05	0.831	0.926
12	WLAN5GHz	802.11n-HT40 MCS0	Right Cheek	0mm	Ant 1	ON	110	5550	14.95	15.00	1.011	90.29	1.108	0	0.944	1.057
	WLAN5GHz	802.11n-HT40 MCS0	Right Tilted	0mm	Ant 1	ON	102	5510	14.97	15.00	1.006	90.29	1.108	0.18	0.655	0.730
	WLAN5GHz	802.11n-HT40 MCS0	Left Cheek	0mm	Ant 1	ON	102	5510	14.97	15.00	1.006	90.29	1.108	-0.09	0.523	0.583
	WLAN5GHz	802.11n-HT40 MCS0	Left Tilted	0mm	Ant 1	ON	102	5510	14.97	15.00	1.006	90.29	1.108	-0.1	0.392	0.437
	WLAN5GHz	802.11n-HT40 MCS0	Right Cheek	0mm	Ant 2	ON	102	5510	14.94	15.00	1.014	89.71	1.115	0.11	0.278	0.314
	WLAN5GHz	802.11n-HT40 MCS0	Right Tilted	0mm	Ant 2	ON	102	5510	14.94	15.00	1.014	89.71	1.115	-0.11	0.269	0.304
	WLAN5GHz	802.11n-HT40 MCS0	Left Cheek	0mm	Ant 2	ON	102	5510	14.94	15.00	1.014	89.71	1.115	-0.14	0.624	0.705
	WLAN5GHz	802.11n-HT40 MCS0	Left Tilted	0mm	Ant 2	ON	102	5510	14.94	15.00	1.014	89.71	1.115	-0.16	0.503	0.568
13	WLAN5GHz	802.11n-HT40 MCS0	Right Cheek	0mm	Ant 1	ON	159	5795	13.38	13.50	1.027	90.29	1.108	0.11	0.957	1.089
	WLAN5GHz	802.11n-HT40 MCS0	Right Cheek	0mm	Ant 1	ON	151	5755	13.32	13.50	1.041	90.29	1.108	0.08	0.913	1.053
	WLAN5GHz	802.11n-HT40 MCS0	Right Tilted	0mm	Ant 1	ON	159	5795	13.38	13.50	1.027	90.29	1.108	0.16	0.828	0.942
	WLAN5GHz	802.11n-HT40 MCS0	Right Tilted	0mm	Ant 1	ON	151	5755	13.32	13.50	1.041	90.29	1.108	0.12	0.635	0.733
	WLAN5GHz	802.11n-HT40 MCS0	Left Cheek	0mm	Ant 1	ON	159	5795	13.38	13.50	1.027	90.29	1.108	-0.03	0.683	0.777
	WLAN5GHz	802.11n-HT40 MCS0	Left Tilted	0mm	Ant 1	ON	159	5795	13.38	13.50	1.027	90.29	1.108	-0.13	0.478	0.544
	WLAN5GHz	802.11n-HT40 MCS0	Right Cheek	0mm	Ant 2	ON	159	5795	13.19	13.50	1.074	89.71	1.115	-0.03	0.116	0.139
	WLAN5GHz	802.11n-HT40 MCS0	Right Tilted	0mm	Ant 2	ON	159	5795	13.19	13.50	1.074	89.71	1.115	-0.09	0.112	0.134
	WLAN5GHz	802.11n-HT40 MCS0	Left Cheek	0mm	Ant 2	ON	159	5795	13.19	13.50	1.074	89.71	1.115	-0.01	0.259	0.310
	WLAN5GHz	802.11n-HT40 MCS0	Left Tilted	0mm	Ant 2	ON	159	5795	13.19	13.50	1.074	89.71	1.115	-0.05	0.218	0.261



15.2 Hotspot SAR

<GSM SAR>

Plot No.	Band	Mode	Test Position	Gap (mm)	Ch.	Freq. (MHz)	Average Power (dBm)	Tune-Up Limit (dBm)	Tune-up Scaling Factor	Power Drift (dB)	Measured 1g SAR (W/kg)	Reported 1g SAR (W/kg)
14	GSM850	GPRS (4 Tx slots)	Front	10mm	189	836.4	26.92	27.50	1.143	-0.04	0.218	0.249
	GSM850	GPRS (4 Tx slots)	Back	10mm	189	836.4	26.92	27.50	1.143	-0.04	0.119	0.136
	GSM850	GPRS (4 Tx slots)	Left Side	10mm	189	836.4	26.92	27.50	1.143	-0.16	0.091	0.104
	GSM850	GPRS (4 Tx slots)	Right Side	10mm	189	836.4	26.92	27.50	1.143	0.03	0.196	0.224
	GSM850	GPRS (4 Tx slots)	Bottom Side	10mm	189	836.4	26.92	27.50	1.143	0.04	0.100	0.114
	GSM1900	GPRS (4 Tx slots)	Front	10mm	512	1850.2	24.02	25.00	1.253	-0.15	0.858	1.075
	GSM1900	GPRS (4 Tx slots)	Front	10mm	661	1880	23.91	25.00	1.285	-0.13	0.532	0.684
	GSM1900	GPRS (4 Tx slots)	Front	10mm	810	1909.8	23.94	25.00	1.276	-0.12	0.404	0.516
	GSM1900	GPRS (4 Tx slots)	Back	10mm	512	1850.2	24.02	25.00	1.253	-0.12	0.137	0.172
	GSM1900	GPRS (4 Tx slots)	Left Side	10mm	512	1850.2	24.02	25.00	1.253	-0.11	0.239	0.300
	GSM1900	GPRS (4 Tx slots)	Right Side	10mm	512	1850.2	24.02	25.00	1.253	-0.11	0.008	0.010
15	GSM1900	GPRS (4 Tx slots)	Bottom Side	10mm	512	1850.2	24.02	25.00	1.253	-0.11	0.957	1.199
	GSM1900	GPRS (4 Tx slots)	Bottom Side	10mm	661	1880	23.91	25.00	1.285	-0.18	0.530	0.681
	GSM1900	GPRS (4 Tx slots)	Bottom Side	10mm	810	1909.8	23.94	25.00	1.276	-0.12	0.379	0.484

<WCDMA SAR>

Plot No.	Band	Mode	Test Position	Gap (mm)	Ch.	Freq. (MHz)	Average Power (dBm)	Tune-Up Limit (dBm)	Tune-up Scaling Factor	Power Drift (dB)	Measured 1g SAR (W/kg)	Reported 1g SAR (W/kg)
	WCDMA II	RMC 12.2Kbps	Front	10mm	9262	1852.4	23.85	24.00	1.035	-0.12	0.738	0.764
	WCDMA II	RMC 12.2Kbps	Back	10mm	9262	1852.4	23.85	24.00	1.035	-0.06	0.112	0.116
	WCDMA II	RMC 12.2Kbps	Left Side	10mm	9262	1852.4	23.85	24.00	1.035	-0.06	0.169	0.175
	WCDMA II	RMC 12.2Kbps	Right Side	10mm	9262	1852.4	23.85	24.00	1.035	-0.09	0.005	0.005
16	WCDMA II	RMC 12.2Kbps	Bottom Side	10mm	9262	1852.4	23.85	24.00	1.035	-0.17	0.749	0.775
17	WCDMA V	RMC 12.2Kbps	Front	10mm	4233	846.6	23.29	24.00	1.178	0.04	0.220	0.259
	WCDMA V	RMC 12.2Kbps	Back	10mm	4233	846.6	23.29	24.00	1.178	-0.01	0.112	0.132
	WCDMA V	RMC 12.2Kbps	Left Side	10mm	4233	846.6	23.29	24.00	1.178	-0.01	0.072	0.085
	WCDMA V	RMC 12.2Kbps	Right Side	10mm	4233	846.6	23.29	24.00	1.178	-0.01	0.163	0.192
	WCDMA V	RMC 12.2Kbps	Bottom Side	10mm	4233	846.6	23.29	24.00	1.178	0.12	0.092	0.108



<FDD LTE SAR>

Plot No.	Band	BW (MHz)	Modulation	RB Size	RB offset	Test Position	Gap (mm)	Ch.	Freq. (MHz)	Average Power (dBm)	Tune-Up Limit (dBm)	Tune-up Scaling Factor	Power Drift (dB)	Measured 1g SAR (W/kg)	Reported 1g SAR (W/kg)
	LTE Band 2	20M	QPSK	1	0	Front	10mm	18700	1860	23.68	24.00	1.076	-0.13	0.812	0.874
	LTE Band 2	20M	QPSK	1	0	Front	10mm	18900	1880	23.51	24.00	1.119	-0.06	0.799	0.894
18	LTE Band 2	20M	QPSK	1	0	Front	10mm	19100	1900	23.42	24.00	1.143	-0.06	0.791	0.904
	LTE Band 2	20M	QPSK	50	0	Front	10mm	18700	1860	22.46	23.00	1.132	-0.04	0.614	0.695
	LTE Band 2	20M	QPSK	100	0	Front	10mm	18700	1860	22.40	23.00	1.148	-0.09	0.610	0.700
	LTE Band 2	20M	QPSK	1	0	Back	10mm	18700	1860	23.68	24.00	1.076	0	0.129	0.139
	LTE Band 2	20M	QPSK	50	0	Back	10mm	18700	1860	22.46	23.00	1.132	-0.01	0.099	0.112
	LTE Band 2	20M	QPSK	1	0	Left Side	10mm	18700	1860	23.68	24.00	1.076	-0.06	0.198	0.213
	LTE Band 2	20M	QPSK	50	0	Left Side	10mm	18700	1860	22.46	23.00	1.132	-0.06	0.152	0.172
	LTE Band 2	20M	QPSK	1	0	Right Side	10mm	18700	1860	23.68	24.00	1.076	0.18	0.006	0.007
	LTE Band 2	20M	QPSK	50	0	Right Side	10mm	18700	1860	22.46	23.00	1.132	-0.19	0.005	0.005
	LTE Band 2	20M	QPSK	1	0	Bottom Side	10mm	18700	1860	23.68	24.00	1.076	-0.12	0.816	0.878
	LTE Band 2	20M	QPSK	1	0	Bottom Side	10mm	18900	1880	23.51	24.00	1.119	-0.12	0.778	0.871
	LTE Band 2	20M	QPSK	1	0	Bottom Side	10mm	19100	1900	23.42	24.00	1.143	-0.12	0.751	0.858
	LTE Band 2	20M	QPSK	50	0	Bottom Side	10mm	18700	1860	22.46	23.00	1.132	-0.19	0.615	0.696
	LTE Band 2	20M	QPSK	100	0	Bottom Side	10mm	18700	1860	22.40	23.00	1.148	-0.19	0.608	0.698
19	LTE Band 4	20M	QPSK	1	0	Front	10mm	20175	1732.5	23.66	24.00	1.081	-0.09	0.843	0.912
	LTE Band 4	20M	QPSK	50	0	Front	10mm	20175	1732.5	22.55	23.00	1.109	-0.05	0.613	0.680
	LTE Band 4	20M	QPSK	100	0	Front	10mm	20175	1732.5	22.54	23.00	1.112	-0.06	0.588	0.654
	LTE Band 4	20M	QPSK	1	0	Back	10mm	20175	1732.5	23.66	24.00	1.081	-0.02	0.110	0.119
	LTE Band 4	20M	QPSK	50	0	Back	10mm	20175	1732.5	22.55	23.00	1.109	0.01	0.083	0.092
	LTE Band 4	20M	QPSK	1	0	Left Side	10mm	20175	1732.5	23.66	24.00	1.081	-0.11	0.098	0.106
	LTE Band 4	20M	QPSK	50	0	Left Side	10mm	20175	1732.5	22.55	23.00	1.109	-0.07	0.076	0.084
	LTE Band 4	20M	QPSK	1	0	Right Side	10mm	20175	1732.5	23.66	24.00	1.081	0.06	0.009	0.010
	LTE Band 4	20M	QPSK	50	0	Right Side	10mm	20175	1732.5	22.55	23.00	1.109	-0.09	0.006	0.007
	LTE Band 4	20M	QPSK	1	0	Bottom Side	10mm	20175	1732.5	23.66	24.00	1.081	-0.18	0.779	0.842
	LTE Band 4	20M	QPSK	50	0	Bottom Side	10mm	20175	1732.5	22.55	23.00	1.109	-0.12	0.598	0.663
	LTE Band 4	20M	QPSK	100	0	Bottom Side	10mm	20175	1732.5	22.54	23.00	1.112	-0.17	0.576	0.640
20	LTE Band 5	10M	QPSK	1	0	Front	10mm	20525	836.5	22.73	24.50	1.503	0.1	0.204	0.307
	LTE Band 5	10M	QPSK	25	0	Front	10mm	20525	836.5	21.65	23.50	1.531	0	0.159	0.243
	LTE Band 5	10M	QPSK	1	0	Back	10mm	20525	836.5	22.73	24.50	1.503	-0.02	0.114	0.171
	LTE Band 5	10M	QPSK	25	0	Back	10mm	20525	836.5	21.65	23.50	1.531	-0.02	0.089	0.136
	LTE Band 5	10M	QPSK	1	0	Left Side	10mm	20525	836.5	22.73	24.50	1.503	0.12	0.077	0.116
	LTE Band 5	10M	QPSK	25	0	Left Side	10mm	20525	836.5	21.65	23.50	1.531	-0.04	0.062	0.095
	LTE Band 5	10M	QPSK	1	0	Right Side	10mm	20525	836.5	22.73	24.50	1.503	0.11	0.165	0.248
	LTE Band 5	10M	QPSK	25	0	Right Side	10mm	20525	836.5	21.65	23.50	1.531	0.04	0.133	0.204
	LTE Band 5	10M	QPSK	1	0	Bottom Side	10mm	20525	836.5	22.73	24.50	1.503	0.02	0.089	0.134
	LTE Band 5	10M	QPSK	25	0	Bottom Side	10mm	20525	836.5	21.65	23.50	1.531	0.06	0.070	0.107



Plot No.	Band	BW (MHz)	Modulation	RB Size	RB offset	Test Position	Gap (mm)	Ch.	Freq. (MHz)	Average Power (dBm)	Tune-Up Limit (dBm)	Tune-up Scaling Factor	Power Drift (dB)	Measured 1g SAR (W/kg)	Reported 1g SAR (W/kg)
	LTE Band 7	20M	QPSK	1	0	Front	10mm	21350	2560	24.00	24.50	1.122	-0.13	0.816	0.916
21	LTE Band 7	20M	QPSK	1	0	Front	10mm	20850	2510	23.46	24.50	1.271	-0.05	0.892	1.133
	LTE Band 7	20M	QPSK	1	0	Front	10mm	21100	2535	23.65	24.50	1.216	0.03	0.793	0.964
	LTE Band 7	20M	QPSK	50	0	Front	10mm	21350	2560	23.00	23.50	1.122	-0.04	0.541	0.607
	LTE Band 7	20M	QPSK	100	0	Front	10mm	21350	2560	22.92	23.50	1.143	-0.01	0.632	0.722
	LTE Band 7	20M	QPSK	1	0	Back	10mm	21350	2560	24.00	24.50	1.122	-0.01	0.592	0.664
	LTE Band 7	20M	QPSK	50	0	Back	10mm	21350	2560	23.00	23.50	1.122	0.1	0.458	0.514
	LTE Band 7	20M	QPSK	1	0	Left Side	10mm	21350	2560	24.00	24.50	1.122	0.01	0.126	0.141
	LTE Band 7	20M	QPSK	50	0	Left Side	10mm	21350	2560	23.00	23.50	1.122	-0.06	0.100	0.112
	LTE Band 7	20M	QPSK	1	0	Right Side	10mm	21350	2560	24.00	24.50	1.122	0.01	0.573	0.643
	LTE Band 7	20M	QPSK	50	0	Right Side	10mm	21350	2560	23.00	23.50	1.122	-0.02	0.437	0.490
	LTE Band 7	20M	QPSK	1	0	Bottom Side	10mm	21350	2560	24.00	24.50	1.122	-0.07	0.701	0.787
	LTE Band 7	20M	QPSK	50	0	Bottom Side	10mm	21350	2560	23.00	23.50	1.122	-0.13	0.526	0.590

<TDD LTE SAR>

Plot No.	Band	BW (MHz)	Modulation	RB Size	RB offset	Test Position	Gap (mm)	Ch.	Freq. (MHz)	Average Power (dBm)	Tune-Up Limit (dBm)	Tune-up Scaling Factor	Duty Cycle %	Duty Cycle Scaling Factor	Power Drift (dB)	Measured 1g SAR (W/kg)	Reported 1g SAR (W/kg)
22	LTE Band 41	20M	QPSK	1	0	Front	10mm	41055	2636.5	23.58	24.00	1.102	62.9	1.006	0.07	0.356	0.395
	LTE Band 41	20M	QPSK	50	0	Front	10mm	41055	2636.5	22.72	23.00	1.067	62.9	1.006	0.07	0.283	0.304
	LTE Band 41	20M	QPSK	1	0	Back	10mm	41055	2636.5	23.58	24.00	1.102	62.9	1.006	-0.01	0.313	0.347
	LTE Band 41	20M	QPSK	50	0	Back	10mm	41055	2636.5	22.72	23.00	1.067	62.9	1.006	0	0.252	0.270
	LTE Band 41	20M	QPSK	1	0	Left Side	10mm	41055	2636.5	23.58	24.00	1.102	62.9	1.006	-0.08	0.062	0.069
	LTE Band 41	20M	QPSK	50	0	Left Side	10mm	41055	2636.5	22.72	23.00	1.067	62.9	1.006	0.05	0.046	0.049
	LTE Band 41	20M	QPSK	1	0	Right Side	10mm	41055	2636.5	23.58	24.00	1.102	62.9	1.006	0.17	0.267	0.296
	LTE Band 41	20M	QPSK	50	0	Right Side	10mm	41055	2636.5	22.72	23.00	1.067	62.9	1.006	0.18	0.209	0.224
	LTE Band 41	20M	QPSK	1	0	Bottom Side	10mm	41055	2636.5	23.58	24.00	1.102	62.9	1.006	0.07	0.329	0.365
	LTE Band 41	20M	QPSK	50	0	Bottom Side	10mm	41055	2636.5	22.72	23.00	1.067	62.9	1.006	-0.01	0.261	0.280



<WLAN SAR>

Plot No.	Band	Mode	Test Position	Gap (mm)	Antenna	Power Reduction	Ch.	Freq. (MHz)	Average Power (dBm)	Tune-Up Limit (dBm)	Tune-up Scaling Factor	Duty Cycle %	Duty Cycle Scaling Factor	Power Drift (dB)	Measured 1g SAR (W/kg)	Reported 1g SAR (W/kg)
23	WLAN2.4GHz	802.11b 1Mbps	Front	10mm	Ant 1	OFF	1	2412	17.81	18.00	1.044	98.54	1.015	0	0.190	0.201
	WLAN2.4GHz	802.11b 1Mbps	Back	10mm	Ant 1	OFF	1	2412	17.81	18.00	1.044	98.54	1.015	0.07	0.069	0.073
	WLAN2.4GHz	802.11b 1Mbps	Left Side	10mm	Ant 1	OFF	1	2412	17.81	18.00	1.044	98.54	1.015	0.08	0.087	0.092
	WLAN2.4GHz	802.11b 1Mbps	Top Side	10mm	Ant 1	OFF	1	2412	17.81	18.00	1.044	98.54	1.015	-0.13	0.051	0.054
	WLAN2.4GHz	802.11b 1Mbps	Front	10mm	Ant 2	OFF	1	2412	17.74	18.00	1.061	99.03	1.010	0.13	0.078	0.084
	WLAN2.4GHz	802.11b 1Mbps	Back	10mm	Ant 2	OFF	1	2412	17.74	18.00	1.061	99.03	1.010	-0.15	0.036	0.039
	WLAN2.4GHz	802.11b 1Mbps	Right Side	10mm	Ant 2	OFF	1	2412	17.74	18.00	1.061	99.03	1.010	-0.05	0.032	0.034
	WLAN2.4GHz	802.11b 1Mbps	Top Side	10mm	Ant 2	OFF	1	2412	17.74	18.00	1.061	99.03	1.010	-0.18	0.026	0.028
	WLAN5GHz	802.11n-HT40 MCS0	Front	10mm	Ant 1	OFF	38	5190	16.70	17.00	1.071	90.29	1.108	0.13	0.063	0.075
	WLAN5GHz	802.11n-HT40 MCS0	Back	10mm	Ant 1	OFF	38	5190	16.70	17.00	1.071	90.29	1.108	0	0.001	0.001
	WLAN5GHz	802.11n-HT40 MCS0	Left Side	10mm	Ant 1	OFF	38	5190	16.70	17.00	1.071	90.29	1.108	-0.11	0.018	0.021
	WLAN5GHz	802.11n-HT40 MCS0	Top Side	10mm	Ant 1	OFF	38	5190	16.70	17.00	1.071	90.29	1.108	0.19	0.018	0.021
24	WLAN5GHz	802.11n-HT40 MCS0	Front	10mm	Ant 2	OFF	38	5190	16.64	17.00	1.086	89.71	1.115	-0.15	0.168	0.203
	WLAN5GHz	802.11n-HT40 MCS0	Back	10mm	Ant 2	OFF	38	5190	16.64	17.00	1.086	89.71	1.115	0	0.001	0.001
	WLAN5GHz	802.11n-HT40 MCS0	Right Side	10mm	Ant 2	OFF	38	5190	16.64	17.00	1.086	89.71	1.115	0.15	0.020	0.024
	WLAN5GHz	802.11n-HT40 MCS0	Top Side	10mm	Ant 2	OFF	38	5190	16.64	17.00	1.086	89.71	1.115	0.01	0.050	0.061
25	WLAN5GHz	802.11n-HT40 MCS0	Front	10mm	Ant 1	OFF	159	5795	16.79	17.00	1.049	90.29	1.108	-0.13	0.311	0.361
	WLAN5GHz	802.11n-HT40 MCS0	Back	10mm	Ant 1	OFF	159	5795	16.79	17.00	1.049	90.29	1.108	-0.17	0.030	0.035
	WLAN5GHz	802.11n-HT40 MCS0	Left Side	10mm	Ant 1	OFF	159	5795	16.79	17.00	1.049	90.29	1.108	0.14	0.090	0.105
	WLAN5GHz	802.11n-HT40 MCS0	Top Side	10mm	Ant 1	OFF	159	5795	16.79	17.00	1.049	90.29	1.108	-0.11	0.106	0.123
	WLAN5GHz	802.11n-HT40 MCS0	Front	10mm	Ant 2	OFF	159	5795	16.67	17.00	1.079	89.71	1.115	-0.12	0.115	0.138
	WLAN5GHz	802.11n-HT40 MCS0	Back	10mm	Ant 2	OFF	159	5795	16.67	17.00	1.079	89.71	1.115	0.15	0.028	0.034
	WLAN5GHz	802.11n-HT40 MCS0	Right Side	10mm	Ant 2	OFF	159	5795	16.67	17.00	1.079	89.71	1.115	-0.1	0.032	0.038
	WLAN5GHz	802.11n-HT40 MCS0	Top Side	10mm	Ant 2	OFF	159	5795	16.67	17.00	1.079	89.71	1.115	-0.15	0.071	0.085

15.3 Product Specific SAR

<WLAN SAR>

Plot No.	Band	Mode	Test Position	Gap (mm)	Antenna	Power Reduction	Ch.	Freq. (MHz)	Average Power (dBm)	Tune-Up Limit (dBm)	Tune-up Scaling Factor	Duty Cycle %	Duty Cycle Scaling Factor	Power Drift (dB)	Measured 10g SAR (W/kg)	Reported 10g SAR (W/kg)
	WLAN5GHz	802.11n-HT40 MCS0	Front	0mm	Ant 1	OFF	62	5310	16.54	17.00	1.111	90.29	1.108	0.09	0.149	0.183
	WLAN5GHz	802.11n-HT40 MCS0	Back	0mm	Ant 1	OFF	62	5310	16.54	17.00	1.111	90.29	1.108	0	0.001	0.001
	WLAN5GHz	802.11n-HT40 MCS0	Left Side	0mm	Ant 1	OFF	62	5310	16.54	17.00	1.111	90.29	1.108	0.11	0.025	0.031
	WLAN5GHz	802.11n-HT40 MCS0	Top Side	0mm	Ant 1	OFF	62	5310	16.54	17.00	1.111	90.29	1.108	0.02	0.041	0.050
26	WLAN5GHz	802.11n-HT40 MCS0	Front	0mm	Ant 2	OFF	62	5310	16.63	17.00	1.089	89.71	1.115	0.13	0.836	1.015
	WLAN5GHz	802.11n-HT40 MCS0	Back	0mm	Ant 2	OFF	62	5310	16.63	17.00	1.089	89.71	1.115	0.07	0.014	0.017
	WLAN5GHz	802.11n-HT40 MCS0	Right Side	0mm	Ant 2	OFF	62	5310	16.63	17.00	1.089	89.71	1.115	-0.07	0.041	0.050
	WLAN5GHz	802.11n-HT40 MCS0	Top Side	0mm	Ant 2	OFF	62	5310	16.63	17.00	1.089	89.71	1.115	-0.08	0.130	0.158
	WLAN5GHz	802.11n-HT40 MCS0	Front	0mm	Ant 1	OFF	102	5510	16.52	17.00	1.116	90.29	1.108	0.15	0.295	0.365
	WLAN5GHz	802.11n-HT40 MCS0	Back	0mm	Ant 1	OFF	102	5510	16.52	17.00	1.116	90.29	1.108	-0.11	0.013	0.016
	WLAN5GHz	802.11n-HT40 MCS0	Left Side	0mm	Ant 1	OFF	102	5510	16.52	17.00	1.116	90.29	1.108	-0.04	0.032	0.040
	WLAN5GHz	802.11n-HT40 MCS0	Top Side	0mm	Ant 1	OFF	102	5510	16.52	17.00	1.116	90.29	1.108	-0.04	0.050	0.062
27	WLAN5GHz	802.11n-HT40 MCS0	Front	0mm	Ant 2	OFF	102	5510	16.72	17.00	1.066	89.71	1.115	0.19	0.570	0.678
	WLAN5GHz	802.11n-HT40 MCS0	Back	0mm	Ant 2	OFF	102	5510	16.72	17.00	1.066	89.71	1.115	-0.14	0.012	0.014
	WLAN5GHz	802.11n-HT40 MCS0	Right Side	0mm	Ant 2	OFF	102	5510	16.72	17.00	1.066	89.71	1.115	-0.03	0.025	0.030
	WLAN5GHz	802.11n-HT40 MCS0	Top Side	0mm	Ant 2	OFF	102	5510	16.72	17.00	1.066	89.71	1.115	-0.1	0.120	0.143



15.4 Body Worn Accessory SAR

<GSM SAR>

Plot No.	Band	Mode	Test Position	Gap (mm)	Ch.	Freq. (MHz)	Average Power (dBm)	Tune-Up Limit (dBm)	Tune-up Scaling Factor	Power Drift (dB)	Measured 1g SAR (W/kg)	Reported 1g SAR (W/kg)
28	GSM850	GPRS (4 Tx slots)	Front	15mm	189	836.4	26.92	27.50	1.143	0.19	0.168	0.192
	GSM850	GPRS (4 Tx slots)	Back	15mm	189	836.4	26.92	27.50	1.143	-0.06	0.122	0.139
29	GSM1900	GPRS (4 Tx slots)	Front	15mm	512	1850.2	24.02	25.00	1.253	-0.16	0.388	0.486
	GSM1900	GPRS (4 Tx slots)	Back	15mm	512	1850.2	24.02	25.00	1.253	-0.04	0.070	0.088

<WCDMA SAR>

Plot No.	Band	Mode	Test Position	Gap (mm)	Ch.	Freq. (MHz)	Average Power (dBm)	Tune-Up Limit (dBm)	Tune-up Scaling Factor	Power Drift (dB)	Measured 1g SAR (W/kg)	Reported 1g SAR (W/kg)
30	WCDMA II	RMC 12.2Kbps	Front	15mm	9262	1852.4	23.85	24.00	1.035	-0.11	0.323	0.334
	WCDMA II	RMC 12.2Kbps	Back	15mm	9262	1852.4	23.85	24.00	1.035	-0.04	0.081	0.084
31	WCDMA V	RMC 12.2Kbps	Front	15mm	4233	846.6	23.29	24.00	1.178	-0.12	0.143	0.168
	WCDMA V	RMC 12.2Kbps	Back	15mm	4233	846.6	23.29	24.00	1.178	0.03	0.105	0.124

<FDD LTE SAR>

Plot No.	Band	BW (MHz)	Modulation	RB Size	RB offset	Test Position	Gap (mm)	Ch.	Freq. (MHz)	Average Power (dBm)	Tune-Up Limit (dBm)	Tune-up Scaling Factor	Power Drift (dB)	Measured 1g SAR (W/kg)	Reported 1g SAR (W/kg)
32	LTE Band 2	20M	QPSK	1	0	Front	15mm	18700	1860	23.68	24.00	1.076	-0.15	0.328	0.353
	LTE Band 2	20M	QPSK	50	0	Front	15mm	18700	1860	22.46	23.00	1.132	-0.11	0.250	0.283
	LTE Band 2	20M	QPSK	1	0	Back	15mm	18700	1860	23.68	24.00	1.076	-0.01	0.081	0.087
	LTE Band 2	20M	QPSK	50	0	Back	15mm	18700	1860	22.46	23.00	1.132	-0.06	0.063	0.071
33	LTE Band 4	20M	QPSK	1	0	Front	15mm	20175	1732.5	23.66	24.00	1.081	-0.08	0.356	0.385
	LTE Band 4	20M	QPSK	50	0	Front	15mm	20175	1732.5	22.55	23.00	1.109	-0.02	0.271	0.301
	LTE Band 4	20M	QPSK	1	0	Back	15mm	20175	1732.5	23.66	24.00	1.081	-0.07	0.053	0.057
	LTE Band 4	20M	QPSK	50	0	Back	15mm	20175	1732.5	22.55	23.00	1.109	0.05	0.040	0.044
34	LTE Band 5	10M	QPSK	1	0	Front	15mm	20525	836.5	22.73	24.50	1.503	0.01	0.147	0.221
	LTE Band 5	10M	QPSK	25	0	Front	15mm	20525	836.5	21.65	23.50	1.531	0	0.116	0.178
	LTE Band 5	10M	QPSK	1	0	Back	15mm	20525	836.5	22.73	24.50	1.503	0.02	0.099	0.149
	LTE Band 5	10M	QPSK	25	0	Back	15mm	20525	836.5	21.65	23.50	1.531	0.04	0.079	0.121
35	LTE Band 7	20M	QPSK	1	0	Front	15mm	21350	2560	24.00	24.50	1.122	0.05	0.423	0.475
	LTE Band 7	20M	QPSK	50	0	Front	15mm	21350	2560	23.00	23.50	1.122	0.01	0.329	0.369
	LTE Band 7	20M	QPSK	1	0	Back	15mm	21350	2560	24.00	24.50	1.122	0	0.331	0.371
	LTE Band 7	20M	QPSK	50	0	Back	15mm	21350	2560	23.00	23.50	1.122	0	0.258	0.289



<TDD LTE SAR>

Plot No.	Band	BW (MHz)	Modulation	RB Size	RB offset	Test Position	Gap (mm)	Ch.	Freq. (MHz)	Average Power (dBm)	Tune-Up Limit (dBm)	Tune-up Scaling Factor	Duty Cycle %	Duty Cycle Scaling Factor	Power Drift (dB)	Measured 1g SAR (W/kg)	Reported 1g SAR (W/kg)
36	LTE Band 41	20M	QPSK	1	0	Front	15mm	41055	2636.5	23.58	24.00	1.102	62.9	1.006	-0.02	0.176	0.195
	LTE Band 41	20M	QPSK	50	0	Front	15mm	41055	2636.5	22.72	23.00	1.067	62.9	1.006	0.03	0.136	0.146
	LTE Band 41	20M	QPSK	1	0	Back	15mm	41055	2636.5	23.58	24.00	1.102	62.9	1.006	-0.01	0.151	0.167
	LTE Band 41	20M	QPSK	50	0	Back	15mm	41055	2636.5	22.72	23.00	1.067	62.9	1.006	-0.03	0.116	0.124

<WLAN SAR>

Plot No.	Band	Mode	Test Position	Gap (mm)	Antenna	Power Reduction	Ch.	Freq. (MHz)	Average Power (dBm)	Tune-Up Limit (dBm)	Tune-up Scaling Factor	Duty Cycle %	Duty Cycle Scaling Factor	Power Drift (dB)	Measured 1g SAR (W/kg)	Reported 1g SAR (W/kg)
37	WLAN2.4GHz	802.11b 1Mbps	Front	15mm	Ant 1	OFF	1	2412	17.81	18.00	1.044	98.54	1.015	0.14	0.126	0.133
	WLAN2.4GHz	802.11b 1Mbps	Back	15mm	Ant 1	OFF	1	2412	17.81	18.00	1.044	98.54	1.015	0.15	0.061	0.065
	WLAN2.4GHz	802.11b 1Mbps	Front	15mm	Ant 2	OFF	1	2412	17.74	18.00	1.061	99.03	1.010	0.13	0.028	0.030
	WLAN2.4GHz	802.11b 1Mbps	Back	15mm	Ant 2	OFF	1	2412	17.74	18.00	1.061	99.03	1.010	0.19	0.020	0.021
	WLAN5GHz	802.11n-HT40 MCS0	Front	15mm	Ant 1	OFF	62	5310	16.54	17.00	1.111	90.29	1.108	-0.13	0.045	0.055
	WLAN5GHz	802.11n-HT40 MCS0	Back	15mm	Ant 1	OFF	62	5310	16.54	17.00	1.111	90.29	1.108	0	0.001	0.001
38	WLAN5GHz	802.11n-HT40 MCS0	Front	15mm	Ant 2	OFF	62	5310	16.63	17.00	1.089	89.71	1.115	0.08	0.122	0.148
	WLAN5GHz	802.11n-HT40 MCS0	Back	15mm	Ant 2	OFF	62	5310	16.63	17.00	1.089	89.71	1.115	0	0.001	0.001
	WLAN5GHz	802.11n-HT40 MCS0	Front	15mm	Ant 1	OFF	102	5510	16.52	17.00	1.116	90.29	1.108	-0.17	0.065	0.080
	WLAN5GHz	802.11n-HT40 MCS0	Back	15mm	Ant 1	OFF	102	5510	16.52	17.00	1.116	90.29	1.108	0.03	0.002	0.002
39	WLAN5GHz	802.11n-HT40 MCS0	Front	15mm	Ant 2	OFF	102	5510	16.72	17.00	1.066	89.71	1.115	-0.13	0.080	0.095
	WLAN5GHz	802.11n-HT40 MCS0	Back	15mm	Ant 2	OFF	102	5510	16.72	17.00	1.066	89.71	1.115	0.12	0.001	0.001
40	WLAN5GHz	802.11n-HT40 MCS0	Front	15mm	Ant 1	OFF	159	5795	16.79	17.00	1.049	90.29	1.108	0.04	0.186	0.216
	WLAN5GHz	802.11n-HT40 MCS0	Back	15mm	Ant 1	OFF	159	5795	16.79	17.00	1.049	90.29	1.108	-0.01	0.026	0.030
	WLAN5GHz	802.11n-HT40 MCS0	Front	15mm	Ant 2	OFF	159	5795	16.67	17.00	1.079	89.71	1.115	-0.11	0.058	0.070
	WLAN5GHz	802.11n-HT40 MCS0	Back	15mm	Ant 2	OFF	159	5795	16.67	17.00	1.079	89.71	1.115	-0.14	0.032	0.038



15.5 Repeated SAR Measurement

No.	Band	Mode	Test Position	Gap (mm)	Antenna	Power Reduction	Ch.	Freq. (MHz)	Average Power (dBm)	Tune-Up Limit (dBm)	Tune-up Scaling Factor	Duty Cycle %	Duty Cycle Scaling Factor	Power Drift (dB)	Measured 1g SAR (W/kg)	Ratio	Reported 1g SAR (W/kg)
1st	WLAN5GHz	802.11n-HT40 MCS0	Right Cheek	0mm	Ant 1	ON	110	5550	14.95	15.00	1.011	90.29	1.108	0	0.944		1.057
2nd	WLAN5GHz	802.11n-HT40 MCS0	Right Cheek	0mm	Ant 1	ON	110	5550	14.95	15.00	1.011	90.29	1.108	0.07	0.920	1.03	1.030
1st	WLAN5GHz	802.11n-HT40 MCS0	Right Cheek	0mm	Ant 1	ON	159	5795	13.38	13.50	1.027	90.29	1.108	0.11	0.957		1.089
2nd	WLAN5GHz	802.11n-HT40 MCS0	Right Cheek	0mm	Ant 1	ON	159	5795	13.38	13.50	1.027	90.29	1.108	0.14	0.931	1.03	1.060

No.	Band	Mode	Test Position	Gap (mm)	Ch.	Freq. (MHz)	Average Power (dBm)	Tune-Up Limit (dBm)	Tune-up Scaling Factor	Power Drift (dB)	Measured 1g SAR (W/kg)	Ratio	Reported 1g SAR (W/kg)
1st	GSM1900	GPRS (4 Tx slots)	Bottom Side	10mm	512	1850.2	24.02	25.00	1.253	-0.11	0.957		1.199
2nd	GSM1900	GPRS (4 Tx slots)	Bottom Side	10mm	512	1850.2	24.02	25.00	1.253	-0.12	0.901	1.06	1.129
1st	LTE Band 4	20M_QPSK_1_0	Front	10mm	20175	1732.5	23.66	24.00	1.081	-0.09	0.843		0.912
2nd	LTE Band 4	20M_QPSK_1_0	Front	10mm	20175	1732.5	23.66	24.00	1.081	-0.12	0.801	1.05	0.866
1st	LTE Band 7	20M_QPSK_1_0	Front	10mm	20850	2510	23.46	24.50	1.271	-0.05	0.892		1.133
2nd	LTE Band 7	20M_QPSK_1_0	Front	10mm	20850	2510	23.46	24.50	1.271	-0.04	0.879	1.01	1.117

General Note:

1. Per KDB 865664 D01v01r04, for each frequency band, repeated SAR measurement is required only when the measured SAR is $\geq 0.8W/kg$.
2. Per KDB 865664 D01v01r04, if the ratio among the repeated measurement is ≤ 1.2 and the measured SAR $< 1.45W/kg$, only one repeated measurement is required.
3. The ratio is the difference in percentage between original and repeated *measured* SAR.
4. All measurement SAR result is scaled-up to account for tune-up tolerance and is compliant.

16. Simultaneous Transmission Analysis

NO.	Simultaneous Transmission Configurations	Portable Handset			
		Head	Body-worn	Hotspot	Product Specific
1.	WWAN (Voice) + WLAN Ant 1 + WLAN Ant 2	Yes	Yes		Yes
2.	WWAN (Data) + WLAN Ant 1 + WLAN Ant 2	Yes	Yes	Yes	Yes
3.	WWAN (Voice) + Bluetooth Ant 1 + WLAN Ant 2		Yes		Yes
4.	WWAN (Data) + Bluetooth Ant 1 + WLAN Ant 2		Yes		Yes

General Note:

1. This device 2.4GHz / 5.2GHz / 5.8GHz WLAN supports Hotspot operation.
2. WLAN and Bluetooth share the same antenna1, and cannot transmit simultaneously.
3. For WLAN SAR testing was performed on single antenna RF power in SISO mode is larger or equal to the single antenna RF power in MIMO mode, and for RF exposure assessment of MIMO mode simultaneous transmission exclusion analysis was performed with SAR test results of each antenna in SISO mode.
4. The worst case WLAN reported SAR for each configuration was used for SAR summation. Therefore, the following summations represent the absolute worst cases for simultaneous transmission with WLAN.
5. The Scaled SAR summation is calculated based on the same configuration and test position.
6. Per KDB 447498 D01v06, simultaneous transmission SAR is compliant if,
 - i) Scalar SAR summation < 1.6W/kg.
 - ii) $SPLSR = (SAR1 + SAR2)^{1.5} / (\text{min. separation distance, mm})$, and the peak separation distance is determined from the square root of $[(x1-x2)^2 + (y1-y2)^2 + (z1-z2)^2]$, where (x1, y1, z1) and (x2, y2, z2) are the coordinates of the extrapolated peak SAR locations in the zoom scan.
 - iii) If $SPLSR \leq 0.04$, simultaneously transmission SAR measurement is not necessary.
 - iv) Simultaneously transmission SAR measurement, and the reported multi-band SAR < 1.6W/kg.
 - v) The SPLSR calculated results please refer to section 16.5.
7. For simultaneous transmission analysis, Bluetooth SAR is estimated per KDB 447498 D01v06 based on the formula below.
 - i) $(\text{max. power of channel, including tune-up tolerance, mW}) / (\text{min. test separation distance, mm}) \cdot [\sqrt{f(\text{GHz})} / x] \text{ W/kg}$ for test separation distances $\leq 50 \text{ mm}$; where $x = 7.5$ for 1-g SAR, and $x = 18.75$ for 10-g SAR.
 - ii) When the minimum separation distance is < 5mm, the distance is used 5mm to determine SAR test exclusion.
 - iii) 0.4 W/kg for 1-g SAR and 1.0 W/kg for 10-g SAR, when the test separation distances is > 50 mm.

Bluetooth Max Power	Exposure Position	Body worn
	Test separation	15 mm
11.5dBm	Estimated 1g SAR (W/kg)	0.196W/kg

Bluetooth Max Power	Exposure Position	Product Specific
	Test separation	5 mm
11.5dBm	Estimated 10g SAR (W/kg)	0.235W/kg



16.1 Head Exposure Conditions

WWAN Band	Exposure Position	1	2	3	4	5	1+2+3 Summed 1g SAR (W/kg)	1+2+5 Summed 1g SAR (W/kg)	1+3+4 Summed 1g SAR (W/kg)	1+4+5 Summed 1g SAR (W/kg)	SPLSR	Case No	
		WWAN	2.4GHz WLAN Ant 1	2.4GHz WLAN Ant 2	5GHz WLAN Ant 1	5GHz WLAN Ant 2							
		1g SAR (W/kg)	1g SAR (W/kg)	1g SAR (W/kg)	1g SAR (W/kg)	1g SAR (W/kg)							
GSM	GSM850	Right Cheek	0.131	0.774	0.121	1.089	0.364	1.03	1.27	1.34	1.58		
		Right Tilted	0.070	0.582	0.080	0.942	0.354	0.73	1.01	1.09	1.37		
		Left Cheek	0.125	0.326	0.450	0.777	0.860	0.90	1.31	1.35	1.76	0.04	Case 1
		Left Tilted	0.087	0.259	0.279	0.544	0.667	0.63	1.01	0.91	1.30		
	GSM1900	Right Cheek	0.088	0.774	0.121	1.089	0.364	0.98	1.23	1.30	1.54		
		Right Tilted	0.076	0.582	0.080	0.942	0.354	0.74	1.01	1.10	1.37		
		Left Cheek	0.182	0.326	0.450	0.777	0.860	0.96	1.37	1.41	1.82	0.04	Case 2
		Left Tilted	0.063	0.259	0.279	0.544	0.667	0.60	0.99	0.89	1.27		
WCDMA	WCDMA II	Right Cheek	0.107	0.774	0.121	1.089	0.364	1.00	1.25	1.32	1.56		
		Right Tilted	0.098	0.582	0.080	0.942	0.354	0.76	1.03	1.12	1.39		
		Left Cheek	0.244	0.326	0.450	0.777	0.860	1.02	1.43	1.47	1.88	0.04	Case 3
		Left Tilted	0.081	0.259	0.279	0.544	0.667	0.62	1.01	0.90	1.29		
	WCDMA V	Right Cheek	0.141	0.774	0.121	1.089	0.364	1.04	1.28	1.35	1.59		
		Right Tilted	0.069	0.582	0.080	0.942	0.354	0.73	1.01	1.09	1.37		
		Left Cheek	0.117	0.326	0.450	0.777	0.860	0.89	1.30	1.34	1.75	0.04	Case 4
		Left Tilted	0.074	0.259	0.279	0.544	0.667	0.61	1.00	0.90	1.29		
LTE	LTE Band 2	Right Cheek	0.070	0.774	0.121	1.089	0.364	0.97	1.21	1.28	1.52		
		Right Tilted	0.056	0.582	0.080	0.942	0.354	0.72	0.99	1.08	1.35		
		Left Cheek	0.156	0.326	0.450	0.777	0.860	0.93	1.34	1.38	1.79	0.04	Case 5
		Left Tilted	0.053	0.259	0.279	0.544	0.667	0.59	0.98	0.88	1.26		
	LTE Band 4	Right Cheek	0.061	0.774	0.121	1.089	0.364	0.96	1.20	1.27	1.51		
		Right Tilted	0.050	0.582	0.080	0.942	0.354	0.71	0.99	1.07	1.35		
		Left Cheek	0.141	0.326	0.450	0.777	0.860	0.92	1.33	1.37	1.78	0.04	Case 6
		Left Tilted	0.054	0.259	0.279	0.544	0.667	0.59	0.98	0.88	1.27		
	LTE Band 5	Right Cheek	0.176	0.774	0.121	1.089	0.364	1.07	1.31	1.39	1.63	0.03	Case 7
		Right Tilted	0.069	0.582	0.080	0.942	0.354	0.73	1.01	1.09	1.37		
		Left Cheek	0.161	0.326	0.450	0.777	0.860	0.94	1.35	1.39	1.80	0.04	Case 8
		Left Tilted	0.093	0.259	0.279	0.544	0.667	0.63	1.02	0.92	1.30		
	LTE Band 7	Right Cheek	0.178	0.774	0.121	1.089	0.364	1.07	1.32	1.39	1.63	0.03	Case 9
		Right Tilted	0.071	0.582	0.080	0.942	0.354	0.73	1.01	1.09	1.37		
		Left Cheek	0.176	0.326	0.450	0.777	0.860	0.95	1.36	1.40	1.81	0.04	Case 10
		Left Tilted	0.139	0.259	0.279	0.544	0.667	0.68	1.07	0.96	1.35		
LTE Band 41	Right Cheek	0.124	0.774	0.121	1.089	0.364	1.02	1.26	1.33	1.58			
	Right Tilted	0.041	0.582	0.080	0.942	0.354	0.70	0.98	1.06	1.34			
	Left Cheek	0.092	0.326	0.450	0.777	0.860	0.87	1.28	1.32	1.73	0.04	Case 11	
	Left Tilted	0.072	0.259	0.279	0.544	0.667	0.61	1.00	0.90	1.28			



16.2 Hotspot Exposure Conditions

WWAN Band	Exposure Position	1	2	3	4	5	1+2+3 Summed 1g SAR (W/kg)	1+2+5 Summed 1g SAR (W/kg)	1+3+4 Summed 1g SAR (W/kg)	1+4+5 Summed 1g SAR (W/kg)	SPLSR	Case No	
		WWAN	2.4GHz WLAN Ant 1	2.4GHz WLAN Ant 2	5GHz WLAN Ant 1	5GHz WLAN Ant 2							
		1g SAR (W/kg)	1g SAR (W/kg)	1g SAR (W/kg)	1g SAR (W/kg)	1g SAR (W/kg)							
GSM	GSM850	Front	0.249	0.201	0.084	0.361	0.203	0.53	0.65	0.69	0.81		
		Back	0.136	0.073	0.039	0.035	0.034	0.25	0.24	0.21	0.21		
		Left side	0.104	0.092		0.105		0.20	0.20	0.21	0.21		
		Right side	0.224		0.034		0.038	0.26	0.26	0.26	0.26		
		Top side		0.054	0.028	0.123	0.085	0.08	0.14	0.15	0.21		
		Bottom side	0.114					0.11	0.11	0.11	0.11		
	GSM1900	Front	1.075	0.201	0.084	0.361	0.203	1.36	1.48	1.52	1.64	0.01	Case 12
		Back	0.172	0.073	0.039	0.035	0.034	0.28	0.28	0.25	0.24		
		Left side	0.300	0.092		0.105		0.39	0.39	0.41	0.41		
		Right side	0.010		0.034		0.038	0.04	0.05	0.04	0.05		
		Top side		0.054	0.028	0.123	0.085	0.08	0.14	0.15	0.21		
		Bottom side	1.199					1.20	1.20	1.20	1.20		
WCDMA	WCDMA II	Front	0.764	0.201	0.084	0.361	0.203	1.05	1.17	1.21	1.33		
		Back	0.116	0.073	0.039	0.035	0.034	0.23	0.22	0.19	0.19		
		Left side	0.175	0.092		0.105		0.27	0.27	0.28	0.28		
		Right side	0.005		0.034		0.038	0.04	0.04	0.04	0.04		
		Top side		0.054	0.028	0.123	0.085	0.08	0.14	0.15	0.21		
		Bottom side	0.775					0.78	0.78	0.78	0.78		
	WCDMA V	Front	0.259	0.201	0.084	0.361	0.203	0.54	0.66	0.70	0.82		
		Back	0.132	0.073	0.039	0.035	0.034	0.24	0.24	0.21	0.20		
		Left side	0.085	0.092		0.105		0.18	0.18	0.19	0.19		
		Right side	0.192		0.034		0.038	0.23	0.23	0.23	0.23		
		Top side		0.054	0.028	0.123	0.085	0.08	0.14	0.15	0.21		
		Bottom side	0.108					0.11	0.11	0.11	0.11		



WWAN Band	Exposure Position	1	2	3	4	5	1+2+3 Summed 1g SAR (W/kg)	1+2+5 Summed 1g SAR (W/kg)	1+3+4 Summed 1g SAR (W/kg)	1+4+5 Summed 1g SAR (W/kg)	SPLSR	Case No	
		WWAN	2.4GHz WLAN Ant 1	2.4GHz WLAN Ant 2	5GHz WLAN Ant 1	5GHz WLAN Ant 2							
		1g SAR (W/kg)	1g SAR (W/kg)	1g SAR (W/kg)	1g SAR (W/kg)	1g SAR (W/kg)							
LTE	LTE Band 2	Front	0.904	0.201	0.084	0.361	0.203	1.19	1.31	1.35	1.47		
		Back	0.139	0.073	0.039	0.035	0.034	0.25	0.25	0.21	0.21		
		Left side	0.213	0.092		0.105		0.31	0.31	0.32	0.32		
		Right side	0.007		0.034		0.038	0.04	0.05	0.04	0.05		
		Top side		0.054	0.028	0.123	0.085	0.08	0.14	0.15	0.21		
		Bottom side	0.878					0.88	0.88	0.88	0.88		
	LTE Band 4	Front	0.912	0.201	0.084	0.361	0.203	1.20	1.32	1.36	1.48		
		Back	0.119	0.073	0.039	0.035	0.034	0.23	0.23	0.19	0.19		
		Left side	0.106	0.092		0.105		0.20	0.20	0.21	0.21		
		Right side	0.010		0.034		0.038	0.04	0.05	0.04	0.05		
		Top side		0.054	0.028	0.123	0.085	0.08	0.14	0.15	0.21		
		Bottom side	0.842					0.84	0.84	0.84	0.84		
	LTE Band 5	Front	0.307	0.201	0.084	0.361	0.203	0.59	0.71	0.75	0.87		
		Back	0.171	0.073	0.039	0.035	0.034	0.28	0.28	0.25	0.24		
		Left side	0.116	0.092		0.105		0.21	0.21	0.22	0.22		
		Right side	0.248		0.034		0.038	0.28	0.29	0.28	0.29		
		Top side		0.054	0.028	0.123	0.085	0.08	0.14	0.15	0.21		
		Bottom side	0.134					0.13	0.13	0.13	0.13		
	LTE Band 7	Front	1.133	0.201	0.084	0.361	0.203	1.42	1.54	1.58	1.70	0.01	Case 13
		Back	0.664	0.073	0.039	0.035	0.034	0.78	0.77	0.74	0.73		
		Left side	0.141	0.092		0.105		0.23	0.23	0.25	0.25		
		Right side	0.643		0.034		0.038	0.68	0.68	0.68	0.68		
		Top side		0.054	0.028	0.123	0.085	0.08	0.14	0.15	0.21		
		Bottom side	0.787					0.79	0.79	0.79	0.79		
LTE Band 41	Front	0.395	0.201	0.084	0.361	0.203	0.68	0.80	0.84	0.96			
	Back	0.347	0.073	0.039	0.035	0.034	0.46	0.45	0.42	0.42			
	Left side	0.069	0.092		0.105		0.16	0.16	0.17	0.17			
	Right side	0.296		0.034		0.038	0.33	0.33	0.33	0.33			
	Top side		0.054	0.028	0.123	0.085	0.08	0.14	0.15	0.21			
	Bottom side	0.365					0.37	0.37	0.37	0.37			

16.3 Product Specific Exposure Conditions

Exposure Position	1	2	3	4	5	6	1+2+3 Summed 10g SAR (W/kg)	1+2+5 Summed 10g SAR (W/kg)	1+3+4 Summed 10g SAR (W/kg)	1+4+5 Summed 10g SAR (W/kg)	1+3+6 Summed 10g SAR (W/kg)	1+5+6 Summed 10g SAR (W/kg)
	WWAN	2.4GHz WLAN Ant 1	2.4GHz WLAN Ant 2	5GHz WLAN Ant 1	5GHz WLAN Ant 2	Bluetooth Ant 1						
	10g SAR (W/kg)	10g SAR (W/kg)	10g SAR (W/kg)	10g SAR (W/kg)	10g SAR (W/kg)	Estimated 10g SAR (W/kg)						
Product Specific	-	-	-	0.365	1.015	0.235	-	1.11	0.37	1.38	0.24	1.25

Remark:

- The worst case 5GHz WLAN results are taking from 5.3GHz (U-NII-2A) and 5.5GHz (U-NII-2C) perform product specific simultaneous transmission analysis.
- According to KDB 648474 D04v01r01, for WWAN / 2.4GHz WLAN hand SAR ("") was excluded, since WWAN / 2.4GHz WLAN hotspot SAR was < 1.2W/kg.



16.4 Body-Worn Accessory Exposure Conditions

WWAN Band		Exposure Position	1	2	3	4	5	1+2+3 Summed 1g SAR (W/kg)	1+2+5 Summed 1g SAR (W/kg)	1+3+4 Summed 1g SAR (W/kg)	1+4+5 Summed 1g SAR (W/kg)
			WWAN	2.4GHz WLAN Ant 1	2.4GHz WLAN Ant 2	5GHz WLAN Ant 1	5GHz WLAN Ant 2				
			1g SAR (W/kg)	1g SAR (W/kg)	1g SAR (W/kg)	1g SAR (W/kg)	1g SAR (W/kg)				
GSM	GSM850	Front	0.192	0.133	0.030	0.216	0.148	0.36	0.47	0.44	0.56
		Back	0.139	0.065	0.021	0.030	0.038	0.23	0.24	0.19	0.21
	GSM1900	Front	0.486	0.133	0.030	0.216	0.148	0.65	0.77	0.73	0.85
		Back	0.088	0.065	0.021	0.030	0.038	0.17	0.19	0.14	0.16
WCDMA	WCDMA II	Front	0.334	0.133	0.030	0.216	0.148	0.50	0.62	0.58	0.70
		Back	0.084	0.065	0.021	0.030	0.038	0.17	0.19	0.14	0.15
	WCDMA V	Front	0.168	0.133	0.030	0.216	0.148	0.33	0.45	0.41	0.53
		Back	0.124	0.065	0.021	0.030	0.038	0.21	0.23	0.18	0.19
LTE	LTE Band 2	Front	0.353	0.133	0.030	0.216	0.148	0.52	0.63	0.60	0.72
		Back	0.087	0.065	0.021	0.030	0.038	0.17	0.19	0.14	0.16
	LTE Band 4	Front	0.385	0.133	0.030	0.216	0.148	0.55	0.67	0.63	0.75
		Back	0.057	0.065	0.021	0.030	0.038	0.14	0.16	0.11	0.13
	LTE Band 5	Front	0.221	0.133	0.030	0.216	0.148	0.38	0.50	0.47	0.59
		Back	0.149	0.065	0.021	0.030	0.038	0.24	0.25	0.20	0.22
	LTE Band 7	Front	0.475	0.133	0.030	0.216	0.148	0.64	0.76	0.72	0.84
		Back	0.371	0.065	0.021	0.030	0.038	0.46	0.47	0.42	0.44
	LTE Band 41	Front	0.195	0.133	0.030	0.216	0.148	0.36	0.48	0.44	0.56
		Back	0.167	0.065	0.021	0.030	0.038	0.25	0.27	0.22	0.24

WWAN Band		Exposure Position	1	3	5	6	1+3+6 Summed 1g SAR (W/kg)	1+5+6 Summed 1g SAR (W/kg)
			WWAN	2.4GHz WLAN Ant 2	5GHz WLAN Ant 2	Bluetooth Ant 1		
			1g SAR (W/kg)	1g SAR (W/kg)	1g SAR (W/kg)	Estimated 1g SAR (W/kg)		
GSM	GSM850	Front	0.192	0.030	0.148	0.196	0.42	0.54
		Back	0.139	0.021	0.038	0.196	0.36	0.37
	GSM1900	Front	0.486	0.030	0.148	0.196	0.71	0.83
		Back	0.088	0.021	0.038	0.196	0.31	0.32
WCDMA	WCDMA II	Front	0.334	0.030	0.148	0.196	0.56	0.68
		Back	0.084	0.021	0.038	0.196	0.30	0.32
	WCDMA V	Front	0.168	0.030	0.148	0.196	0.39	0.51
		Back	0.124	0.021	0.038	0.196	0.34	0.36
LTE	LTE Band 2	Front	0.353	0.030	0.148	0.196	0.58	0.70
		Back	0.087	0.021	0.038	0.196	0.30	0.32
	LTE Band 4	Front	0.385	0.030	0.148	0.196	0.61	0.73
		Back	0.057	0.021	0.038	0.196	0.27	0.29
	LTE Band 5	Front	0.221	0.030	0.148	0.196	0.45	0.57
		Back	0.149	0.021	0.038	0.196	0.37	0.38
	LTE Band 7	Front	0.475	0.030	0.148	0.196	0.70	0.82
		Back	0.371	0.021	0.038	0.196	0.59	0.61
	LTE Band 41	Front	0.195	0.030	0.148	0.196	0.42	0.54
		Back	0.167	0.021	0.038	0.196	0.38	0.40

16.5 SPLSR Evaluation and Analysis

General Note:

- SPLSR = $(SAR_1 + SAR_2)^{1.5} / (\text{min. separation distance, mm})$. If $SPLSR \leq 0.04$, simultaneously transmission SAR measurement is not necessary

	Band	Position	SAR (W/kg)	Gap (cm)	SAR peak location (m)			3D distance (mm)	Summed SAR (W/kg)	SPLSR Results	Simultaneous SAR
					X	Y	Z				
Case 1	GSM850	Left Cheek	0.125	0	5.02	-2.74	-0.32	69.9	0.90	0.01	Not required
	WLAN5GHz Ant 1		0.777	0	-1.92	-2.59	0.47				
	GSM850	Left Cheek	0.125	0	5.02	-2.74	-0.32	65.6	0.99	0.01	Not required
	WLAN5GHz Ant 2		0.86	0	0.62	2.12	-0.21				
	WLAN5GHz Ant 1	Left Cheek	0.777	0	-1.92	-2.59	0.47	53.9	1.64	0.04	Not required
	WLAN5GHz Ant 2		0.86	0	0.62	2.12	-0.21				

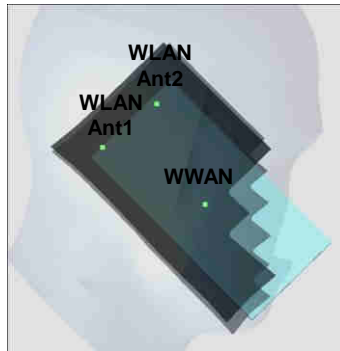

	Band	Position	SAR (W/kg)	Gap (cm)	SAR peak location (m)			3D distance (mm)	Summed SAR (W/kg)	SPLSR Results	Simultaneous SAR
					X	Y	Z				
Case 2	GSM1900	Left Cheek	0.182	0	4.91	-5.89	-0.14	76.1	0.96	0.01	Not required
	WLAN5GHz Ant 1		0.777	0	-1.92	-2.59	0.47				
	GSM1900	Left Cheek	0.182	0	4.91	-5.89	-0.14	90.9	1.04	0.01	Not required
	WLAN5GHz Ant 2		0.86	0	0.62	2.12	-0.21				
	WLAN5GHz Ant 1	Left Cheek	0.777	0	-1.92	-2.59	0.47	53.9	1.64	0.04	Not required
	WLAN5GHz Ant 2		0.86	0	0.62	2.12	-0.21				

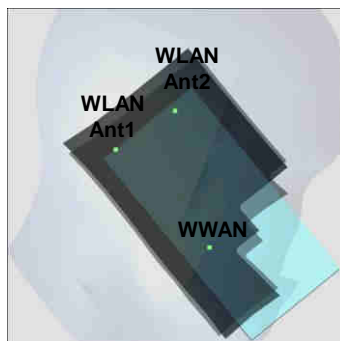

Case 3	Band	Position	SAR (W/kg)	Gap (cm)	SAR peak location (m)			3D distance (mm)	Summed SAR (W/kg)	SPLSR Results	Simultaneous SAR
					X	Y	Z				
WCDMA II	Left Cheek	0.244	0	5.31	-6.23	-0.05	81.1	1.02	0.01	Not required	
		0.777	0	-1.92	-2.59	0.47					
WCDMA II	Left Cheek	0.244	0	5.31	-6.23	-0.05	95.8	1.10	0.01	Not required	
		0.86	0	0.62	2.12	-0.21					
WLAN5GHz Ant 1	Left Cheek	0.777	0	-1.92	-2.59	0.47	53.9	1.64	0.04	Not required	
		0.86	0	0.62	2.12	-0.21					

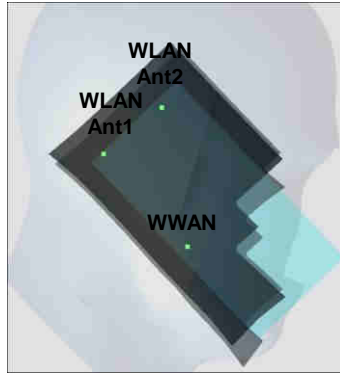

Case 4	Band	Position	SAR (W/kg)	Gap (cm)	SAR peak location (m)			3D distance (mm)	Summed SAR (W/kg)	SPLSR Results	Simultaneous SAR
					X	Y	Z				
WCDMA V	Left Cheek	0.117	0	5.1	-2.6	-0.32	70.6	0.89	0.01	Not required	
		0.777	0	-1.92	-2.59	0.47					
WCDMA V	Left Cheek	0.117	0	5.1	-2.6	-0.32	65.1	0.98	0.01	Not required	
		0.86	0	0.62	2.12	-0.21					
WLAN5GHz Ant 1	Left Cheek	0.777	0	-1.92	-2.59	0.47	53.9	1.64	0.04	Not required	
		0.86	0	0.62	2.12	-0.21					

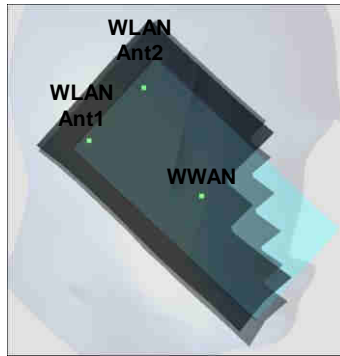

Case 5	Band	Position	SAR (W/kg)	Gap (cm)	SAR peak location (m)			3D distance (mm)	Summed SAR (W/kg)	SPLSR Results	Simultaneous SAR
					X	Y	Z				
Case 5	LTE Band 2	Left Cheek	0.156	0	5.46	-6.21	-0.04	82.4	0.93	0.01	Not required
	WLAN5GHz Ant 1		0.777	0	-1.92	-2.59	0.47				
Case 5	LTE Band 2	Left Cheek	0.156	0	5.46	-6.21	-0.04	96.4	1.02	0.01	Not required
	WLAN5GHz Ant 2		0.86	0	0.62	2.12	-0.21				
Case 5	WLAN5GHz Ant 1	Left Cheek	0.777	0	-1.92	-2.59	0.47	53.9	1.64	0.04	Not required
	WLAN5GHz Ant 2		0.86	0	0.62	2.12	-0.21				

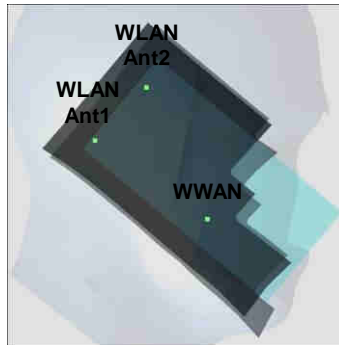

Case 6	Band	Position	SAR (W/kg)	Gap (cm)	SAR peak location (m)			3D distance (mm)	Summed SAR (W/kg)	SPLSR Results	Simultaneous SAR
					X	Y	Z				
Case 6	LTE Band 4	Left Cheek	0.141	0	5.13	-6.54	-0.04	81.0	0.92	0.01	Not required
	WLAN5GHz Ant 1		0.777	0	-1.92	-2.59	0.47				
Case 6	LTE Band 4	Left Cheek	0.141	0	5.13	-6.54	-0.04	97.7	1.00	0.01	Not required
	WLAN5GHz Ant 2		0.86	0	0.62	2.12	-0.21				
Case 6	WLAN5GHz Ant 1	Left Cheek	0.777	0	-1.92	-2.59	0.47	53.9	1.64	0.04	Not required
	WLAN5GHz Ant 2		0.86	0	0.62	2.12	-0.21				

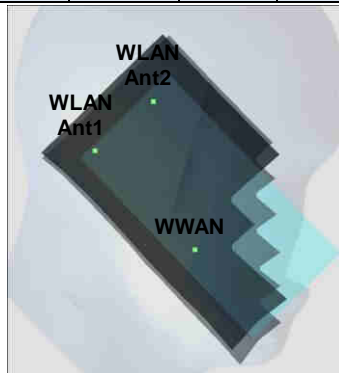

Case 7	Band	Position	SAR (W/kg)	Gap (cm)	SAR peak location (m)			3D distance (mm)	Summed SAR (W/kg)	SPLSR Results	Simultaneous SAR
					X	Y	Z				
	LTE Band 5	Right Cheek	0.176	0	5.19	5.01	-0.24	85.7	1.27	0.02	Not required
	WLAN5GHz Ant 1		1.089	0	0.79	-2.34	-0.27				
	LTE Band 5	Right Cheek	0.176	0	5.19	5.01	-0.24	75.2	0.54	0.01	Not required
	WLAN5GHz Ant 2		0.364	0	-1.84	2.42	0.39				
	WLAN5GHz Ant 1	Right Cheek	1.089	0	0.79	-2.34	-0.27	54.8	1.45	0.03	Not required
	WLAN5GHz Ant 2		0.364	0	-1.84	2.42	0.39				

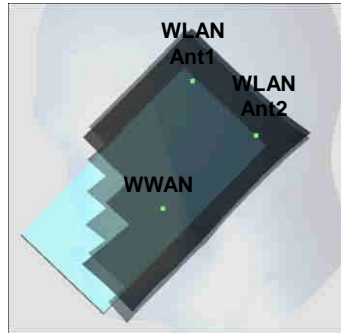

Case 8	Band	Position	SAR (W/kg)	Gap (cm)	SAR peak location (m)			3D distance (mm)	Summed SAR (W/kg)	SPLSR Results	Simultaneous SAR
					X	Y	Z				
	LTE Band 5	Left Cheek	0.161	0	5.82	-5.79	-0.01	83.9	0.94	0.01	Not required
	WLAN5GHz Ant 1		0.777	0	-1.92	-2.59	0.47				
	LTE Band 5	Left Cheek	0.161	0	5.82	-5.79	-0.01	94.7	1.02	0.01	Not required
	WLAN5GHz Ant 2		0.86	0	0.62	2.12	-0.21				
	WLAN5GHz Ant 1	Left Cheek	0.777	0	-1.92	-2.59	0.47	53.9	1.64	0.04	Not required
	WLAN5GHz Ant 2		0.86	0	0.62	2.12	-0.21				

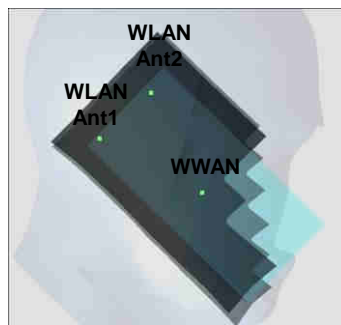

Case 9	Band	Position	SAR (W/kg)	Gap (cm)	SAR peak location (m)			3D distance (mm)	Summed SAR (W/kg)	SPLSR Results	Simultaneous SAR
					X	Y	Z				
Case 9	LTE Band 7	Right Cheek	0.178	0	4.04	6.69	-0.15	96.0	1.27	0.01	Not required
	WLAN5GHz Ant 1		1.089	0	0.79	-2.34	-0.27				
	LTE Band 7	Right Cheek	0.178	0	4.04	6.69	-0.15	72.9	0.54	0.01	Not required
	WLAN5GHz Ant 2		0.364	0	-1.84	2.42	0.39				
	WLAN5GHz Ant 1	Right Cheek	1.089	0	0.79	-2.34	-0.27	54.8	1.45	0.03	Not required
	WLAN5GHz Ant 2		0.364	0	-1.84	2.42	0.39				

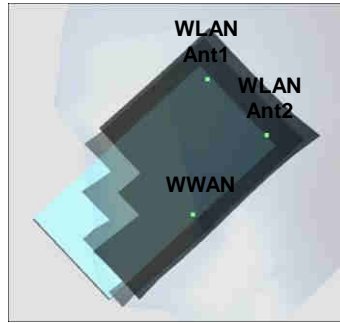

Case 10	Band	Position	SAR (W/kg)	Gap (cm)	SAR peak location (m)			3D distance (mm)	Summed SAR (W/kg)	SPLSR Results	Simultaneous SAR
					X	Y	Z				
Case 10	LTE Band 7	Left Cheek	0.176	0	5.17	-6.73	0.05	82.2	0.95	0.01	Not required
	WLAN5GHz Ant 1		0.777	0	-1.92	-2.59	0.47				
	LTE Band 7	Left Cheek	0.176	0	5.17	-6.73	0.05	99.5	1.04	0.01	Not required
	WLAN5GHz Ant 2		0.86	0	0.62	2.12	-0.21				
	WLAN5GHz Ant 1	Left Cheek	0.777	0	-1.92	-2.59	0.47	53.9	1.64	0.04	Not required
	WLAN5GHz Ant 2		0.86	0	0.62	2.12	-0.21				

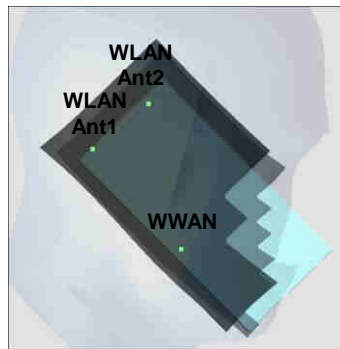

Case	Band	Position	SAR (W/kg)	Gap (cm)	SAR peak location (m)			3D distance (mm)	Summed SAR (W/kg)	SPLSR Results	Simultaneous SAR
					X	Y	Z				
11	LTE Band 41	Left Cheek	0.092	0	4.63	-0.51	-0.42	69.3	0.87	0.01	Not required
	WLAN5GHz Ant 1		0.777	0	-1.92	-2.59	0.47				
	LTE Band 41	Left Cheek	0.092	0	4.63	-0.51	-0.42	48.0	0.95	0.02	Not required
	WLAN5GHz Ant 2		0.86	0	0.62	2.12	-0.21				
	WLAN5GHz Ant 1	Left Cheek	0.777	0	-1.92	-2.59	0.47	53.9	1.64	0.04	Not required
	WLAN5GHz Ant 2		0.86	0	0.62	2.12	-0.21				

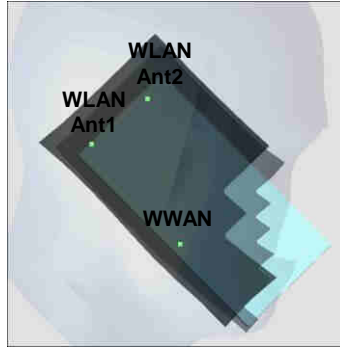

Case	Band	Position	SAR (W/kg)	Gap (cm)	SAR peak location (m)			3D distance (mm)	Summed SAR (W/kg)	SPLSR Results	Simultaneous SAR
					X	Y	Z				
12	GSM1900	Front	1.075	10	-1.63	-7.6	0.11	147.3	1.44	0.01	Not required
	WLAN5GHz Ant 1		0.361	10	-2.78	7.08	0.06				
	GSM1900	Front	1.075	10	-1.63	-7.6	0.11	151.9	1.28	0.01	Not required
	WLAN5GHz Ant 2		0.203	10	2.42	7.04	0.09				
	WLAN5GHz Ant 1	Front	0.361	10	-2.78	7.08	0.06	52.0	0.56	0.01	Not required
	WLAN5GHz Ant 2		0.203	10	2.42	7.04	0.09				

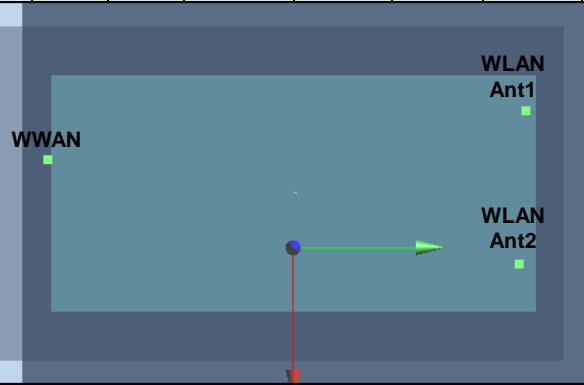

Case	Band	Position	SAR (W/kg)	Gap (cm)	SAR peak location (m)			3D distance (mm)	Summed SAR (W/kg)	SPLSR Results	Simultaneous SAR
					X	Y	Z				
13	LTE Band 7	Front	1.133	10	3.56	-6.78	0.14	152.4	1.49	0.01	Not required
	WLAN5GHz Ant 1		0.361	10	-2.78	7.08	0.06				
	LTE Band 7	Front	1.133	10	3.56	-6.78	0.14	138.7	1.34	0.01	Not required
	WLAN5GHz Ant 2		0.203	10	2.42	7.04	0.09				
	WLAN5GHz Ant 1	Front	0.361	10	-2.78	7.08	0.06	52.0	0.56	0.01	Not required
	WLAN5GHz Ant 2		0.203	10	2.42	7.04	0.09				

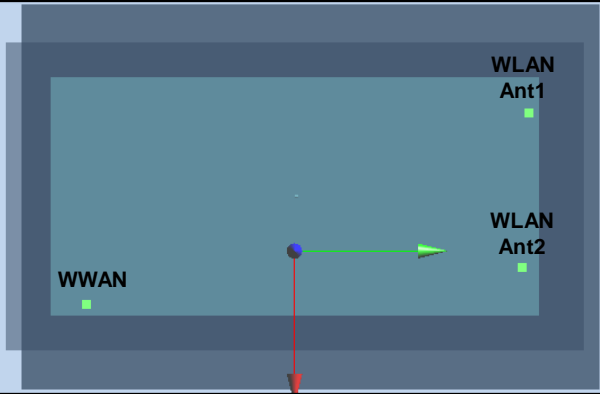

Test Engineer : San Lin Nick Yu Galen Zhang Tommy Chen Iran Wang Steven Chang and Ken Li

17. Uncertainty Assessment

The component of uncertainty may generally be categorized according to the methods used to evaluate them. The evaluation of uncertainty by the statistical analysis of a series of observations is termed a Type A evaluation of uncertainty. The evaluation of uncertainty by means other than the statistical analysis of a series of observation is termed a Type B evaluation of uncertainty. Each component of uncertainty, however evaluated, is represented by an estimated standard deviation, termed standard uncertainty, which is determined by the positive square root of the estimated variance.

A Type A evaluation of standard uncertainty may be based on any valid statistical method for treating data. This includes calculating the standard deviation of the mean of a series of independent observations; using the method of least squares to fit a curve to the data in order to estimate the parameter of the curve and their standard deviations; or carrying out an analysis of variance in order to identify and quantify random effects in certain kinds of measurement.

A type B evaluation of standard uncertainty is typically based on scientific judgment using all of the relevant information available. These may include previous measurement data, experience, and knowledge of the behavior and properties of relevant materials and instruments, manufacture’s specification, data provided in calibration reports and uncertainties assigned to reference data taken from handbooks. Broadly speaking, the uncertainty is either obtained from an outdoor source or obtained from an assumed distribution, such as the normal distribution, rectangular or triangular distributions indicated in table below.

Uncertainty Distributions	Normal	Rectangular	Triangular	U-Shape
Multi-plying Factor ^(a)	1/k ^(b)	1/√3	1/√6	1/√2

(a) standard uncertainty is determined as the product of the multiplying factor and the estimated range of variations in the measured quantity

(b) κ is the coverage factor

Table 17.1. Standard Uncertainty for Assumed Distribution

The combined standard uncertainty of the measurement result represents the estimated standard deviation of the result. It is obtained by combining the individual standard uncertainties of both Type A and Type B evaluation using the usual “root-sum-squares” (RSS) methods of combining standard deviations by taking the positive square root of the estimated variances.

Expanded uncertainty is a measure of uncertainty that defines an interval about the measurement result within which the measured value is confidently believed to lie. It is obtained by multiplying the combined standard uncertainty by a coverage factor. Typically, the coverage factor ranges from 2 to 3. Using a coverage factor allows the true value of a measured quantity to be specified with a defined probability within the specified uncertainty range. For purpose of this document, a coverage factor two is used, which corresponds to confidence interval of about 95 %. The DASY uncertainty Budget is shown in the following tables.



Error Description	Uncertainty Value (±%)	Probability	Divisor	(Ci) 1g	(Ci) 10g	Standard Uncertainty (1g) (±%)	Standard Uncertainty (10g) (±%)
Measurement System							
Probe Calibration	6.00	N	1	1	1	6.0	6.0
Axial Isotropy	4.70	R	1.732	0.7	0.7	1.9	1.9
Hemispherical Isotropy	9.60	R	1.732	0.7	0.7	3.9	3.9
Boundary Effects	1.00	R	1.732	1	1	0.6	0.6
Linearity	4.70	R	1.732	1	1	2.7	2.7
System Detection Limits	1.00	R	1.732	1	1	0.6	0.6
Modulation Response	4.68	R	1.732	1	1	2.7	2.7
Readout Electronics	0.30	N	1	1	1	0.3	0.3
Response Time	0.00	R	1.732	1	1	0.0	0.0
Integration Time	2.60	R	1.732	1	1	1.5	1.5
RF Ambient Noise	3.00	R	1.732	1	1	1.7	1.7
RF Ambient Reflections	3.00	R	1.732	1	1	1.7	1.7
Probe Positioner	0.40	R	1.732	1	1	0.2	0.2
Probe Positioning	2.90	R	1.732	1	1	1.7	1.7
Max. SAR Eval.	2.00	R	1.732	1	1	1.2	1.2
Test Sample Related							
Device Positioning	3.03	N	1	1	1	3.0	3.0
Device Holder	3.60	N	1	1	1	3.6	3.6
Power Drift	5.00	R	1.732	1	1	2.9	2.9
Power Scaling	0.00	R	1.732	1	1	0.0	0.0
Phantom and Setup							
Phantom Uncertainty	6.10	R	1.732	1	1	3.5	3.5
SAR correction	0.00	R	1.732	1	0.84	0.0	0.0
Liquid Conductivity Repeatability	0.03	N	1	0.78	0.71	0.0	0.0
Liquid Conductivity (target)	5.00	R	1.732	0.78	0.71	2.3	2.0
Liquid Conductivity (mea.)	2.50	R	1.732	0.78	0.71	1.1	1.0
Temp. unc. - Conductivity	3.68	R	1.732	0.78	0.71	1.7	1.5
Liquid Permittivity Repeatability	0.02	N	1	0.23	0.26	0.0	0.0
Liquid Permittivity (target)	5.00	R	1.732	0.23	0.26	0.7	0.8
Liquid Permittivity (mea.)	2.50	R	1.732	0.23	0.26	0.3	0.4
Temp. unc. - Permittivity	0.84	R	1.732	0.23	0.26	0.1	0.1
Combined Std. Uncertainty						11.6%	11.6%
Coverage Factor for 95 %						K=2	K=2
Expanded STD Uncertainty						23.2%	23.1%

Table 17.2. Uncertainty Budget for frequency range 300 MHz to 3 GHz



Error Description	Uncertainty Value (±%)	Probability	Divisor	(Ci) 1g	(Ci) 10g	Standard Uncertainty (1g) (±%)	Standard Uncertainty (10g) (±%)
Measurement System							
Probe Calibration	6.55	N	1	1	1	6.6	6.6
Axial Isotropy	4.70	R	1.732	0.7	0.7	1.9	1.9
Hemispherical Isotropy	9.60	R	1.732	0.7	0.7	3.9	3.9
Boundary Effects	2.00	R	1.732	1	1	1.2	1.2
Linearity	4.70	R	1.732	1	1	2.7	2.7
System Detection Limits	1.00	R	1.732	1	1	0.6	0.6
Modulation Response	4.68	R	1.732	1	1	2.7	2.7
Readout Electronics	0.30	N	1	1	1	0.3	0.3
Response Time	0.00	R	1.732	1	1	0.0	0.0
Integration Time	2.60	R	1.732	1	1	1.5	1.5
RF Ambient Noise	3.00	R	1.732	1	1	1.7	1.7
RF Ambient Reflections	3.00	R	1.732	1	1	1.7	1.7
Probe Positioner	0.40	R	1.732	1	1	0.2	0.2
Probe Positioning	6.70	R	1.732	1	1	3.9	3.9
Max. SAR Eval.	4.00	R	1.732	1	1	2.3	2.3
Test Sample Related							
Device Positioning	3.03	N	1	1	1	3.0	3.0
Device Holder	3.60	N	1	1	1	3.6	3.6
Power Drift	5.00	R	1.732	1	1	2.9	2.9
Power Scaling	0.00	R	1.732	1	1	0.0	0.0
Phantom and Setup							
Phantom Uncertainty	6.60	R	1.732	1	1	3.8	3.8
SAR correction	0.00	R	1.732	1	0.84	0.0	0.0
Liquid Conductivity Repeatability	0.03	N	1	0.78	0.71	0.0	0.0
Liquid Conductivity (target)	5.00	R	1.732	0.78	0.71	2.3	2.0
Liquid Conductivity (mea.)	2.50	R	1.732	0.78	0.71	1.1	1.0
Temp. unc. - Conductivity	3.68	R	1.732	0.78	0.71	1.7	1.5
Liquid Permittivity Repeatability	0.02	N	1	0.23	0.26	0.0	0.0
Liquid Permittivity (target)	5.00	R	1.732	0.23	0.26	0.7	0.8
Liquid Permittivity (mea.)	2.50	R	1.732	0.23	0.26	0.3	0.4
Temp. unc. - Permittivity	0.84	R	1.732	0.23	0.26	0.1	0.1
Combined Std. Uncertainty						12.7%	12.6%
Coverage Factor for 95 %						K=2	K=2
Expanded STD Uncertainty						25.4%	25.3%

Table 17.3. Uncertainty Budget for frequency range 3 GHz to 6 GHz



18. References

- [1] FCC 47 CFR Part 2 "Frequency Allocations and Radio Treaty Matters; General Rules and Regulations"
- [2] ANSI/IEEE Std. C95.1-1992, "IEEE Standard for Safety Levels with Respect to Human Exposure to Radio Frequency Electromagnetic Fields, 3 kHz to 300 GHz", September 1992
- [3] IEEE Std. 1528-2013, "IEEE Recommended Practice for Determining the Peak Spatial-Average Specific Absorption Rate (SAR) in the Human Head from Wireless Communications Devices: Measurement Techniques", Sep 2013
- [4] SPEAG DASY System Handbook
- [5] FCC KDB 248227 D01 v02r02, "SAR Guidance for IEEE 802.11 (WiFi) Transmitters", Oct 2015.
- [6] FCC KDB 447498 D01 v06, "Mobile and Portable Device RF Exposure Procedures and Equipment Authorization Policies", Oct 2015
- [7] FCC KDB 648474 D04 v01r03, "SAR Evaluation Considerations for Wireless Handsets", Oct 2015.
- [8] FCC KDB 941225 D01 v03r01, "3G SAR MEAUREMENT PROCEDURES", Oct 2015
- [9] FCC KDB 941225 D05 v02r05, "SAR Evaluation Considerations for LTE Devices", Dec 2015
- [10] FCC KDB 941225 D06 v02r01, "SAR Evaluation Procedures for Portable Devices with Wireless Router Capabilities", Oct 2015.
- [11] FCC KDB 865664 D01 v01r04, "SAR Measurement Requirements for 100 MHz to 6 GHz", Aug 2015.
- [12] FCC KDB 865664 D02 v01r02, "RF Exposure Compliance Reporting and Documentation Considerations" Oct 2015.



Appendix A. Plots of System Performance Check

The plots are shown as follows.

System Check_Head_835MHz

DUT: D835V2-4d200

Communication System: CW; Frequency: 835 MHz; Duty Cycle: 1:1

Medium: HSL_850_170331 Medium parameters used: $f = 835 \text{ MHz}$; $\sigma = 0.876 \text{ S/m}$; $\epsilon_r = 40.791$; $\rho = 1000 \text{ kg/m}^3$

Ambient Temperature : $23.5 \text{ }^\circ\text{C}$; Liquid Temperature : $22.5 \text{ }^\circ\text{C}$

DASY5 Configuration:

- Probe: EX3DV4 - SN3955; ConvF(10.33, 10.33, 10.33); Calibrated: 2016/11/24;
- Sensor-Surface: 1.4mm (Mechanical Surface Detection)
- Electronics: DAE4 Sn1399; Calibrated: 2016/11/17
- Phantom: SAM-Right; Type: SAM; Serial: 1795
- Measurement SW: DASY52, Version 52.8 (8); SEMCAD X Version 14.6.10 (7331)

Pin=250mW/Area Scan (61x61x1): Interpolated grid: $dx=1.500 \text{ mm}$, $dy=1.500 \text{ mm}$

Maximum value of SAR (interpolated) = 3.09 W/kg

Pin=250mW/Zoom Scan (5x5x7)/Cube 0: Measurement grid: $dx=8\text{mm}$, $dy=8\text{mm}$, $dz=5\text{mm}$

Reference Value = 60.94 V/m ; Power Drift = 0.03 dB

Peak SAR (extrapolated) = 3.46 W/kg

SAR(1 g) = 2.31 W/kg ; SAR(10 g) = 1.52 W/kg

Maximum value of SAR (measured) = 3.07 W/kg

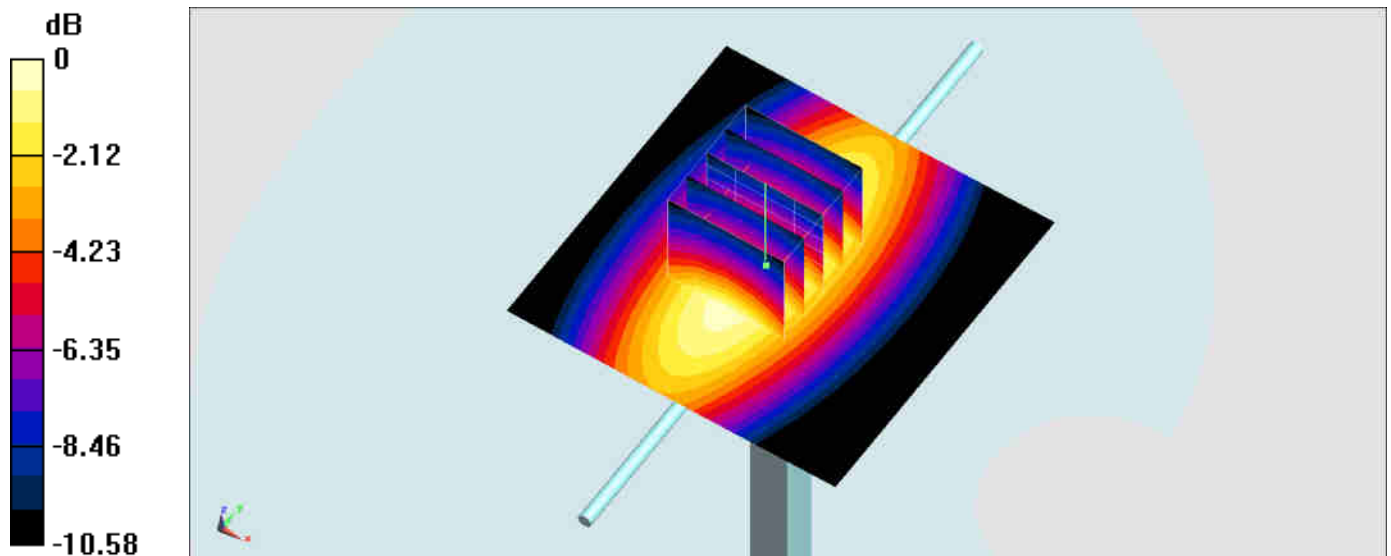

0 dB = 3.07 W/kg = 4.87 dBW/kg

System Check_Body_835MHz

DUT: D835V2-4d200

Communication System: CW ; Frequency: 835 MHz; Duty Cycle: 1:1

Medium: MSL_850_170323 Medium parameters used: $f = 835$ MHz; $\sigma = 0.951$ S/m; $\epsilon_r = 56.03$; $\rho = 1000$ kg/m³

Ambient Temperature : 23.4 °C ; Liquid Temperature : 22.4 °C

DASY5 Configuration:

- Probe: EX3DV4 - SN3925; ConvF(9.91, 9.91, 9.91); Calibrated: 2016/5/26;
- Sensor-Surface: 1.4mm (Mechanical Surface Detection)
- Electronics: DAE3 Sn495; Calibrated: 2016/5/27
- Phantom: SAM-Right; Type: SAM; Serial: TP-1303
- Measurement SW: DASY52, Version 52.8 (8); SEMCAD X Version 14.6.10 (7373)

Pin=250mW/Area Scan (61x61x1): Interpolated grid: dx=1.500 mm, dy=1.500 mm
Maximum value of SAR (interpolated) = 3.23 W/kg

Pin=250mW/Zoom Scan (5x5x7)/Cube 0: Measurement grid: dx=8mm, dy=8mm, dz=5mm
Reference Value = 60.79 V/m; Power Drift = 0.04 dB
Peak SAR (extrapolated) = 3.62 W/kg
SAR(1 g) = 2.47 W/kg; SAR(10 g) = 1.65 W/kg
Maximum value of SAR (measured) = 3.22 W/kg

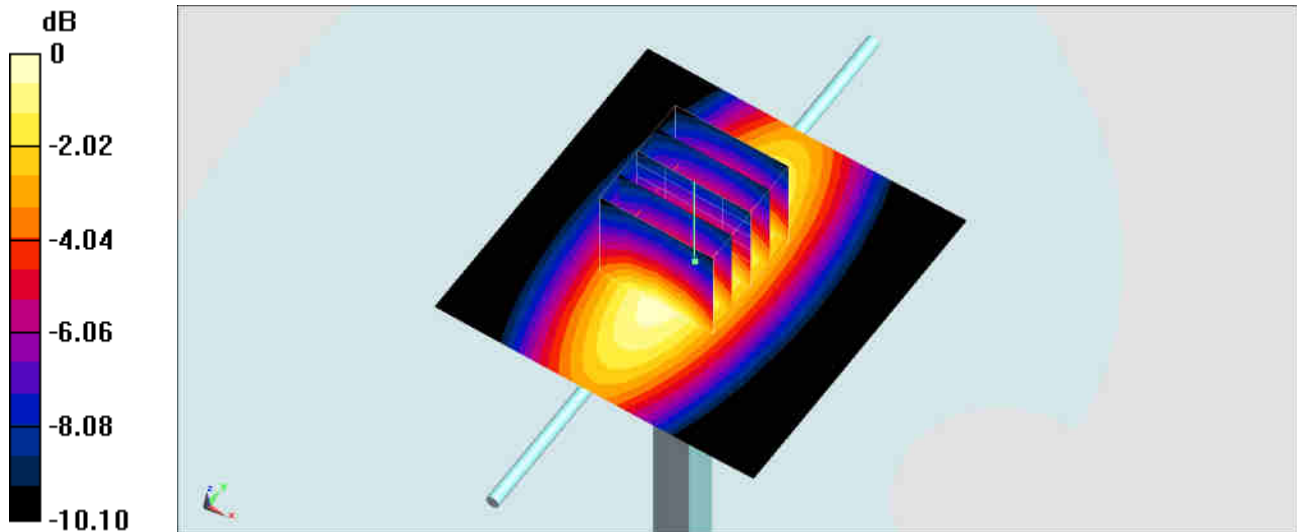

0 dB = 3.22 W/kg = 5.08 dBW/kg

System Check_Head_1750MHz

DUT: D1750V2-1068

Communication System: CW; Frequency: 1750 MHz; Duty Cycle: 1:1

Medium: HSL_1750_170331 Medium parameters used: $f = 1750$ MHz; $\sigma = 1.382$ S/m; $\epsilon_r = 41.201$; $\rho = 1000$ kg/m³

Ambient Temperature : 23.4 °C; Liquid Temperature : 22.4 °C

DASY5 Configuration:

- Probe: EX3DV4 - SN3955; ConvF(8.68, 8.68, 8.68); Calibrated: 2016/11/24;
- Sensor-Surface: 1.4mm (Mechanical Surface Detection)
- Electronics: DAE4 Sn1399; Calibrated: 2016/11/17
- Phantom: SAM-Right; Type: SAM; Serial: 1795
- Measurement SW: DASY52, Version 52.8 (8); SEMCAD X Version 14.6.10 (7331)

Pin=250mW/Area Scan (61x61x1): Interpolated grid: dx=1.500 mm, dy=1.500 mm

Maximum value of SAR (interpolated) = 14.2 W/kg

Pin=250mW/Zoom Scan (5x5x7)/Cube 0: Measurement grid: dx=8mm, dy=8mm, dz=5mm

Reference Value = 102.2 V/m; Power Drift = 0.06 dB

Peak SAR (extrapolated) = 16.3 W/kg

SAR(1 g) = 9.17 W/kg; SAR(10 g) = 4.96 W/kg

Maximum value of SAR (measured) = 13.9 W/kg

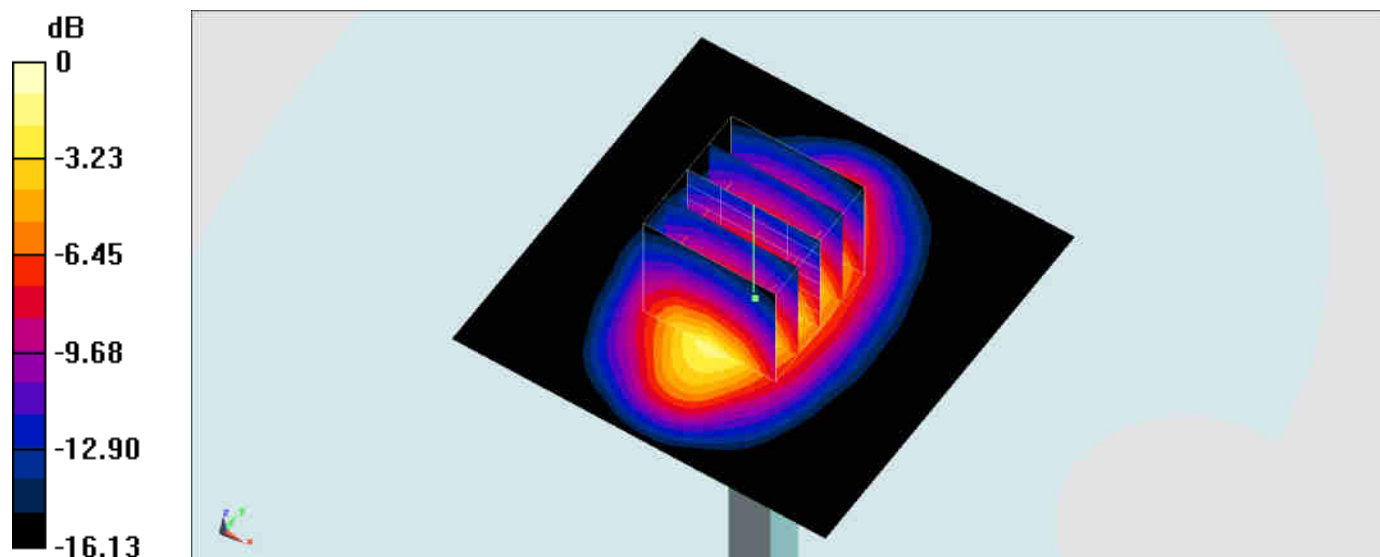

0 dB = 13.9 W/kg = 11.43 dBW/kg

System Check_Body_1750MHz

DUT: D1750V2-1068

Communication System: CW; Frequency: 1750 MHz; Duty Cycle: 1:1

Medium: MSL_1750_170323 Medium parameters used: $f = 1750$ MHz; $\sigma = 1.527$ S/m; $\epsilon_r = 54.161$; $\rho = 1000$ kg/m³

Ambient Temperature : 23.2 °C; Liquid Temperature : 22.2 °C

DASY5 Configuration:

- Probe: EX3DV4 - SN3925; ConvF(8.3, 8.3, 8.3); Calibrated: 2016/5/26;
- Sensor-Surface: 1.4mm (Mechanical Surface Detection)
- Electronics: DAE3 Sn495; Calibrated: 2016/5/27
- Phantom: SAM-Right; Type: SAM; Serial: TP-1303
- Measurement SW: DASY52, Version 52.8 (8); SEMCAD X Version 14.6.10 (7373)

Pin=250mW/Area Scan (61x61x1): Interpolated grid: dx=1.500 mm, dy=1.500 mm
Maximum value of SAR (interpolated) = 14.0 W/kg

Pin=250mW/Zoom Scan (5x5x7)/Cube 0: Measurement grid: dx=8mm, dy=8mm, dz=5mm
Reference Value = 98.80 V/m; Power Drift = -0.07 dB
Peak SAR (extrapolated) = 16.5 W/kg
SAR(1 g) = 9.19 W/kg; SAR(10 g) = 4.89 W/kg
Maximum value of SAR (measured) = 13.9 W/kg

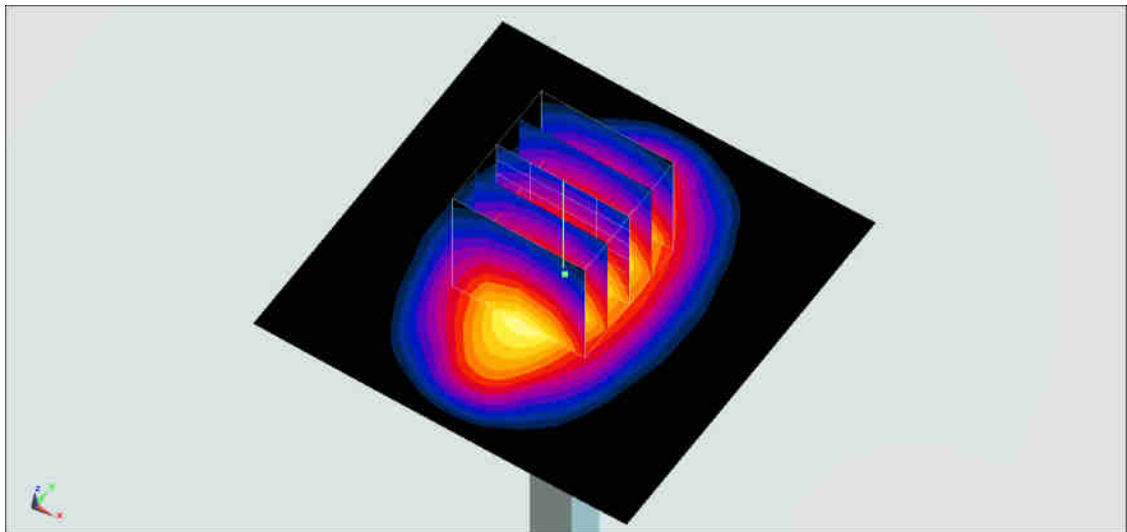
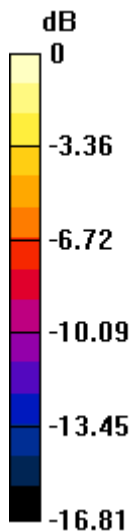

0 dB = 13.9 W/kg = 11.43 dBW/kg

System Check_Head_1900MHz

DUT: D1900V2-5d041

Communication System: CW; Frequency: 1900 MHz; Duty Cycle: 1:1

Medium: HSL_1900_170330 Medium parameters used: $f = 1900$ MHz; $\sigma = 1.406$ S/m; $\epsilon_r = 41.568$; $\rho = 1000$ kg/m³

Ambient Temperature : 23.6 °C; Liquid Temperature : 22.6 °C

DASY5 Configuration:

- Probe: EX3DV4 - SN3955; ConvF(8.43, 8.43, 8.43); Calibrated: 2016/11/24;
- Sensor-Surface: 1.4mm (Mechanical Surface Detection)
- Electronics: DAE4 Sn1399; Calibrated: 2016/11/17
- Phantom: SAM-Right; Type: SAM; Serial: 1795
- Measurement SW: DASY52, Version 52.8 (8); SEMCAD X Version 14.6.10 (7331)

Pin=250mW/Area Scan (61x61x1): Interpolated grid: dx=1.500 mm, dy=1.500 mm

Maximum value of SAR (interpolated) = 15.8 W/kg

Pin=250mW/Zoom Scan (5x5x7)/Cube 0: Measurement grid: dx=8mm, dy=8mm, dz=5mm

Reference Value = 104.5 V/m; Power Drift = 0.14 dB

Peak SAR (extrapolated) = 19.1 W/kg

SAR(1 g) = 10.2 W/kg; SAR(10 g) = 5.28 W/kg

Maximum value of SAR (measured) = 15.7 W/kg

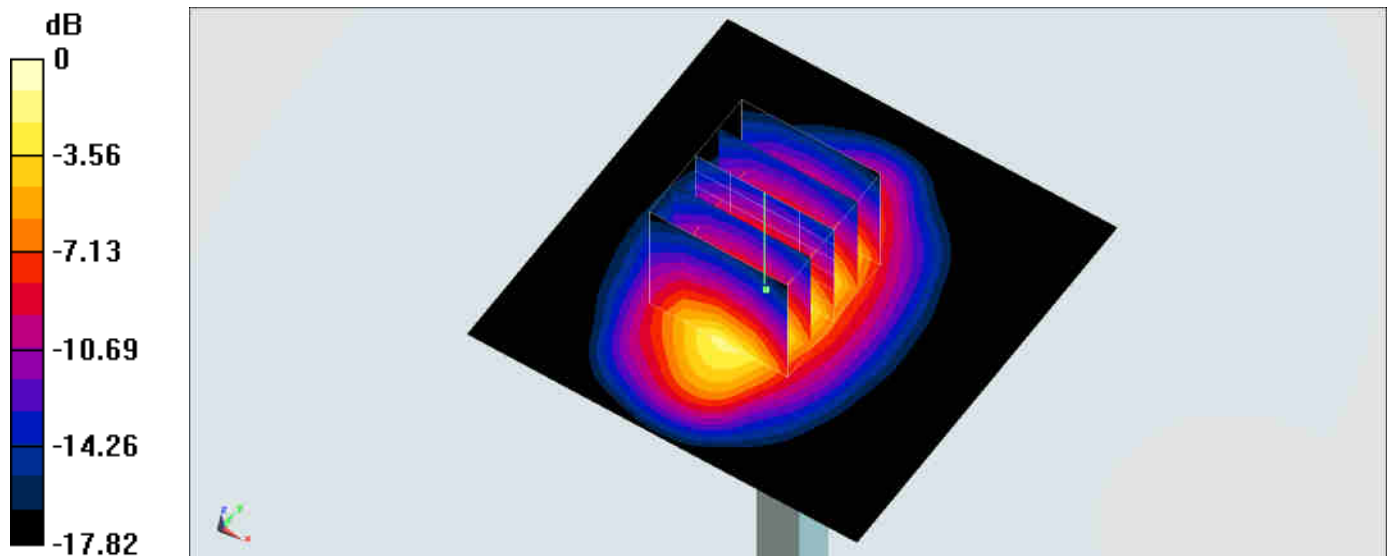

0 dB = 15.7 W/kg = 11.96 dBW/kg

System Check_Body_1900MHz

DUT: D1900V2-5d041

Communication System: CW; Frequency: 1900 MHz; Duty Cycle: 1:1

Medium: MSL_1900_170322 Medium parameters used: $f = 1900$ MHz; $\sigma = 1.54$ S/m; $\epsilon_r = 54.718$; $\rho = 1000$ kg/m³

Ambient Temperature : 23.3 °C ; Liquid Temperature : 22.3 °C

DASY5 Configuration:

- Probe: EX3DV4 - SN3925; ConvF(8, 8, 8); Calibrated: 2016/5/26;
- Sensor-Surface: 1.4mm (Mechanical Surface Detection)
- Electronics: DAE3 Sn495; Calibrated: 2016/5/27
- Phantom: SAM-Right; Type: SAM; Serial: TP-1303
- Measurement SW: DASY52, Version 52.8 (8); SEMCAD X Version 14.6.10 (7373)

Pin=250mW/Area Scan (61x61x1): Interpolated grid: dx=1.500 mm, dy=1.500 mm

Maximum value of SAR (interpolated) = 16.1 W/kg

Pin=250mW/Zoom Scan (5x5x7)/Cube 0: Measurement grid: dx=8mm, dy=8mm, dz=5mm

Reference Value = 105.7 V/m; Power Drift = -0.13 dB

Peak SAR (extrapolated) = 18.0 W/kg

SAR(1 g) = 10 W/kg; SAR(10 g) = 5.22 W/kg

Maximum value of SAR (measured) = 15.1 W/kg

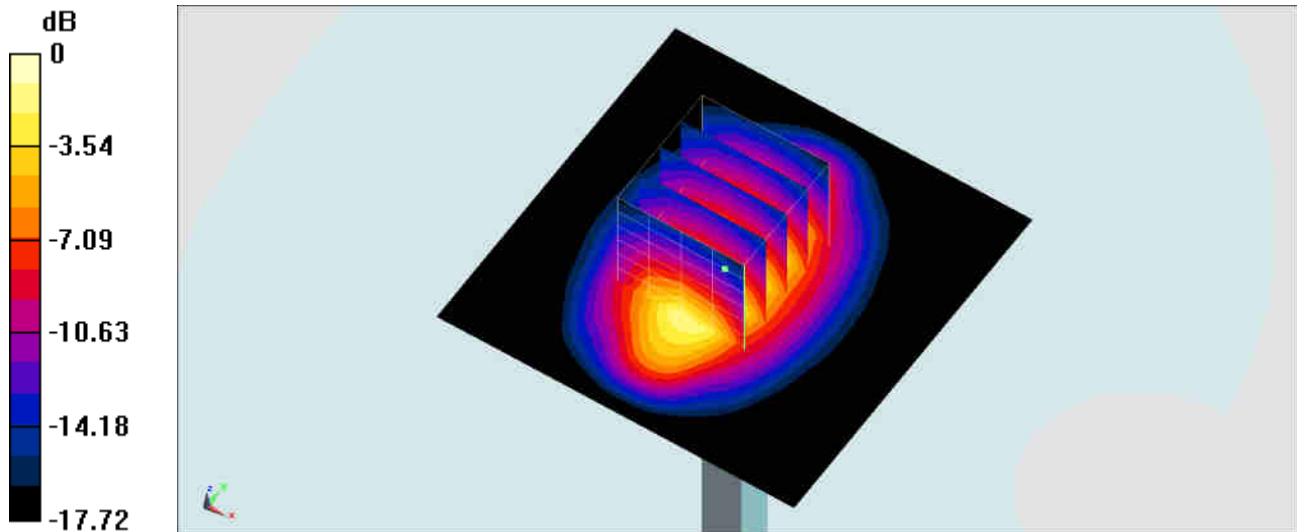

0 dB = 15.1 W/kg = 11.79 dBW/kg

System Check_Head_2450MHz

DUT: D2450V2-736

Communication System: CW; Frequency: 2450 MHz; Duty Cycle: 1:1

Medium: HSL_2450_170409 Medium parameters used: $f = 2450$ MHz; $\sigma = 1.805$ S/m; $\epsilon_r = 40.668$; $\rho = 1000$ kg/m³

Ambient Temperature : 23.4 °C ; Liquid Temperature : 22.4 °C

DASY5 Configuration:

- Probe: EX3DV4 - SN3955; ConvF(7.56, 7.56, 7.56); Calibrated: 2016/11/24;
- Sensor-Surface: 1.4mm (Mechanical Surface Detection)
- Electronics: DAE4 Sn1399; Calibrated: 2016/11/17
- Phantom: SAM-Right; Type: SAM; Serial: TP-1303
- Measurement SW: DASY52, Version 52.8 (8); SEMCAD X Version 14.6.10 (7373)

Pin=250mW/Area Scan (71x71x1): Interpolated grid: dx=1.200 mm, dy=1.200 mm
Maximum value of SAR (interpolated) = 23.6 W/kg

Pin=250mW/Zoom Scan (7x7x7)/Cube 0: Measurement grid: dx=5mm, dy=5mm, dz=5mm
Reference Value = 116.3 V/m; Power Drift = -0.05 dB
Peak SAR (extrapolated) = 29.0 W/kg
SAR(1 g) = 14.1 W/kg; SAR(10 g) = 6.59 W/kg
Maximum value of SAR (measured) = 23.5 W/kg

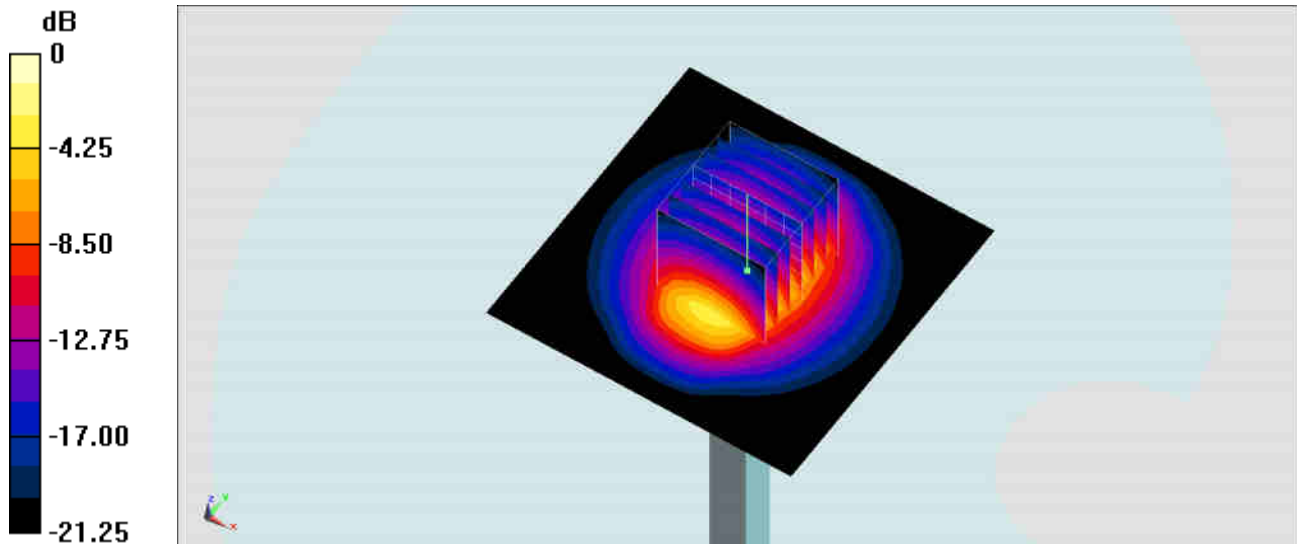

0 dB = 23.5 W/kg = 13.71 dBW/kg

System Check_Body_2450MHz

DUT: D2450V2-736

Communication System: CW; Frequency: 2450 MHz; Duty Cycle: 1:1

Medium: MSL_2450_170409 Medium parameters used: $f = 2450$ MHz; $\sigma = 1.952$ S/m; $\epsilon_r = 54.941$; $\rho = 1000$ kg/m³

Ambient Temperature : 23.9 °C ; Liquid Temperature : 22.9 °C

DASY5 Configuration:

- Probe: EX3DV4 - SN3955; ConvF(7.65, 7.65, 7.65); Calibrated: 2016/11/24;
- Sensor-Surface: 1.4mm (Mechanical Surface Detection)
- Electronics: DAE4 Sn1399; Calibrated: 2016/11/17
- Phantom: SAM-Right; Type: SAM; Serial: TP-1303
- Measurement SW: DASY52, Version 52.8 (8); SEMCAD X Version 14.6.10 (7373)

Pin=250mW/Area Scan (61x61x1): Interpolated grid: dx=1.200 mm, dy=1.200 mm

Maximum value of SAR (interpolated) = 22.4 W/kg

Pin=250mW/Zoom Scan (7x7x7)/Cube 0: Measurement grid: dx=5mm, dy=5mm, dz=5mm

Reference Value = 111.2 V/m; Power Drift = -0.06 dB

Peak SAR (extrapolated) = 27.5 W/kg

SAR(1 g) = 13.6 W/kg; SAR(10 g) = 6.33 W/kg

Maximum value of SAR (measured) = 22.4 W/kg

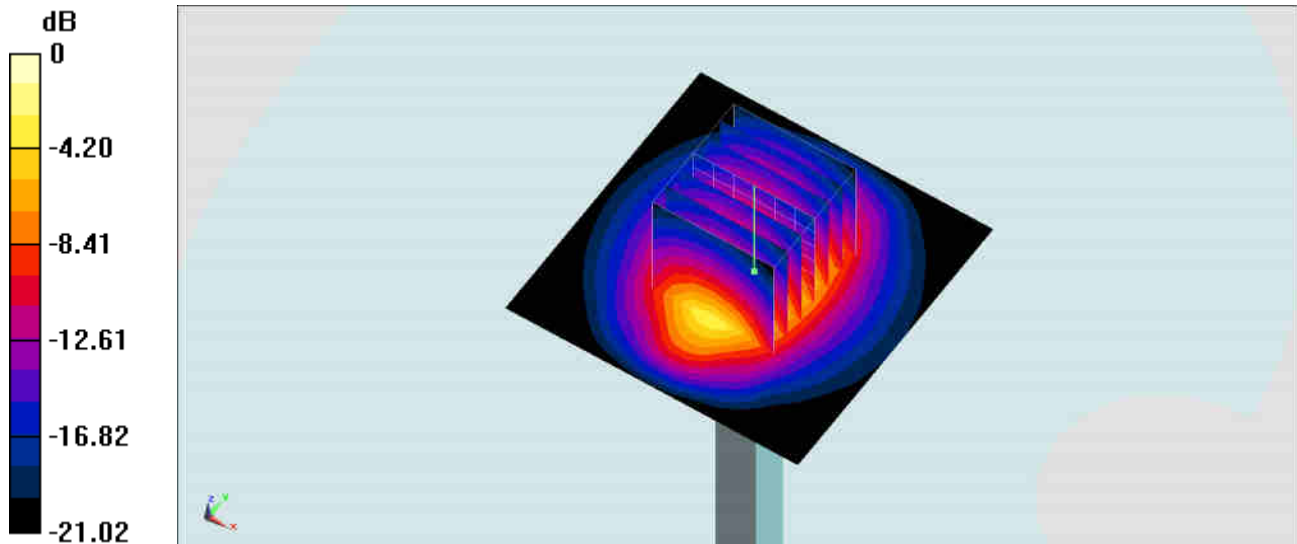

0 dB = 22.4 W/kg = 13.50 dBW/kg

System Check_Head_2600MHz

DUT: D2600V2-1008

Communication System: CW; Frequency: 2600 MHz; Duty Cycle: 1:1

Medium: HSL_2600_170329 Medium parameters used: $f = 2600$ MHz; $\sigma = 1.97$ mho/m; $\epsilon_r = 38.7$; $\rho = 1000$ kg/m³

Ambient Temperature : 23.3 °C; Liquid Temperature : 22.3 °C

DASY4 Configuration:

- Probe: EX3DV4 - SN3976; ConvF(7.6, 7.6, 7.6); Calibrated: 2017/2/21
- Sensor-Surface: 1.4mm (Mechanical Surface Detection)
- Electronics: DAE4 Sn1424; Calibrated: 2017/2/16
- Phantom: SAM_Right; Type: QD000P40CD; Serial: TP:1815
- ;Postprocessing SW: SEMCAD, V1.8 Build 159

Pin=250mW/Area Scan (71x71x1): Measurement grid: dx=12mm, dy=12mm

Maximum value of SAR (interpolated) = 24.5 mW/g

Pin=250mW/Zoom Scan (7x7x7)/Cube 0: Measurement grid: dx=5mm, dy=5mm, dz=5mm

Reference Value = 113.8 V/m; Power Drift = 0.010 dB

Peak SAR (extrapolated) = 30.4 W/kg

SAR(1 g) = 14.3 mW/g; SAR(10 g) = 6.47 mW/g

Maximum value of SAR (measured) = 24.1 mW/g

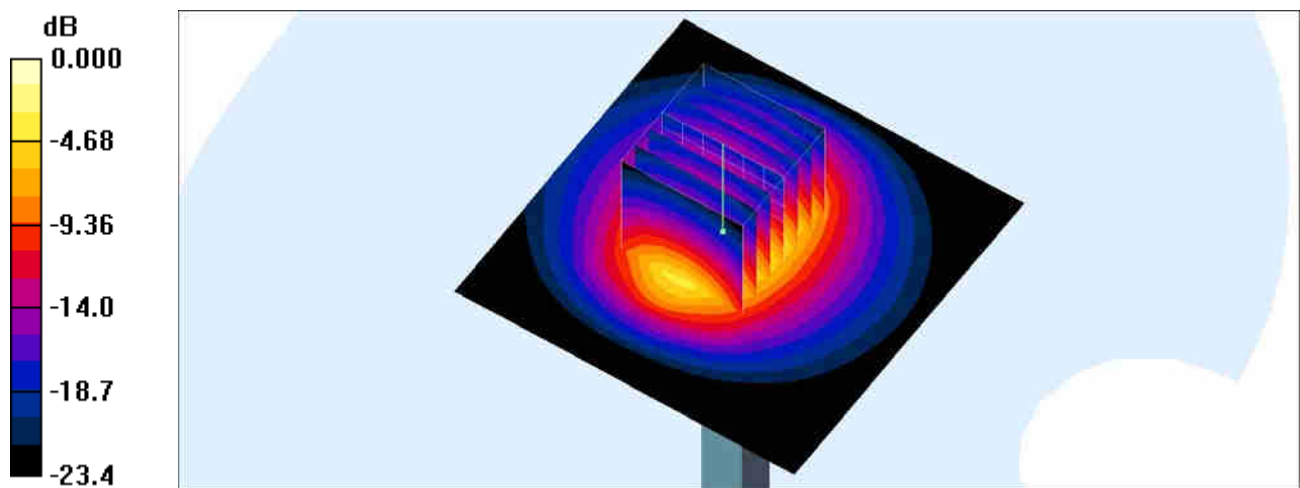

0 dB = 24.1mW/g

System Check_Head_2600MHz

DUT: D2600V2-1008

Communication System: CW; Frequency: 2600 MHz; Duty Cycle: 1:1

Medium: HSL_2600_170421 Medium parameters used: $f = 2600$ MHz; $\sigma = 2.027$ S/m; $\epsilon_r = 39.813$; $\rho = 1000$ kg/m³

Ambient Temperature : 23.5 °C; Liquid Temperature : 22.5 °C

DASY5 Configuration:

- Probe: ES3DV3 - SN3270; ConvF(4.37, 4.37, 4.37); Calibrated: 2016/8/26;
- Sensor-Surface: 3mm (Mechanical Surface Detection)
- Electronics: DAE4 Sn778; Calibrated: 2016/5/12
- Phantom: SAM_Right; Type: QD000P40CD; Serial: 1884
- Measurement SW: DASY52, Version 52.8 (8); SEMCAD X Version 14.6.10 (7331)

Pin=250mW/Area Scan (81x81x1): Interpolated grid: dx=1.200 mm, dy=1.200 mm

Maximum value of SAR (interpolated) = 22.9 W/kg

Pin=250mW/Zoom Scan (7x7x7)/Cube 0: Measurement grid: dx=5mm, dy=5mm, dz=5mm

Reference Value = 113.9 V/m; Power Drift = 0.12 dB

Peak SAR (extrapolated) = 31.8 W/kg

SAR(1 g) = 14.6 W/kg; SAR(10 g) = 6.53 W/kg

Maximum value of SAR (measured) = 22.9 W/kg

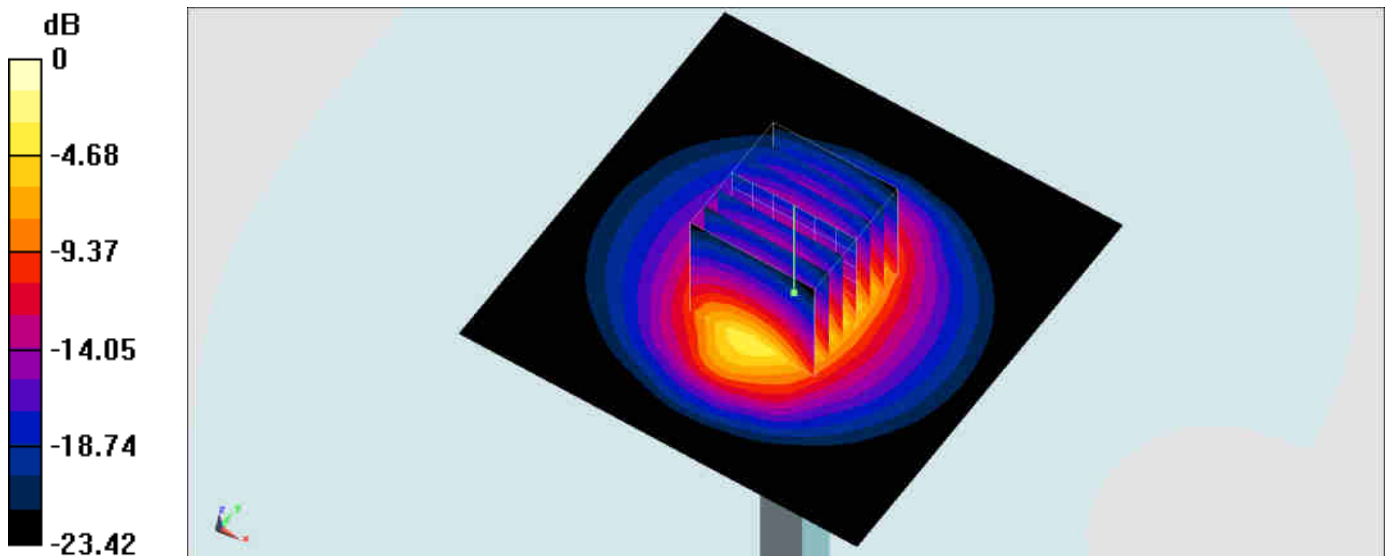

0 dB = 22.9 W/kg = 13.60 dBW/kg

System Check_Body_2600MHz

DUT: D2600V2-1008

Communication System: CW ; Frequency: 2600 MHz;Duty Cycle: 1:1

Medium: MSL_2600_170321 Medium parameters used: $f = 2600$ MHz; $\sigma = 2.164$ S/m; $\epsilon_r = 51.469$; $\rho = 1000$ kg/m³

Ambient Temperature : 23.7 °C ; Liquid Temperature : 22.7 °C

DASY5 Configuration:

- Probe: EX3DV4 - SN3925; ConvF(7.38, 7.38, 7.38); Calibrated: 2016/5/26;
- Sensor-Surface: 1.4mm (Mechanical Surface Detection)
- Electronics: DAE3 Sn495; Calibrated: 2016/5/27
- Phantom: SAM-Right; Type: SAM; Serial: TP-1303
- Measurement SW: DASY52, Version 52.8 (8);SEMCAD X Version 14.6.10 (7373)

Pin=250mW/Area Scan (61x61x1): Interpolated grid: dx=1.200 mm, dy=1.200 mm
Maximum value of SAR (interpolated) = 24.3 W/kg

Pin=250mW/Zoom Scan (7x7x7)/Cube 0: Measurement grid: dx=5mm, dy=5mm, dz=5mm
Reference Value = 100.8 V/m; Power Drift = -0.08 dB
Peak SAR (extrapolated) = 29.3 W/kg
SAR(1 g) = 13.2 W/kg; SAR(10 g) = 5.85 W/kg
Maximum value of SAR (measured) = 22.8 W/kg

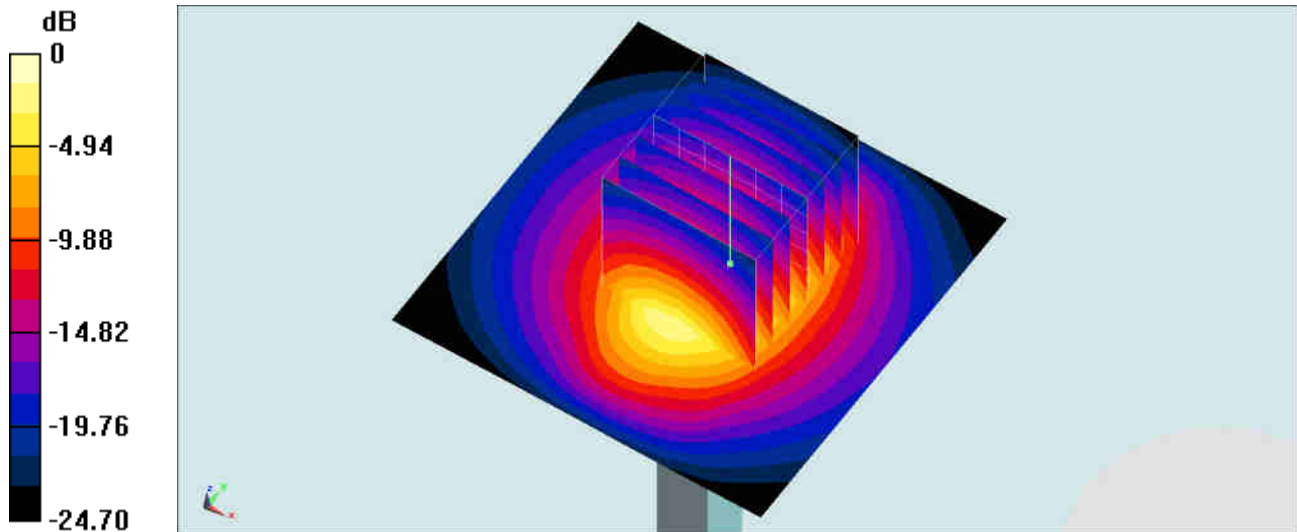

0 dB = 22.8 W/kg = 13.58 dBW/kg

System Check_Body_2600MHz

DUT: D2600V2-1008

Communication System: CW; Frequency: 2600 MHz; Duty Cycle: 1:1

Medium: MSL_2600_170421 Medium parameters used: $f = 2600$ MHz; $\sigma = 2.166$ S/m; $\epsilon_r = 52.736$; $\rho = 1000$ kg/m³

Ambient Temperature : 23.5 °C; Liquid Temperature : 22.5 °C

DASY5 Configuration:

- Probe: ES3DV3 - SN3270; ConvF(4.12, 4.12, 4.12); Calibrated: 2016/8/26;
- Sensor-Surface: 3mm (Mechanical Surface Detection)
- Electronics: DAE4 Sn778; Calibrated: 2016/5/12
- Phantom: SAM-Left; Type: QD 000 P40 C; Serial: TP-1446
- Measurement SW: DASY52, Version 52.8 (8); SEMCAD X Version 14.6.10 (7331)

Pin=250mW/Area Scan (71x71x1): Interpolated grid: dx=1.200 mm, dy=1.200 mm

Maximum value of SAR (interpolated) = 19.9 W/kg

Pin=250mW/Zoom Scan (7x7x7)/Cube 0: Measurement grid: dx=5mm, dy=5mm, dz=5mm

Reference Value = 95.89 V/m; Power Drift = -0.02 dB

Peak SAR (extrapolated) = 30.4 W/kg

SAR(1 g) = 14.2 W/kg; SAR(10 g) = 6.38 W/kg

Maximum value of SAR (measured) = 19.2 W/kg

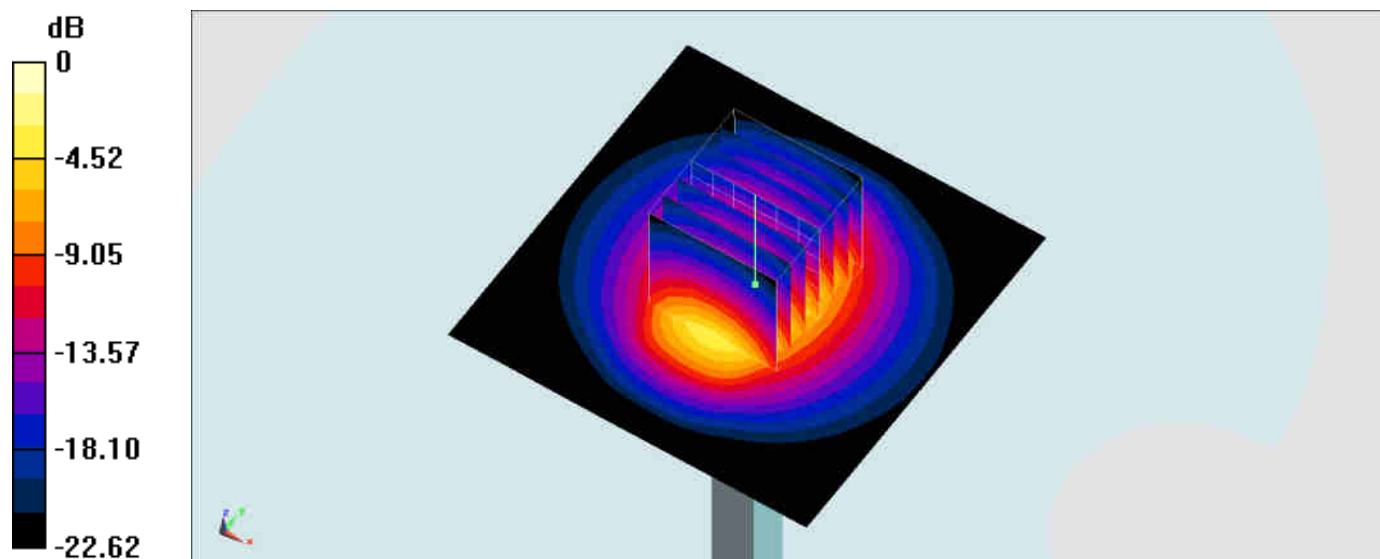

0 dB = 19.2 W/kg = 12.83 dBW/kg

System Check_Head_5250MHz

DUT: D5GHzV2-1006

Communication System: CW; Frequency: 5250 MHz; Duty Cycle: 1:1

Medium: HSL_5G_170413 Medium parameters used: $f = 5250$ MHz; $\sigma = 4.717$ S/m; $\epsilon_r = 37.312$; $\rho = 1000$ kg/m³

Ambient Temperature : 23.6 °C; Liquid Temperature : 22.6 °C

DASY5 Configuration:

- Probe: EX3DV4 - SN3931; ConvF(5.38, 5.38, 5.38); Calibrated: 2016/10/3;
- Sensor-Surface: 1.4mm (Mechanical Surface Detection)
- Electronics: DAE3 Sn577; Calibrated: 2016/9/28
- Phantom: SAM_Right; Type: QD000P40CD; Serial: 1884
- Measurement SW: DASY52, Version 52.8 (8); SEMCAD X Version 14.6.10 (7331)

Pin=100mW/Area Scan (71x71x1): Interpolated grid: dx=1.000 mm, dy=1.000 mm

Maximum value of SAR (interpolated) = 21.2 W/kg

Pin=100mW/Zoom Scan (7x7x7)/Cube 0: Measurement grid: dx=4mm, dy=4mm, dz=1.4mm

Reference Value = 70.18 V/m; Power Drift = -0.01 dB

Peak SAR (extrapolated) = 32.5 W/kg

SAR(1 g) = 7.92 W/kg; SAR(10 g) = 2.29 W/kg

Maximum value of SAR (measured) = 19.8 W/kg

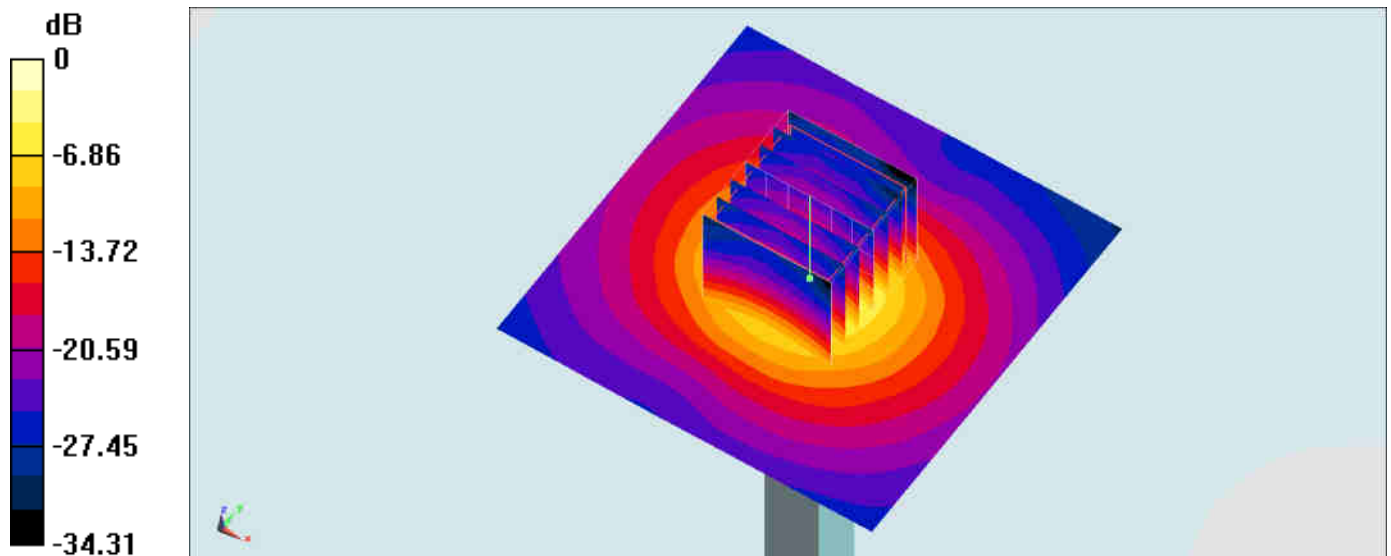

0 dB = 19.8 W/kg = 12.97 dBW/kg

System Check_Body_5250MHz

DUT: D5GHzV2-1006

Communication System: CW; Frequency: 5250 MHz; Duty Cycle: 1:1

Medium: MSL_5G_170406 Medium parameters used: $f = 5250$ MHz; $\sigma = 5.439$ S/m; $\epsilon_r = 47.661$; $\rho = 1000$ kg/m³

Ambient Temperature : 23.7 °C; Liquid Temperature : 22.7 °C

DASY5 Configuration:

- Probe: EX3DV4 - SN3955; ConvF(4.51, 4.51, 4.51); Calibrated: 2016/11/24;
- Sensor-Surface: 1.4mm (Mechanical Surface Detection)
- Electronics: DAE4 Sn1399; Calibrated: 2016/11/17
- Phantom: SAM-Right; Type: SAM; Serial: TP-1303
- Measurement SW: DASY52, Version 52.8 (8); SEMCAD X Version 14.6.10 (7373)

Pin=100mW/Area Scan (71x71x1): Interpolated grid: dx=1.000 mm, dy=1.000 mm
Maximum value of SAR (interpolated) = 18.3 W/kg

Pin=100mW/Zoom Scan (7x7x7)/Cube 0: Measurement grid: dx=4mm, dy=4mm, dz=1.4mm
Reference Value = 65.11 V/m; Power Drift = 0.10 dB
Peak SAR (extrapolated) = 29.8 W/kg
SAR(1 g) = 7.79 W/kg; SAR(10 g) = 2.23 W/kg
Maximum value of SAR (measured) = 18.0 W/kg

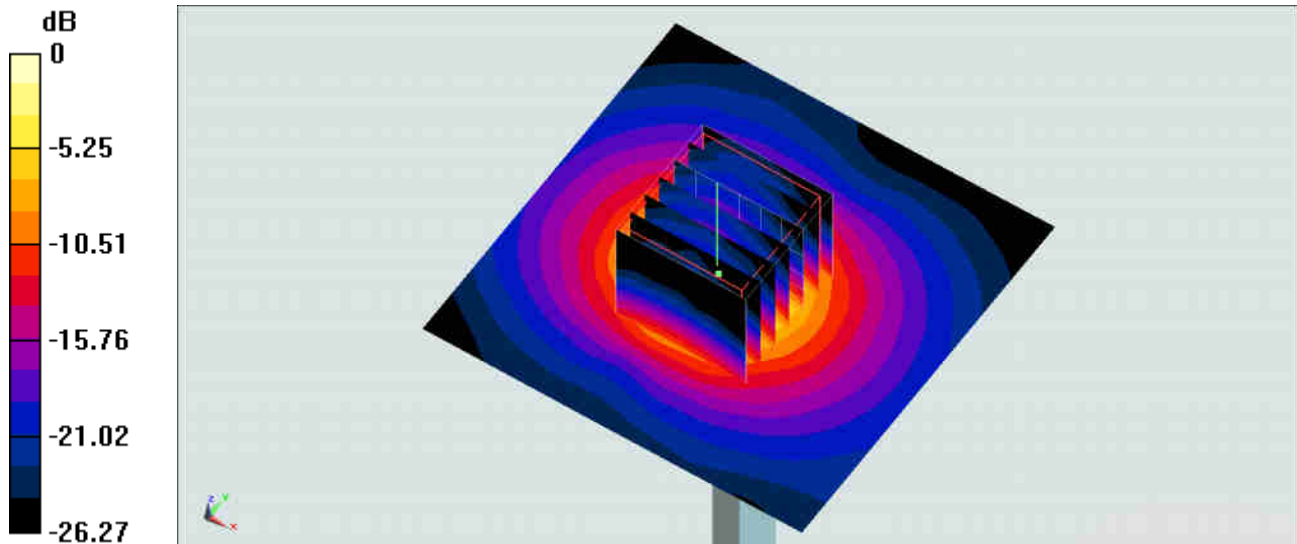

0 dB = 18.0 W/kg = 12.55 dBW/kg

System Check_Head_5600MHz

DUT: D5GHzV2-1006

Communication System: CW; Frequency: 5600 MHz; Duty Cycle: 1:1

Medium: HSL_5G_170413 Medium parameters used: $f = 5600$ MHz; $\sigma = 5.074$ S/m; $\epsilon_r = 36.786$; $\rho = 1000$ kg/m³

Ambient Temperature : 23.6 °C; Liquid Temperature : 22.6 °C

DASY5 Configuration:

- Probe: EX3DV4 - SN3931; ConvF(4.68, 4.68, 4.68); Calibrated: 2016/10/3;
- Sensor-Surface: 1.4mm (Mechanical Surface Detection)
- Electronics: DAE3 Sn577; Calibrated: 2016/9/28
- Phantom: SAM_Right; Type: QD000P40CD; Serial: 1884
- Measurement SW: DASY52, Version 52.8 (8); SEMCAD X Version 14.6.10 (7331)

Pin=100mW/Area Scan (71x71x1): Interpolated grid: dx=1.000 mm, dy=1.000 mm

Maximum value of SAR (interpolated) = 21.9 W/kg

Pin=100mW/Zoom Scan (7x7x7)/Cube 0: Measurement grid: dx=4mm, dy=4mm, dz=1.4mm

Reference Value = 72.92 V/m; Power Drift = -0.15 dB

Peak SAR (extrapolated) = 36.6 W/kg

SAR(1 g) = 8.8 W/kg; SAR(10 g) = 2.44 W/kg

Maximum value of SAR (measured) = 22.4 W/kg

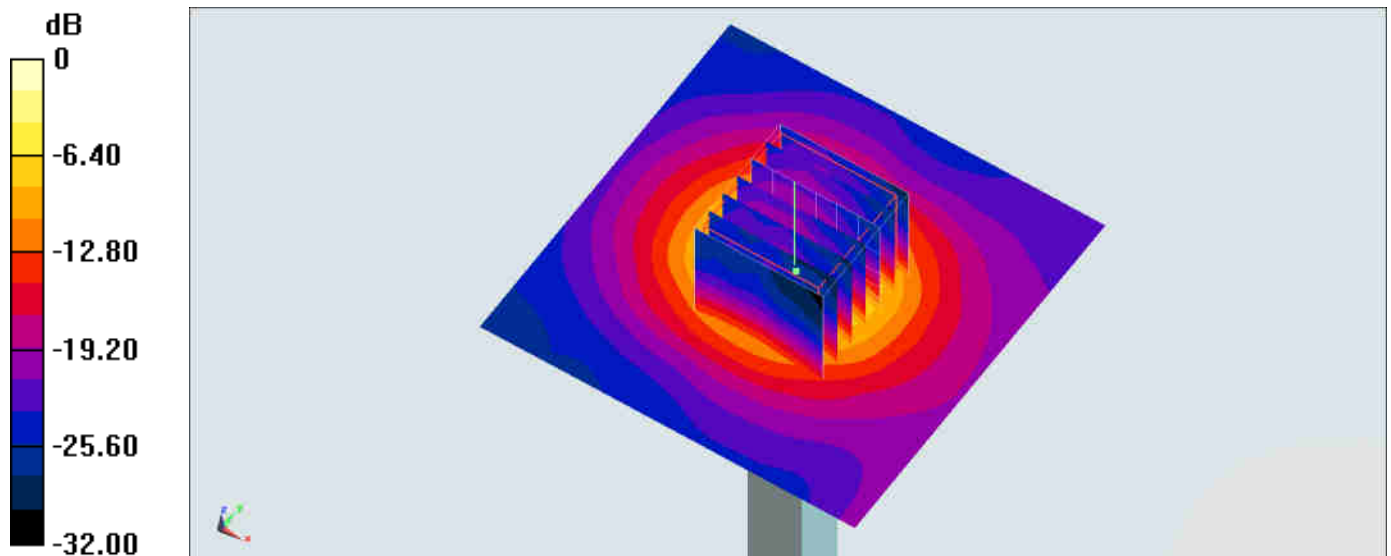

0 dB = 22.4 W/kg = 13.50 dBW/kg

System Check_Body_5600MHz

DUT: D5GHzV2-1006

Communication System: CW; Frequency: 5600 MHz; Duty Cycle: 1:1

Medium: MSL_5G_170406 Medium parameters used: $f = 5600$ MHz; $\sigma = 5.895$ S/m; $\epsilon_r = 47.057$; $\rho = 1000$ kg/m³

Ambient Temperature : 23.7 °C; Liquid Temperature : 22.7 °C

DASY5 Configuration:

- Probe: EX3DV4 - SN3955; ConvF(3.91, 3.91, 3.91); Calibrated: 2016/11/24;
- Sensor-Surface: 1.4mm (Mechanical Surface Detection)
- Electronics: DAE4 Sn1399; Calibrated: 2016/11/17
- Phantom: SAM-Right; Type: SAM; Serial: TP-1303
- Measurement SW: DASY52, Version 52.8 (8); SEMCAD X Version 14.6.10 (7373)

Pin=100mW/Area Scan (71x71x1): Interpolated grid: dx=1.000 mm, dy=1.000 mm

Maximum value of SAR (interpolated) = 20.7 W/kg

Pin=100mW/Zoom Scan (7x7x7)/Cube 0: Measurement grid: dx=4mm, dy=4mm, dz=1.4mm

Reference Value = 69.97 V/m; Power Drift = -0.05 dB

Peak SAR (extrapolated) = 33.9 W/kg

SAR(1 g) = 8.37 W/kg; SAR(10 g) = 2.35 W/kg

Maximum value of SAR (measured) = 20.7 W/kg

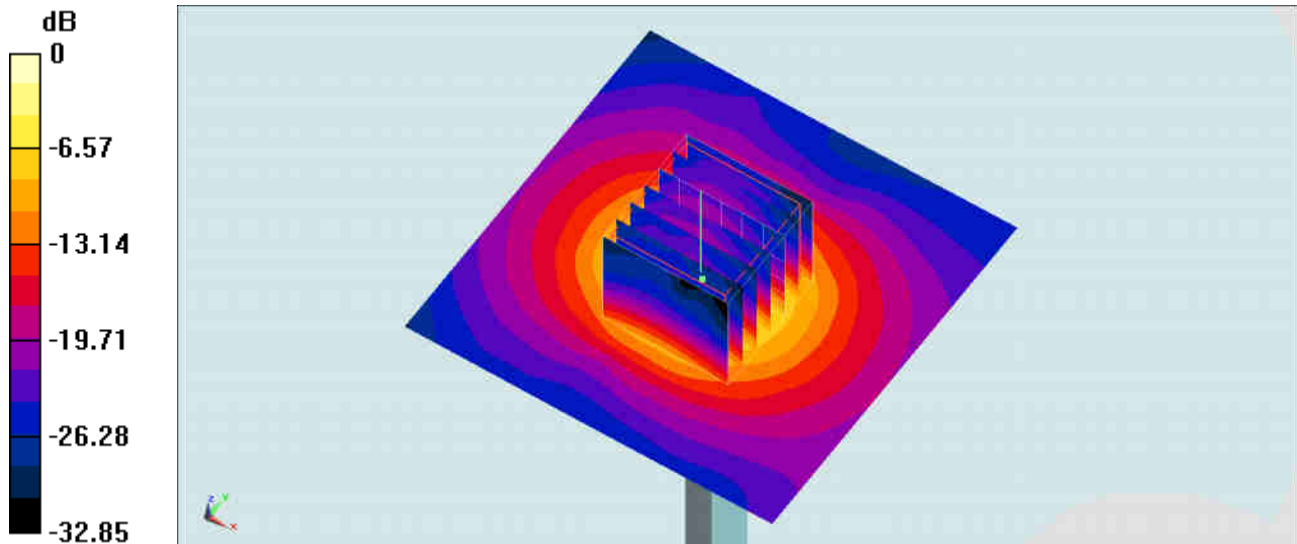

0 dB = 20.7 W/kg = 13.16 dBW/kg

System Check_Head_5750MHz

DUT: D5GHzV2-1006

Communication System: CW; Frequency: 5750 MHz; Duty Cycle: 1:1

Medium: HSL_5G_170413 Medium parameters used: $f = 5750 \text{ MHz}$; $\sigma = 5.236 \text{ S/m}$; $\epsilon_r = 36.587$; $\rho = 1000 \text{ kg/m}^3$

Ambient Temperature : $23.6 \text{ }^\circ\text{C}$; Liquid Temperature : $22.6 \text{ }^\circ\text{C}$

DASY5 Configuration:

- Probe: EX3DV4 - SN3931; ConvF(4.84, 4.84, 4.84); Calibrated: 2016/10/3;
- Sensor-Surface: 1.4mm (Mechanical Surface Detection)
- Electronics: DAE3 Sn577; Calibrated: 2016/9/28
- Phantom: SAM_Right; Type: QD000P40CD; Serial: 1884
- Measurement SW: DASY52, Version 52.8 (8); SEMCAD X Version 14.6.10 (7331)

Pin=100mW/Area Scan (71x71x1): Interpolated grid: $dx=1.000 \text{ mm}$, $dy=1.000 \text{ mm}$

Maximum value of SAR (interpolated) = 22.1 W/kg

Pin=100mW/Zoom Scan (7x7x7)/Cube 0: Measurement grid: $dx=4\text{mm}$, $dy=4\text{mm}$, $dz=1.4\text{mm}$

Reference Value = 69.89 V/m ; Power Drift = -0.02 dB

Peak SAR (extrapolated) = 35.5 W/kg

SAR(1 g) = 7.98 W/kg ; SAR(10 g) = 2.29 W/kg

Maximum value of SAR (measured) = 20.6 W/kg

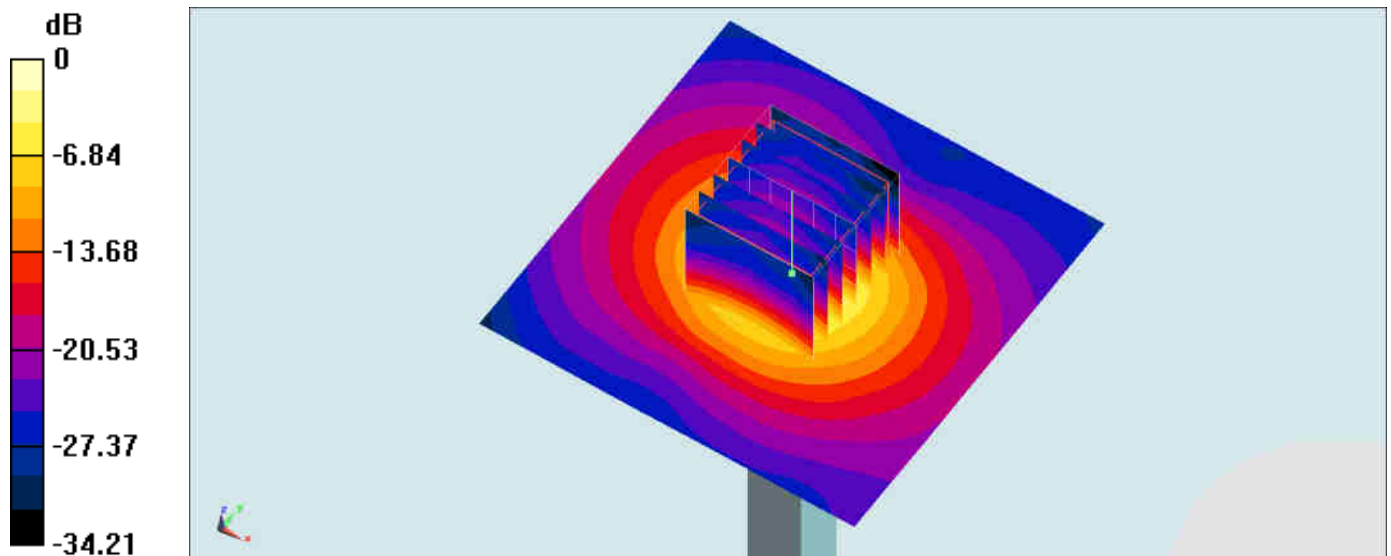

$0 \text{ dB} = 20.6 \text{ W/kg} = 13.14 \text{ dBW/kg}$

System Check_Body_5750MHz

DUT: D5GHzV2-1006

Communication System: CW; Frequency: 5750 MHz; Duty Cycle: 1:1

Medium: MSL_5G_170408 Medium parameters used: $f = 5750$ MHz; $\sigma = 6.203$ S/m; $\epsilon_r = 46.594$; $\rho = 1000$ kg/m³

Ambient Temperature : 23.5 °C ; Liquid Temperature : 22.5 °C

DASY5 Configuration:

- Probe: EX3DV4 - SN3955; ConvF(4.12, 4.12, 4.12); Calibrated: 2016/11/24;
- Sensor-Surface: 1.4mm (Mechanical Surface Detection)
- Electronics: DAE4 Sn1399; Calibrated: 2016/11/17
- Phantom: SAM-Right; Type: SAM; Serial: TP-1303
- Measurement SW: DASY52, Version 52.8 (8); SEMCAD X Version 14.6.10 (7373)

Pin=100mW/Area Scan (71x71x1): Interpolated grid: dx=1.000 mm, dy=1.000 mm

Maximum value of SAR (interpolated) = 20.4 W/kg

Pin=100mW/Zoom Scan (7x7x7)/Cube 0: Measurement grid: dx=4mm, dy=4mm, dz=1.4mm

Reference Value = 67.96 V/m; Power Drift = -0.10 dB

Peak SAR (extrapolated) = 35.1 W/kg

SAR(1 g) = 7.93 W/kg; SAR(10 g) = 2.26 W/kg

Maximum value of SAR (measured) = 21.1 W/kg

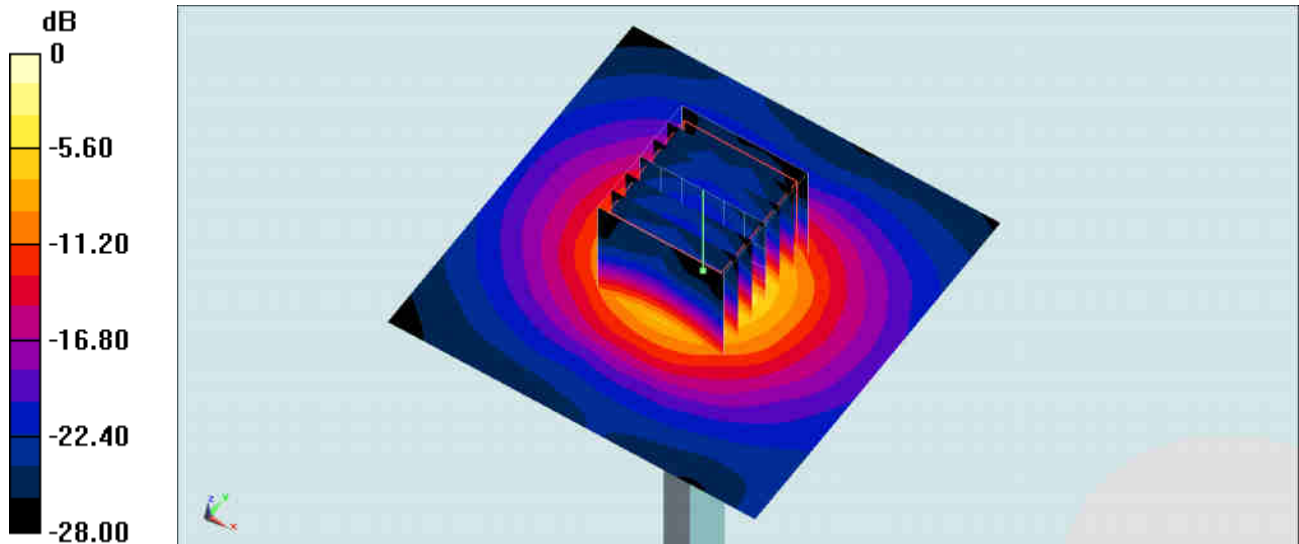

0 dB = 21.1 W/kg = 13.24 dBW/kg