



In Collaboration with  
**s p e a g**  
CALIBRATION LABORATORY



中国认可  
国际互认  
校准  
CALIBRATION  
CNAS L0570

Add: No.51 Xueyuan Road, Haidian District, Beijing, 100191, China  
Tel: +86-10-62304633-2079 Fax: +86-10-62304633-2504  
E-mail: cttl@chinattl.com [Http://www.chinattl.cn](http://www.chinattl.cn)

Client

**Sporton\_TW**

Certificate No: **Z16-97124**

## CALIBRATION CERTIFICATE

Object: D835V2 - SN: 4d200

Calibration Procedure(s): FD-Z11-2-003-01  
Calibration Procedures for dipole validation kits

Calibration date: August 23, 2016

This calibration Certificate documents the traceability to national standards, which realize the physical units of measurements(SI). The measurements and the uncertainties with confidence probability are given on the following pages and are part of the certificate.

All calibrations have been conducted in the closed laboratory facility: environment temperature(22±3)°C and humidity<70%.

Calibration Equipment used (M&TE critical for calibration)

Primary Standards	ID #	Cal Date(Calibrated by, Certificate No.)	Scheduled Calibration
Power Meter NRP2	101919	27-Jun-16 (CTTL, No.J16X04777)	Jun-17
Power sensor NRP-Z91	101547	27-Jun-16 (CTTL, No.J16X04777)	Jun-17
Reference Probe EX3DV4	SN 3617	26-Aug-15(SPEAG,No.EX3-3617_Aug15)	Aug-16
DAE4	SN 777	26-Aug-15(SPEAG,No.DAE4-777_Aug15)	Aug-16
Secondary Standards	ID #	Cal Date(Calibrated by, Certificate No.)	Scheduled Calibration
Signal Generator E4438C	MY49071430	01-Feb-16 (CTTL, No.J16X00893)	Jan-17
Network Analyzer E5071C	MY46110673	26-Jan-16 (CTTL, No.J16X00894)	Jan-17

	Name	Function	Signature
Calibrated by:	Zhao Jing	SAR Test Engineer	
Reviewed by:	Qi Dianyuan	SAR Project Leader	
Approved by:	Lu Bingsong	Deputy Director of the laboratory	

Issued: August 26, 2016

This calibration certificate shall not be reproduced except in full without written approval of the laboratory.



Add: No.51 Xueyuan Road, Haidian District, Beijing, 100191, China  
Tel: +86-10-62304633-2079 Fax: +86-10-62304633-2504  
E-mail: ettl@chinattl.com Http://www.chinattl.cn

#### Glossary:

TSL	tissue simulating liquid
ConvF	sensitivity in TSL / NORM <sub>x,y,z</sub>
N/A	not applicable or not measured

#### Calibration is Performed According to the Following Standards:

- IEEE Std 1528-2013, "IEEE Recommended Practice for Determining the Peak Spatial-Averaged Specific Absorption Rate (SAR) in the Human Head from Wireless Communications Devices: Measurement Techniques", June 2013
- IEC 62209-1, "Procedure to measure the Specific Absorption Rate (SAR) For hand-held devices used in close proximity to the ear (frequency range of 300MHz to 3GHz)", February 2005
- IEC 62209-2, "Procedure to measure the Specific Absorption Rate (SAR) For wireless communication devices used in close proximity to the human body (frequency range of 30MHz to 6GHz)", March 2010
- KDB865664, SAR Measurement Requirements for 100 MHz to 6 GHz

#### Additional Documentation:

- DASY4/5 System Handbook

#### Methods Applied and Interpretation of Parameters:

- Measurement Conditions:** Further details are available from the Validation Report at the end of the certificate. All figures stated in the certificate are valid at the frequency indicated.
- Antenna Parameters with TSL:** The dipole is mounted with the spacer to position its feed point exactly below the center marking of the flat phantom section, with the arms oriented parallel to the body axis.
- Feed Point Impedance and Return Loss:** These parameters are measured with the dipole positioned under the liquid filled phantom. The impedance stated is transformed from the measurement at the SMA connector to the feed point. The Return Loss ensures low reflected power. No uncertainty required.
- Electrical Delay:** One-way delay between the SMA connector and the antenna feed point. No uncertainty required.
- SAR measured:** SAR measured at the stated antenna input power.
- SAR normalized:** SAR as measured, normalized to an input power of 1 W at the antenna connector.
- SAR for nominal TSL parameters:** The measured TSL parameters are used to calculate the nominal SAR result.

The reported uncertainty of measurement is stated as the standard uncertainty of Measurement multiplied by the coverage factor  $k=2$ , which for a normal distribution Corresponds to a coverage probability of approximately 95%.



Add: No.51 Xueyuan Road, Haidian District, Beijing, 100191, China  
 Tel: +86-10-62304633-2079 Fax: +86-10-62304633-2504  
 E-mail: cttl@chinattl.com Http://www.chinattl.cn

### Measurement Conditions

DASY system configuration, as far as not given on page 1.

DASY Version	DASY52	52.8.8.1258
Extrapolation	Advanced Extrapolation	
Phantom	Triple Flat Phantom 5.1C	
Distance Dipole Center - TSL	15 mm	with Spacer
Zoom Scan Resolution	dx, dy, dz = 5 mm	
Frequency	835 MHz ± 1 MHz	

### Head TSL parameters

The following parameters and calculations were applied.

	Temperature	Permittivity	Conductivity
Nominal Head TSL parameters	22.0 °C	41.5	0.90 mho/m
Measured Head TSL parameters	(22.0 ± 0.2) °C	42.0 ± 6 %	0.92 mho/m ± 6 %
Head TSL temperature change during test	<1.0 °C	---	---

### SAR result with Head TSL

<b>SAR averaged over 1 cm<sup>3</sup> (1 g) of Head TSL</b>	Condition	
SAR measured	250 mW input power	2.37 mW / g
SAR for nominal Head TSL parameters	normalized to 1W	<b>9.39 mW / g ± 20.8 % (k=2)</b>
<b>SAR averaged over 10 cm<sup>3</sup> (10 g) of Head TSL</b>	Condition	
SAR measured	250 mW input power	1.56 mW / g
SAR for nominal Head TSL parameters	normalized to 1W	<b>6.19 mW / g ± 20.4 % (k=2)</b>

### Body TSL parameters

The following parameters and calculations were applied.

	Temperature	Permittivity	Conductivity
Nominal Body TSL parameters	22.0 °C	55.2	0.97 mho/m
Measured Body TSL parameters	(22.0 ± 0.2) °C	54.9 ± 6 %	0.98 mho/m ± 6 %
Body TSL temperature change during test	<1.0 °C	---	---

### SAR result with Body TSL

<b>SAR averaged over 1 cm<sup>3</sup> (1 g) of Body TSL</b>	Condition	
SAR measured	250 mW input power	2.43 mW / g
SAR for nominal Body TSL parameters	normalized to 1W	<b>9.65 mW / g ± 20.8 % (k=2)</b>
<b>SAR averaged over 10 cm<sup>3</sup> (10 g) of Body TSL</b>	Condition	
SAR measured	250 mW input power	1.62 mW / g
SAR for nominal Body TSL parameters	normalized to 1W	<b>6.44 mW / g ± 20.4 % (k=2)</b>



Add: No.51 Xueyuan Road, Haidian District, Beijing, 100191, China  
Tel: +86-10-62304633-2079 Fax: +86-10-62304633-2504  
E-mail: cttl@chinattl.com Http://www.chinattl.cn

## Appendix

### Antenna Parameters with Head TSL

Impedance, transformed to feed point	50.0Ω- 3.39jΩ
Return Loss	- 29.4dB

### Antenna Parameters with Body TSL

Impedance, transformed to feed point	46.1Ω- 5.27jΩ
Return Loss	- 23.3dB

### General Antenna Parameters and Design

Electrical Delay (one direction)	1.499 ns
----------------------------------	----------

After long term use with 100W radiated power, only a slight warming of the dipole near the feedpoint can be measured.

The dipole is made of standard semirigid coaxial cable. The center conductor of the feeding line is directly connected to the second arm of the dipole. The antenna is therefore short-circuited for DC-signals. On some of the dipoles, small end caps are added to the dipole arms in order to improve matching when loaded according to the position as explained in the "Measurement Conditions" paragraph. The SAR data are not affected by this change. The overall dipole length is still according to the Standard. No excessive force must be applied to the dipole arms, because they might bend or the soldered connections near the feedpoint may be damaged.

### Additional EUT Data

Manufactured by	SPEAG
-----------------	-------



Add: No.51 Xucyuan Road, Haidian District, Beijing, 100191, China  
Tel: +86-10-62304633-2079 Fax: +86-10-62304633-2504  
E-mail: cttl@chinattl.com Http://www.chinattl.cn

**DASY5 Validation Report for Head TSL**

Date: 08.23.2016

Test Laboratory: CTTL, Beijing, China

**DUT: Dipole 835 MHz; Type: D835V2; Serial: D835V2 - SN: 4d200**

Communication System: UID 0, CW; Frequency: 835 MHz; Duty Cycle: 1:1

Medium parameters used:  $f = 835 \text{ MHz}$ ;  $\sigma = 0.915 \text{ S/m}$ ;  $\epsilon_r = 41.98$ ;  $\rho = 1000 \text{ kg/m}^3$

Phantom section: Center Section

Measurement Standard: DASY5 (IEEE/IEC/ANSI C63.19-2007)

DASY5 Configuration:

- Probe: EX3DV4 - SN3617; ConvF(9.56, 9.56,9.56); Calibrated: 8/26/2015;
- Sensor-Surface: 2mm (Mechanical Surface Detection)
- Electronics: DAE4 Sn777; Calibrated: 2015-08-26
- Phantom: Triple Flat Phantom 5.1C; Type: QD 000 P51 CA; Serial: 1161/1
- Measurement SW: DASY52, Version 52.8 (8); SEMCAD X Version 14.6.10 (7372)

**Dipole Calibration/Zoom Scan (7x7x7) (7x7x7)/Cube 0:** Measurement grid:  $dx=5\text{mm}$ ,  $dy=5\text{mm}$ ,  $dz=5\text{mm}$

Reference Value = 58.36V/m; Power Drift = -0.01 dB

Peak SAR (extrapolated) = 3.53 W/kg

**SAR(1 g) = 2.37 W/kg; SAR(10 g) = 1.56 W/kg**

Maximum value of SAR (measured) = 3.00 W/kg

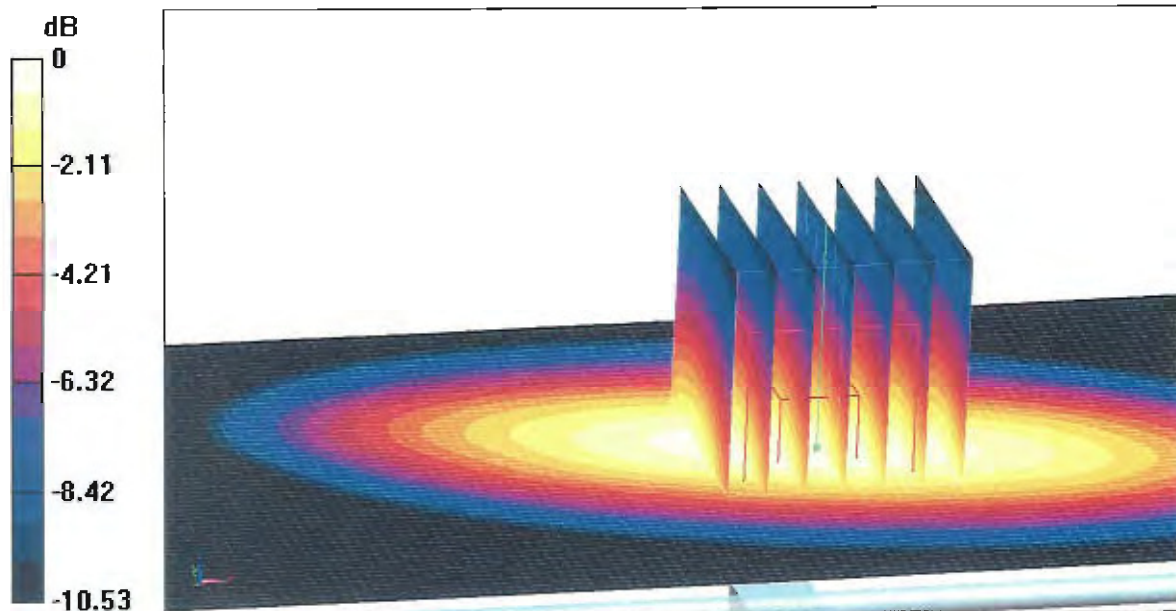

**0 dB = 3.00 W/kg = 4.77 dBW/kg**



Add: No.51 Xucyuan Road, Haidian District, Beijing, 100191, China  
Tel: +86-10-62304633-2079 Fax: +86-10-62304633-2504  
E-mail: cttl@chinattl.com Http://www.chinattl.cn

### Impedance Measurement Plot for Head TSL

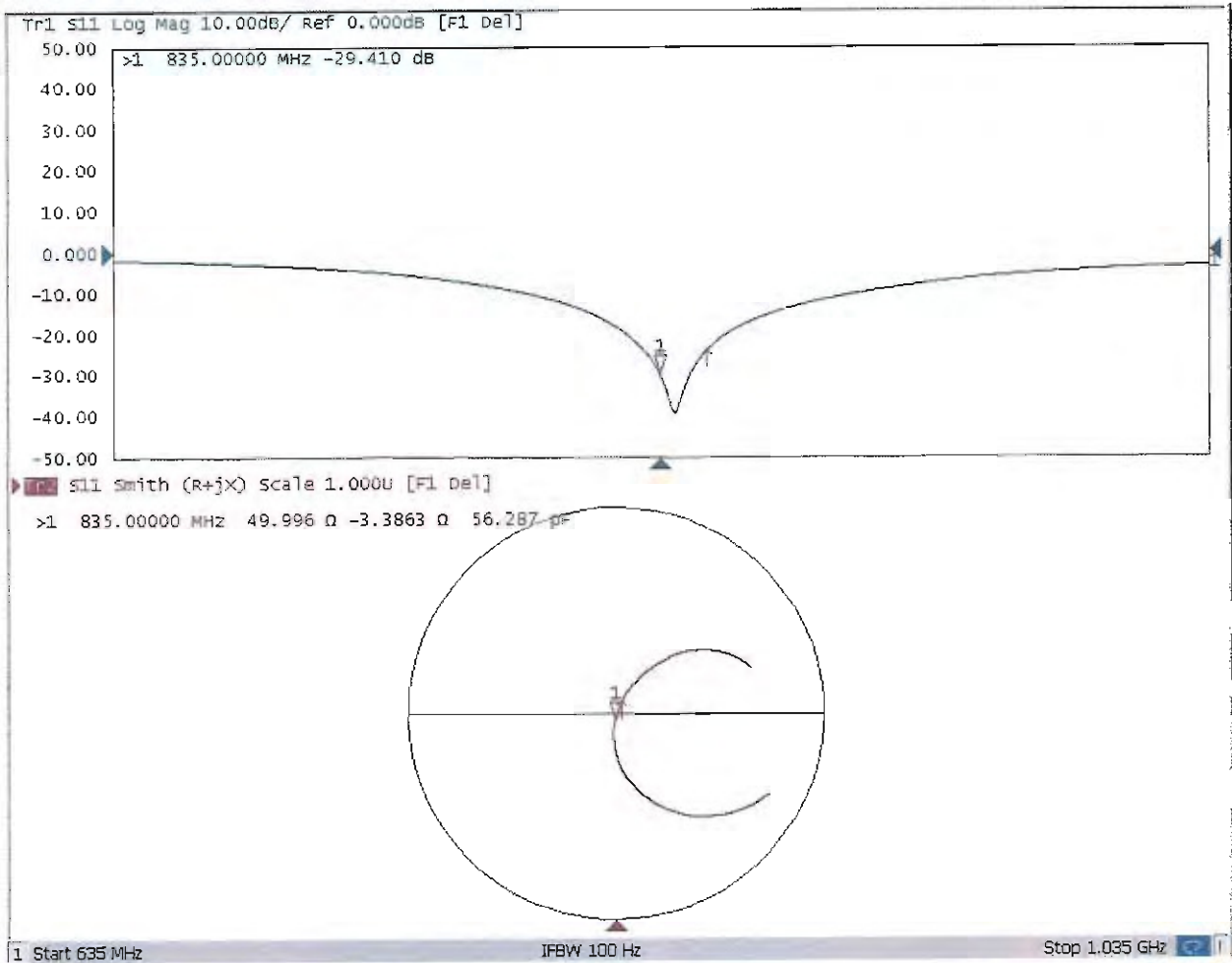



Add: No.51 Xueyuan Road, Haidian District, Beijing, 100191, China  
Tel: +86-10-62304633-2079 Fax: +86-10-62304633-2504  
E-mail: cttl@chinattl.com Http://www.chinattl.cn

### DASY5 Validation Report for Body TSL

Date: 08.23.2016

Test Laboratory: CTTL, Beijing, China

**DUT: Dipole 835 MHz; Type: D835V2; Serial: D835V2 - SN: 4d200**

Communication System: UID 0, CW; Frequency: 835 MHz; Duty Cycle: 1:1

Medium parameters used:  $f = 835$  MHz;  $\sigma = 0.978$  S/m;  $\epsilon_r = 54.86$ ;  $\rho = 1000$  kg/m<sup>3</sup>

Phantom section: Left Section

Measurement Standard: DASY5 (IEEE/IEC/ANSI C63.19-2007)

DASY5 Configuration:

- Probe: EX3DV4 - SN3617; ConvF(9.71,9.71, 9.71); Calibrated: 8/26/2015;
- Sensor-Surface: 2mm (Mechanical Surface Detection)
- Electronics: DAE4 Sn777; Calibrated: 2015-08-26
- Phantom: Triple Flat Phantom 5.1C; Type: QD 000 P51 CA; Serial: 1161/1
- Measurement SW: DASY52, Version 52.8 (8); SEMCAD X Version 14.6.10 (7372)

**Dipole Calibration/Zoom Scan (7x7x7) (7x7x7)/Cube 0:** Measurement grid: dx=5mm, dy=5mm, dz=5mm

Reference Value = 55.53 V/m; Power Drift = 0.00 dB

Peak SAR (extrapolated) = 3.54 W/kg

**SAR(1 g) = 2.43 W/kg; SAR(10 g) = 1.62 W/kg**

Maximum value of SAR (measured) = 3.04 W/kg

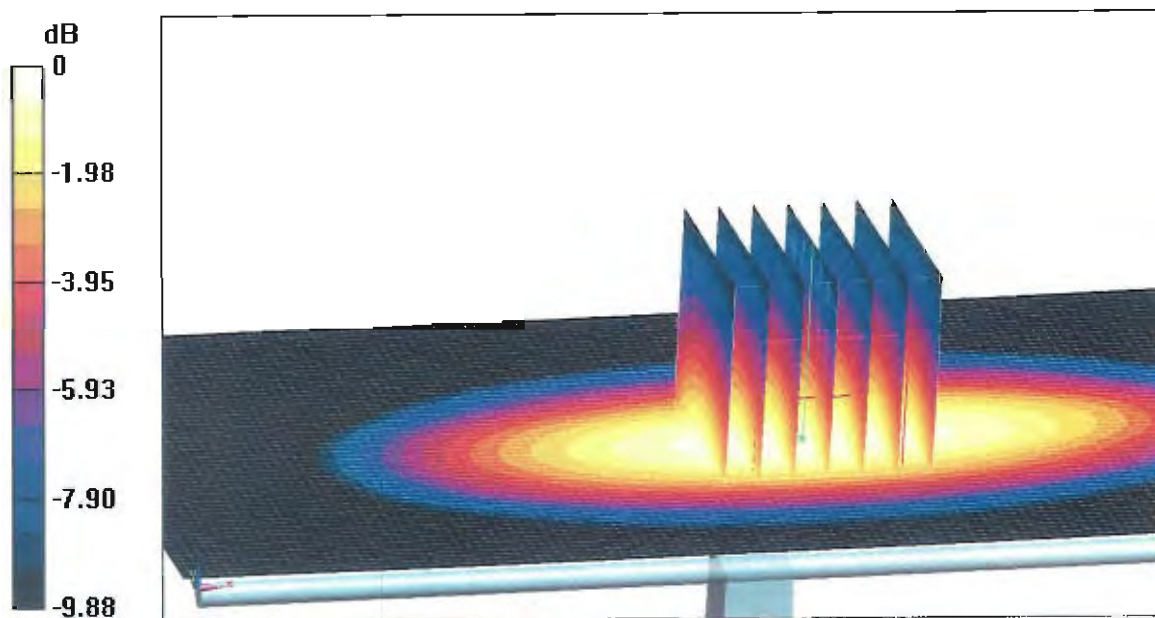

**0 dB = 3.04 W/kg = 4.83 dBW/kg**



Add: No.51 Xueyuan Road, Haidian District, Beijing, 100191, China  
Tel: +86-10-62304633-2079 Fax: +86-10-62304633-2504  
E-mail: cttl@chinattl.com Http://www.chinattl.cn

### Impedance Measurement Plot for Body TSL

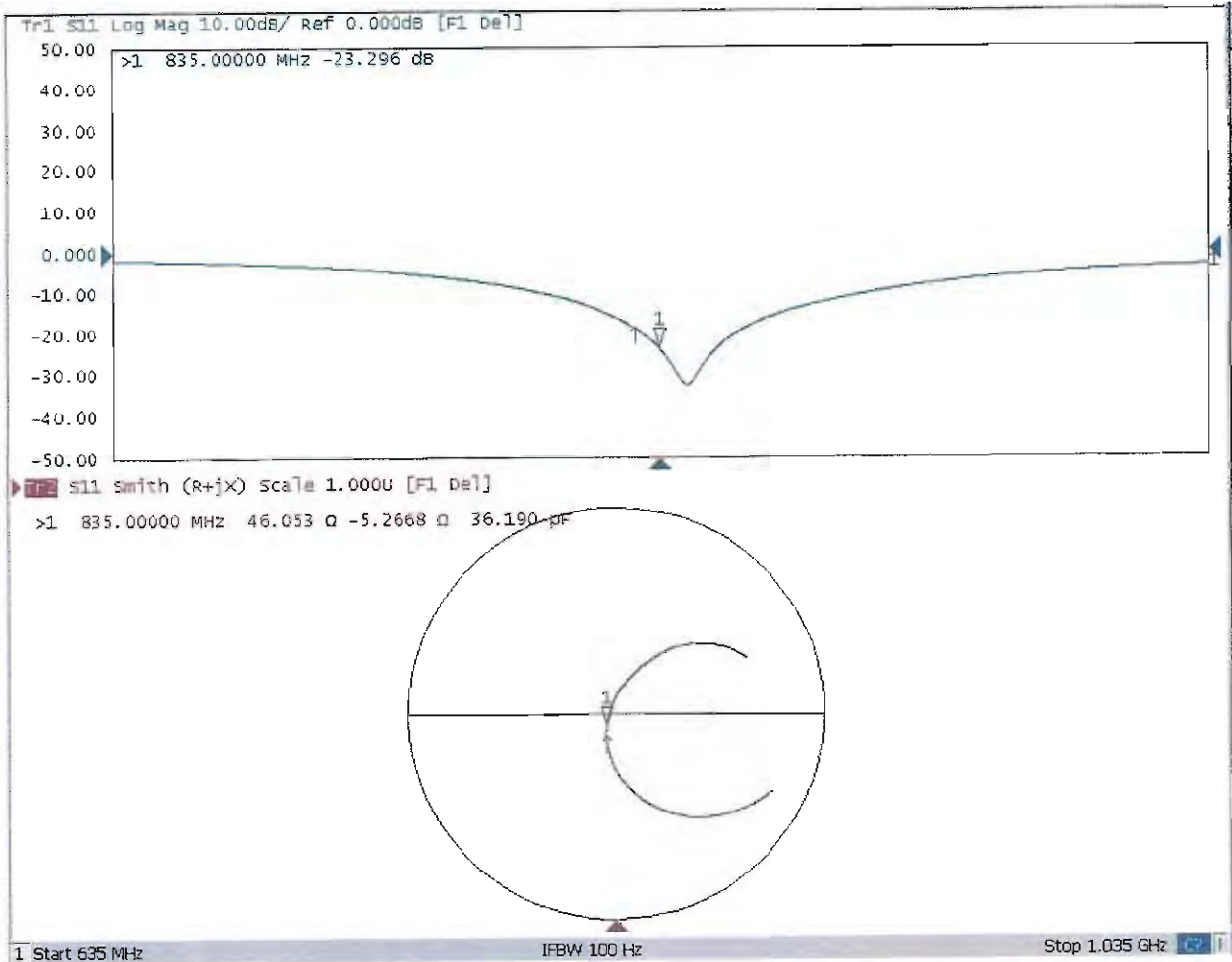





Accredited by the Swiss Accreditation Service (SAS)  
The Swiss Accreditation Service is one of the signatories to the EA  
Multilateral Agreement for the recognition of calibration certificates

Accreditation No.: **SCS 0108**

Client **Sporton-TW (Auden)**

Certificate No: **D1750V2-1068\_Nov16**

## CALIBRATION CERTIFICATE

Object **D1750V2 - SN:1068**

Calibration procedure(s) **QA CAL-05.v9  
Calibration procedure for dipole validation kits above 700 MHz**

Calibration date: **November 16, 2016**

This calibration certificate documents the traceability to national standards, which realize the physical units of measurements (SI).  
The measurements and the uncertainties with confidence probability are given on the following pages and are part of the certificate.

All calibrations have been conducted in the closed laboratory facility: environment temperature (22 ± 3)°C and humidity < 70%.

Calibration Equipment used (M&TE critical for calibration)

Primary Standards	ID #	Cal Date (Certificate No.)	Scheduled Calibration
Power meter NRP	SN: 104778	06-Apr-16 (No. 217-02288/02289)	Apr-17
Power sensor NRP-Z91	SN: 103244	06-Apr-16 (No. 217-02288)	Apr-17
Power sensor NRP-Z91	SN: 103245	06-Apr-16 (No. 217-02289)	Apr-17
Reference 20 dB Attenuator	SN: 5058 (20k)	05-Apr-16 (No. 217-02292)	Apr-17
Type-N mismatch combination	SN: 5047.2 / 06327	05-Apr-16 (No. 217-02295)	Apr-17
Reference Probe EX3DV4	SN: 7349	15-Jun-16 (No. EX3-7349_Jun16)	Jun-17
DAE4	SN: 601	30-Dec-15 (No. DAE4-601_Dec15)	Dec-16

Secondary Standards	ID #	Check Date (in house)	Scheduled Check
Power meter EPM-442A	SN: GB37480704	07-Oct-15 (in house check Oct-16)	In house check: Oct-18
Power sensor HP 8481A	SN: US37292783	07-Oct-15 (in house check Oct-16)	In house check: Oct-18
Power sensor HP 8481A	SN: MY41092317	07-Oct-15 (in house check Oct-16)	In house check: Oct-18
RF generator R&S SMT-06	SN: 100972	15-Jun-15 (in house check Oct-16)	In house check: Oct-18
Network Analyzer HP 8753E	SN: US37390585	18-Oct-01 (in house check Oct-16)	In house check: Oct-17

Calibrated by: **Claudio Leubler**      Name: Claudio Leubler      Function: Laboratory Technician

Approved by: **Katja Pokovic**      Name: Katja Pokovic      Function: Technical Manager

Signature

Issued: November 17, 2016

This calibration certificate shall not be reproduced except in full without written approval of the laboratory.



Accredited by the Swiss Accreditation Service (SAS)

Accreditation No.: **SCS 0108**

The Swiss Accreditation Service is one of the signatories to the EA Multilateral Agreement for the recognition of calibration certificates

**Glossary:**

TSL	tissue simulating liquid
ConvF	sensitivity in TSL / NORM x,y,z
N/A	not applicable or not measured

**Calibration is Performed According to the Following Standards:**

- a) IEEE Std 1528-2013, "IEEE Recommended Practice for Determining the Peak Spatial-Averaged Specific Absorption Rate (SAR) in the Human Head from Wireless Communications Devices: Measurement Techniques", June 2013
- b) IEC 62209-1, "Procedure to measure the Specific Absorption Rate (SAR) for hand-held devices used in close proximity to the ear (frequency range of 300 MHz to 3 GHz)", February 2005
- c) IEC 62209-2, "Procedure to determine the Specific Absorption Rate (SAR) for wireless communication devices used in close proximity to the human body (frequency range of 30 MHz to 6 GHz)", March 2010
- d) KDB 865664, "SAR Measurement Requirements for 100 MHz to 6 GHz"

**Additional Documentation:**

- e) DASY4/5 System Handbook

**Methods Applied and Interpretation of Parameters:**

- *Measurement Conditions:* Further details are available from the Validation Report at the end of the certificate. All figures stated in the certificate are valid at the frequency indicated.
- *Antenna Parameters with TSL:* The dipole is mounted with the spacer to position its feed point exactly below the center marking of the flat phantom section, with the arms oriented parallel to the body axis.
- *Feed Point Impedance and Return Loss:* These parameters are measured with the dipole positioned under the liquid filled phantom. The impedance stated is transformed from the measurement at the SMA connector to the feed point. The Return Loss ensures low reflected power. No uncertainty required.
- *Electrical Delay:* One-way delay between the SMA connector and the antenna feed point. No uncertainty required.
- *SAR measured:* SAR measured at the stated antenna input power.
- *SAR normalized:* SAR as measured, normalized to an input power of 1 W at the antenna connector.
- *SAR for nominal TSL parameters:* The measured TSL parameters are used to calculate the nominal SAR result.

The reported uncertainty of measurement is stated as the standard uncertainty of measurement multiplied by the coverage factor  $k=2$ , which for a normal distribution corresponds to a coverage probability of approximately 95%.

## Measurement Conditions

DASY system configuration, as far as not given on page 1.

DASY Version	DASY5	V52.8.8
Extrapolation	Advanced Extrapolation	
Phantom	Modular Flat Phantom	
Distance Dipole Center - TSL	10 mm	with Spacer
Zoom Scan Resolution	dx, dy, dz = 5 mm	
Frequency	1750 MHz $\pm$ 1 MHz	

## Head TSL parameters

The following parameters and calculations were applied.

	Temperature	Permittivity	Conductivity
Nominal Head TSL parameters	22.0 °C	40.1	1.37 mho/m
Measured Head TSL parameters	(22.0 $\pm$ 0.2) °C	39.1 $\pm$ 6 %	1.37 mho/m $\pm$ 6 %
Head TSL temperature change during test	< 0.5 °C	----	----

## SAR result with Head TSL

SAR averaged over 1 cm <sup>3</sup> (1 g) of Head TSL	Condition	
SAR measured	250 mW input power	9.20 W/kg
SAR for nominal Head TSL parameters	normalized to 1W	<b>36.6 W/kg <math>\pm</math> 17.0 % (k=2)</b>

SAR averaged over 10 cm <sup>3</sup> (10 g) of Head TSL	condition	
SAR measured	250 mW input power	4.88 W/kg
SAR for nominal Head TSL parameters	normalized to 1W	<b>19.5 W/kg <math>\pm</math> 16.5 % (k=2)</b>

## Body TSL parameters

The following parameters and calculations were applied.

	Temperature	Permittivity	Conductivity
Nominal Body TSL parameters	22.0 °C	53.4	1.49 mho/m
Measured Body TSL parameters	(22.0 $\pm$ 0.2) °C	53.7 $\pm$ 6 %	1.49 mho/m $\pm$ 6 %
Body TSL temperature change during test	< 0.5 °C	----	----

## SAR result with Body TSL

SAR averaged over 1 cm <sup>3</sup> (1 g) of Body TSL	Condition	
SAR measured	250 mW input power	9.04 W/kg
SAR for nominal Body TSL parameters	normalized to 1W	<b>36.2 W/kg <math>\pm</math> 17.0 % (k=2)</b>

SAR averaged over 10 cm <sup>3</sup> (10 g) of Body TSL	condition	
SAR measured	250 mW input power	4.85 W/kg
SAR for nominal Body TSL parameters	normalized to 1W	<b>19.4 W/kg <math>\pm</math> 16.5 % (k=2)</b>

## Appendix (Additional assessments outside the scope of SCS 0108)

### Antenna Parameters with Head TSL

Impedance, transformed to feed point	51.4 $\Omega$ + 3.9 j $\Omega$
Return Loss	- 27.9 dB

### Antenna Parameters with Body TSL

Impedance, transformed to feed point	47.1 $\Omega$ + 2.7 j $\Omega$
Return Loss	- 27.8 dB

### General Antenna Parameters and Design

Electrical Delay (one direction)	1.221 ns
----------------------------------	----------

After long term use with 100W radiated power, only a slight warming of the dipole near the feedpoint can be measured.

The dipole is made of standard semirigid coaxial cable. The center conductor of the feeding line is directly connected to the second arm of the dipole. The antenna is therefore short-circuited for DC-signals. On some of the dipoles, small end caps are added to the dipole arms in order to improve matching when loaded according to the position as explained in the "Measurement Conditions" paragraph. The SAR data are not affected by this change. The overall dipole length is still according to the Standard.

No excessive force must be applied to the dipole arms, because they might bend or the soldered connections near the feedpoint may be damaged.

### Additional EUT Data

Manufactured by	SPEAG
Manufactured on	June 15, 2010

## DASY5 Validation Report for Head TSL

Date: 16.11.2016

Test Laboratory: SPEAG, Zurich, Switzerland

**DUT: Dipole 1750 MHz; Type: D1750V2; Serial: D1750V2 - SN:1068**

Communication System: UID 0 - CW; Frequency: 1750 MHz

Medium parameters used:  $f = 1750$  MHz;  $\sigma = 1.37$  S/m;  $\epsilon_r = 39.1$ ;  $\rho = 1000$  kg/m<sup>3</sup>

Phantom section: Flat Section

Measurement Standard: DASY5 (IEEE/IEC/ANSI C63.19-2011)

DASY52 Configuration:

- Probe: EX3DV4 - SN7349; ConvF(8.46, 8.46, 8.46); Calibrated: 15.06.2016;
- Sensor-Surface: 1.4mm (Mechanical Surface Detection)
- Electronics: DAE4 Sn601; Calibrated: 30.12.2015
- Phantom: Flat Phantom 5.0 (front); Type: QD000P50AA; Serial: 1001
- DASY52 52.8.8(1258); SEMCAD X 14.6.10(7372)

### Dipole Calibration for Head Tissue/Pin=250 mW, d=10mm/Zoom Scan (7x7x7)/Cube 0:

Measurement grid: dx=5mm, dy=5mm, dz=5mm

Reference Value = 103.4 V/m; Power Drift = 0.01 dB

Peak SAR (extrapolated) = 16.8 W/kg

**SAR(1 g) = 9.2 W/kg; SAR(10 g) = 4.88 W/kg**

Maximum value of SAR (measured) = 14.0 W/kg

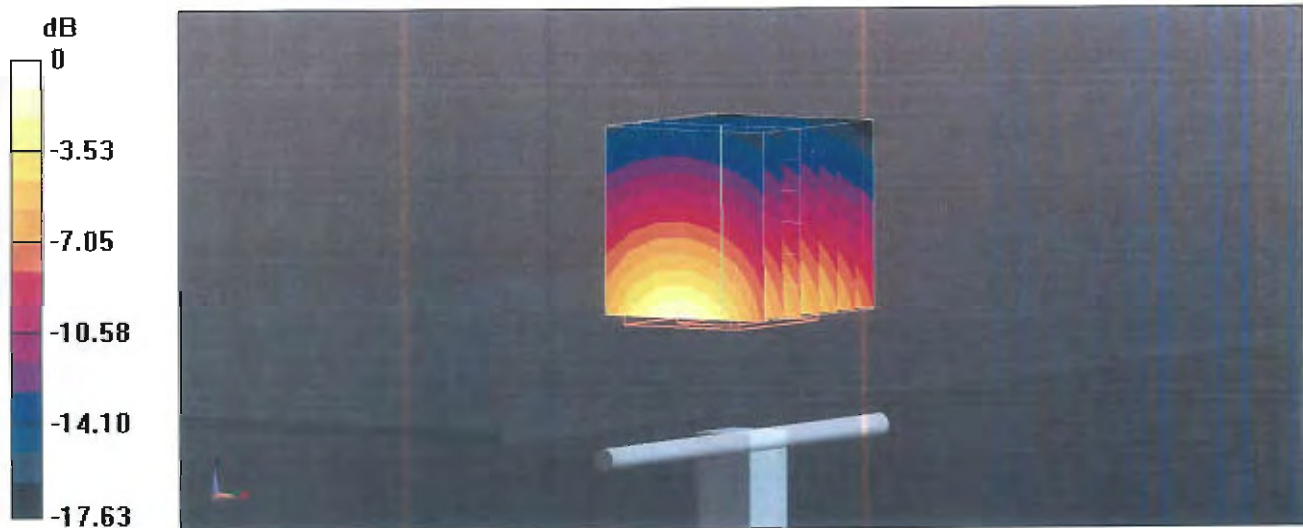

# Impedance Measurement Plot for Head TSL

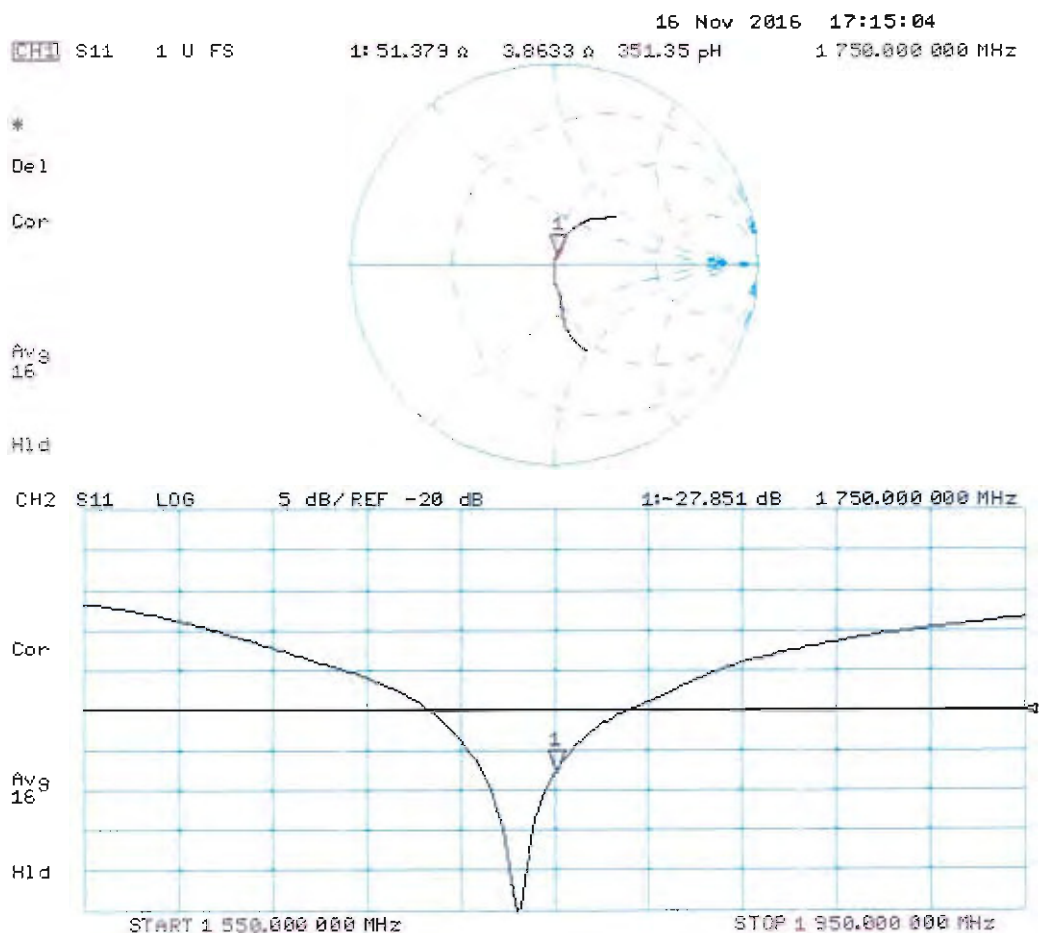

## DASY5 Validation Report for Body TSL

Date: 16.11.2016

Test Laboratory: SPEAG, Zurich, Switzerland

**DUT: Dipole 1750 MHz; Type: D1750V2; Serial: D1750V2 - SN:1068**

Communication System: UID 0 - CW; Frequency: 1750 MHz

Medium parameters used:  $f = 1750$  MHz;  $\sigma = 1.49$  S/m;  $\epsilon_r = 53.7$ ;  $\rho = 1000$  kg/m<sup>3</sup>

Phantom section: Flat Section

Measurement Standard: DASY5 (IEEE/IEC/ANSI C63.19-2011)

DASY52 Configuration:

- Probe: EX3DV4 - SN7349; ConvF(8.25, 8.25, 8.25); Calibrated: 15.06.2016;
- Sensor-Surface: 1.4mm (Mechanical Surface Detection)
- Electronics: DAE4 Sn601; Calibrated: 30.12.2015
- Phantom: Flat Phantom 5.0 (back); Type: QD000P50AA; Serial: 1002
- DASY52 52.8.8(1258); SEMCAD X 14.6.10(7372)

### Dipole Calibration for Body Tissue/Pin=250 mW, d=10mm/Zoom Scan (7x7x7)/Cube 0:

Measurement grid: dx=5mm, dy=5mm, dz=5mm

Reference Value = 99.57 V/m; Power Drift = -0.06 dB

Peak SAR (extrapolated) = 15.8 W/kg

**SAR(1 g) = 9.04 W/kg; SAR(10 g) = 4.85 W/kg**

Maximum value of SAR (measured) = 13.5 W/kg

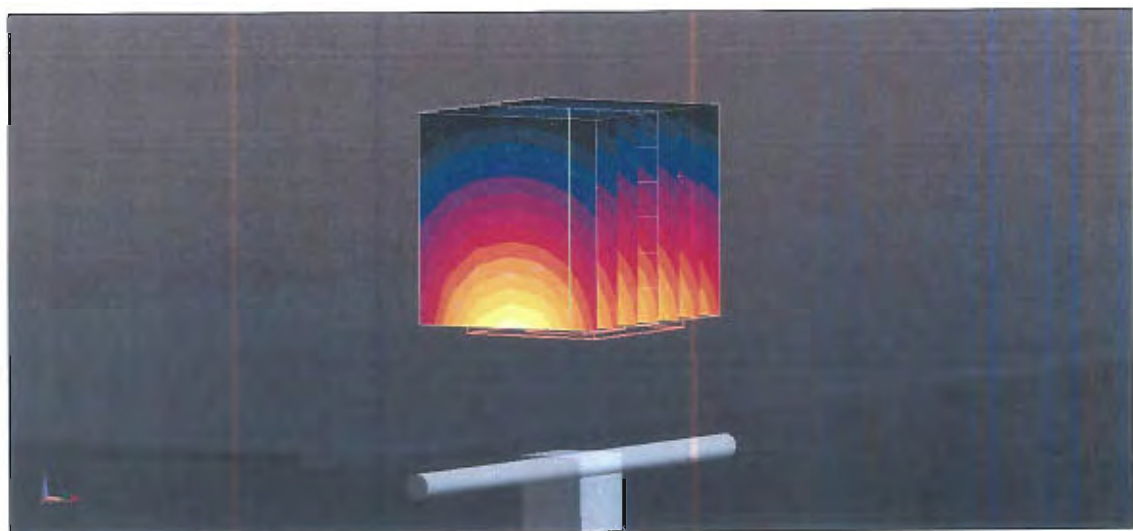
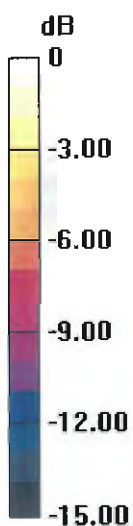

0 dB = 13.5 W/kg = 11.30 dBW/kg

# Impedance Measurement Plot for Body TSL

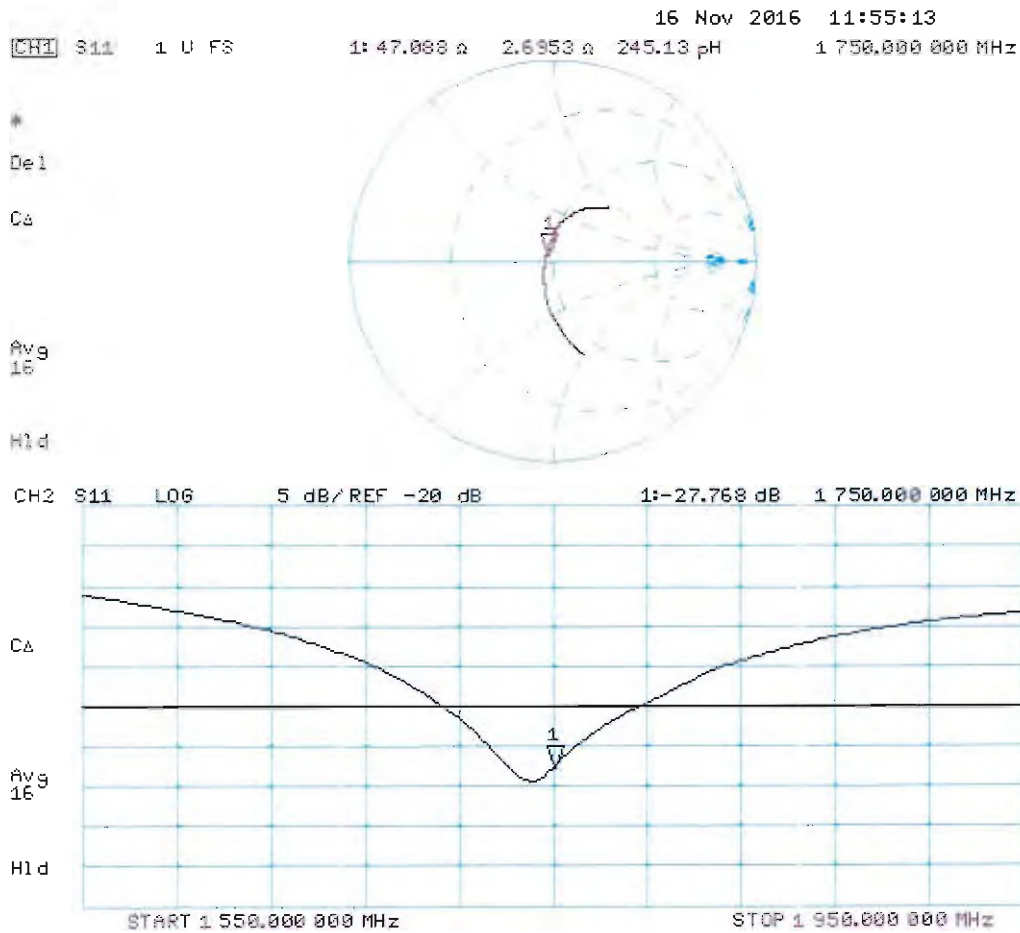





Accredited by the Swiss Accreditation Service (SAS)  
The Swiss Accreditation Service is one of the signatories to the EA  
Multilateral Agreement for the recognition of calibration certificates

Accreditation No.: **SCS 0108**

Client **Sporton-TW (Auden)**

Certificate No: **D1900V2-5d041\_Sep16**

## CALIBRATION CERTIFICATE

Object **D1900V2 - SN:5d041**

Calibration procedure(s) **QA CAL-05.v9**  
**Calibration procedure for dipole validation kits above 700 MHz**

Calibration date: **September 30, 2016**

This calibration certificate documents the traceability to national standards, which realize the physical units of measurements (SI).  
The measurements and the uncertainties with confidence probability are given on the following pages and are part of the certificate.

All calibrations have been conducted in the closed laboratory facility: environment temperature ( $22 \pm 3$ )°C and humidity < 70%.

Calibration Equipment used (M&TE critical for calibration)

Primary Standards	ID #	Cal Date (Certificate No.)	Scheduled Calibration
Power meter NRP	SN: 104778	06-Apr-16 (No. 217-02288/02289)	Apr-17
Power sensor NRP-Z91	SN: 103244	06-Apr-16 (No. 217-02288)	Apr-17
Power sensor NRP-Z91	SN: 103245	06-Apr-16 (No. 217-02289)	Apr-17
Reference 20 dB Attenuator	SN: 5058 (20k)	05-Apr-16 (No. 217-02292)	Apr-17
Type-N mismatch combination	SN: 5047.2 / 06327	05-Apr-16 (No. 217-02295)	Apr-17
Reference Probe EX3DV4	SN: 7349	15-Jun-16 (No. EX3-7349_Jun16)	Jun-17
DAE4	SN: 601	30-Dec-15 (No. DAE4-601_Dec15)	Dec-16
Secondary Standards	ID #	Check Date (in house)	Scheduled Check
Power meter EPM-442A	SN: GB37480704	07-Oct-15 (No. 217-02222)	In house check: Oct-16
Power sensor HP 8481A	SN: US37292783	07-Oct-15 (No. 217-02222)	In house check: Oct-16
Power sensor HP 8481A	SN: MY41092317	07-Oct-15 (No. 217-02223)	In house check: Oct-16
RF generator R&S SMT-06	SN: 100972	15-Jun-15 (in house check Jun-15)	In house check: Oct-16
Network Analyzer HP 8753E	SN: US37390585	18-Oct-01 (in house check Oct-15)	In house check: Oct-16

Calibrated by: **Jeton Kastrati**      Function: **Laboratory Technician**

Approved by: **Katja Pokovic**      Function: **Technical Manager**

Signature

Issued: September 30, 2016

This calibration certificate shall not be reproduced except in full without written approval of the laboratory.



Accredited by the Swiss Accreditation Service (SAS)

Accreditation No.: **SCS 0108**

The Swiss Accreditation Service is one of the signatories to the EA  
Multilateral Agreement for the recognition of calibration certificates

### Glossary:

TSL	tissue simulating liquid
ConvF	sensitivity in TSL / NORM x,y,z
N/A	not applicable or not measured

### Calibration is Performed According to the Following Standards:

- IEEE Std 1528-2013, "IEEE Recommended Practice for Determining the Peak Spatial-Averaged Specific Absorption Rate (SAR) in the Human Head from Wireless Communications Devices: Measurement Techniques", June 2013
- IEC 62209-1, "Procedure to measure the Specific Absorption Rate (SAR) for hand-held devices used in close proximity to the ear (frequency range of 300 MHz to 3 GHz)", February 2005
- IEC 62209-2, "Procedure to determine the Specific Absorption Rate (SAR) for wireless communication devices used in close proximity to the human body (frequency range of 30 MHz to 6 GHz)", March 2010
- KDB 865664, "SAR Measurement Requirements for 100 MHz to 6 GHz"

### Additional Documentation:

- DASY4/5 System Handbook

### Methods Applied and Interpretation of Parameters:

- Measurement Conditions:** Further details are available from the Validation Report at the end of the certificate. All figures stated in the certificate are valid at the frequency indicated.
- Antenna Parameters with TSL:** The dipole is mounted with the spacer to position its feed point exactly below the center marking of the flat phantom section, with the arms oriented parallel to the body axis.
- Feed Point Impedance and Return Loss:** These parameters are measured with the dipole positioned under the liquid filled phantom. The impedance stated is transformed from the measurement at the SMA connector to the feed point. The Return Loss ensures low reflected power. No uncertainty required.
- Electrical Delay:** One-way delay between the SMA connector and the antenna feed point. No uncertainty required.
- SAR measured:** SAR measured at the stated antenna input power.
- SAR normalized:** SAR as measured, normalized to an input power of 1 W at the antenna connector.
- SAR for nominal TSL parameters:** The measured TSL parameters are used to calculate the nominal SAR result.

The reported uncertainty of measurement is stated as the standard uncertainty of measurement multiplied by the coverage factor  $k=2$ , which for a normal distribution corresponds to a coverage probability of approximately 95%.

## Measurement Conditions

DASY system configuration, as far as not given on page 1.

<b>DASY Version</b>	DASY5	V52.8.8
<b>Extrapolation</b>	Advanced Extrapolation	
<b>Phantom</b>	Modular Flat Phantom	
<b>Distance Dipole Center - TSL</b>	10 mm	with Spacer
<b>Zoom Scan Resolution</b>	dx, dy, dz = 5 mm	
<b>Frequency</b>	1900 MHz $\pm$ 1 MHz	

## Head TSL parameters

The following parameters and calculations were applied.

	Temperature	Permittivity	Conductivity
<b>Nominal Head TSL parameters</b>	22.0 °C	40.0	1.40 mho/m
<b>Measured Head TSL parameters</b>	(22.0 $\pm$ 0.2) °C	40.5 $\pm$ 6 %	1.40 mho/m $\pm$ 6 %
<b>Head TSL temperature change during test</b>	< 0.5 °C	----	----

## SAR result with Head TSL

<b>SAR averaged over 1 cm<sup>3</sup> (1 g) of Head TSL</b>	Condition	
SAR measured	250 mW input power	10.1 W/kg
SAR for nominal Head TSL parameters	normalized to 1W	<b>40.5 W/kg <math>\pm</math> 17.0 % (k=2)</b>

<b>SAR averaged over 10 cm<sup>3</sup> (10 g) of Head TSL</b>	condition	
SAR measured	250 mW input power	5.33 W/kg
SAR for nominal Head TSL parameters	normalized to 1W	<b>21.4 W/kg <math>\pm</math> 16.5 % (k=2)</b>

## Body TSL parameters

The following parameters and calculations were applied.

	Temperature	Permittivity	Conductivity
<b>Nominal Body TSL parameters</b>	22.0 °C	53.3	1.52 mho/m
<b>Measured Body TSL parameters</b>	(22.0 $\pm$ 0.2) °C	53.6 $\pm$ 6 %	1.49 mho/m $\pm$ 6 %
<b>Body TSL temperature change during test</b>	< 0.5 °C	----	----

## SAR result with Body TSL

<b>SAR averaged over 1 cm<sup>3</sup> (1 g) of Body TSL</b>	Condition	
SAR measured	250 mW input power	9.58 W/kg
SAR for nominal Body TSL parameters	normalized to 1W	<b>38.8 W/kg <math>\pm</math> 17.0 % (k=2)</b>

<b>SAR averaged over 10 cm<sup>3</sup> (10 g) of Body TSL</b>	condition	
SAR measured	250 mW input power	5.10 W/kg
SAR for nominal Body TSL parameters	normalized to 1W	<b>20.6 W/kg <math>\pm</math> 16.5 % (k=2)</b>

## Appendix (Additional assessments outside the scope of SCS 0108)

### Antenna Parameters with Head TSL

Impedance, transformed to feed point	52.5 $\Omega$ + 8.0 j $\Omega$
Return Loss	- 21.8 dB

### Antenna Parameters with Body TSL

Impedance, transformed to feed point	48.7 $\Omega$ + 7.6 j $\Omega$
Return Loss	- 22.1 dB

### General Antenna Parameters and Design

Electrical Delay (one direction)	1.199 ns
----------------------------------	----------

After long term use with 100W radiated power, only a slight warming of the dipole near the feedpoint can be measured.

The dipole is made of standard semirigid coaxial cable. The center conductor of the feeding line is directly connected to the second arm of the dipole. The antenna is therefore short-circuited for DC-signals. On some of the dipoles, small end caps are added to the dipole arms in order to improve matching when loaded according to the position as explained in the "Measurement Conditions" paragraph. The SAR data are not affected by this change. The overall dipole length is still according to the Standard.

No excessive force must be applied to the dipole arms, because they might bend or the soldered connections near the feedpoint may be damaged.

### Additional EUT Data

Manufactured by	SPEAG
Manufactured on	July 04, 2003

## DASY5 Validation Report for Head TSL

Date: 28.09.2016

Test Laboratory: SPEAG, Zurich, Switzerland

**DUT: Dipole 1900 MHz; Type: D1900V2; Serial: D1900V2 - SN:5d041**

Communication System: UID 0 - CW; Frequency: 1900 MHz

Medium parameters used:  $f = 1900$  MHz;  $\sigma = 1.4$  S/m;  $\epsilon_r = 40.5$ ;  $\rho = 1000$  kg/m<sup>3</sup>

Phantom section: Flat Section

Measurement Standard: DASY5 (IEEE/IEC/ANSI C63.19-2011)

DASY52 Configuration:

- Probe: EX3DV4 - SN7349; ConvF(7.99, 7.99, 7.99); Calibrated: 15.06.2016;
- Sensor-Surface: 1.4mm (Mechanical Surface Detection)
- Electronics: DAE4 Sn601; Calibrated: 30.12.2015
- Phantom: Flat Phantom 5.0 (front); Type: QD000P50AA; Serial: 1001
- DASY52 52.8.8(1258); SEMCAD X 14.6.10(7372)

### **Dipole Calibration for Head Tissue/Pin=250 mW, d=10mm/Zoom Scan (7x7x7)/Cube 0:**

Measurement grid: dx=5mm, dy=5mm, dz=5mm

Reference Value = 108.5 V/m; Power Drift = -0.02 dB

Peak SAR (extrapolated) = 19.0 W/kg

**SAR(1 g) = 10.1 W/kg; SAR(10 g) = 5.33 W/kg**

Maximum value of SAR (measured) = 15.7 W/kg

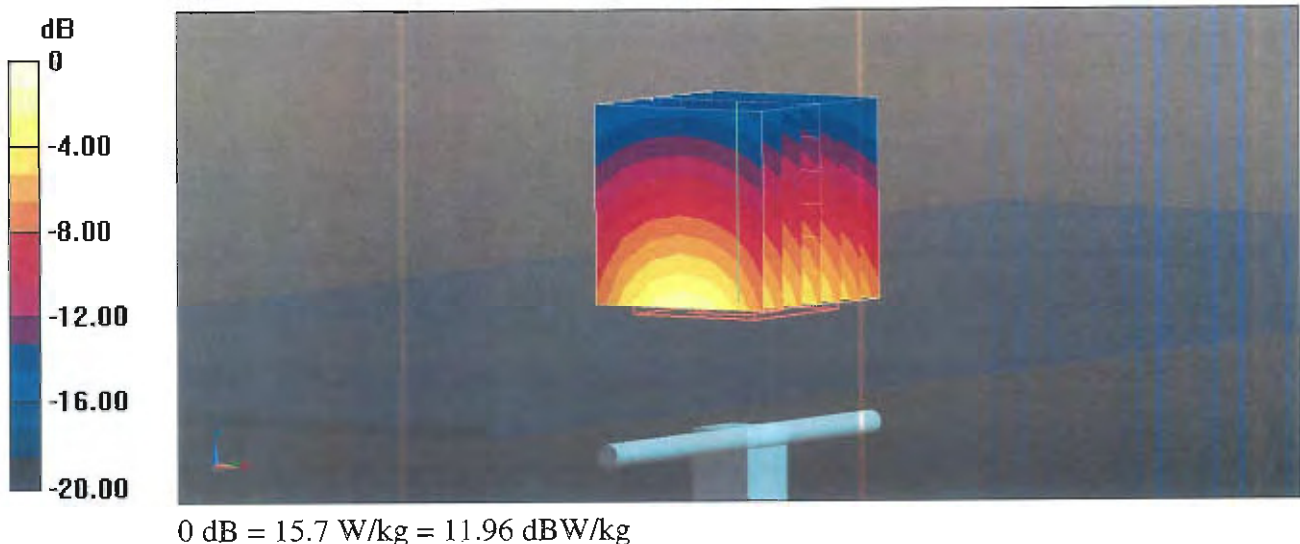

# Impedance Measurement Plot for Head TSL

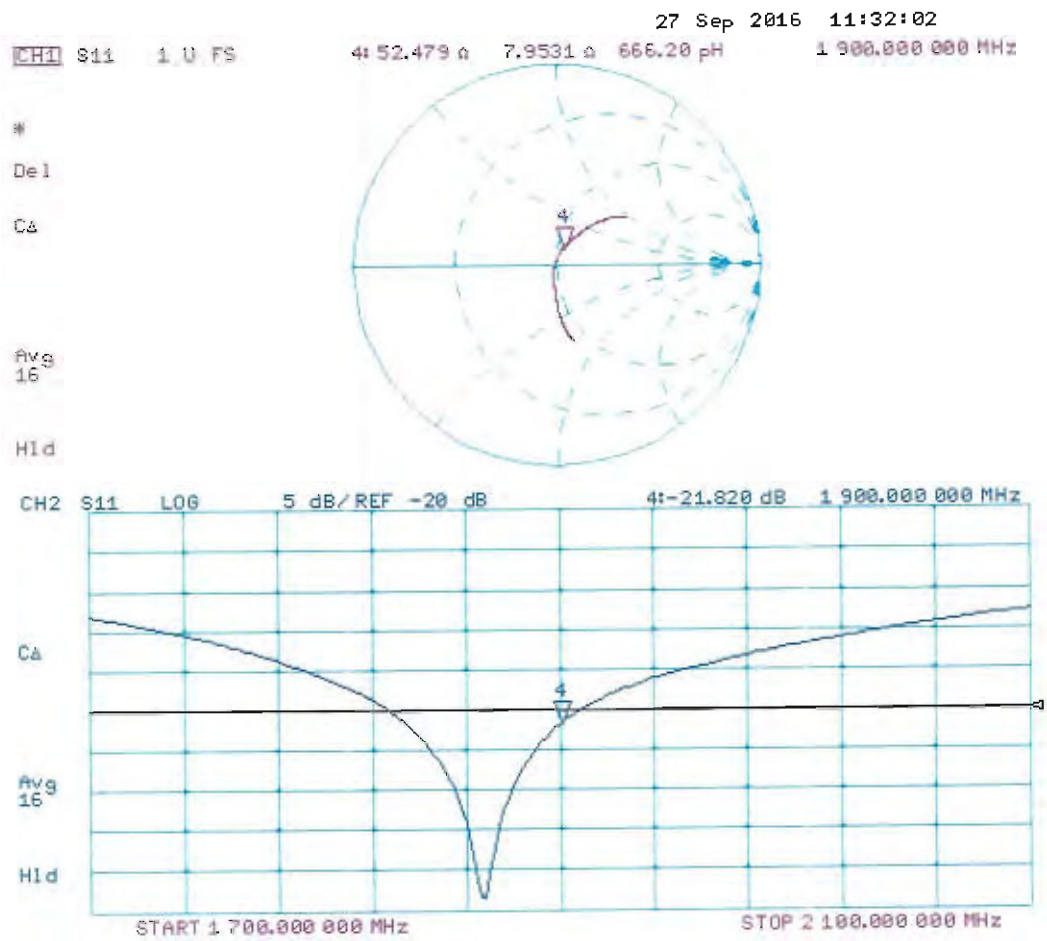

# DASY5 Validation Report for Body TSL

Date: 30.09.2016

Test Laboratory: SPEAG, Zurich, Switzerland

**DUT: Dipole 1900 MHz; Type: D1900V2; Serial: D1900V2 - SN:5d041**

Communication System: UID 0 - CW; Frequency: 1900 MHz

Medium parameters used:  $f = 1900$  MHz;  $\sigma = 1.49$  S/m;  $\epsilon_r = 53.6$ ;  $\rho = 1000$  kg/m<sup>3</sup>

Phantom section: Flat Section

Measurement Standard: DASY5 (IEEE/IEC/ANSI C63.19-2011)

DASY52 Configuration:

- Probe: EX3DV4 - SN7349; ConvF(8.03, 8.03, 8.03); Calibrated: 15.06.2016;
- Sensor-Surface: 1.4mm (Mechanical Surface Detection)
- Electronics: DAE4 Sn601; Calibrated: 30.12.2015
- Phantom: Flat Phantom 5.0 (back); Type: QD000P50AA; Serial: 1002
- DASY52 52.8.8(1258); SEMCAD X 14.6.10(7372)

## Dipole Calibration for Body Tissue/ $P_{in}=250$ mW, $d=10$ mm/Zoom Scan (7x7x7)/Cube 0:

Measurement grid:  $dx=5$ mm,  $dy=5$ mm,  $dz=5$ mm

Reference Value = 102.7 V/m; Power Drift = -0.03 dB

Peak SAR (extrapolated) = 16.7 W/kg

**SAR(1 g) = 9.58 W/kg; SAR(10 g) = 5.1 W/kg**

Maximum value of SAR (measured) = 14.3 W/kg

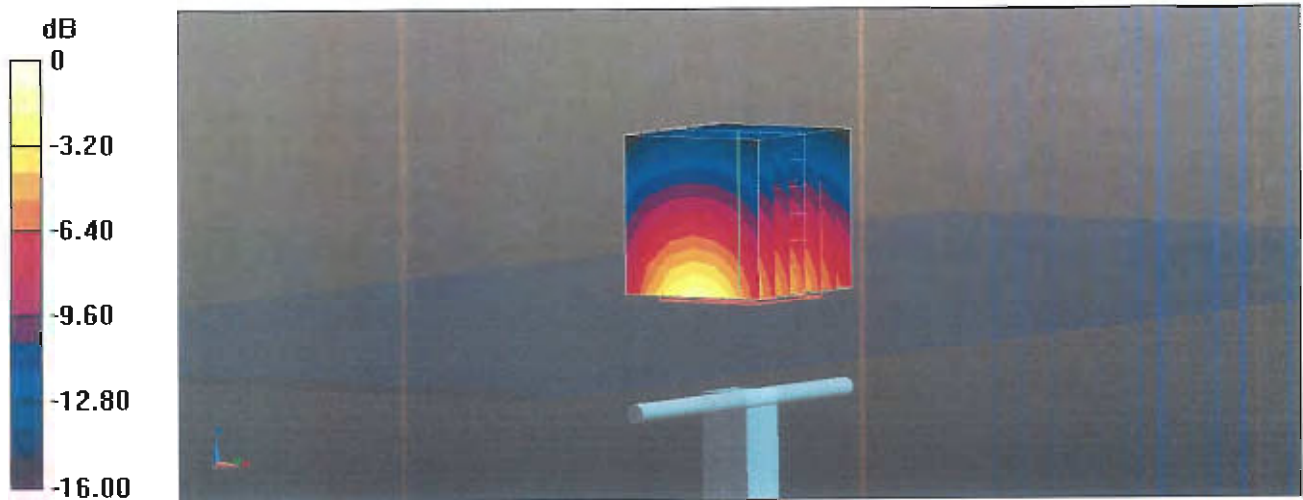

0 dB = 14.3 W/kg = 11.55 dBW/kg

# Impedance Measurement Plot for Body TSL

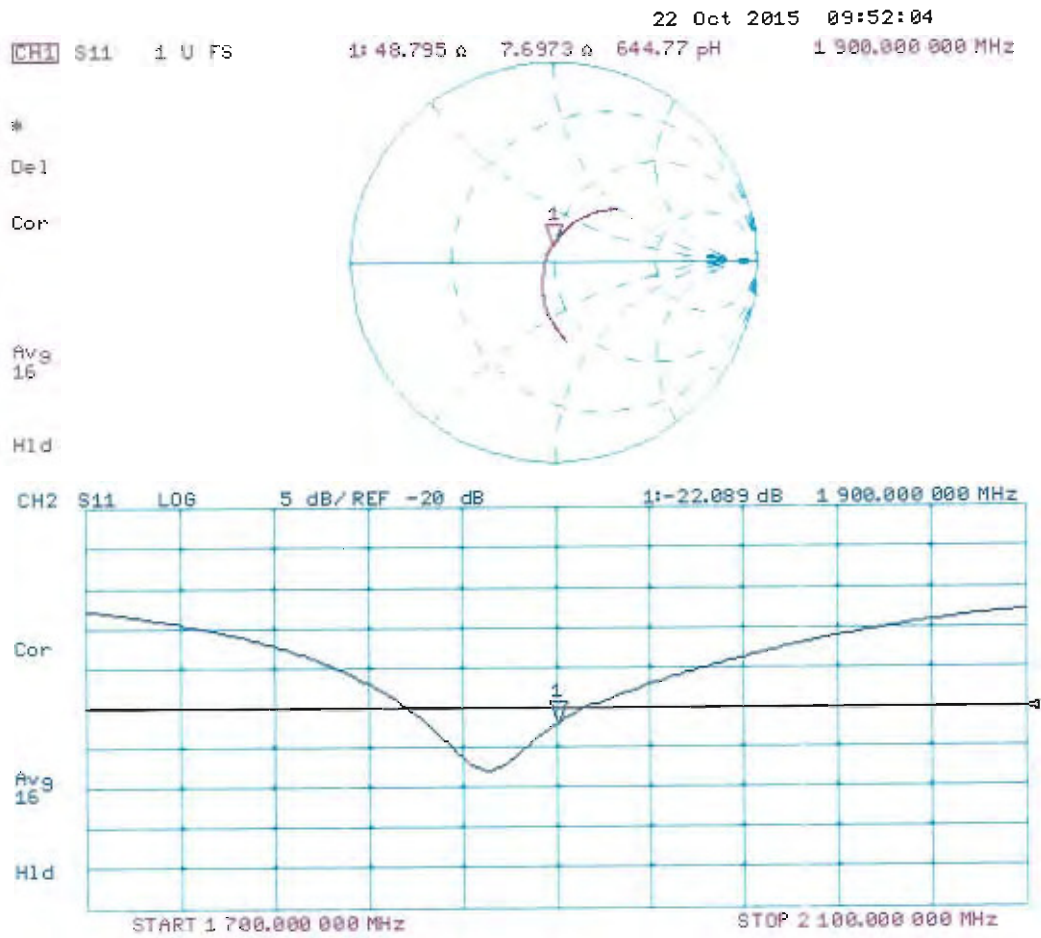





In Collaboration with  
**s p e a g**  
 CALIBRATION LABORATORY



中国认可  
 国际互认  
 校准  
 CALIBRATION  
 CNAS L0570

Add: No.51 Xueyuan Road, Haidian District, Beijing, 100191, China  
 Tel: +86-10-62304633-2079 Fax: +86-10-62304633-2504  
 E-mail: cttl@chinattl.com [Http://www.chinattl.cn](http://www.chinattl.cn)

Client

**Sporton\_TW**

Certificate No: **Z16-97130**

## CALIBRATION CERTIFICATE

Object D2450V2 - SN: 736

Calibration Procedure(s) FD-Z11-2-003-01  
 Calibration Procedures for dipole validation kits

Calibration date: August 30, 2016

This calibration Certificate documents the traceability to national standards, which realize the physical units of measurements(SI). The measurements and the uncertainties with confidence probability are given on the following pages and are part of the certificate.

All calibrations have been conducted in the closed laboratory facility: environment temperature(22±3)°C and humidity<70%.

Calibration Equipment used (M&TE critical for calibration)

Primary Standards	ID #	Cal Date(Calibrated by, Certificate No.)	Scheduled Calibration
Power Meter NRP2	101919	01-Jul-15 (CTTL, No.J15X04256)	Jun-16
Power sensor NRP-Z91	101547	01-Jul-15 (CTTL, No.J15X04256)	Jun-16
Reference Probe EX3DV4	SN 3801	29-Jun-16(SPEAG,No.EX3-3801_Jun16)	Jun-17
DAE4	SN 777	22-Aug-16(CTTL-SPEAG,No.Z16-97138)	Aug-17
Secondary Standards	ID #	Cal Date(Calibrated by, Certificate No.)	Scheduled Calibration
Signal Generator E4438C	MY49071430	01-Feb-16 (CTTL, No.J16X00893)	Jan-17
Network Analyzer E5071C	MY46110673	26-Jan-16 (CTTL, No.J16X00894)	Jan-17

	Name	Function	Signature
Calibrated by:	Zhao Jing	SAR Test Engineer	
Reviewed by:	Qi Dianyuan	SAR Project Leader	
Approved by:	Lu Bingsong	Deputy Director of the laboratory	

Issued: September 1, 2016

This calibration certificate shall not be reproduced except in full without written approval of the laboratory.



### Glossary:

TSL	tissue simulating liquid
ConvF	sensitivity in TSL / NORM <sub>x,y,z</sub>
N/A	not applicable or not measured

### Calibration is Performed According to the Following Standards:

- IEEE Std 1528-2013, "IEEE Recommended Practice for Determining the Peak Spatial-Averaged Specific Absorption Rate (SAR) in the Human Head from Wireless Communications Devices: Measurement Techniques", June 2013
- IEC 62209-1, "Procedure to measure the Specific Absorption Rate (SAR) For hand-held devices used in close proximity to the ear (frequency range of 300MHz to 3GHz)", February 2005
- IEC 62209-2, "Procedure to measure the Specific Absorption Rate (SAR) For wireless communication devices used in close proximity to the human body (frequency range of 30MHz to 6GHz)", March 2010
- KDB865664, SAR Measurement Requirements for 100 MHz to 6 GHz

### Additional Documentation:

- DASY4/5 System Handbook

### Methods Applied and Interpretation of Parameters:

- Measurement Conditions:** Further details are available from the Validation Report at the end of the certificate. All figures stated in the certificate are valid at the frequency indicated.
- Antenna Parameters with TSL:** The dipole is mounted with the spacer to position its feed point exactly below the center marking of the flat phantom section, with the arms oriented parallel to the body axis.
- Feed Point Impedance and Return Loss:** These parameters are measured with the dipole positioned under the liquid filled phantom. The impedance stated is transformed from the measurement at the SMA connector to the feed point. The Return Loss ensures low reflected power. No uncertainty required.
- Electrical Delay:** One-way delay between the SMA connector and the antenna feed point. No uncertainty required.
- SAR measured:** SAR measured at the stated antenna input power.
- SAR normalized:** SAR as measured, normalized to an input power of 1 W at the antenna connector.
- SAR for nominal TSL parameters:** The measured TSL parameters are used to calculate the nominal SAR result.

The reported uncertainty of measurement is stated as the standard uncertainty of Measurement multiplied by the coverage factor  $k=2$ , which for a normal distribution Corresponds to a coverage probability of approximately 95%.



Add: No.51 Xueyuan Road, Haidian District, Beijing, 100191, China  
 Tel: +86-10-62304633-2079 Fax: +86-10-62304633-2504  
 E-mail: cttl@chinattl.com Http://www.chinattl.cn

### Measurement Conditions

DASY system configuration, as far as not given on page 1.

<b>DASY Version</b>	DASY52	52.8.8.1258
<b>Extrapolation</b>	Advanced Extrapolation	
<b>Phantom</b>	Triple Flat Phantom 5.1C	
<b>Distance Dipole Center - TSL</b>	10 mm	with Spacer
<b>Zoom Scan Resolution</b>	dx, dy, dz = 5 mm	
<b>Frequency</b>	2450 MHz ± 1 MHz	

### Head TSL parameters

The following parameters and calculations were applied.

	Temperature	Permittivity	Conductivity
<b>Nominal Head TSL parameters</b>	22.0 °C	39.2	1.80 mho/m
<b>Measured Head TSL parameters</b>	(22.0 ± 0.2) °C	39.5 ± 6 %	1.81 mho/m ± 6 %
<b>Head TSL temperature change during test</b>	<1.0 °C	----	----

### SAR result with Head TSL

<b>SAR averaged over 1 cm<sup>3</sup> (1 g) of Head TSL</b>	Condition	
SAR measured	250 mW input power	13.3 mW / g
SAR for nominal Head TSL parameters	normalized to 1W	<b>53.1 mW / g ± 20.8 % (k=2)</b>
<b>SAR averaged over 10 cm<sup>3</sup> (10 g) of Head TSL</b>	Condition	
SAR measured	250 mW input power	6.24 mW / g
SAR for nominal Head TSL parameters	normalized to 1W	<b>25.0 mW / g ± 20.4 % (k=2)</b>

### Body TSL parameters

The following parameters and calculations were applied.

	Temperature	Permittivity	Conductivity
<b>Nominal Body TSL parameters</b>	22.0 °C	52.7	1.95 mho/m
<b>Measured Body TSL parameters</b>	(22.0 ± 0.2) °C	52.0 ± 6 %	1.93 mho/m ± 6 %
<b>Body TSL temperature change during test</b>	<1.0 °C	----	----

### SAR result with Body TSL

<b>SAR averaged over 1 cm<sup>3</sup> (1 g) of Body TSL</b>	Condition	
SAR measured	250 mW input power	13.0 mW / g
SAR for nominal Body TSL parameters	normalized to 1W	<b>52.1 mW / g ± 20.8 % (k=2)</b>
<b>SAR averaged over 10 cm<sup>3</sup> (10 g) of Body TSL</b>	Condition	
SAR measured	250 mW input power	6.10 mW / g
SAR for nominal Body TSL parameters	normalized to 1W	<b>24.4 mW / g ± 20.4 % (k=2)</b>



## Appendix

### Antenna Parameters with Head TSL

Impedance, transformed to feed point	$52.5\Omega + 4.99j\Omega$
Return Loss	- 25.3dB

### Antenna Parameters with Body TSL

Impedance, transformed to feed point	$48.0\Omega + 4.65j\Omega$
Return Loss	- 25.7dB

### General Antenna Parameters and Design

Electrical Delay (one direction)	1.053 ns
----------------------------------	----------

After long term use with 100W radiated power, only a slight warming of the dipole near the feedpoint can be measured.

The dipole is made of standard semirigid coaxial cable. The center conductor of the feeding line is directly connected to the second arm of the dipole. The antenna is therefore short-circuited for DC-signals. On some of the dipoles, small end caps are added to the dipole arms in order to improve matching when loaded according to the position as explained in the "Measurement Conditions" paragraph. The SAR data are not affected by this change. The overall dipole length is still according to the Standard.

No excessive force must be applied to the dipole arms, because they might bend or the soldered connections near the feedpoint may be damaged.

### Additional EUT Data

Manufactured by	SPEAG
-----------------	-------



Add: No.51 Xueyuan Road, Haidian District, Beijing, 100191, China  
Tel: +86-10-62304633-2079 Fax: +86-10-62304633-2504  
E-mail: cttl@chinattl.com Http://www.chinattl.cn

**DASY5 Validation Report for Head TSL**

Date: 08.30.2016

Test Laboratory: CTTL, Beijing, China

**DUT: Dipole 2450 MHz; Type: D2450V2; Serial: D2450V2 - SN: 736**

Communication System: UID 0, CW; Frequency: 2450 MHz; Duty Cycle: 1:1

Medium parameters used:  $f = 2450$  MHz;  $\sigma = 1.812$  S/m;  $\epsilon_r = 39.54$ ;  $\rho = 1000$  kg/m<sup>3</sup>

Phantom section: Right Section

Measurement Standard: DASY5 (IEEE/IEC/ANSI C63.19-2007)

DASY5 Configuration:

- Probe: EX3DV4 - SN3801; ConvF(6.67, 6.67, 6.67); Calibrated: 6/29/2016;
- Sensor-Surface: 2mm (Mechanical Surface Detection)
- Electronics: DAE4 Sn777; Calibrated: 8/22/2016
- Phantom: Triple Flat Phantom 5.1C; Type: QD 000 P51 CA; Serial: 1161/1
- Measurement SW: DASY52, Version 52.8 (8); SEMCAD X Version 14.6.10 (7372)

**Dipole Calibration/Zoom Scan (7x7x7) (7x7x7)/Cube 0:** Measurement grid: dx=5mm, dy=5mm, dz=5mm

Reference Value = 103.9 V/m; Power Drift = -0.03 dB

Peak SAR (extrapolated) = 26.9 W/kg

**SAR(1 g) = 13.3 W/kg; SAR(10 g) = 6.24 W/kg**

Maximum value of SAR (measured) = 20.2 W/kg

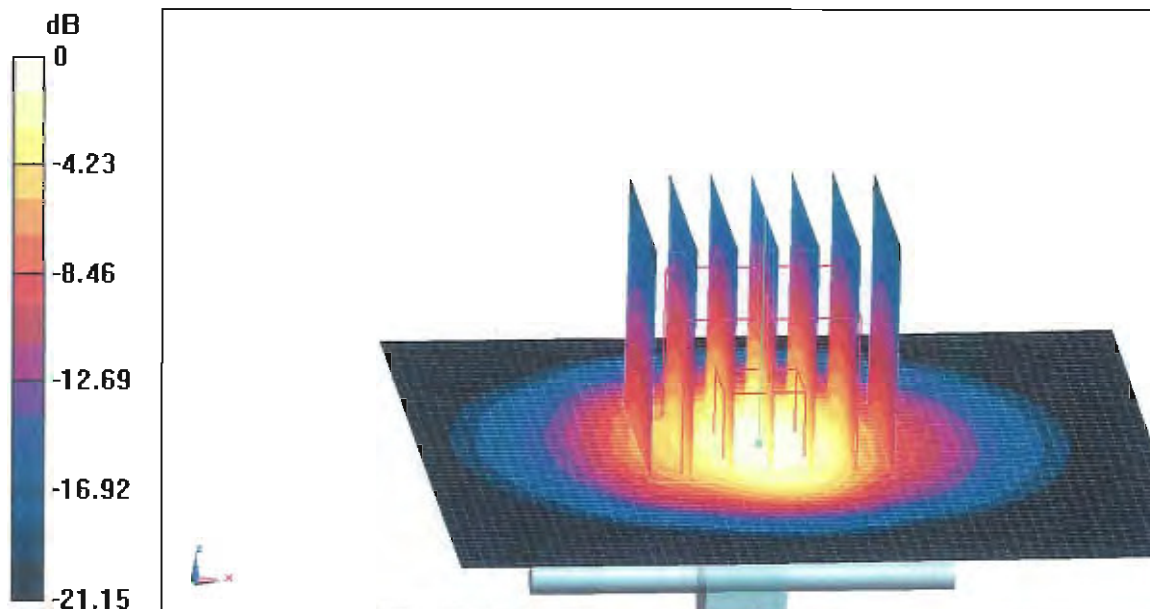

**0 dB = 20.2 W/kg = 13.05 dBW/kg**



Add: No.51 Xueyuan Road, Haidian District, Beijing, 100191, China  
Tel: +86-10-62304633-2079 Fax: +86-10-62304633-2504  
E-mail: cttl@chinattl.com Http://www.chinattl.cn

### Impedance Measurement Plot for Head TSL

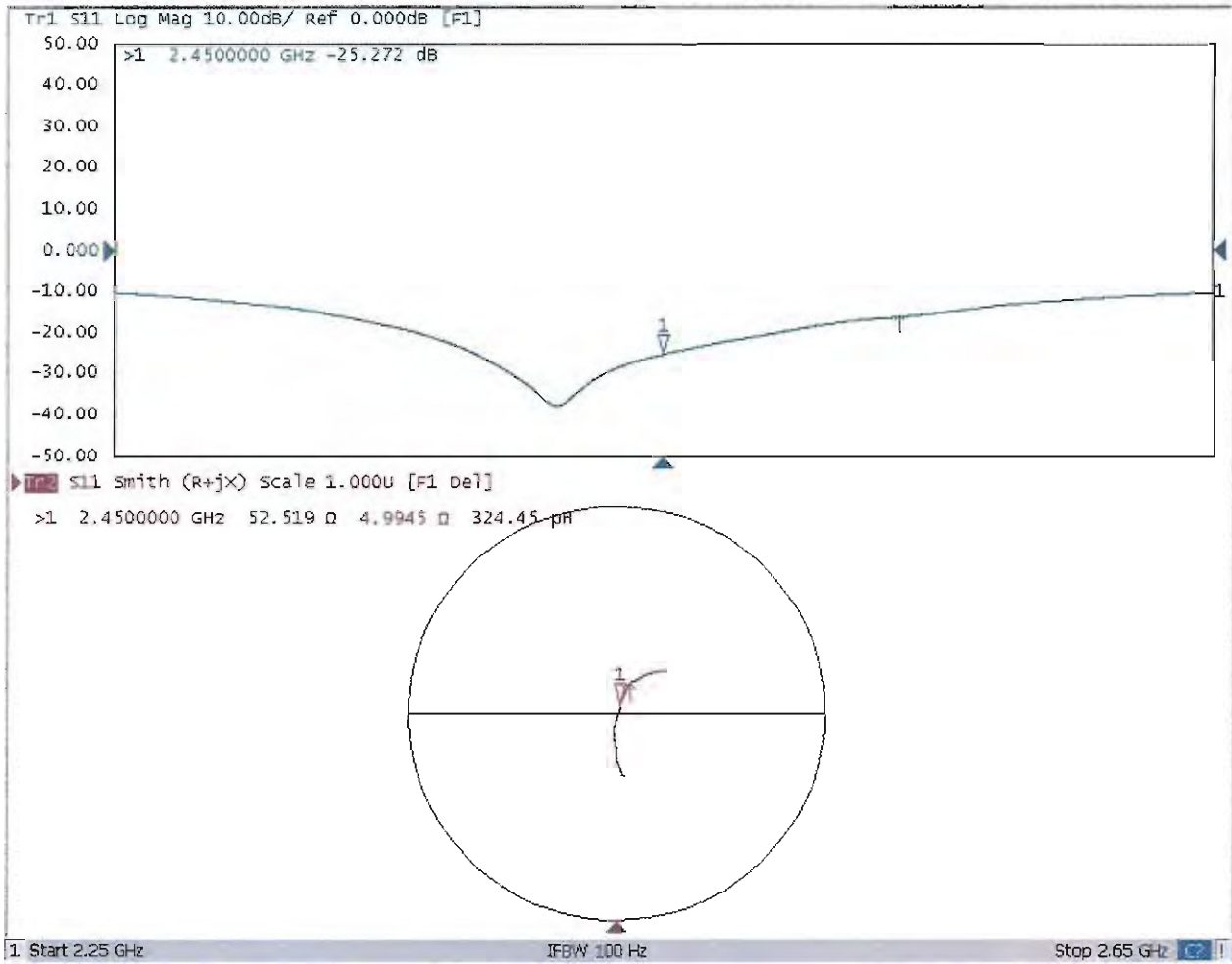



**DASY5 Validation Report for Body TSL**

Date: 08.30.2016

Test Laboratory: CTTL, Beijing, China

**DUT: Dipole 2450 MHz; Type: D2450V2; Serial: D2450V2 - SN: 736**

Communication System: UID 0, CW; Frequency: 2450 MHz; Duty Cycle: 1:1

Medium parameters used:  $f = 2450$  MHz;  $\sigma = 1.933$  S/m;  $\epsilon_r = 51.96$ ;  $\rho = 1000$  kg/m<sup>3</sup>

Phantom section: Center Section

Measurement Standard: DASY5 (IEEE/IEC/ANSI C63.19-2007)

DASY5 Configuration:

- Probe: EX3DV4 - SN3801; ConvF(6.88, 6.88, 6.88); Calibrated: 6/29/2016;
- Sensor-Surface: 2mm (Mechanical Surface Detection)
- Electronics: DAE4 Sn777; Calibrated: 8/22/2016
- Phantom: Triple Flat Phantom 5.1C; Type: QD 000 P51 CA; Serial: 1161/1
- Measurement SW: DASY52, Version 52.8 (8); SEMCAD X Version 14.6.10 (7372)

**Dipole Calibration/Zoom Scan (7x7x7) (7x7x7)/Cube 0:** Measurement grid: dx=5mm, dy=5mm, dz=5mm

Reference Value = 95.98 V/m; Power Drift = 0.04 dB

Peak SAR (extrapolated) = 26.1 W/kg

**SAR(1 g) = 13 W/kg; SAR(10 g) = 6.1 W/kg**

Maximum value of SAR (measured) = 19.6 W/kg

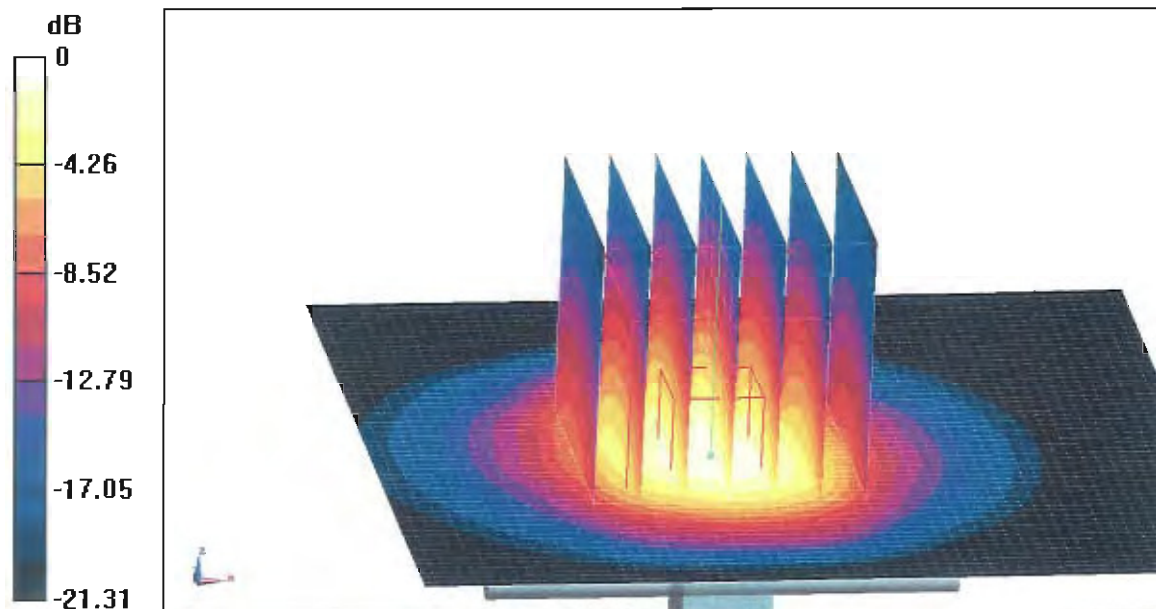

**0 dB = 19.6 W/kg = 12.92 dBW/kg**



Add: No.51 Xueyuan Road, Haidian District, Beijing, 100191, China  
Tel: +86-10-62304633-2079 Fax: +86-10-62304633-2504  
E-mail: cttl@chinattl.com Http://www.chinattl.cn

### Impedance Measurement Plot for Body TSL

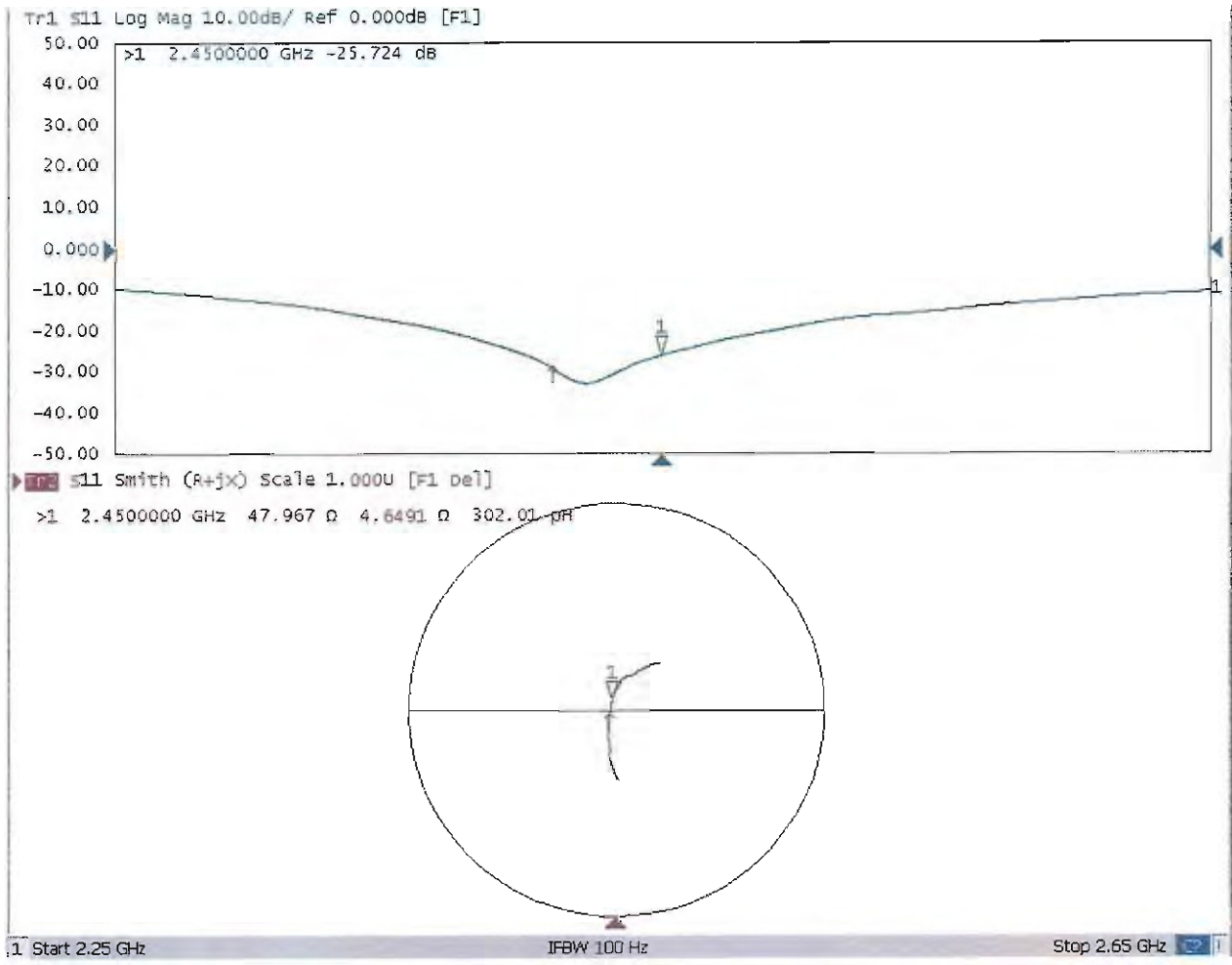





In Collaboration with  
**s p e a g**  
 CALIBRATION LABORATORY



中国认可  
 国际互认  
 校准  
 CALIBRATION  
 CNAS L0570

Add: No.51 Xueyuan Road, Haidian District, Beijing, 100191, China  
 Tel: +86-10-62304633-2079 Fax: +86-10-62304633-2504  
 E-mail: cttl@chinattl.com [Http://www.chinattl.cn](http://www.chinattl.cn)

Client **Sporton\_TW**

Certificate No: **Z16-97132**

## CALIBRATION CERTIFICATE

Object **D2600V2 - SN: 1008**

Calibration Procedure(s) **FD-Z11-2-003-01**  
 Calibration Procedures for dipole validation kits

Calibration date: **August 30, 2016**

This calibration Certificate documents the traceability to national standards, which realize the physical units of measurements(SI). The measurements and the uncertainties with confidence probability are given on the following pages and are part of the certificate.

All calibrations have been conducted in the closed laboratory facility: environment temperature(22±3)°C and humidity<70%.

Calibration Equipment used (M&TE critical for calibration)

Primary Standards	ID #	Cal Date(Calibrated by, Certificate No.)	Scheduled Calibration
Power Meter NRP2	101919	01-Jul-15 (CTTL, No.J15X04256)	Jun-16
Power sensor NRP-Z91	101547	01-Jul-15 (CTTL, No.J15X04256)	Jun-16
Reference Probe EX3DV4	SN 3801	29-Jun-16(SPEAG,No.EX3-3801_Jun16)	Jun-17
DAE4	SN 777	22-Aug-16(CTTL-SPEAG,No.Z16-97138)	Aug-17
Secondary Standards	ID #	Cal Date(Calibrated by, Certificate No.)	Scheduled Calibration
Signal Generator E4438C	MY49071430	01-Feb-16 (CTTL, No.J16X00893)	Jan-17
Network Analyzer E5071C	MY46110673	26-Jan-16 (CTTL, No.J16X00894)	Jan-17

	Name	Function	Signature
Calibrated by:	Zhao Jing	SAR Test Engineer	
Reviewed by:	Qi Dianyuan	SAR Project Leader	
Approved by:	Lu Bingsong	Deputy Director of the laboratory	

Issued: September 1, 2016

This calibration certificate shall not be reproduced except in full without written approval of the laboratory.



### Glossary:

TSL	tissue simulating liquid
ConvF	sensitivity in TSL / NORM <sub>x,y,z</sub>
N/A	not applicable or not measured

### Calibration is Performed According to the Following Standards:

- IEEE Std 1528-2013, "IEEE Recommended Practice for Determining the Peak Spatial-Averaged Specific Absorption Rate (SAR) in the Human Head from Wireless Communications Devices: Measurement Techniques", June 2013
- IEC 62209-1, "Procedure to measure the Specific Absorption Rate (SAR) For hand-held devices used in close proximity to the ear (frequency range of 300MHz to 3GHz)", February 2005
- IEC 62209-2, "Procedure to measure the Specific Absorption Rate (SAR) For wireless communication devices used in close proximity to the human body (frequency range of 30MHz to 6GHz)", March 2010
- KDB865664, SAR Measurement Requirements for 100 MHz to 6 GHz

### Additional Documentation:

- DASY4/5 System Handbook

### Methods Applied and Interpretation of Parameters:

- Measurement Conditions:** Further details are available from the Validation Report at the end of the certificate. All figures stated in the certificate are valid at the frequency indicated.
- Antenna Parameters with TSL:** The dipole is mounted with the spacer to position its feed point exactly below the center marking of the flat phantom section, with the arms oriented parallel to the body axis.
- Feed Point Impedance and Return Loss:** These parameters are measured with the dipole positioned under the liquid filled phantom. The impedance stated is transformed from the measurement at the SMA connector to the feed point. The Return Loss ensures low reflected power. No uncertainty required.
- Electrical Delay:** One-way delay between the SMA connector and the antenna feed point. No uncertainty required.
- SAR measured:** SAR measured at the stated antenna input power.
- SAR normalized:** SAR as measured, normalized to an input power of 1 W at the antenna connector.
- SAR for nominal TSL parameters:** The measured TSL parameters are used to calculate the nominal SAR result.

The reported uncertainty of measurement is stated as the standard uncertainty of Measurement multiplied by the coverage factor  $k=2$ , which for a normal distribution Corresponds to a coverage probability of approximately 95%.



### Measurement Conditions

DASY system configuration, as far as not given on page 1.

<b>DASY Version</b>	DASY52	52.8.8.1258
<b>Extrapolation</b>	Advanced Extrapolation	
<b>Phantom</b>	Triple Flat Phantom 5.1C	
<b>Distance Dipole Center - TSL</b>	10 mm	with Spacer
<b>Zoom Scan Resolution</b>	dx, dy, dz = 5 mm	
<b>Frequency</b>	2600 MHz ± 1 MHz	

### Head TSL parameters

The following parameters and calculations were applied.

	Temperature	Permittivity	Conductivity
<b>Nominal Head TSL parameters</b>	22.0 °C	39.0	1.96 mho/m
<b>Measured Head TSL parameters</b>	(22.0 ± 0.2) °C	39.4 ± 6 %	1.97 mho/m ± 6 %
<b>Head TSL temperature change during test</b>	<1.0 °C	---	---

### SAR result with Head TSL

<b>SAR averaged over 1 cm<sup>3</sup> (1 g) of Head TSL</b>	Condition	
SAR measured	250 mW input power	14.2 mW / g
SAR for nominal Head TSL parameters	normalized to 1W	<b>56.8 mW / g ± 20.8 % (k=2)</b>
<b>SAR averaged over 10 cm<sup>3</sup> (10 g) of Head TSL</b>	Condition	
SAR measured	250 mW input power	6.40 mW / g
SAR for nominal Head TSL parameters	normalized to 1W	<b>25.6 mW / g ± 20.4 % (k=2)</b>

### Body TSL parameters

The following parameters and calculations were applied.

	Temperature	Permittivity	Conductivity
<b>Nominal Body TSL parameters</b>	22.0 °C	52.5	2.16 mho/m
<b>Measured Body TSL parameters</b>	(22.0 ± 0.2) °C	52.2 ± 6 %	2.18 mho/m ± 6 %
<b>Body TSL temperature change during test</b>	<1.0 °C	---	---

### SAR result with Body TSL

<b>SAR averaged over 1 cm<sup>3</sup> (1 g) of Body TSL</b>	Condition	
SAR measured	250 mW input power	13.9 mW / g
SAR for nominal Body TSL parameters	normalized to 1W	<b>55.2 mW / g ± 20.8 % (k=2)</b>
<b>SAR averaged over 10 cm<sup>3</sup> (10 g) of Body TSL</b>	Condition	
SAR measured	250 mW input power	6.28 mW / g
SAR for nominal Body TSL parameters	normalized to 1W	<b>25.0 mW / g ± 20.4 % (k=2)</b>



## Appendix

### Antenna Parameters with Head TSL

Impedance, transformed to feed point	48.3Ω- 1.82jΩ
Return Loss	- 31.8dB

### Antenna Parameters with Body TSL

Impedance, transformed to feed point	45.8Ω- 1.91jΩ
Return Loss	- 26.4dB

### General Antenna Parameters and Design

Electrical Delay (one direction)	1.046 ns
----------------------------------	----------

After long term use with 100W radiated power, only a slight warming of the dipole near the feedpoint can be measured.

The dipole is made of standard semirigid coaxial cable. The center conductor of the feeding line is directly connected to the second arm of the dipole. The antenna is therefore short-circuited for DC-signals. On some of the dipoles, small end caps are added to the dipole arms in order to improve matching when loaded according to the position as explained in the "Measurement Conditions" paragraph. The SAR data are not affected by this change. The overall dipole length is still according to the Standard.

No excessive force must be applied to the dipole arms, because they might bend or the soldered connections near the feedpoint may be damaged.

### Additional EUT Data

Manufactured by	SPEAG
-----------------	-------



**DASY5 Validation Report for Head TSL**

Date: 08.30.2016

Test Laboratory: CTTL, Beijing, China

**DUT: Dipole 2600 MHz; Type: D2600V2; Serial: D2600V2 - SN: 1008**

Communication System: UID 0, CW; Frequency: 2600 MHz; Duty Cycle: 1:1

Medium parameters used:  $f = 2600$  MHz;  $\sigma = 1.974$  S/m;  $\epsilon_r = 39.43$ ;  $\rho = 1000$  kg/m<sup>3</sup>

Phantom section: Right Section

Measurement Standard: DASY5 (IEEE/IEC/ANSI C63.19-2007)

DASY5 Configuration:

- Probe: EX3DV4 - SN3801; ConvF(6.64, 6.64, 6.64); Calibrated: 6/29/2016;
- Sensor-Surface: 2mm (Mechanical Surface Detection)
- Electronics: DAE4 Sn777; Calibrated: 8/22/2016
- Phantom: Triple Flat Phantom 5.1C; Type: QD 000 P51 CA; Serial: 1161/1
- Measurement SW: DASY52, Version 52.8 (8); SEMCAD X Version 14.6.10 (7372)

**Dipole Calibration/Zoom Scan (7x7x7) (7x7x7)/Cube 0:** Measurement grid: dx=5mm, dy=5mm, dz=5mm

Reference Value = 107.4 V/m; Power Drift = 0.02 dB

Peak SAR (extrapolated) = 30.0 W/kg

**SAR(1 g) = 14.2 W/kg; SAR(10 g) = 6.4 W/kg**

Maximum value of SAR (measured) = 22.1 W/kg

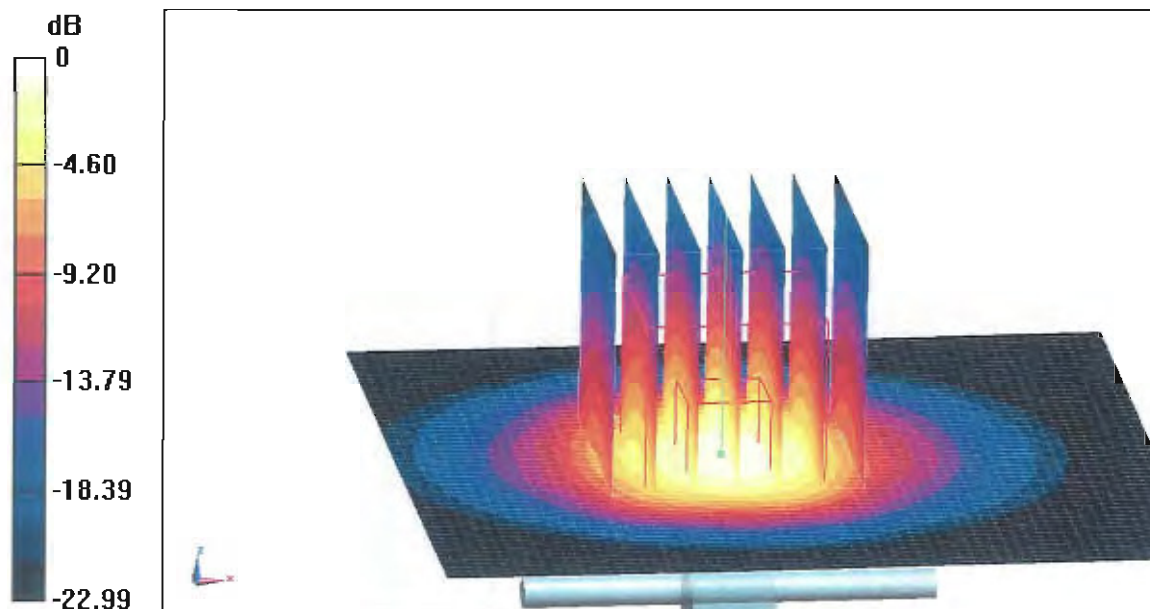

**0 dB = 22.1 W/kg = 13.44 dBW/kg**



Add: No.51 Xueyuan Road, Haidian District, Beijing, 100191, China  
Tel: +86-10-62304633-2079 Fax: +86-10-62304633-2504  
E-mail: cttl@chinattl.com Http://www.chinattl.cn

### Impedance Measurement Plot for Head TSL

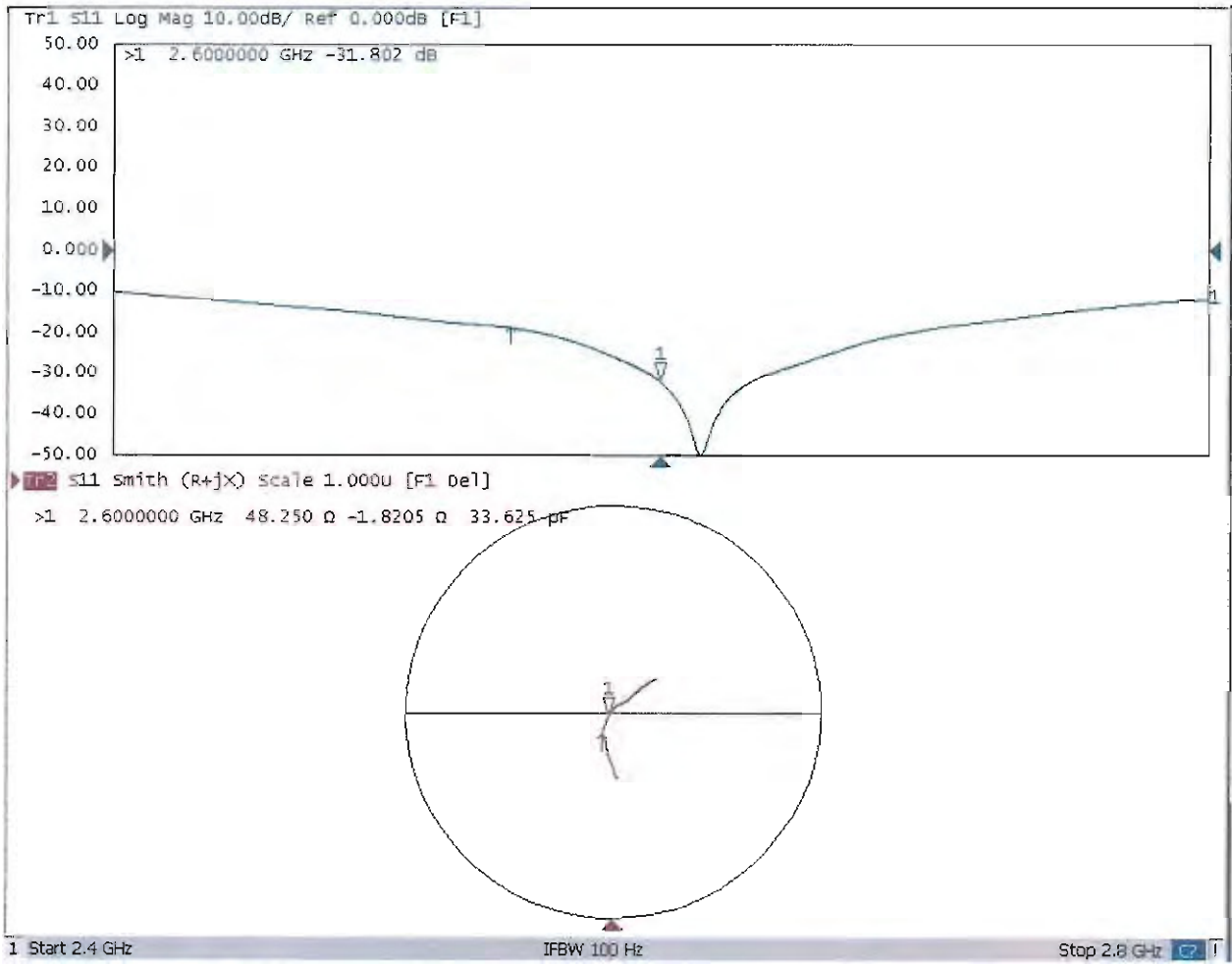



Add: No.51 Xueyuan Road, Haidian District, Beijing, 100191, China  
Tel: +86-10-62304633-2079 Fax: +86-10-62304633-2504  
E-mail: cttl@chinattl.com Http://www.chinattl.cn

### DASY5 Validation Report for Body TSL

Date: 08.30.2016

Test Laboratory: CTTL, Beijing, China

**DUT: Dipole 2600 MHz; Type: D2600V2; Serial: D2600V2 - SN: 1008**

Communication System: UID 0, CW; Frequency: 2600 MHz; Duty Cycle: 1:1

Medium parameters used:  $f = 2600$  MHz;  $\sigma = 2.184$  S/m;  $\epsilon_r = 52.15$ ;  $\rho = 1000$  kg/m<sup>3</sup>

Phantom section: Left Section

Measurement Standard: DASY5 (IEEE/IEC/ANSI C63.19-2007)

DASY5 Configuration:

- Probe: EX3DV4 - SN3801; ConvF(6.7, 6.7,6.7); Calibrated: 6/29/2016;
- Sensor-Surface: 2mm (Mechanical Surface Detection)
- Electronics: DAE4 Sn777; Calibrated: 8/22/2016
- Phantom: Triple Flat Phantom 5.1C; Type: QD 000 P51 CA; Serial: 1161/1
- Measurement SW: DASY52, Version 52.8 (8); SEMCAD X Version 14.6.10 (7372)

**Dipole Calibration/Zoom Scan (7x7x7) (7x7x7)/Cube 0:** Measurement grid: dx=5mm, dy=5mm, dz=5mm

Reference Value = 94.70 V/m; Power Drift = -0.00 dB

Peak SAR (extrapolated) = 28.8 W/kg

**SAR(1 g) = 13.9 W/kg; SAR(10 g) = 6.28 W/kg**

Maximum value of SAR (measured) = 21.3 W/kg

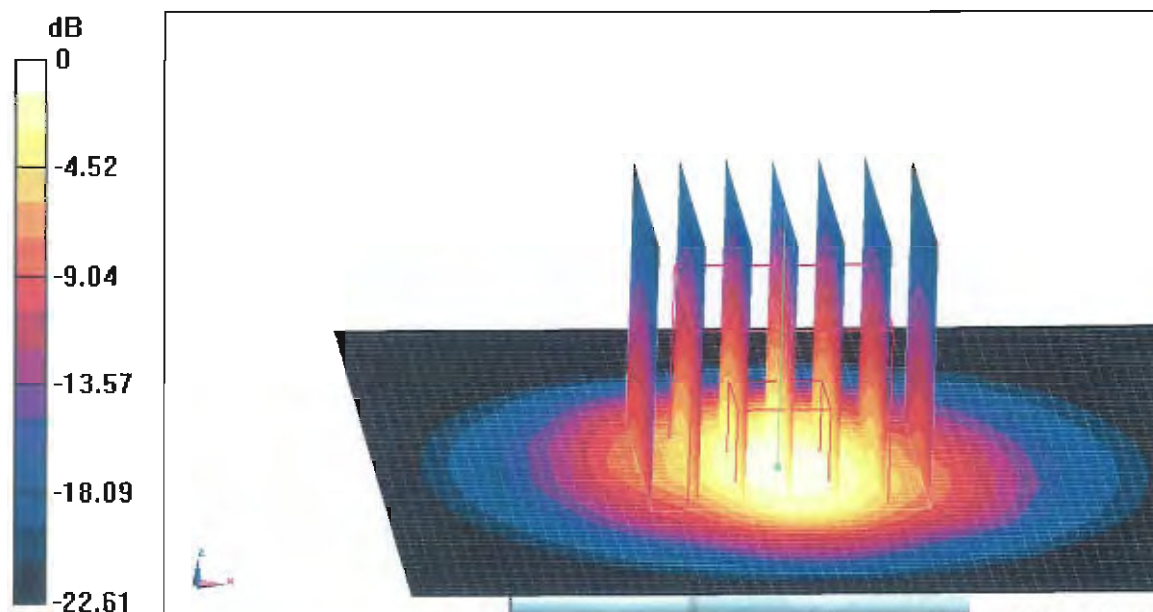

**0 dB = 21.3 W/kg = 13.28 dBW/kg**



Add: No.51 Xueyuan Road, Haidian District, Beijing, 100191, China  
Tel: +86-10-62304633-2079 Fax: +86-10-62304633-2504  
E-mail: cttl@chinattl.com Http://www.chinattl.cn

### Impedance Measurement Plot for Body TSL

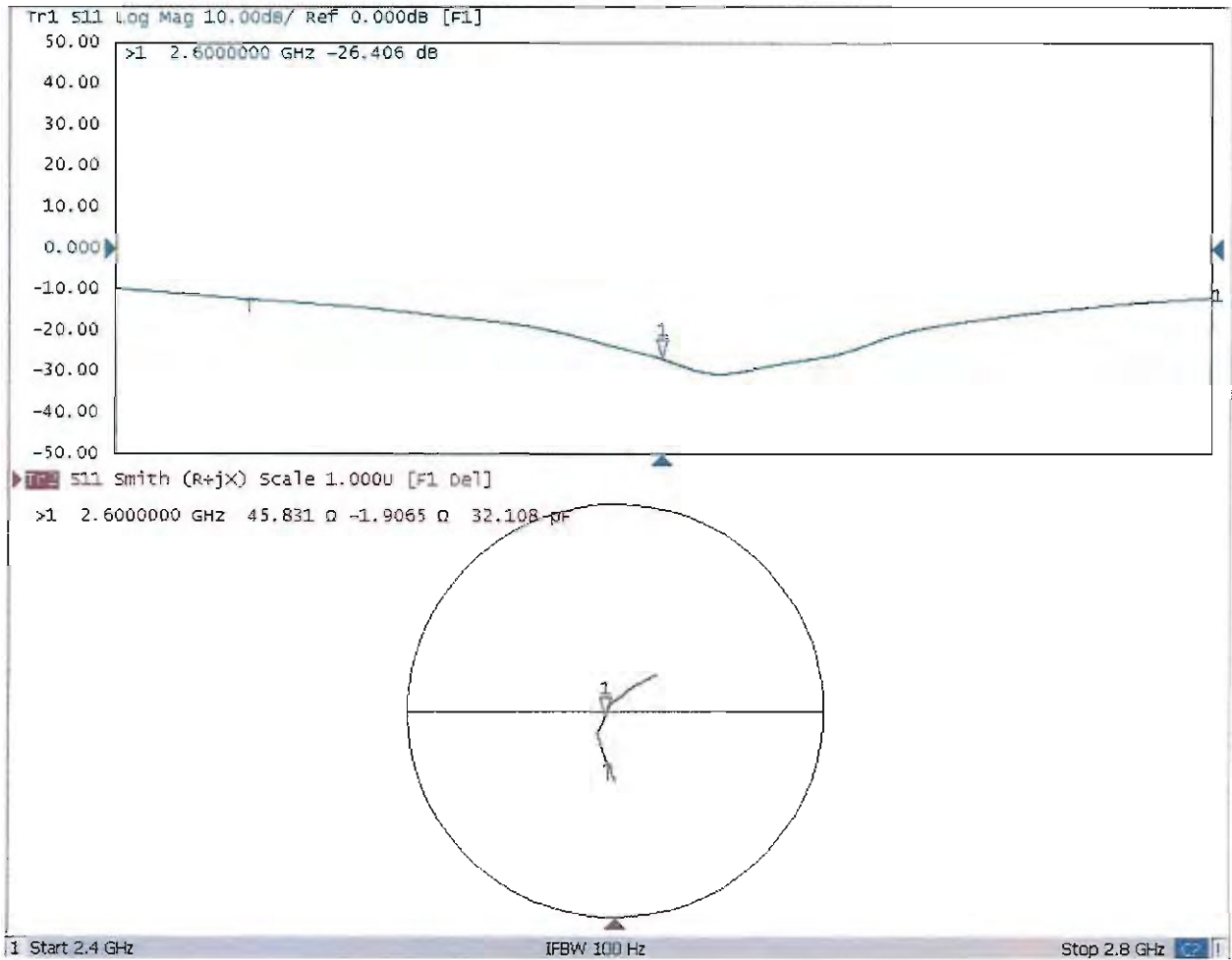





Accredited by the Swiss Accreditation Service (SAS)  
The Swiss Accreditation Service is one of the signatories to the EA  
Multilateral Agreement for the recognition of calibration certificates

Accreditation No.: **SCS 0108**

Client **Sporton-TW (Auden)**

Certificate No: **D5GHzV2-1006\_Sep16**

## CALIBRATION CERTIFICATE

Object **D5GHzV2 - SN:1006**

Calibration procedure(s) **QA CAL-22.v2**  
**Calibration procedure for dipole validation kits between 3-6 GHz**

Calibration date: **September 27, 2016**

This calibration certificate documents the traceability to national standards, which realize the physical units of measurements (SI).  
The measurements and the uncertainties with confidence probability are given on the following pages and are part of the certificate.

All calibrations have been conducted in the closed laboratory facility: environment temperature ( $22 \pm 3$ )°C and humidity < 70%.

Calibration Equipment used (M&TE critical for calibration)

Primary Standards	ID #	Cal Date (Certificate No.)	Scheduled Calibration
Power meter NRP	SN: 104778	06-Apr-16 (No. 217-02288/02289)	Apr-17
Power sensor NRP-Z91	SN: 103244	06-Apr-16 (No. 217-02288)	Apr-17
Power sensor NRP-Z91	SN: 103245	06-Apr-16 (No. 217-02289)	Apr-17
Reference 20 dB Attenuator	SN: 5058 (20k)	05-Apr-16 (No. 217-02292)	Apr-17
Type-N mismatch combination	SN: 5047.2 / 06327	05-Apr-16 (No. 217-02295)	Apr-17
Reference Probe EX3DV4	SN: 3503	30-Jun-16 (No. EX3-3503_Jun16)	Jun-17
DAE4	SN: 601	30-Dec-15 (No. DAE4-601_Dec15)	Dec-16
Secondary Standards	ID #	Check Date (in house)	Scheduled Check
Power meter EPM-442A	SN: GB37480704	07-Oct-15 (No. 217-02222)	In house check: Oct-16
Power sensor HP 8481A	SN: US37292783	07-Oct-15 (No. 217-02222)	In house check: Oct-16
Power sensor HP 8481A	SN: MY41092317	07-Oct-15 (No. 217-02223)	In house check: Oct-16
RF generator R&S SMT-06	SN: 100972	15-Jun-15 (in house check Jun-15)	In house check: Oct-16
Network Analyzer HP 8753E	SN: US37390585	18-Oct-01 (in house check Oct-15)	In house check: Oct-16

Calibrated by: **Claudio Leubler**      Name: Claudio Leubler      Function: Laboratory Technician

Approved by: **Katja Pokovic**      Name: Katja Pokovic      Function: Technical Manager

Signature

Issued: September 27, 2016

This calibration certificate shall not be reproduced except in full without written approval of the laboratory.



Accredited by the Swiss Accreditation Service (SAS)  
The Swiss Accreditation Service is one of the signatories to the EA  
Multilateral Agreement for the recognition of calibration certificates

Accreditation No.: **SCS 0108**

### Glossary:

TSL	tissue simulating liquid
ConvF	sensitivity in TSL / NORM x,y,z
N/A	not applicable or not measured

### Calibration is Performed According to the Following Standards:

- IEEE Std 1528-2013, "IEEE Recommended Practice for Determining the Peak Spatial-Averaged Specific Absorption Rate (SAR) in the Human Head from Wireless Communications Devices: Measurement Techniques", June 2013
- IEC 62209-2, "Procedure to determine the Specific Absorption Rate (SAR) for wireless communication devices used in close proximity to the human body (frequency range of 30 MHz to 6 GHz)", March 2010
- KDB 865664, "SAR Measurement Requirements for 100 MHz to 6 GHz"

### Additional Documentation:

- DASY4/5 System Handbook

### Methods Applied and Interpretation of Parameters:

- Measurement Conditions:** Further details are available from the Validation Report at the end of the certificate. All figures stated in the certificate are valid at the frequency indicated.
- Antenna Parameters with TSL:** The dipole is mounted with the spacer to position its feed point exactly below the center marking of the flat phantom section, with the arms oriented parallel to the body axis.
- Feed Point Impedance and Return Loss:** These parameters are measured with the dipole positioned under the liquid filled phantom. The impedance stated is transformed from the measurement at the SMA connector to the feed point. The Return Loss ensures low reflected power. No uncertainty required.
- Electrical Delay:** One-way delay between the SMA connector and the antenna feed point. No uncertainty required.
- SAR measured:** SAR measured at the stated antenna input power.
- SAR normalized:** SAR as measured, normalized to an input power of 1 W at the antenna connector.
- SAR for nominal TSL parameters:** The measured TSL parameters are used to calculate the nominal SAR result.

The reported uncertainty of measurement is stated as the standard uncertainty of measurement multiplied by the coverage factor  $k=2$ , which for a normal distribution corresponds to a coverage probability of approximately 95%.

## Measurement Conditions

DASY system configuration, as far as not given on page 1.

<b>DASY Version</b>	DASY5	V52.8.8
<b>Extrapolation</b>	Advanced Extrapolation	
<b>Phantom</b>	Modular Flat Phantom V5.0	
<b>Distance Dipole Center - TSL</b>	10 mm	with Spacer
<b>Zoom Scan Resolution</b>	dx, dy = 4.0 mm, dz = 1.4 mm	Graded Ratio = 1.4 (Z direction)
<b>Frequency</b>	5250 MHz ± 1 MHz 5600 MHz ± 1 MHz 5750 MHz ± 1 MHz	

## Head TSL parameters at 5250 MHz

The following parameters and calculations were applied.

	Temperature	Permittivity	Conductivity
<b>Nominal Head TSL parameters</b>	22.0 °C	35.9	4.71 mho/m
<b>Measured Head TSL parameters</b>	(22.0 ± 0.2) °C	34.5 ± 6 %	4.59 mho/m ± 6 %
<b>Head TSL temperature change during test</b>	< 0.5 °C	----	----

## SAR result with Head TSL at 5250 MHz

<b>SAR averaged over 1 cm<sup>3</sup> (1 g) of Head TSL</b>	Condition	
SAR measured	100 mW input power	8.13 W/kg
SAR for nominal Head TSL parameters	normalized to 1W	<b>80.6 W/kg ± 19.9 % (k=2)</b>

<b>SAR averaged over 10 cm<sup>3</sup> (10 g) of Head TSL</b>	condition	
SAR measured	100 mW input power	2.32 W/kg
SAR for nominal Head TSL parameters	normalized to 1W	<b>22.9 W/kg ± 19.5 % (k=2)</b>

## Head TSL parameters at 5600 MHz

The following parameters and calculations were applied.

	Temperature	Permittivity	Conductivity
<b>Nominal Head TSL parameters</b>	22.0 °C	35.5	5.07 mho/m
<b>Measured Head TSL parameters</b>	(22.0 ± 0.2) °C	34.0 ± 6 %	4.93 mho/m ± 6 %
<b>Head TSL temperature change during test</b>	< 0.5 °C	----	----

## SAR result with Head TSL at 5600 MHz

<b>SAR averaged over 1 cm<sup>3</sup> (1 g) of Head TSL</b>	Condition	
SAR measured	100 mW input power	8.47 W/kg
SAR for nominal Head TSL parameters	normalized to 1W	<b>83.8 W / kg ± 19.9 % (k=2)</b>

<b>SAR averaged over 10 cm<sup>3</sup> (10 g) of Head TSL</b>	condition	
SAR measured	100 mW input power	2.40 W/kg
SAR for nominal Head TSL parameters	normalized to 1W	<b>23.7 W/kg ± 19.5 % (k=2)</b>

## Head TSL parameters at 5750 MHz

The following parameters and calculations were applied.

	Temperature	Permittivity	Conductivity
Nominal Head TSL parameters	22.0 °C	35.4	5.22 mho/m
Measured Head TSL parameters	(22.0 ± 0.2) °C	33.8 ± 6 %	5.08 mho/m ± 6 %
Head TSL temperature change during test	< 0.5 °C	----	----

## SAR result with Head TSL at 5750 MHz

SAR averaged over 1 cm <sup>3</sup> (1 g) of Head TSL	Condition	
SAR measured	100 mW input power	8.14 W/kg
SAR for nominal Head TSL parameters	normalized to 1W	<b>80.5 W/kg ± 19.9 % (k=2)</b>

SAR averaged over 10 cm <sup>3</sup> (10 g) of Head TSL	condition	
SAR measured	100 mW input power	2.30 W/kg
SAR for nominal Head TSL parameters	normalized to 1W	<b>22.7 W/kg ± 19.5 % (k=2)</b>

## Body TSL parameters at 5250 MHz

The following parameters and calculations were applied.

	Temperature	Permittivity	Conductivity
Nominal Body TSL parameters	22.0 °C	48.9	5.36 mho/m
Measured Body TSL parameters	(22.0 ± 0.2) °C	47.4 ± 6 %	5.52 mho/m ± 6 %
Body TSL temperature change during test	< 0.5 °C	----	----

## SAR result with Body TSL at 5250 MHz

SAR averaged over 1 cm <sup>3</sup> (1 g) of Body TSL	Condition	
SAR measured	100 mW input power	7.59 W/kg
SAR for nominal Body TSL parameters	normalized to 1W	<b>75.5 W/kg ± 19.9 % (k=2)</b>

SAR averaged over 10 cm <sup>3</sup> (10 g) of Body TSL	condition	
SAR measured	100 mW input power	2.13 W/kg
SAR for nominal Body TSL parameters	normalized to 1W	<b>21.2 W/kg ± 19.5 % (k=2)</b>

### Body TSL parameters at 5600 MHz

The following parameters and calculations were applied.

	Temperature	Permittivity	Conductivity
Nominal Body TSL parameters	22.0 °C	48.5	5.77 mho/m
Measured Body TSL parameters	(22.0 ± 0.2) °C	46.8 ± 6 %	6.00 mho/m ± 6 %
Body TSL temperature change during test	< 0.5 °C	----	----

### SAR result with Body TSL at 5600 MHz

SAR averaged over 1 cm <sup>3</sup> (1 g) of Body TSL	Condition	
SAR measured	100 mW input power	7.90 W/kg
SAR for nominal Body TSL parameters	normalized to 1W	<b>78.6 W/kg ± 19.9 % (k=2)</b>

SAR averaged over 10 cm <sup>3</sup> (10 g) of Body TSL	condition	
SAR measured	100 mW input power	2.22 W/kg
SAR for nominal Body TSL parameters	normalized to 1W	<b>22.0 W/kg ± 19.5 % (k=2)</b>

### Body TSL parameters at 5750 MHz

The following parameters and calculations were applied.

	Temperature	Permittivity	Conductivity
Nominal Body TSL parameters	22.0 °C	48.3	5.94 mho/m
Measured Body TSL parameters	(22.0 ± 0.2) °C	46.5 ± 6 %	6.21 mho/m ± 6 %
Body TSL temperature change during test	< 0.5 °C	----	----

### SAR result with Body TSL at 5750 MHz

SAR averaged over 1 cm <sup>3</sup> (1 g) of Body TSL	Condition	
SAR measured	100 mW input power	7.50 W/kg
SAR for nominal Body TSL parameters	normalized to 1W	<b>74.6 W/kg ± 19.9 % (k=2)</b>

SAR averaged over 10 cm <sup>3</sup> (10 g) of Body TSL	condition	
SAR measured	100 mW input power	2.10 W/kg
SAR for nominal Body TSL parameters	normalized to 1W	<b>20.8 W/kg ± 19.5 % (k=2)</b>

## Appendix (Additional assessments outside the scope of SCS 0108)

### Antenna Parameters with Head TSL at 5250 MHz

Impedance, transformed to feed point	55.6 $\Omega$ - 6.5 j $\Omega$
Return Loss	- 21.8 dB

### Antenna Parameters with Head TSL at 5600 MHz

Impedance, transformed to feed point	57.5 $\Omega$ - 4.7 j $\Omega$
Return Loss	- 21.7 dB

### Antenna Parameters with Head TSL at 5750 MHz

Impedance, transformed to feed point	59.2 $\Omega$ + 5.8 j $\Omega$
Return Loss	- 20.1 dB

### Antenna Parameters with Body TSL at 5250 MHz

Impedance, transformed to feed point	55.5 $\Omega$ - 3.4 j $\Omega$
Return Loss	- 24.2 dB

### Antenna Parameters with Body TSL at 5600 MHz

Impedance, transformed to feed point	59.3 $\Omega$ - 1.9 j $\Omega$
Return Loss	- 21.2 dB

### Antenna Parameters with Body TSL at 5750 MHz

Impedance, transformed to feed point	58.8 $\Omega$ + 8.9 j $\Omega$
Return Loss	- 18.8 dB

### General Antenna Parameters and Design

Electrical Delay (one direction)	1.201 ns
----------------------------------	----------

After long term use with 100W radiated power, only a slight warming of the dipole near the feedpoint can be measured.

The dipole is made of standard semirigid coaxial cable. The center conductor of the feeding line is directly connected to the second arm of the dipole. The antenna is therefore short-circuited for DC-signals. On some of the dipoles, small end caps are added to the dipole arms in order to improve matching when loaded according to the position as explained in the "Measurement Conditions" paragraph. The SAR data are not affected by this change. The overall dipole length is still according to the Standard.

No excessive force must be applied to the dipole arms, because they might bend or the soldered connections near the feedpoint may be damaged.

### Additional EUT Data

Manufactured by	SPEAG
Manufactured on	August 28, 2003

Test Laboratory: SPEAG, Zurich, Switzerland

**DUT: Dipole D5GHzV2; Type: D5GHzV2; Serial: D5GHzV2 - SN:1006**

Communication System: UID 0 - CW; Frequency: 5250 MHz, Frequency: 5600 MHz, Frequency: 5750 MHz

Medium parameters used:  $f = 5250$  MHz;  $\sigma = 4.59$  S/m;  $\epsilon_r = 34.5$ ;  $\rho = 1000$  kg/m<sup>3</sup>

Medium parameters used:  $f = 5600$  MHz;  $\sigma = 4.93$  S/m;  $\epsilon_r = 34.0$ ;  $\rho = 1000$  kg/m<sup>3</sup>

Medium parameters used:  $f = 5750$  MHz;  $\sigma = 5.08$  S/m;  $\epsilon_r = 33.8$ ;  $\rho = 1000$  kg/m<sup>3</sup>

Phantom section: Flat Section

Measurement Standard: DASY5 (IEEE/IEC/ANSI C63.19-2011)

DASY52 Configuration:

- Probe: EX3DV4 - SN3503; ConvF(5.42, 5.42, 5.42); Calibrated: 30.06.2016, ConvF(4.89, 4.89, 4.89); Calibrated: 30.06.2016, ConvF(4.85, 4.85, 4.85); Calibrated: 30.06.2016;
- Sensor-Surface: 1.4mm (Mechanical Surface Detection)
- Electronics: DAE4 Sn601; Calibrated: 30.12.2015
- Phantom: Flat Phantom 5.0 (front); Type: QD000P50AA; Serial: 1001
- DASY52 52.8.8(1258); SEMCAD X 14.6.10(7372)

**Dipole Calibration for Head Tissue/Pin=100mW, dist=10mm, f=5250 MHz/Zoom Scan, dist=1.4mm (8x8x7)/Cube 0:** Measurement grid: dx=4mm, dy=4mm, dz=1.4mm

Reference Value = 72.67 V/m; Power Drift = 0.03 dB

Peak SAR (extrapolated) = 29.4 W/kg

**SAR(1 g) = 8.13 W/kg; SAR(10 g) = 2.32 W/kg**

Maximum value of SAR (measured) = 18.2 W/kg

**Dipole Calibration for Head Tissue/Pin=100mW, dist=10mm, f=5600 MHz/Zoom Scan, dist=1.4mm (8x8x7)/Cube 0:** Measurement grid: dx=4mm, dy=4mm, dz=1.4mm

Reference Value = 72.60 V/m; Power Drift = 0.04 dB

Peak SAR (extrapolated) = 33.1 W/kg

**SAR(1 g) = 8.47 W/kg; SAR(10 g) = 2.4 W/kg**

Maximum value of SAR (measured) = 19.7 W/kg

**Dipole Calibration for Head Tissue/Pin=100mW, dist=10mm, f=5750 MHz/Zoom Scan, dist=1.4mm (8x8x7)/Cube 0:** Measurement grid: dx=4mm, dy=4mm, dz=1.4mm

Reference Value = 70.56 V/m; Power Drift = 0.03 dB

Peak SAR (extrapolated) = 33.0 W/kg

**SAR(1 g) = 8.14 W/kg; SAR(10 g) = 2.3 W/kg**

Maximum value of SAR (measured) = 19.2 W/kg

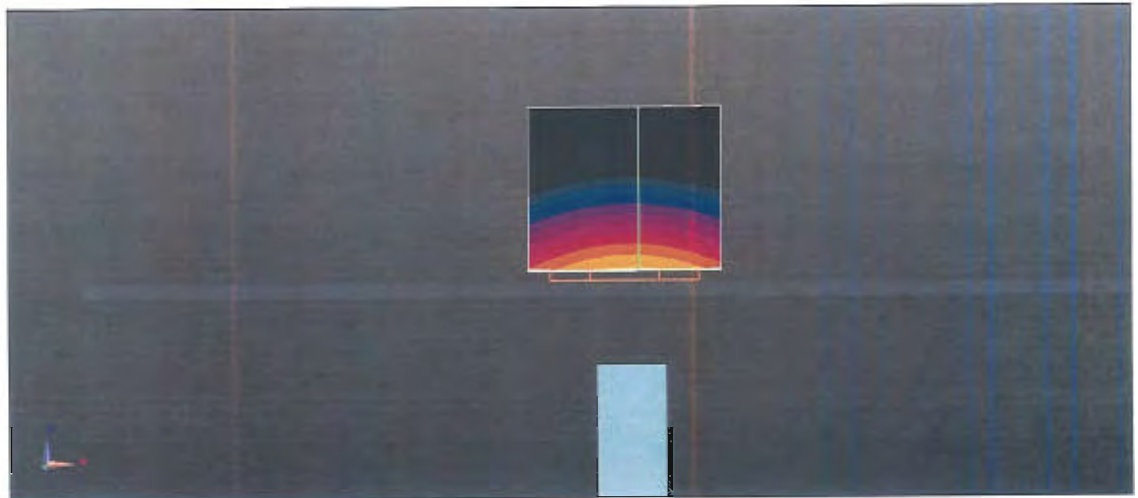
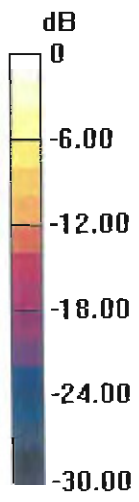

0 dB = 19.2 W/kg = 12.83 dBW/kg



# Impedance Measurement Plot for Head TSL

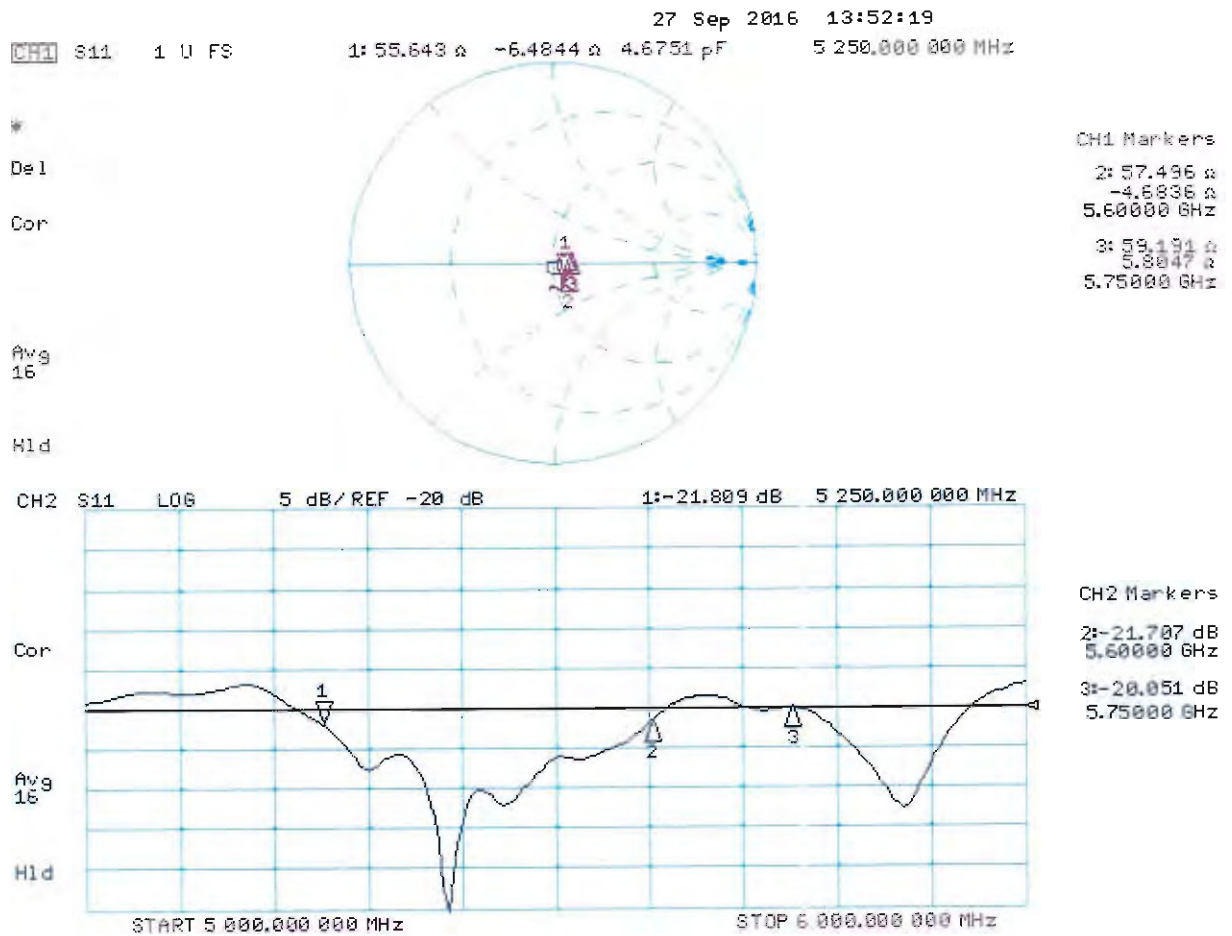

Test Laboratory: SPEAG, Zurich, Switzerland

**DUT: Dipole D5GHzV2; Type: D5GHzV2; Serial: D5GHzV2 - SN:1006**

Communication System: UID 0 - CW; Frequency: 5250 MHz, Frequency: 5600 MHz, Frequency: 5750 MHz

Medium parameters used:  $f = 5250$  MHz;  $\sigma = 5.52$  S/m;  $\epsilon_r = 47.4$ ;  $\rho = 1000$  kg/m<sup>3</sup>

Medium parameters used:  $f = 5600$  MHz;  $\sigma = 6.00$  S/m;  $\epsilon_r = 46.8$ ;  $\rho = 1000$  kg/m<sup>3</sup>

Medium parameters used:  $f = 5750$  MHz;  $\sigma = 6.21$  S/m;  $\epsilon_r = 46.5$ ;  $\rho = 1000$  kg/m<sup>3</sup>

Phantom section: Flat Section

Measurement Standard: DASY5 (IEEE/IEC/ANSI C63.19-2011)

DASY52 Configuration:

- Probe: EX3DV4 - SN3503; ConvF(4.85, 4.85, 4.85); Calibrated: 30.06.2016, ConvF(4.35, 4.35, 4.35); Calibrated: 30.06.2016, ConvF(4.3, 4.3, 4.3); Calibrated: 30.06.2016;
- Sensor-Surface: 1.4mm (Mechanical Surface Detection)
- Electronics: DAE4 Sn601; Calibrated: 30.12.2015
- Phantom: Flat Phantom 5.0 (back); Type: QD000P50AA; Serial: 1002
- DASY52 52.8.8(1258); SEMCAD X 14.6.10(7372)

**Dipole Calibration for Body Tissue/Pin=100mW, dist=10mm, f=5250 MHz/Zoom Scan, dist=1.4mm (8x8x7)/Cube 0:** Measurement grid: dx=4mm, dy=4mm, dz=1.4mm

Reference Value = 66.79 V/m; Power Drift = -0.07 dB

Peak SAR (extrapolated) = 28.8 W/kg

**SAR(1 g) = 7.59 W/kg; SAR(10 g) = 2.13 W/kg**

Maximum value of SAR (measured) = 17.9 W/kg

**Dipole Calibration for Body Tissue/Pin=100mW, dist=10mm, f=5600 MHz/Zoom Scan, dist=1.4mm (8x8x7)/Cube 0:** Measurement grid: dx=4mm, dy=4mm, dz=1.4mm

Reference Value = 67.00 V/m; Power Drift = -0.07 dB

Peak SAR (extrapolated) = 32.5 W/kg

**SAR(1 g) = 7.9 W/kg; SAR(10 g) = 2.22 W/kg**

Maximum value of SAR (measured) = 19.0 W/kg

**Dipole Calibration for Body Tissue/Pin=100mW, dist=10mm, f=5750 MHz/Zoom Scan, dist=1.4mm (8x8x7)/Cube 0:** Measurement grid: dx=4mm, dy=4mm, dz=1.4mm

Reference Value = 64.64 V/m; Power Drift = -0.03 dB

Peak SAR (extrapolated) = 32.2 W/kg

**SAR(1 g) = 7.5 W/kg; SAR(10 g) = 2.1 W/kg**

Maximum value of SAR (measured) = 18.5 W/kg

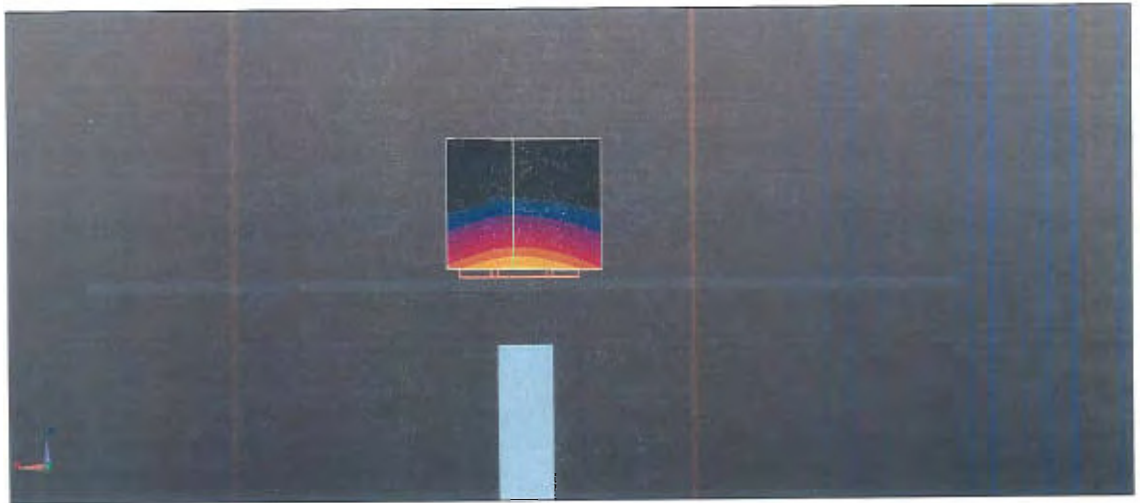
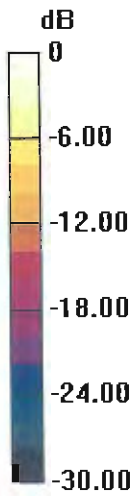

0 dB = 18.5 W/kg = 12.67 dBW/kg

# Impedance Measurement Plot for Body TSL

26 Sep 2016 07:46:17

CH1 S11 1 U FS

1: 55.521  $\Omega$  -3.4188  $\Omega$  8.8694 pF

5 250.000 000 MHz

\*  
Del  
Cor  
Avg  
16  
H1d

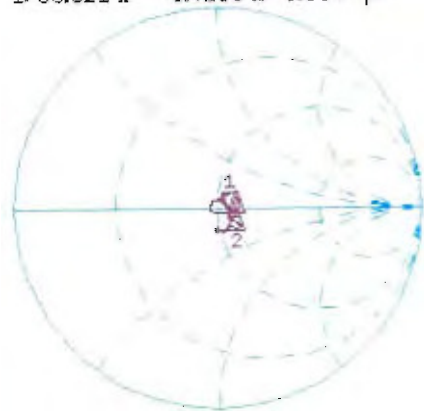

CH1 Markers  
2: 59.314  $\Omega$   
-1.8555  $\Omega$   
5.60000 GHz  
3: 58.801  $\Omega$   
8.8986  $\Omega$   
5.75000 GHz

CH2 S11 LOG 5 dB/REF -20 dB 1:-24.217 dB 5 250.000 000 MHz

Cor  
Avg  
16  
H1d

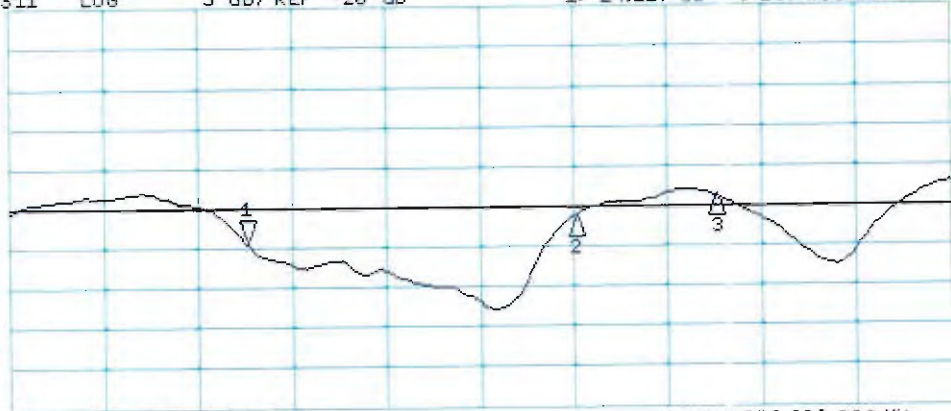

CH2 Markers  
2:-21.221 dB  
5.60000 GHz  
3:-18.815 dB  
5.75000 GHz



Accredited by the Swiss Accreditation Service (SAS)  
The Swiss Accreditation Service is one of the signatories to the EA  
Multilateral Agreement for the recognition of calibration certificates

Accreditation No.: **SCS 0108**

Client **Sporton - ICC (Auden)**

Certificate No: **DAE4-1424\_Feb17**

## CALIBRATION CERTIFICATE

Object **DAE4 - SD 000 D04 BM - SN: 1424**

Calibration procedure(s) **QA CAL-06.v29**  
**Calibration procedure for the data acquisition electronics (DAE)**

Calibration date: **February 16, 2017**

This calibration certificate documents the traceability to national standards, which realize the physical units of measurements (SI).  
The measurements and the uncertainties with confidence probability are given on the following pages and are part of the certificate.

All calibrations have been conducted in the closed laboratory facility: environment temperature ( $22 \pm 3$ )°C and humidity < 70%.

Calibration Equipment used (M&TE critical for calibration)

Primary Standards	ID #	Cal Date (Certificate No.)	Scheduled Calibration
Keithley Multimeter Type 2001	SN: 0810278	09-Sep-16 (No:19065)	Sep-17
Secondary Standards	ID #	Check Date (in house)	Scheduled Check
Auto DAE Calibration Unit	SE UWS 053 AA 1001	05-Jan-17 (in house check)	In house check: Jan-18
Calibrator Box V2.1	SE UMS 006 AA 1002	05-Jan-17 (in house check)	In house check: Jan-18

Calibrated by:	Name Adrian Gehring	Function Technician	Signature 
Approved by:	Fin Bornholt	Deputy Technical Manager	

Issued: February 16, 2017

This calibration certificate shall not be reproduced except in full without written approval of the laboratory.



Accredited by the Swiss Accreditation Service (SAS)  
The Swiss Accreditation Service is one of the signatories to the EA  
Multilateral Agreement for the recognition of calibration certificates

## Glossary

DAE data acquisition electronics  
Connector angle information used in DASY system to align probe sensor X to the robot coordinate system.

## Methods Applied and Interpretation of Parameters

- *DC Voltage Measurement:* Calibration Factor assessed for use in DASY system by comparison with a calibrated instrument traceable to national standards. The figure given corresponds to the full scale range of the voltmeter in the respective range.
- *Connector angle:* The angle of the connector is assessed measuring the angle mechanically by a tool inserted. Uncertainty is not required.
- The following parameters as documented in the Appendix contain technical information as a result from the performance test and require no uncertainty.
  - *DC Voltage Measurement Linearity:* Verification of the Linearity at +10% and -10% of the nominal calibration voltage. Influence of offset voltage is included in this measurement.
  - *Common mode sensitivity:* Influence of a positive or negative common mode voltage on the differential measurement.
  - *Channel separation:* Influence of a voltage on the neighbor channels not subject to an input voltage.
  - *AD Converter Values with inputs shorted:* Values on the internal AD converter corresponding to zero input voltage
  - *Input Offset Measurement:* Output voltage and statistical results over a large number of zero voltage measurements.
  - *Input Offset Current:* Typical value for information; Maximum channel input offset current, not considering the input resistance.
  - *Input resistance:* Typical value for information: DAE input resistance at the connector, during internal auto-zeroing and during measurement.
  - *Low Battery Alarm Voltage:* Typical value for information. Below this voltage, a battery alarm signal is generated.
  - *Power consumption:* Typical value for information. Supply currents in various operating modes.

## DC Voltage Measurement

A/D - Converter Resolution nominal

High Range: 1LSB = 6.1 $\mu$ V, full range = -100...+300 mV

Low Range: 1LSB = 61nV, full range = -1.....+3mV

DASY measurement parameters: Auto Zero Time: 3 sec; Measuring time: 3 sec

Calibration Factors	X	Y	Z
High Range	403.134 $\pm$ 0.02% (k=2)	403.619 $\pm$ 0.02% (k=2)	403.192 $\pm$ 0.02% (k=2)
Low Range	3.96929 $\pm$ 1.50% (k=2)	3.99683 $\pm$ 1.50% (k=2)	3.98424 $\pm$ 1.50% (k=2)

## Connector Angle

Connector Angle to be used in DASY system	358.0 $\pm$ 1 $^{\circ}$
---	--------------------------

## Appendix (Additional assessments outside the scope of SCS0108)

### 1. DC Voltage Linearity

High Range		Reading ( $\mu\text{V}$ )	Difference ( $\mu\text{V}$ )	Error (%)
Channel X	+ Input	200030.67	-2.60	-0.00
Channel X	+ Input	20005.85	1.13	0.01
Channel X	- Input	-20002.78	2.30	-0.01
Channel Y	+ Input	200031.94	-1.24	-0.00
Channel Y	+ Input	20003.46	-1.30	-0.01
Channel Y	- Input	-20006.16	-1.09	0.01
Channel Z	+ Input	200032.25	-1.01	-0.00
Channel Z	+ Input	20004.24	-0.48	-0.00
Channel Z	- Input	-20006.86	-1.71	0.01

Low Range		Reading ( $\mu\text{V}$ )	Difference ( $\mu\text{V}$ )	Error (%)
Channel X	+ Input	2001.70	0.52	0.03
Channel X	+ Input	201.06	-0.00	-0.00
Channel X	- Input	-198.66	0.27	-0.13
Channel Y	+ Input	2001.37	0.26	0.01
Channel Y	+ Input	199.96	-1.04	-0.52
Channel Y	- Input	-199.87	-0.90	0.45
Channel Z	+ Input	2000.87	-0.15	-0.01
Channel Z	+ Input	199.84	-1.10	-0.55
Channel Z	- Input	-200.34	-1.29	0.65

### 2. Common mode sensitivity

DASY measurement parameters: Auto Zero Time: 3 sec; Measuring time: 3 sec

	Common mode Input Voltage (mV)	High Range Average Reading ( $\mu\text{V}$ )	Low Range Average Reading ( $\mu\text{V}$ )
Channel X	200	-0.52	-2.04
	- 200	2.53	1.37
Channel Y	200	-13.45	-13.66
	- 200	11.80	11.67
Channel Z	200	-9.10	-8.91
	- 200	6.53	6.23

### 3. Channel separation

DASY measurement parameters: Auto Zero Time: 3 sec; Measuring time: 3 sec

	Input Voltage (mV)	Channel X ( $\mu\text{V}$ )	Channel Y ( $\mu\text{V}$ )	Channel Z ( $\mu\text{V}$ )
Channel X	200	-	2.89	-3.75
Channel Y	200	8.71	-	4.32
Channel Z	200	9.71	6.36	-



#### 4. AD-Converter Values with inputs shorted

DASY measurement parameters: Auto Zero Time: 3 sec; Measuring time: 3 sec

	High Range (LSB)	Low Range (LSB)
Channel X	15953	15468
Channel Y	15877	15900
Channel Z	15869	13329

#### 5. Input Offset Measurement

DASY measurement parameters: Auto Zero Time: 3 sec; Measuring time: 3 sec

Input 10M $\Omega$

	Average ( $\mu$ V)	min. Offset ( $\mu$ V)	max. Offset ( $\mu$ V)	Std. Deviation ( $\mu$ V)
Channel X	0.70	-0.82	2.12	0.47
Channel Y	-0.67	-2.05	0.88	0.54
Channel Z	-1.55	-2.34	-0.03	0.37

#### 6. Input Offset Current

Nominal Input circuitry offset current on all channels: <25fA

#### 7. Input Resistance (Typical values for information)

	Zeroing (kOhm)	Measuring (MOhm)
Channel X	200	200
Channel Y	200	200
Channel Z	200	200

#### 8. Low Battery Alarm Voltage (Typical values for information)

Typical values	Alarm Level (VDC)
Supply (+ Vcc)	+7.9
Supply (- Vcc)	-7.6

#### 9. Power Consumption (Typical values for information)

Typical values	Switched off (mA)	Stand by (mA)	Transmitting (mA)
Supply (+ Vcc)	+0.01	+6	+14
Supply (- Vcc)	-0.01	-8	-9



Accredited by the Swiss Accreditation Service (SAS)  
The Swiss Accreditation Service is one of the signatories to the EA  
Multilateral Agreement for the recognition of calibration certificates

Accreditation No.: **SCS 0108**

Client **Sporton - TW (Auden)**

Certificate No: **DAE3-495\_May16**

## CALIBRATION CERTIFICATE

Object **DAE3 - SD 000 D03 AD - SN: 495**

Calibration procedure(s) **QA CAL-06.v29  
Calibration procedure for the data acquisition electronics (DAE)**

Calibration date: **May 27, 2016**

This calibration certificate documents the traceability to national standards, which realize the physical units of measurements (SI).  
The measurements and the uncertainties with confidence probability are given on the following pages and are part of the certificate.

All calibrations have been conducted in the closed laboratory facility: environment temperature ( $22 \pm 3$ )°C and humidity < 70%.

Calibration Equipment used (M&TE critical for calibration)

Primary Standards	ID #	Cal Date (Certificate No.)	Scheduled Calibration
Keithley Multimeter Type 2001	SN: 0810278	09-Sep-15 (No:17153)	Sep-16
Secondary Standards	ID #	Check Date (in house)	Scheduled Check
Auto DAE Calibration Unit	SE UWS 053 AA 1001	05-Jan-16 (in house check)	In house check: Jan-17
Calibrator Box V2.1	SE UMS 006 AA 1002	05-Jan-16 (in house check)	In house check: Jan-17

Calibrated by:	Name R.Mayoraz	Function Technician	Signature 
Approved by:	Fin Bomholt	Deputy Technical Manager	

Issued: May 27, 2016

This calibration certificate shall not be reproduced except in full without written approval of the laboratory.



Accredited by the Swiss Accreditation Service (SAS)

The Swiss Accreditation Service is one of the signatories to the EA Multilateral Agreement for the recognition of calibration certificates

Accreditation No.: **SCS 0108**

## Glossary

DAE data acquisition electronics  
Connector angle information used in DASY system to align probe sensor X to the robot coordinate system.

## Methods Applied and Interpretation of Parameters

- *DC Voltage Measurement:* Calibration Factor assessed for use in DASY system by comparison with a calibrated instrument traceable to national standards. The figure given corresponds to the full scale range of the voltmeter in the respective range.
- *Connector angle:* The angle of the connector is assessed measuring the angle mechanically by a tool inserted. Uncertainty is not required.
- The following parameters as documented in the Appendix contain technical information as a result from the performance test and require no uncertainty.
  - *DC Voltage Measurement Linearity:* Verification of the Linearity at +10% and -10% of the nominal calibration voltage. Influence of offset voltage is included in this measurement.
  - *Common mode sensitivity:* Influence of a positive or negative common mode voltage on the differential measurement.
  - *Channel separation:* Influence of a voltage on the neighbor channels not subject to an input voltage.
  - *AD Converter Values with inputs shorted:* Values on the internal AD converter corresponding to zero input voltage
  - *Input Offset Measurement:* Output voltage and statistical results over a large number of zero voltage measurements.
  - *Input Offset Current:* Typical value for information; Maximum channel input offset current, not considering the input resistance.
  - *Input resistance:* Typical value for information: DAE input resistance at the connector, during internal auto-zeroing and during measurement.
  - *Low Battery Alarm Voltage:* Typical value for information. Below this voltage, a battery alarm signal is generated.
  - *Power consumption:* Typical value for information. Supply currents in various operating modes.

## DC Voltage Measurement

A/D - Converter Resolution nominal

High Range: 1LSB = 6.1 $\mu$ V, full range = -100...+300 mV

Low Range: 1LSB = 61nV, full range = -1.....+3mV

DASY measurement parameters: Auto Zero Time: 3 sec; Measuring time: 3 sec

Calibration Factors	X	Y	Z
High Range	404.392 $\pm$ 0.02% (k=2)	405.369 $\pm$ 0.02% (k=2)	405.725 $\pm$ 0.02% (k=2)
Low Range	3.95295 $\pm$ 1.50% (k=2)	3.99096 $\pm$ 1.50% (k=2)	3.96580 $\pm$ 1.50% (k=2)

## Connector Angle

Connector Angle to be used in DASY system	78.0 $^{\circ}$ $\pm$ 1 $^{\circ}$
---	------------------------------------

## Appendix (Additional assessments outside the scope of SCS0108)

### 1. DC Voltage Linearity

High Range		Reading ( $\mu\text{V}$ )	Difference ( $\mu\text{V}$ )	Error (%)
Channel X	+ Input	199996.62	1.58	0.00
Channel X	+ Input	20000.74	-0.12	-0.00
Channel X	- Input	-19996.44	4.68	-0.02
Channel Y	+ Input	199995.94	1.53	0.00
Channel Y	+ Input	20002.54	1.56	0.01
Channel Y	- Input	-19999.75	1.29	-0.01
Channel Z	+ Input	199992.83	-1.82	-0.00
Channel Z	+ Input	20002.61	1.74	0.01
Channel Z	- Input	-19998.46	2.69	-0.01

Low Range		Reading ( $\mu\text{V}$ )	Difference ( $\mu\text{V}$ )	Error (%)
Channel X	+ Input	2001.48	0.75	0.04
Channel X	+ Input	201.55	0.46	0.23
Channel X	- Input	-198.32	0.30	-0.15
Channel Y	+ Input	2000.13	-0.57	-0.03
Channel Y	+ Input	200.91	-0.45	-0.22
Channel Y	- Input	-199.30	-0.77	0.39
Channel Z	+ Input	1999.63	-0.96	-0.05
Channel Z	+ Input	200.82	-0.44	-0.22
Channel Z	- Input	-199.88	-1.27	0.64

### 2. Common mode sensitivity

DASY measurement parameters: Auto Zero Time: 3 sec; Measuring time: 3 sec

	Common mode Input Voltage (mV)	High Range Average Reading ( $\mu\text{V}$ )	Low Range Average Reading ( $\mu\text{V}$ )
Channel X	200	3.18	2.27
	- 200	-2.19	-3.80
Channel Y	200	0.69	0.05
	- 200	-0.39	-0.92
Channel Z	200	2.28	2.22
	- 200	-4.44	-4.68

### 3. Channel separation

DASY measurement parameters: Auto Zero Time: 3 sec; Measuring time: 3 sec

	Input Voltage (mV)	Channel X ( $\mu\text{V}$ )	Channel Y ( $\mu\text{V}$ )	Channel Z ( $\mu\text{V}$ )
Channel X	200	-	-0.76	-2.16
Channel Y	200	7.44	-	-0.52
Channel Z	200	5.77	5.68	-

#### 4. AD-Converter Values with inputs shorted

DASY measurement parameters: Auto Zero Time: 3 sec; Measuring time: 3 sec

	High Range (LSB)	Low Range (LSB)
Channel X	15817	17431
Channel Y	15765	17509
Channel Z	15903	17029

#### 5. Input Offset Measurement

DASY measurement parameters: Auto Zero Time: 3 sec; Measuring time: 3 sec

Input 10M $\Omega$

	Average ( $\mu$ V)	min. Offset ( $\mu$ V)	max. Offset ( $\mu$ V)	Std. Deviation ( $\mu$ V)
Channel X	-0.15	-1.92	1.72	0.56
Channel Y	0.33	-0.86	2.13	0.60
Channel Z	-1.62	-2.91	-0.07	0.62

#### 6. Input Offset Current

Nominal Input circuitry offset current on all channels: <25fA

#### 7. Input Resistance (Typical values for information)

	Zeroing (kOhm)	Measuring (MOhm)
Channel X	200	200
Channel Y	200	200
Channel Z	200	200

#### 8. Low Battery Alarm Voltage (Typical values for information)

Typical values	Alarm Level (VDC)
Supply (+ Vcc)	+7.9
Supply (- Vcc)	-7.6

#### 9. Power Consumption (Typical values for information)

Typical values	Switched off (mA)	Stand by (mA)	Transmitting (mA)
Supply (+ Vcc)	+0.01	+6	+14
Supply (- Vcc)	-0.01	-8	-9



Accredited by the Swiss Accreditation Service (SAS)  
The Swiss Accreditation Service is one of the signatories to the EA  
Multilateral Agreement for the recognition of calibration certificates

Accreditation No.: **SCS 0108**

Client **Sporton-TW (Auden)**

Certificate No: **DAE4-1399\_Nov16**

## CALIBRATION CERTIFICATE

Object **DAE4 - SD 000 D04 BM - SN: 1399**

Calibration procedure(s) **QA CAL-06.v29**  
**Calibration procedure for the data acquisition electronics (DAE)**

Calibration date: **November 17, 2016**

This calibration certificate documents the traceability to national standards, which realize the physical units of measurements (SI).  
The measurements and the uncertainties with confidence probability are given on the following pages and are part of the certificate.

All calibrations have been conducted in the closed laboratory facility: environment temperature ( $22 \pm 3$ )°C and humidity < 70%.

Calibration Equipment used (M&TE critical for calibration)

Primary Standards	ID #	Cal Date (Certificate No.)	Scheduled Calibration
Keithley Multimeter Type 2001	SN: 0810278	09-Sep-16 (No:19065)	Sep-17
Secondary Standards	ID #	Check Date (in house)	Scheduled Check
Auto DAE Calibration Unit	SE UWS 053 AA 1001	05-Jan-16 (in house check)	In house check: Jan-17
Calibrator Box V2.1	SE UMS 006 AA 1002	05-Jan-16 (in house check)	In house check: Jan-17

	Name	Function	Signature
Calibrated by:	Dominique Steffen	Technician	
Approved by:	Fin Bomholt	Deputy Technical Manager	

Issued: November 17, 2016

This calibration certificate shall not be reproduced except in full without written approval of the laboratory.



Accredited by the Swiss Accreditation Service (SAS)  
The Swiss Accreditation Service is one of the signatories to the EA  
Multilateral Agreement for the recognition of calibration certificates

## Glossary

DAE data acquisition electronics  
Connector angle information used in DASY system to align probe sensor X to the robot coordinate system.

## Methods Applied and Interpretation of Parameters

- *DC Voltage Measurement:* Calibration Factor assessed for use in DASY system by comparison with a calibrated instrument traceable to national standards. The figure given corresponds to the full scale range of the voltmeter in the respective range.
- *Connector angle:* The angle of the connector is assessed measuring the angle mechanically by a tool inserted. Uncertainty is not required.
- The following parameters as documented in the Appendix contain technical information as a result from the performance test and require no uncertainty.
  - *DC Voltage Measurement Linearity:* Verification of the Linearity at +10% and -10% of the nominal calibration voltage. Influence of offset voltage is included in this measurement.
  - *Common mode sensitivity:* Influence of a positive or negative common mode voltage on the differential measurement.
  - *Channel separation:* Influence of a voltage on the neighbor channels not subject to an input voltage.
  - *AD Converter Values with inputs shorted:* Values on the internal AD converter corresponding to zero input voltage
  - *Input Offset Measurement:* Output voltage and statistical results over a large number of zero voltage measurements.
  - *Input Offset Current:* Typical value for information; Maximum channel input offset current, not considering the input resistance.
  - *Input resistance:* Typical value for information: DAE input resistance at the connector, during internal auto-zeroing and during measurement.
  - *Low Battery Alarm Voltage:* Typical value for information. Below this voltage, a battery alarm signal is generated.
  - *Power consumption:* Typical value for information. Supply currents in various operating modes.



## DC Voltage Measurement

A/D - Converter Resolution nominal

High Range: 1LSB = 6.1 $\mu$ V, full range = -100...+300 mV

Low Range: 1LSB = 61nV, full range = -1.....+3mV

DASY measurement parameters: Auto Zero Time: 3 sec; Measuring time: 3 sec

Calibration Factors	X	Y	Z
High Range	403.601 $\pm$ 0.02% (k=2)	403.860 $\pm$ 0.02% (k=2)	403.715 $\pm$ 0.02% (k=2)
Low Range	3.98192 $\pm$ 1.50% (k=2)	3.99210 $\pm$ 1.50% (k=2)	3.98028 $\pm$ 1.50% (k=2)

## Connector Angle

Connector Angle to be used in DASY system	302.5 $^{\circ}$ $\pm$ 1 $^{\circ}$
---	-------------------------------------

## Appendix (Additional assessments outside the scope of SCS0108)

### 1. DC Voltage Linearity

High Range	Reading ( $\mu\text{V}$ )	Difference ( $\mu\text{V}$ )	Error (%)
Channel X + Input	199995.88	1.05	0.00
Channel X + Input	20002.28	0.87	0.00
Channel X - Input	-19998.50	2.29	-0.01
Channel Y + Input	199993.59	-1.44	-0.00
Channel Y + Input	20000.11	-1.26	-0.01
Channel Y - Input	-20001.82	-0.91	0.00
Channel Z + Input	199995.29	-0.07	-0.00
Channel Z + Input	19998.72	-2.63	-0.01
Channel Z - Input	-20002.93	-1.99	0.01

Low Range	Reading ( $\mu\text{V}$ )	Difference ( $\mu\text{V}$ )	Error (%)
Channel X + Input	2001.09	-0.18	-0.01
Channel X + Input	201.99	0.26	0.13
Channel X - Input	-197.66	0.46	-0.23
Channel Y + Input	2001.13	-0.06	-0.00
Channel Y + Input	200.58	-0.99	-0.49
Channel Y - Input	-198.74	-0.44	0.22
Channel Z + Input	2001.38	0.15	0.01
Channel Z + Input	200.84	-0.68	-0.34
Channel Z - Input	-199.07	-0.83	0.42

### 2. Common mode sensitivity

DASY measurement parameters: Auto Zero Time: 3 sec; Measuring time: 3 sec

	Common mode Input Voltage (mV)	High Range Average Reading ( $\mu\text{V}$ )	Low Range Average Reading ( $\mu\text{V}$ )
Channel X	200	-4.94	-6.62
	- 200	8.38	6.51
Channel Y	200	-6.22	-6.54
	- 200	5.04	4.27
Channel Z	200	-6.68	-6.74
	- 200	4.86	5.05

### 3. Channel separation

DASY measurement parameters: Auto Zero Time: 3 sec; Measuring time: 3 sec

	Input Voltage (mV)	Channel X ( $\mu\text{V}$ )	Channel Y ( $\mu\text{V}$ )	Channel Z ( $\mu\text{V}$ )
Channel X	200	-	4.65	-1.72
Channel Y	200	9.38	-	6.88
Channel Z	200	8.80	6.72	-

#### 4. AD-Converter Values with inputs shorted

DASY measurement parameters: Auto Zero Time: 3 sec; Measuring time: 3 sec

	High Range (LSB)	Low Range (LSB)
Channel X	15826	16053
Channel Y	16118	16526
Channel Z	15887	15918

#### 5. Input Offset Measurement

DASY measurement parameters: Auto Zero Time: 3 sec; Measuring time: 3 sec

Input 10M $\Omega$

	Average ( $\mu$ V)	min. Offset ( $\mu$ V)	max. Offset ( $\mu$ V)	Std. Deviation ( $\mu$ V)
Channel X	0.11	-0.73	0.73	0.27
Channel Y	-0.19	-1.32	1.76	0.44
Channel Z	-0.78	-2.06	0.51	0.41

#### 6. Input Offset Current

Nominal Input circuitry offset current on all channels: <25fA

#### 7. Input Resistance (Typical values for information)

	Zeroing (kOhm)	Measuring (MOhm)
Channel X	200	200
Channel Y	200	200
Channel Z	200	200

#### 8. Low Battery Alarm Voltage (Typical values for information)

Typical values	Alarm Level (VDC)
Supply (+ Vcc)	+7.9
Supply (- Vcc)	-7.6

#### 9. Power Consumption (Typical values for information)

Typical values	Switched off (mA)	Stand by (mA)	Transmitting (mA)
Supply (+ Vcc)	+0.01	+6	+14
Supply (- Vcc)	-0.01	-8	-9



Accredited by the Swiss Accreditation Service (SAS)  
The Swiss Accreditation Service is one of the signatories to the EA  
Multilateral Agreement for the recognition of calibration certificates

Accreditation No.: **SCS 0108**

Client **Sporton - TW (Auden)**

Certificate No: **DAE4-778\_May16**

## CALIBRATION CERTIFICATE

Object **DAE4 - SD 000 D04 BM - SN: 778**

Calibration procedure(s) **QA CAL-06.v29  
Calibration procedure for the data acquisition electronics (DAE)**

Calibration date: **May 12, 2016**

This calibration certificate documents the traceability to national standards, which realize the physical units of measurements (SI).  
The measurements and the uncertainties with confidence probability are given on the following pages and are part of the certificate.

All calibrations have been conducted in the closed laboratory facility: environment temperature (22 ± 3)°C and humidity < 70%.

Calibration Equipment used (M&TE critical for calibration)

Primary Standards	ID #	Cal Date (Certificate No.)	Scheduled Calibration
Keithley Multimeter Type 2001	SN: 0810278	09-Sep-15 (No:17153)	Sep-16
Secondary Standards	ID #	Check Date (in house)	Scheduled Check
Auto DAE Calibration Unit	SE UWS 053 AA 1001	05-Jan-16 (in house check)	In house check: Jan-17
Calibrator Box V2.1	SE UMS 006 AA 1002	05-Jan-16 (in house check)	In house check: Jan-17

Calibrated by:	Name Dominique Steffen	Function Technician	Signature 
Approved by:	Fin Bomholt	Deputy Technical Manager	

Issued: May 12, 2016

This calibration certificate shall not be reproduced except in full without written approval of the laboratory.



Accredited by the Swiss Accreditation Service (SAS)  
The Swiss Accreditation Service is one of the signatories to the EA  
Multilateral Agreement for the recognition of calibration certificates

Accreditation No.: **SCS 0108**

## Glossary

DAE data acquisition electronics  
Connector angle information used in DASY system to align probe sensor X to the robot coordinate system.

## Methods Applied and Interpretation of Parameters

- *DC Voltage Measurement:* Calibration Factor assessed for use in DASY system by comparison with a calibrated instrument traceable to national standards. The figure given corresponds to the full scale range of the voltmeter in the respective range.
- *Connector angle:* The angle of the connector is assessed measuring the angle mechanically by a tool inserted. Uncertainty is not required.
- The following parameters as documented in the Appendix contain technical information as a result from the performance test and require no uncertainty.
  - *DC Voltage Measurement Linearity:* Verification of the Linearity at +10% and -10% of the nominal calibration voltage. Influence of offset voltage is included in this measurement.
  - *Common mode sensitivity:* Influence of a positive or negative common mode voltage on the differential measurement.
  - *Channel separation:* Influence of a voltage on the neighbor channels not subject to an input voltage.
  - *AD Converter Values with inputs shorted:* Values on the internal AD converter corresponding to zero input voltage
  - *Input Offset Measurement:* Output voltage and statistical results over a large number of zero voltage measurements.
  - *Input Offset Current:* Typical value for information; Maximum channel input offset current, not considering the input resistance.
  - *Input resistance:* Typical value for information: DAE input resistance at the connector, during internal auto-zeroing and during measurement.
  - *Low Battery Alarm Voltage:* Typical value for information. Below this voltage, a battery alarm signal is generated.
  - *Power consumption:* Typical value for information. Supply currents in various operating modes.

## DC Voltage Measurement

A/D - Converter Resolution nominal

High Range: 1LSB = 6.1 $\mu$ V, full range = -100...+300 mV

Low Range: 1LSB = 61nV, full range = -1.....+3mV

DASY measurement parameters: Auto Zero Time: 3 sec; Measuring time: 3 sec

Calibration Factors	X	Y	Z
High Range	404.712 $\pm$ 0.02% (k=2)	403.516 $\pm$ 0.02% (k=2)	405.068 $\pm$ 0.02% (k=2)
Low Range	3.98678 $\pm$ 1.50% (k=2)	3.96495 $\pm$ 1.50% (k=2)	4.00091 $\pm$ 1.50% (k=2)

## Connector Angle

Connector Angle to be used in DASY system	270.0 $\pm$ 1 $^{\circ}$
---	--------------------------

## Appendix (Additional assessments outside the scope of SCS0108)

### 1. DC Voltage Linearity

High Range	Reading ( $\mu\text{V}$ )	Difference ( $\mu\text{V}$ )	Error (%)
Channel X + Input	200032.14	-1.38	-0.00
Channel X + Input	20005.68	0.79	0.00
Channel X - Input	-20003.61	1.31	-0.01
Channel Y + Input	200030.28	-3.73	-0.00
Channel Y + Input	20006.01	1.25	0.01
Channel Y - Input	-20003.00	1.89	-0.01
Channel Z + Input	200035.46	1.52	0.00
Channel Z + Input	20002.36	-2.31	-0.01
Channel Z - Input	-20008.31	-3.27	0.02

Low Range	Reading ( $\mu\text{V}$ )	Difference ( $\mu\text{V}$ )	Error (%)
Channel X + Input	2001.27	0.01	0.00
Channel X + Input	201.37	0.21	0.10
Channel X - Input	-198.61	-0.02	0.01
Channel Y + Input	2001.38	0.24	0.01
Channel Y + Input	200.13	-0.97	-0.48
Channel Y - Input	-198.84	-0.10	0.05
Channel Z + Input	2001.29	0.21	0.01
Channel Z + Input	200.34	-0.69	-0.34
Channel Z - Input	-200.58	-1.74	0.88

### 2. Common mode sensitivity

DASY measurement parameters: Auto Zero Time: 3 sec; Measuring time: 3 sec

	Common mode Input Voltage (mV)	High Range Average Reading ( $\mu\text{V}$ )	Low Range Average Reading ( $\mu\text{V}$ )
Channel X	200	-4.35	-5.61
	- 200	7.07	5.78
Channel Y	200	-1.79	-1.82
	- 200	0.49	0.20
Channel Z	200	-12.55	-12.56
	- 200	10.17	10.19

### 3. Channel separation

DASY measurement parameters: Auto Zero Time: 3 sec; Measuring time: 3 sec

	Input Voltage (mV)	Channel X ( $\mu\text{V}$ )	Channel Y ( $\mu\text{V}$ )	Channel Z ( $\mu\text{V}$ )
Channel X	200	-	-0.66	-2.54
Channel Y	200	8.70	-	-0.26
Channel Z	200	3.71	7.16	-

#### 4. AD-Converter Values with inputs shorted

DASY measurement parameters: Auto Zero Time: 3 sec; Measuring time: 3 sec

	High Range (LSB)	Low Range (LSB)
Channel X	16054	16869
Channel Y	16191	17846
Channel Z	16441	16314

#### 5. Input Offset Measurement

DASY measurement parameters: Auto Zero Time: 3 sec; Measuring time: 3 sec

Input 10M $\Omega$

	Average ( $\mu$ V)	min. Offset ( $\mu$ V)	max. Offset ( $\mu$ V)	Std. Deviation ( $\mu$ V)
Channel X	0.48	-0.60	1.44	0.42
Channel Y	-0.09	-1.42	2.50	0.58
Channel Z	-1.11	-2.45	-0.19	0.45

#### 6. Input Offset Current

Nominal Input circuitry offset current on all channels: <25fA

#### 7. Input Resistance (Typical values for information)

	Zeroing (kOhm)	Measuring (MOhm)
Channel X	200	200
Channel Y	200	200
Channel Z	200	200

#### 8. Low Battery Alarm Voltage (Typical values for information)

Typical values	Alarm Level (VDC)
Supply (+ Vcc)	+7.9
Supply (- Vcc)	-7.6

#### 9. Power Consumption (Typical values for information)

Typical values	Switched off (mA)	Stand by (mA)	Transmitting (mA)
Supply (+ Vcc)	+0.01	+6	+14
Supply (- Vcc)	-0.01	-8	-9





Accredited by the Swiss Accreditation Service (SAS)  
The Swiss Accreditation Service is one of the signatories to the EA  
Multilateral Agreement for the recognition of calibration certificates

Accreditation No.: **SCS 0108**

Client **Sporton - TW (Auden)**

Certificate No: **DAE3-577\_Sep16**

## CALIBRATION CERTIFICATE

Object **DAE3 - SD 000 D03 AA - SN: 577**

Calibration procedure(s) **QA CAL-06.v29  
Calibration procedure for the data acquisition electronics (DAE)**

Calibration date: **September 28, 2016**

This calibration certificate documents the traceability to national standards, which realize the physical units of measurements (SI).  
The measurements and the uncertainties with confidence probability are given on the following pages and are part of the certificate.

All calibrations have been conducted in the closed laboratory facility: environment temperature ( $22 \pm 3$ )°C and humidity < 70%.

Calibration Equipment used (M&TE critical for calibration)

Primary Standards	ID #	Cal Date (Certificate No.)	Scheduled Calibration
Keithley Multimeter Type 2001	SN: 0810278	09-Sep-16 (No:19065)	Sep-17
Secondary Standards	ID #	Check Date (in house)	Scheduled Check
Auto DAE Calibration Unit	SE UWS 053 AA 1001	05-Jan-16 (in house check)	In house check: Jan-17
Calibrator Box V2.1	SE UMS 006 AA 1002	05-Jan-16 (in house check)	In house check: Jan-17

Calibrated by: **Name** Eric Hainfeld **Function** Technician

Signature

Approved by: **Name** Fin Bomholt **Function** Deputy Technical Manager

Issued: September 28, 2016

This calibration certificate shall not be reproduced except in full without written approval of the laboratory.



Accredited by the Swiss Accreditation Service (SAS)

The Swiss Accreditation Service is one of the signatories to the EA  
Multilateral Agreement for the recognition of calibration certificates

Accreditation No.: **SCS 0108**

## Glossary

DAE	data acquisition electronics
Connector angle	information used in DASY system to align probe sensor X to the robot coordinate system.

## Methods Applied and Interpretation of Parameters

- *DC Voltage Measurement:* Calibration Factor assessed for use in DASY system by comparison with a calibrated instrument traceable to national standards. The figure given corresponds to the full scale range of the voltmeter in the respective range.
- *Connector angle:* The angle of the connector is assessed measuring the angle mechanically by a tool inserted. Uncertainty is not required.
- The following parameters as documented in the Appendix contain technical information as a result from the performance test and require no uncertainty.
  - *DC Voltage Measurement Linearity:* Verification of the Linearity at +10% and -10% of the nominal calibration voltage. Influence of offset voltage is included in this measurement.
  - *Common mode sensitivity:* Influence of a positive or negative common mode voltage on the differential measurement.
  - *Channel separation:* Influence of a voltage on the neighbor channels not subject to an input voltage.
  - *AD Converter Values with inputs shorted:* Values on the internal AD converter corresponding to zero input voltage
  - *Input Offset Measurement:* Output voltage and statistical results over a large number of zero voltage measurements.
  - *Input Offset Current:* Typical value for information; Maximum channel input offset current, not considering the input resistance.
  - *Input resistance:* Typical value for information: DAE input resistance at the connector, during internal auto-zeroing and during measurement.
  - *Low Battery Alarm Voltage:* Typical value for information. Below this voltage, a battery alarm signal is generated.
  - *Power consumption:* Typical value for information. Supply currents in various operating modes.

## DC Voltage Measurement

A/D - Converter Resolution nominal

High Range: 1LSB = 6.1 $\mu$ V, full range = -100...+300 mV

Low Range: 1LSB = 61nV, full range = -1.....+3mV

DASY measurement parameters: Auto Zero Time: 3 sec; Measuring time: 3 sec

Calibration Factors	X	Y	Z
High Range	403.533 $\pm$ 0.02% (k=2)	403.512 $\pm$ 0.02% (k=2)	403.819 $\pm$ 0.02% (k=2)
Low Range	3.92648 $\pm$ 1.50% (k=2)	3.94206 $\pm$ 1.50% (k=2)	3.96074 $\pm$ 1.50% (k=2)

## Connector Angle

Connector Angle to be used in DASY system	190.0 $^{\circ}$ $\pm$ 1 $^{\circ}$
---	-------------------------------------

## Appendix (Additional assessments outside the scope of SCS0108)

### 1. DC Voltage Linearity

High Range		Reading ( $\mu\text{V}$ )	Difference ( $\mu\text{V}$ )	Error (%)
Channel X	+ Input	200038.14	2.56	0.00
Channel X	+ Input	20010.51	5.45	0.03
Channel X	- Input	-20002.01	3.17	-0.02
Channel Y	+ Input	200032.33	-3.18	-0.00
Channel Y	+ Input	20006.38	1.35	0.01
Channel Y	- Input	-20004.73	0.65	-0.00
Channel Z	+ Input	200031.49	-4.11	-0.00
Channel Z	+ Input	20005.92	0.98	0.00
Channel Z	- Input	-20007.03	-1.64	0.01

Low Range		Reading ( $\mu\text{V}$ )	Difference ( $\mu\text{V}$ )	Error (%)
Channel X	+ Input	2001.00	-0.10	-0.01
Channel X	+ Input	201.47	0.40	0.20
Channel X	- Input	-198.57	0.28	-0.14
Channel Y	+ Input	2001.38	0.31	0.02
Channel Y	+ Input	200.40	-0.54	-0.27
Channel Y	- Input	-199.63	-0.73	0.37
Channel Z	+ Input	2000.35	-0.56	-0.03
Channel Z	+ Input	199.97	-0.93	-0.46
Channel Z	- Input	-200.50	-1.56	0.79

### 2. Common mode sensitivity

DASY measurement parameters: Auto Zero Time: 3 sec; Measuring time: 3 sec

	Common mode Input Voltage (mV)	High Range Average Reading ( $\mu\text{V}$ )	Low Range Average Reading ( $\mu\text{V}$ )
Channel X	200	-2.76	-4.30
	- 200	6.04	3.73
Channel Y	200	-14.29	-14.35
	- 200	12.74	12.77
Channel Z	200	3.10	2.81
	- 200	-5.90	-5.65

### 3. Channel separation

DASY measurement parameters: Auto Zero Time: 3 sec; Measuring time: 3 sec

	Input Voltage (mV)	Channel X ( $\mu\text{V}$ )	Channel Y ( $\mu\text{V}$ )	Channel Z ( $\mu\text{V}$ )
Channel X	200	-	-1.07	-3.44
Channel Y	200	8.43	-	0.12
Channel Z	200	5.44	4.83	-

#### 4. AD-Converter Values with inputs shorted

DASY measurement parameters: Auto Zero Time: 3 sec; Measuring time: 3 sec

	High Range (LSB)	Low Range (LSB)
Channel X	16132	16062
Channel Y	16099	16321
Channel Z	16116	15372

#### 5. Input Offset Measurement

DASY measurement parameters: Auto Zero Time: 3 sec; Measuring time: 3 sec

Input 10M $\Omega$

	Average ( $\mu$ V)	min. Offset ( $\mu$ V)	max. Offset ( $\mu$ V)	Std. Deviation ( $\mu$ V)
Channel X	0.37	-1.07	1.49	0.43
Channel Y	1.21	-0.41	3.21	0.59
Channel Z	-1.38	-2.63	-0.30	0.45

#### 6. Input Offset Current

Nominal Input circuitry offset current on all channels: <25fA

#### 7. Input Resistance (Typical values for information)

	Zeroing (kOhm)	Measuring (MOhm)
Channel X	200	200
Channel Y	200	200
Channel Z	200	200

#### 8. Low Battery Alarm Voltage (Typical values for information)

Typical values	Alarm Level (VDC)
Supply (+ Vcc)	+7.9
Supply (- Vcc)	-7.6

#### 9. Power Consumption (Typical values for information)

Typical values	Switched off (mA)	Stand by (mA)	Transmitting (mA)
Supply (+ Vcc)	+0.01	+6	+14
Supply (- Vcc)	-0.01	-8	-9



Accredited by the Swiss Accreditation Service (SAS)  
The Swiss Accreditation Service is one of the signatories to the EA  
Multilateral Agreement for the recognition of calibration certificates

Accreditation No.: **SCS 0108**

Client **Sporton-ICC (Auden)**

Certificate No: **EX3-3976\_Feb17**

## CALIBRATION CERTIFICATE

Object **EX3DV4 - SN:3976**

Calibration procedure(s) **QA CAL-01.v9, QA CAL-14.v4, QA CAL-23.v5, QA CAL-25.v6  
Calibration procedure for dosimetric E-field probes**

Calibration date: **February 21, 2017**

This calibration certificate documents the traceability to national standards, which realize the physical units of measurements (SI).  
The measurements and the uncertainties with confidence probability are given on the following pages and are part of the certificate.

All calibrations have been conducted in the closed laboratory facility: environment temperature (22 ± 3)°C and humidity < 70%.

Calibration Equipment used (M&TE critical for calibration)

Primary Standards	ID	Cal Date (Certificate No.)	Scheduled Calibration
Power meter NRP	SN: 104778	06-Apr-16 (No. 217-02288/02289)	Apr-17
Power sensor NRP-Z91	SN: 103244	06-Apr-16 (No. 217-02288)	Apr-17
Power sensor NRP-Z91	SN: 103245	06-Apr-16 (No. 217-02289)	Apr-17
Reference 20 dB Attenuator	SN: S5277 (20x)	05-Apr-16 (No. 217-02293)	Apr-17
Reference Probe ES3DV2	SN: 3013	31-Dec-16 (No. ES3-3013_Dec16)	Dec-17
DAE4	SN: 660	7-Dec-16 (No. DAE4-660_Dec16)	Dec-17
Secondary Standards	ID	Check Date (in house)	Scheduled Check
Power meter E4419B	SN: GB41293874	06-Apr-16 (in house check Jun-16)	In house check: Jun-18
Power sensor E4412A	SN: MY41498087	06-Apr-16 (in house check Jun-16)	In house check: Jun-18
Power sensor E4412A	SN: 000110210	06-Apr-16 (in house check Jun-16)	In house check: Jun-18
RF generator HP 8648C	SN: US3642U01700	04-Aug-99 (in house check Jun-16)	In house check: Jun-18
Network Analyzer HP 8753E	SN: US37390585	18-Oct-01 (in house check Oct-16)	In house check: Oct-17

Calibrated by:	Name <b>Claudio Leubler</b>	Function Laboratory Technician	Signature 
Approved by:	<b>Katja Pokovic</b>	Technical Manager	
			Issued: February 27, 2017
This calibration certificate shall not be reproduced except in full without written approval of the laboratory.			



Accredited by the Swiss Accreditation Service (SAS)

Accreditation No.: **SCS 0108**

The Swiss Accreditation Service is one of the signatories to the EA  
Multilateral Agreement for the recognition of calibration certificates

**Glossary:**

TSL	tissue simulating liquid
NORM <sub>x,y,z</sub>	sensitivity in free space
ConvF	sensitivity in TSL / NORM <sub>x,y,z</sub>
DCP	diode compression point
CF	crest factor (1/duty_cycle) of the RF signal
A, B, C, D	modulation dependent linearization parameters
Polarization φ	φ rotation around probe axis
Polarization ϑ	ϑ rotation around an axis that is in the plane normal to probe axis (at measurement center), i.e., ϑ = 0 is normal to probe axis
Connector Angle	information used in DASY system to align probe sensor X to the robot coordinate system

**Calibration is Performed According to the Following Standards:**

- a) IEEE Std 1528-2013, "IEEE Recommended Practice for Determining the Peak Spatial-Averaged Specific Absorption Rate (SAR) in the Human Head from Wireless Communications Devices: Measurement Techniques", June 2013
- b) IEC 62209-1, "Procedure to measure the Specific Absorption Rate (SAR) for hand-held devices used in close proximity to the ear (frequency range of 300 MHz to 3 GHz)", February 2005
- c) IEC 62209-2, "Procedure to determine the Specific Absorption Rate (SAR) for wireless communication devices used in close proximity to the human body (frequency range of 30 MHz to 6 GHz)", March 2010
- d) KDB 865664, "SAR Measurement Requirements for 100 MHz to 6 GHz"

**Methods Applied and Interpretation of Parameters:**

- NORM<sub>x,y,z</sub>: Assessed for E-field polarization ϑ = 0 (f ≤ 900 MHz in TEM-cell; f > 1800 MHz: R22 waveguide). NORM<sub>x,y,z</sub> are only intermediate values, i.e., the uncertainties of NORM<sub>x,y,z</sub> does not affect the E<sup>2</sup>-field uncertainty inside TSL (see below ConvF).
- NORM(f)<sub>x,y,z</sub> = NORM<sub>x,y,z</sub> \* frequency\_response (see Frequency Response Chart). This linearization is implemented in DASY4 software versions later than 4.2. The uncertainty of the frequency response is included in the stated uncertainty of ConvF.
- DCP<sub>x,y,z</sub>: DCP are numerical linearization parameters assessed based on the data of power sweep with CW signal (no uncertainty required). DCP does not depend on frequency nor media.
- PAR: PAR is the Peak to Average Ratio that is not calibrated but determined based on the signal characteristics
- Ax,y,z; Bx,y,z; Cx,y,z; Dx,y,z; VRx,y,z: A, B, C, D are numerical linearization parameters assessed based on the data of power sweep for specific modulation signal. The parameters do not depend on frequency nor media. VR is the maximum calibration range expressed in RMS voltage across the diode.
- ConvF and Boundary Effect Parameters: Assessed in flat phantom using E-field (or Temperature Transfer Standard for f ≤ 800 MHz) and inside waveguide using analytical field distributions based on power measurements for f > 800 MHz. The same setups are used for assessment of the parameters applied for boundary compensation (alpha, depth) of which typical uncertainty values are given. These parameters are used in DASY4 software to improve probe accuracy close to the boundary. The sensitivity in TSL corresponds to NORM<sub>x,y,z</sub> \* ConvF whereby the uncertainty corresponds to that given for ConvF. A frequency dependent ConvF is used in DASY version 4.4 and higher which allows extending the validity from ± 50 MHz to ± 100 MHz.
- Spherical isotropy (3D deviation from isotropy): in a field of low gradients realized using a flat phantom exposed by a patch antenna.
- Sensor Offset: The sensor offset corresponds to the offset of virtual measurement center from the probe tip (on probe axis). No tolerance required.
- Connector Angle: The angle is assessed using the information gained by determining the NORM<sub>x</sub> (no uncertainty required).

# Probe EX3DV4

## SN:3976

Manufactured: November 5, 2013  
Calibrated: February 21, 2017

**Calibrated for DASYS/EASY Systems**  
(Note: non-compatible with DASYS2 system!)



# DASY/EASY - Parameters of Probe: EX3DV4 - SN:3976

## Basic Calibration Parameters

	Sensor X	Sensor Y	Sensor Z	Unc (k=2)
Norm ( $\mu\text{V}/(\text{V}/\text{m})^2$ ) <sup>A</sup>	0.48	0.49	0.54	$\pm 10.1 \%$
DCP (mV) <sup>B</sup>	102.3	101.2	103.1	

## Modulation Calibration Parameters

UID	Communication System Name		A dB	B dB $\sqrt{\mu\text{V}}$	C	D dB	VR mV	Unc <sup>E</sup> (k=2)
0	CW	X	0.0	0.0	1.0	0.00	173.0	$\pm 3.0 \%$
		Y	0.0	0.0	1.0		186.1	
		Z	0.0	0.0	1.0		174.0	

The reported uncertainty of measurement is stated as the standard uncertainty of measurement multiplied by the coverage factor k=2, which for a normal distribution corresponds to a coverage probability of approximately 95%.

<sup>A</sup> The uncertainties of Norm X,Y,Z do not affect the E<sup>2</sup>-field uncertainty inside TSL (see Pages 5 and 6).

<sup>B</sup> Numerical linearization parameter: uncertainty not required.

<sup>E</sup> Uncertainty is determined using the max. deviation from linear response applying rectangular distribution and is expressed for the square of the field value.

## DASY/EASY - Parameters of Probe: EX3DV4 - SN:3976

### Calibration Parameter Determined in Head Tissue Simulating Media

f (MHz) <sup>C</sup>	Relative Permittivity <sup>F</sup>	Conductivity (S/m) <sup>F</sup>	ConvF X	ConvF Y	ConvF Z	Alpha <sup>G</sup>	Depth <sup>G</sup> (mm)	Unc (k=2)
750	41.9	0.89	10.96	10.96	10.96	0.38	0.95	± 12.0 %
835	41.5	0.90	10.43	10.43	10.43	0.46	0.80	± 12.0 %
900	41.5	0.97	10.28	10.28	10.28	0.49	0.80	± 12.0 %
1750	40.1	1.37	8.93	8.93	8.93	0.33	0.80	± 12.0 %
1900	40.0	1.40	8.62	8.62	8.62	0.39	0.80	± 12.0 %
2000	40.0	1.40	8.61	8.61	8.61	0.29	0.80	± 12.0 %
2450	39.2	1.80	7.83	7.83	7.83	0.32	0.88	± 12.0 %
2600	39.0	1.96	7.60	7.60	7.60	0.36	0.87	± 12.0 %
3700	37.7	3.12	7.60	7.60	7.60	0.25	1.20	± 13.1 %
5250	35.9	4.71	5.56	5.56	5.56	0.35	1.80	± 13.1 %
5600	35.5	5.07	4.98	4.98	4.98	0.40	1.80	± 13.1 %
5750	35.4	5.22	5.16	5.16	5.16	0.40	1.80	± 13.1 %

<sup>C</sup> Frequency validity above 300 MHz of ± 100 MHz only applies for DASY v4.4 and higher (see Page 2), else it is restricted to ± 50 MHz. The uncertainty is the RSS of the ConvF uncertainty at calibration frequency and the uncertainty for the indicated frequency band. Frequency validity below 300 MHz is ± 10, 25, 40, 50 and 70 MHz for ConvF assessments at 30, 64, 128, 150 and 220 MHz respectively. Above 5 GHz frequency validity can be extended to ± 110 MHz.

<sup>F</sup> At frequencies below 3 GHz, the validity of tissue parameters ( $\epsilon$  and  $\sigma$ ) can be relaxed to ± 10% if liquid compensation formula is applied to measured SAR values. At frequencies above 3 GHz, the validity of tissue parameters ( $\epsilon$  and  $\sigma$ ) is restricted to ± 5%. The uncertainty is the RSS of the ConvF uncertainty for indicated target tissue parameters.

<sup>G</sup> Alpha/Depth are determined during calibration. SPEAG warrants that the remaining deviation due to the boundary effect after compensation is always less than ± 1% for frequencies below 3 GHz and below ± 2% for frequencies between 3-6 GHz at any distance larger than half the probe tip diameter from the boundary.

## DASY/EASY - Parameters of Probe: EX3DV4 - SN:3976

### Calibration Parameter Determined in Body Tissue Simulating Media

f (MHz) <sup>C</sup>	Relative Permittivity <sup>F</sup>	Conductivity (S/m) <sup>F</sup>	ConvF X	ConvF Y	ConvF Z	Alpha <sup>G</sup>	Depth <sup>G</sup> (mm)	Unc (k=2)
750	55.5	0.96	10.68	10.68	10.68	0.51	0.80	± 12.0 %
835	55.2	0.97	10.41	10.41	10.41	0.48	0.80	± 12.0 %
1750	53.4	1.49	8.57	8.57	8.57	0.37	0.80	± 12.0 %
1900	53.3	1.52	8.31	8.31	8.31	0.41	0.80	± 12.0 %
2450	52.7	1.95	7.93	7.93	7.93	0.30	0.92	± 12.0 %
2600	52.5	2.16	7.59	7.59	7.59	0.28	0.92	± 12.0 %
3700	51.0	3.55	6.84	6.84	6.84	0.30	1.20	± 13.1 %
5250	48.9	5.36	4.87	4.87	4.87	0.40	1.90	± 13.1 %
5600	48.5	5.77	4.03	4.03	4.03	0.50	1.90	± 13.1 %
5750	48.3	5.94	4.33	4.33	4.33	0.50	1.90	± 13.1 %

<sup>C</sup> Frequency validity above 300 MHz of ± 100 MHz only applies for DASY v4.4 and higher (see Page 2), else it is restricted to ± 50 MHz. The uncertainty is the RSS of the ConvF uncertainty at calibration frequency and the uncertainty for the indicated frequency band. Frequency validity below 300 MHz is ± 10, 25, 40, 50 and 70 MHz for ConvF assessments at 30, 64, 128, 150 and 220 MHz respectively. Above 5 GHz frequency validity can be extended to ± 110 MHz.

<sup>F</sup> At frequencies below 3 GHz, the validity of tissue parameters ( $\epsilon$  and  $\sigma$ ) can be relaxed to ± 10% if liquid compensation formula is applied to measured SAR values. At frequencies above 3 GHz, the validity of tissue parameters ( $\epsilon$  and  $\sigma$ ) is restricted to ± 5%. The uncertainty is the RSS of the ConvF uncertainty for indicated target tissue parameters.

<sup>G</sup> Alpha/Depth are determined during calibration. SPEAG warrants that the remaining deviation due to the boundary effect after compensation is always less than ± 1% for frequencies below 3 GHz and below ± 2% for frequencies between 3-6 GHz at any distance larger than half the probe tip diameter from the boundary.

### Frequency Response of E-Field (TEM-Cell:ifi110 EXX, Waveguide: R22)

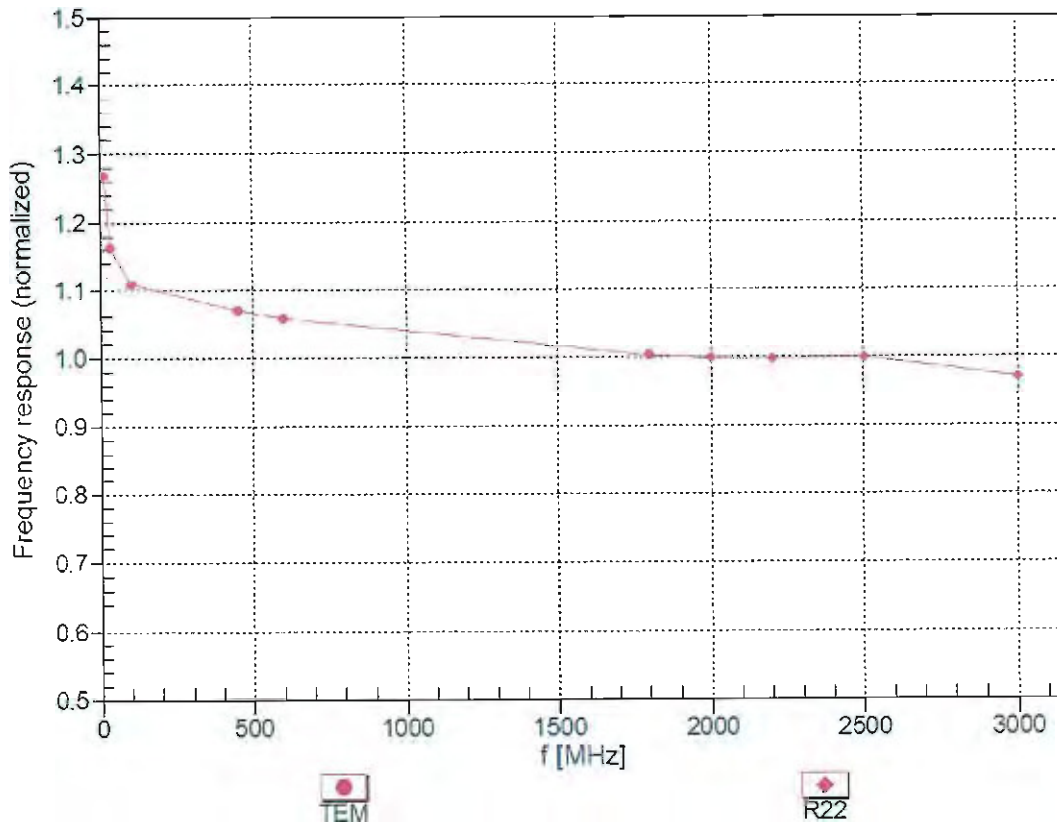

Uncertainty of Frequency Response of E-field:  $\pm 6.3\%$  (k=2)

### Receiving Pattern ( $\phi$ ), $\theta = 0^\circ$

f=600 MHz, TEM

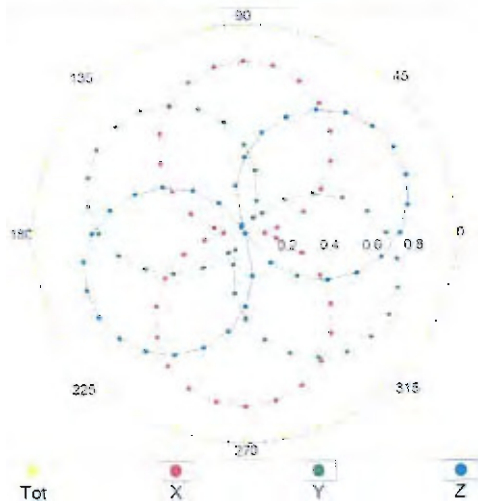

f=1800 MHz, R22

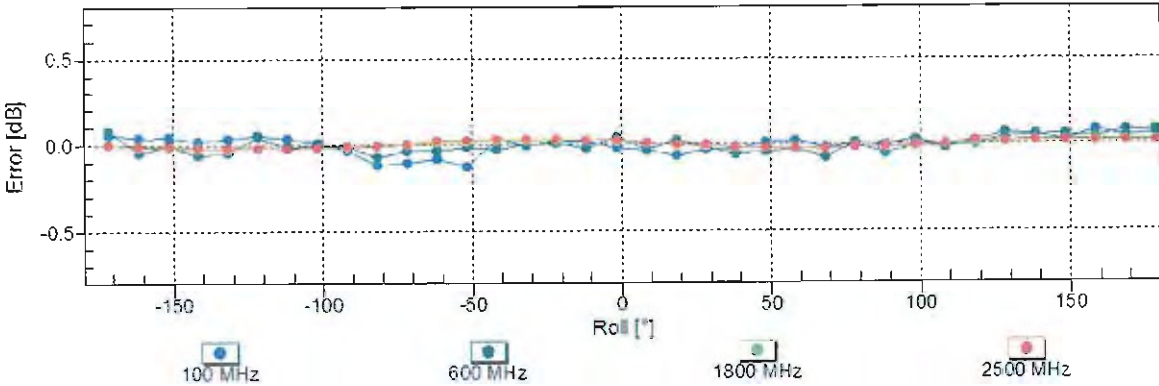
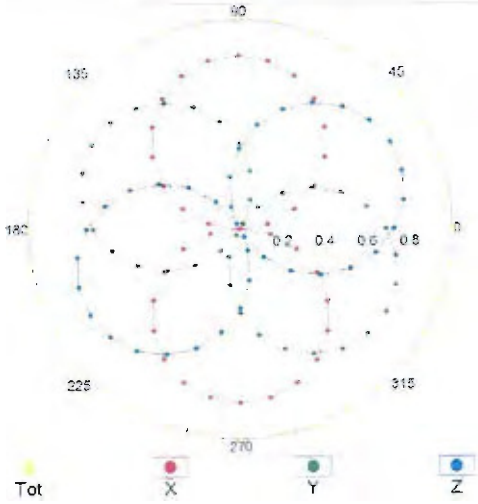

Uncertainty of Axial Isotropy Assessment:  $\pm 0.5\%$  (k=2)

### Dynamic Range f(SAR<sub>head</sub>) (TEM cell , f<sub>eval</sub>= 1900 MHz)

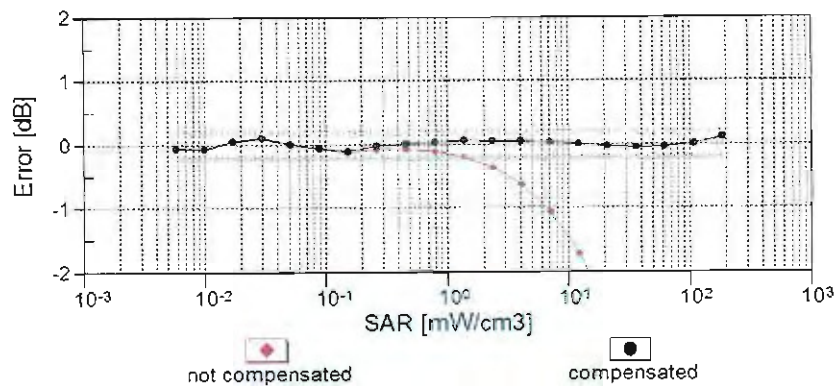
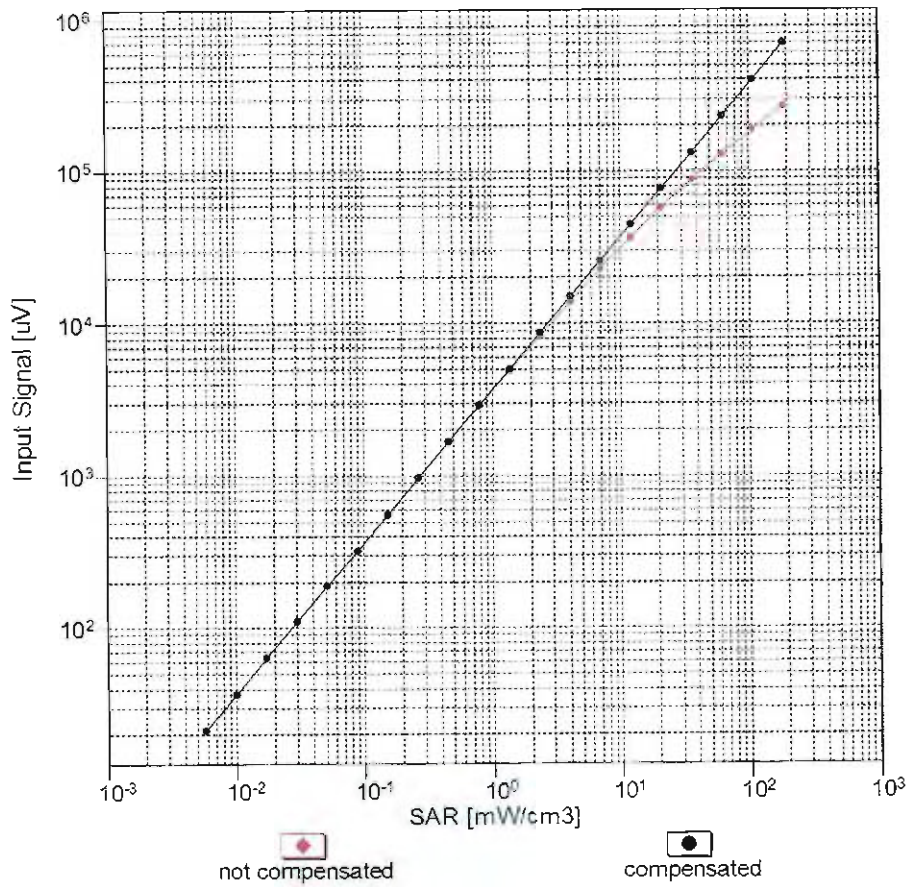

Uncertainty of Linearity Assessment: ± 0.6% (k=2)

# Conversion Factor Assessment

f = 835 MHz, WGLS R9 (H\_convF)

f = 1900 MHz, WGLS R22 (H\_convF)

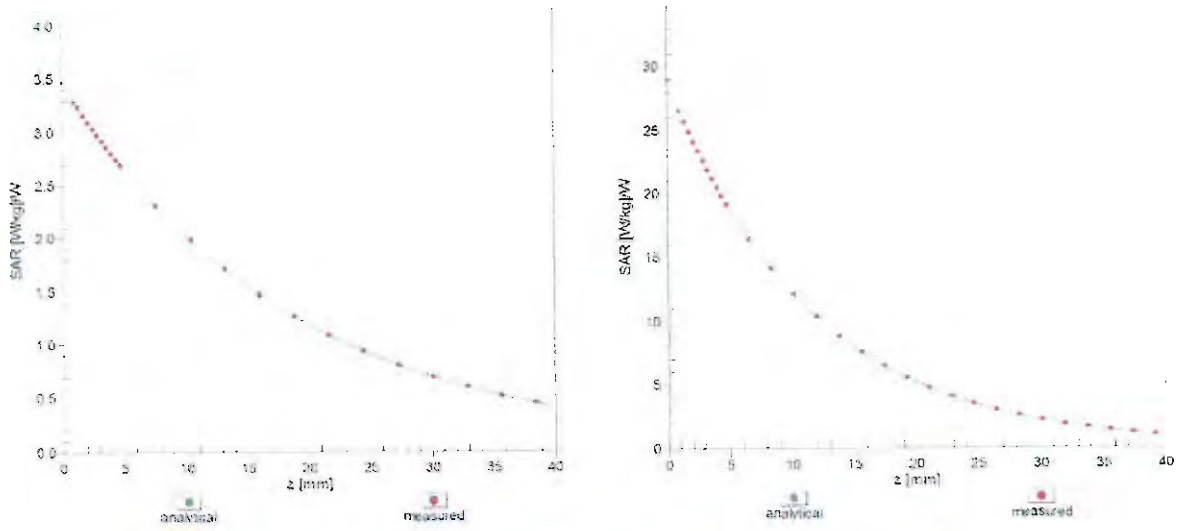

## Deviation from Isotropy in Liquid Error ( $\phi, \vartheta$ ), f = 900 MHz

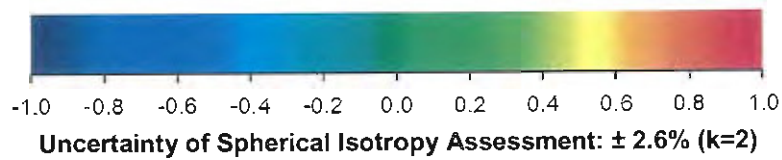
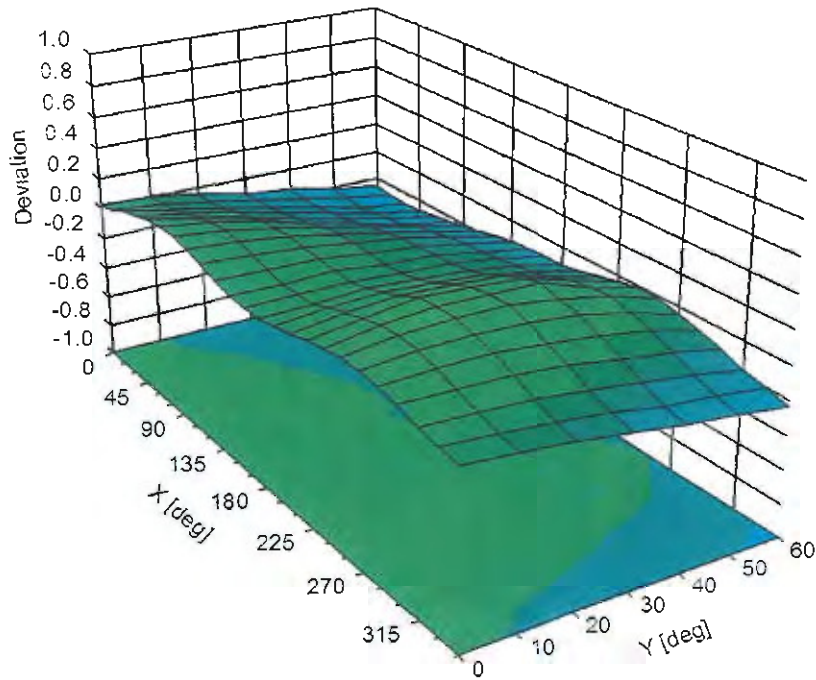

**DASY/EASY - Parameters of Probe: EX3DV4 - SN:3976****Other Probe Parameters**

Sensor Arrangement	Triangular
Connector Angle (°)	-1.6
Mechanical Surface Detection Mode	enabled
Optical Surface Detection Mode	disabled
Probe Overall Length	337 mm
Probe Body Diameter	10 mm
Tip Length	9 mm
Tip Diameter	2.5 mm
Probe Tip to Sensor X Calibration Point	1 mm
Probe Tip to Sensor Y Calibration Point	1 mm
Probe Tip to Sensor Z Calibration Point	1 mm
Recommended Measurement Distance from Surface	1.4 mm





Accredited by the Swiss Accreditation Service (SAS)  
The Swiss Accreditation Service is one of the signatories to the EA  
Multilateral Agreement for the recognition of calibration certificates

Accreditation No.: **SCS 0108**

Client **Sporton-TW (Auden)**

Certificate No: **EX3-3925\_May16**

## CALIBRATION CERTIFICATE

Object **EX3DV4 - SN:3925**

Calibration procedure(s) **QA CAL-01.v9, QA CAL-14.v4, QA CAL-23.v5, QA CAL-25.v6  
Calibration procedure for dosimetric E-field probes**

Calibration date: **May 26, 2016**

This calibration certificate documents the traceability to national standards, which realize the physical units of measurements (SI).  
The measurements and the uncertainties with confidence probability are given on the following pages and are part of the certificate.

All calibrations have been conducted in the closed laboratory facility: environment temperature (22 ± 3)°C and humidity < 70%.

Calibration Equipment used (M&TE critical for calibration)

Primary Standards	ID	Cal Date (Certificate No.)	Scheduled Calibration
Power meter NRP	SN: 104778	06-Apr-16 (No. 217-02288/02289)	Apr-17
Power sensor NRP-Z91	SN: 103244	06-Apr-16 (No. 217-02288)	Apr-17
Power sensor NRP-Z91	SN: 103245	06-Apr-16 (No. 217-02289)	Apr-17
Reference 20 dB Attenuator	SN: S5277 (20x)	05-Apr-16 (No. 217-02293)	Apr-17
Reference Probe ES3DV2	SN: 3013	31-Dec-15 (No. ES3-3013_Dec15)	Dec-16
DAE4	SN: 660	23-Dec-15 (No. DAE4-660_Dec15)	Dec-16
Secondary Standards	ID	Check Date (in house)	Scheduled Check
Power meter E4419B	SN: GB41293874	06-Apr-16 (No. 217-02285/02284)	In house check: Jun-16
Power sensor E4412A	SN: MY41498087	06-Apr-16 (No. 217-02285)	In house check: Jun-16
Power sensor E4412A	SN: 000110210	06-Apr-16 (No. 217-02284)	In house check: Jun-16
RF generator HP 8648C	SN: US3642U01700	04-Aug-99 (in house check Apr-13)	In house check: Jun-16
Network Analyzer HP 8753E	SN: US37390585	18-Oct-01 (in house check Oct-15)	In house check: Oct-16

Calibrated by:	Name Leif Klysner	Function Laboratory Technician	Signature 
Approved by:	Name Katja Pokovic	Function Technical Manager	Signature 

Issued: May 31, 2016

This calibration certificate shall not be reproduced except in full without written approval of the laboratory.



Accredited by the Swiss Accreditation Service (SAS)

Accreditation No.: **SCS 0108**

The Swiss Accreditation Service is one of the signatories to the EA  
Multilateral Agreement for the recognition of calibration certificates

### Glossary:

TSL	tissue simulating liquid
NORM <sub>x,y,z</sub>	sensitivity in free space
ConvF	sensitivity in TSL / NORM <sub>x,y,z</sub>
DCP	diode compression point
CF	crest factor (1/duty_cycle) of the RF signal
A, B, C, D	modulation dependent linearization parameters
Polarization $\varphi$	$\varphi$ rotation around probe axis
Polarization $\vartheta$	$\vartheta$ rotation around an axis that is in the plane normal to probe axis (at measurement center), i.e., $\vartheta = 0$ is normal to probe axis
Connector Angle	information used in DASY system to align probe sensor X to the robot coordinate system

### Calibration is Performed According to the Following Standards:

- IEEE Std 1528-2013, "IEEE Recommended Practice for Determining the Peak Spatial-Averaged Specific Absorption Rate (SAR) in the Human Head from Wireless Communications Devices: Measurement Techniques", June 2013
- IEC 62209-1, "Procedure to measure the Specific Absorption Rate (SAR) for hand-held devices used in close proximity to the ear (frequency range of 300 MHz to 3 GHz)", February 2005
- IEC 62209-2, "Procedure to determine the Specific Absorption Rate (SAR) for wireless communication devices used in close proximity to the human body (frequency range of 30 MHz to 6 GHz)", March 2010
- KDB 865664, "SAR Measurement Requirements for 100 MHz to 6 GHz"

### Methods Applied and Interpretation of Parameters:

- NORM<sub>x,y,z</sub>**: Assessed for E-field polarization  $\vartheta = 0$  ( $f \leq 900$  MHz in TEM-cell;  $f > 1800$  MHz: R22 waveguide). NORM<sub>x,y,z</sub> are only intermediate values, i.e., the uncertainties of NORM<sub>x,y,z</sub> does not affect the  $E^2$ -field uncertainty inside TSL (see below ConvF).
- NORM(f)<sub>x,y,z</sub> = NORM<sub>x,y,z</sub> \* frequency\_response** (see Frequency Response Chart). This linearization is implemented in DASY4 software versions later than 4.2. The uncertainty of the frequency response is included in the stated uncertainty of ConvF.
- DCP<sub>x,y,z</sub>**: DCP are numerical linearization parameters assessed based on the data of power sweep with CW signal (no uncertainty required). DCP does not depend on frequency nor media.
- PAR**: PAR is the Peak to Average Ratio that is not calibrated but determined based on the signal characteristics
- A<sub>x,y,z</sub>; B<sub>x,y,z</sub>; C<sub>x,y,z</sub>; D<sub>x,y,z</sub>; VR<sub>x,y,z</sub>; A, B, C, D** are numerical linearization parameters assessed based on the data of power sweep for specific modulation signal. The parameters do not depend on frequency nor media. VR is the maximum calibration range expressed in RMS voltage across the diode.
- ConvF and Boundary Effect Parameters**: Assessed in flat phantom using E-field (or Temperature Transfer Standard for  $f \leq 800$  MHz) and inside waveguide using analytical field distributions based on power measurements for  $f > 800$  MHz. The same setups are used for assessment of the parameters applied for boundary compensation (alpha, depth) of which typical uncertainty values are given. These parameters are used in DASY4 software to improve probe accuracy close to the boundary. The sensitivity in TSL corresponds to NORM<sub>x,y,z</sub> \* ConvF whereby the uncertainty corresponds to that given for ConvF. A frequency dependent ConvF is used in DASY version 4.4 and higher which allows extending the validity from  $\pm 50$  MHz to  $\pm 100$  MHz.
- Spherical isotropy (3D deviation from isotropy)**: in a field of low gradients realized using a flat phantom exposed by a patch antenna.
- Sensor Offset**: The sensor offset corresponds to the offset of virtual measurement center from the probe tip (on probe axis). No tolerance required.
- Connector Angle**: The angle is assessed using the information gained by determining the NORM<sub>x</sub> (no uncertainty required).

# Probe EX3DV4

## SN:3925

Manufactured: March 8, 2013  
Calibrated: May 26, 2016

Calibrated for DASY/EASY Systems  
(Note: non-compatible with DASY2 system!)

## DASY/EASY - Parameters of Probe: EX3DV4 - SN:3925

### Basic Calibration Parameters

	Sensor X	Sensor Y	Sensor Z	Unc (k=2)
Norm ( $\mu\text{V}/(\text{V}/\text{m})^2$ ) <sup>A</sup>	0.59	0.52	0.50	$\pm 10.1\%$
DCP (mV) <sup>B</sup>	96.5	97.9	98.9	

### Modulation Calibration Parameters

UID	Communication System Name		A dB	B dB $\sqrt{\mu\text{V}}$	C	D dB	VR mV	Unc <sup>E</sup> (k=2)
0	CW	X	0.0	0.0	1.0	0.00	152.6	$\pm 2.7\%$
		Y	0.0	0.0	1.0		143.7	
		Z	0.0	0.0	1.0		138.9	

The reported uncertainty of measurement is stated as the standard uncertainty of measurement multiplied by the coverage factor k=2, which for a normal distribution corresponds to a coverage probability of approximately 95%.

<sup>A</sup> The uncertainties of Norm X,Y,Z do not affect the E<sup>2</sup>-field uncertainty inside TSL (see Pages 5 and 6).

<sup>B</sup> Numerical linearization parameter; uncertainty not required.

<sup>E</sup> Uncertainty is determined using the max. deviation from linear response applying rectangular distribution and is expressed for the square of the field value.

## DASY/EASY - Parameters of Probe: EX3DV4 - SN:3925

### Calibration Parameter Determined in Head Tissue Simulating Media

f (MHz) <sup>C</sup>	Relative Permittivity <sup>F</sup>	Conductivity (S/m) <sup>F</sup>	ConvF X	ConvF Y	ConvF Z	Alpha <sup>G</sup>	Depth <sup>G</sup> (mm)	Unc (k=2)
750	41.9	0.89	10.37	10.37	10.37	0.48	0.80	± 12.0 %
835	41.5	0.90	9.92	9.92	9.92	0.47	0.81	± 12.0 %
900	41.5	0.97	9.72	9.72	9.72	0.41	0.80	± 12.0 %
1750	40.1	1.37	8.57	8.57	8.57	0.29	0.80	± 12.0 %
1900	40.0	1.40	8.30	8.30	8.30	0.30	0.80	± 12.0 %
2000	40.0	1.40	8.26	8.26	8.26	0.30	0.80	± 12.0 %
2450	39.2	1.80	7.47	7.47	7.47	0.35	0.80	± 12.0 %
2600	39.0	1.96	7.28	7.28	7.28	0.36	0.86	± 12.0 %
3500	37.9	2.91	7.14	7.14	7.14	0.29	1.30	± 13.1 %
5200	36.0	4.66	5.31	5.31	5.31	0.35	1.80	± 13.1 %
5300	35.9	4.76	5.15	5.15	5.15	0.35	1.80	± 13.1 %
5500	35.6	4.96	4.66	4.66	4.66	0.45	1.80	± 13.1 %
5600	35.5	5.07	4.47	4.47	4.47	0.50	1.80	± 13.1 %
5800	35.3	5.27	4.51	4.51	4.51	0.50	1.80	± 13.1 %

<sup>C</sup> Frequency validity above 300 MHz of ± 100 MHz only applies for DASY v4.4 and higher (see Page 2), else it is restricted to ± 50 MHz. The uncertainty is the RSS of the ConvF uncertainty at calibration frequency and the uncertainty for the indicated frequency band. Frequency validity below 300 MHz is ± 10, 25, 40, 50 and 70 MHz for ConvF assessments at 30, 64, 128, 150 and 220 MHz respectively. Above 5 GHz frequency validity can be extended to ± 110 MHz.

<sup>F</sup> At frequencies below 3 GHz, the validity of tissue parameters ( $\epsilon$  and  $\sigma$ ) can be relaxed to ± 10% if liquid compensation formula is applied to measured SAR values. At frequencies above 3 GHz, the validity of tissue parameters ( $\epsilon$  and  $\sigma$ ) is restricted to ± 5%. The uncertainty is the RSS of the ConvF uncertainty for indicated target tissue parameters.

<sup>G</sup> Alpha/Depth are determined during calibration. SPEAG warrants that the remaining deviation due to the boundary effect after compensation is always less than ± 1% for frequencies below 3 GHz and below ± 2% for frequencies between 3-6 GHz at any distance larger than half the probe tip diameter from the boundary.

## DASY/EASY - Parameters of Probe: EX3DV4 - SN:3925

### Calibration Parameter Determined in Body Tissue Simulating Media

f (MHz) <sup>C</sup>	Relative Permittivity <sup>F</sup>	Conductivity (S/m) <sup>F</sup>	ConvF X	ConvF Y	ConvF Z	Alpha <sup>G</sup>	Depth <sup>G</sup> (mm)	Unc (k=2)
750	55.5	0.96	10.18	10.18	10.18	0.49	0.80	± 12.0 %
835	55.2	0.97	9.91	9.91	9.91	0.44	0.88	± 12.0 %
900	55.0	1.05	9.96	9.96	9.96	0.47	0.80	± 12.0 %
1750	53.4	1.49	8.30	8.30	8.30	0.34	0.80	± 12.0 %
1900	53.3	1.52	8.00	8.00	8.00	0.38	0.80	± 12.0 %
2000	53.3	1.52	8.18	8.18	8.18	0.37	0.80	± 12.0 %
2450	52.7	1.95	7.64	7.64	7.64	0.36	0.80	± 12.0 %
2600	52.5	2.16	7.38	7.38	7.38	0.26	0.80	± 12.0 %
3500	51.3	3.31	6.73	6.73	6.73	0.29	1.30	± 13.1 %
5200	49.0	5.30	4.39	4.39	4.39	0.50	1.90	± 13.1 %
5300	48.9	5.42	4.22	4.22	4.22	0.50	1.90	± 13.1 %
5500	48.6	5.65	4.02	4.02	4.02	0.55	1.90	± 13.1 %
5600	48.5	5.77	3.85	3.85	3.85	0.60	1.90	± 13.1 %
5800	48.2	6.00	3.85	3.85	3.85	0.60	1.90	± 13.1 %

<sup>C</sup> Frequency validity above 300 MHz of ± 100 MHz only applies for DASY v4.4 and higher (see Page 2), else it is restricted to ± 50 MHz. The uncertainty is the RSS of the ConvF uncertainty at calibration frequency and the uncertainty for the indicated frequency band. Frequency validity below 300 MHz is ± 10, 25, 40, 50 and 70 MHz for ConvF assessments at 30, 64, 128, 150 and 220 MHz respectively. Above 5 GHz frequency validity can be extended to ± 110 MHz.

<sup>F</sup> At frequencies below 3 GHz, the validity of tissue parameters ( $\epsilon$  and  $\sigma$ ) can be relaxed to ± 10% if liquid compensation formula is applied to measured SAR values. At frequencies above 3 GHz, the validity of tissue parameters ( $\epsilon$  and  $\sigma$ ) is restricted to ± 5%. The uncertainty is the RSS of the ConvF uncertainty for indicated target tissue parameters.

<sup>G</sup> Alpha/Depth are determined during calibration. SPEAG warrants that the remaining deviation due to the boundary effect after compensation is always less than ± 1% for frequencies below 3 GHz and below ± 2% for frequencies between 3-6 GHz at any distance larger than half the probe tip diameter from the boundary.

# Frequency Response of E-Field

(TEM-Cell:ifi110 EXX, Waveguide: R22)

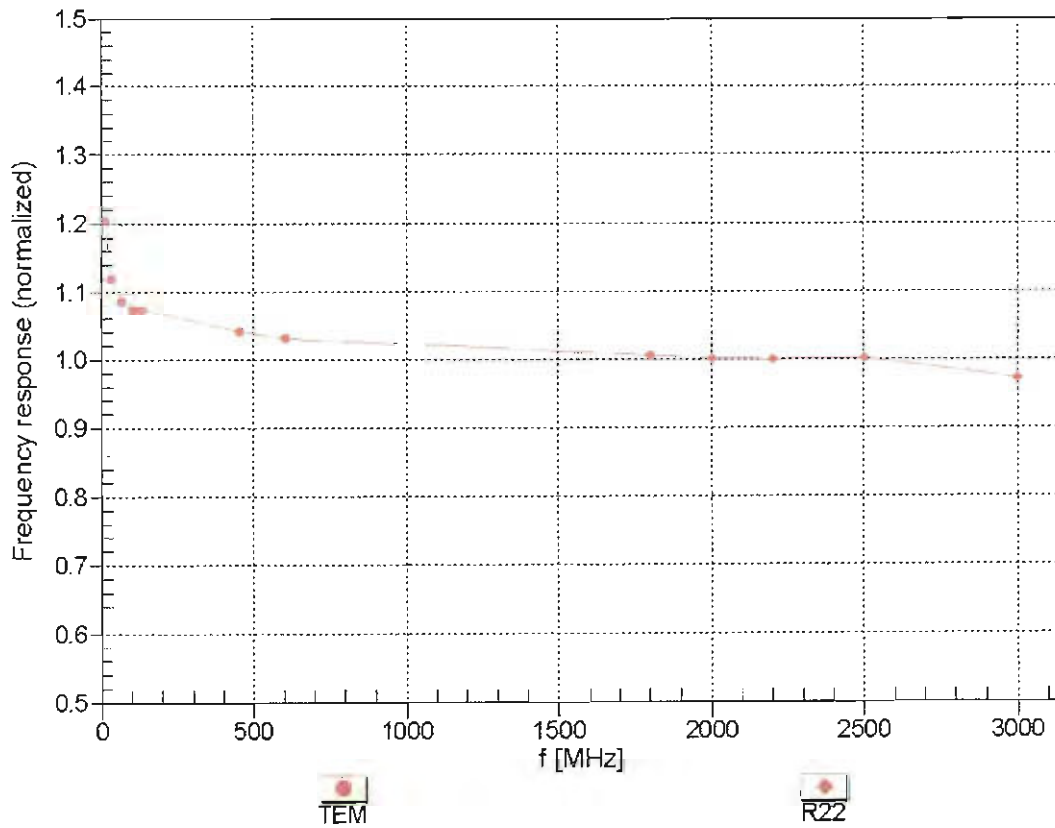

Uncertainty of Frequency Response of E-field:  $\pm 6.3\%$  (k=2)

### Receiving Pattern ( $\phi$ ), $\theta = 0^\circ$

f=600 MHz,TEM

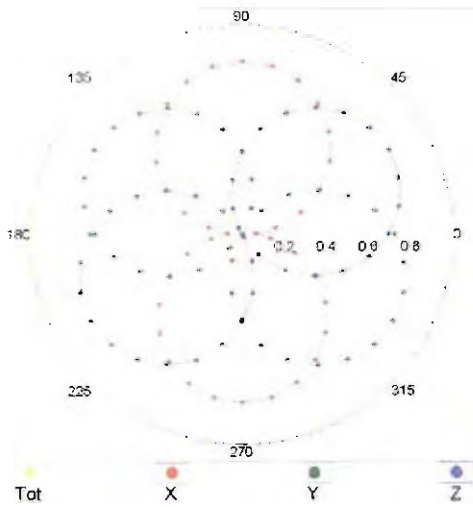

f=1800 MHz,R22

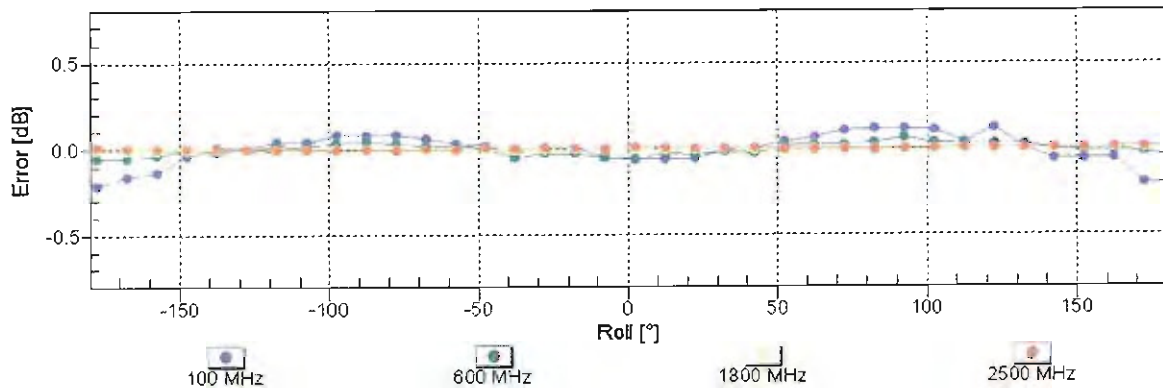
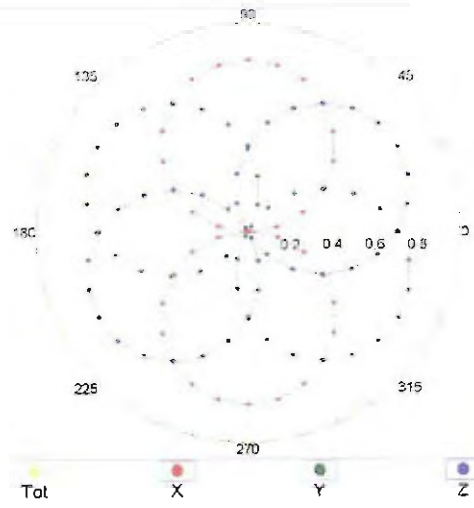

Uncertainty of Axial Isotropy Assessment:  $\pm 0.5\%$  (k=2)



### Dynamic Range $f(\text{SAR}_{\text{head}})$ (TEM cell, $f_{\text{eval}} = 1900 \text{ MHz}$ )

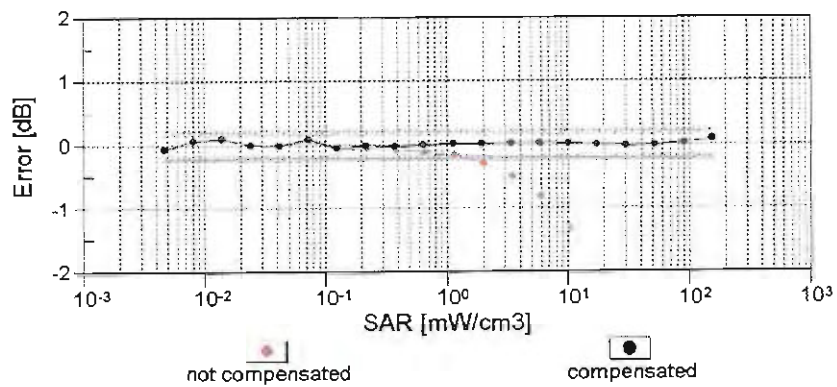
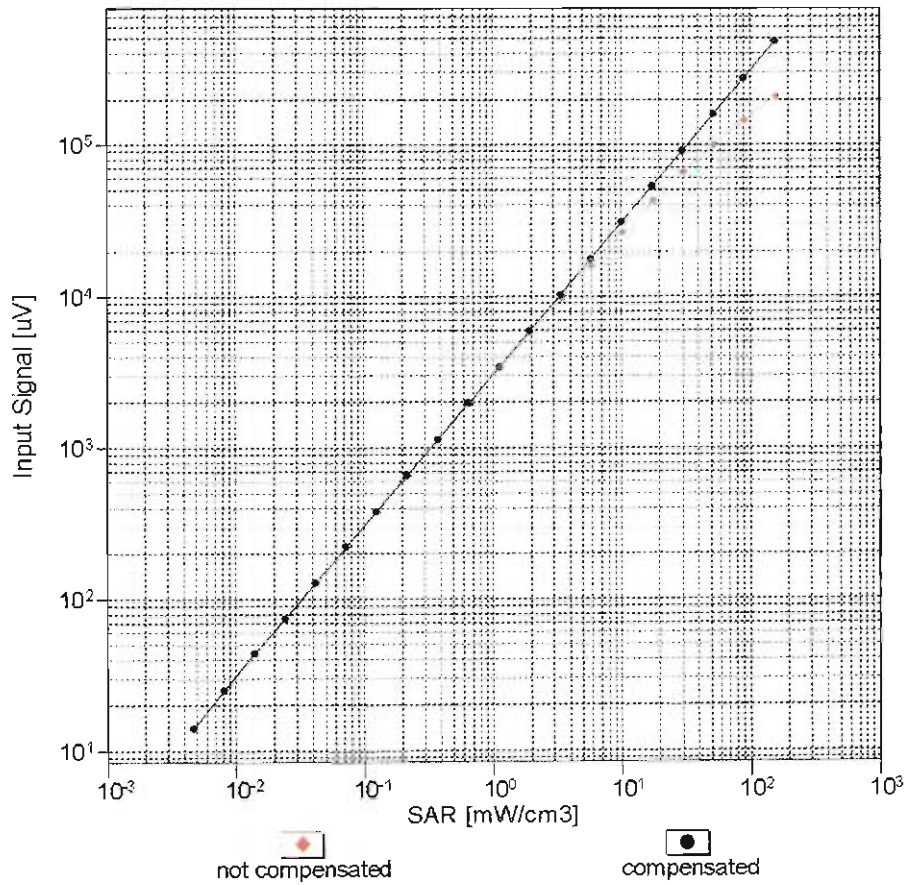

Uncertainty of Linearity Assessment:  $\pm 0.6\%$  ( $k=2$ )

# Conversion Factor Assessment

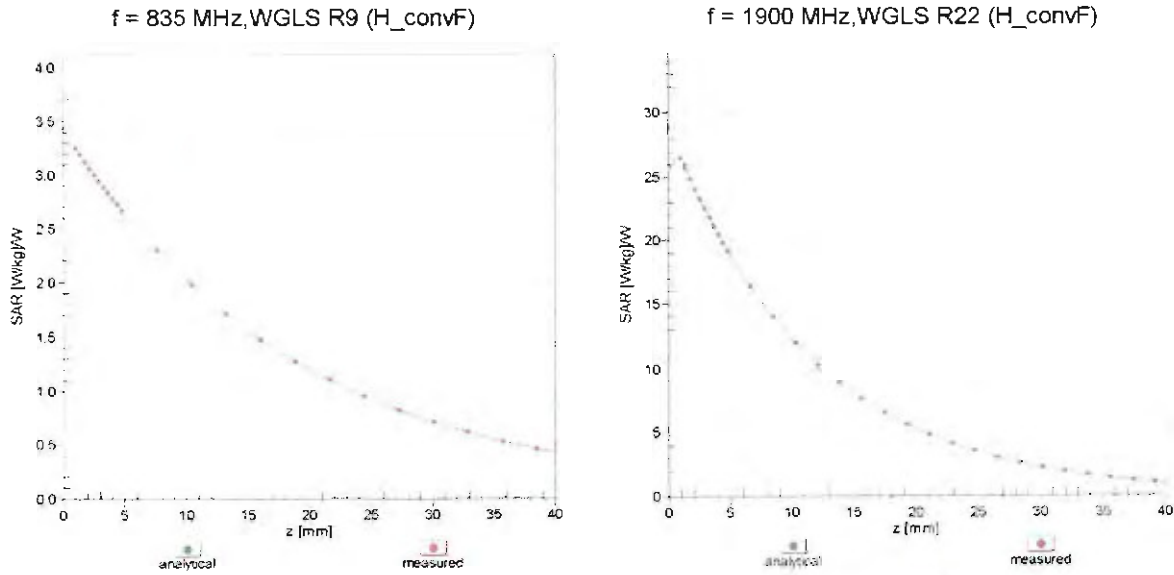

## Deviation from Isotropy in Liquid Error ( $\phi, \theta$ ), f = 900 MHz

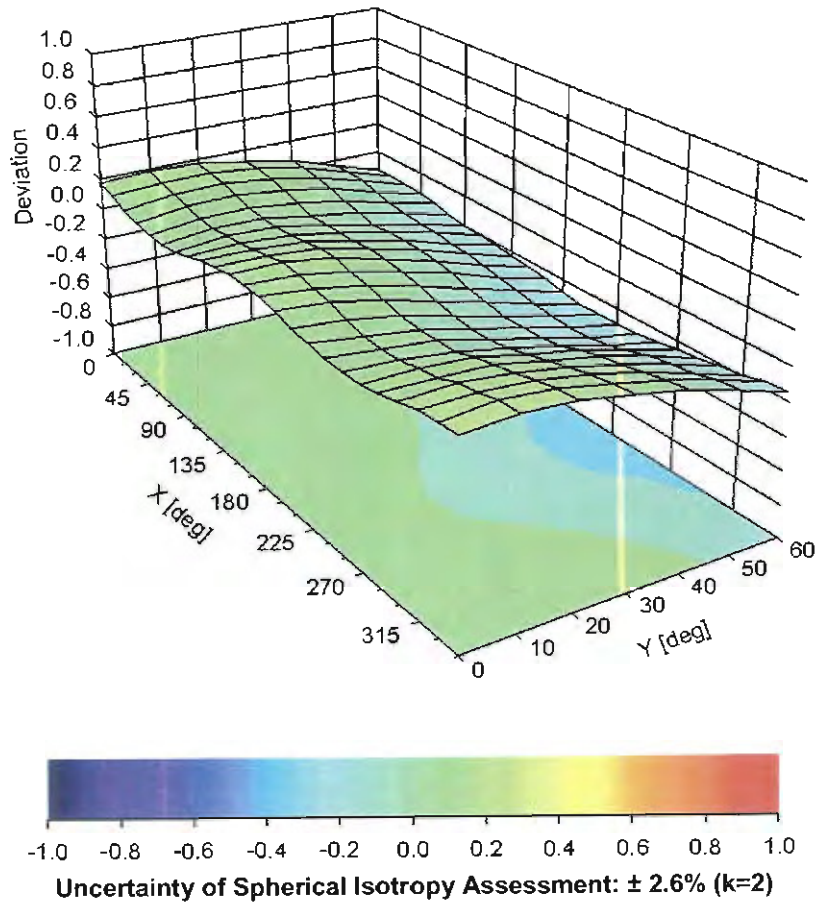

## DASY/EASY - Parameters of Probe: EX3DV4 - SN:3925

### Other Probe Parameters

Sensor Arrangement	Triangular
Connector Angle (°)	92.2
Mechanical Surface Detection Mode	enabled
Optical Surface Detection Mode	disabled
Probe Overall Length	337 mm
Probe Body Diameter	10 mm
Tip Length	9 mm
Tip Diameter	2.5 mm
Probe Tip to Sensor X Calibration Point	1 mm
Probe Tip to Sensor Y Calibration Point	1 mm
Probe Tip to Sensor Z Calibration Point	1 mm
Recommended Measurement Distance from Surface	1.4 mm



Accreditation No.: **SCS 0108**

Accredited by the Swiss Accreditation Service (SAS)  
The Swiss Accreditation Service is one of the signatories to the EA  
Multilateral Agreement for the recognition of calibration certificates

Client **Sporton-TW (Auden)**

Certificate No: **EX3-3955\_Nov16**

## CALIBRATION CERTIFICATE

Object **EX3DV4 - SN:3955**

Calibration procedure(s) **QA CAL-01.v9, QA CAL-14.v4, QA CAL-23.v5, QA CAL-25.v6**  
Calibration procedure for dosimetric E-field probes

Calibration date: **November 24, 2016**

This calibration certificate documents the traceability to national standards, which realize the physical units of measurements (SI).  
The measurements and the uncertainties with confidence probability are given on the following pages and are part of the certificate.

All calibrations have been conducted in the closed laboratory facility: environment temperature (22 ± 3)°C and humidity < 70%.

Calibration Equipment used (M&TE critical for calibration)

Primary Standards	ID	Cal Date (Certificate No.)	Scheduled Calibration
Power meter NRP	SN: 104778	06-Apr-16 (No. 217-02288/02289)	Apr-17
Power sensor NRP-Z91	SN: 103244	06-Apr-16 (No. 217-02288)	Apr-17
Power sensor NRP-Z91	SN: 103245	06-Apr-16 (No. 217-02289)	Apr-17
Reference 20 dB Attenuator	SN: S5277 (20x)	05-Apr-16 (No. 217-02293)	Apr-17
Reference Probe ES3DV2	SN: 3013	31-Dec-15 (No. ES3-3013_Dec15)	Dec-16
DAE4	SN: 660	23-Dec-15 (No. DAE4-660_Dec15)	Dec-16
Secondary Standards	ID	Check Date (in house)	Scheduled Check
Power meter E4419B	SN: GB41293874	06-Apr-16 (in house check Jun-16)	In house check: Jun-18
Power sensor E4412A	SN: MY41498087	06-Apr-16 (in house check Jun-16)	In house check: Jun-18
Power sensor E4412A	SN: 000110210	06-Apr-16 (in house check Jun-16)	In house check: Jun-18
RF generator HP 8648C	SN: US3642U01700	04-Aug-99 (in house check Jun-16)	In house check: Jun-18
Network Analyzer HP 8753E	SN: US37390585	18-Oct-01 (in house check Oct-16)	In house check: Oct-17

	Name	Function	Signature
Calibrated by:	Leif Klysner	Laboratory Technician	
Approved by:	Katja Pokovic	Technical Manager	
			Issued: November 28, 2016
This calibration certificate shall not be reproduced except in full without written approval of the laboratory.			



Accredited by the Swiss Accreditation Service (SAS)

Accreditation No.: **SCS 0108**

The Swiss Accreditation Service is one of the signatories to the EA  
Multilateral Agreement for the recognition of calibration certificates

### Glossary:

TSL	tissue simulating liquid
NORM <sub>x,y,z</sub>	sensitivity in free space
ConvF	sensitivity in TSL / NORM <sub>x,y,z</sub>
DCP	diode compression point
CF	crest factor (1/duty_cycle) of the RF signal
A, B, C, D	modulation dependent linearization parameters
Polarization $\varphi$	$\varphi$ rotation around probe axis
Polarization $\vartheta$	$\vartheta$ rotation around an axis that is in the plane normal to probe axis (at measurement center), i.e., $\vartheta = 0$ is normal to probe axis
Connector Angle	information used in DASY system to align probe sensor X to the robot coordinate system

### Calibration is Performed According to the Following Standards:

- IEEE Std 1528-2013, "IEEE Recommended Practice for Determining the Peak Spatial-Averaged Specific Absorption Rate (SAR) in the Human Head from Wireless Communications Devices: Measurement Techniques", June 2013
- IEC 62209-1, "Procedure to measure the Specific Absorption Rate (SAR) for hand-held devices used in close proximity to the ear (frequency range of 300 MHz to 3 GHz)", February 2005
- IEC 62209-2, "Procedure to determine the Specific Absorption Rate (SAR) for wireless communication devices used in close proximity to the human body (frequency range of 30 MHz to 6 GHz)", March 2010
- KDB 865664, "SAR Measurement Requirements for 100 MHz to 6 GHz"

### Methods Applied and Interpretation of Parameters:

- NORM<sub>x,y,z</sub>**: Assessed for E-field polarization  $\vartheta = 0$  ( $f \leq 900$  MHz in TEM-cell;  $f > 1800$  MHz: R22 waveguide). NORM<sub>x,y,z</sub> are only intermediate values, i.e., the uncertainties of NORM<sub>x,y,z</sub> does not affect the E<sup>2</sup>-field uncertainty inside TSL (see below ConvF).
- NORM(f)<sub>x,y,z</sub> = NORM<sub>x,y,z</sub> \* frequency\_response** (see Frequency Response Chart). This linearization is implemented in DASY4 software versions later than 4.2. The uncertainty of the frequency response is included in the stated uncertainty of ConvF.
- DCP<sub>x,y,z</sub>**: DCP are numerical linearization parameters assessed based on the data of power sweep with CW signal (no uncertainty required). DCP does not depend on frequency nor media.
- PAR**: PAR is the Peak to Average Ratio that is not calibrated but determined based on the signal characteristics
- A<sub>x,y,z</sub>; B<sub>x,y,z</sub>; C<sub>x,y,z</sub>; D<sub>x,y,z</sub>; VR<sub>x,y,z</sub>**: A, B, C, D are numerical linearization parameters assessed based on the data of power sweep for specific modulation signal. The parameters do not depend on frequency nor media. VR is the maximum calibration range expressed in RMS voltage across the diode.
- ConvF and Boundary Effect Parameters**: Assessed in flat phantom using E-field (or Temperature Transfer Standard for  $f \leq 800$  MHz) and inside waveguide using analytical field distributions based on power measurements for  $f > 800$  MHz. The same setups are used for assessment of the parameters applied for boundary compensation (alpha, depth) of which typical uncertainty values are given. These parameters are used in DASY4 software to improve probe accuracy close to the boundary. The sensitivity in TSL corresponds to NORM<sub>x,y,z</sub> \* ConvF whereby the uncertainty corresponds to that given for ConvF. A frequency dependent ConvF is used in DASY version 4.4 and higher which allows extending the validity from  $\pm 50$  MHz to  $\pm 100$  MHz.
- Spherical isotropy (3D deviation from isotropy)**: in a field of low gradients realized using a flat phantom exposed by a patch antenna.
- Sensor Offset**: The sensor offset corresponds to the offset of virtual measurement center from the probe tip (on probe axis). No tolerance required.
- Connector Angle**: The angle is assessed using the information gained by determining the NORM<sub>x</sub> (no uncertainty required).

# Probe EX3DV4

## SN:3955

Manufactured: August 6, 2013  
Calibrated: November 24, 2016

Calibrated for DASY/EASY Systems  
(Note: non-compatible with DASY2 system!)

## DASY/EASY - Parameters of Probe: EX3DV4 - SN:3955

### Basic Calibration Parameters

	Sensor X	Sensor Y	Sensor Z	Unc (k=2)
Norm ( $\mu\text{V}/(\text{V}/\text{m})^2$ ) <sup>A</sup>	0.34	0.40	0.31	$\pm 10.1 \%$
DCP (mV) <sup>B</sup>	100.5	101.5	97.2	

### Modulation Calibration Parameters

UID	Communication System Name		A dB	B dB $\sqrt{\mu\text{V}}$	C	D dB	VR mV	Unc <sup>E</sup> (k=2)
0	CW	X	0.0	0.0	1.0	0.00	128.6	$\pm 3.3 \%$
		Y	0.0	0.0	1.0		140.6	
		Z	0.0	0.0	1.0		128.8	

The reported uncertainty of measurement is stated as the standard uncertainty of measurement multiplied by the coverage factor  $k=2$ , which for a normal distribution corresponds to a coverage probability of approximately 95%.

<sup>A</sup> The uncertainties of Norm X,Y,Z do not affect the  $E^2$ -field uncertainty inside TSL (see Pages 5 and 6).

<sup>B</sup> Numerical linearization parameter: uncertainty not required.

<sup>E</sup> Uncertainty is determined using the max. deviation from linear response applying rectangular distribution and is expressed for the square of the field value.

## DASY/EASY - Parameters of Probe: EX3DV4 - SN:3955

### Calibration Parameter Determined in Head Tissue Simulating Media

f (MHz) <sup>C</sup>	Relative Permittivity <sup>F</sup>	Conductivity (S/m) <sup>F</sup>	ConvF X	ConvF Y	ConvF Z	Alpha <sup>G</sup>	Depth <sup>G</sup> (mm)	Unc (k=2)
750	41.9	0.89	10.65	10.65	10.65	0.49	0.80	± 12.0 %
835	41.5	0.90	10.33	10.33	10.33	0.44	0.80	± 12.0 %
900	41.5	0.97	10.07	10.07	10.07	0.34	1.01	± 12.0 %
1750	40.1	1.37	8.68	8.68	8.68	0.32	0.80	± 12.0 %
1900	40.0	1.40	8.43	8.43	8.43	0.32	0.80	± 12.0 %
2000	40.0	1.40	8.38	8.38	8.38	0.33	0.80	± 12.0 %
2450	39.2	1.80	7.56	7.56	7.56	0.24	1.06	± 12.0 %
2600	39.0	1.96	7.28	7.28	7.28	0.30	0.95	± 12.0 %
5250	35.9	4.71	5.04	5.04	5.04	0.40	1.80	± 13.1 %
5600	35.5	5.07	4.50	4.50	4.50	0.50	1.80	± 13.1 %
5750	35.4	5.22	4.63	4.63	4.63	0.50	1.80	± 13.1 %

<sup>C</sup> Frequency validity above 300 MHz of ± 100 MHz only applies for DASY v4.4 and higher (see Page 2), else it is restricted to ± 50 MHz. The uncertainty is the RSS of the ConvF uncertainty at calibration frequency and the uncertainty for the indicated frequency band. Frequency validity below 300 MHz is ± 10, 25, 40, 50 and 70 MHz for ConvF assessments at 30, 64, 128, 150 and 220 MHz respectively. Above 5 GHz frequency validity can be extended to ± 110 MHz.

<sup>F</sup> At frequencies below 3 GHz, the validity of tissue parameters ( $\epsilon$  and  $\sigma$ ) can be relaxed to ± 10% if liquid compensation formula is applied to measured SAR values. At frequencies above 3 GHz, the validity of tissue parameters ( $\epsilon$  and  $\sigma$ ) is restricted to ± 5%. The uncertainty is the RSS of the ConvF uncertainty for indicated target tissue parameters.

<sup>G</sup> Alpha/Depth are determined during calibration. SPEAG warrants that the remaining deviation due to the boundary effect after compensation is always less than ± 1% for frequencies below 3 GHz and below ± 2% for frequencies between 3-6 GHz at any distance larger than half the probe tip diameter from the boundary.



## DASY/EASY - Parameters of Probe: EX3DV4 - SN:3955

### Calibration Parameter Determined in Body Tissue Simulating Media

f (MHz) <sup>c</sup>	Relative Permittivity <sup>F</sup>	Conductivity (S/m) <sup>F</sup>	ConvF X	ConvF Y	ConvF Z	Alpha <sup>G</sup>	Depth (mm) <sup>G</sup>	Unc (k=2)
750	55.5	0.96	10.42	10.42	10.42	0.38	0.90	± 12.0 %
835	55.2	0.97	10.18	10.18	10.18	0.33	0.97	± 12.0 %
1750	53.4	1.49	8.31	8.31	8.31	0.46	0.80	± 12.0 %
1900	53.3	1.52	8.00	8.00	8.00	0.30	0.95	± 12.0 %
2450	52.7	1.95	7.65	7.65	7.65	0.39	0.80	± 12.0 %
2600	52.5	2.16	7.42	7.42	7.42	0.37	0.80	± 12.0 %
5250	48.9	5.36	4.51	4.51	4.51	0.50	1.90	± 13.1 %
5600	48.5	5.77	3.91	3.91	3.91	0.55	1.90	± 13.1 %
5750	48.3	5.94	4.12	4.12	4.12	0.55	1.90	± 13.1 %

<sup>c</sup> Frequency validity above 300 MHz of ± 100 MHz only applies for DASY v4.4 and higher (see Page 2), else it is restricted to ± 50 MHz. The uncertainty is the RSS of the ConvF uncertainty at calibration frequency and the uncertainty for the indicated frequency band. Frequency validity below 300 MHz is ± 10, 25, 40, 50 and 70 MHz for ConvF assessments at 30, 64, 128, 150 and 220 MHz respectively. Above 5 GHz frequency validity can be extended to ± 110 MHz.

<sup>F</sup> At frequencies below 3 GHz, the validity of tissue parameters ( $\epsilon$  and  $\sigma$ ) can be relaxed to ± 10% if liquid compensation formula is applied to measured SAR values. At frequencies above 3 GHz, the validity of tissue parameters ( $\epsilon$  and  $\sigma$ ) is restricted to ± 5%. The uncertainty is the RSS of the ConvF uncertainty for indicated target tissue parameters.

<sup>G</sup> Alpha/Depth are determined during calibration. SPEAG warrants that the remaining deviation due to the boundary effect after compensation is always less than ± 1% for frequencies below 3 GHz and below ± 2% for frequencies between 3-6 GHz at any distance larger than half the probe tip diameter from the boundary.

# Frequency Response of E-Field

(TEM-Cell:ifi110 EXX, Waveguide: R22)

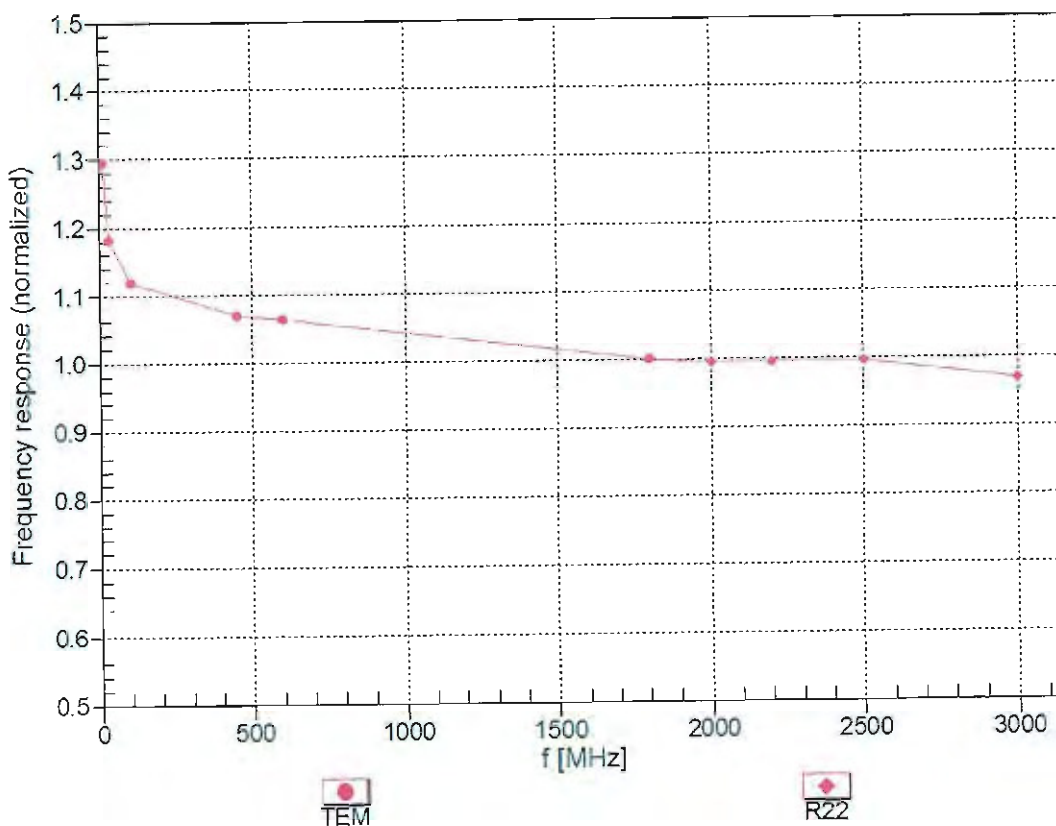

Uncertainty of Frequency Response of E-field:  $\pm 6.3\%$  (k=2)

### Receiving Pattern ( $\phi$ ), $\theta = 0^\circ$

f=600 MHz, TEM

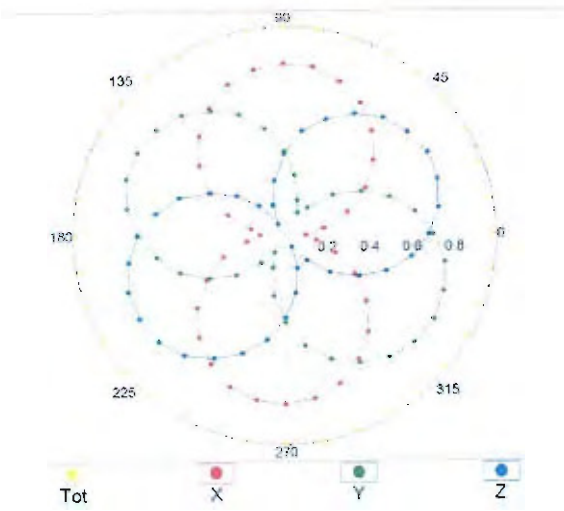

f=1800 MHz, R22

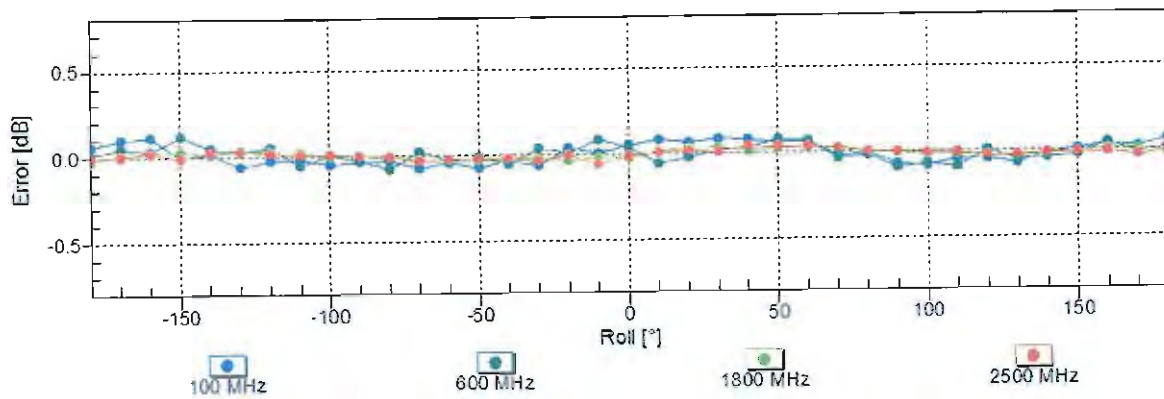
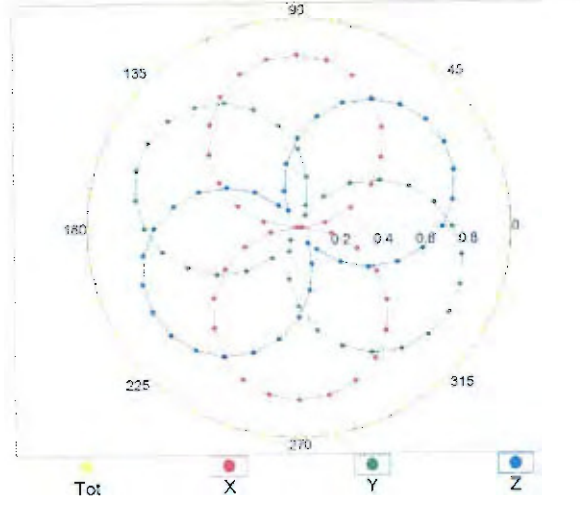

Uncertainty of Axial Isotropy Assessment:  $\pm 0.5\%$  ( $k=2$ )

### Dynamic Range f(SAR<sub>head</sub>) (TEM cell , f<sub>eval</sub>= 1900 MHz)

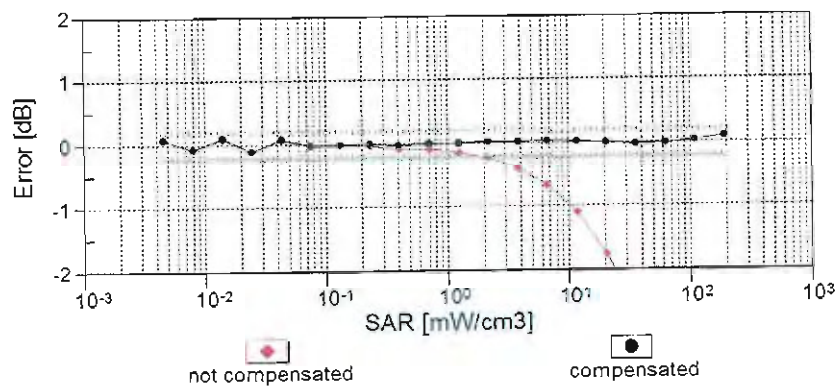
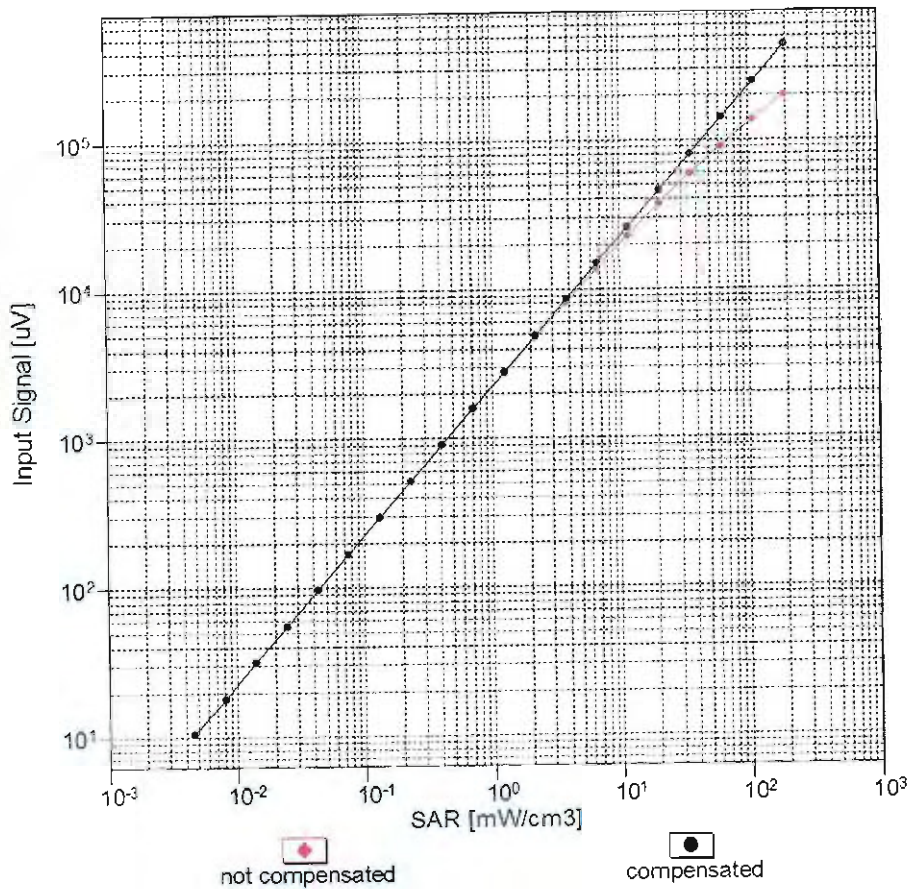

Uncertainty of Linearity Assessment: ± 0.6% (k=2)

# Conversion Factor Assessment

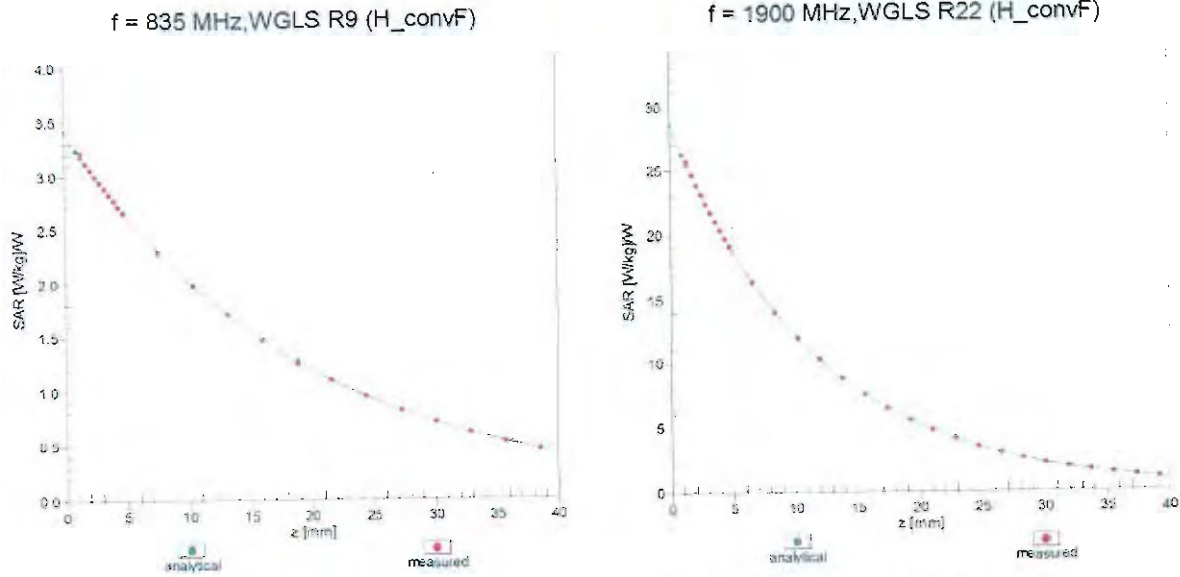

## Deviation from Isotropy in Liquid Error ( $\phi, \theta$ ), f = 900 MHz

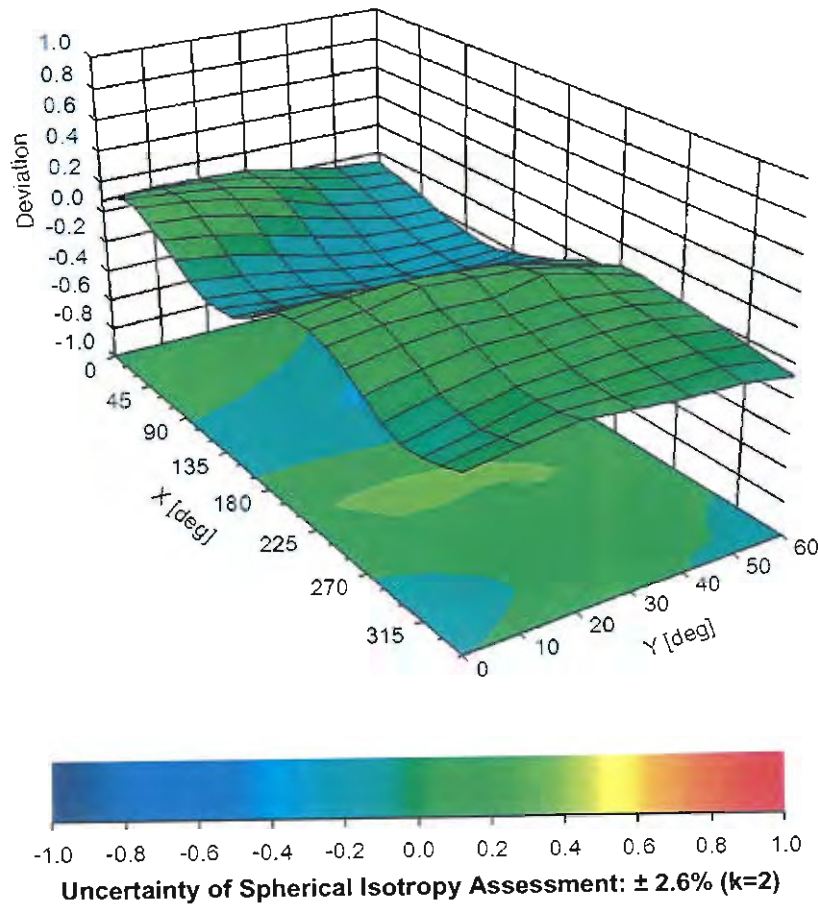

## DASY/EASY - Parameters of Probe: EX3DV4 - SN:3955

### Other Probe Parameters

Sensor Arrangement	Triangular
Connector Angle (°)	130.3
Mechanical Surface Detection Mode	enabled
Optical Surface Detection Mode	disabled
Probe Overall Length	337 mm
Probe Body Diameter	10 mm
Tip Length	9 mm
Tip Diameter	2.5 mm
Probe Tip to Sensor X Calibration Point	1 mm
Probe Tip to Sensor Y Calibration Point	1 mm
Probe Tip to Sensor Z Calibration Point	1 mm
Recommended Measurement Distance from Surface	1.4 mm



Add: No.51 Xueyuan Road, Haidian District, Beijing, 100191, China  
Tel: +86-10-62304633-2218 Fax: +86-10-62304633-2209  
E-mail: cttl@chinattl.com [Http://www.chinattl.cn](http://www.chinattl.cn)

Client **Sporton\_TW**

Certificate No: **Z16-97123**

## CALIBRATION CERTIFICATE

Object ES3DV3 - SN:3270

Calibration Procedure(s) FD-Z11-2-004-01  
Calibration Procedures for Dosimetric E-field Probes

Calibration date: August 26, 2016

This calibration Certificate documents the traceability to national standards, which realize the physical units of measurements(SI). The measurements and the uncertainties with confidence probability are given on the following pages and are part of the certificate.

All calibrations have been conducted in the closed laboratory facility: environment temperature(22±3)°C and humidity<70%.

Calibration Equipment used (M&TE critical for calibration)

Primary Standards	ID #	Cal Date(Calibrated by, Certificate No.)	Scheduled Calibration
Power Meter NRP2	101919	27-Jun-16 (CTTL, No.J16X04777)	Jun-17
Power sensor NRP-Z91	101547	27-Jun-16 (CTTL, No.J16X04777)	Jun-17
Power sensor NRP-Z91	101548	27-Jun-16 (CTTL, No.J16X04777)	Jun-17
Reference10dBAttenuator	18N50W-10dB	13-Mar-16(CTTL,No.J16X01547)	Mar-18
Reference20dBAttenuator	18N50W-20dB	13-Mar-16(CTTL, No.J16X01548)	Mar-18
Reference Probe EX3DV4	SN 7307	19-Feb-16(SPEAG,No.EX3-7307_Feb16)	Feb-17
DAE4	SN 1331	21-Jan-16(SPEAG, No.DAE4-1331_Jan16)	Jan -17
Secondary Standards	ID #	Cal Date(Calibrated by, Certificate No.)	Scheduled Calibration
SignalGeneratorMG3700A	6201052605	27-Jun-16 (CTTL, No.J16X04776)	Jun-17
Network Analyzer E5071C	MY46110673	26-Jan-16 (CTTL, No.J16X00894)	Jan -17

	Name	Function	Signature
Calibrated by:	Yu Zongying	SAR Test Engineer	
Reviewed by:	Qi Dianyuan	SAR Project Leader	
Approved by:	Lu Bingsong	Deputy Director of the laboratory	

Issued: August 27, 2016

This calibration certificate shall not be reproduced except in full without written approval of the laboratory.



## Glossary:

TSL	tissue simulating liquid
NORM <sub>x,y,z</sub>	sensitivity in free space
ConvF	sensitivity in TSL / NORM <sub>x,y,z</sub>
DCP	diode compression point
CF	crest factor (1/duty_cycle) of the RF signal
A,B,C,D	modulation dependent linearization parameters
Polarization $\Phi$	$\Phi$ rotation around probe axis
Polarization $\theta$	$\theta$ rotation around an axis that is in the plane normal to probe axis (at measurement center), $i$ $\theta=0$ is normal to probe axis

Connector Angle information used in DASY system to align probe sensor X to the robot coordinate system

## Calibration is Performed According to the Following Standards:

- IEEE Std 1528-2013, "IEEE Recommended Practice for Determining the Peak Spatial-Averaged Specific Absorption Rate (SAR) in the Human Head from Wireless Communications Devices: Measurement Techniques", June 2013
- IEC 62209-1, "Procedure to measure the Specific Absorption Rate (SAR) for hand-held devices used in close proximity to the ear (frequency range of 300MHz to 3GHz)", February 2005
- IEC 62209-2, "Procedure to determine the Specific Absorption Rate (SAR) for wireless communication devices used in close proximity to the human body (frequency range of 30 MHz to 6 GHz)", March 2010
- KDB 865664, "SAR Measurement Requirements for 100 MHz to 6 GHz"

## Methods Applied and Interpretation of Parameters:

- NORM<sub>x,y,z</sub>**: Assessed for E-field polarization  $\theta=0$  ( $f \leq 900\text{MHz}$  in TEM-cell;  $f > 1800\text{MHz}$ : waveguide). NORM<sub>x,y,z</sub> are only intermediate values, i.e., the uncertainties of NORM<sub>x,y,z</sub> does not effect the  $E^2$ -field uncertainty inside TSL (see below ConvF).
- NORM(f)<sub>x,y,z</sub>** = NORM<sub>x,y,z</sub> \* frequency\_response (see Frequency Response Chart). This linearization is implemented in DASY4 software versions later than 4.2. The uncertainty of the frequency response is included in the stated uncertainty of ConvF.
- DCP<sub>x,y,z</sub>**: DCP are numerical linearization parameters assessed based on the data of power sweep (no uncertainty required). DCP does not depend on frequency nor media.
- PAR**: PAR is the Peak to Average Ratio that is not calibrated but determined based on the signal characteristics.
- A<sub>x,y,z</sub>; B<sub>x,y,z</sub>; C<sub>x,y,z</sub>; VR<sub>x,y,z</sub>; A,B,C** are numerical linearization parameters assessed based on the data of power sweep for specific modulation signal. The parameters do not depend on frequency nor media. VR is the maximum calibration range expressed in RMS voltage across the diode.
- ConvF and Boundary Effect Parameters**: Assessed in flat phantom using E-field (or Temperature Transfer Standard for  $f \leq 800\text{MHz}$ ) and inside waveguide using analytical field distributions based on power measurements for  $f > 800\text{MHz}$ . The same setups are used for assessment of the parameters applied for boundary compensation (alpha, depth) of which typical uncertainty valued are given. These parameters are used in DASY4 software to improve probe accuracy close to the boundary. The sensitivity in TSL corresponds to NORM<sub>x,y,z</sub> \* ConvF whereby the uncertainty corresponds to that given for ConvF. A frequency dependent ConvF is used in DASY version 4.4 and higher which allows extending the validity from  $\pm 50\text{MHz}$  to  $\pm 100\text{MHz}$ .
- Spherical isotropy (3D deviation from isotropy)**: in a field of low gradients realized using a flat phantom exposed by a patch antenna.
- Sensor Offset**: The sensor offset corresponds to the offset of virtual measurement center from the probe tip (on probe axis). No tolerance required.
- Connector Angle**: The angle is assessed using the information gained by determining the NORM<sub>x</sub> (no uncertainty required).





In Collaboration with

**s p e a q**

**CALIBRATION LABORATORY**

Add: No.51 Xueyuan Road, Haidian District, Beijing, 100191, China

Tel: +86-10-62304633-2218

Fax: +86-10-62304633-2209

E-mail: [cttl@chinattl.com](mailto:cttl@chinattl.com)

[Http://www.chinattl.cn](http://www.chinattl.cn)

# Probe ES3DV3

## SN: 3270

Calibrated: August 26, 2016

Calibrated for DASY/EASY Systems

(Note: non-compatible with DASY2 system!)



## DASY/EASY – Parameters of Probe: ES3DV3 - SN: 3270

### Basic Calibration Parameters

	Sensor X	Sensor Y	Sensor Z	Unc (k=2)
Norm( $\mu\text{V}/(\text{V}/\text{m})^2$ ) <sup>A</sup>	1.09	1.22	1.19	±10.8%
DCP(mV) <sup>B</sup>	100.9	103.3	101.0	

### Modulation Calibration Parameters

UID	Communication System Name		A dB	B dB/ $\mu\text{V}$	C	D dB	VR mV	Unc <sup>E</sup> (k=2)
0	CW	X	0.0	0.0	1.0	0.00	274.7	±2.7%
		Y	0.0	0.0	1.0		295.4	
		Z	0.0	0.0	1.0		288.4	

The reported uncertainty of measurement is stated as the standard uncertainty of Measurement multiplied by the coverage factor k=2, which for a normal distribution Corresponds to a coverage probability of approximately 95%.

<sup>A</sup> The uncertainties of Norm X, Y, Z do not affect the E<sup>2</sup>-field uncertainty inside TSL (see Page 5 and Page 6).

<sup>B</sup> Numerical linearization parameter: uncertainty not required.

<sup>E</sup> Uncertainty is determined using the max. deviation from linear response applying rectangular distribution and is expressed for the square of the field value.



## DASY/EASY – Parameters of Probe: ES3DV3 - SN: 3270

### Calibration Parameter Determined in Head Tissue Simulating Media

f [MHz] <sup>C</sup>	Relative Permittivity <sup>F</sup>	Conductivity (S/m) <sup>F</sup>	ConvF X	ConvF Y	ConvF Z	Alpha <sup>G</sup>	Depth <sup>G</sup> (mm)	Unct. (k=2)
750	41.9	0.89	6.19	6.19	6.19	0.50	1.35	± 12%
835	41.5	0.90	6.03	6.03	6.03	0.42	1.47	± 12%
900	41.5	0.97	6.09	6.09	6.09	0.37	1.61	± 12%
1750	40.1	1.37	5.21	5.21	5.21	0.52	1.53	± 12%
1900	40.0	1.40	5.08	5.08	5.08	0.55	1.50	± 12%
2000	40.0	1.40	4.98	4.98	4.98	0.57	1.47	± 12%
2100	39.8	1.49	5.02	5.02	5.02	0.68	1.41	± 12%
2450	39.2	1.80	4.51	4.51	4.51	0.73	1.30	± 12%
2600	39.0	1.96	4.37	4.37	4.37	0.90	1.13	± 12%

<sup>C</sup> Frequency validity above 300 MHz of ±100MHz only applies for DASY v4.4 and higher (Page 2), else it is restricted to ±50MHz. The uncertainty is the RSS of ConvF uncertainty at calibration frequency and the uncertainty for the indicated frequency band. Frequency validity below 300 MHz is ± 10, 25, 40, 50 and 70 MHz for ConvF assessments at 30, 64, 128, 150 and 220 MHz respectively. Above 5 GHz frequency validity can be extended to ± 110 MHz.

<sup>F</sup> At frequency below 3 GHz, the validity of tissue parameters ( $\epsilon$  and  $\sigma$ ) can be relaxed to ±10% if liquid compensation formula is applied to measured SAR values. At frequencies above 3 GHz, the validity of tissue parameters ( $\epsilon$  and  $\sigma$ ) is restricted to ±5%. The uncertainty is the RSS of the ConvF uncertainty for indicated target tissue parameters.

<sup>G</sup> Alpha/Depth are determined during calibration. SPEAG warrants that the remaining deviation due to the boundary effect after compensation is always less than ± 1% for frequencies below 3 GHz and below ± 2% for the frequencies between 3-6 GHz at any distance larger than half the probe tip diameter from the boundary.



## DASY/EASY – Parameters of Probe: ES3DV3 - SN: 3270

### Calibration Parameter Determined in Body Tissue Simulating Media

f [MHz] <sup>C</sup>	Relative Permittivity <sup>F</sup>	Conductivity (S/m) <sup>F</sup>	ConvF X	ConvF Y	ConvF Z	Alpha <sup>G</sup>	Depth <sup>G</sup> (mm)	Unct. (k=2)
750	55.5	0.96	6.09	6.09	6.09	0.50	1.35	± 12%
835	55.2	0.97	6.01	6.01	6.01	0.42	1.60	± 12%
1750	53.4	1.49	4.95	4.95	4.95	0.50	1.66	± 12%
1900	53.3	1.52	4.70	4.70	4.70	0.53	1.64	± 12%
2450	52.7	1.95	4.28	4.28	4.28	0.90	1.20	± 12%
2600	52.5	2.16	4.12	4.12	4.12	0.90	1.18	± 12%

<sup>C</sup> Frequency validity above 300 MHz of ±100MHz only applies for DASY v4.4 and higher (Page 2), else it is restricted to ±50MHz. The uncertainty is the RSS of ConvF uncertainty at calibration frequency and the uncertainty for the indicated frequency band. Frequency validity below 300 MHz is ± 10, 25, 40, 50 and 70 MHz for ConvF assessments at 30, 64, 128, 150 and 220 MHz respectively. Above 5 GHz frequency validity can be extended to ± 110 MHz.

<sup>F</sup> At frequency below 3 GHz, the validity of tissue parameters ( $\epsilon$  and  $\sigma$ ) can be relaxed to ±10% if liquid compensation formula is applied to measured SAR values. At frequencies above 3 GHz, the validity of tissue parameters ( $\epsilon$  and  $\sigma$ ) is restricted to ±5%. The uncertainty is the RSS of the ConvF uncertainty for indicated target tissue parameters.

<sup>G</sup> Alpha/Depth are determined during calibration. SPEAG warrants that the remaining deviation due to the boundary effect after compensation is always less than ± 1% for frequencies below 3 GHz and below ± 2% for the frequencies between 3-6 GHz at any distance larger than half the probe tip diameter from the boundary.



Add: No.51 Xueyuan Road, Haidian District, Beijing, 100191, China  
Tel: +86-10-62304633-2218 Fax: +86-10-62304633-2209  
E-mail: [ctl@chinattl.com](mailto:ctl@chinattl.com) [Http://www.chinattl.cn](http://www.chinattl.cn)

## Frequency Response of E-Field (TEM-Cell: ifi110 EXX, Waveguide: R22)

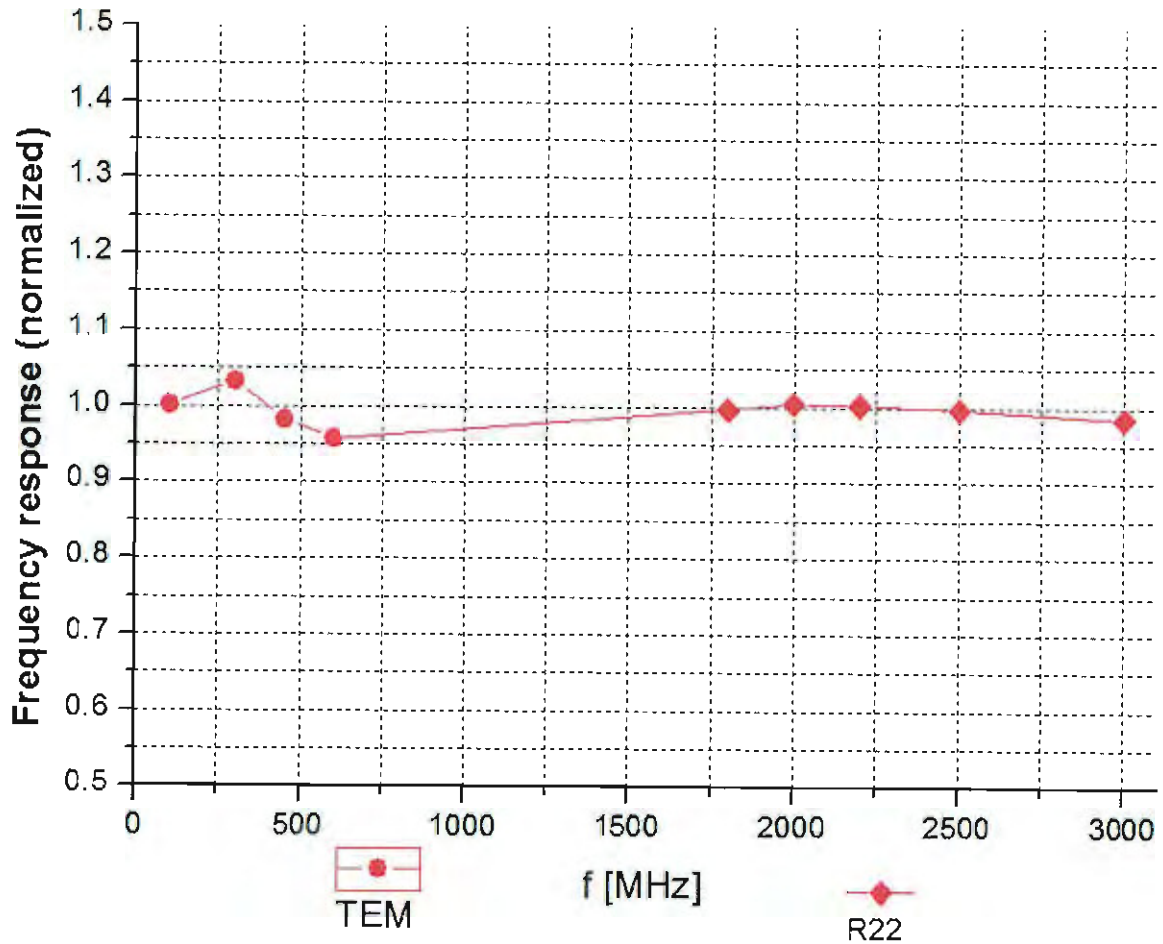

Uncertainty of Frequency Response of E-field:  $\pm 7.5\%$  (k=2)



Add: No.51 Xueyuan Road, Haidian District, Beijing, 100191, China  
Tel: +86-10-62304633-2218 Fax: +86-10-62304633-2209  
E-mail: cttl@chinattl.com [Http://www.chinattl.cn](http://www.chinattl.cn)

## Receiving Pattern ( $\Phi$ ), $\theta=0^\circ$

**f=600 MHz, TEM**

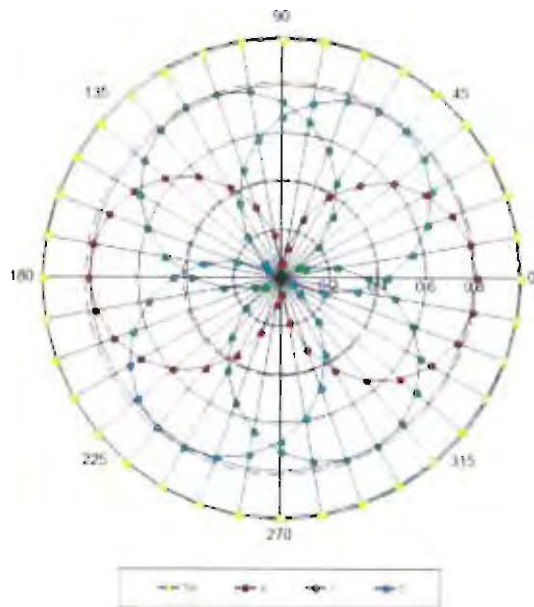

**f=1800 MHz, R22**

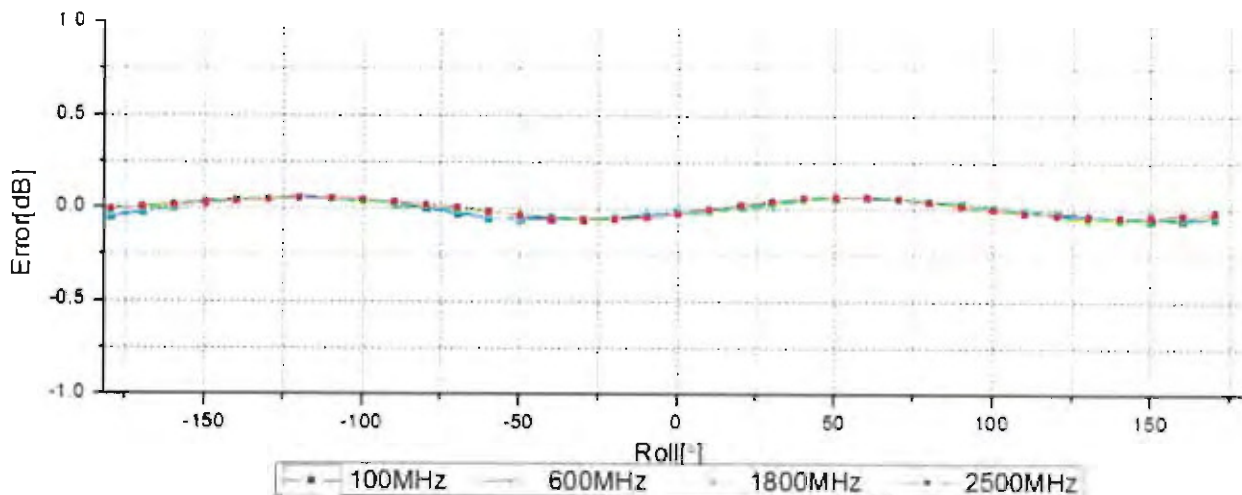
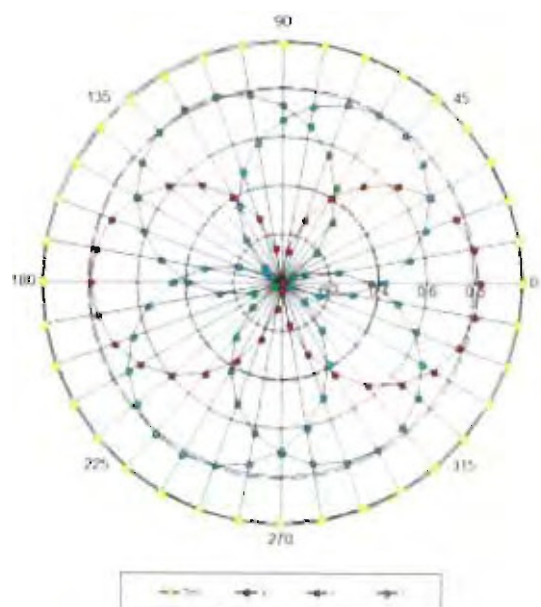

Uncertainty of Axial Isotropy Assessment:  $\pm 0.9\%$  (k=2)



Add: No.51 Xueyuan Road, Haidian District, Beijing, 100191, China  
Tel: +86-10-62304633-2218 Fax: +86-10-62304633-2209  
E-mail: cttl@chinattl.com [Http://www.chinattl.cn](http://www.chinattl.cn)

## Dynamic Range f(SAR<sub>head</sub>) (TEM cell, f = 900 MHz)

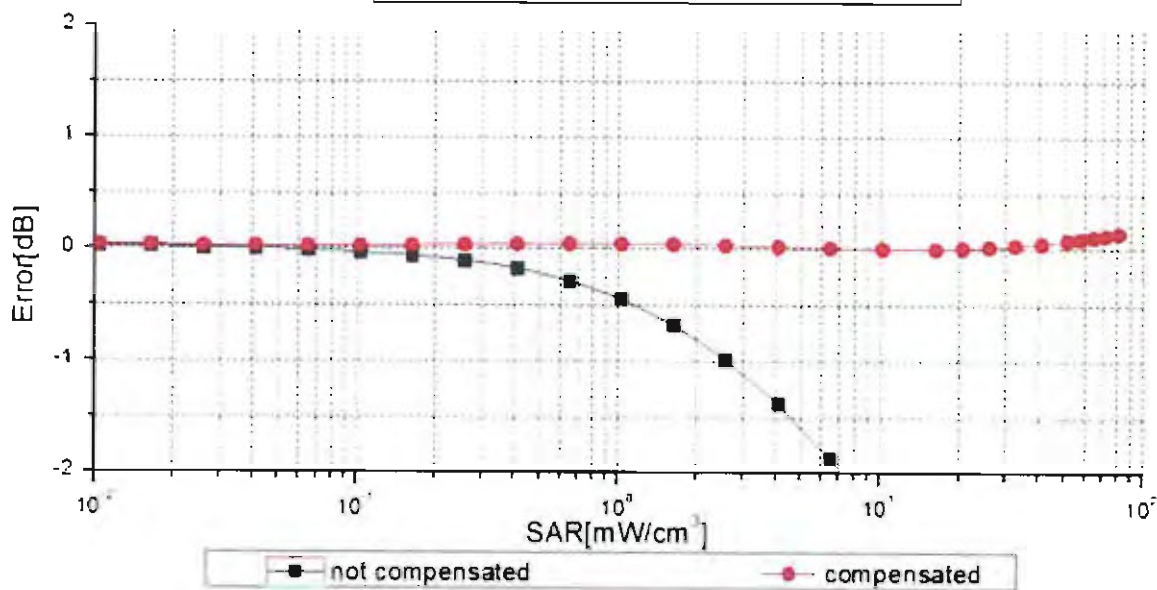
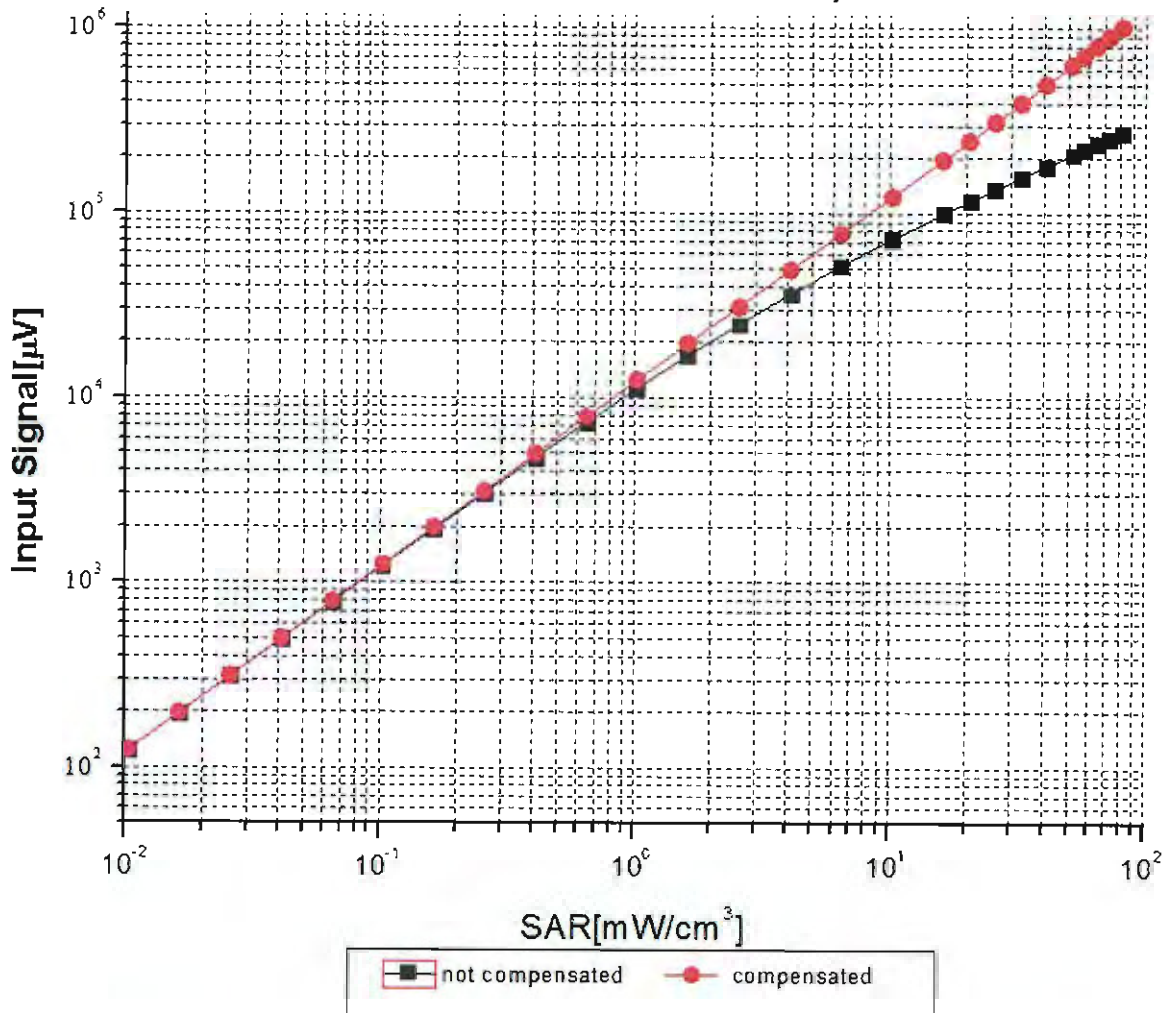

Uncertainty of Linearity Assessment:  $\pm 0.9\%$  (k=2)

## Conversion Factor Assessment

f=900 MHz, WGLS R9(H\_convF)

f=1750 MHz, WGLS R22(H\_convF)

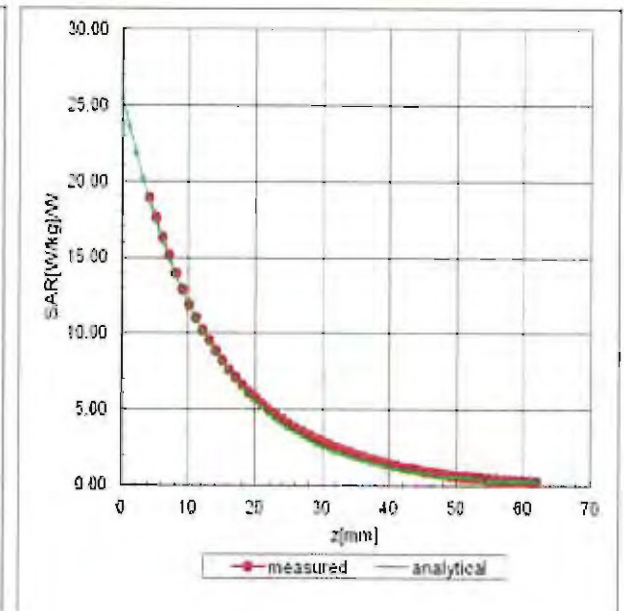
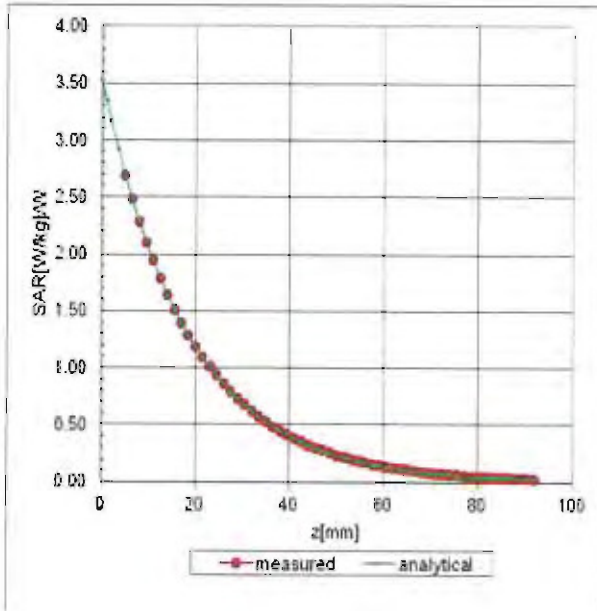

## Deviation from Isotropy in Liquid

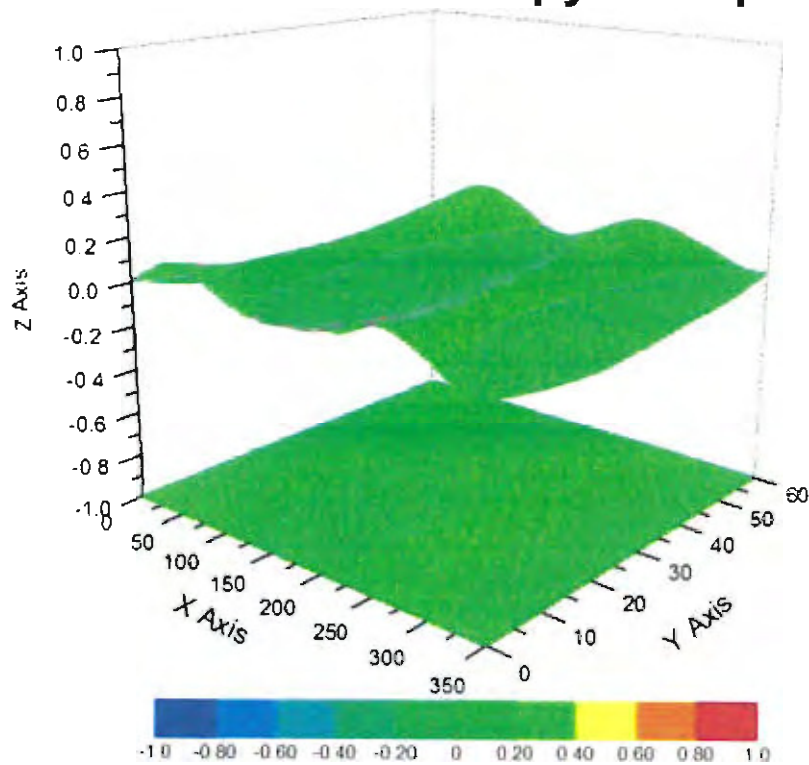

Uncertainty of Spherical Isotropy Assessment:  $\pm 2.8\%$  (K=2)





## DASY/EASY – Parameters of Probe: ES3DV3 - SN: 3270

### Other Probe Parameters

<b>Sensor Arrangement</b>	<b>Triangular</b>
<b>Connector Angle (°)</b>	<b>168.9</b>
<b>Mechanical Surface Detection Mode</b>	<b>enabled</b>
<b>Optical Surface Detection Mode</b>	<b>disable</b>
<b>Probe Overall Length</b>	<b>337mm</b>
<b>Probe Body Diameter</b>	<b>10mm</b>
<b>Tip Length</b>	<b>10mm</b>
<b>Tip Diameter</b>	<b>4mm</b>
<b>Probe Tip to Sensor X Calibration Point</b>	<b>2mm</b>
<b>Probe Tip to Sensor Y Calibration Point</b>	<b>2mm</b>
<b>Probe Tip to Sensor Z Calibration Point</b>	<b>2mm</b>
<b>Recommended Measurement Distance from Surface</b>	<b>3mm</b>



Accreditation No.: **SCS 0108**

Accredited by the Swiss Accreditation Service (SAS)  
The Swiss Accreditation Service is one of the signatories to the EA  
Multilateral Agreement for the recognition of calibration certificates

Client **Sporton-TW (Auden)**

Certificate No: **EX3-3931\_Oct16**

## CALIBRATION CERTIFICATE

Object **EX3DV4 - SN:3931**

Calibration procedure(s) **QA CAL-01.v9, QA CAL-14.v4, QA CAL-23.v5, QA CAL-25.v6**  
Calibration procedure for dosimetric E-field probes

Calibration date: **October 3, 2016**

This calibration certificate documents the traceability to national standards, which realize the physical units of measurements (SI).  
The measurements and the uncertainties with confidence probability are given on the following pages and are part of the certificate.

All calibrations have been conducted in the closed laboratory facility: environment temperature  $(22 \pm 3)^\circ\text{C}$  and humidity < 70%.

Calibration Equipment used (M&TE critical for calibration)

Primary Standards	ID	Cal Date (Certificate No.)	Scheduled Calibration
Power meter NRP	SN: 104778	06-Apr-16 (No. 217-02288/02289)	Apr-17
Power sensor NRP-Z91	SN: 103244	06-Apr-16 (No. 217-02288)	Apr-17
Power sensor NRP-Z91	SN: 103245	06-Apr-16 (No. 217-02289)	Apr-17
Reference 20 dB Attenuator	SN: S5277 (20x)	05-Apr-16 (No. 217-02293)	Apr-17
Reference Probe ES3DV2	SN: 3013	31-Dec-15 (No. ES3-3013_Dec15)	Dec-16
DAE4	SN: 660	23-Dec-15 (No. DAE4-660_Dec15)	Dec-16
Secondary Standards	ID	Check Date (in house)	Scheduled Check
Power meter E4419B	SN: GB41293874	06-Apr-16 (in house check Jun-16)	In house check: Jun-18
Power sensor E4412A	SN: MY41498087	06-Apr-16 (in house check Jun-16)	In house check: Jun-18
Power sensor E4412A	SN: 000110210	06-Apr-16 (in house check Jun-16)	In house check: Jun-18
RF generator HP 8648C	SN: US3642U01700	04-Aug-99 (in house check Jun-16)	In house check: Jun-18
Network Analyzer HP 8753E	SN: US37390585	18-Oct-01 (in house check Oct-15)	In house check: Oct-16

	Name	Function	Signature
Calibrated by:	Michael Weber	Laboratory Technician	
Approved by:	Katja Pokovic	Technical Manager	
			Issued: October 4, 2016
This calibration certificate shall not be reproduced except in full without written approval of the laboratory.			



Accredited by the Swiss Accreditation Service (SAS)

The Swiss Accreditation Service is one of the signatories to the EA  
Multilateral Agreement for the recognition of calibration certificates

Accreditation No.: **SCS 0108**

### Glossary:

TSL	tissue simulating liquid
NORM <sub>x,y,z</sub>	sensitivity in free space
ConvF	sensitivity in TSL / NORM <sub>x,y,z</sub>
DCP	diode compression point
CF	crest factor (1/duty_cycle) of the RF signal
A, B, C, D	modulation dependent linearization parameters
Polarization $\varphi$	$\varphi$ rotation around probe axis
Polarization $\vartheta$	$\vartheta$ rotation around an axis that is in the plane normal to probe axis (at measurement center), i.e., $\vartheta = 0$ is normal to probe axis
Connector Angle	information used in DASY system to align probe sensor X to the robot coordinate system

### Calibration is Performed According to the Following Standards:

- IEEE Std 1528-2013, "IEEE Recommended Practice for Determining the Peak Spatial-Averaged Specific Absorption Rate (SAR) in the Human Head from Wireless Communications Devices: Measurement Techniques", June 2013
- IEC 62209-1, "Procedure to measure the Specific Absorption Rate (SAR) for hand-held devices used in close proximity to the ear (frequency range of 300 MHz to 3 GHz)", February 2005
- IEC 62209-2, "Procedure to determine the Specific Absorption Rate (SAR) for wireless communication devices used in close proximity to the human body (frequency range of 30 MHz to 6 GHz)", March 2010
- KDB 865664, "SAR Measurement Requirements for 100 MHz to 6 GHz"

### Methods Applied and Interpretation of Parameters:

- NORM<sub>x,y,z</sub>**: Assessed for E-field polarization  $\vartheta = 0$  ( $f \leq 900$  MHz in TEM-cell;  $f > 1800$  MHz: R22 waveguide). NORM<sub>x,y,z</sub> are only intermediate values, i.e., the uncertainties of NORM<sub>x,y,z</sub> does not affect the E<sup>2</sup>-field uncertainty inside TSL (see below ConvF).
- NORM(f)<sub>x,y,z</sub> = NORM<sub>x,y,z</sub> \* frequency\_response** (see Frequency Response Chart). This linearization is implemented in DASY4 software versions later than 4.2. The uncertainty of the frequency response is included in the stated uncertainty of ConvF.
- DCP<sub>x,y,z</sub>**: DCP are numerical linearization parameters assessed based on the data of power sweep with CW signal (no uncertainty required). DCP does not depend on frequency nor media.
- PAR**: PAR is the Peak to Average Ratio that is not calibrated but determined based on the signal characteristics
- A<sub>x,y,z</sub>; B<sub>x,y,z</sub>; C<sub>x,y,z</sub>; D<sub>x,y,z</sub>; VR<sub>x,y,z</sub>**: A, B, C, D are numerical linearization parameters assessed based on the data of power sweep for specific modulation signal. The parameters do not depend on frequency nor media. VR is the maximum calibration range expressed in RMS voltage across the diode.
- ConvF and Boundary Effect Parameters**: Assessed in flat phantom using E-field (or Temperature Transfer Standard for  $f \leq 800$  MHz) and inside waveguide using analytical field distributions based on power measurements for  $f > 800$  MHz. The same setups are used for assessment of the parameters applied for boundary compensation (alpha, depth) of which typical uncertainty values are given. These parameters are used in DASY4 software to improve probe accuracy close to the boundary. The sensitivity in TSL corresponds to NORM<sub>x,y,z</sub> \* ConvF whereby the uncertainty corresponds to that given for ConvF. A frequency dependent ConvF is used in DASY version 4.4 and higher which allows extending the validity from  $\pm 50$  MHz to  $\pm 100$  MHz.
- Spherical isotropy (3D deviation from isotropy)**: in a field of low gradients realized using a flat phantom exposed by a patch antenna.
- Sensor Offset**: The sensor offset corresponds to the offset of virtual measurement center from the probe tip (on probe axis). No tolerance required.
- Connector Angle**: The angle is assessed using the information gained by determining the NORM<sub>x</sub> (no uncertainty required).

# Probe EX3DV4

## SN:3931

Manufactured:	July 24, 2013
Repaired:	September 27, 2016
Calibrated:	October 3, 2016

**Calibrated for DASYS/EASY Systems**  
(Note: non-compatible with DASYS2 system!)

## DASY/EASY - Parameters of Probe: EX3DV4 - SN:3931

### Basic Calibration Parameters

	Sensor X	Sensor Y	Sensor Z	Unc (k=2)
Norm ( $\mu\text{V}/(\text{V}/\text{m})^2$ ) <sup>A</sup>	0.50	0.56	0.47	$\pm 10.1 \%$
DCP (mV) <sup>B</sup>	99.3	102.3	99.2	

### Modulation Calibration Parameters

UID	Communication System Name		A dB	B dB $\sqrt{\mu\text{V}}$	C	D dB	VR mV	Unc <sup>E</sup> (k=2)
0	CW	X	0.0	0.0	1.0	0.00	165.2	$\pm 2.2 \%$
		Y	0.0	0.0	1.0		169.6	
		Z	0.0	0.0	1.0		158.4	

Note: For details on UID parameters see Appendix.

### Sensor Model Parameters

	C1 fF	C2 fF	$\alpha$ $\text{V}^{-1}$	T1 $\text{ms}\cdot\text{V}^{-2}$	T2 $\text{ms}\cdot\text{V}^{-1}$	T3 ms	T4 $\text{V}^{-2}$	T5 $\text{V}^{-1}$	T6
X	39.73	299.4	36.38	13.81	1.099	5.004	0.119	0.351	1.005
Y	59.82	447.7	35.85	21.83	1.546	5.045	0.719	0.472	1.007
Z	54.23	405.8	35.74	19.34	1.491	5.007	0.433	0.514	1.005

The reported uncertainty of measurement is stated as the standard uncertainty of measurement multiplied by the coverage factor  $k=2$ , which for a normal distribution corresponds to a coverage probability of approximately 95%.

<sup>A</sup> The uncertainties of Norm X,Y,Z do not affect the  $E^2$ -field uncertainty inside TSL (see Pages 5 and 6).

<sup>B</sup> Numerical linearization parameter: uncertainty not required.

<sup>E</sup> Uncertainty is determined using the max. deviation from linear response applying rectangular distribution and is expressed for the square of the field value.

## DASY/EASY - Parameters of Probe: EX3DV4 - SN:3931

### Calibration Parameter Determined in Head Tissue Simulating Media

f (MHz) <sup>C</sup>	Relative Permittivity <sup>F</sup>	Conductivity (S/m) <sup>F</sup>	ConvF X	ConvF Y	ConvF Z	Alpha <sup>G</sup>	Depth <sup>G</sup> (mm)	Unc (k=2)
750	41.9	0.89	10.68	10.68	10.68	0.47	0.86	± 12.0 %
835	41.5	0.90	10.35	10.35	10.35	0.43	0.80	± 12.0 %
900	41.5	0.97	10.09	10.09	10.09	0.44	0.86	± 12.0 %
1450	40.5	1.20	8.73	8.73	8.73	0.45	0.80	± 12.0 %
1750	40.1	1.37	8.68	8.68	8.68	0.37	0.80	± 12.0 %
1900	40.0	1.40	8.42	8.42	8.42	0.34	0.80	± 12.0 %
2000	40.0	1.40	8.43	8.43	8.43	0.37	0.80	± 12.0 %
2300	39.5	1.67	7.94	7.94	7.94	0.28	0.86	± 12.0 %
2450	39.2	1.80	7.60	7.60	7.60	0.36	0.84	± 12.0 %
2600	39.0	1.96	7.37	7.37	7.37	0.31	0.97	± 12.0 %
5250	35.9	4.71	5.38	5.38	5.38	0.35	1.80	± 13.1 %
5600	35.5	5.07	4.68	4.68	4.68	0.40	1.80	± 13.1 %
5750	35.4	5.22	4.84	4.84	4.84	0.40	1.80	± 13.1 %

<sup>C</sup> Frequency validity above 300 MHz of ± 100 MHz only applies for DASY v4.4 and higher (see Page 2), else it is restricted to ± 50 MHz. The uncertainty is the RSS of the ConvF uncertainty at calibration frequency and the uncertainty for the indicated frequency band. Frequency validity below 300 MHz is ± 10, 25, 40, 50 and 70 MHz for ConvF assessments at 30, 64, 128, 150 and 220 MHz respectively. Above 5 GHz frequency validity can be extended to ± 110 MHz.

<sup>F</sup> At frequencies below 3 GHz, the validity of tissue parameters ( $\epsilon$  and  $\sigma$ ) can be relaxed to ± 10% if liquid compensation formula is applied to measured SAR values. At frequencies above 3 GHz, the validity of tissue parameters ( $\epsilon$  and  $\sigma$ ) is restricted to ± 5%. The uncertainty is the RSS of the ConvF uncertainty for indicated target tissue parameters.

<sup>G</sup> Alpha/Depth are determined during calibration. SPEAG warrants that the remaining deviation due to the boundary effect after compensation is always less than ± 1% for frequencies below 3 GHz and below ± 2% for frequencies between 3-6 GHz at any distance larger than half the probe tip diameter from the boundary.

## DASY/EASY - Parameters of Probe: EX3DV4 - SN:3931

### Calibration Parameter Determined in Body Tissue Simulating Media

f (MHz) <sup>C</sup>	Relative Permittivity <sup>F</sup>	Conductivity (S/m) <sup>F</sup>	ConvF X	ConvF Y	ConvF Z	Alpha <sup>G</sup>	Depth <sup>G</sup> (mm)	Unc (k=2)
750	55.5	0.96	10.37	10.37	10.37	0.38	0.97	± 12.0 %
835	55.2	0.97	10.14	10.14	10.14	0.36	0.99	± 12.0 %
1450	54.0	1.30	8.53	8.53	8.53	0.31	0.80	± 12.0 %
1750	53.4	1.49	8.45	8.45	8.45	0.37	0.80	± 12.0 %
1900	53.3	1.52	8.14	8.14	8.14	0.33	0.90	± 12.0 %
2300	52.9	1.81	7.96	7.96	7.96	0.39	0.80	± 12.0 %
2450	52.7	1.95	7.73	7.73	7.73	0.38	0.85	± 12.0 %
2600	52.5	2.16	7.46	7.46	7.46	0.25	0.95	± 12.0 %
5250	48.9	5.36	4.57	4.57	4.57	0.50	1.90	± 13.1 %
5600	48.5	5.77	3.71	3.71	3.71	0.60	1.90	± 13.1 %
5750	48.3	5.94	4.01	4.01	4.01	0.60	1.90	± 13.1 %

<sup>C</sup> Frequency validity above 300 MHz of ± 100 MHz only applies for DASY v4.4 and higher (see Page 2), else it is restricted to ± 50 MHz. The uncertainty is the RSS of the ConvF uncertainty at calibration frequency and the uncertainty for the indicated frequency band. Frequency validity below 300 MHz is ± 10, 25, 40, 50 and 70 MHz for ConvF assessments at 30, 64, 128, 150 and 220 MHz respectively. Above 5 GHz frequency validity can be extended to ± 110 MHz.

<sup>F</sup> At frequencies below 3 GHz, the validity of tissue parameters ( $\epsilon$  and  $\sigma$ ) can be relaxed to ± 10% if liquid compensation formula is applied to measured SAR values. At frequencies above 3 GHz, the validity of tissue parameters ( $\epsilon$  and  $\sigma$ ) is restricted to ± 5%. The uncertainty is the RSS of the ConvF uncertainty for indicated target tissue parameters.

<sup>G</sup> Alpha/Depth are determined during calibration. SPEAG warrants that the remaining deviation due to the boundary effect after compensation is always less than ± 1% for frequencies below 3 GHz and below ± 2% for frequencies between 3-6 GHz at any distance larger than half the probe tip diameter from the boundary.

### Frequency Response of E-Field (TEM-Cell: ifi110 EXX, Waveguide: R22)

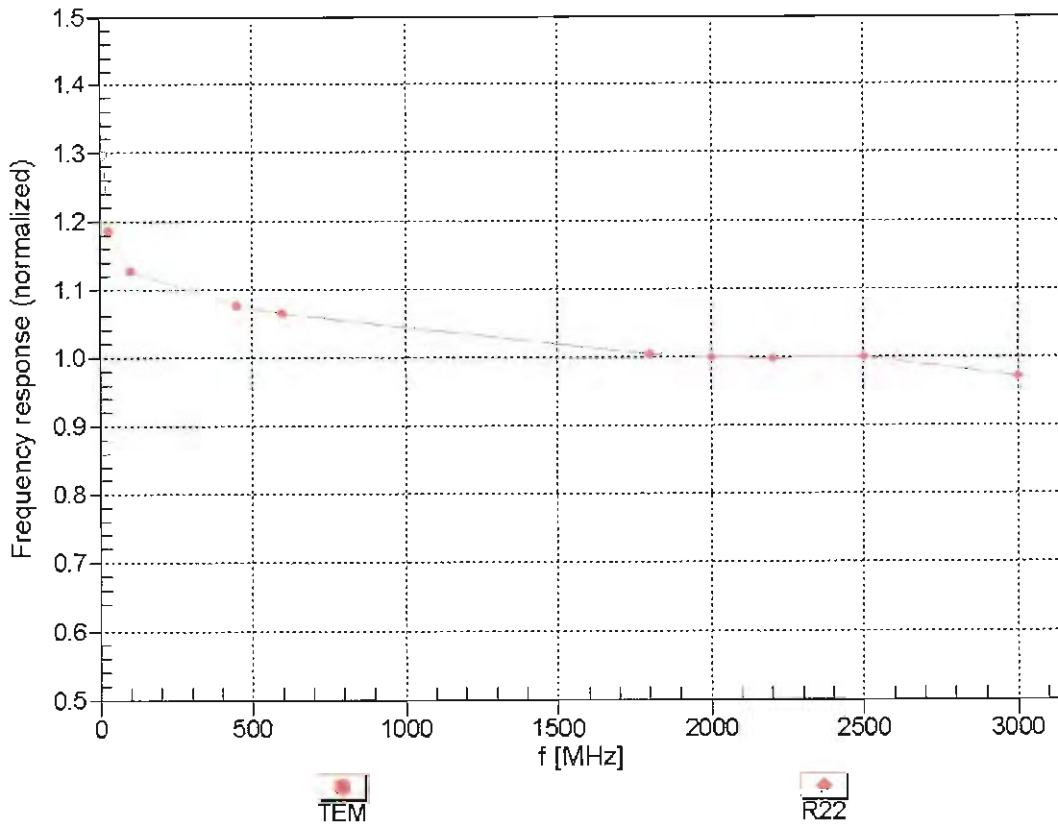

Uncertainty of Frequency Response of E-field:  $\pm 6.3\%$  ( $k=2$ )



### Receiving Pattern ( $\phi$ ), $\theta = 0^\circ$

f=600 MHz,TEM

f=1800 MHz,R22

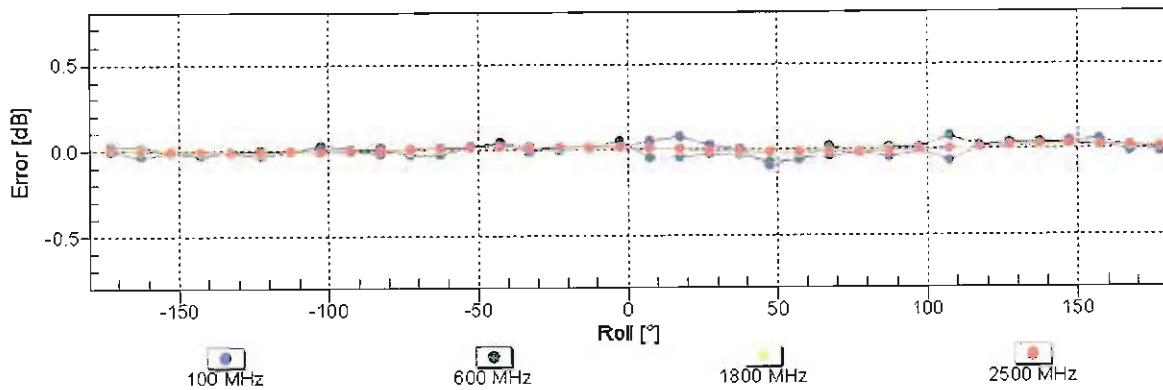
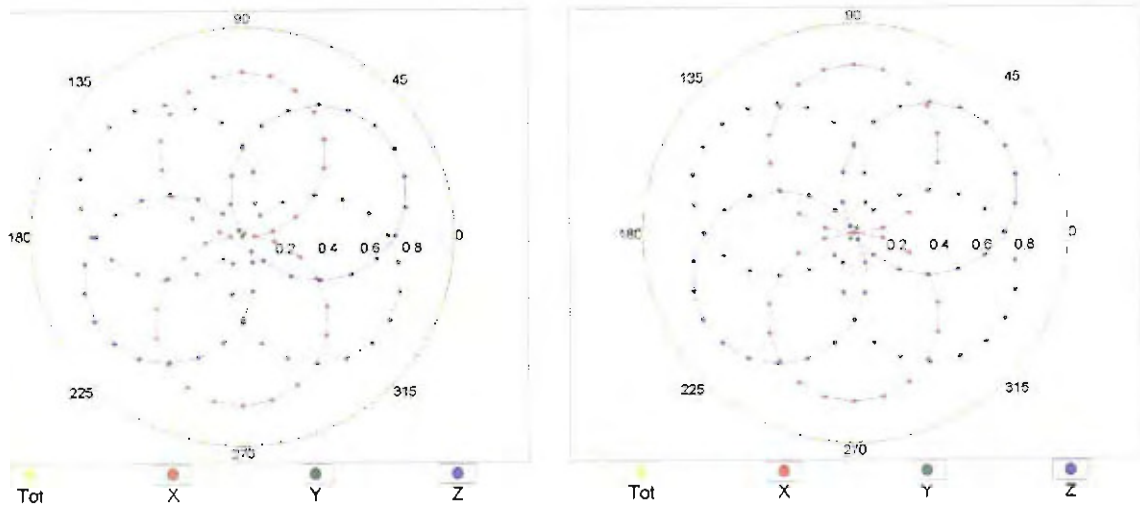

Uncertainty of Axial Isotropy Assessment:  $\pm 0.5\%$  ( $k=2$ )

### Dynamic Range $f(SAR_{head})$ (TEM cell , $f_{eval} = 1900$ MHz)

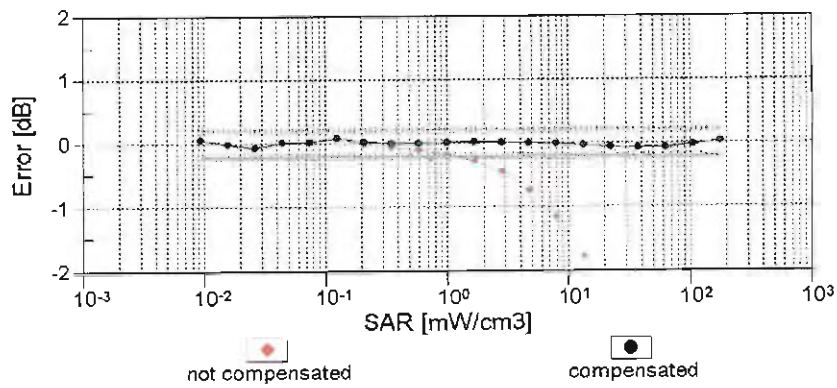
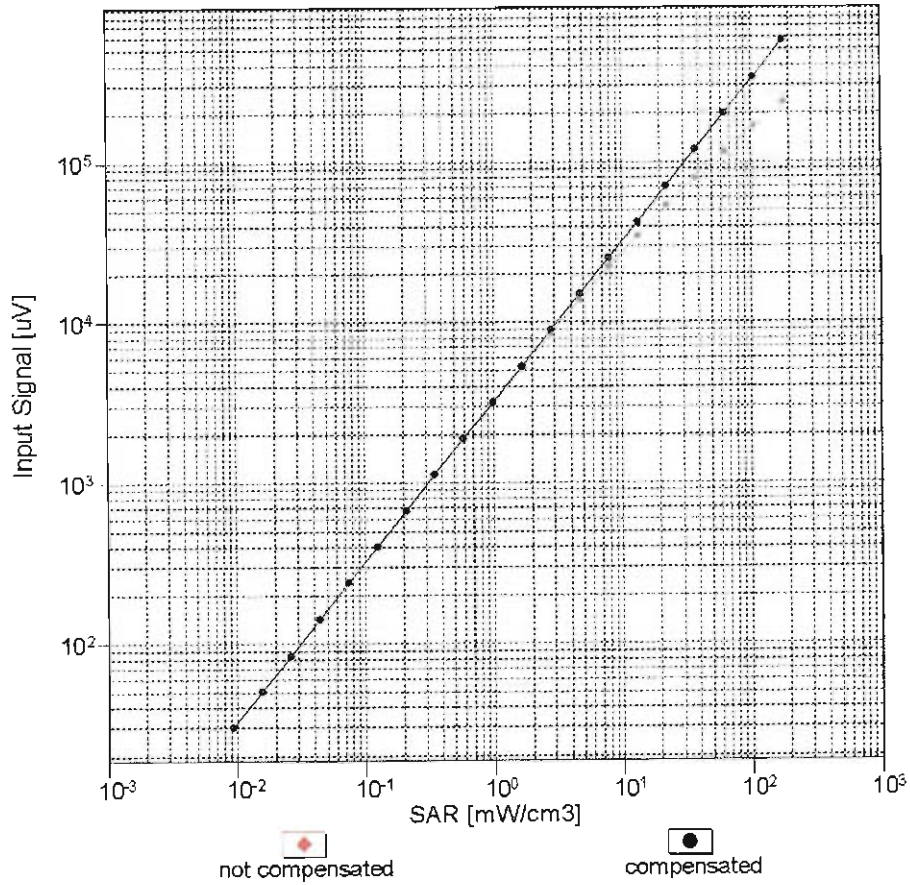

Uncertainty of Linearity Assessment:  $\pm 0.6\%$  ( $k=2$ )

# Conversion Factor Assessment

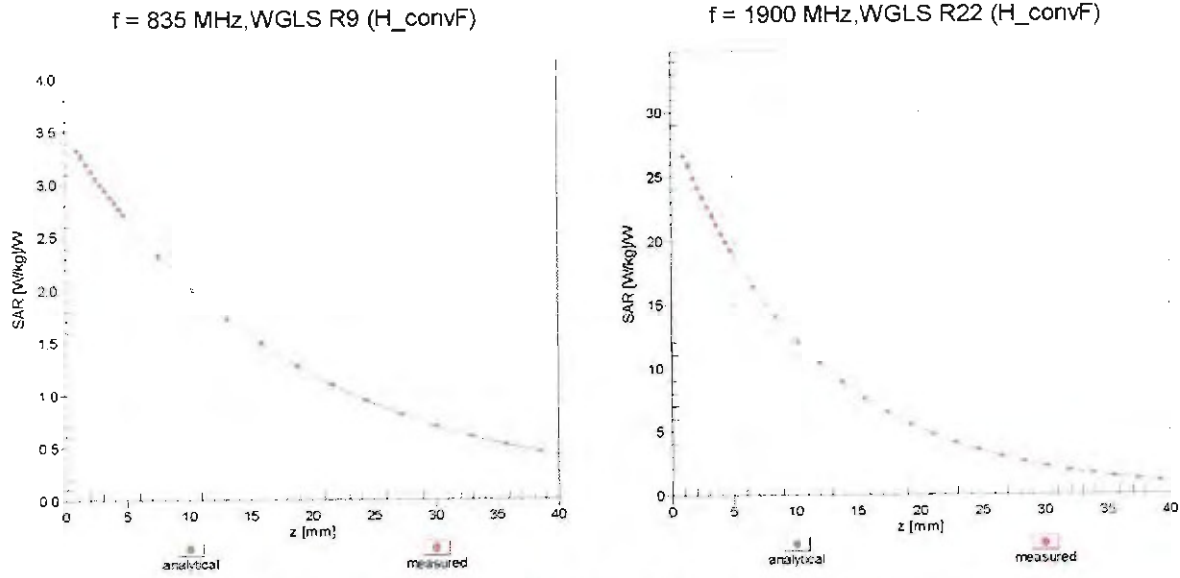

## Deviation from Isotropy in Liquid Error ( $\phi, \vartheta$ ), f = 900 MHz

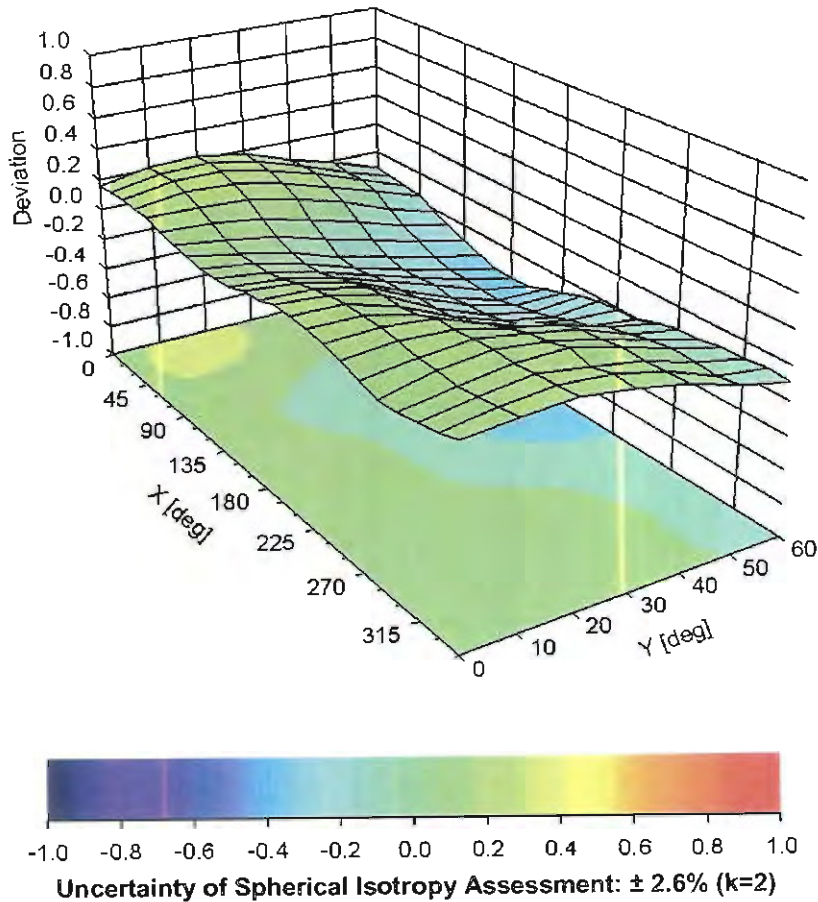

## DASY/EASY - Parameters of Probe: EX3DV4 - SN:3931

### Other Probe Parameters

Sensor Arrangement	Triangular
Connector Angle (°)	127.3
Mechanical Surface Detection Mode	enabled
Optical Surface Detection Mode	disabled
Probe Overall Length	337 mm
Probe Body Diameter	10 mm
Tip Length	9 mm
Tip Diameter	2.5 mm
Probe Tip to Sensor X Calibration Point	1 mm
Probe Tip to Sensor Y Calibration Point	1 mm
Probe Tip to Sensor Z Calibration Point	1 mm
Recommended Measurement Distance from Surface	1.4 mm

**Appendix: Modulation Calibration Parameters**

UID	Communication System Name		A dB	B dB $\sqrt{\mu V}$	C	D dB	VR mV	Max Unc <sup>E</sup> (k=2)
0	CW	X	0.00	0.00	1.00	0.00	165.2	$\pm 2.2\%$
		Y	0.00	0.00	1.00		169.6	
		Z	0.00	0.00	1.00		158.4	
10010- CAA	SAR Validation (Square, 100ms, 10ms)	X	3.48	69.31	12.63	10.00	20.0	$\pm 9.6\%$
		Y	5.87	75.87	16.27		20.0	
		Z	4.02	70.66	13.78		20.0	
10011- CAB	UMTS-FDD (WCDMA)	X	1.30	72.39	18.20	0.00	150.0	$\pm 9.6\%$
		Y	1.19	69.63	16.77		150.0	
		Z	1.01	66.38	14.76		150.0	
10012- CAB	IEEE 802.11b WiFi 2.4 GHz (DSSS, 1 Mbps)	X	1.24	65.29	16.42	0.41	150.0	$\pm 9.6\%$
		Y	1.26	64.91	16.05		150.0	
		Z	1.20	63.67	14.96		150.0	
10013- CAB	IEEE 802.11g WiFi 2.4 GHz (DSSS-OFDM, 6 Mbps)	X	4.82	66.95	17.27	1.46	150.0	$\pm 9.6\%$
		Y	5.04	66.77	17.23		150.0	
		Z	4.95	66.50	16.90		150.0	
10021- DAB	GSM-FDD (TDMA, GMSK)	X	100.00	114.09	27.93	9.39	50.0	$\pm 9.6\%$
		Y	100.00	118.26	30.54		50.0	
		Z	25.45	96.76	24.27		50.0	
10023- DAB	GPRS-FDD (TDMA, GMSK, TN 0)	X	83.93	111.52	27.32	9.57	50.0	$\pm 9.6\%$
		Y	99.99	118.26	30.60		50.0	
		Z	19.40	92.86	23.18		50.0	
10024- DAB	GPRS-FDD (TDMA, GMSK, TN 0-1)	X	100.00	112.26	25.94	6.56	60.0	$\pm 9.6\%$
		Y	100.00	115.42	28.11		60.0	
		Z	100.00	112.41	26.50		60.0	
10025- DAB	EDGE-FDD (TDMA, 8PSK, TN 0)	X	5.67	76.70	28.63	12.57	50.0	$\pm 9.6\%$
		Y	15.06	105.00	40.92		50.0	
		Z	5.92	75.84	27.63		50.0	
10026- DAB	EDGE-FDD (TDMA, 8PSK, TN 0-1)	X	9.71	91.87	32.18	9.56	60.0	$\pm 9.6\%$
		Y	18.06	104.69	36.55		60.0	
		Z	11.21	92.21	31.55		60.0	
10027- DAB	GPRS-FDD (TDMA, GMSK, TN 0-1-2)	X	100.00	112.68	25.31	4.80	80.0	$\pm 9.6\%$
		Y	100.00	114.88	27.06		80.0	
		Z	100.00	111.26	25.19		80.0	
10028- DAB	GPRS-FDD (TDMA, GMSK, TN 0-1-2-3)	X	100.00	114.77	25.52	3.55	100.0	$\pm 9.6\%$
		Y	100.00	115.72	26.71		100.0	
		Z	100.00	111.32	24.54		100.0	
10029- DAB	EDGE-FDD (TDMA, 8PSK, TN 0-1-2)	X	6.19	82.03	27.36	7.80	80.0	$\pm 9.6\%$
		Y	10.55	92.05	31.00		80.0	
		Z	7.53	83.82	27.35		80.0	
10030- CAA	IEEE 802.15.1 Bluetooth (GFSK, DH1)	X	100.00	110.56	24.66	5.30	70.0	$\pm 9.6\%$
		Y	100.00	113.96	26.95		70.0	
		Z	100.00	110.53	25.16		70.0	
10031- CAA	IEEE 802.15.1 Bluetooth (GFSK, DH3)	X	100.00	116.75	24.95	1.88	100.0	$\pm 9.6\%$
		Y	100.00	117.62	26.11		100.0	
		Z	100.00	110.75	23.01		100.0	

10032-CAA	IEEE 802.15.1 Bluetooth (GFSK, DH5)	X	100.00	131.18	29.75	1.17	100.0	± 9.6 %
		Y	100.00	125.29	28.26		100.0	
		Z	100.00	114.95	23.87		100.0	
10033-CAA	IEEE 802.15.1 Bluetooth (PI/4-DQPSK, DH1)	X	10.93	90.53	23.32	5.30	70.0	± 9.6 %
		Y	20.55	101.44	27.99		70.0	
		Z	7.67	84.45	21.88		70.0	
10034-CAA	IEEE 802.15.1 Bluetooth (PI/4-DQPSK, DH3)	X	5.70	84.58	20.06	1.88	100.0	± 9.6 %
		Y	5.85	85.75	22.03		100.0	
		Z	2.95	74.86	17.34		100.0	
10035-CAA	IEEE 802.15.1 Bluetooth (PI/4-DQPSK, DH5)	X	3.92	81.20	18.80	1.17	100.0	± 9.6 %
		Y	3.48	79.72	19.80		100.0	
		Z	2.10	71.76	15.97		100.0	
10036-CAA	IEEE 802.15.1 Bluetooth (8-DPSK, DH1)	X	15.13	95.54	24.90	5.30	70.0	± 9.6 %
		Y	28.86	107.18	29.66		70.0	
		Z	9.07	87.21	22.88		70.0	
10037-CAA	IEEE 802.15.1 Bluetooth (8-DPSK, DH3)	X	4.82	82.50	19.36	1.88	100.0	± 9.6 %
		Y	5.58	85.13	21.78		100.0	
		Z	2.82	74.36	17.11		100.0	
10038-CAA	IEEE 802.15.1 Bluetooth (8-DPSK, DH5)	X	4.08	82.09	19.24	1.17	100.0	± 9.6 %
		Y	3.57	80.38	20.14		100.0	
		Z	2.12	72.10	16.20		100.0	
10039-CAB	CDMA2000 (1xRTT, RC1)	X	5.80	88.31	21.06	0.00	150.0	± 9.6 %
		Y	2.44	75.65	18.16		150.0	
		Z	1.80	71.10	15.73		150.0	
10042-CAB	IS-54 / IS-136 FDD (TDMA/FDM, PI/4-DQPSK, Halfrate)	X	100.00	110.27	25.32	7.78	50.0	± 9.6 %
		Y	100.00	114.03	27.70		50.0	
		Z	32.06	97.64	22.93		50.0	
10044-CAA	IS-91/EIA/TIA-553 FDD (FDMA, FM)	X	0.00	105.67	0.52	0.00	150.0	± 9.6 %
		Y	0.00	101.10	0.34		150.0	
		Z	0.00	94.56	3.16		150.0	
10048-CAA	DECT (TDD, TDMA/FDM, GFSK, Full Slot, 24)	X	11.94	82.95	20.71	13.80	25.0	± 9.6 %
		Y	15.06	89.64	24.59		25.0	
		Z	9.78	81.31	21.11		25.0	
10049-CAA	DECT (TDD, TDMA/FDM, GFSK, Double Slot, 12)	X	15.54	88.48	21.39	10.79	40.0	± 9.6 %
		Y	23.79	97.14	25.51		40.0	
		Z	11.46	84.91	21.03		40.0	
10056-CAA	UMTS-TDD (TD-SCDMA, 1.28 Mcps)	X	13.32	89.14	23.36	9.03	50.0	± 9.6 %
		Y	16.34	93.59	26.16		50.0	
		Z	10.18	84.57	22.45		50.0	
10058-DAB	EDGE-FDD (TDMA, 8PSK, TN 0-1-2-3)	X	4.78	77.20	24.69	6.55	100.0	± 9.6 %
		Y	7.46	84.92	27.60		100.0	
		Z	5.76	78.94	24.73		100.0	
10059-CAB	IEEE 802.11b WiFi 2.4 GHz (DSSS, 2 Mbps)	X	1.30	66.67	17.10	0.61	110.0	± 9.6 %
		Y	1.37	66.65	16.91		110.0	
		Z	1.27	64.87	15.53		110.0	
10060-CAB	IEEE 802.11b WiFi 2.4 GHz (DSSS, 5.5 Mbps)	X	100.00	139.37	36.42	1.30	110.0	± 9.6 %
		Y	100.00	134.75	34.85		110.0	
		Z	5.80	90.90	23.07		110.0	

10061-CAB	IEEE 802.11b WiFi 2.4 GHz (DSSS, 11 Mbps)	X	4.16	86.26	24.31	2.04	110.0	± 9.6 %
		Y	6.78	92.08	26.03		110.0	
		Z	3.18	78.55	20.67		110.0	
10062-CAB	IEEE 802.11a/h WiFi 5 GHz (OFDM, 6 Mbps)	X	4.62	66.99	16.77	0.49	100.0	± 9.6 %
		Y	4.83	66.75	16.66		100.0	
		Z	4.75	66.51	16.38		100.0	
10063-CAB	IEEE 802.11a/h WiFi 5 GHz (OFDM, 9 Mbps)	X	4.64	67.08	16.86	0.72	100.0	± 9.6 %
		Y	4.86	66.87	16.78		100.0	
		Z	4.77	66.60	16.47		100.0	
10064-CAB	IEEE 802.11a/h WiFi 5 GHz (OFDM, 12 Mbps)	X	4.89	67.27	17.04	0.86	100.0	± 9.6 %
		Y	5.19	67.18	17.02		100.0	
		Z	5.08	66.89	16.71		100.0	
10065-CAB	IEEE 802.11a/h WiFi 5 GHz (OFDM, 18 Mbps)	X	4.77	67.14	17.11	1.21	100.0	± 9.6 %
		Y	5.06	67.12	17.13		100.0	
		Z	4.94	66.80	16.79		100.0	
10066-CAB	IEEE 802.11a/h WiFi 5 GHz (OFDM, 24 Mbps)	X	4.78	67.15	17.25	1.46	100.0	± 9.6 %
		Y	5.09	67.18	17.31		100.0	
		Z	4.97	66.83	16.94		100.0	
10067-CAB	IEEE 802.11a/h WiFi 5 GHz (OFDM, 36 Mbps)	X	5.07	67.35	17.68	2.04	100.0	± 9.6 %
		Y	5.38	67.26	17.72		100.0	
		Z	5.26	66.92	17.34		100.0	
10068-CAB	IEEE 802.11a/h WiFi 5 GHz (OFDM, 48 Mbps)	X	5.11	67.30	17.84	2.55	100.0	± 9.6 %
		Y	5.48	67.51	18.02		100.0	
		Z	5.34	67.10	17.60		100.0	
10069-CAB	IEEE 802.11a/h WiFi 5 GHz (OFDM, 54 Mbps)	X	5.18	67.33	18.03	2.67	100.0	± 9.6 %
		Y	5.55	67.43	18.19		100.0	
		Z	5.42	67.05	17.77		100.0	
10071-CAB	IEEE 802.11g WiFi 2.4 GHz (DSSS/OFDM, 9 Mbps)	X	4.92	67.02	17.54	1.99	100.0	± 9.6 %
		Y	5.15	66.91	17.55		100.0	
		Z	5.05	66.61	17.20		100.0	
10072-CAB	IEEE 802.11g WiFi 2.4 GHz (DSSS/OFDM, 12 Mbps)	X	4.89	67.32	17.73	2.30	100.0	± 9.6 %
		Y	5.18	67.36	17.81		100.0	
		Z	5.06	66.97	17.41		100.0	
10073-CAB	IEEE 802.11g WiFi 2.4 GHz (DSSS/OFDM, 18 Mbps)	X	4.97	67.51	18.05	2.83	100.0	± 9.6 %
		Y	5.26	67.57	18.16		100.0	
		Z	5.13	67.15	17.71		100.0	
10074-CAB	IEEE 802.11g WiFi 2.4 GHz (DSSS/OFDM, 24 Mbps)	X	4.97	67.45	18.19	3.30	100.0	± 9.6 %
		Y	5.25	67.52	18.35		100.0	
		Z	5.12	67.08	17.88		100.0	
10075-CAB	IEEE 802.11g WiFi 2.4 GHz (DSSS/OFDM, 36 Mbps)	X	5.01	67.53	18.46	3.82	90.0	± 9.6 %
		Y	5.35	67.85	18.77		90.0	
		Z	5.20	67.32	18.23		90.0	
10076-CAB	IEEE 802.11g WiFi 2.4 GHz (DSSS/OFDM, 48 Mbps)	X	5.05	67.39	18.61	4.15	90.0	± 9.6 %
		Y	5.33	67.57	18.84		90.0	
		Z	5.20	67.09	18.32		90.0	
10077-CAB	IEEE 802.11g WiFi 2.4 GHz (DSSS/OFDM, 54 Mbps)	X	5.08	67.49	18.72	4.30	90.0	± 9.6 %
		Y	5.35	67.63	18.93		90.0	
		Z	5.23	67.15	18.41		90.0	

10081-CAB	CDMA2000 (1xRTT, RC3)	X	1.31	72.98	15.39	0.00	150.0	± 9.6 %
		Y	1.11	69.20	15.13		150.0	
		Z	0.87	65.58	12.79		150.0	
10082-CAB	IS-54 / IS-136 FDD (TDMA/FDM, PI/4-DQPSK, Fullrate)	X	0.85	60.00	5.02	4.77	80.0	± 9.6 %
		Y	1.21	60.81	6.24		80.0	
		Z	1.05	60.00	5.50		80.0	
10090-DAB	GPRS-FDD (TDMA, GMSK, TN 0-4)	X	100.00	112.28	25.96	6.56	60.0	± 9.6 %
		Y	100.00	115.46	28.15		60.0	
		Z	100.00	112.45	26.54		60.0	
10097-CAB	UMTS-FDD (HSDPA)	X	2.10	70.95	17.43	0.00	150.0	± 9.6 %
		Y	1.95	68.39	16.42		150.0	
		Z	1.81	67.01	15.42		150.0	
10098-CAB	UMTS-FDD (HSUPA, Subtest 2)	X	2.06	70.93	17.43	0.00	150.0	± 9.6 %
		Y	1.91	68.38	16.41		150.0	
		Z	1.77	66.95	15.38		150.0	
10099-DAB	EDGE-FDD (TDMA, 8PSK, TN 0-4)	X	9.76	91.94	32.20	9.56	60.0	± 9.6 %
		Y	18.08	104.66	36.54		60.0	
		Z	11.25	92.22	31.54		60.0	
10100-CAB	LTE-FDD (SC-FDMA, 100% RB, 20 MHz, QPSK)	X	3.35	72.13	17.90	0.00	150.0	± 9.6 %
		Y	3.43	71.55	17.33		150.0	
		Z	3.14	69.99	16.48		150.0	
10101-CAB	LTE-FDD (SC-FDMA, 100% RB, 20 MHz, 16-QAM)	X	3.28	68.30	16.59	0.00	150.0	± 9.6 %
		Y	3.42	68.10	16.32		150.0	
		Z	3.28	67.37	15.82		150.0	
10102-CAB	LTE-FDD (SC-FDMA, 100% RB, 20 MHz, 64-QAM)	X	3.39	68.25	16.67	0.00	150.0	± 9.6 %
		Y	3.51	67.99	16.38		150.0	
		Z	3.39	67.35	15.92		150.0	
10103-CAB	LTE-TDD (SC-FDMA, 100% RB, 20 MHz, QPSK)	X	6.41	75.89	20.51	3.98	65.0	± 9.6 %
		Y	7.77	77.49	21.00		65.0	
		Z	6.54	74.47	19.52		65.0	
10104-CAB	LTE-TDD (SC-FDMA, 100% RB, 20 MHz, 16-QAM)	X	6.38	73.95	20.45	3.98	65.0	± 9.6 %
		Y	7.62	75.73	21.18		65.0	
		Z	6.97	74.03	20.17		65.0	
10105-CAB	LTE-TDD (SC-FDMA, 100% RB, 20 MHz, 64-QAM)	X	5.88	72.23	19.98	3.98	65.0	± 9.6 %
		Y	7.31	74.91	21.13		65.0	
		Z	6.85	73.64	20.32		65.0	
10108-CAC	LTE-FDD (SC-FDMA, 100% RB, 10 MHz, QPSK)	X	2.91	71.53	17.82	0.00	150.0	± 9.6 %
		Y	3.02	70.68	17.15		150.0	
		Z	2.76	69.18	16.29		150.0	
10109-CAC	LTE-FDD (SC-FDMA, 100% RB, 10 MHz, 16-QAM)	X	2.95	68.44	16.61	0.00	150.0	± 9.6 %
		Y	3.08	67.93	16.28		150.0	
		Z	2.95	67.17	15.72		150.0	
10110-CAC	LTE-FDD (SC-FDMA, 100% RB, 5 MHz, QPSK)	X	2.39	71.08	17.59	0.00	150.0	± 9.6 %
		Y	2.47	69.75	16.86		150.0	
		Z	2.25	68.18	15.88		150.0	
10111-CAC	LTE-FDD (SC-FDMA, 100% RB, 5 MHz, 16-QAM)	X	2.79	70.36	17.30	0.00	150.0	± 9.6 %
		Y	2.80	68.64	16.65		150.0	
		Z	2.65	67.83	16.01		150.0	



10112-CAC	LTE-FDD (SC-FDMA, 100% RB, 10 MHz, 64-QAM)	X	3.07	68.42	16.64	0.00	150.0	± 9.6 %
		Y	3.20	67.83	16.29		150.0	
		Z	3.07	67.16	15.79		150.0	
10113-CAC	LTE-FDD (SC-FDMA, 100% RB, 5 MHz, 64-QAM)	X	2.94	70.45	17.39	0.00	150.0	± 9.6 %
		Y	2.95	68.67	16.72		150.0	
		Z	2.81	67.97	16.15		150.0	
10114-CAB	IEEE 802.11n (HT Greenfield, 13.5 Mbps, BPSK)	X	5.09	67.47	16.77	0.00	150.0	± 9.6 %
		Y	5.23	67.24	16.53		150.0	
		Z	5.18	67.08	16.35		150.0	
10115-CAB	IEEE 802.11n (HT Greenfield, 81 Mbps, 16-QAM)	X	5.34	67.51	16.78	0.00	150.0	± 9.6 %
		Y	5.60	67.53	16.67		150.0	
		Z	5.52	67.36	16.50		150.0	
10116-CAB	IEEE 802.11n (HT Greenfield, 135 Mbps, 64-QAM)	X	5.18	67.67	16.79	0.00	150.0	± 9.6 %
		Y	5.36	67.51	16.58		150.0	
		Z	5.29	67.32	16.39		150.0	
10117-CAB	IEEE 802.11n (HT Mixed, 13.5 Mbps, BPSK)	X	5.07	67.38	16.74	0.00	150.0	± 9.6 %
		Y	5.24	67.25	16.55		150.0	
		Z	5.16	67.03	16.34		150.0	
10118-CAB	IEEE 802.11n (HT Mixed, 81 Mbps, 16-QAM)	X	5.42	67.71	16.89	0.00	150.0	± 9.6 %
		Y	5.67	67.69	16.76		150.0	
		Z	5.59	67.53	16.59		150.0	
10119-CAB	IEEE 802.11n (HT Mixed, 135 Mbps, 64-QAM)	X	5.17	67.64	16.79	0.00	150.0	± 9.6 %
		Y	5.33	67.45	16.57		150.0	
		Z	5.26	67.25	16.37		150.0	
10140-CAB	LTE-FDD (SC-FDMA, 100% RB, 15 MHz, 16-QAM)	X	3.41	68.25	16.57	0.00	150.0	± 9.6 %
		Y	3.56	67.99	16.30		150.0	
		Z	3.43	67.35	15.84		150.0	
10141-CAB	LTE-FDD (SC-FDMA, 100% RB, 15 MHz, 64-QAM)	X	3.54	68.37	16.75	0.00	150.0	± 9.6 %
		Y	3.68	68.01	16.43		150.0	
		Z	3.56	67.45	16.01		150.0	
10142-CAC	LTE-FDD (SC-FDMA, 100% RB, 3 MHz, QPSK)	X	2.25	71.96	17.48	0.00	150.0	± 9.6 %
		Y	2.26	69.83	16.74		150.0	
		Z	2.02	68.09	15.61		150.0	
10143-CAC	LTE-FDD (SC-FDMA, 100% RB, 3 MHz, 16-QAM)	X	2.82	72.22	17.26	0.00	150.0	± 9.6 %
		Y	2.71	69.55	16.65		150.0	
		Z	2.52	68.51	15.83		150.0	
10144-CAC	LTE-FDD (SC-FDMA, 100% RB, 3 MHz, 64-QAM)	X	2.29	68.06	14.75	0.00	150.0	± 9.6 %
		Y	2.50	67.47	15.19		150.0	
		Z	2.32	66.44	14.34		150.0	
10145-CAC	LTE-FDD (SC-FDMA, 100% RB, 1.4 MHz, QPSK)	X	1.16	65.56	11.35	0.00	150.0	± 9.6 %
		Y	1.65	68.53	14.65		150.0	
		Z	1.36	65.83	12.76		150.0	
10146-CAC	LTE-FDD (SC-FDMA, 100% RB, 1.4 MHz, 16-QAM)	X	1.35	63.40	9.39	0.00	150.0	± 9.6 %
		Y	3.12	72.00	15.52		150.0	
		Z	2.16	67.04	12.61		150.0	
10147-CAC	LTE-FDD (SC-FDMA, 100% RB, 1.4 MHz, 64-QAM)	X	1.53	64.72	10.19	0.00	150.0	± 9.6 %
		Y	4.03	75.63	17.18		150.0	
		Z	2.54	69.13	13.74		150.0	

10149-CAB	LTE-FDD (SC-FDMA, 50% RB, 20 MHz, 16-QAM)	X	2.96	68.52	16.66	0.00	150.0	± 9.6 %
		Y	3.09	67.99	16.32		150.0	
		Z	2.96	67.23	15.77		150.0	
10150-CAB	LTE-FDD (SC-FDMA, 50% RB, 20 MHz, 64-QAM)	X	3.08	68.50	16.69	0.00	150.0	± 9.6 %
		Y	3.21	67.88	16.33		150.0	
		Z	3.08	67.21	15.83		150.0	
10151-CAB	LTE-TDD (SC-FDMA, 50% RB, 20 MHz, QPSK)	X	7.03	79.10	21.82	3.98	65.0	± 9.6 %
		Y	8.21	79.75	22.00		65.0	
		Z	7.10	77.15	20.67		65.0	
10152-CAB	LTE-TDD (SC-FDMA, 50% RB, 20 MHz, 16-QAM)	X	5.92	73.94	20.06	3.98	65.0	± 9.6 %
		Y	7.21	75.88	21.03		65.0	
		Z	6.48	73.87	19.84		65.0	
10153-CAB	LTE-TDD (SC-FDMA, 50% RB, 20 MHz, 64-QAM)	X	6.35	75.11	20.94	3.98	65.0	± 9.6 %
		Y	7.55	76.62	21.69		65.0	
		Z	6.87	74.79	20.60		65.0	
10154-CAC	LTE-FDD (SC-FDMA, 50% RB, 10 MHz, QPSK)	X	2.46	71.67	17.92	0.00	150.0	± 9.6 %
		Y	2.54	70.24	17.15		150.0	
		Z	2.30	68.63	16.17		150.0	
10155-CAC	LTE-FDD (SC-FDMA, 50% RB, 10 MHz, 16-QAM)	X	2.79	70.40	17.33	0.00	150.0	± 9.6 %
		Y	2.80	68.64	16.65		150.0	
		Z	2.66	67.83	16.02		150.0	
10156-CAC	LTE-FDD (SC-FDMA, 50% RB, 5 MHz, QPSK)	X	2.17	72.73	17.45	0.00	150.0	± 9.6 %
		Y	2.14	70.24	16.79		150.0	
		Z	1.88	68.21	15.48		150.0	
10157-CAC	LTE-FDD (SC-FDMA, 50% RB, 5 MHz, 16-QAM)	X	2.21	69.24	14.98	0.00	150.0	± 9.6 %
		Y	2.36	68.31	15.46		150.0	
		Z	2.15	66.99	14.43		150.0	
10158-CAC	LTE-FDD (SC-FDMA, 50% RB, 10 MHz, 64-QAM)	X	2.95	70.56	17.46	0.00	150.0	± 9.6 %
		Y	2.95	68.72	16.76		150.0	
		Z	2.82	68.03	16.20		150.0	
10159-CAC	LTE-FDD (SC-FDMA, 50% RB, 5 MHz, 64-QAM)	X	2.36	69.87	15.32	0.00	150.0	± 9.6 %
		Y	2.49	68.78	15.76		150.0	
		Z	2.27	67.50	14.75		150.0	
10160-CAB	LTE-FDD (SC-FDMA, 50% RB, 15 MHz, QPSK)	X	2.90	70.47	17.47	0.00	150.0	± 9.6 %
		Y	2.94	69.28	16.77		150.0	
		Z	2.76	68.21	16.07		150.0	
10161-CAB	LTE-FDD (SC-FDMA, 50% RB, 15 MHz, 16-QAM)	X	2.98	68.55	16.64	0.00	150.0	± 9.6 %
		Y	3.10	67.79	16.29		150.0	
		Z	2.98	67.13	15.77		150.0	
10162-CAB	LTE-FDD (SC-FDMA, 50% RB, 15 MHz, 64-QAM)	X	3.10	68.74	16.76	0.00	150.0	± 9.6 %
		Y	3.21	67.84	16.35		150.0	
		Z	3.09	67.25	15.86		150.0	
10166-CAC	LTE-FDD (SC-FDMA, 50% RB, 1.4 MHz, QPSK)	X	3.31	69.42	19.40	3.01	150.0	± 9.6 %
		Y	3.85	69.94	19.41		150.0	
		Z	3.63	68.92	18.65		150.0	
10167-CAC	LTE-FDD (SC-FDMA, 50% RB, 1.4 MHz, 16-QAM)	X	3.89	72.11	19.78	3.01	150.0	± 9.6 %
		Y	4.89	73.20	20.04		150.0	
		Z	4.45	71.60	19.05		150.0	

10168-CAC	LTE-FDD (SC-FDMA, 50% RB, 1.4 MHz, 64-QAM)	X	4.43	75.02	21.48	3.01	150.0	± 9.6 %
		Y	5.37	75.20	21.21		150.0	
		Z	4.92	73.76	20.36		150.0	
10169-CAB	LTE-FDD (SC-FDMA, 1 RB, 20 MHz, QPSK)	X	2.61	67.65	18.68	3.01	150.0	± 9.6 %
		Y	3.41	71.01	19.90		150.0	
		Z	3.09	68.90	18.61		150.0	
10170-CAB	LTE-FDD (SC-FDMA, 1 RB, 20 MHz, 16-QAM)	X	3.32	73.16	21.10	3.01	150.0	± 9.6 %
		Y	5.09	78.14	22.55		150.0	
		Z	4.27	74.69	20.88		150.0	
10171-AAB	LTE-FDD (SC-FDMA, 1 RB, 20 MHz, 64-QAM)	X	2.74	69.02	18.13	3.01	150.0	± 9.6 %
		Y	4.10	73.53	19.72		150.0	
		Z	3.48	70.44	18.07		150.0	
10172-CAB	LTE-TDD (SC-FDMA, 1 RB, 20 MHz, QPSK)	X	5.53	83.56	25.72	6.02	65.0	± 9.6 %
		Y	21.34	105.31	32.41		65.0	
		Z	7.30	84.26	24.94		65.0	
10173-CAB	LTE-TDD (SC-FDMA, 1 RB, 20 MHz, 16-QAM)	X	10.58	92.60	26.95	6.02	65.0	± 9.6 %
		Y	29.30	105.74	30.57		65.0	
		Z	12.37	90.08	25.23		65.0	
10174-CAB	LTE-TDD (SC-FDMA, 1 RB, 20 MHz, 64-QAM)	X	7.41	85.53	24.05	6.02	65.0	± 9.6 %
		Y	21.20	98.69	27.99		65.0	
		Z	10.53	86.42	23.55		65.0	
10175-CAC	LTE-FDD (SC-FDMA, 1 RB, 10 MHz, QPSK)	X	2.58	67.36	18.42	3.01	150.0	± 9.6 %
		Y	3.37	70.66	19.64		150.0	
		Z	3.05	68.56	18.35		150.0	
10176-CAC	LTE-FDD (SC-FDMA, 1 RB, 10 MHz, 16-QAM)	X	3.33	73.19	21.11	3.01	150.0	± 9.6 %
		Y	5.10	78.16	22.56		150.0	
		Z	4.27	74.71	20.89		150.0	
10177-CAE	LTE-FDD (SC-FDMA, 1 RB, 5 MHz, QPSK)	X	2.60	67.50	18.51	3.01	150.0	± 9.6 %
		Y	3.40	70.83	19.75		150.0	
		Z	3.07	68.74	18.46		150.0	
10178-CAC	LTE-FDD (SC-FDMA, 1 RB, 5 MHz, 16-QAM)	X	3.30	73.00	21.00	3.01	150.0	± 9.6 %
		Y	5.02	77.85	22.40		150.0	
		Z	4.22	74.44	20.74		150.0	
10179-CAC	LTE-FDD (SC-FDMA, 1 RB, 10 MHz, 64-QAM)	X	3.00	71.00	19.50	3.01	150.0	± 9.6 %
		Y	4.55	75.67	20.98		150.0	
		Z	3.82	72.37	19.31		150.0	
10180-CAC	LTE-FDD (SC-FDMA, 1 RB, 5 MHz, 64-QAM)	X	2.73	68.97	18.09	3.01	150.0	± 9.6 %
		Y	4.08	73.43	19.65		150.0	
		Z	3.47	70.35	18.01		150.0	
10181-CAB	LTE-FDD (SC-FDMA, 1 RB, 15 MHz, QPSK)	X	2.59	67.48	18.51	3.01	150.0	± 9.6 %
		Y	3.39	70.81	19.74		150.0	
		Z	3.07	68.71	18.45		150.0	
10182-CAB	LTE-FDD (SC-FDMA, 1 RB, 15 MHz, 16-QAM)	X	3.30	72.98	20.99	3.01	150.0	± 9.6 %
		Y	5.01	77.82	22.39		150.0	
		Z	4.21	74.41	20.73		150.0	
10183-AAA	LTE-FDD (SC-FDMA, 1 RB, 15 MHz, 64-QAM)	X	2.73	68.94	18.08	3.01	150.0	± 9.6 %
		Y	4.07	73.40	19.64		150.0	
		Z	3.46	70.33	18.00		150.0	

10184-CAC	LTE-FDD (SC-FDMA, 1 RB, 3 MHz, QPSK)	X	2.60	67.52	18.53	3.01	150.0	± 9.6 %
		Y	3.40	70.86	19.76		150.0	
		Z	3.08	68.76	18.47		150.0	
10185-CAC	LTE-FDD (SC-FDMA, 1 RB, 3 MHz, 16-QAM)	X	3.31	73.05	21.03	3.01	150.0	± 9.6 %
		Y	5.04	77.90	22.43		150.0	
		Z	4.23	74.49	20.77		150.0	
10186-AAC	LTE-FDD (SC-FDMA, 1 RB, 3 MHz, 64-QAM)	X	2.74	69.01	18.12	3.01	150.0	± 9.6 %
		Y	4.10	73.47	19.68		150.0	
		Z	3.48	70.39	18.03		150.0	
10187-CAC	LTE-FDD (SC-FDMA, 1 RB, 1.4 MHz, QPSK)	X	2.61	67.58	18.60	3.01	150.0	± 9.6 %
		Y	3.41	70.90	19.81		150.0	
		Z	3.09	68.80	18.52		150.0	
10188-CAC	LTE-FDD (SC-FDMA, 1 RB, 1.4 MHz, 16-QAM)	X	3.41	73.70	21.42	3.01	150.0	± 9.6 %
		Y	5.24	78.69	22.84		150.0	
		Z	4.38	75.22	21.18		150.0	
10189-AAC	LTE-FDD (SC-FDMA, 1 RB, 1.4 MHz, 64-QAM)	X	2.80	69.41	18.40	3.01	150.0	± 9.6 %
		Y	4.20	73.97	19.98		150.0	
		Z	3.56	70.83	18.32		150.0	
10193-CAB	IEEE 802.11n (HT Greenfield, 6.5 Mbps, BPSK)	X	4.49	67.07	16.51	0.00	150.0	± 9.6 %
		Y	4.67	66.69	16.32		150.0	
		Z	4.59	66.49	16.09		150.0	
10194-CAB	IEEE 802.11n (HT Greenfield, 39 Mbps, 16-QAM)	X	4.64	67.34	16.63	0.00	150.0	± 9.6 %
		Y	4.86	67.05	16.43		150.0	
		Z	4.77	66.83	16.21		150.0	
10195-CAB	IEEE 802.11n (HT Greenfield, 65 Mbps, 64-QAM)	X	4.68	67.36	16.65	0.00	150.0	± 9.6 %
		Y	4.90	67.06	16.44		150.0	
		Z	4.82	66.86	16.22		150.0	
10196-CAB	IEEE 802.11n (HT Mixed, 6.5 Mbps, BPSK)	X	4.48	67.10	16.51	0.00	150.0	± 9.6 %
		Y	4.68	66.78	16.36		150.0	
		Z	4.60	66.57	16.12		150.0	
10197-CAB	IEEE 802.11n (HT Mixed, 39 Mbps, 16-QAM)	X	4.66	67.35	16.64	0.00	150.0	± 9.6 %
		Y	4.88	67.07	16.45		150.0	
		Z	4.79	66.86	16.22		150.0	
10198-CAB	IEEE 802.11n (HT Mixed, 65 Mbps, 64-QAM)	X	4.68	67.37	16.65	0.00	150.0	± 9.6 %
		Y	4.91	67.08	16.45		150.0	
		Z	4.82	66.87	16.23		150.0	
10219-CAB	IEEE 802.11n (HT Mixed, 7.2 Mbps, BPSK)	X	4.44	67.14	16.49	0.00	150.0	± 9.6 %
		Y	4.63	66.80	16.32		150.0	
		Z	4.55	66.58	16.08		150.0	
10220-CAB	IEEE 802.11n (HT Mixed, 43.3 Mbps, 16-QAM)	X	4.65	67.31	16.63	0.00	150.0	± 9.6 %
		Y	4.87	67.06	16.44		150.0	
		Z	4.79	66.83	16.21		150.0	
10221-CAB	IEEE 802.11n (HT Mixed, 72.2 Mbps, 64-QAM)	X	4.69	67.30	16.64	0.00	150.0	± 9.6 %
		Y	4.91	67.01	16.44		150.0	
		Z	4.83	66.81	16.22		150.0	
10222-CAB	IEEE 802.11n (HT Mixed, 15 Mbps, BPSK)	X	5.04	67.37	16.73	0.00	150.0	± 9.6 %
		Y	5.22	67.27	16.55		150.0	
		Z	5.14	67.04	16.34		150.0	

10223-CAB	IEEE 802.11n (HT Mixed, 90 Mbps, 16-QAM)	X	5.33	67.57	16.84	0.00	150.0	± 9.6 %
		Y	5.58	67.57	16.72		150.0	
		Z	5.46	67.24	16.46		150.0	
10224-CAB	IEEE 802.11n (HT Mixed, 150 Mbps, 64-QAM)	X	5.08	67.48	16.71	0.00	150.0	± 9.6 %
		Y	5.27	67.38	16.53		150.0	
		Z	5.19	67.14	16.31		150.0	
10225-CAB	UMTS-FDD (HSPA+)	X	2.82	67.14	15.84	0.00	150.0	± 9.6 %
		Y	2.95	66.38	15.78		150.0	
		Z	2.86	65.91	15.30		150.0	
10226-CAA	LTE-TDD (SC-FDMA, 1 RB, 1.4 MHz, 16-QAM)	X	11.41	94.07	27.52	6.02	65.0	± 9.6 %
		Y	31.67	107.27	31.09		65.0	
		Z	13.11	91.16	25.67		65.0	
10227-CAA	LTE-TDD (SC-FDMA, 1 RB, 1.4 MHz, 64-QAM)	X	11.04	92.14	26.24	6.02	65.0	± 9.6 %
		Y	24.12	100.92	28.72		65.0	
		Z	11.71	88.12	24.16		65.0	
10228-CAA	LTE-TDD (SC-FDMA, 1 RB, 1.4 MHz, QPSK)	X	7.63	90.07	28.10	6.02	65.0	± 9.6 %
		Y	23.55	107.62	33.18		65.0	
		Z	10.51	91.21	27.39		65.0	
10229-CAB	LTE-TDD (SC-FDMA, 1 RB, 3 MHz, 16-QAM)	X	10.66	92.71	26.99	6.02	65.0	± 9.6 %
		Y	29.42	105.79	30.60		65.0	
		Z	12.45	90.17	25.27		65.0	
10230-CAB	LTE-TDD (SC-FDMA, 1 RB, 3 MHz, 64-QAM)	X	10.25	90.80	25.74	6.02	65.0	± 9.6 %
		Y	22.68	99.76	28.30		65.0	
		Z	11.15	87.26	23.80		65.0	
10231-CAB	LTE-TDD (SC-FDMA, 1 RB, 3 MHz, QPSK)	X	7.27	89.04	27.66	6.02	65.0	± 9.6 %
		Y	22.20	106.36	32.73		65.0	
		Z	10.05	90.30	27.01		65.0	
10232-CAB	LTE-TDD (SC-FDMA, 1 RB, 5 MHz, 16-QAM)	X	10.64	92.69	26.99	6.02	65.0	± 9.6 %
		Y	29.42	105.80	30.60		65.0	
		Z	12.43	90.15	25.26		65.0	
10233-CAB	LTE-TDD (SC-FDMA, 1 RB, 5 MHz, 64-QAM)	X	10.23	90.76	25.73	6.02	65.0	± 9.6 %
		Y	22.67	99.78	28.30		65.0	
		Z	11.14	87.24	23.80		65.0	
10234-CAB	LTE-TDD (SC-FDMA, 1 RB, 5 MHz, QPSK)	X	6.99	88.15	27.23	6.02	65.0	± 9.6 %
		Y	20.93	105.02	32.23		65.0	
		Z	9.64	89.40	26.60		65.0	
10235-CAB	LTE-TDD (SC-FDMA, 1 RB, 10 MHz, 16-QAM)	X	10.65	92.73	27.00	6.02	65.0	± 9.6 %
		Y	29.50	105.86	30.62		65.0	
		Z	12.44	90.18	25.27		65.0	
10236-CAB	LTE-TDD (SC-FDMA, 1 RB, 10 MHz, 64-QAM)	X	10.34	90.92	25.77	6.02	65.0	± 9.6 %
		Y	22.93	99.94	28.35		65.0	
		Z	11.22	87.34	23.83		65.0	
10237-CAB	LTE-TDD (SC-FDMA, 1 RB, 10 MHz, QPSK)	X	7.28	89.10	27.69	6.02	65.0	± 9.6 %
		Y	22.38	106.55	32.79		65.0	
		Z	10.07	90.36	27.03		65.0	
10238-CAB	LTE-TDD (SC-FDMA, 1 RB, 15 MHz, 16-QAM)	X	10.61	92.67	26.98	6.02	65.0	± 9.6 %
		Y	29.40	105.80	30.59		65.0	
		Z	12.41	90.13	25.25		65.0	

10239-CAB	LTE-TDD (SC-FDMA, 1 RB, 15 MHz, 64-QAM)	X	10.19	90.73	25.72	6.02	65.0	± 9.6 %
		Y	22.65	99.78	28.31		65.0	
		Z	11.11	87.22	23.79		65.0	
10240-CAB	LTE-TDD (SC-FDMA, 1 RB, 15 MHz, QPSK)	X	7.26	89.06	27.67	6.02	65.0	± 9.6 %
		Y	22.30	106.48	32.77		65.0	
		Z	10.04	90.32	27.01		65.0	
10241-CAA	LTE-TDD (SC-FDMA, 50% RB, 1.4 MHz, 16-QAM)	X	7.75	81.08	25.21	6.98	65.0	± 9.6 %
		Y	10.21	83.82	26.43		65.0	
		Z	8.73	80.32	24.52		65.0	
10242-CAA	LTE-TDD (SC-FDMA, 50% RB, 1.4 MHz, 64-QAM)	X	6.80	78.38	24.02	6.98	65.0	± 9.6 %
		Y	9.63	82.52	25.83		65.0	
		Z	8.38	79.47	24.10		65.0	
10243-CAA	LTE-TDD (SC-FDMA, 50% RB, 1.4 MHz, QPSK)	X	5.61	75.06	23.46	6.98	65.0	± 9.6 %
		Y	7.74	79.46	25.50		65.0	
		Z	6.88	76.70	23.79		65.0	
10244-CAB	LTE-TDD (SC-FDMA, 50% RB, 3 MHz, 16-QAM)	X	4.85	72.20	16.09	3.98	65.0	± 9.6 %
		Y	8.02	78.99	20.43		65.0	
		Z	6.19	74.48	17.94		65.0	
10245-CAB	LTE-TDD (SC-FDMA, 50% RB, 3 MHz, 64-QAM)	X	4.70	71.53	15.74	3.98	65.0	± 9.6 %
		Y	7.89	78.48	20.19		65.0	
		Z	6.13	74.10	17.74		65.0	
10246-CAB	LTE-TDD (SC-FDMA, 50% RB, 3 MHz, QPSK)	X	5.22	76.54	18.28	3.98	65.0	± 9.6 %
		Y	8.14	82.43	21.79		65.0	
		Z	5.87	76.86	19.08		65.0	
10247-CAB	LTE-TDD (SC-FDMA, 50% RB, 5 MHz, 16-QAM)	X	4.92	73.01	17.55	3.98	65.0	± 9.6 %
		Y	6.62	76.59	20.16		65.0	
		Z	5.63	73.71	18.45		65.0	
10248-CAB	LTE-TDD (SC-FDMA, 50% RB, 5 MHz, 64-QAM)	X	4.84	72.32	17.23	3.98	65.0	± 9.6 %
		Y	6.62	76.08	19.95		65.0	
		Z	5.66	73.31	18.26		65.0	
10249-CAB	LTE-TDD (SC-FDMA, 50% RB, 5 MHz, QPSK)	X	7.10	81.85	21.45	3.98	65.0	± 9.6 %
		Y	9.09	84.35	23.13		65.0	
		Z	6.82	79.25	20.73		65.0	
10250-CAB	LTE-TDD (SC-FDMA, 50% RB, 10 MHz, 16-QAM)	X	6.14	76.72	21.07	3.98	65.0	± 9.6 %
		Y	7.40	78.29	22.09		65.0	
		Z	6.54	75.95	20.75		65.0	
10251-CAB	LTE-TDD (SC-FDMA, 50% RB, 10 MHz, 64-QAM)	X	5.70	74.17	19.61	3.98	65.0	± 9.6 %
		Y	7.04	76.19	20.94		65.0	
		Z	6.27	74.04	19.64		65.0	
10252-CAB	LTE-TDD (SC-FDMA, 50% RB, 10 MHz, QPSK)	X	7.47	82.32	22.88	3.98	65.0	± 9.6 %
		Y	8.82	83.02	23.29		65.0	
		Z	7.18	79.27	21.49		65.0	
10253-CAB	LTE-TDD (SC-FDMA, 50% RB, 15 MHz, 16-QAM)	X	5.82	73.49	19.80	3.98	65.0	± 9.6 %
		Y	6.99	75.20	20.79		65.0	
		Z	6.34	73.34	19.64		65.0	
10254-CAB	LTE-TDD (SC-FDMA, 50% RB, 15 MHz, 64-QAM)	X	6.20	74.53	20.56	3.98	65.0	± 9.6 %
		Y	7.35	75.96	21.41		65.0	
		Z	6.71	74.22	20.33		65.0	

10255-CAB	LTE-TDD (SC-FDMA, 50% RB, 15 MHz, QPSK)	X	6.71	78.47	21.74	3.98	65.0	± 9.6 %
		Y	7.84	79.18	22.03		65.0	
		Z	6.83	76.67	20.70		65.0	
10256-CAA	LTE-TDD (SC-FDMA, 100% RB, 1.4 MHz, 16-QAM)	X	3.47	67.38	12.72	3.98	65.0	± 9.6 %
		Y	6.90	76.38	18.57		65.0	
		Z	5.11	71.48	15.77		65.0	
10257-CAA	LTE-TDD (SC-FDMA, 100% RB, 1.4 MHz, 64-QAM)	X	3.38	66.76	12.32	3.98	65.0	± 9.6 %
		Y	6.74	75.67	18.20		65.0	
		Z	5.05	70.99	15.48		65.0	
10258-CAA	LTE-TDD (SC-FDMA, 100% RB, 1.4 MHz, QPSK)	X	3.49	70.18	14.59	3.98	65.0	± 9.6 %
		Y	6.78	79.22	19.98		65.0	
		Z	4.80	73.56	17.06		65.0	
10259-CAB	LTE-TDD (SC-FDMA, 100% RB, 3 MHz, 16-QAM)	X	5.42	74.50	18.87	3.98	65.0	± 9.6 %
		Y	6.93	77.16	20.83		65.0	
		Z	5.98	74.51	19.26		65.0	
10260-CAB	LTE-TDD (SC-FDMA, 100% RB, 3 MHz, 64-QAM)	X	5.41	74.15	18.72	3.98	65.0	± 9.6 %
		Y	6.95	76.90	20.74		65.0	
		Z	6.03	74.34	19.21		65.0	
10261-CAB	LTE-TDD (SC-FDMA, 100% RB, 3 MHz, QPSK)	X	6.87	81.15	21.70	3.98	65.0	± 9.6 %
		Y	8.53	83.00	22.95		65.0	
		Z	6.70	78.62	20.83		65.0	
10262-CAB	LTE-TDD (SC-FDMA, 100% RB, 5 MHz, 16-QAM)	X	6.12	76.64	21.02	3.98	65.0	± 9.6 %
		Y	7.39	78.26	22.06		65.0	
		Z	6.53	75.90	20.71		65.0	
10263-CAB	LTE-TDD (SC-FDMA, 100% RB, 5 MHz, 64-QAM)	X	5.69	74.15	19.60	3.98	65.0	± 9.6 %
		Y	7.03	76.18	20.94		65.0	
		Z	6.26	74.03	19.63		65.0	
10264-CAB	LTE-TDD (SC-FDMA, 100% RB, 5 MHz, QPSK)	X	7.38	82.08	22.77	3.98	65.0	± 9.6 %
		Y	8.75	82.86	23.22		65.0	
		Z	7.12	79.11	21.41		65.0	
10265-CAB	LTE-TDD (SC-FDMA, 100% RB, 10 MHz, 16-QAM)	X	5.92	73.94	20.06	3.98	65.0	± 9.6 %
		Y	7.20	75.88	21.03		65.0	
		Z	6.48	73.87	19.85		65.0	
10266-CAB	LTE-TDD (SC-FDMA, 100% RB, 10 MHz, 64-QAM)	X	6.35	75.09	20.93	3.98	65.0	± 9.6 %
		Y	7.55	76.61	21.68		65.0	
		Z	6.86	74.78	20.59		65.0	
10267-CAB	LTE-TDD (SC-FDMA, 100% RB, 10 MHz, QPSK)	X	7.01	79.05	21.80	3.98	65.0	± 9.6 %
		Y	8.19	79.71	21.98		65.0	
		Z	7.09	77.11	20.65		65.0	
10268-CAB	LTE-TDD (SC-FDMA, 100% RB, 15 MHz, 16-QAM)	X	6.54	73.87	20.51	3.98	65.0	± 9.6 %
		Y	7.70	75.41	21.18		65.0	
		Z	7.12	73.89	20.25		65.0	
10269-CAB	LTE-TDD (SC-FDMA, 100% RB, 15 MHz, 64-QAM)	X	6.52	73.47	20.39	3.98	65.0	± 9.6 %
		Y	7.63	74.96	21.06		65.0	
		Z	7.08	73.52	20.16		65.0	
10270-CAB	LTE-TDD (SC-FDMA, 100% RB, 15 MHz, QPSK)	X	6.72	76.10	20.81	3.98	65.0	± 9.6 %
		Y	7.77	76.91	21.02		65.0	
		Z	7.04	75.13	20.02		65.0	

10274-CAB	UMTS-FDD (HSUPA, Subtest 5, 3GPP Rel8.10)	X	2.68	67.93	16.00	0.00	150.0	± 9.6 %
		Y	2.70	66.71	15.69		150.0	
		Z	2.60	66.12	15.13		150.0	
10275-CAB	UMTS-FDD (HSUPA, Subtest 5, 3GPP Rel8.4)	X	1.86	71.35	17.51	0.00	150.0	± 9.6 %
		Y	1.79	69.27	16.54		150.0	
		Z	1.60	67.20	15.22		150.0	
10277-CAA	PHS (QPSK)	X	2.51	62.07	7.69	9.03	50.0	± 9.6 %
		Y	3.60	65.47	10.92		50.0	
		Z	3.21	64.00	9.69		50.0	
10278-CAA	PHS (QPSK, BW 884MHz, Rolloff 0.5)	X	4.14	68.90	13.57	9.03	50.0	± 9.6 %
		Y	8.03	79.56	19.93		50.0	
		Z	5.72	73.56	16.82		50.0	
10279-CAA	PHS (QPSK, BW 884MHz, Rolloff 0.38)	X	4.23	69.12	13.72	9.03	50.0	± 9.6 %
		Y	8.23	79.82	20.06		50.0	
		Z	5.85	73.80	16.95		50.0	
10290-AAB	CDMA2000, RC1, SO55, Full Rate	X	2.16	75.12	16.21	0.00	150.0	± 9.6 %
		Y	1.91	71.91	16.34		150.0	
		Z	1.49	68.32	14.21		150.0	
10291-AAB	CDMA2000, RC3, SO55, Full Rate	X	1.24	72.30	15.09	0.00	150.0	± 9.6 %
		Y	1.08	68.86	14.96		150.0	
		Z	0.85	65.38	12.66		150.0	
10292-AAB	CDMA2000, RC3, SO32, Full Rate	X	13.33	104.67	25.79	0.00	150.0	± 9.6 %
		Y	1.50	74.81	18.02		150.0	
		Z	1.03	68.79	14.75		150.0	
10293-AAB	CDMA2000, RC3, SO3, Full Rate	X	100.00	135.60	33.89	0.00	150.0	± 9.6 %
		Y	2.41	82.36	21.43		150.0	
		Z	1.44	73.75	17.42		150.0	
10295-AAB	CDMA2000, RC1, SO3, 1/8th Rate 25 fr.	X	11.05	85.41	22.93	9.03	50.0	± 9.6 %
		Y	8.87	82.92	23.80		50.0	
		Z	7.57	79.23	21.65		50.0	
10297-AAA	LTE-FDD (SC-FDMA, 50% RB, 20 MHz, QPSK)	X	2.93	71.67	17.91	0.00	150.0	± 9.6 %
		Y	3.03	70.79	17.22		150.0	
		Z	2.77	69.28	16.35		150.0	
10298-AAB	LTE-FDD (SC-FDMA, 50% RB, 3 MHz, QPSK)	X	1.80	70.98	15.29	0.00	150.0	± 9.6 %
		Y	1.94	70.01	16.02		150.0	
		Z	1.64	67.53	14.38		150.0	
10299-AAB	LTE-FDD (SC-FDMA, 50% RB, 3 MHz, 16-QAM)	X	2.25	68.93	13.39	0.00	150.0	± 9.6 %
		Y	3.57	73.44	16.90		150.0	
		Z	2.68	69.23	14.47		150.0	
10300-AAB	LTE-FDD (SC-FDMA, 50% RB, 3 MHz, 64-QAM)	X	1.52	63.47	9.92	0.00	150.0	± 9.6 %
		Y	2.60	68.00	13.77		150.0	
		Z	2.12	65.38	11.93		150.0	
10301-AAA	IEEE 802.16e WiMAX (29:18, 5ms, 10MHz, QPSK, PUSC)	X	4.73	66.14	17.79	4.17	50.0	± 9.6 %
		Y	5.14	66.14	17.98		50.0	
		Z	4.87	65.30	17.38		50.0	
10302-AAA	IEEE 802.16e WiMAX (29:18, 5ms, 10MHz, QPSK, PUSC, 3 CTRL symbols)	X	5.19	66.64	18.43	4.96	50.0	± 9.6 %
		Y	5.69	67.11	18.91		50.0	
		Z	5.42	66.20	18.24		50.0	



10303-AAA	IEEE 802.16e WiMAX (31:15, 5ms, 10MHz, 64QAM, PUSC)	X	4.96	66.34	18.27	4.96	50.0	± 9.6 %
		Y	5.48	66.96	18.88		50.0	
		Z	5.20	65.95	18.14		50.0	
10304-AAA	IEEE 802.16e WiMAX (29:18, 5ms, 10MHz, 64QAM, PUSC)	X	4.76	66.23	17.80	4.17	50.0	± 9.6 %
		Y	5.21	66.54	18.19		50.0	
		Z	4.96	65.68	17.56		50.0	
10305-AAA	IEEE 802.16e WiMAX (31:15, 10ms, 10MHz, 64QAM, PUSC, 15 symbols)	X	4.83	70.07	20.50	6.02	35.0	± 9.6 %
		Y	5.51	71.60	22.16		35.0	
		Z	4.98	69.23	20.55		35.0	
10306-AAA	IEEE 802.16e WiMAX (29:18, 10ms, 10MHz, 64QAM, PUSC, 18 symbols)	X	4.91	68.09	19.77	6.02	35.0	± 9.6 %
		Y	5.42	68.18	20.25		35.0	
		Z	5.11	67.47	19.73		35.0	
10307-AAA	IEEE 802.16e WiMAX (29:18, 10ms, 10MHz, QPSK, PUSC, 18 symbols)	X	4.83	68.37	19.78	6.02	35.0	± 9.6 %
		Y	5.47	69.61	21.06		35.0	
		Z	5.07	67.89	19.81		35.0	
10308-AAA	IEEE 802.16e WiMAX (29:18, 10ms, 10MHz, 16QAM, PUSC)	X	4.84	68.69	19.98	6.02	35.0	± 9.6 %
		Y	5.46	69.92	21.24		35.0	
		Z	5.05	68.12	19.96		35.0	
10309-AAA	IEEE 802.16e WiMAX (29:18, 10ms, 10MHz, 16QAM, AMC 2x3, 18 symbols)	X	4.94	68.23	19.88	6.02	35.0	± 9.6 %
		Y	5.52	68.51	20.43		35.0	
		Z	5.19	67.72	19.88		35.0	
10310-AAA	IEEE 802.16e WiMAX (29:18, 10ms, 10MHz, QPSK, AMC 2x3, 18 symbols)	X	4.88	68.25	19.79	6.02	35.0	± 9.6 %
		Y	5.44	69.18	20.91		35.0	
		Z	5.08	67.61	19.74		35.0	
10311-AAA	LTE-FDD (SC-FDMA, 100% RB, 15 MHz, QPSK)	X	3.31	70.70	17.41	0.00	150.0	± 9.6 %
		Y	3.40	70.05	16.83		150.0	
		Z	3.13	68.65	16.04		150.0	
10313-AAA	iDEN 1:3	X	4.31	74.90	16.96	6.99	70.0	± 9.6 %
		Y	5.76	76.90	17.84		70.0	
		Z	4.08	72.13	15.67		70.0	
10314-AAA	iDEN 1:6	X	7.33	84.94	23.33	10.00	30.0	± 9.6 %
		Y	7.31	83.11	22.80		30.0	
		Z	4.98	76.71	20.14		30.0	
10315-AAB	IEEE 802.11b WiFi 2.4 GHz (DSSS, 1 Mbps, 96pc duty cycle)	X	1.15	65.39	16.53	0.17	150.0	± 9.6 %
		Y	1.15	64.64	15.92		150.0	
		Z	1.10	63.46	14.86		150.0	
10316-AAB	IEEE 802.11g WiFi 2.4 GHz (ERP-OFDM, 6 Mbps, 96pc duty cycle)	X	4.52	67.01	16.57	0.17	150.0	± 9.6 %
		Y	4.73	66.76	16.44		150.0	
		Z	4.65	66.51	16.17		150.0	
10317-AAB	IEEE 802.11a WiFi 5 GHz (OFDM, 6 Mbps, 96pc duty cycle)	X	4.52	67.01	16.57	0.17	150.0	± 9.6 %
		Y	4.73	66.76	16.44		150.0	
		Z	4.65	66.51	16.17		150.0	
10400-AAC	IEEE 802.11ac WiFi (20MHz, 64-QAM, 99pc duty cycle)	X	4.62	67.36	16.62	0.00	150.0	± 9.6 %
		Y	4.87	67.12	16.43		150.0	
		Z	4.77	66.88	16.19		150.0	
10401-AAC	IEEE 802.11ac WiFi (40MHz, 64-QAM, 99pc duty cycle)	X	5.32	67.33	16.68	0.00	150.0	± 9.6 %
		Y	5.49	67.16	16.50		150.0	
		Z	5.43	67.01	16.32		150.0	

10402-AAC	IEEE 802.11ac WiFi (80MHz, 64-QAM, 99pc duty cycle)	X	5.60	67.66	16.72	0.00	150.0	± 9.6 %
		Y	5.79	67.68	16.60		150.0	
		Z	5.72	67.47	16.40		150.0	
10403-AAB	CDMA2000 (1xEV-DO, Rev. 0)	X	2.16	75.12	16.21	0.00	115.0	± 9.6 %
		Y	1.91	71.91	16.34		115.0	
		Z	1.49	68.32	14.21		115.0	
10404-AAB	CDMA2000 (1xEV-DO, Rev. A)	X	2.16	75.12	16.21	0.00	115.0	± 9.6 %
		Y	1.91	71.91	16.34		115.0	
		Z	1.49	68.32	14.21		115.0	
10406-AAB	CDMA2000, RC3, SO32, SCH0, Full Rate	X	100.00	127.59	32.37	0.00	100.0	± 9.6 %
		Y	100.00	123.98	31.83		100.0	
		Z	14.26	95.15	24.05		100.0	
10410-AAA	LTE-TDD (SC-FDMA, 1 RB, 10 MHz, QPSK, UL Subframe=2,3,4,7,8,9)	X	100.00	124.06	30.89	3.23	80.0	± 9.6 %
		Y	100.00	119.95	30.07		80.0	
		Z	11.66	89.63	21.52		80.0	
10415-AAA	IEEE 802.11b WiFi 2.4 GHz (DSSS, 1 Mbps, 99pc duty cycle)	X	1.06	64.51	16.01	0.00	150.0	± 9.6 %
		Y	1.04	63.51	15.25		150.0	
		Z	1.01	62.60	14.33		150.0	
10416-AAA	IEEE 802.11g WiFi 2.4 GHz (ERP-OFDM, 6 Mbps, 99pc duty cycle)	X	4.49	67.08	16.58	0.00	150.0	± 9.6 %
		Y	4.67	66.72	16.37		150.0	
		Z	4.59	66.53	16.14		150.0	
10417-AAA	IEEE 802.11a/h WiFi 5 GHz (OFDM, 6 Mbps, 99pc duty cycle)	X	4.49	67.08	16.58	0.00	150.0	± 9.6 %
		Y	4.67	66.72	16.37		150.0	
		Z	4.59	66.53	16.14		150.0	
10418-AAA	IEEE 802.11g WiFi 2.4 GHz (DSSS-OFDM, 6 Mbps, 99pc duty cycle, Long preamble)	X	4.49	67.30	16.63	0.00	150.0	± 9.6 %
		Y	4.65	66.87	16.37		150.0	
		Z	4.58	66.67	16.15		150.0	
10419-AAA	IEEE 802.11g WiFi 2.4 GHz (DSSS-OFDM, 6 Mbps, 99pc duty cycle, Short preamble)	X	4.50	67.22	16.62	0.00	150.0	± 9.6 %
		Y	4.68	66.82	16.38		150.0	
		Z	4.60	66.63	16.16		150.0	
10422-AAA	IEEE 802.11n (HT Greenfield, 7.2 Mbps, BPSK)	X	4.61	67.18	16.61	0.00	150.0	± 9.6 %
		Y	4.80	66.83	16.39		150.0	
		Z	4.73	66.64	16.18		150.0	
10423-AAA	IEEE 802.11n (HT Greenfield, 43.3 Mbps, 16-QAM)	X	4.75	67.46	16.71	0.00	150.0	± 9.6 %
		Y	5.00	67.20	16.53		150.0	
		Z	4.91	66.98	16.30		150.0	
10424-AAA	IEEE 802.11n (HT Greenfield, 72.2 Mbps, 64-QAM)	X	4.68	67.42	16.69	0.00	150.0	± 9.6 %
		Y	4.91	67.14	16.49		150.0	
		Z	4.82	66.93	16.27		150.0	
10425-AAA	IEEE 802.11n (HT Greenfield, 15 Mbps, BPSK)	X	5.29	67.59	16.82	0.00	150.0	± 9.6 %
		Y	5.47	67.41	16.61		150.0	
		Z	5.41	67.25	16.44		150.0	
10426-AAA	IEEE 802.11n (HT Greenfield, 90 Mbps, 16-QAM)	X	5.31	67.68	16.86	0.00	150.0	± 9.6 %
		Y	5.48	67.44	16.63		150.0	
		Z	5.41	67.26	16.44		150.0	

10427-AAA	IEEE 802.11n (HT Greenfield, 150 Mbps, 64-QAM)	X	5.29	67.52	16.78	0.00	150.0	± 9.6 %
		Y	5.50	67.46	16.63		150.0	
		Z	5.43	67.26	16.43		150.0	
10430-AAA	LTE-FDD (OFDMA, 5 MHz, E-TM 3.1)	X	4.63	73.67	19.48	0.00	150.0	± 9.6 %
		Y	4.38	70.39	18.28		150.0	
		Z	4.34	70.59	18.21		150.0	
10431-AAA	LTE-FDD (OFDMA, 10 MHz, E-TM 3.1)	X	4.15	67.84	16.60	0.00	150.0	± 9.6 %
		Y	4.40	67.31	16.45		150.0	
		Z	4.29	67.04	16.16		150.0	
10432-AAA	LTE-FDD (OFDMA, 15 MHz, E-TM 3.1)	X	4.45	67.57	16.66	0.00	150.0	± 9.6 %
		Y	4.69	67.19	16.47		150.0	
		Z	4.59	66.95	16.22		150.0	
10433-AAA	LTE-FDD (OFDMA, 20 MHz, E-TM 3.1)	X	4.70	67.46	16.71	0.00	150.0	± 9.6 %
		Y	4.93	67.18	16.52		150.0	
		Z	4.84	66.96	16.29		150.0	
10434-AAA	W-CDMA (BS Test Model 1, 64 DPCH)	X	4.94	75.22	19.61	0.00	150.0	± 9.6 %
		Y	4.49	71.19	18.31		150.0	
		Z	4.45	71.43	18.22		150.0	
10435-AAA	LTE-TDD (SC-FDMA, 1 RB, 20 MHz, QPSK, UL Subframe=2,3,4,7,8,9)	X	100.00	123.75	30.75	3.23	80.0	± 9.6 %
		Y	100.00	119.75	29.98		80.0	
		Z	11.13	88.92	21.27		80.0	
10447-AAA	LTE-FDD (OFDMA, 5 MHz, E-TM 3.1, Clipping 44%)	X	3.46	68.09	15.85	0.00	150.0	± 9.6 %
		Y	3.73	67.44	16.02		150.0	
		Z	3.59	67.02	15.56		150.0	
10448-AAA	LTE-FDD (OFDMA, 10 MHz, E-TM 3.1, Clipping 44%)	X	4.01	67.64	16.48	0.00	150.0	± 9.6 %
		Y	4.23	67.09	16.31		150.0	
		Z	4.12	66.82	16.01		150.0	
10449-AAA	LTE-FDD (OFDMA, 15 MHz, E-TM 3.1, Clipping 44%)	X	4.28	67.42	16.58	0.00	150.0	± 9.6 %
		Y	4.48	67.02	16.38		150.0	
		Z	4.39	66.78	16.12		150.0	
10450-AAA	LTE-FDD (OFDMA, 20 MHz, E-TM 3.1, Clipping 44%)	X	4.48	67.25	16.58	0.00	150.0	± 9.6 %
		Y	4.66	66.95	16.38		150.0	
		Z	4.58	66.72	16.14		150.0	
10451-AAA	W-CDMA (BS Test Model 1, 64 DPCH, Clipping 44%)	X	3.33	68.18	15.32	0.00	150.0	± 9.6 %
		Y	3.67	67.76	15.79		150.0	
		Z	3.50	67.23	15.24		150.0	
10456-AAA	IEEE 802.11ac WiFi (160MHz, 64-QAM, 99pc duty cycle)	X	6.23	68.21	17.00	0.00	150.0	± 9.6 %
		Y	6.33	68.03	16.78		150.0	
		Z	6.26	67.85	16.61		150.0	
10457-AAA	UMTS-FDD (DC-HSDPA)	X	3.79	65.76	16.30	0.00	150.0	± 9.6 %
		Y	3.86	65.36	16.10		150.0	
		Z	3.82	65.17	15.85		150.0	
10458-AAA	CDMA2000 (1xEV-DO, Rev. B, 2 carriers)	X	3.05	67.01	14.29	0.00	150.0	± 9.6 %
		Y	3.48	67.05	15.31		150.0	
		Z	3.32	66.56	14.71		150.0	
10459-AAA	CDMA2000 (1xEV-DO, Rev. B, 3 carriers)	X	4.19	65.60	15.56	0.00	150.0	± 9.6 %
		Y	4.63	65.36	16.07		150.0	
		Z	4.50	65.15	15.72		150.0	

10460-AAA	UMTS-FDD (WCDMA, AMR)	X	1.27	75.41	20.14	0.00	150.0	± 9.6 %
		Y	1.05	70.71	17.81		150.0	
		Z	0.86	66.76	15.37		150.0	
10461-AAA	LTE-TDD (SC-FDMA, 1 RB, 1.4 MHz, QPSK, UL Subframe=2,3,4,7,8,9)	X	100.00	127.84	32.72	3.29	80.0	± 9.6 %
		Y	100.00	123.27	31.69		80.0	
		Z	6.47	83.77	20.46		80.0	
10462-AAA	LTE-TDD (SC-FDMA, 1 RB, 1.4 MHz, 16-QAM, UL Subframe=2,3,4,7,8,9)	X	1.26	63.91	10.22	3.23	80.0	± 9.6 %
		Y	14.90	86.82	19.02		80.0	
		Z	1.81	64.45	10.77		80.0	
10463-AAA	LTE-TDD (SC-FDMA, 1 RB, 1.4 MHz, 64-QAM, UL Subframe=2,3,4,7,8,9)	X	0.85	60.00	7.76	3.23	80.0	± 9.6 %
		Y	4.74	73.69	14.47		80.0	
		Z	1.46	62.00	9.21		80.0	
10464-AAA	LTE-TDD (SC-FDMA, 1 RB, 3 MHz, QPSK, UL Subframe=2,3,4,7,8,9)	X	100.00	124.65	31.09	3.23	80.0	± 9.6 %
		Y	100.00	121.04	30.50		80.0	
		Z	5.02	79.91	18.70		80.0	
10465-AAA	LTE-TDD (SC-FDMA, 1 RB, 3 MHz, 16-QAM, UL Subframe=2,3,4,7,8,9)	X	1.13	62.86	9.67	3.23	80.0	± 9.6 %
		Y	9.25	81.62	17.45		80.0	
		Z	1.69	63.74	10.38		80.0	
10466-AAA	LTE-TDD (SC-FDMA, 1 RB, 3 MHz, 64-QAM, UL Subframe=2,3,4,7,8,9)	X	0.85	60.00	7.71	3.23	80.0	± 9.6 %
		Y	3.78	71.31	13.57		80.0	
		Z	1.40	61.59	8.96		80.0	
10467-AAA	LTE-TDD (SC-FDMA, 1 RB, 5 MHz, QPSK, UL Subframe=2,3,4,7,8,9)	X	100.00	125.03	31.26	3.23	80.0	± 9.6 %
		Y	100.00	121.26	30.60		80.0	
		Z	5.32	80.71	18.99		80.0	
10468-AAA	LTE-TDD (SC-FDMA, 1 RB, 5 MHz, 16-QAM, UL Subframe=2,3,4,7,8,9)	X	1.17	63.15	9.83	3.23	80.0	± 9.6 %
		Y	10.30	82.81	17.81		80.0	
		Z	1.71	63.90	10.47		80.0	
10469-AAA	LTE-TDD (SC-FDMA, 1 RB, 5 MHz, 64-QAM, UL Subframe=2,3,4,7,8,9)	X	0.85	60.00	7.71	3.23	80.0	± 9.6 %
		Y	3.80	71.39	13.60		80.0	
		Z	1.40	61.60	8.96		80.0	
10470-AAA	LTE-TDD (SC-FDMA, 1 RB, 10 MHz, QPSK, UL Subframe=2,3,4,7,8,9)	X	100.00	125.05	31.26	3.23	80.0	± 9.6 %
		Y	100.00	121.29	30.60		80.0	
		Z	5.31	80.70	18.98		80.0	
10471-AAA	LTE-TDD (SC-FDMA, 1 RB, 10 MHz, 16-QAM, UL Subframe=2,3,4,7,8,9)	X	1.16	63.09	9.79	3.23	80.0	± 9.6 %
		Y	10.21	82.69	17.77		80.0	
		Z	1.70	63.86	10.44		80.0	
10472-AAA	LTE-TDD (SC-FDMA, 1 RB, 10 MHz, 64-QAM, UL Subframe=2,3,4,7,8,9)	X	0.85	60.00	7.70	3.23	80.0	± 9.6 %
		Y	3.77	71.31	13.56		80.0	
		Z	1.40	61.57	8.94		80.0	
10473-AAA	LTE-TDD (SC-FDMA, 1 RB, 15 MHz, QPSK, UL Subframe=2,3,4,7,8,9)	X	100.00	125.02	31.24	3.23	80.0	± 9.6 %
		Y	100.00	121.25	30.59		80.0	
		Z	5.30	80.66	18.96		80.0	
10474-AAA	LTE-TDD (SC-FDMA, 1 RB, 15 MHz, 16-QAM, UL Subframe=2,3,4,7,8,9)	X	1.15	63.05	9.77	3.23	80.0	± 9.6 %
		Y	10.08	82.57	17.73		80.0	
		Z	1.70	63.84	10.43		80.0	
10475-AAA	LTE-TDD (SC-FDMA, 1 RB, 15 MHz, 64-QAM, UL Subframe=2,3,4,7,8,9)	X	0.85	60.00	7.70	3.23	80.0	± 9.6 %
		Y	3.75	71.25	13.54		80.0	
		Z	1.39	61.55	8.93		80.0	

10477-AAA	LTE-TDD (SC-FDMA, 1 RB, 20 MHz, 16-QAM, UL Subframe=2,3,4,7,8,9)	X	1.12	62.81	9.63	3.23	80.0	± 9.6 %
		Y	9.29	81.66	17.43		80.0	
		Z	1.68	63.69	10.35		80.0	
10478-AAA	LTE-TDD (SC-FDMA, 1 RB, 20 MHz, 64-QAM, UL Subframe=2,3,4,7,8,9)	X	0.85	60.00	7.69	3.23	80.0	± 9.6 %
		Y	3.71	71.13	13.49		80.0	
		Z	1.39	61.52	8.91		80.0	
10479-AAA	LTE-TDD (SC-FDMA, 50% RB, 1.4 MHz, QPSK, UL Subframe=2,3,4,7,8,9)	X	16.34	98.15	26.22	3.23	80.0	± 9.6 %
		Y	8.05	85.58	23.31		80.0	
		Z	4.44	75.80	19.08		80.0	
10480-AAA	LTE-TDD (SC-FDMA, 50% RB, 1.4 MHz, 16-QAM, UL Subframe=2,3,4,7,8,9)	X	8.15	82.28	19.17	3.23	80.0	± 9.6 %
		Y	9.14	82.89	20.82		80.0	
		Z	4.48	72.61	16.42		80.0	
10481-AAA	LTE-TDD (SC-FDMA, 50% RB, 1.4 MHz, 64-QAM, UL Subframe=2,3,4,7,8,9)	X	4.98	75.50	16.46	3.23	80.0	± 9.6 %
		Y	7.94	80.29	19.62		80.0	
		Z	4.00	70.70	15.36		80.0	
10482-AAA	LTE-TDD (SC-FDMA, 50% RB, 3 MHz, QPSK, UL Subframe=2,3,4,7,8,9)	X	3.11	72.47	16.27	2.23	80.0	± 9.6 %
		Y	4.49	76.30	19.03		80.0	
		Z	2.84	69.51	15.71		80.0	
10483-AAA	LTE-TDD (SC-FDMA, 50% RB, 3 MHz, 16-QAM, UL Subframe=2,3,4,7,8,9)	X	3.23	69.48	14.33	2.23	80.0	± 9.6 %
		Y	6.12	77.20	19.06		80.0	
		Z	3.70	69.78	15.41		80.0	
10484-AAA	LTE-TDD (SC-FDMA, 50% RB, 3 MHz, 64-QAM, UL Subframe=2,3,4,7,8,9)	X	2.99	68.30	13.84	2.23	80.0	± 9.6 %
		Y	5.80	76.19	18.70		80.0	
		Z	3.62	69.26	15.20		80.0	
10485-AAA	LTE-TDD (SC-FDMA, 50% RB, 5 MHz, QPSK, UL Subframe=2,3,4,7,8,9)	X	3.90	76.03	18.96	2.23	80.0	± 9.6 %
		Y	4.65	76.77	19.89		80.0	
		Z	3.19	70.88	17.04		80.0	
10486-AAA	LTE-TDD (SC-FDMA, 50% RB, 5 MHz, 16-QAM, UL Subframe=2,3,4,7,8,9)	X	3.22	69.78	15.73	2.23	80.0	± 9.6 %
		Y	4.07	71.59	17.54		80.0	
		Z	3.24	68.15	15.55		80.0	
10487-AAA	LTE-TDD (SC-FDMA, 50% RB, 5 MHz, 64-QAM, UL Subframe=2,3,4,7,8,9)	X	3.17	69.19	15.46	2.23	80.0	± 9.6 %
		Y	4.05	71.16	17.36		80.0	
		Z	3.26	67.91	15.45		80.0	
10488-AAA	LTE-TDD (SC-FDMA, 50% RB, 10 MHz, QPSK, UL Subframe=2,3,4,7,8,9)	X	3.89	74.31	19.36	2.23	80.0	± 9.6 %
		Y	4.74	75.31	19.78		80.0	
		Z	3.62	70.94	17.62		80.0	
10489-AAA	LTE-TDD (SC-FDMA, 50% RB, 10 MHz, 16-QAM, UL Subframe=2,3,4,7,8,9)	X	3.61	70.11	17.53	2.23	80.0	± 9.6 %
		Y	4.17	70.61	18.05		80.0	
		Z	3.61	68.29	16.66		80.0	
10490-AAA	LTE-TDD (SC-FDMA, 50% RB, 10 MHz, 64-QAM, UL Subframe=2,3,4,7,8,9)	X	3.68	69.86	17.43	2.23	80.0	± 9.6 %
		Y	4.25	70.34	17.96		80.0	
		Z	3.72	68.19	16.64		80.0	
10491-AAA	LTE-TDD (SC-FDMA, 50% RB, 15 MHz, QPSK, UL Subframe=2,3,4,7,8,9)	X	3.96	72.11	18.69	2.23	80.0	± 9.6 %
		Y	4.74	73.16	19.02		80.0	
		Z	3.92	70.03	17.39		80.0	
10492-AAA	LTE-TDD (SC-FDMA, 50% RB, 15 MHz, 16-QAM, UL Subframe=2,3,4,7,8,9)	X	3.88	69.01	17.48	2.23	80.0	± 9.6 %
		Y	4.46	69.66	17.87		80.0	
		Z	4.00	67.90	16.78		80.0	

10493-AAA	LTE-TDD (SC-FDMA, 50% RB, 15 MHz, 64-QAM, UL Subframe=2,3,4,7,8,9)	X	3.93	68.84	17.41	2.23	80.0	± 9.6 %
		Y	4.52	69.48	17.82		80.0	
		Z	4.08	67.81	16.77		80.0	
10494-AAA	LTE-TDD (SC-FDMA, 50% RB, 20 MHz, QPSK, UL Subframe=2,3,4,7,8,9)	X	4.32	73.69	19.20	2.23	80.0	± 9.6 %
		Y	5.29	75.06	19.58		80.0	
		Z	4.18	71.25	17.73		80.0	
10495-AAA	LTE-TDD (SC-FDMA, 50% RB, 20 MHz, 16-QAM, UL Subframe=2,3,4,7,8,9)	X	3.92	69.34	17.70	2.23	80.0	± 9.6 %
		Y	4.53	70.19	18.09		80.0	
		Z	4.04	68.27	16.95		80.0	
10496-AAA	LTE-TDD (SC-FDMA, 50% RB, 20 MHz, 64-QAM, UL Subframe=2,3,4,7,8,9)	X	3.98	69.05	17.60	2.23	80.0	± 9.6 %
		Y	4.58	69.81	17.97		80.0	
		Z	4.12	68.07	16.91		80.0	
10497-AAA	LTE-TDD (SC-FDMA, 100% RB, 1.4 MHz, QPSK, UL Subframe=2,3,4,7,8,9)	X	1.72	64.88	11.75	2.23	80.0	± 9.6 %
		Y	3.58	73.16	17.12		80.0	
		Z	2.20	66.42	13.58		80.0	
10498-AAA	LTE-TDD (SC-FDMA, 100% RB, 1.4 MHz, 16-QAM, UL Subframe=2,3,4,7,8,9)	X	1.30	60.00	8.13	2.23	80.0	± 9.6 %
		Y	2.81	67.13	13.70		80.0	
		Z	1.98	62.85	11.00		80.0	
10499-AAA	LTE-TDD (SC-FDMA, 100% RB, 1.4 MHz, 64-QAM, UL Subframe=2,3,4,7,8,9)	X	1.32	60.00	7.98	2.23	80.0	± 9.6 %
		Y	2.75	66.54	13.31		80.0	
		Z	1.95	62.46	10.68		80.0	
10500-AAA	LTE-TDD (SC-FDMA, 100% RB, 3 MHz, QPSK, UL Subframe=2,3,4,7,8,9)	X	3.82	75.04	19.03	2.23	80.0	± 9.6 %
		Y	4.55	75.62	19.66		80.0	
		Z	3.32	70.66	17.20		80.0	
10501-AAA	LTE-TDD (SC-FDMA, 100% RB, 3 MHz, 16-QAM, UL Subframe=2,3,4,7,8,9)	X	3.45	70.22	16.55	2.23	80.0	± 9.6 %
		Y	4.10	71.10	17.69		80.0	
		Z	3.41	68.23	15.99		80.0	
10502-AAA	LTE-TDD (SC-FDMA, 100% RB, 3 MHz, 64-QAM, UL Subframe=2,3,4,7,8,9)	X	3.48	69.95	16.36	2.23	80.0	± 9.6 %
		Y	4.15	70.89	17.57		80.0	
		Z	3.47	68.14	15.91		80.0	
10503-AAA	LTE-TDD (SC-FDMA, 100% RB, 5 MHz, QPSK, UL Subframe=2,3,4,7,8,9)	X	3.83	74.06	19.24	2.23	80.0	± 9.6 %
		Y	4.68	75.11	19.69		80.0	
		Z	3.58	70.77	17.54		80.0	
10504-AAA	LTE-TDD (SC-FDMA, 100% RB, 5 MHz, 16-QAM, UL Subframe=2,3,4,7,8,9)	X	3.59	69.99	17.46	2.23	80.0	± 9.6 %
		Y	4.16	70.53	18.00		80.0	
		Z	3.60	68.21	16.61		80.0	
10505-AAA	LTE-TDD (SC-FDMA, 100% RB, 5 MHz, 64-QAM, UL Subframe=2,3,4,7,8,9)	X	3.66	69.75	17.36	2.23	80.0	± 9.6 %
		Y	4.23	70.25	17.91		80.0	
		Z	3.70	68.11	16.59		80.0	
10506-AAA	LTE-TDD (SC-FDMA, 100% RB, 10 MHz, QPSK, UL Subframe=2,3,4,7,8,9)	X	4.28	73.52	19.12	2.23	80.0	± 9.6 %
		Y	5.24	74.92	19.51		80.0	
		Z	4.15	71.12	17.66		80.0	
10507-AAA	LTE-TDD (SC-FDMA, 100% RB, 10 MHz, 16-QAM, UL Subframe=2,3,4,7,8,9)	X	3.90	69.27	17.66	2.23	80.0	± 9.6 %
		Y	4.51	70.14	18.06		80.0	
		Z	4.02	68.21	16.91		80.0	

10508-AAA	LTE-TDD (SC-FDMA, 100% RB, 10 MHz, 64-QAM, UL Subframe=2,3,4,7,8,9)	X	3.97	68.96	17.55	2.23	80.0	± 9.6 %
		Y	4.57	69.75	17.93		80.0	
		Z	4.11	68.00	16.87		80.0	
10509-AAA	LTE-TDD (SC-FDMA, 100% RB, 15 MHz, QPSK, UL Subframe=2,3,4,7,8,9)	X	4.54	71.87	18.48	2.23	80.0	± 9.6 %
		Y	5.35	73.05	18.77		80.0	
		Z	4.54	70.32	17.38		80.0	
10510-AAA	LTE-TDD (SC-FDMA, 100% RB, 15 MHz, 16-QAM, UL Subframe=2,3,4,7,8,9)	X	4.34	68.76	17.59	2.23	80.0	± 9.6 %
		Y	4.97	69.73	17.95		80.0	
		Z	4.53	68.16	17.00		80.0	
10511-AAA	LTE-TDD (SC-FDMA, 100% RB, 15 MHz, 64-QAM, UL Subframe=2,3,4,7,8,9)	X	4.39	68.51	17.51	2.23	80.0	± 9.6 %
		Y	5.00	69.40	17.85		80.0	
		Z	4.59	67.95	16.96		80.0	
10512-AAA	LTE-TDD (SC-FDMA, 100% RB, 20 MHz, QPSK, UL Subframe=2,3,4,7,8,9)	X	4.78	73.48	18.98	2.23	80.0	± 9.6 %
		Y	5.80	75.09	19.41		80.0	
		Z	4.67	71.54	17.71		80.0	
10513-AAA	LTE-TDD (SC-FDMA, 100% RB, 20 MHz, 16-QAM, UL Subframe=2,3,4,7,8,9)	X	4.24	69.00	17.69	2.23	80.0	± 9.6 %
		Y	4.89	70.17	18.11		80.0	
		Z	4.41	68.40	17.07		80.0	
10514-AAA	LTE-TDD (SC-FDMA, 100% RB, 20 MHz, 64-QAM, UL Subframe=2,3,4,7,8,9)	X	4.26	68.58	17.56	2.23	80.0	± 9.6 %
		Y	4.87	69.63	17.95		80.0	
		Z	4.44	68.04	16.99		80.0	
10515-AAA	IEEE 802.11b WiFi 2.4 GHz (DSSS, 2 Mbps, 99pc duty cycle)	X	1.03	64.84	16.18	0.00	150.0	± 9.6 %
		Y	1.01	63.76	15.35		150.0	
		Z	0.97	62.74	14.37		150.0	
10516-AAA	IEEE 802.11b WiFi 2.4 GHz (DSSS, 5.5 Mbps, 99pc duty cycle)	X	1.37	87.37	25.57	0.00	150.0	± 9.6 %
		Y	0.82	76.24	20.55		150.0	
		Z	0.54	67.46	15.73		150.0	
10517-AAA	IEEE 802.11b WiFi 2.4 GHz (DSSS, 11 Mbps, 99pc duty cycle)	X	0.93	68.34	17.75	0.00	150.0	± 9.6 %
		Y	0.89	66.40	16.42		150.0	
		Z	0.81	64.28	14.78		150.0	
10518-AAA	IEEE 802.11a/h WiFi 5 GHz (OFDM, 9 Mbps, 99pc duty cycle)	X	4.48	67.19	16.57	0.00	150.0	± 9.6 %
		Y	4.66	66.80	16.35		150.0	
		Z	4.59	66.60	16.12		150.0	
10519-AAA	IEEE 802.11a/h WiFi 5 GHz (OFDM, 12 Mbps, 99pc duty cycle)	X	4.64	67.36	16.66	0.00	150.0	± 9.6 %
		Y	4.88	67.08	16.48		150.0	
		Z	4.79	66.86	16.25		150.0	
10520-AAA	IEEE 802.11a/h WiFi 5 GHz (OFDM, 18 Mbps, 99pc duty cycle)	X	4.50	67.33	16.59	0.00	150.0	± 9.6 %
		Y	4.73	67.07	16.42		150.0	
		Z	4.64	66.83	16.17		150.0	
10521-AAA	IEEE 802.11a/h WiFi 5 GHz (OFDM, 24 Mbps, 99pc duty cycle)	X	4.43	67.32	16.58	0.00	150.0	± 9.6 %
		Y	4.66	67.08	16.41		150.0	
		Z	4.57	66.82	16.16		150.0	
10522-AAA	IEEE 802.11a/h WiFi 5 GHz (OFDM, 36 Mbps, 99pc duty cycle)	X	4.49	67.45	16.68	0.00	150.0	± 9.6 %
		Y	4.71	67.07	16.44		150.0	
		Z	4.62	66.87	16.22		150.0	

10523-AAA	IEEE 802.11a/h WiFi 5 GHz (OFDM, 48 Mbps, 99pc duty cycle)	X	4.40	67.41	16.59	0.00	150.0	± 9.6 %
		Y	4.58	66.97	16.31		150.0	
		Z	4.50	66.74	16.07		150.0	
10524-AAA	IEEE 802.11a/h WiFi 5 GHz (OFDM, 54 Mbps, 99pc duty cycle)	X	4.44	67.39	16.66	0.00	150.0	± 9.6 %
		Y	4.66	67.02	16.43		150.0	
		Z	4.57	66.80	16.19		150.0	
10525-AAA	IEEE 802.11ac WiFi (20MHz, MCS0, 99pc duty cycle)	X	4.46	66.48	16.28	0.00	150.0	± 9.6 %
		Y	4.62	66.06	16.02		150.0	
		Z	4.54	65.85	15.79		150.0	
10526-AAA	IEEE 802.11ac WiFi (20MHz, MCS1, 99pc duty cycle)	X	4.60	66.79	16.40	0.00	150.0	± 9.6 %
		Y	4.82	66.46	16.16		150.0	
		Z	4.72	66.22	15.93		150.0	
10527-AAA	IEEE 802.11ac WiFi (20MHz, MCS2, 99pc duty cycle)	X	4.53	66.77	16.35	0.00	150.0	± 9.6 %
		Y	4.74	66.44	16.12		150.0	
		Z	4.64	66.19	15.88		150.0	
10528-AAA	IEEE 802.11ac WiFi (20MHz, MCS3, 99pc duty cycle)	X	4.54	66.78	16.38	0.00	150.0	± 9.6 %
		Y	4.75	66.46	16.15		150.0	
		Z	4.66	66.21	15.91		150.0	
10529-AAA	IEEE 802.11ac WiFi (20MHz, MCS4, 99pc duty cycle)	X	4.54	66.78	16.38	0.00	150.0	± 9.6 %
		Y	4.75	66.46	16.15		150.0	
		Z	4.66	66.21	15.91		150.0	
10531-AAA	IEEE 802.11ac WiFi (20MHz, MCS6, 99pc duty cycle)	X	4.52	66.84	16.38	0.00	150.0	± 9.6 %
		Y	4.76	66.60	16.18		150.0	
		Z	4.66	66.32	15.93		150.0	
10532-AAA	IEEE 802.11ac WiFi (20MHz, MCS7, 99pc duty cycle)	X	4.39	66.72	16.32	0.00	150.0	± 9.6 %
		Y	4.61	66.47	16.13		150.0	
		Z	4.51	66.18	15.86		150.0	
10533-AAA	IEEE 802.11ac WiFi (20MHz, MCS8, 99pc duty cycle)	X	4.55	66.87	16.39	0.00	150.0	± 9.6 %
		Y	4.77	66.48	16.13		150.0	
		Z	4.67	66.24	15.89		150.0	
10534-AAA	IEEE 802.11ac WiFi (40MHz, MCS0, 99pc duty cycle)	X	5.09	66.73	16.38	0.00	150.0	± 9.6 %
		Y	5.26	66.58	16.18		150.0	
		Z	5.19	66.36	15.98		150.0	
10535-AAA	IEEE 802.11ac WiFi (40MHz, MCS1, 99pc duty cycle)	X	5.14	66.89	16.46	0.00	150.0	± 9.6 %
		Y	5.33	66.72	16.24		150.0	
		Z	5.25	66.50	16.04		150.0	
10536-AAA	IEEE 802.11ac WiFi (40MHz, MCS2, 99pc duty cycle)	X	5.03	66.89	16.44	0.00	150.0	± 9.6 %
		Y	5.20	66.71	16.22		150.0	
		Z	5.12	66.47	16.01		150.0	
10537-AAA	IEEE 802.11ac WiFi (40MHz, MCS3, 99pc duty cycle)	X	5.08	66.84	16.42	0.00	150.0	± 9.6 %
		Y	5.27	66.68	16.21		150.0	
		Z	5.18	66.44	16.00		150.0	
10538-AAA	IEEE 802.11ac WiFi (40MHz, MCS4, 99pc duty cycle)	X	5.15	66.81	16.44	0.00	150.0	± 9.6 %
		Y	5.37	66.74	16.28		150.0	
		Z	5.28	66.49	16.06		150.0	
10540-AAA	IEEE 802.11ac WiFi (40MHz, MCS6, 99pc duty cycle)	X	5.09	66.80	16.45	0.00	150.0	± 9.6 %
		Y	5.28	66.69	16.27		150.0	
		Z	5.20	66.47	16.06		150.0	



10541-AAA	IEEE 802.11ac WiFi (40MHz, MCS7, 99pc duty cycle)	X	5.06	66.68	16.38	0.00	150.0	± 9.6 %
		Y	5.26	66.60	16.22		150.0	
		Z	5.18	66.36	16.00		150.0	
10542-AAA	IEEE 802.11ac WiFi (40MHz, MCS8, 99pc duty cycle)	X	5.22	66.77	16.43	0.00	150.0	± 9.6 %
		Y	5.41	66.64	16.25		150.0	
		Z	5.33	66.43	16.05		150.0	
10543-AAA	IEEE 802.11ac WiFi (40MHz, MCS9, 99pc duty cycle)	X	5.28	66.79	16.47	0.00	150.0	± 9.6 %
		Y	5.50	66.65	16.27		150.0	
		Z	5.41	66.46	16.08		150.0	
10544-AAA	IEEE 802.11ac WiFi (80MHz, MCS0, 99pc duty cycle)	X	5.42	66.77	16.34	0.00	150.0	± 9.6 %
		Y	5.55	66.69	16.17		150.0	
		Z	5.48	66.48	15.98		150.0	
10545-AAA	IEEE 802.11ac WiFi (80MHz, MCS1, 99pc duty cycle)	X	5.61	67.23	16.53	0.00	150.0	± 9.6 %
		Y	5.75	67.07	16.30		150.0	
		Z	5.67	66.87	16.11		150.0	
10546-AAA	IEEE 802.11ac WiFi (80MHz, MCS2, 99pc duty cycle)	X	5.46	66.92	16.38	0.00	150.0	± 9.6 %
		Y	5.64	66.96	16.27		150.0	
		Z	5.56	66.72	16.06		150.0	
10547-AAA	IEEE 802.11ac WiFi (80MHz, MCS3, 99pc duty cycle)	X	5.54	67.00	16.42	0.00	150.0	± 9.6 %
		Y	5.73	67.04	16.29		150.0	
		Z	5.64	66.77	16.07		150.0	
10548-AAA	IEEE 802.11ac WiFi (80MHz, MCS4, 99pc duty cycle)	X	5.73	67.79	16.78	0.00	150.0	± 9.6 %
		Y	5.99	67.96	16.73		150.0	
		Z	5.87	67.64	16.48		150.0	
10550-AAA	IEEE 802.11ac WiFi (80MHz, MCS6, 99pc duty cycle)	X	5.52	67.07	16.47	0.00	150.0	± 9.6 %
		Y	5.66	66.92	16.25		150.0	
		Z	5.58	66.70	16.06		150.0	
10551-AAA	IEEE 802.11ac WiFi (80MHz, MCS7, 99pc duty cycle)	X	5.47	66.93	16.36	0.00	150.0	± 9.6 %
		Y	5.67	66.99	16.25		150.0	
		Z	5.59	66.76	16.05		150.0	
10552-AAA	IEEE 802.11ac WiFi (80MHz, MCS8, 99pc duty cycle)	X	5.43	66.87	16.34	0.00	150.0	± 9.6 %
		Y	5.58	66.77	16.15		150.0	
		Z	5.50	66.55	15.96		150.0	
10553-AAA	IEEE 802.11ac WiFi (80MHz, MCS9, 99pc duty cycle)	X	5.49	66.84	16.35	0.00	150.0	± 9.6 %
		Y	5.67	66.82	16.21		150.0	
		Z	5.59	66.61	16.01		150.0	
10554-AAA	IEEE 1602.11ac WiFi (160MHz, MCS0, 99pc duty cycle)	X	5.84	67.09	16.40	0.00	150.0	± 9.6 %
		Y	5.94	67.05	16.25		150.0	
		Z	5.88	66.85	16.07		150.0	
10555-AAA	IEEE 1602.11ac WiFi (160MHz, MCS1, 99pc duty cycle)	X	5.95	67.36	16.52	0.00	150.0	± 9.6 %
		Y	6.09	67.37	16.39		150.0	
		Z	6.01	67.14	16.19		150.0	
10556-AAA	IEEE 1602.11ac WiFi (160MHz, MCS2, 99pc duty cycle)	X	5.98	67.45	16.56	0.00	150.0	± 9.6 %
		Y	6.10	67.39	16.39		150.0	
		Z	6.03	67.18	16.21		150.0	
10557-AAA	IEEE 1602.11ac WiFi (160MHz, MCS3, 99pc duty cycle)	X	5.93	67.31	16.50	0.00	150.0	± 9.6 %
		Y	6.09	67.35	16.39		150.0	
		Z	6.01	67.12	16.19		150.0	

10558-AAA	IEEE 1602.11ac WiFi (160MHz, MCS4, 99pc duty cycle)	X	5.96	67.43	16.58	0.00	150.0	± 9.6 %
		Y	6.14	67.53	16.50		150.0	
		Z	6.06	67.28	16.29		150.0	
10560-AAA	IEEE 1602.11ac WiFi (160MHz, MCS6, 99pc duty cycle)	X	5.96	67.30	16.55	0.00	150.0	± 9.6 %
		Y	6.14	67.38	16.46		150.0	
		Z	6.06	67.14	16.26		150.0	
10561-AAA	IEEE 1602.11ac WiFi (160MHz, MCS7, 99pc duty cycle)	X	5.90	67.30	16.59	0.00	150.0	± 9.6 %
		Y	6.05	67.33	16.47		150.0	
		Z	5.97	67.09	16.27		150.0	
10562-AAA	IEEE 1602.11ac WiFi (160MHz, MCS8, 99pc duty cycle)	X	5.97	67.52	16.70	0.00	150.0	± 9.6 %
		Y	6.20	67.78	16.70		150.0	
		Z	6.10	67.49	16.47		150.0	
10563-AAA	IEEE 1602.11ac WiFi (160MHz, MCS9, 99pc duty cycle)	X	6.05	67.43	16.61	0.00	150.0	± 9.6 %
		Y	6.51	68.26	16.88		150.0	
		Z	6.42	68.01	16.67		150.0	
10564-AAA	IEEE 802.11g WiFi 2.4 GHz (DSSS-OFDM, 9 Mbps, 99pc duty cycle)	X	4.79	67.15	16.65	0.46	150.0	± 9.6 %
		Y	4.99	66.89	16.50		150.0	
		Z	4.91	66.68	16.27		150.0	
10565-AAA	IEEE 802.11g WiFi 2.4 GHz (DSSS-OFDM, 12 Mbps, 99pc duty cycle)	X	5.00	67.58	16.97	0.46	150.0	± 9.6 %
		Y	5.25	67.37	16.83		150.0	
		Z	5.16	67.16	16.61		150.0	
10566-AAA	IEEE 802.11g WiFi 2.4 GHz (DSSS-OFDM, 18 Mbps, 99pc duty cycle)	X	4.83	67.41	16.78	0.46	150.0	± 9.6 %
		Y	5.08	67.24	16.66		150.0	
		Z	4.99	67.00	16.41		150.0	
10567-AAA	IEEE 802.11g WiFi 2.4 GHz (DSSS-OFDM, 24 Mbps, 99pc duty cycle)	X	4.88	67.87	17.20	0.46	150.0	± 9.6 %
		Y	5.11	67.62	16.99		150.0	
		Z	5.02	67.41	16.78		150.0	
10568-AAA	IEEE 802.11g WiFi 2.4 GHz (DSSS-OFDM, 36 Mbps, 99pc duty cycle)	X	4.73	67.14	16.52	0.46	150.0	± 9.6 %
		Y	4.99	66.97	16.41		150.0	
		Z	4.89	66.73	16.15		150.0	
10569-AAA	IEEE 802.11g WiFi 2.4 GHz (DSSS-OFDM, 48 Mbps, 99pc duty cycle)	X	4.86	68.08	17.32	0.46	150.0	± 9.6 %
		Y	5.05	67.63	17.01		150.0	
		Z	4.97	67.46	16.82		150.0	
10570-AAA	IEEE 802.11g WiFi 2.4 GHz (DSSS-OFDM, 54 Mbps, 99pc duty cycle)	X	4.87	67.85	17.21	0.46	150.0	± 9.6 %
		Y	5.09	67.48	16.95		150.0	
		Z	5.01	67.31	16.75		150.0	
10571-AAA	IEEE 802.11b WiFi 2.4 GHz (DSSS, 1 Mbps, 90pc duty cycle)	X	1.23	65.85	16.68	0.46	130.0	± 9.6 %
		Y	1.28	65.62	16.38		130.0	
		Z	1.20	64.12	15.14		130.0	
10572-AAA	IEEE 802.11b WiFi 2.4 GHz (DSSS, 2 Mbps, 90pc duty cycle)	X	1.26	66.61	17.14	0.46	130.0	± 9.6 %
		Y	1.30	66.27	16.76		130.0	
		Z	1.21	64.64	15.46		130.0	
10573-AAA	IEEE 802.11b WiFi 2.4 GHz (DSSS, 5.5 Mbps, 90pc duty cycle)	X	15.61	122.59	34.86	0.46	130.0	± 9.6 %
		Y	7.32	105.62	29.57		130.0	
		Z	1.41	77.28	19.61		130.0	
10574-AAA	IEEE 802.11b WiFi 2.4 GHz (DSSS, 11 Mbps, 90pc duty cycle)	X	1.59	75.46	21.51	0.46	130.0	± 9.6 %
		Y	1.56	73.46	20.23		130.0	
		Z	1.30	69.51	17.90		130.0	

10575-AAA	IEEE 802.11g WiFi 2.4 GHz (DSSS-OFDM, 6 Mbps, 90pc duty cycle)	X	4.57	66.90	16.65	0.46	130.0	± 9.6 %
		Y	4.78	66.67	16.55		130.0	
		Z	4.70	66.43	16.27		130.0	
10576-AAA	IEEE 802.11g WiFi 2.4 GHz (DSSS-OFDM, 9 Mbps, 90pc duty cycle)	X	4.60	67.11	16.74	0.46	130.0	± 9.6 %
		Y	4.81	66.83	16.61		130.0	
		Z	4.72	66.59	16.34		130.0	
10577-AAA	IEEE 802.11g WiFi 2.4 GHz (DSSS-OFDM, 12 Mbps, 90pc duty cycle)	X	4.78	67.36	16.89	0.46	130.0	± 9.6 %
		Y	5.04	67.16	16.78		130.0	
		Z	4.94	66.91	16.52		130.0	
10578-AAA	IEEE 802.11g WiFi 2.4 GHz (DSSS-OFDM, 18 Mbps, 90pc duty cycle)	X	4.68	67.55	17.03	0.46	130.0	± 9.6 %
		Y	4.93	67.32	16.88		130.0	
		Z	4.83	67.07	16.62		130.0	
10579-AAA	IEEE 802.11g WiFi 2.4 GHz (DSSS-OFDM, 24 Mbps, 90pc duty cycle)	X	4.43	66.68	16.24	0.46	130.0	± 9.6 %
		Y	4.71	66.69	16.25		130.0	
		Z	4.59	66.34	15.91		130.0	
10580-AAA	IEEE 802.11g WiFi 2.4 GHz (DSSS-OFDM, 36 Mbps, 90pc duty cycle)	X	4.47	66.74	16.26	0.46	130.0	± 9.6 %
		Y	4.75	66.68	16.26		130.0	
		Z	4.64	66.35	15.93		130.0	
10581-AAA	IEEE 802.11g WiFi 2.4 GHz (DSSS-OFDM, 48 Mbps, 90pc duty cycle)	X	4.59	67.62	16.99	0.46	130.0	± 9.6 %
		Y	4.83	67.38	16.83		130.0	
		Z	4.73	67.09	16.54		130.0	
10582-AAA	IEEE 802.11g WiFi 2.4 GHz (DSSS-OFDM, 54 Mbps, 90pc duty cycle)	X	4.35	66.42	16.00	0.46	130.0	± 9.6 %
		Y	4.66	66.46	16.06		130.0	
		Z	4.54	66.09	15.70		130.0	
10583-AAA	IEEE 802.11a/h WiFi 5 GHz (OFDM, 6 Mbps, 90pc duty cycle)	X	4.57	66.90	16.65	0.46	130.0	± 9.6 %
		Y	4.78	66.67	16.55		130.0	
		Z	4.70	66.43	16.27		130.0	
10584-AAA	IEEE 802.11a/h WiFi 5 GHz (OFDM, 9 Mbps, 90pc duty cycle)	X	4.60	67.11	16.74	0.46	130.0	± 9.6 %
		Y	4.81	66.83	16.61		130.0	
		Z	4.72	66.59	16.34		130.0	
10585-AAA	IEEE 802.11a/h WiFi 5 GHz (OFDM, 12 Mbps, 90pc duty cycle)	X	4.78	67.36	16.89	0.46	130.0	± 9.6 %
		Y	5.04	67.16	16.78		130.0	
		Z	4.94	66.91	16.52		130.0	
10586-AAA	IEEE 802.11a/h WiFi 5 GHz (OFDM, 18 Mbps, 90pc duty cycle)	X	4.68	67.55	17.03	0.46	130.0	± 9.6 %
		Y	4.93	67.32	16.88		130.0	
		Z	4.83	67.07	16.62		130.0	
10587-AAA	IEEE 802.11a/h WiFi 5 GHz (OFDM, 24 Mbps, 90pc duty cycle)	X	4.43	66.68	16.24	0.46	130.0	± 9.6 %
		Y	4.71	66.69	16.25		130.0	
		Z	4.59	66.34	15.91		130.0	
10588-AAA	IEEE 802.11a/h WiFi 5 GHz (OFDM, 36 Mbps, 90pc duty cycle)	X	4.47	66.74	16.26	0.46	130.0	± 9.6 %
		Y	4.75	66.68	16.26		130.0	
		Z	4.64	66.35	15.93		130.0	
10589-AAA	IEEE 802.11a/h WiFi 5 GHz (OFDM, 48 Mbps, 90pc duty cycle)	X	4.59	67.62	16.99	0.46	130.0	± 9.6 %
		Y	4.83	67.38	16.83		130.0	
		Z	4.73	67.09	16.54		130.0	
10590-AAA	IEEE 802.11a/h WiFi 5 GHz (OFDM, 54 Mbps, 90pc duty cycle)	X	4.35	66.42	16.00	0.46	130.0	± 9.6 %
		Y	4.66	66.46	16.06		130.0	
		Z	4.54	66.09	15.70		130.0	

10591-AAA	IEEE 802.11n (HT Mixed, 20MHz, MCS0, 90pc duty cycle)	X	4.72	66.97	16.76	0.46	130.0	± 9.6 %
		Y	4.93	66.73	16.63		130.0	
		Z	4.85	66.51	16.38		130.0	
10592-AAA	IEEE 802.11n (HT Mixed, 20MHz, MCS1, 90pc duty cycle)	X	4.85	67.28	16.89	0.46	130.0	± 9.6 %
		Y	5.10	67.07	16.76		130.0	
		Z	5.01	66.85	16.51		130.0	
10593-AAA	IEEE 802.11n (HT Mixed, 20MHz, MCS2, 90pc duty cycle)	X	4.77	67.16	16.75	0.46	130.0	± 9.6 %
		Y	5.03	67.02	16.67		130.0	
		Z	4.93	66.76	16.39		130.0	
10594-AAA	IEEE 802.11n (HT Mixed, 20MHz, MCS3, 90pc duty cycle)	X	4.83	67.35	16.92	0.46	130.0	± 9.6 %
		Y	5.08	67.17	16.80		130.0	
		Z	4.99	66.92	16.54		130.0	
10595-AAA	IEEE 802.11n (HT Mixed, 20MHz, MCS4, 90pc duty cycle)	X	4.79	67.31	16.82	0.46	130.0	± 9.6 %
		Y	5.06	67.14	16.71		130.0	
		Z	4.95	66.87	16.44		130.0	
10596-AAA	IEEE 802.11n (HT Mixed, 20MHz, MCS5, 90pc duty cycle)	X	4.73	67.29	16.82	0.46	130.0	± 9.6 %
		Y	4.99	67.14	16.71		130.0	
		Z	4.89	66.86	16.43		130.0	
10597-AAA	IEEE 802.11n (HT Mixed, 20MHz, MCS6, 90pc duty cycle)	X	4.68	67.16	16.68	0.46	130.0	± 9.6 %
		Y	4.95	67.07	16.62		130.0	
		Z	4.84	66.78	16.32		130.0	
10598-AAA	IEEE 802.11n (HT Mixed, 20MHz, MCS7, 90pc duty cycle)	X	4.67	67.44	16.97	0.46	130.0	± 9.6 %
		Y	4.93	67.31	16.88		130.0	
		Z	4.82	67.03	16.60		130.0	
10599-AAA	IEEE 802.11n (HT Mixed, 40MHz, MCS0, 90pc duty cycle)	X	5.39	67.39	16.95	0.46	130.0	± 9.6 %
		Y	5.60	67.32	16.82		130.0	
		Z	5.51	67.07	16.58		130.0	
10600-AAA	IEEE 802.11n (HT Mixed, 40MHz, MCS1, 90pc duty cycle)	X	5.51	67.80	17.12	0.46	130.0	± 9.6 %
		Y	5.77	67.81	17.04		130.0	
		Z	5.65	67.49	16.76		130.0	
10601-AAA	IEEE 802.11n (HT Mixed, 40MHz, MCS2, 90pc duty cycle)	X	5.41	67.56	17.02	0.46	130.0	± 9.6 %
		Y	5.64	67.51	16.91		130.0	
		Z	5.54	67.24	16.65		130.0	
10602-AAA	IEEE 802.11n (HT Mixed, 40MHz, MCS3, 90pc duty cycle)	X	5.54	67.73	17.02	0.46	130.0	± 9.6 %
		Y	5.72	67.51	16.82		130.0	
		Z	5.62	67.22	16.56		130.0	
10603-AAA	IEEE 802.11n (HT Mixed, 40MHz, MCS4, 90pc duty cycle)	X	5.62	68.07	17.33	0.46	130.0	± 9.6 %
		Y	5.82	67.83	17.11		130.0	
		Z	5.72	67.58	16.87		130.0	
10604-AAA	IEEE 802.11n (HT Mixed, 40MHz, MCS5, 90pc duty cycle)	X	5.49	67.68	17.12	0.46	130.0	± 9.6 %
		Y	5.60	67.27	16.82		130.0	
		Z	5.51	67.03	16.58		130.0	
10605-AAA	IEEE 802.11n (HT Mixed, 40MHz, MCS6, 90pc duty cycle)	X	5.51	67.70	17.12	0.46	130.0	± 9.6 %
		Y	5.70	67.55	16.96		130.0	
		Z	5.61	67.31	16.72		130.0	
10606-AAA	IEEE 802.11n (HT Mixed, 40MHz, MCS7, 90pc duty cycle)	X	5.26	67.01	16.63	0.46	130.0	± 9.6 %
		Y	5.49	67.08	16.60		130.0	
		Z	5.39	66.79	16.33		130.0	

10607-AAA	IEEE 802.11ac WiFi (20MHz, MCS0, 90pc duty cycle)	X	4.58	66.35	16.43	0.46	130.0	± 9.6 %
		Y	4.76	66.03	16.25		130.0	
		Z	4.68	65.79	15.98		130.0	
10608-AAA	IEEE 802.11ac WiFi (20MHz, MCS1, 90pc duty cycle)	X	4.73	66.71	16.58	0.46	130.0	± 9.6 %
		Y	4.98	66.46	16.42		130.0	
		Z	4.87	66.20	16.15		130.0	
10609-AAA	IEEE 802.11ac WiFi (20MHz, MCS2, 90pc duty cycle)	X	4.62	66.54	16.40	0.46	130.0	± 9.6 %
		Y	4.87	66.34	16.28		130.0	
		Z	4.76	66.05	15.99		130.0	
10610-AAA	IEEE 802.11ac WiFi (20MHz, MCS3, 90pc duty cycle)	X	4.68	66.72	16.58	0.46	130.0	± 9.6 %
		Y	4.92	66.49	16.43		130.0	
		Z	4.81	66.21	16.15		130.0	
10611-AAA	IEEE 802.11ac WiFi (20MHz, MCS4, 90pc duty cycle)	X	4.59	66.51	16.42	0.46	130.0	± 9.6 %
		Y	4.84	66.32	16.29		130.0	
		Z	4.73	66.02	16.00		130.0	
10612-AAA	IEEE 802.11ac WiFi (20MHz, MCS5, 90pc duty cycle)	X	4.59	66.66	16.46	0.46	130.0	± 9.6 %
		Y	4.85	66.48	16.33		130.0	
		Z	4.74	66.16	16.03		130.0	
10613-AAA	IEEE 802.11ac WiFi (20MHz, MCS6, 90pc duty cycle)	X	4.58	66.47	16.30	0.46	130.0	± 9.6 %
		Y	4.87	66.40	16.24		130.0	
		Z	4.75	66.06	15.92		130.0	
10614-AAA	IEEE 802.11ac WiFi (20MHz, MCS7, 90pc duty cycle)	X	4.55	66.74	16.59	0.46	130.0	± 9.6 %
		Y	4.80	66.57	16.46		130.0	
		Z	4.69	66.26	16.16		130.0	
10615-AAA	IEEE 802.11ac WiFi (20MHz, MCS8, 90pc duty cycle)	X	4.58	66.31	16.16	0.46	130.0	± 9.6 %
		Y	4.84	66.15	16.08		130.0	
		Z	4.73	65.83	15.77		130.0	
10616-AAA	IEEE 802.11ac WiFi (40MHz, MCS0, 90pc duty cycle)	X	5.21	66.65	16.56	0.46	130.0	± 9.6 %
		Y	5.41	66.58	16.44		130.0	
		Z	5.33	66.33	16.20		130.0	
10617-AAA	IEEE 802.11ac WiFi (40MHz, MCS1, 90pc duty cycle)	X	5.28	66.84	16.63	0.46	130.0	± 9.6 %
		Y	5.47	66.68	16.45		130.0	
		Z	5.38	66.45	16.22		130.0	
10618-AAA	IEEE 802.11ac WiFi (40MHz, MCS2, 90pc duty cycle)	X	5.18	66.90	16.68	0.46	130.0	± 9.6 %
		Y	5.37	66.76	16.51		130.0	
		Z	5.28	66.49	16.27		130.0	
10619-AAA	IEEE 802.11ac WiFi (40MHz, MCS3, 90pc duty cycle)	X	5.18	66.65	16.49	0.46	130.0	± 9.6 %
		Y	5.39	66.59	16.37		130.0	
		Z	5.30	66.32	16.11		130.0	
10620-AAA	IEEE 802.11ac WiFi (40MHz, MCS4, 90pc duty cycle)	X	5.26	66.66	16.54	0.46	130.0	± 9.6 %
		Y	5.51	66.68	16.46		130.0	
		Z	5.40	66.39	16.19		130.0	
10621-AAA	IEEE 802.11ac WiFi (40MHz, MCS5, 90pc duty cycle)	X	5.27	66.82	16.75	0.46	130.0	± 9.6 %
		Y	5.48	66.74	16.60		130.0	
		Z	5.39	66.50	16.37		130.0	
10622-AAA	IEEE 802.11ac WiFi (40MHz, MCS6, 90pc duty cycle)	X	5.27	66.93	16.80	0.46	130.0	± 9.6 %
		Y	5.48	66.86	16.65		130.0	
		Z	5.39	66.62	16.42		130.0	

10623-AAA	IEEE 802.11ac WiFi (40MHz, MCS7, 90pc duty cycle)	X	5.14	66.42	16.40	0.46	130.0	± 9.6 %
		Y	5.37	66.46	16.34		130.0	
		Z	5.27	66.17	16.07		130.0	
10624-AAA	IEEE 802.11ac WiFi (40MHz, MCS8, 90pc duty cycle)	X	5.34	66.68	16.59	0.46	130.0	± 9.6 %
		Y	5.56	66.62	16.48		130.0	
		Z	5.47	66.37	16.24		130.0	
10625-AAA	IEEE 802.11ac WiFi (40MHz, MCS9, 90pc duty cycle)	X	5.51	67.05	16.84	0.46	130.0	± 9.6 %
		Y	5.94	67.60	17.02		130.0	
		Z	5.85	67.36	16.78		130.0	
10626-AAA	IEEE 802.11ac WiFi (80MHz, MCS0, 90pc duty cycle)	X	5.53	66.66	16.50	0.46	130.0	± 9.6 %
		Y	5.68	66.62	16.38		130.0	
		Z	5.60	66.40	16.16		130.0	
10627-AAA	IEEE 802.11ac WiFi (80MHz, MCS1, 90pc duty cycle)	X	5.78	67.30	16.79	0.46	130.0	± 9.6 %
		Y	5.92	67.14	16.59		130.0	
		Z	5.84	66.92	16.37		130.0	
10628-AAA	IEEE 802.11ac WiFi (80MHz, MCS2, 90pc duty cycle)	X	5.53	66.65	16.39	0.46	130.0	± 9.6 %
		Y	5.74	66.79	16.36		130.0	
		Z	5.65	66.51	16.11		130.0	
10629-AAA	IEEE 802.11ac WiFi (80MHz, MCS3, 90pc duty cycle)	X	5.63	66.79	16.45	0.46	130.0	± 9.6 %
		Y	5.82	66.85	16.38		130.0	
		Z	5.74	66.60	16.14		130.0	
10630-AAA	IEEE 802.11ac WiFi (80MHz, MCS4, 90pc duty cycle)	X	5.95	67.97	17.05	0.46	130.0	± 9.6 %
		Y	6.32	68.49	17.20		130.0	
		Z	6.17	68.05	16.86		130.0	
10631-AAA	IEEE 802.11ac WiFi (80MHz, MCS5, 90pc duty cycle)	X	5.89	67.93	17.23	0.46	130.0	± 9.6 %
		Y	6.21	68.27	17.26		130.0	
		Z	6.09	67.93	17.00		130.0	
10632-AAA	IEEE 802.11ac WiFi (80MHz, MCS6, 90pc duty cycle)	X	5.77	67.44	17.00	0.46	130.0	± 9.6 %
		Y	5.90	67.22	16.76		130.0	
		Z	5.82	67.00	16.55		130.0	
10633-AAA	IEEE 802.11ac WiFi (80MHz, MCS7, 90pc duty cycle)	X	5.60	66.87	16.54	0.46	130.0	± 9.6 %
		Y	5.83	67.02	16.49		130.0	
		Z	5.72	66.69	16.23		130.0	
10634-AAA	IEEE 802.11ac WiFi (80MHz, MCS8, 90pc duty cycle)	X	5.59	66.92	16.62	0.46	130.0	± 9.6 %
		Y	5.81	67.01	16.55		130.0	
		Z	5.71	66.73	16.31		130.0	
10635-AAA	IEEE 802.11ac WiFi (80MHz, MCS9, 90pc duty cycle)	X	5.44	66.12	15.93	0.46	130.0	± 9.6 %
		Y	5.70	66.39	15.99		130.0	
		Z	5.59	66.05	15.69		130.0	
10636-AAA	IEEE 1602.11ac WiFi (160MHz, MCS0, 90pc duty cycle)	X	5.96	67.00	16.57	0.46	130.0	± 9.6 %
		Y	6.08	67.01	16.47		130.0	
		Z	6.01	66.78	16.25		130.0	
10637-AAA	IEEE 1602.11ac WiFi (160MHz, MCS1, 90pc duty cycle)	X	6.10	67.36	16.74	0.46	130.0	± 9.6 %
		Y	6.25	67.39	16.63		130.0	
		Z	6.17	67.14	16.41		130.0	
10638-AAA	IEEE 1602.11ac WiFi (160MHz, MCS2, 90pc duty cycle)	X	6.11	67.36	16.71	0.46	130.0	± 9.6 %
		Y	6.25	67.36	16.60		130.0	
		Z	6.17	67.12	16.38		130.0	

10639-AAA	IEEE 1602.11ac WiFi (160MHz, MCS3, 90pc duty cycle)	X	6.07	67.26	16.71	0.46	130.0	± 9.6 %
		Y	6.25	67.37	16.65		130.0	
		Z	6.16	67.11	16.42		130.0	
10640-AAA	IEEE 1602.11ac WiFi (160MHz, MCS4, 90pc duty cycle)	X	6.05	67.22	16.62	0.46	130.0	± 9.6 %
		Y	6.27	67.44	16.63		130.0	
		Z	6.17	67.12	16.37		130.0	
10641-AAA	IEEE 1602.11ac WiFi (160MHz, MCS5, 90pc duty cycle)	X	6.13	67.23	16.65	0.46	130.0	± 9.6 %
		Y	6.27	67.20	16.53		130.0	
		Z	6.19	66.96	16.31		130.0	
10642-AAA	IEEE 1602.11ac WiFi (160MHz, MCS6, 90pc duty cycle)	X	6.16	67.45	16.94	0.46	130.0	± 9.6 %
		Y	6.34	67.53	16.85		130.0	
		Z	6.25	67.29	16.64		130.0	
10643-AAA	IEEE 1602.11ac WiFi (160MHz, MCS7, 90pc duty cycle)	X	6.00	67.14	16.67	0.46	130.0	± 9.6 %
		Y	6.17	67.21	16.60		130.0	
		Z	6.08	66.93	16.36		130.0	
10644-AAA	IEEE 1602.11ac WiFi (160MHz, MCS8, 90pc duty cycle)	X	6.08	67.39	16.82	0.46	130.0	± 9.6 %
		Y	6.38	67.85	16.95		130.0	
		Z	6.26	67.49	16.66		130.0	
10645-AAA	IEEE 1602.11ac WiFi (160MHz, MCS9, 90pc duty cycle)	X	6.23	67.50	16.83	0.46	130.0	± 9.6 %
		Y	6.74	68.44	17.18		130.0	
		Z	6.68	68.29	17.00		130.0	
10646-AAB	LTE-TDD (SC-FDMA, 1 RB, 5 MHz, QPSK, UL Subframe=2,7)	X	13.71	101.95	34.43	9.30	60.0	± 9.6 %
		Y	31.42	116.20	38.46		60.0	
		Z	15.59	99.47	32.52		60.0	
10647-AAA	LTE-TDD (SC-FDMA, 1 RB, 20 MHz, QPSK, UL Subframe=2,7)	X	12.18	100.02	33.95	9.30	60.0	± 9.6 %
		Y	30.06	116.00	38.55		60.0	
		Z	14.66	98.82	32.42		60.0	
10648-AAA	CDMA2000 (1x Advanced)	X	0.74	65.73	11.50	0.00	150.0	± 9.6 %
		Y	0.86	65.73	12.88		150.0	
		Z	0.73	63.45	11.13		150.0	

<sup>E</sup> Uncertainty is determined using the max. deviation from linear response applying rectangular distribution and is expressed for the square of the field value.