



FCC RF Test Report

APPLICANT : HMD Global Oy
EQUIPMENT : Smart Phone
BRAND NAME : NOKIA
MODEL NAME : TA-1004
FCC ID : 2AJOTTA-1004
STANDARD : FCC 47 CFR Part 2, 22(H), 24(E)
CLASSIFICATION : PCS Licensed Transmitter Held to Ear (PCE)

The product was received on Jan. 21, 2017 and testing was completed on Apr. 21, 2017. We, SPORTON INTERNATIONAL INC., would like to declare that the tested sample has been evaluated in accordance with the test procedures given in ANSI / TIA / EIA-603-D-2010 and has been in compliance with the applicable technical standards.

The test results in this report apply exclusively to the tested model / sample. Without written approval of SPORTON INTERNATIONAL INC., the test report shall not be reproduced except in full.

Reviewed by: Joseph Lin / Supervisor

Approved by: Jones Tsai / Manager



SPORTON INTERNATIONAL INC.

No. 52, Hwa Ya 1st Rd., Hwa Ya Technology Park, Kwei-Shan District, Tao Yuan City, Taiwan, R.O.C.

SPORTON INTERNATIONAL INC.

TEL : 886-3-327-3456

FAX : 886-3-328-4978

FCC ID : 2AJOTTA-1004

Page Number : 1 of 20

Report Issued Date : May 25, 2017

Report Version : Rev. 01

Report Template No.: BU5-FG22/24 Version 2.0



TABLE OF CONTENTS

REVISION HISTORY..... 3

SUMMARY OF TEST RESULT 4

1 GENERAL DESCRIPTION 5

 1.1 Applicant..... 5

 1.2 Manufacturer 5

 1.3 Product Feature of Equipment Under Test 5

 1.4 Modification of EUT 5

 1.5 Testing Location 6

 1.6 Applicable Standards 6

2 TEST CONFIGURATION OF EQUIPMENT UNDER TEST 7

 2.1 Test Mode..... 7

 2.2 Connection Diagram of Test System 7

 2.3 Support Unit used in test configuration 8

 2.4 Measurement Results Explanation Example 8

 2.5 Frequency List of Low/Middle/High Channels..... 8

3 CONDUCTED TEST RESULT..... 9

 3.1 Measuring Instruments..... 9

 3.2 Test Setup 9

 3.3 Test Result of Conducted Test..... 9

 3.4 Conducted Output Power 10

 3.5 Peak-to-Average Ratio 11

 3.6 99% Occupied Bandwidth and 26dB Bandwidth Measurement..... 12

 3.7 Conducted Band Edge 13

 3.8 Conducted Spurious Emission 14

 3.9 Frequency Stability..... 15

4 RADIATED TEST ITEMS 16

 4.1 Measuring Instruments..... 16

 4.2 Test Setup 16

 4.3 Test Result of Radiated Test..... 16

 4.4 Effective Radiated Power and Effective Isotropic Radiated Power Measurement 17

 4.5 Field Strength of Spurious Radiation Measurement 18

5 LIST OF MEASURING EQUIPMENT 19

6 UNCERTAINTY OF EVALUATION 20

APPENDIX A. TEST RESULTS OF CONDUCTED TEST

APPENDIX B. TEST RESULTS OF RADIATED TEST

APPENDIX C. TEST SETUP PHOTOGRAPHS



SUMMARY OF TEST RESULT

Report Section	FCC Rule	Description	Limit	Result	Remark
3.4	§2.1046	Conducted Output Power	Reporting Only	PASS	-
3.5	§24.232(d)	Peak-to-Average Ratio	< 13 dB	PASS	-
3.6	§2.1049 §22.917(b) §24.238(b)	Occupied Bandwidth	Reporting Only	PASS	-
3.7	§2.1051 §22.917(a) §24.238(a)	Band Edge Measurement	< 43+10log ₁₀ (P[Watts])	PASS	-
3.8	§2.1051 §22.917(a) §24.238(a)	Conducted Emission	< 43+10log ₁₀ (P[Watts])	PASS	-
3.9	§2.1055 §22.355	Frequency Stability for Temperature & Voltage	< 2.5 ppm for Part 22	PASS	-
	§2.1055 §24.235		Within Authorized Band		
4.4	§22.913(a)(2)	Effective Radiated Power	< 7 Watts	PASS	-
	§24.232(c)	Equivalent Isotropic Radiated Power	< 2 Watts	PASS	-
4.5	§2.1053 §22.917(a) §24.238(a)	Field Strength of Spurious Radiation	< 43+10log ₁₀ (P[Watts])	PASS	Under limit 35.10 dB at 1672.000 MHz



1 General Description

1.1 Applicant

HMD Global Oy
Karaportti 2, 02610 Espoo, Finland

1.2 Manufacturer

HMD Global Oy
Karaportti 2, 02610 Espoo, Finland

1.3 Product Feature of Equipment Under Test

GSM/WCDMA/LTE, Bluetooth, Wi-Fi 2.4GHz 802.11b/g/n, Wi-Fi 5GHz 802.11a/n/ac, NFC, and GPS.

Product Specification subjective to this standard	
Antenna Type	WWAN: PIFA Antenna WLAN: PIFA Antenna Bluetooth: PIFA Antenna GPS/Glonass/Beidou: Monopole Antenna NFC: Loop Antenna

1.4 Modification of EUT

No modifications are made to the EUT during all test items.



1.5 Testing Location

Sporton Lab is accredited to ISO 17025 by Taiwan Accreditation Foundation (TAF code : 1190) and the FCC designation No. TW0007 under the FCC 2.948(e) by Mutual Recognition Agreement (MRA) in FCC Test.

Test Site	SPORTON INTERNATIONAL INC.
Test Site Location	No. 52, Hwa Ya 1 st Rd., Hwa Ya Technology Park, Kwei-Shan District, Tao Yuan City, Taiwan, R.O.C. TEL: +886-3-327-3456 FAX: +886-3-328-4978
Test Site No.	Sporton Site No.
	TH03-HY

Test Site	SPORTON INTERNATIONAL INC.
Test Site Location	No.58, Aly. 75, Ln. 564, Wenhua 3rd Rd. Guishan Dist, Taoyuan City, Taiwan (R.O.C.) TEL: +886-3-327-0868 FAX: +886-3-327-0855
Test Site No.	Sporton Site No.
	03CH12-HY

1.6 Applicable Standards

According to the specifications of the manufacturer, the EUT must comply with the requirements of the following standards:

- ♦ 47 CFR Part 2, 22(H), 24(E)
- ♦ ANSI / TIA / EIA-603-D-2010
- ♦ FCC KDB 971168 D01 Power Meas. License Digital Systems v02r02

Remark:

1. All test items were verified and recorded according to the standards and without any deviation during the test.
2. This EUT has also been tested and complied with the requirements of FCC Part 15, Subpart B, recorded in a separate test report.

2 Test Configuration of Equipment Under Test

2.1 Test Mode

Antenna port conducted and radiated test items were performed according to KDB 971168 D01 Power Meas. License Digital Systems v02r02 with maximum output power.

Radiated measurements were performed with rotating EUT in different three orthogonal test planes to find the maximum emission.

Radiated emissions were investigated as following frequency range:

1. 30 MHz to 9000 MHz for GSM850 and WCDMA Band V.
2. 30 MHz to 19100 MHz for GSM1900 and WCDMA Band II.

All modes and data rates and positions were investigated.

Test modes are chosen to be reported as the worst case configuration below:

Test Modes		
Band	Radiated TCs	Conducted TCs
GSM 850	<ul style="list-style-type: none"> ■ GPRS class 8 Link + SIM 2 ■ EDGE class 8 Link + SIM 2 	<ul style="list-style-type: none"> ■ GPRS class 8 Link ■ EDGE class 8 Link
GSM 1900	<ul style="list-style-type: none"> ■ GSM Link+ SIM 1 ■ EDGE class 8 Link+ SIM 1 	<ul style="list-style-type: none"> ■ GSM Link ■ EDGE class 8 Link
WCDMA Band V	<ul style="list-style-type: none"> ■ RMC 12.2Kbps Link+ SIM 2 	<ul style="list-style-type: none"> ■ RMC 12.2Kbps Link
WCDMA Band II	<ul style="list-style-type: none"> ■ RMC 12.2Kbps Link+ SIM 1 	<ul style="list-style-type: none"> ■ RMC 12.2Kbps Link

2.2 Connection Diagram of Test System

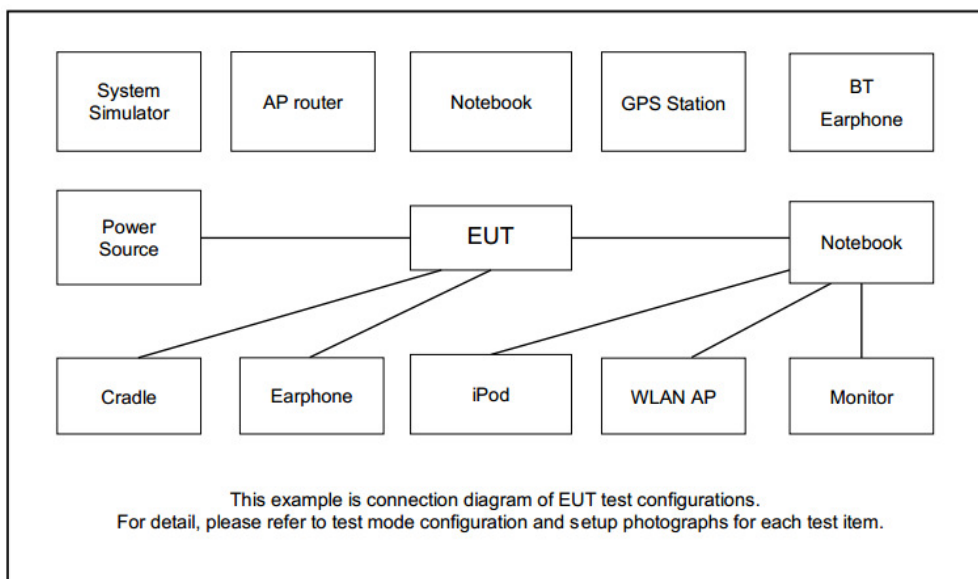



2.3 Support Unit used in test configuration

Item	Equipment	Trade Name	Model No.	FCC ID	Data Cable	Power Cord
1.	System Simulator	R&S	CMU 200	N/A	N/A	Unshielded, 1.8 m

2.4 Measurement Results Explanation Example

For all conducted test items:

The offset level is set in the spectrum analyzer to compensate the RF cable loss and attenuator factor between RF conducted output port and spectrum analyzer. With the offset compensation, the spectrum analyzer reading level will be exactly the RF output level.

The spectrum analyzer offset is derived from RF cable loss and attenuator factor.

$$\text{Offset} = \text{RF cable loss} + \text{attenuator factor}.$$

The following shows an offset computation example with RF cable loss 4.2 dB and a 10dB attenuator.

Example :

$$\begin{aligned} \text{Offset(dB)} &= \text{RF cable loss(dB)} + \text{attenuator factor(dB)}. \\ &= 4.2 + 10 = 14.2 \text{ (dB)} \end{aligned}$$

2.5 Frequency List of Low/Middle/High Channels

Frequency List				
Band	Channel/Frequency(MHz)	Lowest	Middle	Highest
GSM850	Channel	128	189	251
	Frequency	824.2	836.4	848.8
WCDMA Band V	Channel	4132	4182	4233
	Frequency	826.4	836.4	846.6
GSM1900	Channel	512	661	810
	Frequency	1850.2	1880.0	1909.8
WCDMA Band II	Channel	9262	9400	9538
	Frequency	1852.4	1880.0	1907.6

3 Conducted Test Result

3.1 Measuring Instruments

See list of measuring instruments of this test report.

3.2 Test Setup

3.2.1 Conducted Output Power

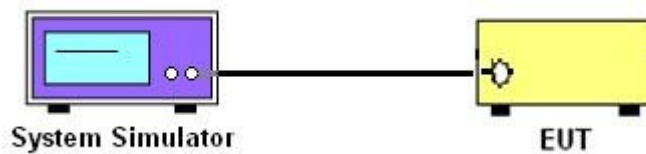

3.2.2 Peak-to-Average Ratio, Occupied Bandwidth, Conducted Band-Edge and Conducted Spurious Emission

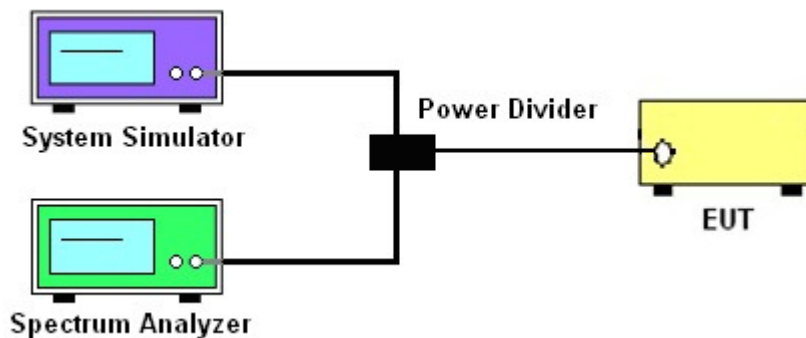

3.2.3 Frequency Stability

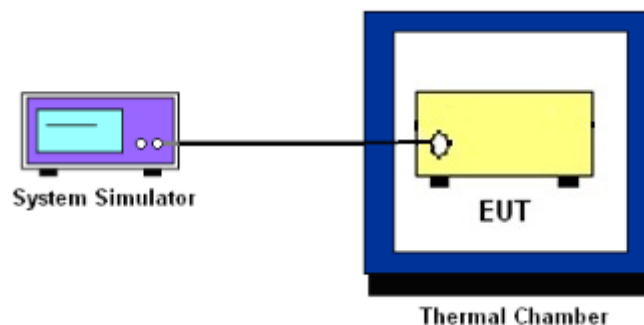

3.3 Test Result of Conducted Test

Please refer to Appendix A.



3.4 Conducted Output Power

3.4.1 Description of the Conducted Output Power

A system simulator was used to establish communication with the EUT. Its parameters were set to enforce EUT transmitting at the maximum power. The measured power in the radio frequency on the transmitter output terminals shall be reported.

3.4.2 Test Procedures

1. The transmitter output port was connected to the system simulator.
2. Set EUT at maximum power through system simulator.
3. Select lowest, middle, and highest channels for each band and different modulation.
4. Measure the maximum burst average power for GSM and maximum average power for other modulation signal.



3.5 Peak-to-Average Ratio

3.5.1 Description of the PAR Measurement

The peak-to-average ratio (PAR) of the transmission may not exceed 13 dB.

3.5.2 Test Procedures

1. The testing follows FCC KDB 971168 D01 v02r02 Section 5.7.1.
2. The EUT was connected to spectrum analyzer and system simulator via a power divider.
3. Set EUT to transmit at maximum output power.
4. When the duty cycle is less than 98%, then signal gating will be implemented on the spectrum analyzer by triggering from the system simulator.
5. Set the CCDF (Complementary Cumulative Distribution Function) option of the spectrum analyzer.
Record the maximum PAPR level associated with a probability of 0.1%.



3.6 99% Occupied Bandwidth and 26dB Bandwidth Measurement

3.6.1 Description of 99% Occupied Bandwidth and 26dB Bandwidth Measurement

The occupied bandwidth is the width of a frequency band such that, below the lower and above the upper frequency limits, the mean powers emitted are each equal to a specified percentage 0.5% of the total mean transmitted power.

The 26 dB emission bandwidth is defined as the frequency range between two points, one above and one below the carrier frequency, at which the spectral density of the emission is attenuated 26 dB below the maximum in-band spectral density of the modulated signal. Spectral density (power per unit bandwidth) is to be measured with a detector of resolution bandwidth equal to approximately 1.0% of the emission bandwidth.

3.6.2 Test Procedures

1. The testing follows FCC KDB 971168 v02r02 Section 4.2.
2. The EUT was connected to spectrum analyzer and system simulator via a power divider.
3. The spectrum analyzer center frequency is set to the nominal EUT channel center frequency. The span range for the spectrum analyzer shall be between two and five times the anticipated OBW.
4. The nominal resolution bandwidth (RBW) shall be in the range of 1 to 5 % of the anticipated OBW, and the VBW shall be at least 3 times the RBW.
5. Set the detection mode to peak, and the trace mode to max hold.
6. Determine the reference value: Set the EUT to transmit a modulated signal. Allow the trace to stabilize. Set the spectrum analyzer marker to the highest level of the displayed trace.
(this is the reference value)
7. Determine the “-26 dB down amplitude” as equal to (Reference Value – X).
8. Place two markers, one at the lowest and the other at the highest frequency of the envelope of the spectral display such that each marker is at or slightly below the “-X dB down amplitude” determined in step 6. If a marker is below this “-X dB down amplitude” value it shall be placed as close as possible to this value. The OBW is the positive frequency difference between the two markers.
9. Use the 99 % power bandwidth function of the spectrum analyzer and report the measured bandwidth.



3.7 Conducted Band Edge

3.7.1 Description of Conducted Band Edge Measurement

The power of any emission outside of the authorized operating frequency ranges must be lower than the transmitter power (P) by a factor of at least $43 + 10 \log (P)$ dB.

3.7.2 Test Procedures

1. The testing follows FCC KDB 971168 D01 v02r02 Section 6.0.
2. The EUT was connected to the spectrum analyzer and system simulator via a power divider.
3. The RF output of EUT was connected to the spectrum analyzer by an RF cable and attenuator. The path loss was compensated to the results for each measurement.
4. The band edges of low and high channels for the highest RF powers were measured.
5. The RF fundamental frequency should be excluded against the limit line in the operating frequency band.
6. The limit line is derived from $43 + 10\log(P)$ dB below the transmitter power P(Watts)



3.8 Conducted Spurious Emission

3.8.1 Description of Conducted Spurious Emission Measurement

The power of any emission outside of the authorized operating frequency ranges must be lower than the transmitter power (P) by a factor of at least $43 + 10 \log (P)$ dB.

It is measured by means of a calibrated spectrum analyzer and scanned from 30 MHz up to a frequency including its 10th harmonic.

3.8.2 Test Procedures

1. The testing follows FCC KDB 971168 D01 v02r02 Section 6.0.
2. The EUT was connected to the spectrum analyzer and system simulator via a power divider.
3. The RF output of EUT was connected to the spectrum analyzer by an RF cable and attenuator. The path loss was compensated to the results for each measurement.
4. The middle channel for the highest RF power within the transmitting frequency was measured.
5. The conducted spurious emission for the whole frequency range was taken.
6. The RF fundamental frequency should be excluded against the limit line in the operating frequency band.
7. The limit line is derived from $43 + 10\log(P)$ dB below the transmitter power P(Watts)



3.9 Frequency Stability

3.9.1 Description of Frequency Stability Measurement

The frequency stability shall be measured by variation of ambient temperature and variation of primary supply voltage to ensure that the fundamental emission stays within the authorized frequency block. The frequency stability of the transmitter shall be maintained within $\pm 0.00025\%$ ($\pm 2.5\text{ppm}$) of the center frequency.

3.9.2 Test Procedures for Temperature Variation

1. The testing follows FCC KDB 971168 D01 v02r02 Section 9.0.
2. The EUT was set up in the thermal chamber and connected with the system simulator.
3. With power OFF, the temperature was decreased to -30°C and the EUT was stabilized before testing. Power was applied and the maximum change in frequency was recorded within one minute.
4. With power OFF, the temperature was raised in 10°C steps up to 50°C . The EUT was stabilized at each step for at least half an hour. Power was applied and the maximum frequency change was recorded within one minute.

3.9.3 Test Procedures for Voltage Variation

1. The testing follows FCC KDB 971168 D01 v02r02 Section 9.0.
2. The EUT was placed in a temperature chamber at $20\pm 5^{\circ}\text{C}$ and connected with the system simulator.
3. The power supply voltage to the EUT was varied from 85% to 115% of the nominal value measured at the input to the EUT.
4. The variation in frequency was measured for the worst case.

4 Radiated Test Items

4.1 Measuring Instruments

See list of measuring instruments of this test report.

4.2 Test Setup

4.2.1 For radiated test from 30MHz to 1GHz

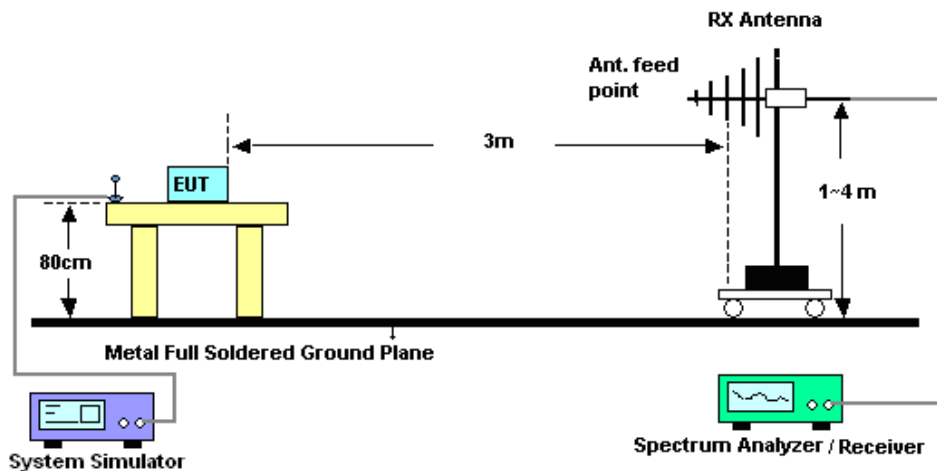

4.2.2 For radiated test above 1GHz

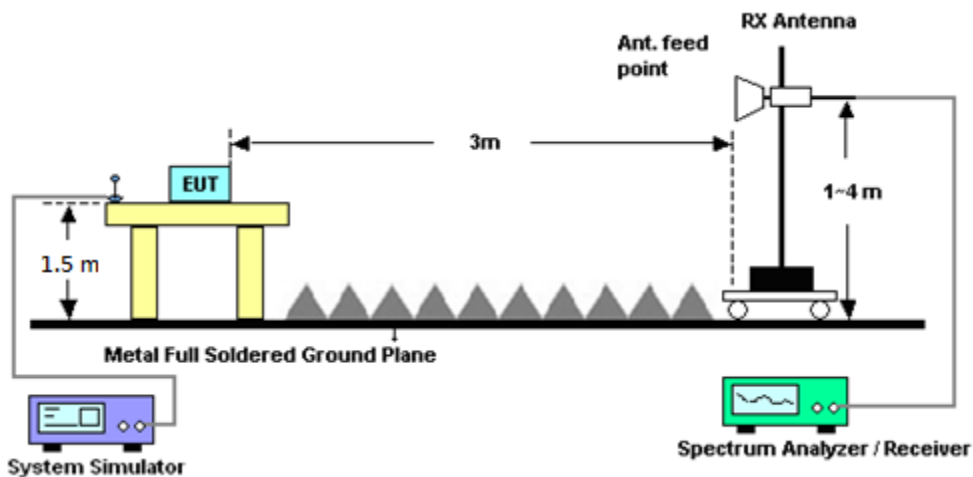

4.3 Test Result of Radiated Test

Please refer to Appendix B.



4.4 Effective Radiated Power and Effective Isotropic Radiated Power Measurement

4.4.1 Description of the ERP/EIRP Measurement

The substitution method, in ANSI / TIA / EIA-603-D-2010, was used for ERP/EIRP measurement, and the spectrum analyzer configuration follows KDB 971168 D01 Power Meas. License Digital Systems v02r02. The ERP of mobile transmitters must not exceed 7 Watts (Cellular Band) and the EIRP of mobile transmitters are limited to 2 Watts (PCS Band).

4.4.2 Test Procedures

1. The testing follows FCC KDB 971168 D01 v02r02 Section 5.2.1. (for CDMA/WCDMA), Section 5.2.2.2 (for GSM/GPRS/EDGE) and ANSI / TIA-603-D-2010 Section 2.2.17.
2. The EUT was placed on a non-conductive rotating platform (0.8 meters for frequency below 1GHz and 1.5 meter for frequency above 1GHz) in a semi-anechoic chamber. The radiated emission at the fundamental frequency was measured at 3 m with a test antenna and a spectrum analyzer with RMS detector per section 5. of KDB 971168 D01.
3. During the measurement, the system simulator parameters were set to force the EUT transmitting at maximum output power. The maximum emission was recorded from analyzer power level (LVL) from the 360 degrees rotation of the turntable and the test antenna raised and lowered over a range from 1 to 4 meters in both horizontally and vertically polarized orientations.
4. Effective Isotropic Radiated Power (EIRP) was measured by substitution method according to TIA/EIA-603-D. The EUT was replaced by the substitution antenna at same location, and then a known power from S.G. was applied into the dipole antenna through a Tx cable, and then recorded the maximum Analyzer reading through raised and lowered the test antenna. The correction factor (in dB) = S.G. - Tx Cable loss + Substitution antenna gain - Analyzer reading. Then the EUT's EIRP was calculated with the correction factor, $EIRP = LVL + \text{Correction factor}$ and $ERP = EIRP - 2.15$. Take the record of the output power at substitution antenna.

	GSM/GPRS/EDGE	WCDMA/HSPA
SPAN	500kHz	10MHz
RBW	10kHz	100kHz
VBW	30kHz	300kHz
Detector	RMS	RMS
Trace	Average	Average
Average Type	Power	Power
Sweep Count	100	100



4.5 Field Strength of Spurious Radiation Measurement

4.5.1 Description of Field Strength of Spurious Radiated Measurement

The power of any emission outside of the authorized operating frequency ranges must be attenuated below the transmitter power (P) by a factor of at least $43 + 10 \log (P)$ dB. The spectrum is scanned from 30 MHz up to a frequency including its 10th harmonic.

4.5.2 Test Procedures

1. The testing follows FCC KDB 971168 D01 v02r02 Section 5.8 and ANSI / TIA-603-D-2010 Section 2.2.12.
2. The EUT was placed on a rotatable wooden table 0.8 meters for frequency below 1GHz and 1.5 meter for frequency above 1GHz above the ground.
3. The EUT was set 3 meters from the receiving antenna, which was mounted on the antenna tower.
4. The table was rotated 360 degrees to determine the position of the highest spurious emission.
5. The height of the receiving antenna is varied between one meter and four meters to search for the maximum spurious emission for both horizontal and vertical polarizations.
6. Make the measurement with the spectrum analyzer's RBW = 1MHz, VBW = 3MHz, taking record of maximum spurious emission.
7. A horn antenna was substituted in place of the EUT and was driven by a signal generator.
8. Tune the output power of signal generator to the same emission level with EUT maximum spurious emission.
9. Taking the record of output power at antenna port.
10. Repeat step 7 to step 8 for another polarization.
11. $EIRP (dBm) = S.G. Power - Tx Cable Loss + Tx Antenna Gain$
12. $ERP (dBm) = EIRP - 2.15$
13. The RF fundamental frequency should be excluded against the limit line in the operating frequency band.
14. The limit line is derived from $43 + 10\log(P)$ dB below the transmitter power P(Watts)



5 List of Measuring Equipment

Instrument	Manufacturer	Model No.	Serial No.	Characteristics	Calibration Date	Test Date	Due Date	Remark
Spectrum Analyzer	Rohde & Schwarz	FSP30	101329	9kHz~30GHz	Jun. 27, 2016	Mar. 15, 2017 ~ Mar. 16, 2017	Jun. 26, 2017	Conducted (TH03-HY)
Temperature Chamber	ESPEC	SU-641	92013721	-30℃ ~70℃	Nov. 16, 2016	Mar. 15, 2017 ~ Mar. 16, 2017	Nov. 15, 2017	Conducted (TH03-HY)
Programmable Power Supply	GW Instek	PSS-2005	EL883644	Voltage:0~20V;Current:0~5A	Nov. 22, 2016	Mar. 15, 2017 ~ Mar. 16, 2017	Nov. 21, 2017	Conducted (TH03-HY)
Base Station (Measure)	Rohde & Schwarz	CMU200	117997	GSM / GPRS / WCDMA / CDMA	Aug. 05, 2016	Mar. 15, 2017 ~ Mar. 16, 2017	Aug. 04, 2017	Conducted (TH03-HY)
Amplifier	SONOMA	310N	187312	9kHz~1GHz	Nov. 10, 2016	Mar. 19, 2017 ~ Apr. 21, 2017	Nov. 09, 2017	Radiation (03CH12-HY)
Bilog Antenna	TESEQ	CBL 6111D&008	37059&01	30MHz~1GHz	Oct. 15, 2016	Mar. 19, 2017 ~ Apr. 21, 2017	Oct. 14, 2017	Radiation (03CH12-HY)
EMI Test Receiver	Rohde & Schwarz	ESU26	100390	20Hz~26.5GHz	Dec. 23, 2016	Mar. 19, 2017 ~ Apr. 21, 2017	Dec. 22, 2017	Radiation (03CH12-HY)
Horn Antenna	SCHWARZBECK	BBHA 9120D	9120D-1328	1GHz ~ 18GHz	Oct. 25, 2016	Mar. 19, 2017 ~ Apr. 21, 2017	Oct. 24, 2017	Radiation (03CH12-HY)
Preamplifier	MITEQ	AMF-7D-00 101800-30-1	1815698	1GHz~18GHz	Dec. 01, 2016	Mar. 19, 2017 ~ Apr. 21, 2017	Nov. 30, 2017	Radiation (03CH12-HY)
Antenna Mast	EMEC	AM-BS-450 0-B	N/A	1m~4m	N/A	Mar. 19, 2017 ~ Apr. 21, 2017	N/A	Radiation (03CH12-HY)
Turn Table	EMEC	TT2000	N/A	0~360 Degree	N/A	Mar. 19, 2017 ~ Apr. 21, 2017	N/A	Radiation (03CH12-HY)
SHF-EHF Horn Antenna	SCHWARZBECK	BBHA 9170	BBHA91705 76	18GHz ~ 40GHz	Apr. 15, 2016	Mar. 19, 2017 ~ Mar. 21, 2017	Apr. 14, 2017	Radiation (03CH12-HY)
SHF-EHF Horn Antenna	SCHWARZBECK	BBHA 9170	BBHA91702 51	18GHz ~ 40GHz	Nov. 08, 2016	Apr. 21, 2017	Nov. 07, 2017	Radiation (03CH12-HY)
Preamplifier	MITEQ	JS44-18004 000-33-8P	1840917	18GHz ~ 40GHz	Jun. 14, 2016	Mar. 19, 2017 ~ Apr. 21, 2017	Jun. 13, 2017	Radiation (03CH12-HY)
SHF-EHF Horn Antenna	SCHWARZBECK	BBHA 9170	BBHA91705 84	18GHz- 40GHz	Nov. 08, 2016	Mar. 19, 2017 ~ Apr. 21, 2017	Nov. 07, 2017	Radiation (03CH12-HY)
Signal Generator	Anritsu	MG3694C	163401	0.1Hz~40GHz	Jan. 04, 2017	Mar. 19, 2017 ~ Apr. 21, 2017	Jan. 03, 2018	Radiation (03CH12-HY)
Horn Antenna	SCHWARZBECK	BBHA 9120 D	9120D-1522	1G~18GHz	Mar. 31, 2016	Mar. 19, 2017 ~ Mar. 21, 2017	Mar. 30, 2017	Radiation (03CH12-HY)
Horn Antenna	SCHWARZBECK	BBHA 9120 D	9120D-1522	1G~18GHz	Mar. 17, 2017	Apr. 21, 2017	Mar. 16, 2018	Radiation (03CH12-HY)



6 Uncertainty of Evaluation

Uncertainty of Radiated Emission Measurement (30 MHz ~ 1000 MHz)

Measuring Uncertainty for a Level of Confidence of 95% ($U = 2Uc(y)$)	5.1
-------------------------------------------------------------------------	-----

Uncertainty of Radiated Emission Measurement (1 GHz ~ 18 GHz)

Measuring Uncertainty for a Level of Confidence of 95% ($U = 2Uc(y)$)	5.2
-------------------------------------------------------------------------	-----

Uncertainty of Radiated Emission Measurement (18 GHz ~ 40 GHz)

Measuring Uncertainty for a Level of Confidence of 95% ($U = 2Uc(y)$)	4.7
-------------------------------------------------------------------------	-----



Appendix A. Test Results of Conducted Test

Conducted Output Power(Average power)

Conducted Power (*Unit: dBm)						
Band	GSM850			GSM1900		
Channel	128	189	251	512	661	810
Frequency	824.2	836.4	848.8	1850.2	1880	1909.8
GSM	32.39	32.38	32.38	29.51	29.71	29.85
GPRS class 8	32.37	32.44	32.34	29.58	29.7	29.85
GPRS class 10	29.73	29.7	29.63	26.48	26.52	26.61
GPRS class 11	28.32	28.36	28.35	25.28	25.36	25.38
GPRS class 12	26.85	26.92	26.91	24.02	23.91	23.94
EGPRS class 8	26.61	26.76	26.76	25.35	25.43	25.53
EGPRS class 10	23.4	23.54	23.56	22.27	22.27	22.37
EGPRS class 11	22.19	22.29	22.28	21.14	21.23	21.27
EGPRS class 12	20.88	21.05	21.08	20.05	19.98	20.09

Conducted Power (*Unit: dBm)						
Band	WCDMA Band V			WCDMA Band II		
Channel	4132	4182	4233	9262	9400	9538
Frequency	826.4	836.4	846.6	1852.4	1880	1907.6
RMC 12.2K	23.01	23.06	23.29	23.85	23.8	23.64
HSDPA Subtest-1	22.01	21.94	22.1	22.84	22.81	22.55
HSDPA Subtest-2	21.95	21.98	22.13	22.86	22.82	22.49
HSDPA Subtest-3	21.46	21.49	21.65	22.37	22.31	22
HSDPA Subtest-4	21.45	21.5	21.64	22.38	22.3	22.01
HSUPA Subtest-1	21.89	21.94	22.1	22.82	22.79	22.46
HSUPA Subtest-2	19.96	19.97	20.11	20.87	20.8	20.5
HSUPA Subtest-3	20.94	20.97	21.12	21.86	21.82	21.5
HSUPA Subtest-4	19.93	19.97	20.11	20.84	20.81	20.48
HSUPA Subtest-5	21.95	21.95	22.11	22.86	22.81	22.59



A2. GSM

Peak-to-Average Ratio

Mode	GSM850		Limit: 13dB
Mod.	GPRS class 8	EDGE class 8	Result
Lowest CH	0.24	3.48	PASS
Middle CH	0.24	3.44	
Highest CH	0.20	3.32	

Mode	GSM1900		Limit: 13dB
Mod.	GSM	EDGE class 8	Result
Lowest CH	0.20	3.20	PASS
Middle CH	0.24	3.12	
Highest CH	0.24	3.32	

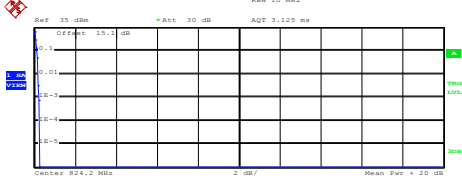
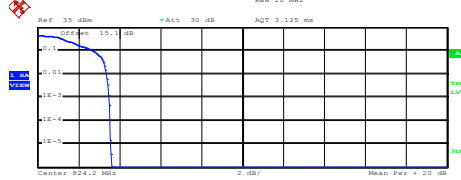
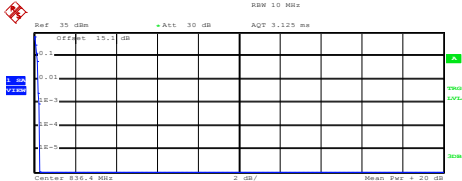
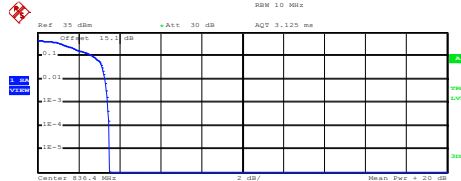
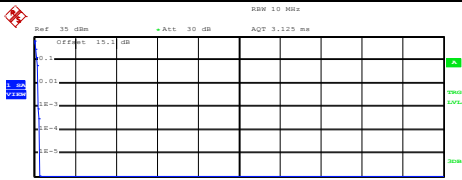
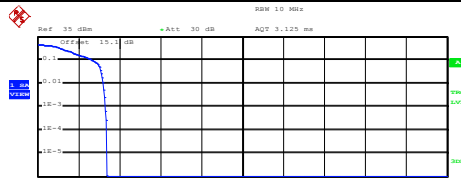

GSM850 (GPRS class 8)	GSM850 (EDGE class 8)																
<p align="center">Lowest Channel</p>  <p>Complementary Cumulative Distribution Function (100000 samples) Trace 1 Mean 31.26 dBm Peak 31.51 dBm Crest 0.25 dB</p> <table border="1"> <tr><td>10 %</td><td>0.12 dB</td></tr> <tr><td>1 %</td><td>0.20 dB</td></tr> <tr><td>.1 %</td><td>0.24 dB</td></tr> <tr><td>.01 %</td><td>0.28 dB</td></tr> </table> <p>Date: 15.MAR.2017 08:09:23</p>	10 %	0.12 dB	1 %	0.20 dB	.1 %	0.24 dB	.01 %	0.28 dB	<p align="center">Lowest Channel</p>  <p>Complementary Cumulative Distribution Function (100000 samples) Trace 1 Mean 26.07 dBm Peak 29.68 dBm Crest 3.61 dB</p> <table border="1"> <tr><td>10 %</td><td>2.72 dB</td></tr> <tr><td>1 %</td><td>3.36 dB</td></tr> <tr><td>.1 %</td><td>3.48 dB</td></tr> <tr><td>.01 %</td><td>3.56 dB</td></tr> </table> <p>Date: 15.MAR.2017 08:22:37</p>	10 %	2.72 dB	1 %	3.36 dB	.1 %	3.48 dB	.01 %	3.56 dB
10 %	0.12 dB																
1 %	0.20 dB																
.1 %	0.24 dB																
.01 %	0.28 dB																
10 %	2.72 dB																
1 %	3.36 dB																
.1 %	3.48 dB																
.01 %	3.56 dB																
<p align="center">Middle Channel</p>  <p>Complementary Cumulative Distribution Function (100000 samples) Trace 1 Mean 31.18 dBm Peak 31.44 dBm Crest 0.26 dB</p> <table border="1"> <tr><td>10 %</td><td>0.12 dB</td></tr> <tr><td>1 %</td><td>0.20 dB</td></tr> <tr><td>.1 %</td><td>0.24 dB</td></tr> <tr><td>.01 %</td><td>0.28 dB</td></tr> </table> <p>Date: 15.MAR.2017 08:09:53</p>	10 %	0.12 dB	1 %	0.20 dB	.1 %	0.24 dB	.01 %	0.28 dB	<p align="center">Middle Channel</p>  <p>Complementary Cumulative Distribution Function (100000 samples) Trace 1 Mean 26.25 dBm Peak 29.75 dBm Crest 3.50 dB</p> <table border="1"> <tr><td>10 %</td><td>2.68 dB</td></tr> <tr><td>1 %</td><td>3.28 dB</td></tr> <tr><td>.1 %</td><td>3.44 dB</td></tr> <tr><td>.01 %</td><td>3.48 dB</td></tr> </table> <p>Date: 15.MAR.2017 08:23:15</p>	10 %	2.68 dB	1 %	3.28 dB	.1 %	3.44 dB	.01 %	3.48 dB
10 %	0.12 dB																
1 %	0.20 dB																
.1 %	0.24 dB																
.01 %	0.28 dB																
10 %	2.68 dB																
1 %	3.28 dB																
.1 %	3.44 dB																
.01 %	3.48 dB																
<p align="center">Highest Channel</p>  <p>Complementary Cumulative Distribution Function (100000 samples) Trace 1 Mean 31.39 dBm Peak 31.65 dBm Crest 0.26 dB</p> <table border="1"> <tr><td>10 %</td><td>0.16 dB</td></tr> <tr><td>1 %</td><td>0.20 dB</td></tr> <tr><td>.1 %</td><td>0.20 dB</td></tr> <tr><td>.01 %</td><td>0.28 dB</td></tr> </table> <p>Date: 15.MAR.2017 08:10:22</p>	10 %	0.16 dB	1 %	0.20 dB	.1 %	0.20 dB	.01 %	0.28 dB	<p align="center">Highest Channel</p>  <p>Complementary Cumulative Distribution Function (100000 samples) Trace 1 Mean 26.29 dBm Peak 29.68 dBm Crest 3.38 dB</p> <table border="1"> <tr><td>10 %</td><td>2.68 dB</td></tr> <tr><td>1 %</td><td>3.20 dB</td></tr> <tr><td>.1 %</td><td>3.32 dB</td></tr> <tr><td>.01 %</td><td>3.40 dB</td></tr> </table> <p>Date: 15.MAR.2017 08:23:45</p>	10 %	2.68 dB	1 %	3.20 dB	.1 %	3.32 dB	.01 %	3.40 dB
10 %	0.16 dB																
1 %	0.20 dB																
.1 %	0.20 dB																
.01 %	0.28 dB																
10 %	2.68 dB																
1 %	3.20 dB																
.1 %	3.32 dB																
.01 %	3.40 dB																

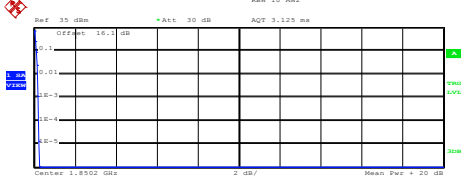
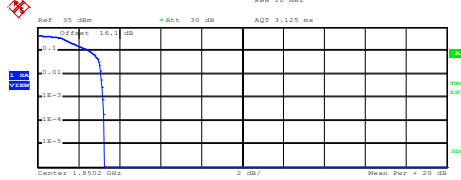
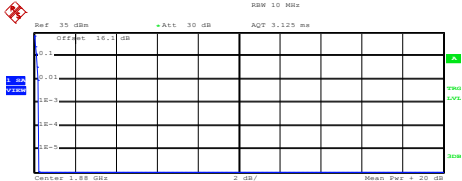
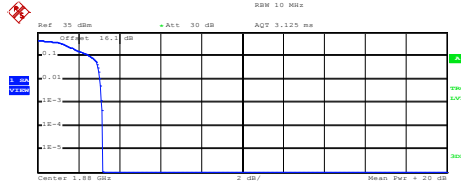
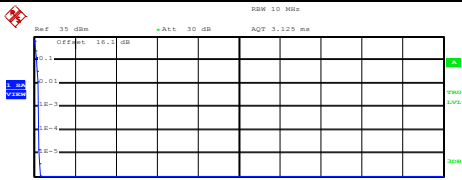
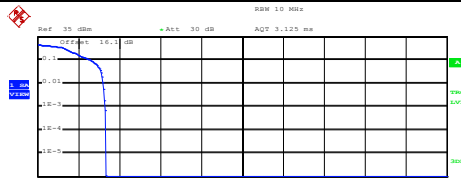

GSM1900 (GSM)	GSM1900 (EDGE class 8)																
<p align="center">Lowest Channel</p>  <p>Ref: 35 dBm *Att: 30 dB AQT: 3.125 ms</p> <p>Center: 1.8502 GHz 2 dB/ Mean Pwr: +20 dB</p> <p>Complementary Cumulative Distribution Function (100000 samples)</p> <p>Trace 1</p> <p>Mean: 28.27 dBm Peak: 28.55 dBm Crest: 0.27 dB</p> <table border="1"> <tr><td>10 %</td><td>0.12 dB</td></tr> <tr><td>1 %</td><td>0.20 dB</td></tr> <tr><td>.1 %</td><td>0.20 dB</td></tr> <tr><td>.01 %</td><td>0.24 dB</td></tr> </table> <p>Date: 15.MAR.2017 08:37:58</p>	10 %	0.12 dB	1 %	0.20 dB	.1 %	0.20 dB	.01 %	0.24 dB	<p align="center">Lowest Channel</p>  <p>Ref: 35 dBm *Att: 30 dB AQT: 3.125 ms</p> <p>Center: 1.8502 GHz 2 dB/ Mean Pwr: +20 dB</p> <p>Complementary Cumulative Distribution Function (100000 samples)</p> <p>Trace 1</p> <p>Mean: 24.17 dBm Peak: 27.42 dBm Crest: 3.25 dB</p> <table border="1"> <tr><td>10 %</td><td>2.56 dB</td></tr> <tr><td>1 %</td><td>3.12 dB</td></tr> <tr><td>.1 %</td><td>3.20 dB</td></tr> <tr><td>.01 %</td><td>3.24 dB</td></tr> </table> <p>Date: 15.MAR.2017 08:52:54</p>	10 %	2.56 dB	1 %	3.12 dB	.1 %	3.20 dB	.01 %	3.24 dB
10 %	0.12 dB																
1 %	0.20 dB																
.1 %	0.20 dB																
.01 %	0.24 dB																
10 %	2.56 dB																
1 %	3.12 dB																
.1 %	3.20 dB																
.01 %	3.24 dB																
<p align="center">Middle Channel</p>  <p>Ref: 35 dBm *Att: 30 dB AQT: 3.125 ms</p> <p>Center: 1.88 GHz 2 dB/ Mean Pwr: +20 dB</p> <p>Complementary Cumulative Distribution Function (100000 samples)</p> <p>Trace 1</p> <p>Mean: 28.54 dBm Peak: 28.76 dBm Crest: 0.22 dB</p> <table border="1"> <tr><td>10 %</td><td>0.12 dB</td></tr> <tr><td>1 %</td><td>0.20 dB</td></tr> <tr><td>.1 %</td><td>0.24 dB</td></tr> <tr><td>.01 %</td><td>0.24 dB</td></tr> </table> <p>Date: 15.MAR.2017 08:38:20</p>	10 %	0.12 dB	1 %	0.20 dB	.1 %	0.24 dB	.01 %	0.24 dB	<p align="center">Middle Channel</p>  <p>Ref: 35 dBm *Att: 30 dB AQT: 3.125 ms</p> <p>Center: 1.88 GHz 2 dB/ Mean Pwr: +20 dB</p> <p>Complementary Cumulative Distribution Function (100000 samples)</p> <p>Trace 1</p> <p>Mean: 24.45 dBm Peak: 27.63 dBm Crest: 3.18 dB</p> <table border="1"> <tr><td>10 %</td><td>2.56 dB</td></tr> <tr><td>1 %</td><td>3.04 dB</td></tr> <tr><td>.1 %</td><td>3.12 dB</td></tr> <tr><td>.01 %</td><td>3.20 dB</td></tr> </table> <p>Date: 15.MAR.2017 08:53:16</p>	10 %	2.56 dB	1 %	3.04 dB	.1 %	3.12 dB	.01 %	3.20 dB
10 %	0.12 dB																
1 %	0.20 dB																
.1 %	0.24 dB																
.01 %	0.24 dB																
10 %	2.56 dB																
1 %	3.04 dB																
.1 %	3.12 dB																
.01 %	3.20 dB																
<p align="center">Highest Channel</p>  <p>Ref: 35 dBm *Att: 30 dB AQT: 3.125 ms</p> <p>Center: 1.9098 GHz 2 dB/ Mean Pwr: +20 dB</p> <p>Complementary Cumulative Distribution Function (100000 samples)</p> <p>Trace 1</p> <p>Mean: 28.47 dBm Peak: 28.76 dBm Crest: 0.29 dB</p> <table border="1"> <tr><td>10 %</td><td>0.12 dB</td></tr> <tr><td>1 %</td><td>0.20 dB</td></tr> <tr><td>.1 %</td><td>0.24 dB</td></tr> <tr><td>.01 %</td><td>0.24 dB</td></tr> </table> <p>Date: 15.MAR.2017 08:38:47</p>	10 %	0.12 dB	1 %	0.20 dB	.1 %	0.24 dB	.01 %	0.24 dB	<p align="center">Highest Channel</p>  <p>Ref: 35 dBm *Att: 30 dB AQT: 3.125 ms</p> <p>Center: 1.9098 GHz 2 dB/ Mean Pwr: +20 dB</p> <p>Complementary Cumulative Distribution Function (100000 samples)</p> <p>Trace 1</p> <p>Mean: 24.21 dBm Peak: 27.56 dBm Crest: 3.35 dB</p> <table border="1"> <tr><td>10 %</td><td>2.60 dB</td></tr> <tr><td>1 %</td><td>3.20 dB</td></tr> <tr><td>.1 %</td><td>3.32 dB</td></tr> <tr><td>.01 %</td><td>3.36 dB</td></tr> </table> <p>Date: 15.MAR.2017 08:53:41</p>	10 %	2.60 dB	1 %	3.20 dB	.1 %	3.32 dB	.01 %	3.36 dB
10 %	0.12 dB																
1 %	0.20 dB																
.1 %	0.24 dB																
.01 %	0.24 dB																
10 %	2.60 dB																
1 %	3.20 dB																
.1 %	3.32 dB																
.01 %	3.36 dB																



26dB Bandwidth

Mode	GSM850	
Mod.	GPRS class 8	EDGE class 8
Lowest CH	0.319	0.266
Middle CH	0.314	0.295
Highest CH	0.301	0.288

Mode	GSM1900	
Mod.	GSM	EDGE class 8
Lowest CH	0.310	0.309
Middle CH	0.316	0.283
Highest CH	0.311	0.293

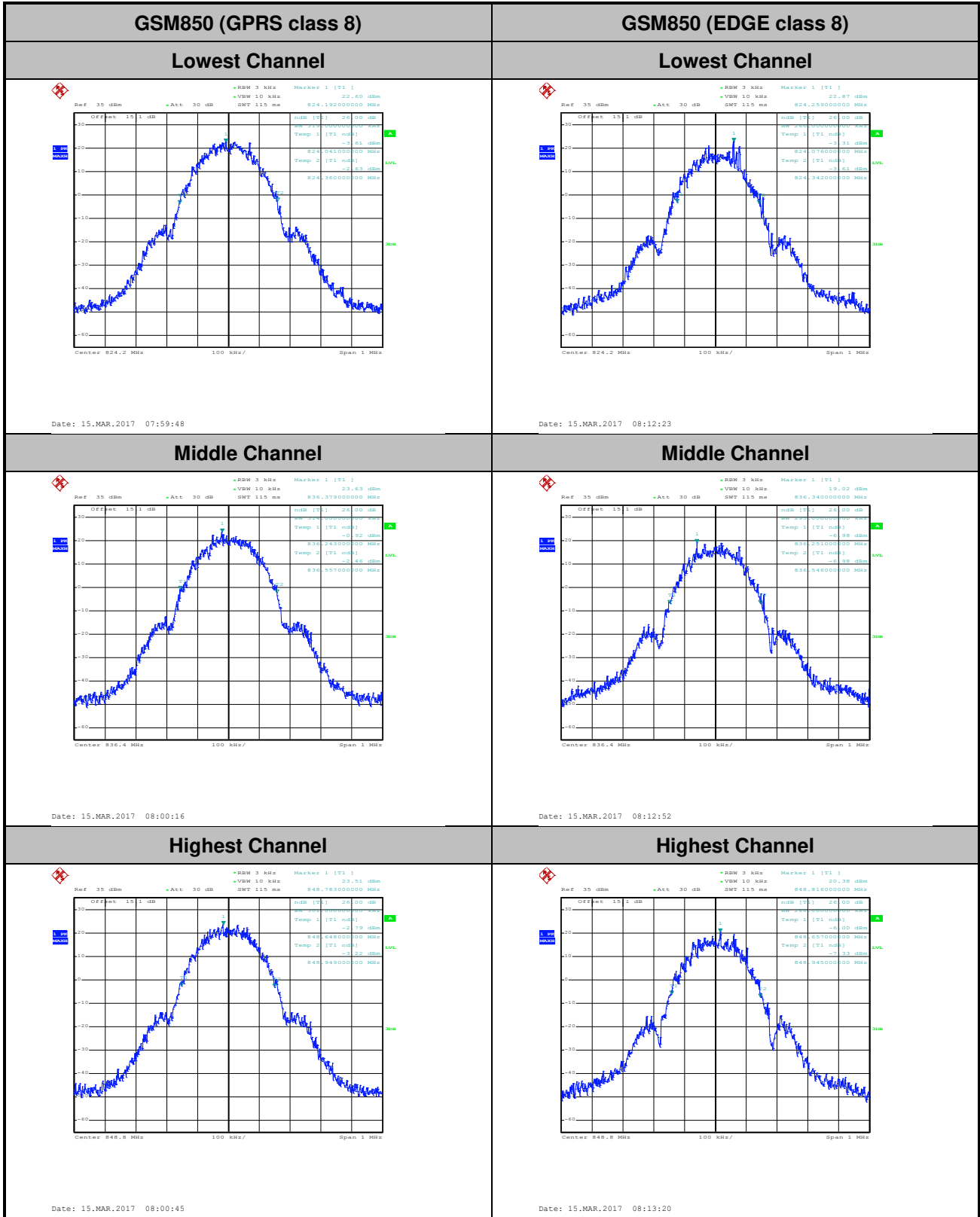



GSM1900 (GSM)

Lowest Channel

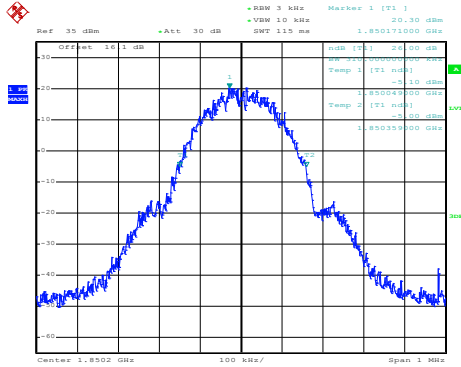

Date: 15.MAR.2017 08:28:46

GSM1900 (EDGE class 8)

Lowest Channel

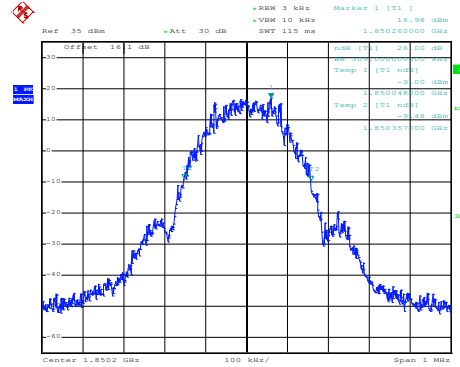

Date: 15.MAR.2017 08:44:37

Middle Channel

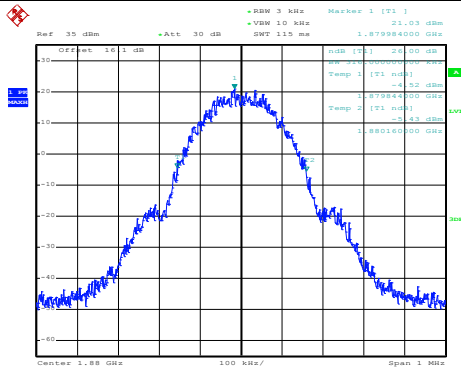

Date: 15.MAR.2017 08:29:14

Middle Channel

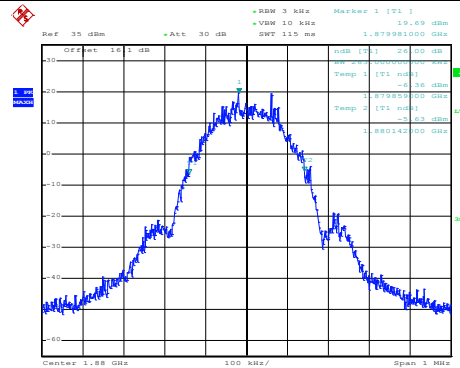

Date: 15.MAR.2017 08:45:06

Highest Channel

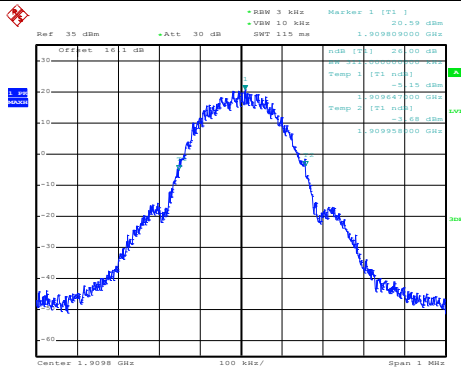

Date: 15.MAR.2017 08:29:43

Highest Channel

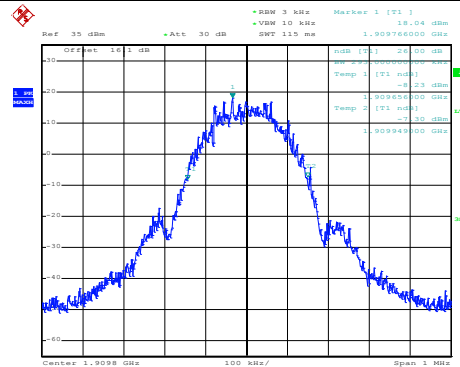

Date: 15.MAR.2017 08:45:34



Occupied Bandwidth

Mode	GSM850	
Mod.	GPRS class 8	EDGE class 8
Lowest CH	0.248	0.238
Middle CH	0.246	0.237
Highest CH	0.247	0.241

Mode	GSM1900	
Mod.	GSM	EDGE class 8
Lowest CH	0.244	0.252
Middle CH	0.245	0.244
Highest CH	0.248	0.247

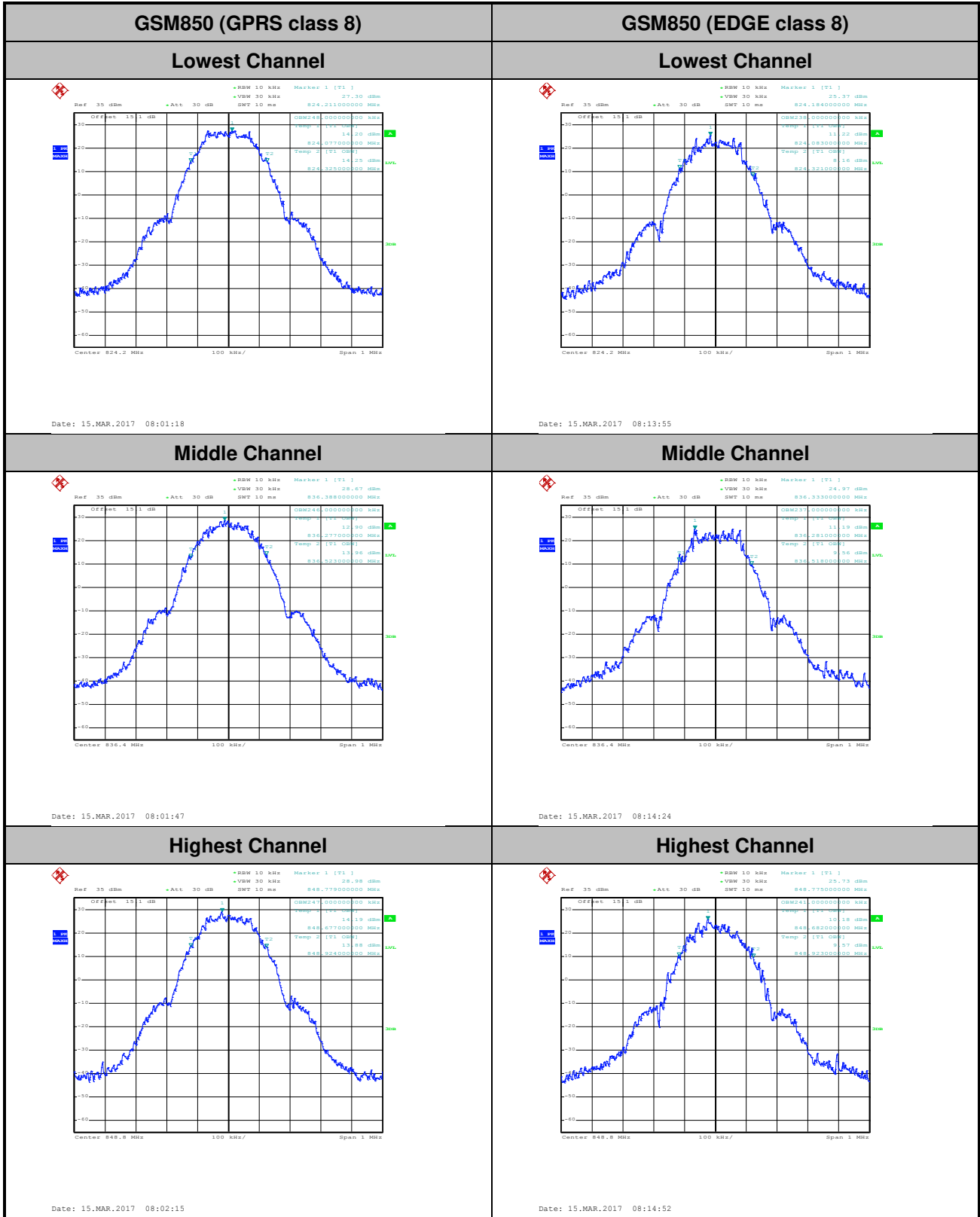

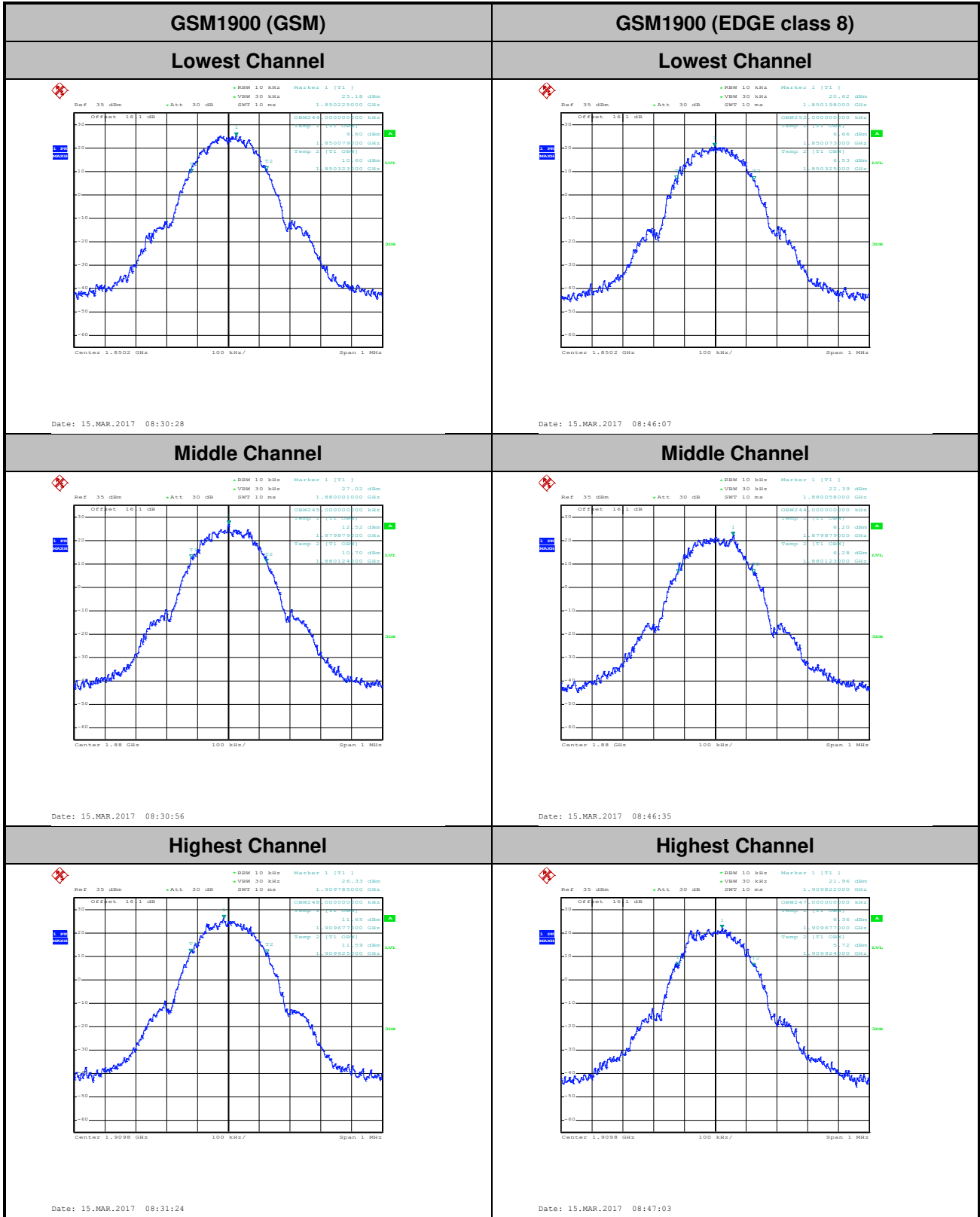



Conducted Band Edge

GSM850 (GPRS class 8)

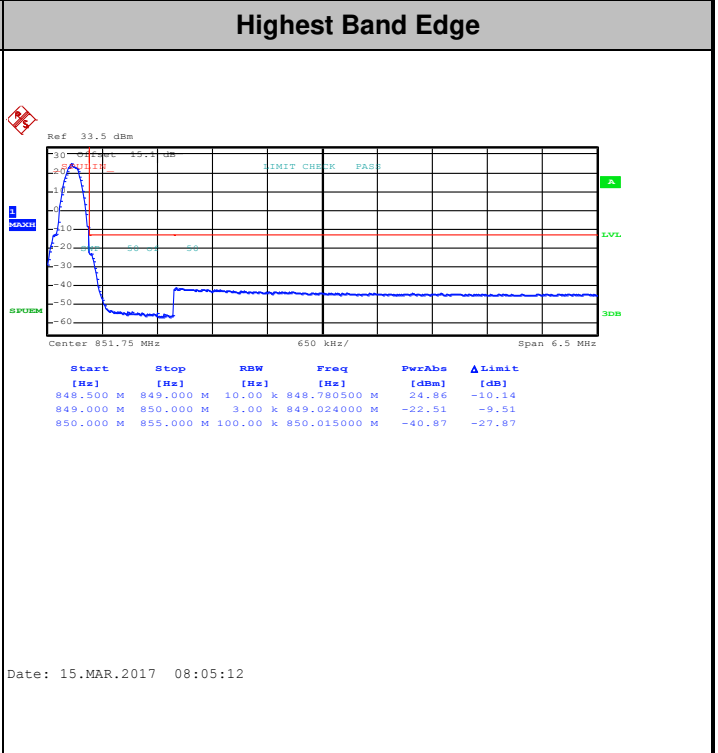
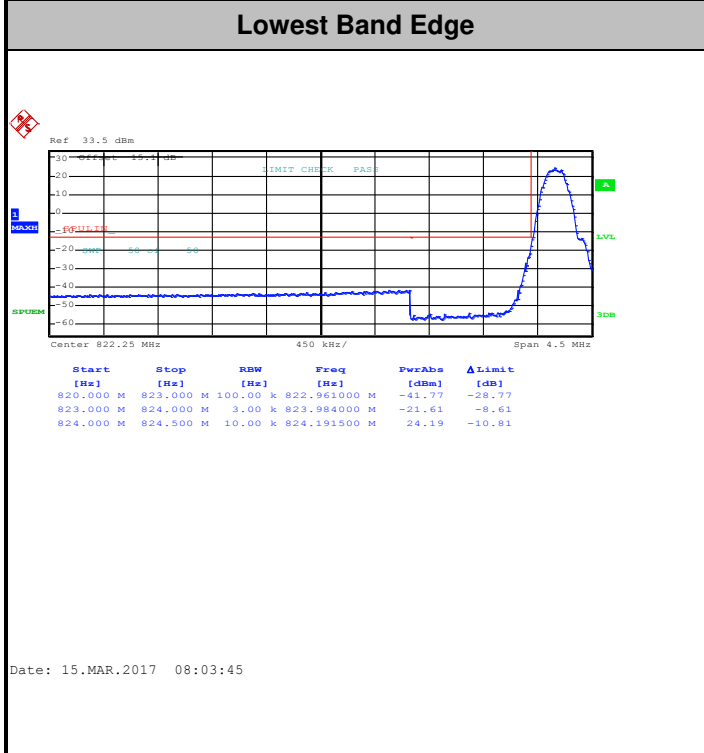

GSM850 (EDGE class 8)

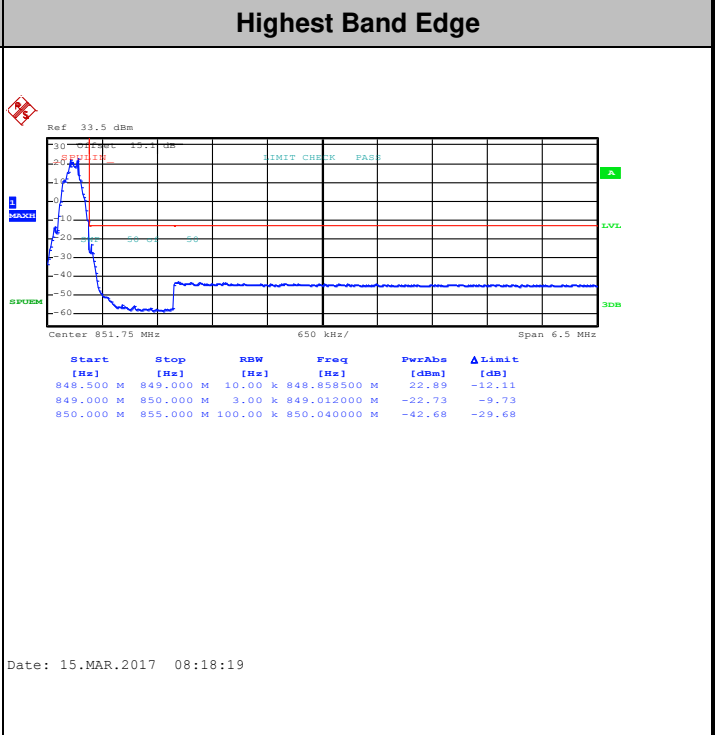
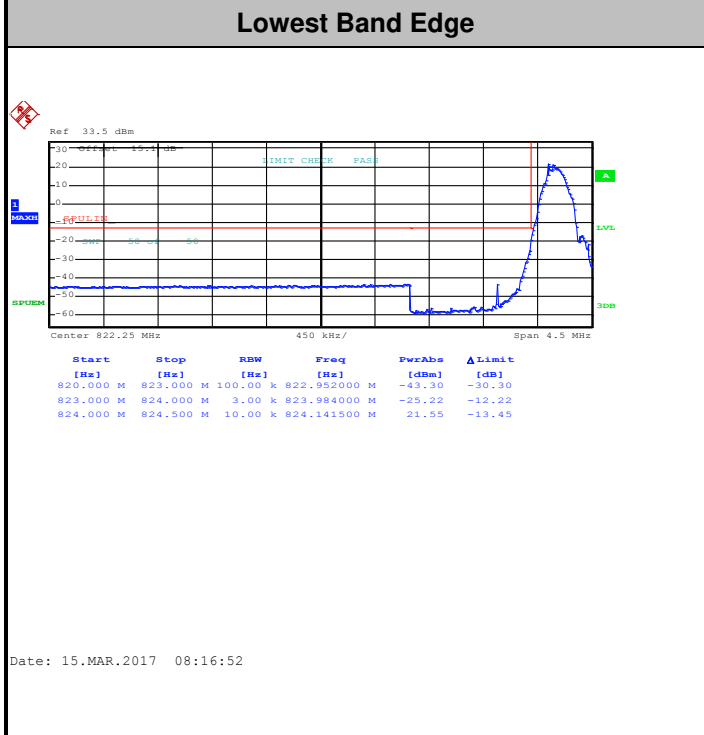



GSM1900 (GSM)

Lowest Band Edge

Highest Band Edge

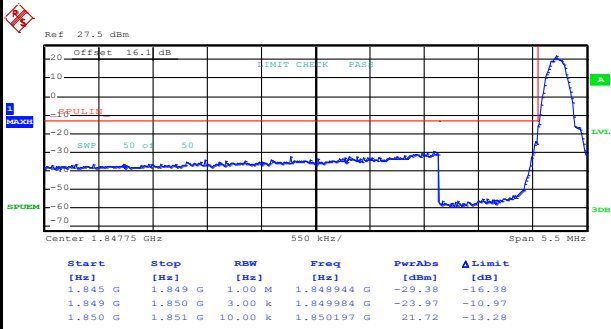

Date: 15.MAR.2017 08:32:58

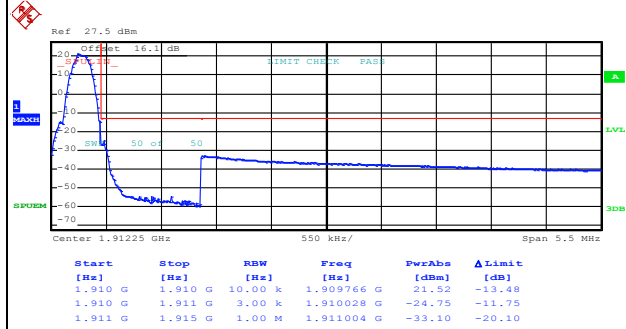

Date: 15.MAR.2017 08:34:25

GSM1900 (EDGE class 8)

Lowest Band Edge

Highest Band Edge

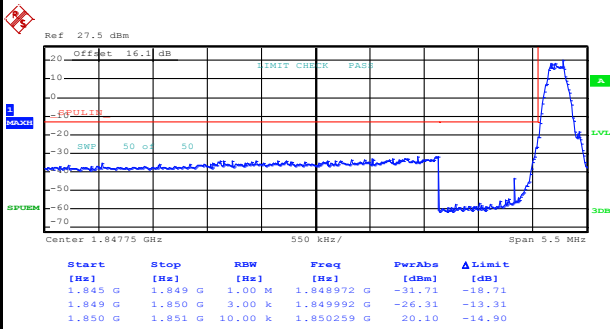

Date: 15.MAR.2017 08:48:33

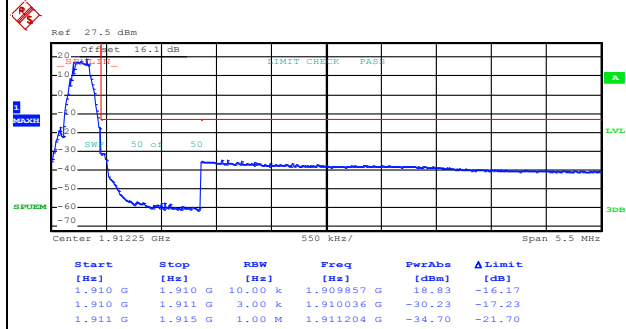

Date: 15.MAR.2017 08:50:00

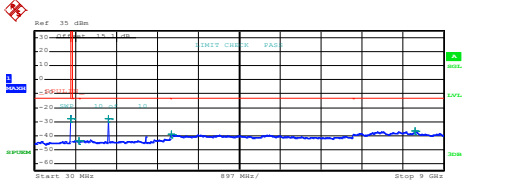
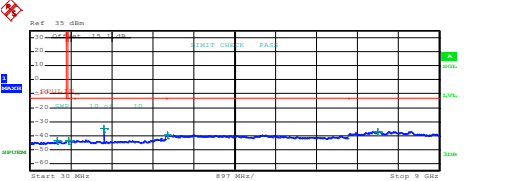
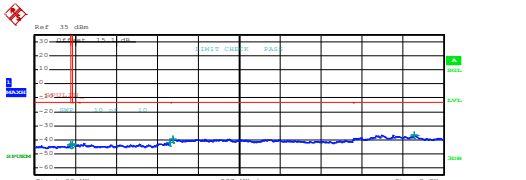
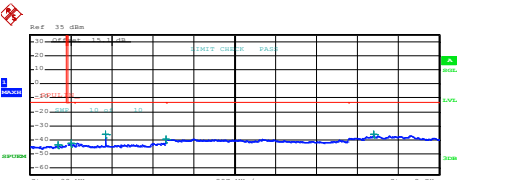
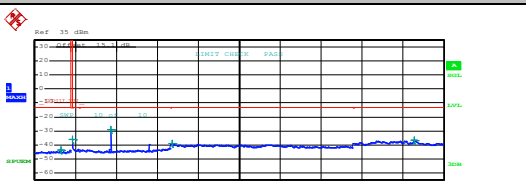
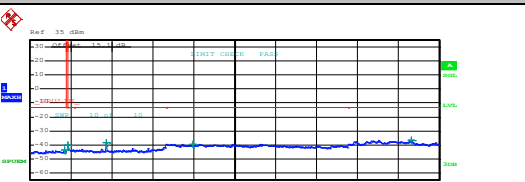

Conducted Spurious Emission

GSM850 (GPRS class 8)	GSM850 (EDGE class 8)																																																																								
Lowest Channel	Lowest Channel																																																																								
 <table border="1" data-bbox="207 660 734 739"> <thead> <tr> <th>Start [Hz]</th> <th>Stop [Hz]</th> <th>RBW [Hz]</th> <th>Freq [Hz]</th> <th>PwrAve [dBm]</th> <th>ΔLimit [dB]</th> </tr> </thead> <tbody> <tr> <td>35,000 M</td> <td>820,000 M</td> <td>1,00 M</td> <td>814,802500 M</td> <td>-27.59</td> <td>-24.59</td> </tr> <tr> <td>855,000 M</td> <td>1,000 G</td> <td>1,00 M</td> <td>996,483760 M</td> <td>-43.40</td> <td>-30.40</td> </tr> <tr> <td>1,000 G</td> <td>3,000 G</td> <td>1,00 M</td> <td>1,648000 G</td> <td>-27.83</td> <td>-24.83</td> </tr> <tr> <td>3,000 G</td> <td>7,000 G</td> <td>1,00 M</td> <td>3,019000 G</td> <td>-39.08</td> <td>-26.08</td> </tr> <tr> <td>7,000 G</td> <td>9,000 G</td> <td>1,00 M</td> <td>8,365500 G</td> <td>-36.49</td> <td>-23.49</td> </tr> </tbody> </table> <p>Date: 15.MAR.2017 08:06:31</p>	Start [Hz]	Stop [Hz]	RBW [Hz]	Freq [Hz]	PwrAve [dBm]	ΔLimit [dB]	35,000 M	820,000 M	1,00 M	814,802500 M	-27.59	-24.59	855,000 M	1,000 G	1,00 M	996,483760 M	-43.40	-30.40	1,000 G	3,000 G	1,00 M	1,648000 G	-27.83	-24.83	3,000 G	7,000 G	1,00 M	3,019000 G	-39.08	-26.08	7,000 G	9,000 G	1,00 M	8,365500 G	-36.49	-23.49	 <table border="1" data-bbox="861 660 1388 739"> <thead> <tr> <th>Start [Hz]</th> <th>Stop [Hz]</th> <th>RBW [Hz]</th> <th>Freq [Hz]</th> <th>PwrAve [dBm]</th> <th>ΔLimit [dB]</th> </tr> </thead> <tbody> <tr> <td>35,000 M</td> <td>820,000 M</td> <td>1,00 M</td> <td>814,205000 M</td> <td>-43.50</td> <td>-30.50</td> </tr> <tr> <td>855,000 M</td> <td>1,000 G</td> <td>1,00 M</td> <td>869,391251 M</td> <td>-43.41</td> <td>-30.41</td> </tr> <tr> <td>1,000 G</td> <td>3,000 G</td> <td>1,00 M</td> <td>1,648000 G</td> <td>-25.06</td> <td>-22.06</td> </tr> <tr> <td>3,000 G</td> <td>7,000 G</td> <td>1,00 M</td> <td>3,049000 G</td> <td>-39.38</td> <td>-26.38</td> </tr> <tr> <td>7,000 G</td> <td>9,000 G</td> <td>1,00 M</td> <td>7,655500 G</td> <td>-36.93</td> <td>-23.93</td> </tr> </tbody> </table> <p>Date: 15.MAR.2017 08:19:49</p>	Start [Hz]	Stop [Hz]	RBW [Hz]	Freq [Hz]	PwrAve [dBm]	ΔLimit [dB]	35,000 M	820,000 M	1,00 M	814,205000 M	-43.50	-30.50	855,000 M	1,000 G	1,00 M	869,391251 M	-43.41	-30.41	1,000 G	3,000 G	1,00 M	1,648000 G	-25.06	-22.06	3,000 G	7,000 G	1,00 M	3,049000 G	-39.38	-26.38	7,000 G	9,000 G	1,00 M	7,655500 G	-36.93	-23.93
Start [Hz]	Stop [Hz]	RBW [Hz]	Freq [Hz]	PwrAve [dBm]	ΔLimit [dB]																																																																				
35,000 M	820,000 M	1,00 M	814,802500 M	-27.59	-24.59																																																																				
855,000 M	1,000 G	1,00 M	996,483760 M	-43.40	-30.40																																																																				
1,000 G	3,000 G	1,00 M	1,648000 G	-27.83	-24.83																																																																				
3,000 G	7,000 G	1,00 M	3,019000 G	-39.08	-26.08																																																																				
7,000 G	9,000 G	1,00 M	8,365500 G	-36.49	-23.49																																																																				
Start [Hz]	Stop [Hz]	RBW [Hz]	Freq [Hz]	PwrAve [dBm]	ΔLimit [dB]																																																																				
35,000 M	820,000 M	1,00 M	814,205000 M	-43.50	-30.50																																																																				
855,000 M	1,000 G	1,00 M	869,391251 M	-43.41	-30.41																																																																				
1,000 G	3,000 G	1,00 M	1,648000 G	-25.06	-22.06																																																																				
3,000 G	7,000 G	1,00 M	3,049000 G	-39.38	-26.38																																																																				
7,000 G	9,000 G	1,00 M	7,655500 G	-36.93	-23.93																																																																				
Middle Channel	Middle Channel																																																																								
 <table border="1" data-bbox="207 1176 734 1254"> <thead> <tr> <th>Start [Hz]</th> <th>Stop [Hz]</th> <th>RBW [Hz]</th> <th>Freq [Hz]</th> <th>PwrAve [dBm]</th> <th>ΔLimit [dB]</th> </tr> </thead> <tbody> <tr> <td>35,000 M</td> <td>820,000 M</td> <td>1,00 M</td> <td>814,805000 M</td> <td>-43.87</td> <td>-30.87</td> </tr> <tr> <td>855,000 M</td> <td>1,000 G</td> <td>1,00 M</td> <td>861,102500 M</td> <td>-43.24</td> <td>-30.24</td> </tr> <tr> <td>1,000 G</td> <td>3,000 G</td> <td>1,00 M</td> <td>2,991000 G</td> <td>-41.97</td> <td>-28.97</td> </tr> <tr> <td>3,000 G</td> <td>7,000 G</td> <td>1,00 M</td> <td>3,053000 G</td> <td>-39.62</td> <td>-26.62</td> </tr> <tr> <td>7,000 G</td> <td>9,000 G</td> <td>1,00 M</td> <td>8,355000 G</td> <td>-36.52</td> <td>-23.52</td> </tr> </tbody> </table> <p>Date: 15.MAR.2017 08:07:17</p>	Start [Hz]	Stop [Hz]	RBW [Hz]	Freq [Hz]	PwrAve [dBm]	ΔLimit [dB]	35,000 M	820,000 M	1,00 M	814,805000 M	-43.87	-30.87	855,000 M	1,000 G	1,00 M	861,102500 M	-43.24	-30.24	1,000 G	3,000 G	1,00 M	2,991000 G	-41.97	-28.97	3,000 G	7,000 G	1,00 M	3,053000 G	-39.62	-26.62	7,000 G	9,000 G	1,00 M	8,355000 G	-36.52	-23.52	 <table border="1" data-bbox="861 1176 1388 1254"> <thead> <tr> <th>Start [Hz]</th> <th>Stop [Hz]</th> <th>RBW [Hz]</th> <th>Freq [Hz]</th> <th>PwrAve [dBm]</th> <th>ΔLimit [dB]</th> </tr> </thead> <tbody> <tr> <td>35,000 M</td> <td>820,000 M</td> <td>1,00 M</td> <td>842,645000 M</td> <td>-43.91</td> <td>-30.91</td> </tr> <tr> <td>855,000 M</td> <td>1,000 G</td> <td>1,00 M</td> <td>820,952500 M</td> <td>-42.62</td> <td>-29.62</td> </tr> <tr> <td>1,000 G</td> <td>3,000 G</td> <td>1,00 M</td> <td>1,672500 G</td> <td>-36.03</td> <td>-23.03</td> </tr> <tr> <td>3,000 G</td> <td>7,000 G</td> <td>1,00 M</td> <td>3,001000 G</td> <td>-39.48</td> <td>-26.48</td> </tr> <tr> <td>7,000 G</td> <td>9,000 G</td> <td>1,00 M</td> <td>7,557500 G</td> <td>-36.21</td> <td>-23.21</td> </tr> </tbody> </table> <p>Date: 15.MAR.2017 08:20:34</p>	Start [Hz]	Stop [Hz]	RBW [Hz]	Freq [Hz]	PwrAve [dBm]	ΔLimit [dB]	35,000 M	820,000 M	1,00 M	842,645000 M	-43.91	-30.91	855,000 M	1,000 G	1,00 M	820,952500 M	-42.62	-29.62	1,000 G	3,000 G	1,00 M	1,672500 G	-36.03	-23.03	3,000 G	7,000 G	1,00 M	3,001000 G	-39.48	-26.48	7,000 G	9,000 G	1,00 M	7,557500 G	-36.21	-23.21
Start [Hz]	Stop [Hz]	RBW [Hz]	Freq [Hz]	PwrAve [dBm]	ΔLimit [dB]																																																																				
35,000 M	820,000 M	1,00 M	814,805000 M	-43.87	-30.87																																																																				
855,000 M	1,000 G	1,00 M	861,102500 M	-43.24	-30.24																																																																				
1,000 G	3,000 G	1,00 M	2,991000 G	-41.97	-28.97																																																																				
3,000 G	7,000 G	1,00 M	3,053000 G	-39.62	-26.62																																																																				
7,000 G	9,000 G	1,00 M	8,355000 G	-36.52	-23.52																																																																				
Start [Hz]	Stop [Hz]	RBW [Hz]	Freq [Hz]	PwrAve [dBm]	ΔLimit [dB]																																																																				
35,000 M	820,000 M	1,00 M	842,645000 M	-43.91	-30.91																																																																				
855,000 M	1,000 G	1,00 M	820,952500 M	-42.62	-29.62																																																																				
1,000 G	3,000 G	1,00 M	1,672500 G	-36.03	-23.03																																																																				
3,000 G	7,000 G	1,00 M	3,001000 G	-39.48	-26.48																																																																				
7,000 G	9,000 G	1,00 M	7,557500 G	-36.21	-23.21																																																																				
Highest Channel	Highest Channel																																																																								
 <table border="1" data-bbox="207 1691 734 1769"> <thead> <tr> <th>Start [Hz]</th> <th>Stop [Hz]</th> <th>RBW [Hz]</th> <th>Freq [Hz]</th> <th>PwrAve [dBm]</th> <th>ΔLimit [dB]</th> </tr> </thead> <tbody> <tr> <td>35,000 M</td> <td>820,000 M</td> <td>1,00 M</td> <td>601,900000 M</td> <td>-43.71</td> <td>-30.71</td> </tr> <tr> <td>855,000 M</td> <td>1,000 G</td> <td>1,00 M</td> <td>850,036250 M</td> <td>-36.13</td> <td>-23.13</td> </tr> <tr> <td>1,000 G</td> <td>3,000 G</td> <td>1,00 M</td> <td>1,697500 G</td> <td>-39.22</td> <td>-26.22</td> </tr> <tr> <td>3,000 G</td> <td>7,000 G</td> <td>1,00 M</td> <td>3,047000 G</td> <td>-39.07</td> <td>-26.07</td> </tr> <tr> <td>7,000 G</td> <td>9,000 G</td> <td>1,00 M</td> <td>8,363000 G</td> <td>-36.50</td> <td>-23.50</td> </tr> </tbody> </table> <p>Date: 15.MAR.2017 08:08:03</p>	Start [Hz]	Stop [Hz]	RBW [Hz]	Freq [Hz]	PwrAve [dBm]	ΔLimit [dB]	35,000 M	820,000 M	1,00 M	601,900000 M	-43.71	-30.71	855,000 M	1,000 G	1,00 M	850,036250 M	-36.13	-23.13	1,000 G	3,000 G	1,00 M	1,697500 G	-39.22	-26.22	3,000 G	7,000 G	1,00 M	3,047000 G	-39.07	-26.07	7,000 G	9,000 G	1,00 M	8,363000 G	-36.50	-23.50	 <table border="1" data-bbox="861 1691 1388 1769"> <thead> <tr> <th>Start [Hz]</th> <th>Stop [Hz]</th> <th>RBW [Hz]</th> <th>Freq [Hz]</th> <th>PwrAve [dBm]</th> <th>ΔLimit [dB]</th> </tr> </thead> <tbody> <tr> <td>35,000 M</td> <td>820,000 M</td> <td>1,00 M</td> <td>785,635000 M</td> <td>-43.72</td> <td>-30.72</td> </tr> <tr> <td>855,000 M</td> <td>1,000 G</td> <td>1,00 M</td> <td>850,036250 M</td> <td>-39.87</td> <td>-26.87</td> </tr> <tr> <td>1,000 G</td> <td>3,000 G</td> <td>1,00 M</td> <td>1,697500 G</td> <td>-39.36</td> <td>-26.36</td> </tr> <tr> <td>3,000 G</td> <td>7,000 G</td> <td>1,00 M</td> <td>3,056000 G</td> <td>-39.29</td> <td>-26.29</td> </tr> <tr> <td>7,000 G</td> <td>9,000 G</td> <td>1,00 M</td> <td>8,366500 G</td> <td>-36.72</td> <td>-23.72</td> </tr> </tbody> </table> <p>Date: 15.MAR.2017 08:21:20</p>	Start [Hz]	Stop [Hz]	RBW [Hz]	Freq [Hz]	PwrAve [dBm]	ΔLimit [dB]	35,000 M	820,000 M	1,00 M	785,635000 M	-43.72	-30.72	855,000 M	1,000 G	1,00 M	850,036250 M	-39.87	-26.87	1,000 G	3,000 G	1,00 M	1,697500 G	-39.36	-26.36	3,000 G	7,000 G	1,00 M	3,056000 G	-39.29	-26.29	7,000 G	9,000 G	1,00 M	8,366500 G	-36.72	-23.72
Start [Hz]	Stop [Hz]	RBW [Hz]	Freq [Hz]	PwrAve [dBm]	ΔLimit [dB]																																																																				
35,000 M	820,000 M	1,00 M	601,900000 M	-43.71	-30.71																																																																				
855,000 M	1,000 G	1,00 M	850,036250 M	-36.13	-23.13																																																																				
1,000 G	3,000 G	1,00 M	1,697500 G	-39.22	-26.22																																																																				
3,000 G	7,000 G	1,00 M	3,047000 G	-39.07	-26.07																																																																				
7,000 G	9,000 G	1,00 M	8,363000 G	-36.50	-23.50																																																																				
Start [Hz]	Stop [Hz]	RBW [Hz]	Freq [Hz]	PwrAve [dBm]	ΔLimit [dB]																																																																				
35,000 M	820,000 M	1,00 M	785,635000 M	-43.72	-30.72																																																																				
855,000 M	1,000 G	1,00 M	850,036250 M	-39.87	-26.87																																																																				
1,000 G	3,000 G	1,00 M	1,697500 G	-39.36	-26.36																																																																				
3,000 G	7,000 G	1,00 M	3,056000 G	-39.29	-26.29																																																																				
7,000 G	9,000 G	1,00 M	8,366500 G	-36.72	-23.72																																																																				



GSM1900 (GSM)

Lowest Channel

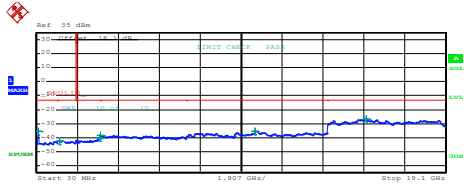

Start [Hz]	Stop [Hz]	RBW [Hz]	Freq [Hz]	PwrAve [dBm]	ΔLimit [dB]
30.000 M	1.000 G	1.00 M	111.965500 M	-35.44	-22.45
1.000 G	1.845 G	1.00 M	1.085979 G	-42.24	-29.24
1.845 G	3.000 G	1.00 M	2.902296 G	-40.42	-27.42
3.000 G	7.000 G	1.00 M	3.003000 G	-38.48	-25.48
7.000 G	13.600 G	1.00 M	10.219975 G	-35.49	-22.49
13.600 G	19.100 G	1.00 M	15.393063 G	-26.92	-13.92

Date: 15.MAR.2017 08:35:21

GSM1900 (EDGE class 8)

Lowest Channel

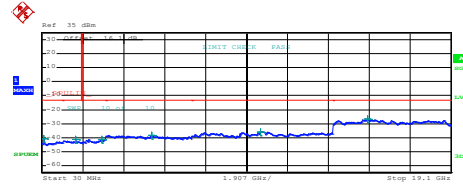

Start [Hz]	Stop [Hz]	RBW [Hz]	Freq [Hz]	PwrAve [dBm]	ΔLimit [dB]
30.000 M	1.000 G	1.00 M	112.207100 M	-40.87	-27.87
1.000 G	1.845 G	1.00 M	1.596781 G	-41.29	-28.29
1.845 G	3.000 G	1.00 M	2.797959 G	-41.23	-28.23
3.000 G	7.000 G	1.00 M	5.153000 G	-38.43	-25.43
7.000 G	13.600 G	1.00 M	10.212550 G	-35.87	-22.87
13.600 G	19.100 G	1.00 M	15.225250 G	-26.94	-13.94

Date: 15.MAR.2017 08:50:54

Middle Channel

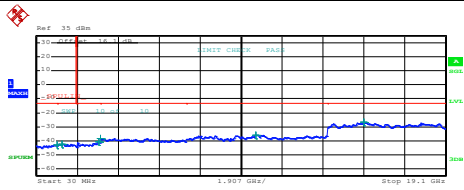

Start [Hz]	Stop [Hz]	RBW [Hz]	Freq [Hz]	PwrAve [dBm]	ΔLimit [dB]
30.000 M	1.000 G	1.00 M	979.387500 M	-43.01	-30.01
1.000 G	1.845 G	1.00 M	1.226460 G	-42.31	-29.31
1.845 G	3.000 G	1.00 M	2.942495 G	-41.01	-28.01
3.000 G	7.000 G	1.00 M	3.014000 G	-38.14	-25.14
7.000 G	13.600 G	1.00 M	10.234000 G	-35.76	-22.76
13.600 G	19.100 G	1.00 M	15.291250 G	-26.95	-13.95

Date: 15.MAR.2017 08:36:07

Middle Channel

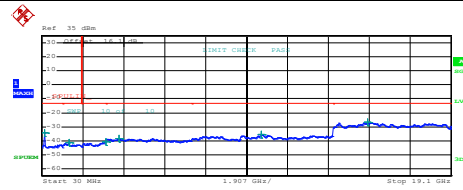

Start [Hz]	Stop [Hz]	RBW [Hz]	Freq [Hz]	PwrAve [dBm]	ΔLimit [dB]
30.000 M	1.000 G	1.00 M	141.792500 M	-34.38	-21.38
1.000 G	1.845 G	1.00 M	1.330579 G	-41.84	-28.84
1.845 G	3.000 G	1.00 M	2.994846 G	-41.01	-28.01
3.000 G	7.000 G	1.00 M	3.599000 G	-38.60	-25.60
7.000 G	13.600 G	1.00 M	10.248000 G	-35.99	-22.99
13.600 G	19.100 G	1.00 M	15.217000 G	-26.81	-13.81

Date: 15.MAR.2017 08:51:40

Highest Channel

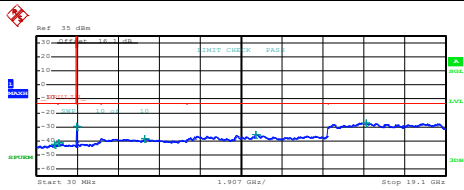

Start [Hz]	Stop [Hz]	RBW [Hz]	Freq [Hz]	PwrAve [dBm]	ΔLimit [dB]
30.000 M	1.000 G	1.00 M	871.253500 M	-42.38	-29.38
1.000 G	1.845 G	1.00 M	1.044785 G	-41.49	-28.49
1.845 G	3.000 G	1.00 M	1.932071 G	-39.77	-26.77
3.000 G	7.000 G	1.00 M	5.076000 G	-38.38	-25.38
7.000 G	13.600 G	1.00 M	10.249675 G	-35.25	-22.25
13.600 G	19.100 G	1.00 M	15.393000 G	-27.10	-14.10

Date: 15.MAR.2017 08:36:53

Highest Channel

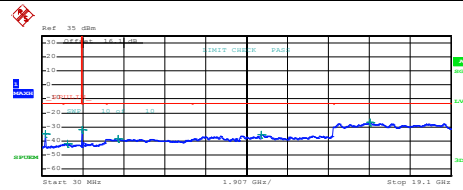

Start [Hz]	Stop [Hz]	RBW [Hz]	Freq [Hz]	PwrAve [dBm]	ΔLimit [dB]
30.000 M	1.000 G	1.00 M	171.620500 M	-34.90	-21.90
1.000 G	1.845 G	1.00 M	1.213785 G	-41.97	-28.97
1.845 G	3.000 G	1.00 M	1.935271 G	-39.77	-26.77
3.000 G	7.000 G	1.00 M	3.571000 G	-38.67	-25.67
7.000 G	13.600 G	1.00 M	10.233175 G	-35.45	-22.45
13.600 G	19.100 G	1.00 M	15.320325 G	-26.75	-13.75

Date: 15.MAR.2017 08:52:26



Frequency Stability

Test Conditions	Middle Channel	GSM850 (GPRS class 8)	GSM850 (EDGE class 8)	Limit 2.5ppm
Temperature (°C)	Voltage (Volt)	Deviation (ppm)		Result
50	Normal Voltage	0.0012	0.0000	PASS
40	Normal Voltage	0.0024	0.0024	
30	Normal Voltage	0.0048	0.0048	
20(Ref.)	Normal Voltage	0.0000	0.0000	
10	Normal Voltage	0.0072	0.0012	
0	Normal Voltage	0.0036	0.0084	
-10	Normal Voltage	0.0012	0.0048	
-20	Normal Voltage	0.0012	0.0060	
-30	Normal Voltage	0.0024	0.0036	
20	Maximum Voltage	0.0072	0.0048	
20	Normal Voltage	0.0036	0.0000	
20	Battery End Point	0.0036	0.0024	

Note:

1. Normal Voltage = 3.9V. ; Battery End Point (BEP) = 3.5 V. ; Maximum Voltage =4.3 V
2. The frequency fundamental emissions stay within the authorized frequency block.



Test Conditions	Middle Channel	GSM1900 (GSM)	GSM1900 (EDGE class 8)	Limit Note 2.
Temperature (°C)	Voltage (Volt)	Deviation (ppm)		Result
50	Normal Voltage	0.0016	0.0016	PASS
40	Normal Voltage	0.0016	0.0027	
30	Normal Voltage	0.0037	0.0011	
20(Ref.)	Normal Voltage	0.0000	0.0000	
10	Normal Voltage	0.0160	0.0021	
0	Normal Voltage	0.0128	0.0521	
-10	Normal Voltage	0.0117	0.0601	
-20	Normal Voltage	0.0160	0.0606	
-30	Normal Voltage	0.0170	0.0553	
20	Maximum Voltage	0.0011	0.0043	
20	Normal Voltage	0.0000	0.0000	
20	Battery End Point	0.0027	0.0027	

Note:

1. Normal Voltage = 3.9V. ; Battery End Point (BEP) = 3.5 V. ; Maximum Voltage =4.3 V
2. The frequency fundamental emissions stay within the authorized frequency block.



A3. WCDMA

Peak-to-Average Ratio

Mode	WCDMA Band V	WCDMA Band II	Limit: 13dB
Mod.	RMC 12.2Kbps	RMC 12.2Kbps	Result
Lowest CH	3.20	3.08	PASS
Middle CH	3.20	3.00	
Highest CH	3.08	3.08	

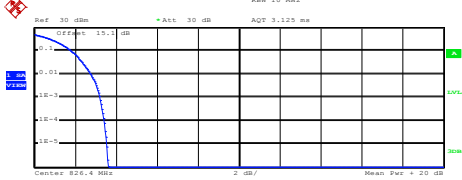
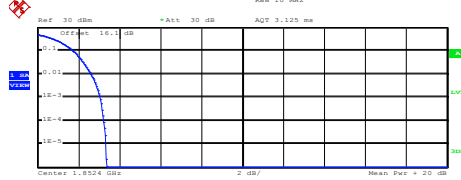
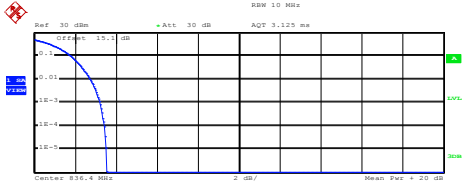
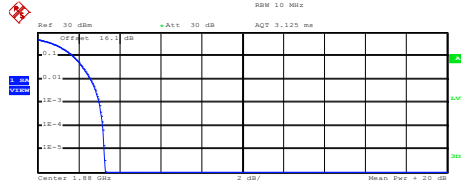
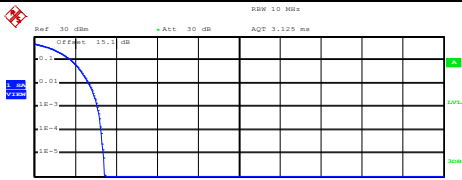
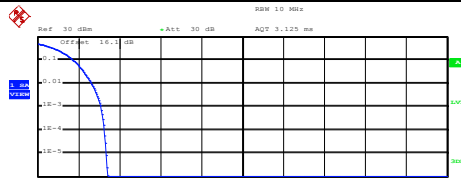

WCDMA Band V (RMC 12.2Kbps)	WCDMA Band II (RMC 12.2Kbps)																
<p align="center">Lowest Channel</p>  <p>Center 826.4 MHz 2 dB/ Mean Pwr + 20 dB</p> <p>Complementary Cumulative Distribution Function (100000 samples) Trace 1 Mean 22.27 dBm Peak 25.88 dBm Crest 3.61 dB</p> <table border="0"> <tr><td>10 %</td><td>1.80 dB</td></tr> <tr><td>1 %</td><td>2.76 dB</td></tr> <tr><td>.1 %</td><td>3.20 dB</td></tr> <tr><td>.01 %</td><td>3.44 dB</td></tr> </table> <p>Date: 15.MAR.2017 09:52:11</p>	10 %	1.80 dB	1 %	2.76 dB	.1 %	3.20 dB	.01 %	3.44 dB	<p align="center">Lowest Channel</p>  <p>Center 1.8524 GHz 2 dB/ Mean Pwr + 20 dB</p> <p>Complementary Cumulative Distribution Function (100000 samples) Trace 1 Mean 23.01 dBm Peak 26.37 dBm Crest 3.36 dB</p> <table border="0"> <tr><td>10 %</td><td>1.76 dB</td></tr> <tr><td>1 %</td><td>2.60 dB</td></tr> <tr><td>.1 %</td><td>3.08 dB</td></tr> <tr><td>.01 %</td><td>3.24 dB</td></tr> </table> <p>Date: 15.MAR.2017 09:36:53</p>	10 %	1.76 dB	1 %	2.60 dB	.1 %	3.08 dB	.01 %	3.24 dB
10 %	1.80 dB																
1 %	2.76 dB																
.1 %	3.20 dB																
.01 %	3.44 dB																
10 %	1.76 dB																
1 %	2.60 dB																
.1 %	3.08 dB																
.01 %	3.24 dB																
<p align="center">Middle Channel</p>  <p>Center 830.4 MHz 2 dB/ Mean Pwr + 20 dB</p> <p>Complementary Cumulative Distribution Function (100000 samples) Trace 1 Mean 22.32 dBm Peak 25.88 dBm Crest 3.56 dB</p> <table border="0"> <tr><td>10 %</td><td>1.80 dB</td></tr> <tr><td>1 %</td><td>2.76 dB</td></tr> <tr><td>.1 %</td><td>3.20 dB</td></tr> <tr><td>.01 %</td><td>3.44 dB</td></tr> </table> <p>Date: 15.MAR.2017 09:52:26</p>	10 %	1.80 dB	1 %	2.76 dB	.1 %	3.20 dB	.01 %	3.44 dB	<p align="center">Middle Channel</p>  <p>Center 1.88 GHz 2 dB/ Mean Pwr + 20 dB</p> <p>Complementary Cumulative Distribution Function (100000 samples) Trace 1 Mean 22.94 dBm Peak 26.23 dBm Crest 3.29 dB</p> <table border="0"> <tr><td>10 %</td><td>1.72 dB</td></tr> <tr><td>1 %</td><td>2.60 dB</td></tr> <tr><td>.1 %</td><td>3.00 dB</td></tr> <tr><td>.01 %</td><td>3.20 dB</td></tr> </table> <p>Date: 15.MAR.2017 09:37:04</p>	10 %	1.72 dB	1 %	2.60 dB	.1 %	3.00 dB	.01 %	3.20 dB
10 %	1.80 dB																
1 %	2.76 dB																
.1 %	3.20 dB																
.01 %	3.44 dB																
10 %	1.72 dB																
1 %	2.60 dB																
.1 %	3.00 dB																
.01 %	3.20 dB																
<p align="center">Highest Channel</p>  <p>Center 846.6 MHz 2 dB/ Mean Pwr + 20 dB</p> <p>Complementary Cumulative Distribution Function (100000 samples) Trace 1 Mean 22.57 dBm Peak 26.02 dBm Crest 3.44 dB</p> <table border="0"> <tr><td>10 %</td><td>1.80 dB</td></tr> <tr><td>1 %</td><td>2.68 dB</td></tr> <tr><td>.1 %</td><td>3.08 dB</td></tr> <tr><td>.01 %</td><td>3.28 dB</td></tr> </table> <p>Date: 15.MAR.2017 09:52:54</p>	10 %	1.80 dB	1 %	2.68 dB	.1 %	3.08 dB	.01 %	3.28 dB	<p align="center">Highest Channel</p>  <p>Center 1.9076 GHz 2 dB/ Mean Pwr + 20 dB</p> <p>Complementary Cumulative Distribution Function (100000 samples) Trace 1 Mean 22.46 dBm Peak 25.88 dBm Crest 3.41 dB</p> <table border="0"> <tr><td>10 %</td><td>1.76 dB</td></tr> <tr><td>1 %</td><td>2.64 dB</td></tr> <tr><td>.1 %</td><td>3.08 dB</td></tr> <tr><td>.01 %</td><td>3.28 dB</td></tr> </table> <p>Date: 15.MAR.2017 09:37:25</p>	10 %	1.76 dB	1 %	2.64 dB	.1 %	3.08 dB	.01 %	3.28 dB
10 %	1.80 dB																
1 %	2.68 dB																
.1 %	3.08 dB																
.01 %	3.28 dB																
10 %	1.76 dB																
1 %	2.64 dB																
.1 %	3.08 dB																
.01 %	3.28 dB																



26dB Bandwidth

Mode	WCDMA Band V	WCDMA Band II
Mod.	RMC 12.2Kbps	RMC 12.2Kbps
Lowest CH	4.70	4.69
Middle CH	4.67	4.69
Highest CH	4.69	4.69



WCDMA Band V (RMC 12.2Kbps)

WCDMA Band II (RMC 12.2Kbps)

Lowest Channel

Lowest Channel

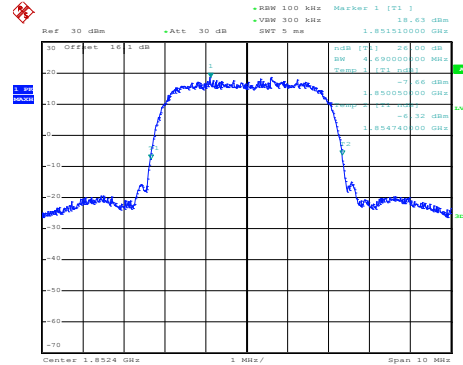
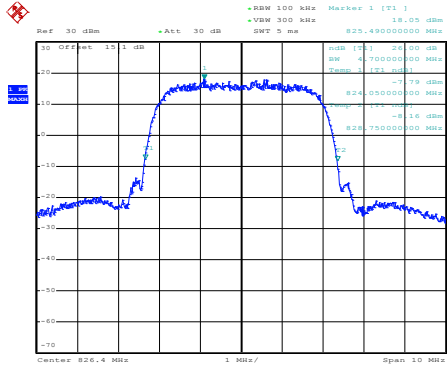

Date: 15.MAR.2017 09:38:24

Date: 15.MAR.2017 09:00:19

Middle Channel

Middle Channel

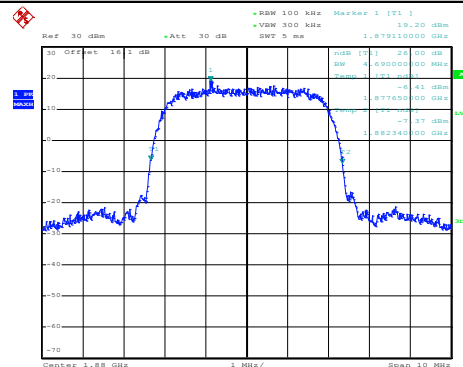
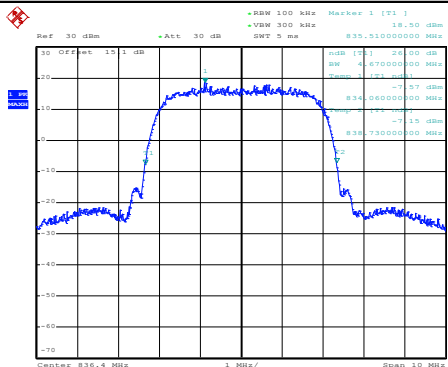

Date: 15.MAR.2017 09:38:58

Date: 15.MAR.2017 09:00:47

Highest Channel

Highest Channel

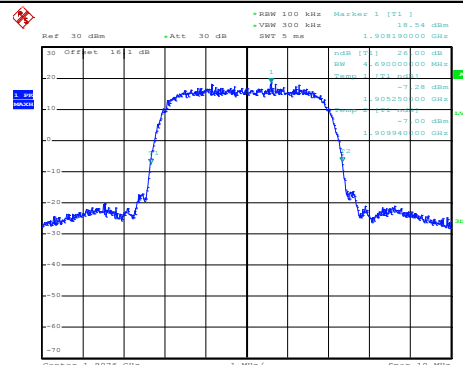
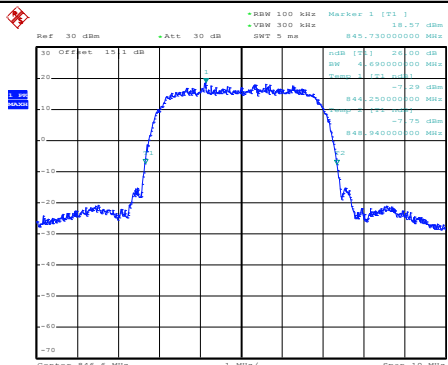

Date: 15.MAR.2017 09:39:33

Date: 15.MAR.2017 09:01:15



Occupied Bandwidth

Mode	WCDMA Band V	WCDMA Band II
Mod.	RMC 12.2Kbps	RMC 12.2Kbps
Lowest CH	4.13	4.12
Middle CH	4.12	4.13
Highest CH	4.13	4.13



WCDMA Band V (RMC 12.2Kbps)

WCDMA Band II (RMC 12.2Kbps)

Lowest Channel

Lowest Channel

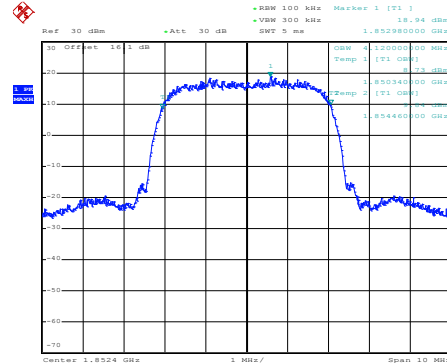
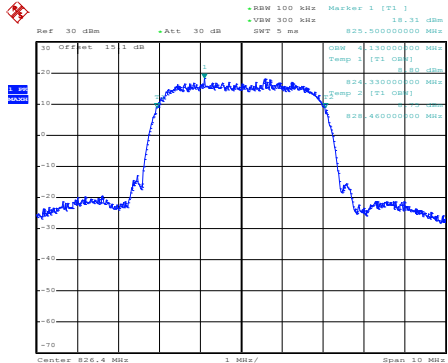

Date: 15.MAR.2017 09:41:51

Date: 15.MAR.2017 09:02:05

Middle Channel

Middle Channel

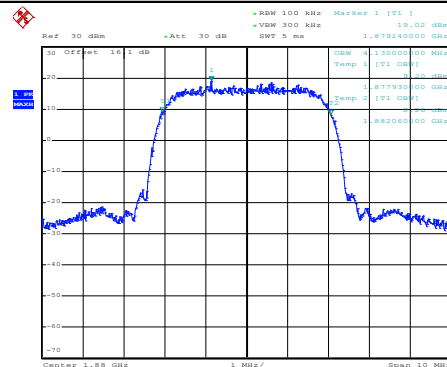
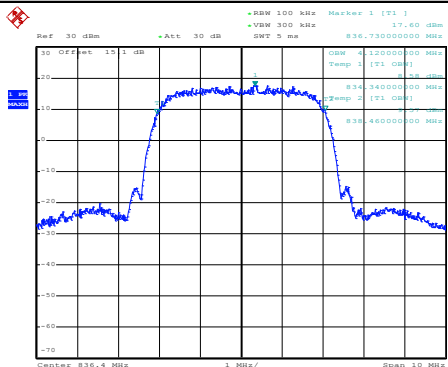

Date: 15.MAR.2017 09:42:33

Date: 15.MAR.2017 09:02:33

Highest Channel

Highest Channel

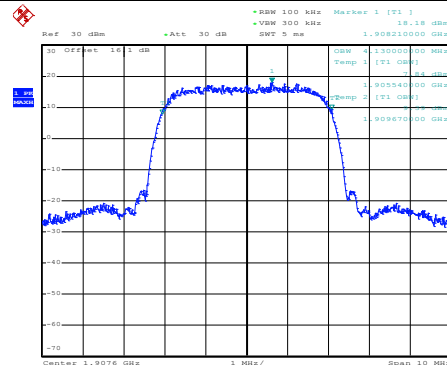
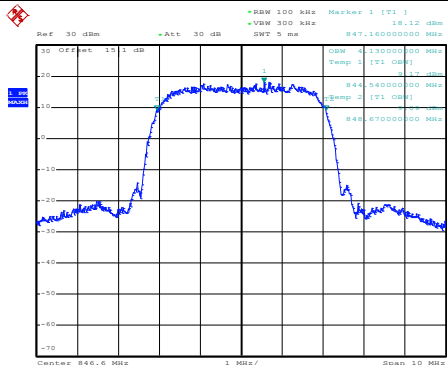

Date: 15.MAR.2017 09:43:17

Date: 15.MAR.2017 09:03:01



Conducted Band Edge

WCDMA Band V (RMC 12.2Kbps)

Lowest Band Edge

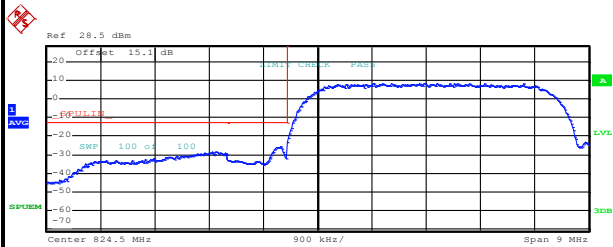

Start [Hz]	Stop [Hz]	RBW [Hz]	Freq [Hz]	PwrAbs [dBm]	ΔLimit [dB]
820.000 M	823.000 M	100.00 k	822.832000 M	-29.32	-15.32
823.000 M	824.000 M	50.00 k	823.876000 M	-25.83	-12.83
824.000 M	829.000 M	100.00 k	826.260000 M	8.32	-26.68

Date: 15.MAR.2017 09:46:07

Highest Band Edge

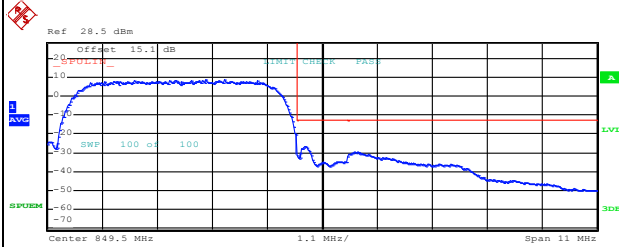

Start [Hz]	Stop [Hz]	RBW [Hz]	Freq [Hz]	PwrAbs [dBm]	ΔLimit [dB]
846.000 M	849.000 M	100.00 k	847.155000 M	9.85	-26.15
849.000 M	850.000 M	50.00 k	849.168000 M	-26.50	-13.50
850.000 M	855.000 M	100.00 k	850.190000 M	-29.45	-16.45

Date: 15.MAR.2017 09:48:56

WCDMA Band II (RMC 12.2Kbps)

Lowest Band Edge

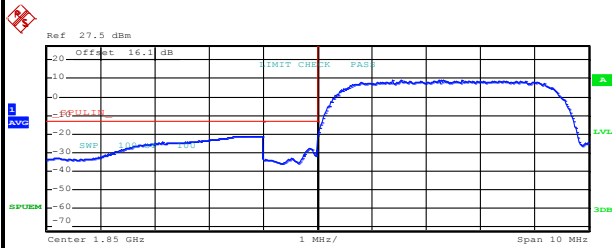

Start [Hz]	Stop [Hz]	RBW [Hz]	Freq [Hz]	PwrAbs [dBm]	ΔLimit [dB]
1.845 G	1.849 G	1.00 M	1.848600 G	-21.05	-8.05
1.849 G	1.850 G	50.00 k	1.849860 G	-27.92	-14.92
1.850 G	1.855 G	100.00 k	1.852240 G	9.19	-25.81

Date: 15.MAR.2017 09:28:42

Highest Band Edge

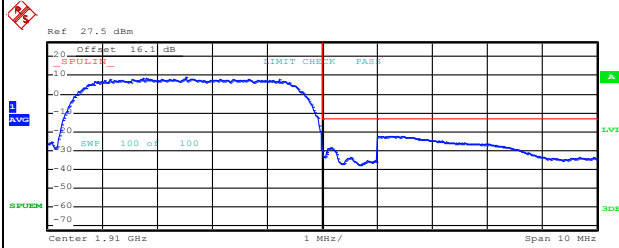

Start [Hz]	Stop [Hz]	RBW [Hz]	Freq [Hz]	PwrAbs [dBm]	ΔLimit [dB]
1.905 G	1.910 G	100.00 k	1.907520 G	9.06	-25.94
1.910 G	1.911 G	50.00 k	1.910164 G	-28.51	-15.51
1.911 G	1.915 G	1.00 M	1.911084 G	-22.37	-9.37

Date: 15.MAR.2017 09:31:23

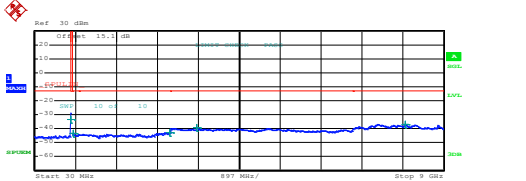
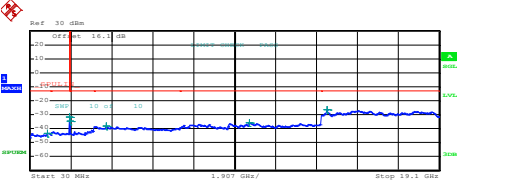
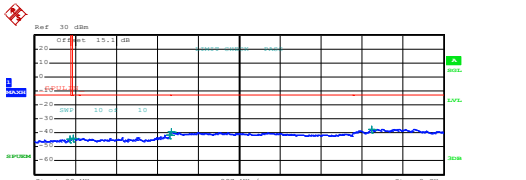
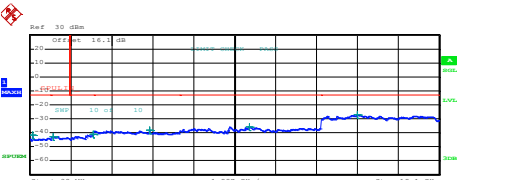
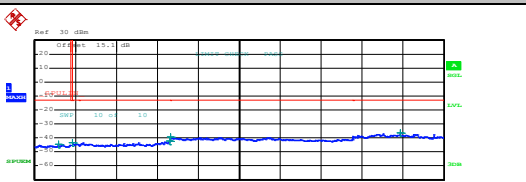
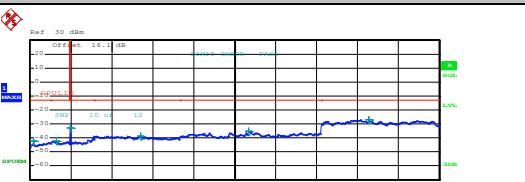

Conducted Spurious Emission

WCDMA Band V (RMC 12.2Kbps)	WCDMA Band II (RMC 12.2Kbps)																																																																																										
Lowest Channel	Lowest Channel																																																																																										
 <table border="1" data-bbox="239 660 702 739"> <thead> <tr> <th>Start</th> <th>Stop</th> <th>RBW</th> <th>Freq</th> <th>PwrAve</th> <th>ΔLimit</th> </tr> <tr> <th>[Hz]</th> <th>[Hz]</th> <th>[Hz]</th> <th>[Hz]</th> <th>[dBm]</th> <th>[dB]</th> </tr> </thead> <tbody> <tr> <td>30,000 M</td> <td>820,000 M</td> <td>1,000 M</td> <td>816,407500 M</td> <td>-33.63</td> <td>-20.63</td> </tr> <tr> <td>855,000 M</td> <td>1,000 G</td> <td>1,000 M</td> <td>871,530000 M</td> <td>-43.51</td> <td>-30.51</td> </tr> <tr> <td>1,000 G</td> <td>3,000 G</td> <td>1,000 M</td> <td>2,398000 G</td> <td>-42.53</td> <td>-29.53</td> </tr> <tr> <td>3,000 G</td> <td>7,000 G</td> <td>1,000 M</td> <td>3,586000 G</td> <td>-39.42</td> <td>-26.42</td> </tr> <tr> <td>7,000 G</td> <td>9,000 G</td> <td>1,000 M</td> <td>8,163000 G</td> <td>-36.69</td> <td>-23.69</td> </tr> </tbody> </table> <p>Date: 15.MAR.2017 09:54:15</p>	Start	Stop	RBW	Freq	PwrAve	ΔLimit	[Hz]	[Hz]	[Hz]	[Hz]	[dBm]	[dB]	30,000 M	820,000 M	1,000 M	816,407500 M	-33.63	-20.63	855,000 M	1,000 G	1,000 M	871,530000 M	-43.51	-30.51	1,000 G	3,000 G	1,000 M	2,398000 G	-42.53	-29.53	3,000 G	7,000 G	1,000 M	3,586000 G	-39.42	-26.42	7,000 G	9,000 G	1,000 M	8,163000 G	-36.69	-23.69	 <table border="1" data-bbox="893 660 1356 739"> <thead> <tr> <th>Start</th> <th>Stop</th> <th>RBW</th> <th>Freq</th> <th>PwrAve</th> <th>ΔLimit</th> </tr> <tr> <th>[Hz]</th> <th>[Hz]</th> <th>[Hz]</th> <th>[Hz]</th> <th>[dBm]</th> <th>[dB]</th> </tr> </thead> <tbody> <tr> <td>30,000 M</td> <td>1,000 G</td> <td>1,000 M</td> <td>845,770000 M</td> <td>-43.21</td> <td>-30.21</td> </tr> <tr> <td>1,000 G</td> <td>3,845 G</td> <td>1,000 M</td> <td>1,844578 G</td> <td>-31.53</td> <td>-18.53</td> </tr> <tr> <td>1,915 G</td> <td>3,000 G</td> <td>1,000 M</td> <td>1,925562 G</td> <td>-34.87</td> <td>-22.87</td> </tr> <tr> <td>3,000 G</td> <td>7,000 G</td> <td>1,000 M</td> <td>3,593000 G</td> <td>-38.38</td> <td>-25.38</td> </tr> <tr> <td>7,000 G</td> <td>13,600 G</td> <td>1,000 M</td> <td>10,248025 G</td> <td>-35.45</td> <td>-22.45</td> </tr> <tr> <td>13,600 G</td> <td>19,100 G</td> <td>1,000 M</td> <td>13,871563 G</td> <td>-26.72</td> <td>-13.72</td> </tr> </tbody> </table> <p>Date: 15.MAR.2017 09:34:55</p>	Start	Stop	RBW	Freq	PwrAve	ΔLimit	[Hz]	[Hz]	[Hz]	[Hz]	[dBm]	[dB]	30,000 M	1,000 G	1,000 M	845,770000 M	-43.21	-30.21	1,000 G	3,845 G	1,000 M	1,844578 G	-31.53	-18.53	1,915 G	3,000 G	1,000 M	1,925562 G	-34.87	-22.87	3,000 G	7,000 G	1,000 M	3,593000 G	-38.38	-25.38	7,000 G	13,600 G	1,000 M	10,248025 G	-35.45	-22.45	13,600 G	19,100 G	1,000 M	13,871563 G	-26.72	-13.72
Start	Stop	RBW	Freq	PwrAve	ΔLimit																																																																																						
[Hz]	[Hz]	[Hz]	[Hz]	[dBm]	[dB]																																																																																						
30,000 M	820,000 M	1,000 M	816,407500 M	-33.63	-20.63																																																																																						
855,000 M	1,000 G	1,000 M	871,530000 M	-43.51	-30.51																																																																																						
1,000 G	3,000 G	1,000 M	2,398000 G	-42.53	-29.53																																																																																						
3,000 G	7,000 G	1,000 M	3,586000 G	-39.42	-26.42																																																																																						
7,000 G	9,000 G	1,000 M	8,163000 G	-36.69	-23.69																																																																																						
Start	Stop	RBW	Freq	PwrAve	ΔLimit																																																																																						
[Hz]	[Hz]	[Hz]	[Hz]	[dBm]	[dB]																																																																																						
30,000 M	1,000 G	1,000 M	845,770000 M	-43.21	-30.21																																																																																						
1,000 G	3,845 G	1,000 M	1,844578 G	-31.53	-18.53																																																																																						
1,915 G	3,000 G	1,000 M	1,925562 G	-34.87	-22.87																																																																																						
3,000 G	7,000 G	1,000 M	3,593000 G	-38.38	-25.38																																																																																						
7,000 G	13,600 G	1,000 M	10,248025 G	-35.45	-22.45																																																																																						
13,600 G	19,100 G	1,000 M	13,871563 G	-26.72	-13.72																																																																																						
Middle Channel	Middle Channel																																																																																										
 <table border="1" data-bbox="239 1176 702 1254"> <thead> <tr> <th>Start</th> <th>Stop</th> <th>RBW</th> <th>Freq</th> <th>PwrAve</th> <th>ΔLimit</th> </tr> <tr> <th>[Hz]</th> <th>[Hz]</th> <th>[Hz]</th> <th>[Hz]</th> <th>[dBm]</th> <th>[dB]</th> </tr> </thead> <tbody> <tr> <td>30,000 M</td> <td>820,000 M</td> <td>1,000 M</td> <td>808,742500 M</td> <td>-44.57</td> <td>-31.57</td> </tr> <tr> <td>855,000 M</td> <td>1,000 G</td> <td>1,000 M</td> <td>867,297500 M</td> <td>-43.81</td> <td>-30.81</td> </tr> <tr> <td>1,000 G</td> <td>3,000 G</td> <td>1,000 M</td> <td>2,984500 G</td> <td>-41.72</td> <td>-28.72</td> </tr> <tr> <td>3,000 G</td> <td>7,000 G</td> <td>1,000 M</td> <td>3,020000 G</td> <td>-39.25</td> <td>-26.25</td> </tr> <tr> <td>7,000 G</td> <td>9,000 G</td> <td>1,000 M</td> <td>7,417000 G</td> <td>-37.38</td> <td>-24.38</td> </tr> </tbody> </table> <p>Date: 15.MAR.2017 09:55:06</p>	Start	Stop	RBW	Freq	PwrAve	ΔLimit	[Hz]	[Hz]	[Hz]	[Hz]	[dBm]	[dB]	30,000 M	820,000 M	1,000 M	808,742500 M	-44.57	-31.57	855,000 M	1,000 G	1,000 M	867,297500 M	-43.81	-30.81	1,000 G	3,000 G	1,000 M	2,984500 G	-41.72	-28.72	3,000 G	7,000 G	1,000 M	3,020000 G	-39.25	-26.25	7,000 G	9,000 G	1,000 M	7,417000 G	-37.38	-24.38	 <table border="1" data-bbox="893 1176 1356 1254"> <thead> <tr> <th>Start</th> <th>Stop</th> <th>RBW</th> <th>Freq</th> <th>PwrAve</th> <th>ΔLimit</th> </tr> <tr> <th>[Hz]</th> <th>[Hz]</th> <th>[Hz]</th> <th>[Hz]</th> <th>[dBm]</th> <th>[dB]</th> </tr> </thead> <tbody> <tr> <td>30,000 M</td> <td>1,000 G</td> <td>1,000 M</td> <td>140,822500 M</td> <td>-41.87</td> <td>-28.87</td> </tr> <tr> <td>1,000 G</td> <td>3,845 G</td> <td>1,000 M</td> <td>1,088289 G</td> <td>-42.87</td> <td>-29.87</td> </tr> <tr> <td>1,915 G</td> <td>3,000 G</td> <td>1,000 M</td> <td>2,957936 G</td> <td>-40.99</td> <td>-27.99</td> </tr> <tr> <td>3,000 G</td> <td>7,000 G</td> <td>1,000 M</td> <td>5,605000 G</td> <td>-38.25</td> <td>-25.25</td> </tr> <tr> <td>7,000 G</td> <td>13,600 G</td> <td>1,000 M</td> <td>10,239500 G</td> <td>-35.61</td> <td>-22.61</td> </tr> <tr> <td>13,600 G</td> <td>19,100 G</td> <td>1,000 M</td> <td>15,301562 G</td> <td>-27.15</td> <td>-14.15</td> </tr> </tbody> </table> <p>Date: 15.MAR.2017 09:35:46</p>	Start	Stop	RBW	Freq	PwrAve	ΔLimit	[Hz]	[Hz]	[Hz]	[Hz]	[dBm]	[dB]	30,000 M	1,000 G	1,000 M	140,822500 M	-41.87	-28.87	1,000 G	3,845 G	1,000 M	1,088289 G	-42.87	-29.87	1,915 G	3,000 G	1,000 M	2,957936 G	-40.99	-27.99	3,000 G	7,000 G	1,000 M	5,605000 G	-38.25	-25.25	7,000 G	13,600 G	1,000 M	10,239500 G	-35.61	-22.61	13,600 G	19,100 G	1,000 M	15,301562 G	-27.15	-14.15
Start	Stop	RBW	Freq	PwrAve	ΔLimit																																																																																						
[Hz]	[Hz]	[Hz]	[Hz]	[dBm]	[dB]																																																																																						
30,000 M	820,000 M	1,000 M	808,742500 M	-44.57	-31.57																																																																																						
855,000 M	1,000 G	1,000 M	867,297500 M	-43.81	-30.81																																																																																						
1,000 G	3,000 G	1,000 M	2,984500 G	-41.72	-28.72																																																																																						
3,000 G	7,000 G	1,000 M	3,020000 G	-39.25	-26.25																																																																																						
7,000 G	9,000 G	1,000 M	7,417000 G	-37.38	-24.38																																																																																						
Start	Stop	RBW	Freq	PwrAve	ΔLimit																																																																																						
[Hz]	[Hz]	[Hz]	[Hz]	[dBm]	[dB]																																																																																						
30,000 M	1,000 G	1,000 M	140,822500 M	-41.87	-28.87																																																																																						
1,000 G	3,845 G	1,000 M	1,088289 G	-42.87	-29.87																																																																																						
1,915 G	3,000 G	1,000 M	2,957936 G	-40.99	-27.99																																																																																						
3,000 G	7,000 G	1,000 M	5,605000 G	-38.25	-25.25																																																																																						
7,000 G	13,600 G	1,000 M	10,239500 G	-35.61	-22.61																																																																																						
13,600 G	19,100 G	1,000 M	15,301562 G	-27.15	-14.15																																																																																						
Highest Channel	Highest Channel																																																																																										
 <table border="1" data-bbox="239 1691 702 1769"> <thead> <tr> <th>Start</th> <th>Stop</th> <th>RBW</th> <th>Freq</th> <th>PwrAve</th> <th>ΔLimit</th> </tr> <tr> <th>[Hz]</th> <th>[Hz]</th> <th>[Hz]</th> <th>[Hz]</th> <th>[dBm]</th> <th>[dB]</th> </tr> </thead> <tbody> <tr> <td>30,000 M</td> <td>820,000 M</td> <td>1,000 M</td> <td>544,832500 M</td> <td>-46.64</td> <td>-33.64</td> </tr> <tr> <td>855,000 M</td> <td>1,000 G</td> <td>1,000 M</td> <td>855,108750 M</td> <td>-43.26</td> <td>-30.26</td> </tr> <tr> <td>1,000 G</td> <td>3,000 G</td> <td>1,000 M</td> <td>2,398000 G</td> <td>-42.14</td> <td>-29.14</td> </tr> <tr> <td>3,000 G</td> <td>7,000 G</td> <td>1,000 M</td> <td>3,003000 G</td> <td>-39.35</td> <td>-26.35</td> </tr> <tr> <td>7,000 G</td> <td>9,000 G</td> <td>1,000 M</td> <td>8,057500 G</td> <td>-36.49</td> <td>-23.49</td> </tr> </tbody> </table> <p>Date: 15.MAR.2017 09:56:02</p>	Start	Stop	RBW	Freq	PwrAve	ΔLimit	[Hz]	[Hz]	[Hz]	[Hz]	[dBm]	[dB]	30,000 M	820,000 M	1,000 M	544,832500 M	-46.64	-33.64	855,000 M	1,000 G	1,000 M	855,108750 M	-43.26	-30.26	1,000 G	3,000 G	1,000 M	2,398000 G	-42.14	-29.14	3,000 G	7,000 G	1,000 M	3,003000 G	-39.35	-26.35	7,000 G	9,000 G	1,000 M	8,057500 G	-36.49	-23.49	 <table border="1" data-bbox="893 1691 1356 1769"> <thead> <tr> <th>Start</th> <th>Stop</th> <th>RBW</th> <th>Freq</th> <th>PwrAve</th> <th>ΔLimit</th> </tr> <tr> <th>[Hz]</th> <th>[Hz]</th> <th>[Hz]</th> <th>[Hz]</th> <th>[dBm]</th> <th>[dB]</th> </tr> </thead> <tbody> <tr> <td>30,000 M</td> <td>1,000 G</td> <td>1,000 M</td> <td>170,105000 M</td> <td>-41.95</td> <td>-28.95</td> </tr> <tr> <td>1,000 G</td> <td>3,845 G</td> <td>1,000 M</td> <td>1,240391 G</td> <td>-42.50</td> <td>-29.50</td> </tr> <tr> <td>1,915 G</td> <td>3,000 G</td> <td>1,000 M</td> <td>1,932071 G</td> <td>-32.66</td> <td>-19.66</td> </tr> <tr> <td>3,000 G</td> <td>7,000 G</td> <td>1,000 M</td> <td>5,189000 G</td> <td>-38.57</td> <td>-25.57</td> </tr> <tr> <td>7,000 G</td> <td>13,600 G</td> <td>1,000 M</td> <td>10,230700 G</td> <td>-34.98</td> <td>-21.98</td> </tr> <tr> <td>13,600 G</td> <td>19,100 G</td> <td>1,000 M</td> <td>12,808938 G</td> <td>-27.21</td> <td>-14.21</td> </tr> </tbody> </table> <p>Date: 15.MAR.2017 09:36:38</p>	Start	Stop	RBW	Freq	PwrAve	ΔLimit	[Hz]	[Hz]	[Hz]	[Hz]	[dBm]	[dB]	30,000 M	1,000 G	1,000 M	170,105000 M	-41.95	-28.95	1,000 G	3,845 G	1,000 M	1,240391 G	-42.50	-29.50	1,915 G	3,000 G	1,000 M	1,932071 G	-32.66	-19.66	3,000 G	7,000 G	1,000 M	5,189000 G	-38.57	-25.57	7,000 G	13,600 G	1,000 M	10,230700 G	-34.98	-21.98	13,600 G	19,100 G	1,000 M	12,808938 G	-27.21	-14.21
Start	Stop	RBW	Freq	PwrAve	ΔLimit																																																																																						
[Hz]	[Hz]	[Hz]	[Hz]	[dBm]	[dB]																																																																																						
30,000 M	820,000 M	1,000 M	544,832500 M	-46.64	-33.64																																																																																						
855,000 M	1,000 G	1,000 M	855,108750 M	-43.26	-30.26																																																																																						
1,000 G	3,000 G	1,000 M	2,398000 G	-42.14	-29.14																																																																																						
3,000 G	7,000 G	1,000 M	3,003000 G	-39.35	-26.35																																																																																						
7,000 G	9,000 G	1,000 M	8,057500 G	-36.49	-23.49																																																																																						
Start	Stop	RBW	Freq	PwrAve	ΔLimit																																																																																						
[Hz]	[Hz]	[Hz]	[Hz]	[dBm]	[dB]																																																																																						
30,000 M	1,000 G	1,000 M	170,105000 M	-41.95	-28.95																																																																																						
1,000 G	3,845 G	1,000 M	1,240391 G	-42.50	-29.50																																																																																						
1,915 G	3,000 G	1,000 M	1,932071 G	-32.66	-19.66																																																																																						
3,000 G	7,000 G	1,000 M	5,189000 G	-38.57	-25.57																																																																																						
7,000 G	13,600 G	1,000 M	10,230700 G	-34.98	-21.98																																																																																						
13,600 G	19,100 G	1,000 M	12,808938 G	-27.21	-14.21																																																																																						



Frequency Stability

Test Conditions	Middle Channel	WCDMA Band V (RMC 12.2Kbps)	Limit 2.5ppm
Temperature (°C)	Voltage (Volt)	Deviation (ppm)	Result
50	Normal Voltage	0.0024	PASS
40	Normal Voltage	0.0000	
30	Normal Voltage	0.0012	
20(Ref.)	Normal Voltage	0.0000	
10	Normal Voltage	0.0048	
0	Normal Voltage	0.0000	
-10	Normal Voltage	0.0012	
-20	Normal Voltage	0.0024	
-30	Normal Voltage	0.0000	
20	Maximum Voltage	0.0012	
20	Normal Voltage	0.0000	
20	Battery End Point	0.0012	

Note:

- 1. Normal Voltage = 3.9V. ; Battery End Point (BEP) = 3.5 V. ; Maximum Voltage =4.3 V
- 2. The frequency fundamental emissions stay within the authorized frequency block.



Test Conditions	Middle Channel	WCDMA Band II (RMC 12.2Kbps)	Limit Note 2.
Temperature (°C)	Voltage (Volt)	Deviation (ppm)	Result
50	Normal Voltage	0.0021	PASS
40	Normal Voltage	0.0011	
30	Normal Voltage	0.0016	
20(Ref.)	Normal Voltage	0.0000	
10	Normal Voltage	0.0011	
0	Normal Voltage	0.0293	
-10	Normal Voltage	0.0293	
-20	Normal Voltage	0.0319	
-30	Normal Voltage	0.0309	
20	Maximum Voltage	0.0021	
20	Normal Voltage	0.0000	
20	Battery End Point	0.0011	

Note:

- 1. Normal Voltage = 3.9V. ; Battery End Point (BEP) = 3.5 V. ; Maximum Voltage =4.3 V
- 2. The frequency fundamental emissions stay within the authorized frequency block.



Appendix B. Test Results of ERP/EIRP and Radiated Test

ERP/EIRP

Channel	Mode	Horizontal		Vertical	
		ERP(dBm)	ERP(W)	ERP(dBm)	ERP(W)
Lowest	GSM850 GPRS class 8	17.83	0.0607	25.86	0.3855
Middle		16.77	0.0475	24.46	0.2793
Highest		16.78	0.0476	24.01	0.2518
Lowest	GSM850 EDGE class 8	12.37	0.0173	20.38	0.1091
Middle		11.96	0.0157	19.11	0.0815
Highest		12.10	0.0162	18.80	0.0759
Lowest	WCDMA Band V AMR 12.2Kbps	8.39	0.0069	16.17	0.0414
Middle		7.68	0.0059	15.42	0.0348
Highest		7.23	0.0053	14.51	0.0282
Limit	ERP < 7W	Result		PASS	

Channel	Mode	Horizontal		Vertical	
		EIRP(dBm)	EIRP(W)	EIRP(dBm)	EIRP(W)
Lowest	GSM1900 GSM	25.72	0.3733	27.47	0.5585
Middle		24.66	0.2924	26.19	0.4159
Highest		24.67	0.2931	26.35	0.4315
Lowest	GSM1900 EDGE class 8	22.06	0.1607	23.57	0.2275
Middle		21.03	0.1268	22.31	0.1702
Highest		20.38	0.1091	22.01	0.1589
Lowest	WCDMA Band II AMR 12.2Kbps	18.83	0.0764	20.51	0.1125
Middle		19.68	0.0929	21.08	0.1282
Highest		19.80	0.0955	21.35	0.1365
Limit	EIRP < 2W	Result		PASS	



Radiated Spurious Emission

Part22H GPRS 850

Mode 1_GPRS 850									
Channel	Frequency (MHz)	ERP (dBm)	Limit (dBm)	Over Limit (dB)	SPA Reading (dBm)	S.G. Power (dBm)	TX Cable loss (dB)	TX Antenna Gain (dBi)	Polarization (H/V)
Middle	1672	-48.95	-13	-35.95	-35.79	-50.63	0.99	4.82	H
	2512	-59.41	-13	-46.41	-50.05	-61.38	1.29	5.41	H
	3345	-68.40	-13	-55.40	-61.45	-72.01	1.56	7.32	H
									H
									H
									H
									H
	1672	-48.10	-13	-35.10	-35.04	-49.78	0.99	4.82	V
	2512	-57.05	-13	-44.05	-47.73	-59.02	1.29	5.41	V
	3344	-68.53	-13	-55.53	-61.33	-72.14	1.56	7.31	V
									V
									V
									V
									V

Remark: Spurious emissions within 30-1000MHz were found more than 20dB below limit line.

Part22H EDGE 850

Mode 2_EDGE 850									
Channel	Frequency (MHz)	ERP (dBm)	Limit (dBm)	Over Limit (dB)	SPA Reading (dBm)	S.G. Power (dBm)	TX Cable loss (dB)	TX Antenna Gain (dBi)	Polarization (H/V)
Middle	1672	-57.64	-13	-44.64	-44.48	-59.32	0.99	4.82	H
	2509	-69.42	-13	-56.42	-60.06	-71.38	1.29	5.41	H
	3345	-68.40	-13	-55.40	-61.45	-72.01	1.56	7.32	H
									H
									H
									H
									H
	1672	-54.86	-13	-41.86	-41.8	-56.54	0.99	4.82	V
	2509	-66.92	-13	-53.92	-57.6	-68.88	1.29	5.41	V
	3345	-68.42	-13	-55.42	-61.22	-72.03	1.56	7.32	V
									V
									V
									V
									V

Remark: Spurious emissions within 30-1000MHz were found more than 20dB below limit line.



Part22H WCDMA 850

Mode 3_WCDMA 850									
Channel	Frequency (MHz)	ERP (dBm)	Limit (dBm)	Over Limit (dB)	SPA Reading (dBm)	S.G. Power (dBm)	TX Cable loss (dB)	TX Antenna Gain (dBi)	Polarization (H/V)
Highest	1688	-68.18	-13	-55.18	-55.02	-69.81	1.00	4.77	H
	2539	-69.37	-13	-56.37	-60.13	-71.35	1.30	5.43	H
	3386	-68.41	-13	-55.41	-61.53	-72.19	1.57	7.50	H
									H
									H
									H
	1688	-66.54	-13	-53.54	-53.48	-68.17	1.00	4.77	V
	2539	-69.06	-13	-56.06	-59.85	-71.04	1.30	5.43	V
	3384	-68.73	-13	-55.73	-61.59	-72.50	1.57	7.49	V
									V
									V
									V
									V
									V

Remark: Spurious emissions within 30-1000MHz were found more than 20dB below limit line.

Part24E GSM 1900

Mode 1_GSM 1900									
Channel	Frequency (MHz)	EIRP (dBm)	Limit (dBm)	Over Limit (dB)	SPA Reading (dBm)	S.G. Power (dBm)	TX Cable loss (dB)	TX Antenna Gain (dBi)	Polarization (H/V)
Highest	3819	-60.83	-13	-47.83	-54.65	-67.51	1.70	8.38	H
	5729	-62.95	-13	-49.95	-63.9	-69.98	2.76	9.79	H
	7639	-58.95	-13	-45.95	-65.47	-68.45	2.38	11.88	H
									H
									H
									H
	3819	-61.12	-13	-48.12	-54.74	-67.80	1.70	8.38	V
	5729	-63.14	-13	-50.14	-64.02	-70.17	2.76	9.79	V
	7641	-58.58	-13	-45.58	-65.33	-68.08	2.38	11.88	V
									V
									V
									V
									V
									V

Remark: Spurious emissions within 30-1000MHz were found more than 20dB below limit line.



Part24E EDGE 1900

Mode 2_EDGE 1900									
Channel	Frequency (MHz)	EIRP (dBm)	Limit (dBm)	Over Limit (dB)	SPA Reading (dBm)	S.G. Power (dBm)	TX Cable loss (dB)	TX Antenna Gain (dBi)	Polarization (H/V)
Highest	3819	-64.61	-13	-51.61	-58.43	-71.29	1.70	8.38	H
	5729	-63.20	-13	-50.20	-64.15	-70.23	2.76	9.79	H
	7639	-58.90	-13	-45.90	-65.42	-68.40	2.38	11.88	H
									H
									H
									H
	3819	-65.70	-13	-52.70	-59.32	-72.38	1.70	8.38	V
	5729	-63.43	-13	-50.43	-64.31	-70.46	2.76	9.79	V
	7641	-58.63	-13	-45.63	-65.38	-68.13	2.38	11.88	V
									V
									V
									V
									V
									V

Remark: Spurious emissions within 30-1000MHz were found more than 20dB below limit line.

Part24E WCDMA 1900

Mode 3_WCDMA 1900									
Channel	Frequency (MHz)	EIRP (dBm)	Limit (dBm)	Over Limit (dB)	SPA Reading (dBm)	S.G. Power (dBm)	TX Cable loss (dB)	TX Antenna Gain (dBi)	Polarization (H/V)
Lowest	3704	-62.36	-13	-49.36	-56.02	-68.94	1.67	8.24	H
	5557	-63.00	-13	-50.00	-63.55	-70.06	2.66	9.72	H
	7409	-59.70	-13	-46.70	-65.68	-68.86	2.46	11.62	H
									H
									H
									H
	3704	-63.29	-13	-50.29	-56.7	-69.87	1.67	8.24	V
	5557	-63.61	-13	-50.61	-64.12	-70.67	2.66	9.72	V
	7409	-59.64	-13	-46.64	-65.92	-68.80	2.46	11.62	V
									V
									V
									V
									V
									V

Remark: Spurious emissions within 30-1000MHz were found more than 20dB below limit line.