

FCC TEST REPORT

For

Shanghai Rising Digital Co., Ltd.

Display screen

Model No.: SECD-510A-03, SECD-510A-03(S), SECD-510B-03,
SECD-510B-03(S), SECD-710A-03, SECD-710A-35

Prepared For : Shanghai Rising Digital Co., Ltd.
Address : No 318, Chuanda Road, Pudong New District, Shanghai China

Prepared By : Shenzhen Anbotek Compliance Laboratory Limited
Address : 1/F., Building 1, SEC Industrial Park, No.0409 Qianhai Road, Nanshan District, Shenzhen, Guangdong, China
Tel: (86) 755-26066544 Fax: (86) 755-26014772

Report Number : R0217050061W3
Date of Test : May. 19~Sept. 30, 2017
Date of Report : Sept. 30, 2017

Contents

1. General Information.....	5
1.1. Client Information.....	5
1.2. Description of Device (EUT).....	5
1.3. Auxiliary Equipment Used During Test.....	6
1.4. Description of Test Modes.....	6
1.5. Description Of Test Setup.....	7
1.6. Test Equipment List.....	9
1.8. Measurement Uncertainty.....	10
1.9. Description of Test Facility.....	10
2. Summary of Test.....	11
2.1. Summary of test result.....	11
3. RF Output Power Test.....	12
3.1. Test Standard and Limit.....	12
3.2. Test Setup.....	12
3.3. Test Procedure.....	12
3.4. Test Data.....	12
4. Peak-Average Ratio.....	35
4.1. Test Standard and Limit.....	35
4.2. Test Setup.....	35
4.3. Test Procedure.....	35
4.4. Test Data.....	35
5. Modulation Characteristic.....	43
6. Occupied Bandwidth.....	44
6.1. Test Standard and Limit.....	44
6.2. Test Setup.....	44
6.3. Test Procedure.....	44
6.4. Test Data.....	44
7. Spurious Emissions at Antenna Terminals.....	66
7.1. Test Standard and Limit.....	66
7.2. Test Setup.....	66
7.3. Test Procedure.....	66
7.4. Test Data.....	66
8. Spurious Radiated Emissions.....	71
8.1. Test Standard and Limit.....	71
8.2. Test Setup.....	71
8.3. Test Procedure.....	71
8.4. Test Data.....	72
9. Band Edge Compliance.....	76
9.1. Test Standard and Limit.....	76
9.2. Test Setup.....	76
9.3. Test Procedure.....	76
9.4. Test Data.....	76

10. Frequency Stability..... 101
 10.1. Test Standard and Limit..... 101
 10.2. Test Setup..... 101
 10.3. Test Procedure..... 101
 10.4. Test Data..... 101
APPENDIX I -- TEST SETUP PHOTOGRAPH..... 106
APPENDIX II -- PHOTOGRAPH..... 107

Anbotek

TEST REPORT

Applicant : Shanghai Rising Digital Co., Ltd.
Manufacturer : Shanghai Rising Digital Co., Ltd.
Product Name : Display screen
Model No. : SECD-510A-03, SECD-510A-03(S), SECD-510B-03, SECD-510B-03(S),
SECD-710A-03, SECD-710A-35
Trade Mark : 
Rating(s) : Input: DC 8-36V, 250mA
Output: DC 24V, 500mA

Test Standard(s) : FCC PART 2, FCC Part 22(H), FCC Part 24(E), FCC Part 27(H): 2016
Test Method(s) : ANSI/TIAC603 D: 2010

The device described above is tested by Shenzhen Anbotek Compliance Laboratory Limited to determine the maximum emission levels emanating from the device and the severe levels of the device can endure and its performance criterion. The measurement results are contained in this test report and Shenzhen Anbotek Compliance Laboratory Limited is assumed full of responsibility for the accuracy and completeness of these measurements. Also, this report shows that the EUT (Equipment Under Test) is technically compliant with the FCC Part 15 Subpart C requirements.

This report applies to above tested sample only and shall not be reproduced in part without written approval of Shenzhen Anbotek Compliance Laboratory Limited.

Date of Test : May. 19~Sept. 30, 2017

Prepared by :



Winkey Wang

(Tested Engineer / Winkey Wang)

Reviewer :

Tangcy. T.

(Project Manager / Tangcy. T)

Approved & Authorized Signer :

Tom Chen

(Manager / Tom Chen)

1. General Information

1.1. Client Information

Applicant	:	Shanghai Rising Digital Co., Ltd.
Address	:	No 318, Chuanda Road, Pudong New District, Shanghai China
Manufacturer	:	Shanghai Rising Digital Co., Ltd.
Address	:	No 318, Chuanda Road, Pudong New District, Shanghai China

1.2. Description of Device (EUT)

Product Name	:	Display screen
Model No.	:	SECD-510A-03, SECD-510A-03(S), SECD-510B-03, SECD-510B-03(S), SECD-710A-03, SECD-710A-35 (Note: All samples are the same except the model number and colour, so we prepare "SECD-510A-03" for test only.)
Trade Mark	:	 RISING
Test Power Supply	:	Input: DC 8-36V, 250mA Output: DC 24V, 500mA
Product Description	:	Operation Frequency: LTE Band 2 TX:1852.5~1907.5 MHz; RX:1932.5~1987.5 MHz LTE Band 4 TX: 1712.5~1752.5 MHz; RX: 2112.5~2152.5 MHz LTE Band 5 TX: 824 ~ 849 MHz; RX : 869 ~ 894 MHz LTE Band 17 TX: 706.5 ~ 713.5 MHz; RX : 736.5 ~ 743.5 MHz
	:	Modulation Type: QPSK/16QAM
	:	Antenna Type: PIFA Antenna
	:	Antenna Gain(Peak): 1 dBi
Remark: 1) For a more detailed features description, please refer to the manufacturer's specifications or the User's Manual. 2)This report is for LTE.		

1.3. Auxiliary Equipment Used During Test

N/A	:	N/A
-----	---	-----

1.4. Description of Test Modes

The following is the description of how the EUT is exercised during testing.

Test	Description Of Operation
Emissions Testing	The EUT was communicating with base station and set to work at maximum output power.
Others Testing	The EUT was communicating with base station and set to work at maximum output power.

Anbotek

1.5. Description Of Test Setup

1.5.1 Conducted Test Setup

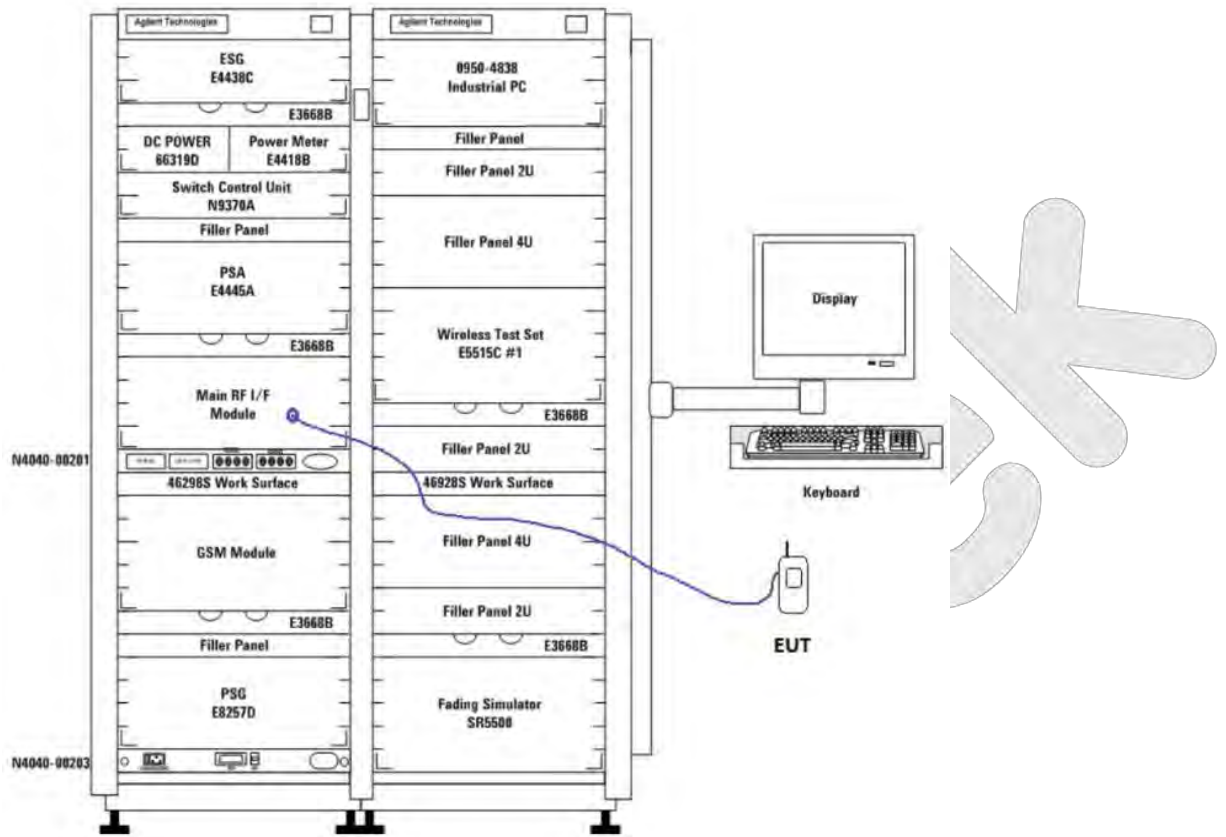

1.5.2 Radiated Test Setup

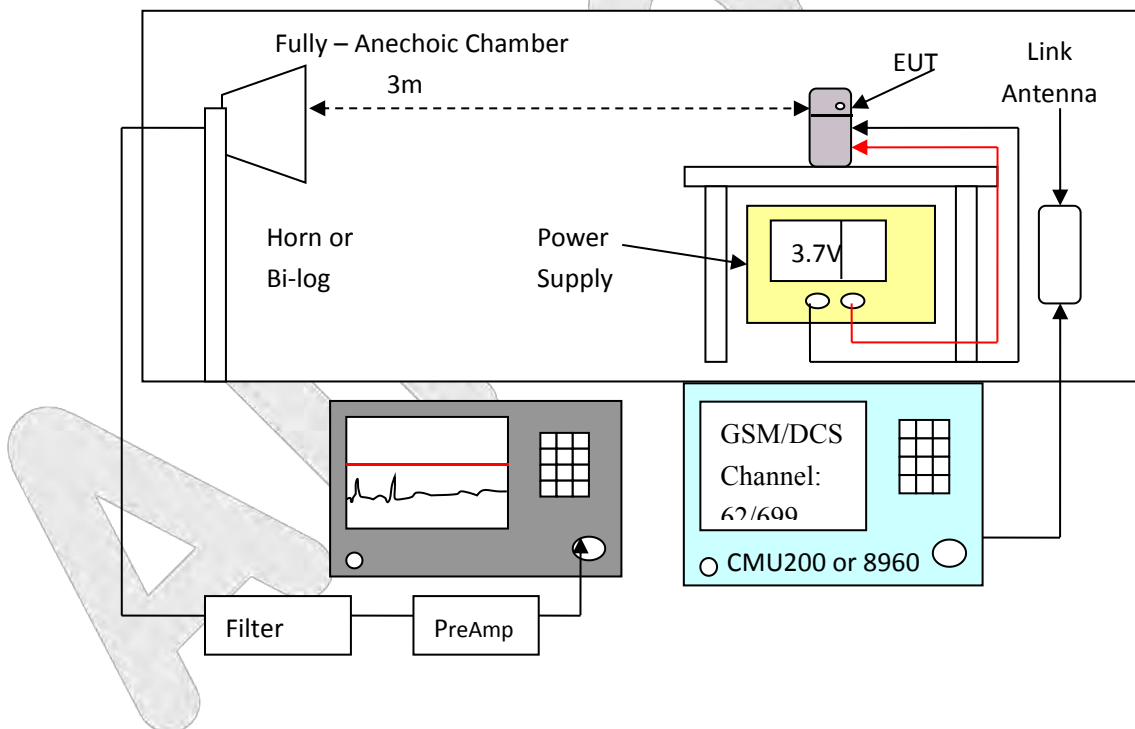
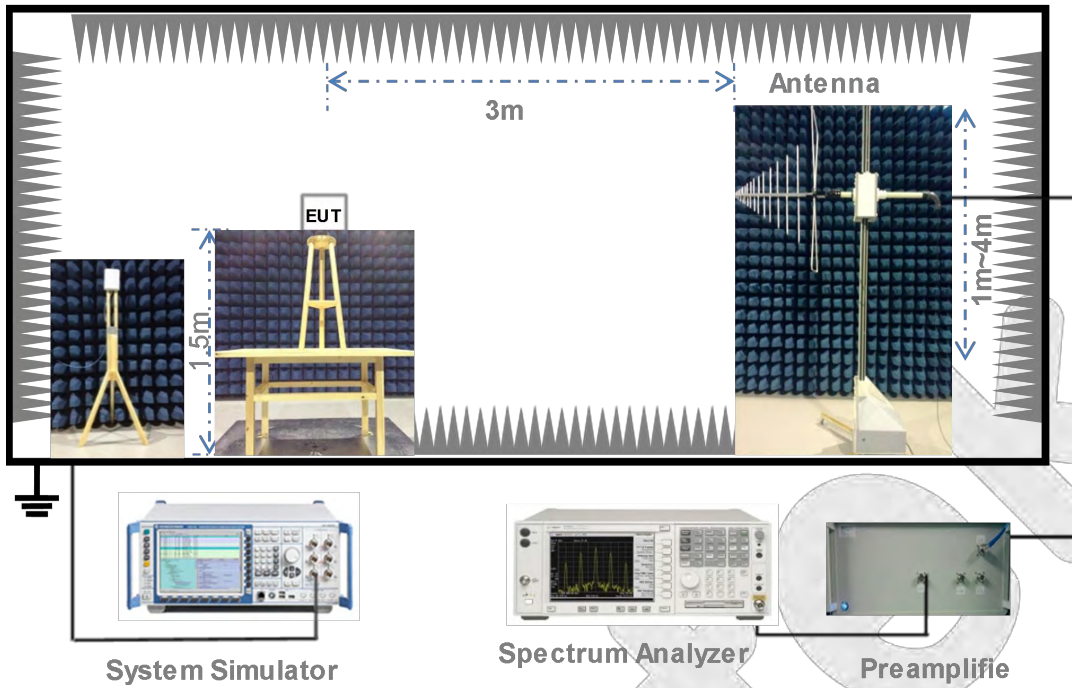

1.6. Test Equipment List

Item	Equipment	Manufacturer	Model No.	Serial No.	Last Cal.	Cal. Interval
1.	L.I.S.N. Artificial Mains Network	Rohde & Schwarz	ENV216	100055	May 27, 2017	1 Year
2.	EMI Test Receiver	Rohde & Schwarz	ESCI	100627	May 27, 2017	1 Year
3.	RF Switching Unit	Compliance Direction	RSU-M2	38303	May 27, 2017	1 Year
4.	Spectrum Analysis	Agilent	E4407B	US39390582	May 27, 2017	1 Year
5.	Preamplifier	SKET Electronic	BK1G18G30 D	KD17503	May 27, 2017	1 Year
6.	EMI Test Receiver	Rohde & Schwarz	ESPI	101604	May 27, 2017	1 Year
7.	Double Ridged Horn Antenna	Instruments corporation	GTH-0118	351600	May 31, 2017	1 Year
8.	Bilog Broadband Antenna	Schwarzbeck	VULB9163	VULB 9163-289	May 31, 2017	1 Year
9.	Loop Antenna	Schwarzbeck	HFH2-Z2	100047	Apr. 03, 2017	1 Year
10.	Pre-amplifier	SONOMA	310N	186860	May 27, 2017	1 Year
11.	EMI Test Software EZ-EMC	SHURPLE	N/A	N/A	N/A	N/A
12.	Power Sensor	DAER	RPR3006W	15100041SN045	May 27, 2017	1 Year
13.	Power Sensor	DAER	RPR3006W	15100041SN046	May 27, 2017	1 Year
14.	MXA Spectrum Analysis	Agilent	N9020A	MY51170037	May 27, 2017	1 Year
15.	MXG RF Vector Signal Generator	Agilent	N5182A	MY48180656	May 27, 2017	1 Year
16.	Signal Generator	Agilent	E4421B	MY41000743	May 27, 2017	1 Year
17.	DC Power supply	IVYTECH	IV6003	1601D6030007	May 26, 2017	1 Year
18.	TEMP&HUMI PROGRAMMABLE CHAMBER	Sertep	ZJ-HWHS80 B	ZJ-17042804	Mar. 03, 2017	1 Year

1.8. Measurement Uncertainty

Maximum measurement uncertainty

Parameter	Uncertainty
Occupied Channel Bandwidth	$\pm 5 \%$
RF output power, conducted	$\pm 1,5 \text{ dB}$
Power Spectral Density, conducted	$\pm 3 \text{ dB}$
Unwanted Emissions, conducted	$\pm 3 \text{ dB}$
All emissions, radiated	$\pm 6 \text{ dB}$
Temperature	$\pm 1 \text{ }^\circ \text{C}$
Humidity	$\pm 5 \%$
DC and low frequency voltages	$\pm 3 \%$
Time	$\pm 5 \%$
Duty Cycle	$\pm 5 \%$

1.9. Description of Test Facility

The test facility is recognized, certified, or accredited by the following organizations:

FCC-Registration No.: 184111

Shenzhen Anbotek Compliance Laboratory Limited, EMC Laboratory has been registered and fully described in a report filed with the (FCC) Federal Communications Commission. The acceptance letter from the FCC is maintained in our files. Registration No. 184111, July 31, 2017.

ISED-Registration No.: 8058A-1

Shenzhen Anbotek Compliance Laboratory Limited, EMC Laboratory has been registered and fully described in a report filed with the (ISED) Innovation, Science and Economic Development Canada. The acceptance letter from the ISED is maintained in our files. Registration 8058A-1, June 13, 2016.

Test Location

All Emissions tests were performed at

Shenzhen Anbotek Compliance Laboratory Limited.

at 1/F., Building 1, SEC Industrial Park, No.0409 Qianhai Road, Nanshan District, Shenzhen, Guangdong, China

2. Summary of Test

2.1. Summary of test result

The EUT has been tested according to the following specifications:

The tests documented in this report were performed in accordance with TIA-603-D, FCC CFR 47 Part 2, Part 22, Part 24, Part 27.

FCC Rules	Description of Test	Result
§ 2.1046; § 24.232(c); § 27.50(c.10); § 27.50(d.4)	RF Output Power	Compliance
§ 24.232 (d); § 27.50(d)	Peak-Average Ratio	Compliance
§ 2.1047	Modulation Characteristics	Compliance
§ 2.1049; § 24.238; § 27.53(a.5)	99% & -26 dB Occupied Bandwidth	Compliance
§ 2.1051; § 24.238(a); § 27.53(h)	Spurious Emissions at Antenna Terminal	Compliance
§ 2.1053; § 24.238(a); § 27.53(h)	Field Strength of Spurious Radiation	Compliance
§ 24.238(a); § 27.53(h)	Out of band emission, Band Edge	Compliance
§ 2.1055; § 24.235; § 27.5(h); § 27.54	Frequency stability vs. temperature Frequency stability vs. voltage	Compliance

Note: Testing was performed by configuring EUT to maximum output power status, the declared output power class for different

3. RF Output Power Test

3.1. Test Standard and Limit

Spec	Item	Requirement
§22.913 (a)	a)	ERP:38.45dBm
§24.232 (c)	b)	EIRP:33dBm
§ 27.50 (c)	c)	EIRP:30dBm

3.2. Test Setup

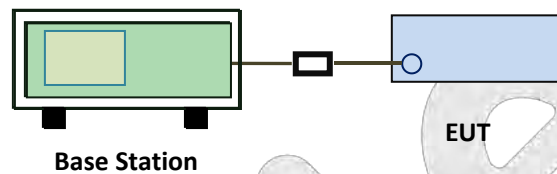

3.3. Test Procedure

For Conducted Power:

1. The transmitter output port was connected to base station.
Set EUT at maximum power through base station.
Select lowest, middle, and highest channels for each band and different test mode.

For ERP/EIRP:

2. The transmitter was placed on a wooden turntable, and it was transmitting into a non-radiating load which was also placed on the turntable.
3. The measurement antenna was placed at a distance of 3 meters from the EUT. During the tests, the antenna height and polarization as well as EUT azimuth were varied in order to identify the maximum level of emissions from the EUT. The test was performed by placing the EUT on 3-orthogonal axis.
4. The frequency range up to tenth harmonic of the fundamental frequency was investigated.
5. Remove the EUT and replace it with substitution antenna.
A signal generator was connected to the substitution antenna by a non-radiating cable. The absolute levels of the spurious emissions were measured by the substitution.
6. Spurious emissions in dB = $10 \log (\text{TX power in Watts}/0.001)$ – the absolute level
7. Spurious attenuation limit in dB = $43 + 10 \text{ Log}_{10} (\text{power out in Watts})$.

3.4. Test Data

Conducted Power:

LTE BAND 2

Channel Bandwidth: 1.4 MHz						
Modulation	Channel	RB Configuration		Peak Power(dBm)	Average Power [dBm]	Verdict
		Size	Offset			
QPSK	1850.7	1	0	26.06	21.03	PASS
		1	5	26.03	21.12	PASS
		3	3	27.07	22.14	PASS
		6	0	26.32	21.16	PASS
	1880.0	1	0	26.42	21.18	PASS
		1	5	26.27	22.31	PASS
		3	3	27.35	22.42	PASS
		6	0	26.09	22.21	PASS
	1909.3	1	0	26.03	21.63	PASS
		1	5	27.06	21.63	PASS
		3	3	26.18	21.64	PASS
		6	0	26.37	21.64	PASS
16QAM	1850.7	1	0	26.11	22.10	PASS
		1	5	26.18	21.60	PASS
		3	3	26.14	21.31	PASS
		6	0	25.47	21.25	PASS
	1880.0	1	0	26.53	21.63	PASS
		1	5	26.59	21.63	PASS
		3	3	26.13	21.65	PASS
		6	0	26.16	21.66	PASS
	1909.3	1	0	25.29	21.64	PASS
		1	5	26.43	21.62	PASS
		3	3	26.56	21.50	PASS
		6	0	25.43	21.62	PASS

Channel Bandwidth: 3 MHz						
Modulation	Channel	RB Configuration		Peak Power(dBm)	Average Power [dBm]	Verdict
		Size	Offset			
QPSK	1851.5	1	0	26.64	21.08	PASS
		1	14	26.72	22.03	PASS
		8	7	26.75	22.17	PASS
		15	0	26.71	22.16	PASS
	1880.0	1	0	26.76	21.15	PASS
		1	14	27.02	21.14	PASS

	1908.5	8	7	26.83	22.56	PASS
		15	0	26.94	22.64	PASS
		1	0	26.96	22.63	PASS
		1	14	26.91	21.66	PASS
		8	7	26.85	21.63	PASS
		15	0	27.33	21.62	PASS
16QAM	1851.5	1	0	26.82	21.65	PASS
		1	14	26.95	22.62	PASS
		8	7	26.81	22.68	PASS
		15	0	26.96	22.60	PASS
	1880.0	1	0	26.83	21.56	PASS
		1	14	27.22	21.62	PASS
		8	7	25.56	22.73	PASS
		15	0	25.62	22.72	PASS
	1908.5	1	0	25.65	22.60	PASS
		1	14	25.66	21.62	PASS
		8	7	25.62	21.61	PASS
		15	0	27.28	21.60	PASS

Channel Bandwidth: 5 MHz						
Modulation	Channel	RB Configuration		Peak Power(dBm)	Average Power [dBm]	Verdict
		Size	Offset			
QPSK	1852.5	1	0	26.96	21.60	PASS
		1	24	27.01	21.67	PASS
		12	13	27.15	22.74	PASS
		25	0	27.46	21.74	PASS
	1880.0	1	0	27.63	21.73	PASS
		1	24	27.66	21.72	PASS
		12	13	26.92	21.65	PASS
		25	0	27.05	22.61	PASS
	1907.5	1	0	27.12	22.73	PASS
		1	24	27.64	22.75	PASS
		12	13	27.61	21.72	PASS
		25	0	27.14	21.72	PASS
16QAM	1852.5	1	0	25.71	22.80	PASS
		1	24	25.62	22.72	PASS
		12	13	25.74	22.73	PASS
		25	0	26.25	21.76	PASS
	1880.0	1	0	26.01	21.68	PASS
		1	24	26.86	21.62	PASS
		12	13	25.73	21.64	PASS
		25	0	25.64	22.82	PASS

	1907.5	1	0	25.79	22.64	PASS
		1	24	26.26	22.63	PASS
		12	13	26.18	21.71	PASS
		25	0	26.92	21.71	PASS

Channel Bandwidth: 10 MHz						
Modulation	Channel	RB Configuration		Peak Power(dBm)	Average Power [dBm]	Verdict
		Size	Offset			
QPSK	1852.5	1	0	26.93	22.44	PASS
		1	49	27.14	21.65	PASS
		25	25	26.52	21.68	PASS
		50	0	27.53	21.73	PASS
	1880.0	1	0	26.81	21.74	PASS
		1	49	26.92	21.63	PASS
		25	25	26.95	21.72	PASS
		50	0	27.42	22.52	PASS
	1907.5	1	0	27.59	21.62	PASS
		1	49	27.75	21.69	PASS
		25	25	25.97	20.63	PASS
		50	0	25.63	20.73	PASS
16QAM	1852.5	1	0	25.65	20.33	PASS
		1	49	26.44	21.67	PASS
		25	25	26.16	21.69	PASS
		50	0	26.78	21.72	PASS
	1880.0	1	0	25.92	21.73	PASS
		1	49	25.61	20.65	PASS
		25	25	25.66	20.74	PASS
		50	0	26.48	21.30	PASS
	1907.5	1	0	26.16	21.74	PASS
		1	49	26.87	21.70	PASS
		25	25	26.93	22.44	PASS
		50	0	26.38	21.65	PASS

Channel Bandwidth: 15 MHz						
Modulation	Channel	RB Configuration		Peak Power(dBm)	Average Power [dBm]	Verdict
		Size	Offset			
QPSK	1857.5	1	0	26.75	20.51	PASS
		1	74	26.94	20.74	PASS
		37	38	27.01	20.58	PASS
		75	0	27.39	20.41	PASS
	1880.0	1	0	27.56	22.32	PASS
		1	74	26.28	22.24	PASS
		37	38	26.41	21.56	PASS
		75	0	25.76	21.57	PASS
	1902.5	1	0	25.62	22.58	PASS
		1	74	26.88	22.47	PASS
		37	38	26.24	21.47	PASS
		75	0	27.46	21.54	PASS
16QAM	1857.5	1	0	26.48	20.94	PASS
		1	74	25.74	20.23	PASS
		37	38	25.56	20.66	PASS
		75	0	26.77	20.50	PASS
	1880.0	1	0	26.27	21.47	PASS
		1	74	27.36	21.52	PASS
		37	38	26.75	20.54	PASS
		75	0	26.94	20.54	PASS
	1902.5	1	0	27.01	21.57	PASS
		1	74	27.39	21.39	PASS
		37	38	27.56	20.44	PASS
		75	0	26.28	20.46	PASS

Channel Bandwidth: 20 MHz						
Modulation	Channel	RB Configuration		Peak Power(dBm)	Average Power [dBm]	Verdict
		Size	Offset			
QPSK	1860.0	1	0	26.93	21.30	PASS
		1	99	26.05	21.32	PASS
		50	50	26.12	22.23	PASS
		100	0	26.48	22.26	PASS
	1880.0	1	0	26.67	21.54	PASS
		1	99	27.78	21.24	PASS
		50	50	27.05	21.30	PASS

	1900.0	100	0	26.04	21.83	PASS
		1	0	25.66	19.98	PASS
		1	99	27.04	22.36	PASS
		50	50	26.32	21.64	PASS
		100	0	27.01	21.65	PASS
16QAM	1860.0	1	0	26.95	21.72	PASS
		1	99	26.02	21.67	PASS
		50	50	25.66	20.52	PASS
		100	0	27.12	22.19	PASS
	1880.0	1	0	26.31	20.12	PASS
		1	99	27.43	21.61	PASS
		50	50	26.93	21.65	PASS
		100	0	27.05	22.63	PASS
	1900.0	1	0	27.12	21.30	PASS
		1	99	26.48	21.32	PASS
		50	50	26.67	21.23	PASS
		100	0	26.78	20.26	PASS

LTE BAND 4

Channel Bandwidth: 1.4 MHz						
Modulation	Channel	RB Configuration		Peak Power(dBm)	Average Power [dBm]	Verdict
		Size	Offset			
QPSK	1710.7	1	0	27.04	22.52	PASS
		1	5	27.02	22.53	PASS
		3	3	27.33	21.65	PASS
		6	0	27.37	21.65	PASS
	1732.5	1	0	27.62	21.64	PASS
		1	5	27.01	21.52	PASS
		3	3	27.02	22.61	PASS
		6	0	27.09	22.53	PASS
	1754.3	1	0	27.33	22.54	PASS
		1	5	27.42	21.76	PASS
		3	3	27.67	21.72	PASS
		6	0	26.91	22.53	PASS
16QAM	1710.7	1	0	26.82	22.54	PASS
		1	5	26.83	22.52	PASS
		3	3	27.39	21.65	PASS
		6	0	27.32	21.66	PASS
	1732.5	1	0	27.30	21.62	PASS
		1	5	26.82	21.52	PASS
		3	3	26.73	22.51	PASS
		6	0	26.88	22.56	PASS

	1754.3	1	0	27.37	22.52	PASS
		1	5	27.33	21.64	PASS
		3	3	27.39	22.52	PASS
		6	0	27.04	22.53	PASS

Channel Bandwidth: 3 MHz						
Modulation	Channel	RB Configuration		Peak Power(dBm)	Average Power [dBm]	Verdict
		Size	Offset			
QPSK	1711.5	1	0	26.87	21.54	PASS
		1	14	26.93	21.55	PASS
		8	7	26.98	21.64	PASS
		15	0	26.85	22.51	PASS
	1732.5	1	0	26.82	22.54	PASS
		1	14	27.81	22.42	PASS
		8	7	26.59	21.43	PASS
		15	0	26.95	21.43	PASS
	1753.5	1	0	26.82	22.44	PASS
		1	14	26.79	22.52	PASS
		8	7	26.83	22.53	PASS
		15	0	27.77	21.55	PASS
16QAM	1711.5	1	0	26.85	21.55	PASS
		1	14	26.73	21.52	PASS
		8	7	26.85	21.63	PASS
		15	0	26.64	22.43	PASS
	1732.5	1	0	26.83	22.52	PASS
		1	14	27.41	22.50	PASS
		8	7	26.92	21.52	PASS
		15	0	26.85	21.53	PASS
	1753.5	1	0	26.78	22.82	PASS
		1	14	26.87	22.70	PASS
		8	7	26.93	22.63	PASS
		15	0	26.98	21.65	PASS

Channel Bandwidth: 5 MHz						
Modulation	Channel	RB Configuration		Peak Power(dBm)	Average Power [dBm]	Verdict
		Size	Offset			
QPSK	1712.5	1	0	26.91	21.47	PASS
		1	24	26.82	20.68	PASS
		12	13	26.98	21.36	PASS
		25	0	27.03	20.26	PASS

	1732.5	1	0	27.08	21.78	PASS
		1	24	27.11	21.51	PASS
		12	13	26.93	21.77	PASS
		25	0	26.81	20.81	PASS
	1752.5	1	0	26.95	21.67	PASS
		1	24	27.52	21.49	PASS
		12	13	27.19	22.55	PASS
		25	0	27.14	20.59	PASS
16QAM	1712.5	1	0	27.12	21.86	PASS
		1	24	26.94	20.04	PASS
		12	13	26.97	21.61	PASS
		25	0	27.46	20.43	PASS
	1732.5	1	0	26.15	20.97	PASS
		1	24	27.02	21.02	PASS
		12	13	27.01	21.94	PASS
		25	0	26.93	21.80	PASS
	1752.5	1	0	26.98	20.50	PASS
		1	24	26.15	21.35	PASS
		12	13	27.10	20.53	PASS
		25	0	26.59	21.55	PASS

Channel Bandwidth: 10 MHz						
Modulation	Channel	RB Configuration		Peak Power(dBm)	Average Power [dBm]	Verdict
		Size	Offset			
QPSK	1715.0	1	0	26.93	21.56	PASS
		1	49	27.55	21.55	PASS
		25	25	27.68	21.57	PASS
		50	0	27.62	21.56	PASS
	1732.5	1	0	26.73	22.67	PASS
		1	49	26.65	22.45	PASS
		25	25	26.67	22.23	PASS
		50	0	27.24	21.53	PASS
	1750.0	1	0	27.28	21.52	PASS
		1	49	27.54	22.21	PASS
		25	25	26.76	22.22	PASS
		50	0	26.62	22.26	PASS
16QAM	1715.0	1	0	26.74	21.44	PASS
		1	49	27.23	21.44	PASS
		25	25	27.37	21.44	PASS
		50	0	27.53	21.43	PASS
	1732.5	1	0	26.96	22.22	PASS
		1	49	26.72	22.25	PASS
		25	25	26.67	22.23	PASS

		50	0	27.64	21.42	PASS
	1750.0	1	0	27.53	21.45	PASS
		1	49	27.68	22.52	PASS
		25	25	26.84	22.44	PASS
		50	0	26.77	22.02	PASS

Channel Bandwidth: 15 MHz						
Modulation	Channel	RB Configuration		Peak Power(dBm)	Average Power [dBm]	Verdict
		Size	Offset			
QPSK	1717.5	1	0	26.99	22.54	PASS
		1	74	26.76	22.47	PASS
		37	38	26.85	21.65	PASS
		75	0	27.32	21.59	PASS
	1732.5	1	0	27.45	22.46	PASS
		1	74	28.19	22.23	PASS
		37	38	26.94	22.54	PASS
		75	0	26.77	21.46	PASS
	1747.5	1	0	26.84	21.50	PASS
		1	74	27.47	21.54	PASS
		37	38	27.43	21.55	PASS
		75	0	27.16	22.47	PASS
16QAM	1717.5	1	0	26.93	22.32	PASS
		1	74	26.95	22.64	PASS
		37	38	26.73	21.57	PASS
		75	0	27.68	21.60	PASS
	1732.5	1	0	27.64	22.85	PASS
		1	74	27.27	22.73	PASS
		37	38	26.95	22.47	PASS
		75	0	26.92	21.92	PASS
	1747.5	1	0	26.75	21.88	PASS
		1	74	26.61	21.83	PASS
		37	38	26.65	21.78	PASS
		75	0	26.28	22.83	PASS

Channel Bandwidth: 20 MHz						
Modulation	Channel	RB Configuration		Peak Power(dBm)	Average Power [dBm]	Verdict
		Size	Offset			
QPSK	1720.0	1	0	27.16	21.58	PASS
		1	99	27.29	22.63	PASS
		50	50	27.27	22.54	PASS

16QAM	1732.5	100	0	27.66	22.57	PASS	
		1	0	27.69	21.59	PASS	
		1	99	27.74	21.55	PASS	
		50	50	27.20	22.92	PASS	
		100	0	27.14	22.63	PASS	
	1745.0	1	0	27.25	22.89	PASS	
		1	99	27.53	21.52	PASS	
		50	50	27.65	21.60	PASS	
		100	0	27.78	21.74	PASS	
	16QAM	1720.0	1	0	27.22	21.67	PASS
			1	99	27.18	22.53	PASS
			50	50	27.24	22.65	PASS
			100	0	27.55	22.52	PASS
		1732.5	1	0	27.67	21.51	PASS
			1	99	27.84	21.60	PASS
			50	50	27.18	22.85	PASS
100			0	27.22	22.82	PASS	
1745.0		1	0	27.18	22.83	PASS	
		1	99	27.63	21.87	PASS	
		50	50	27.74	21.90	PASS	
		100	0	26.27	21.97	PASS	

LTE BAND 5

Channel Bandwidth: 1.4 MHz						
Modulation	Channel	RB Configuration		Peak Power(dBm)	Average Power [dBm]	Verdict
		Size	Offset			
QPSK	824.7	1	0	26.80	22.41	PASS
		1	5	26.91	22.42	PASS
		3	3	27.09	21.64	PASS
		6	0	27.18	21.15	PASS
	836.5	1	0	27.43	22.41	PASS
		1	5	26.84	22.42	PASS
		3	3	26.79	22.36	PASS
		6	0	26.77	21.53	PASS
	848.3	1	0	27.08	21.54	PASS
		1	5	27.12	21.44	PASS
		3	3	27.37	21.51	PASS
		6	0	26.76	22.39	PASS

16QAM	824.7	1	0	26.77	22.44	PASS
		1	5	26.84	22.36	PASS
		3	3	27.08	21.52	PASS
		6	0	27.17	21.47	PASS
	836.5	1	0	27.42	22.69	PASS
		1	5	26.66	22.36	PASS
		3	3	26.57	22.48	PASS
		6	0	26.58	21.64	PASS
	848.3	1	0	27.14	21.15	PASS
		1	5	27.07	21.51	PASS
		3	3	27.05	21.66	PASS
		6	0	26.57	22.69	PASS

Channel Bandwidth: 3 MHz						
Modulation	Channel	RB Configuration		Peak Power(dBm)	Average Power [dBm]	Verdict
		Size	Offset			
QPSK	825.5	1	0	26.57	21.52	PASS
		1	14	26.64	22.39	PASS
		8	7	27.17	22.42	PASS
		15	0	26.62	22.26	PASS
	836.5	1	0	26.68	21.31	PASS
		1	14	26.73	21.31	PASS
		8	7	26.63	22.32	PASS
		15	0	26.57	22.26	PASS
	847.5	1	0	27.56	22.41	PASS
		1	14	26.34	21.43	PASS
		8	7	26.45	21.43	PASS
		15	0	26.57	21.17	PASS
16QAM	825.5	1	0	26.54	21.51	PASS
		1	14	26.58	22.31	PASS
		8	7	27.52	22.28	PASS
		15	0	26.19	22.38	PASS
	836.5	1	0	26.48	21.37	PASS
		1	14	26.15	21.41	PASS
		8	7	26.39	22.66	PASS
		15	0	26.58	22.58	PASS
	847.5	1	0	27.16	22.51	PASS
		1	14	26.67	21.53	PASS
		8	7	26.89	21.52	PASS
		15	0	26.53	21.52	PASS

Channel Bandwidth: 5 MHz						
Modulation	Channel	RB Configuration		Peak Power(dBm)	Average Power [dBm]	Verdict
		Size	Offset			
QPSK	826.5	1	0	26.73	22.31	PASS
		1	24	26.77	21.55	PASS
		12	13	26.84	21.54	PASS
		25	0	26.37	22.42	PASS
	836.5	1	0	26.45	22.18	PASS
		1	24	26.89	22.51	PASS
		12	13	26.66	21.49	PASS
		25	0	26.57	21.49	PASS
	846.5	1	0	26.73	21.44	PASS
		1	24	27.31	21.38	PASS
		12	13	27.27	22.41	PASS
		25	0	27.32	22.19	PASS
16QAM	826.5	1	0	26.68	22.54	PASS
		1	24	26.56	21.41	PASS
		12	13	26.59	21.39	PASS
		25	0	26.27	22.76	PASS
	836.5	1	0	27.23	22.31	PASS
		1	24	27.34	22.42	PASS
		12	13	26.87	21.64	PASS
		25	0	26.69	21.47	PASS
	846.5	1	0	26.72	21.31	PASS
		1	24	26.21	21.43	PASS
		12	13	27.07	22.77	PASS
		25	0	26.77	21.54	PASS

Channel Bandwidth: 10 MHz						
Modulation	Channel	RB Configuration		Peak Power(dBm)	Average Power [dBm]	Verdict
		Size	Offset			
QPSK	829.0	1	0	27.10	22.55	PASS
		1	49	27.37	22.33	PASS
		25	25	26.48	22.11	PASS
		50	0	27.11	21.41	PASS
	836.5	1	0	26.42	21.18	PASS
		1	49	26.99	22.09	PASS

	844	25	25	27.03	22.10	PASS
		50	0	27.29	22.14	PASS
		1	0	26.51	21.32	PASS
		1	49	26.37	21.32	PASS
		25	25	26.49	21.32	PASS
		50	0	26.98	21.31	PASS
16QAM	829.0	1	0	27.12	22.15	PASS
		1	49	27.28	22.13	PASS
		25	25	26.71	22.11	PASS
		50	0	26.47	21.32	PASS
	836.5	1	0	26.42	21.33	PASS
		1	49	27.39	21.87	PASS
		25	25	27.28	22.32	PASS
		50	0	27.43	21.18	PASS
	844	1	0	26.59	21.61	PASS
		1	49	26.52	21.56	PASS
		25	25	26.38	21.19	PASS
		50	0	26.48	21.11	PASS

LTE BAND 17

Channel Bandwidth: 5 MHz						
Modulation	Channel	RB Configuration		Peak Power(dBm)	Average Power [dBm]	Verdict
		Size	Offset			
QPSK	706.5	1	0	26.65	22.25	PASS
		1	24	26.67	21.56	PASS
		12	13	27.24	21.55	PASS
		25	0	27.28	21.57	PASS
	710.0	1	0	26.54	21.56	PASS
		1	24	26.76	22.67	PASS
		12	13	26.62	22.45	PASS
		25	0	26.74	22.23	PASS
	713.5	1	0	26.23	21.53	PASS
		1	24	27.11	21.52	PASS
		12	13	27.09	22.21	PASS
		25	0	26.96	22.22	PASS
16QAM	706.5	1	0	26.72	22.26	PASS
		1	24	26.67	21.44	PASS
		12	13	27.34	21.44	PASS
		25	0	27.53	21.44	PASS
	710.0	1	0	27.41	21.43	PASS
		1	24	26.84	22.22	PASS
		12	13	26.77	22.25	PASS

		25	0	26.63	22.23	PASS
	713.5	1	0	25.68	21.42	PASS
		1	24	26.56	21.45	PASS
		12	13	26.65	22.52	PASS
		25	0	26.67	22.44	PASS

Channel Bandwidth: 10 MHz						
Modulation	Channel	RB Configuration		Peak Power(dBm)	Average Power [dBm]	Verdict
		Size	Offset			
QPSK	709.0	1	0	26.95	22.47	PASS
		1	49	27.02	21.65	PASS
		25	25	26.95	21.59	PASS
		50	0	27.43	22.46	PASS
	710.0	1	0	27.46	22.23	PASS
		1	49	26.23	22.54	PASS
		25	25	26.99	21.46	PASS
		50	0	26.76	21.50	PASS
	711.0	1	0	26.85	21.54	PASS
		1	49	27.32	21.55	PASS
		25	25	27.45	22.47	PASS
		50	0	25.19	22.32	PASS
16QAM	709.0	1	0	26.94	22.64	PASS
		1	49	26.77	21.57	PASS
		25	25	26.84	21.60	PASS
		50	0	27.47	22.85	PASS
	710.0	1	0	27.43	22.73	PASS
		1	49	26.16	22.47	PASS
		25	25	26.93	21.92	PASS
		50	0	26.95	21.88	PASS
	711.0	1	0	26.73	21.83	PASS
		1	49	27.68	21.78	PASS
		25	25	27.64	22.83	PASS
		50	0	27.27	22.76	PASS

Radiated Output Power:

Radiated Power (E.I.R.P) for LTE BAND 2 (1.4MHZ BANDWIDTH)							
Mode	Frequency	Substituted Level (dBm)	Antenna Polarization	Antenna Gain (dBi)	Cable loss (dB)	Absolute Level (dBm)	Conclusion
QPSK	1850.7	15.00	Horizontal	8.13	0.96	22.17	Pass
	1850.7	14.94	Vertical	8.13	0.96	22.11	Pass
	1880.0	15.41	Horizontal	8.14	0.96	22.59	Pass
	1880.0	15.10	Vertical	8.14	0.96	22.28	Pass
	1909.3	15.03	Horizontal	8.14	0.96	22.21	Pass
	1909.3	15.09	Vertical	8.14	0.96	22.27	Pass
16QAM	1850.7	14.22	Horizontal	8.13	0.96	21.39	Pass
	1850.7	14.20	Vertical	8.13	0.96	21.37	Pass
	1880.0	14.45	Horizontal	8.14	0.96	21.63	Pass
	1880.0	14.42	Vertical	8.14	0.96	21.60	Pass
	1909.3	14.12	Horizontal	8.14	0.96	21.30	Pass
	1909.3	14.09	Vertical	8.14	0.96	21.27	Pass

Radiated Power (E.I.R.P) for LTE BAND 2 (3MHZ BANDWIDTH)							
Mode	Frequency	Substituted Level (dBm)	Antenna Polarization	Antenna Gain (dBi)	Cable loss (dB)	Absolute Level (dBm)	Conclusion
QPSK	1851.5	14.92	Horizontal	8.13	0.96	22.09	Pass
	1851.5	14.89	Vertical	8.13	0.96	22.06	Pass
	1880.0	15.02	Horizontal	8.14	0.96	22.20	Pass
	1880.0	14.26	Vertical	8.14	0.96	21.44	Pass
	1908.5	15.06	Horizontal	8.14	0.96	22.24	Pass
	1908.5	15.17	Vertical	8.14	0.96	22.35	Pass
16QAM	1851.5	14.17	Horizontal	8.13	0.96	21.34	Pass
	1851.5	14.12	Vertical	8.13	0.96	21.29	Pass
	1880.0	14.26	Horizontal	8.14	0.96	21.44	Pass
	1880.0	14.29	Vertical	8.14	0.96	21.47	Pass
	1908.5	14.26	Horizontal	8.14	0.96	21.44	Pass
	1908.5	14.19	Vertical	8.14	0.96	21.37	Pass

Radiated Power (E.I.R.P) for LTE BAND 2 (5MHZ BANDWIDTH)							
Mode	Frequency	Substituted Level (dBm)	Antenna Polarization	Antenna Gain (dBi)	Cable loss (dB)	Absolute Level (dBm)	Conclusion
QPSK	1852.5	15.08	Horizontal	8.13	0.96	22.25	Pass
	1852.5	15.02	Vertical	8.13	0.96	22.19	Pass
	1880.0	15.17	Horizontal	8.14	0.96	22.35	Pass
	1880.0	15.14	Vertical	8.14	0.96	22.32	Pass
	1907.5	15.20	Horizontal	8.14	0.96	22.38	Pass
	1907.5	15.34	Vertical	8.14	0.96	22.52	Pass
16QAM	1852.5	14.40	Horizontal	8.13	0.96	21.57	Pass
	1852.5	14.26	Vertical	8.13	0.96	21.43	Pass
	1880.0	14.41	Horizontal	8.14	0.96	21.59	Pass
	1880.0	14.48	Vertical	8.14	0.96	21.66	Pass
	1907.5	14.01	Horizontal	8.14	0.96	21.19	Pass
	1907.5	13.94	Vertical	8.14	0.96	21.12	Pass

Radiated Power (E.I.R.P) for LTE BAND 2 (10MHZ BANDWIDTH)							
Mode	Frequency	Substituted Level (dBm)	Antenna Polarization	Antenna Gain (dBi)	Cable loss (dB)	Absolute Level (dBm)	Conclusion
QPSK	1855.0	15.01	Horizontal	8.13	0.96	22.18	Pass
	1855.0	15.03	Vertical	8.13	0.96	22.20	Pass
	1880.0	15.06	Horizontal	8.14	0.96	22.24	Pass
	1880.0	15.07	Vertical	8.14	0.96	22.25	Pass
	1905.0	15.17	Horizontal	8.14	0.96	22.35	Pass
	1905.0	15.16	Vertical	8.14	0.96	22.34	Pass
16QAM	1855.0	14.26	Horizontal	8.13	0.96	21.43	Pass
	1855.0	14.15	Vertical	8.13	0.96	21.32	Pass
	1880.0	14.28	Horizontal	8.14	0.96	21.46	Pass
	1880.0	14.35	Vertical	8.14	0.96	21.53	Pass
	1905.0	14.31	Horizontal	8.14	0.96	21.49	Pass
	1905.0	14.25	Vertical	8.14	0.96	21.43	Pass

Radiated Power (E.I.R.P) for LTE BAND 2 (15MHZ BANDWIDTH)							
Mode	Frequency	Substituted Level (dBm)	Antenna Polarization	Antenna Gain (dBi)	Cable loss (dB)	Absolute Level (dBm)	Conclusion
QPSK	1857.5	13.34	Horizontal	8.13	0.96	20.51	Pass
	1857.5	13.57	Vertical	8.13	0.96	20.74	Pass
	1880.0	15.14	Horizontal	8.14	0.96	22.32	Pass
	1880.0	15.06	Vertical	8.14	0.96	22.24	Pass
	1902.5	15.40	Horizontal	8.14	0.96	22.58	Pass
	1902.5	15.29	Vertical	8.14	0.96	22.47	Pass
16QAM	1857.5	12.77	Horizontal	8.13	0.96	19.94	Pass
	1857.5	13.06	Vertical	8.13	0.96	20.23	Pass
	1880.0	14.29	Horizontal	8.14	0.96	21.47	Pass
	1880.0	14.34	Vertical	8.14	0.96	21.52	Pass
	1902.5	14.39	Horizontal	8.14	0.96	21.57	Pass
	1902.5	14.21	Vertical	8.14	0.96	21.39	Pass

Radiated Power (E.I.R.P) for LTE BAND 2 (20MHZ BANDWIDTH)							
Mode	Frequency	Substituted Level (dBm)	Antenna Polarization	Antenna Gain (dBi)	Cable loss (dB)	Absolute Level (dBm)	Conclusion
QPSK	1860.0	13.57	Horizontal	8.13	0.96	20.74	Pass
	1860.0	12.97	Vertical	8.13	0.96	20.14	Pass
	1880.0	15.32	Horizontal	8.14	0.96	22.50	Pass
	1880.0	15.19	Vertical	8.14	0.96	22.37	Pass
	1900.0	15.51	Horizontal	8.14	0.96	22.69	Pass
	1900.0	15.36	Vertical	8.14	0.96	22.54	Pass
16QAM	1860.0	12.85	Horizontal	8.13	0.96	20.02	Pass
	1860.0	13.29	Vertical	8.13	0.96	20.46	Pass
	1880.0	14.36	Horizontal	8.14	0.96	21.54	Pass
	1880.0	14.34	Vertical	8.14	0.96	21.52	Pass
	1900.0	14.66	Horizontal	8.14	0.96	21.84	Pass
	1900.0	14.36	Vertical	8.14	0.96	21.54	Pass

Radiated Power (E.I.R.P) for LTE BAND 4 (1.4MHZ BANDWIDTH)							
Mode	Frequency	Substituted Level (dBm)	Antenna Polarization	Antenna Gain (dBi)	Cable loss (dB)	Absolute Level (dBm)	Conclusion
QPSK	1710.7	14.72	Horizontal	8.03	0.91	21.84	Pass
	1710.7	14.61	Vertical	8.03	0.91	21.73	Pass
	1732.5	14.61	Horizontal	8.04	0.91	21.74	Pass
	1732.5	14.59	Vertical	8.04	0.91	21.72	Pass
	1754.3	14.33	Horizontal	8.04	0.91	21.46	Pass
	1754.3	14.31	Vertical	8.04	0.91	21.44	Pass
16QAM	1710.7	13.98	Horizontal	8.03	0.91	21.10	Pass
	1710.7	12.99	Vertical	8.03	0.91	20.11	Pass
	1732.5	15.82	Horizontal	8.04	0.91	22.95	Pass
	1732.5	15.83	Vertical	8.04	0.91	22.96	Pass
	1754.3	13.39	Horizontal	8.04	0.91	20.52	Pass
	1754.3	15.38	Vertical	8.04	0.91	22.51	Pass

Radiated Power (E.I.R.P) for LTE BAND 4 (3MHZ BANDWIDTH)							
Mode	Frequency	Substituted Level (dBm)	Antenna Polarization	Antenna Gain (dBi)	Cable loss (dB)	Absolute Level (dBm)	Conclusion
QPSK	1711.5	13.60	Horizontal	8.03	0.91	20.72	Pass
	1711.5	14.58	Vertical	8.03	0.91	21.70	Pass
	1732.5	14.50	Horizontal	8.04	0.91	21.63	Pass
	1732.5	14.51	Vertical	8.04	0.91	21.64	Pass
	1753.5	14.41	Horizontal	8.04	0.91	21.54	Pass
	1753.5	14.29	Vertical	8.04	0.91	21.42	Pass
16QAM	1711.5	14.90	Horizontal	8.03	0.91	22.02	Pass
	1711.5	15.01	Vertical	8.03	0.91	22.13	Pass
	1732.5	13.69	Horizontal	8.04	0.91	20.82	Pass
	1732.5	16.72	Vertical	8.04	0.91	23.85	Pass
	1753.5	15.56	Horizontal	8.04	0.91	22.69	Pass
	1753.5	13.45	Vertical	8.04	0.91	20.58	Pass

Radiated Power (E.I.R.P) for LTE BAND 4 (5MHZ BANDWIDTH)							
Mode	Frequency	Substituted Level (dBm)	Antenna Polarization	Antenna Gain (dBi)	Cable loss (dB)	Absolute Level (dBm)	Conclusion
QPSK	1712.5	14.35	Horizontal	8.03	0.91	21.47	Pass
	1712.5	13.56	Vertical	8.03	0.91	20.68	Pass
	1732.5	14.65	Horizontal	8.04	0.91	21.78	Pass
	1732.5	14.38	Vertical	8.04	0.91	21.51	Pass
	1752.5	14.54	Horizontal	8.04	0.91	21.67	Pass
	1752.5	14.36	Vertical	8.04	0.91	21.49	Pass
16QAM	1712.5	14.74	Horizontal	8.03	0.91	21.86	Pass
	1712.5	12.92	Vertical	8.03	0.91	20.04	Pass
	1732.5	13.84	Horizontal	8.04	0.91	20.97	Pass
	1732.5	13.89	Vertical	8.04	0.91	21.02	Pass
	1752.5	13.37	Horizontal	8.04	0.91	20.50	Pass
	1752.5	14.22	Vertical	8.04	0.91	21.35	Pass

Radiated Power (E.I.R.P) for LTE BAND 4 (10MHZ BANDWIDTH)							
Mode	Frequency	Substituted Level (dBm)	Antenna Polarization	Antenna Gain (dBi)	Cable loss (dB)	Absolute Level (dBm)	Conclusion
QPSK	1715.0	14.08	Horizontal	8.03	0.91	21.20	Pass
	1715.0	13.43	Vertical	8.03	0.91	20.55	Pass
	1732.5	14.56	Horizontal	8.04	0.91	21.69	Pass
	1732.5	13.48	Vertical	8.04	0.91	20.61	Pass
	1750.0	13.31	Horizontal	8.04	0.91	20.44	Pass
	1750.0	13.87	Vertical	8.04	0.91	21.00	Pass
16QAM	1715.0	14.43	Horizontal	8.03	0.91	21.55	Pass
	1715.0	13.88	Vertical	8.03	0.91	21.00	Pass
	1732.5	14.71	Horizontal	8.04	0.91	21.84	Pass
	1732.5	14.92	Vertical	8.04	0.91	22.05	Pass
	1750.0	13.76	Horizontal	8.04	0.91	20.89	Pass
	1750.0	14.39	Vertical	8.04	0.91	21.52	Pass

Radiated Power (E.I.R.P) for LTE BAND 4 (15MHZ BANDWIDTH)							
Mode	Frequency	Substituted Level (dBm)	Antenna Polarization	Antenna Gain (dBi)	Cable loss (dB)	Absolute Level (dBm)	Conclusion
QPSK	1717.5	14.26	Horizontal	8.03	0.91	21.38	Pass
	1717.5	14.49	Vertical	8.03	0.91	21.61	Pass
	1732.5	14.60	Horizontal	8.04	0.91	21.73	Pass
	1732.5	14.11	Vertical	8.04	0.91	21.24	Pass
	1747.5	15.13	Horizontal	8.04	0.91	22.26	Pass
	1747.5	15.07	Vertical	8.04	0.91	22.20	Pass
16QAM	1717.5	13.99	Horizontal	8.03	0.91	21.11	Pass
	1717.5	15.93	Vertical	8.03	0.91	23.05	Pass
	1732.5	13.71	Horizontal	8.04	0.91	20.84	Pass
	1732.5	14.54	Vertical	8.04	0.91	21.67	Pass
	1747.5	14.45	Horizontal	8.04	0.91	21.58	Pass
	1747.5	15.49	Vertical	8.04	0.91	22.62	Pass

Radiated Power (E.I.R.P) for LTE BAND 4 (20MHZ BANDWIDTH)							
Mode	Frequency	Substituted Level (dBm)	Antenna Polarization	Antenna Gain (dBi)	Cable loss (dB)	Absolute Level (dBm)	Conclusion
QPSK	1720.0	15.40	Horizontal	8.03	0.91	22.52	Pass
	1720.0	15.07	Vertical	8.03	0.91	22.19	Pass
	1732.5	14.40	Horizontal	8.04	0.91	21.53	Pass
	1732.5	13.67	Vertical	8.04	0.91	20.80	Pass
	1745.0	15.40	Horizontal	8.04	0.91	22.53	Pass
	1745.0	16.58	Vertical	8.04	0.91	23.71	Pass
16QAM	1720.0	14.59	Horizontal	8.03	0.91	21.71	Pass
	1720.0	15.33	Vertical	8.03	0.91	22.45	Pass
	1732.5	14.70	Horizontal	8.04	0.91	21.83	Pass
	1732.5	12.90	Vertical	8.04	0.91	20.03	Pass
	1745.0	14.79	Horizontal	8.04	0.91	21.92	Pass
	1745.0	14.03	Vertical	8.04	0.91	21.16	Pass

Radiated Power (E.R.P) for LTE BAND 5 (1.4MHZ BANDWIDTH)							
Mode	Frequency	Substituted Level (dBm)	Antenna Polarization	Antenna Gain (dBi)	Cable loss (dB)	Absolute Level (dBm)	Conclusion
QPSK	824.7	15.50	Horizontal	6.4	0.52	21.38	Pass
	824.7	16.35	Vertical	6.4	0.52	22.23	Pass
	836.5	17.89	Horizontal	6.4	0.52	23.77	Pass
	836.5	16.51	Vertical	6.4	0.52	22.39	Pass
	848.3	16.66	Horizontal	6.5	0.52	22.64	Pass
	848.3	15.40	Vertical	6.5	0.52	21.38	Pass
16QAM	824.7	16.74	Horizontal	6.4	0.52	22.62	Pass
	824.7	15.65	Vertical	6.4	0.52	21.53	Pass
	836.5	17.09	Horizontal	6.4	0.52	22.97	Pass
	836.5	15.96	Vertical	6.4	0.52	21.84	Pass
	848.3	16.88	Horizontal	6.5	0.52	22.86	Pass
	848.3	16.75	Vertical	6.5	0.52	22.73	Pass

Radiated Power (E.R.P) for LTE BAND 5 (3MHZ BANDWIDTH)							
Mode	Frequency	Substituted Level (dBm)	Antenna Polarization	Antenna Gain (dBi)	Cable loss (dB)	Absolute Level (dBm)	Conclusion
QPSK	825.5	15.69	Horizontal	6.4	0.52	21.57	Pass
	825.5	15.43	Vertical	6.4	0.52	21.31	Pass
	836.5	16.79	Horizontal	6.4	0.52	22.67	Pass
	836.5	16.49	Vertical	6.4	0.52	22.37	Pass
	847.5	15.04	Horizontal	6.5	0.52	21.02	Pass
	847.5	14.53	Vertical	6.5	0.52	20.51	Pass
16QAM	825.5	16.04	Horizontal	6.4	0.52	21.92	Pass
	825.5	15.78	Vertical	6.4	0.52	21.66	Pass
	836.5	16.98	Horizontal	6.4	0.52	22.86	Pass
	836.5	15.92	Vertical	6.4	0.52	21.80	Pass
	847.5	15.39	Horizontal	6.5	0.52	21.37	Pass
	847.5	14.97	Vertical	6.5	0.52	20.95	Pass

Radiated Power (E.R.P) for LTE BAND 5 (5MHZ BANDWIDTH)							
Mode	Frequency	Substituted Level (dBm)	Antenna Polarization	Antenna Gain (dBi)	Cable loss (dB)	Absolute Level (dBm)	Conclusion
QPSK	826.5	15.76	Horizontal	6.4	0.52	21.64	Pass
	826.5	15.45	Vertical	6.4	0.52	21.33	Pass
	836.5	15.83	Horizontal	6.4	0.52	21.71	Pass
	836.5	15.45	Vertical	6.4	0.52	21.33	Pass
	846.5	15.33	Horizontal	6.5	0.52	21.31	Pass
	846.5	15.57	Vertical	6.5	0.52	21.55	Pass
16QAM	826.5	16.12	Horizontal	6.4	0.52	22.00	Pass
	826.5	15.87	Vertical	6.4	0.52	21.75	Pass
	836.5	16.17	Horizontal	6.4	0.52	22.05	Pass
	836.5	15.93	Vertical	6.4	0.52	21.81	Pass
	846.5	15.34	Horizontal	6.5	0.52	21.32	Pass
	846.5	15.64	Vertical	6.5	0.52	21.62	Pass

Radiated Power (E.R.P) for LTE BAND 5 (10MHZ BANDWIDTH)							
Mode	Frequency	Substituted Level (dBm)	Antenna Polarization	Antenna Gain (dBi)	Cable loss (dB)	Absolute Level (dBm)	Conclusion
QPSK	829.0	16.63	Horizontal	6.4	0.52	22.51	Pass
	829.0	15.44	Vertical	6.4	0.52	21.32	Pass
	836.5	15.55	Horizontal	6.4	0.52	21.43	Pass
	836.5	15.57	Vertical	6.4	0.52	21.45	Pass
	844.0	15.35	Horizontal	6.5	0.52	21.33	Pass
	844.0	16.13	Vertical	6.5	0.52	22.11	Pass
16QAM	829.0	16.21	Horizontal	6.4	0.52	22.09	Pass
	829.0	16.22	Vertical	6.4	0.52	22.10	Pass
	836.5	16.44	Horizontal	6.4	0.52	22.32	Pass
	836.5	14.44	Vertical	6.4	0.52	20.32	Pass
	844.0	15.15	Horizontal	6.5	0.52	21.13	Pass
	844.0	15.13	Vertical	6.5	0.52	21.11	Pass

Radiated Power (E.R.P) for LTE BAND 17 (5MHZ BANDWIDTH)							
Mode	Frequency	Substituted Level (dBm)	Antenna Polarization	Antenna Gain (dBi)	Cable loss (dB)	Absolute Level (dBm)	Conclusion
QPSK	706.5	16.19	Horizontal	6.1	0.49	21.80	Pass
	706.5	15.80	Vertical	6.1	0.49	21.41	Pass
	710.0	17.21	Horizontal	6.1	0.49	22.82	Pass
	710.0	15.55	Vertical	6.1	0.49	21.16	Pass
	713.5	15.86	Horizontal	6.1	0.49	21.47	Pass
	713.5	17.00	Vertical	6.1	0.49	22.61	Pass
16QAM	706.5	15.58	Horizontal	6.1	0.49	21.19	Pass
	706.5	15.20	Vertical	6.1	0.49	20.81	Pass
	710.0	17.20	Horizontal	6.1	0.49	22.81	Pass
	710.0	15.56	Vertical	6.1	0.49	21.17	Pass
	713.5	15.96	Horizontal	6.1	0.49	21.57	Pass
	713.5	16.19	Vertical	6.1	0.49	21.80	Pass

Radiated Power (E.R.P) for LTE BAND 17 (10MHZ BANDWIDTH)							
Mode	Frequency	Substituted Level (dBm)	Antenna Polarization	Antenna Gain (dBi)	Cable loss (dB)	Absolute Level (dBm)	Conclusion
QPSK	709.0	15.93	Horizontal	6.1	0.49	21.54	Pass
	709.0	15.85	Vertical	6.1	0.49	21.46	Pass
	710.0	15.88	Horizontal	6.1	0.49	21.49	Pass
	710.0	15.83	Vertical	6.1	0.49	21.44	Pass
	711.0	14.81	Horizontal	6.1	0.49	20.42	Pass
	711.0	15.86	Vertical	6.1	0.49	21.47	Pass
16QAM	709.0	17.11	Horizontal	6.1	0.49	22.72	Pass
	709.0	15.73	Vertical	6.1	0.49	21.34	Pass
	710.0	16.89	Horizontal	6.1	0.49	22.50	Pass
	710.0	15.14	Vertical	6.1	0.49	20.75	Pass
	711.0	14.82	Horizontal	6.1	0.49	20.43	Pass
	711.0	15.96	Vertical	6.1	0.49	21.57	Pass

4. Peak-Average Ratio

4.1. Test Standard and Limit

In measuring transmissions in this band using an average power technique, the peak-to-average ratio (PAR) of the transmission may not exceed 13 dB.

4.2. Test Setup

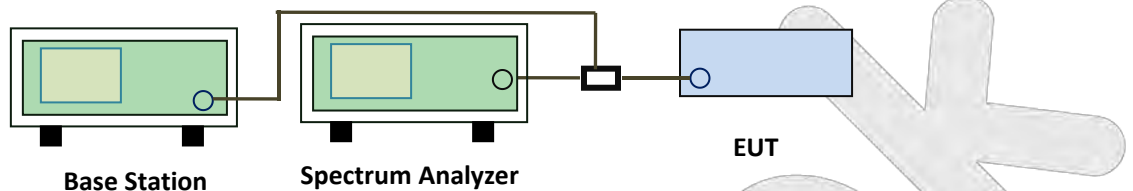

4.3. Test Procedure

According with KDB 971168

1. The signal analyzer's CCDF measurement profile is enabled
2. Frequency = carrier center frequency
3. Measurement BW > Emission bandwidth of signal
4. The signal analyzer was set to collect one million samples to generate the CCDF curve
5. The measurement interval was set depending on the type of signal analyzed. For continuous signals (>98% duty cycle), the measurement interval was set to 1ms. For burst transmissions, the spectrum analyzer is set to use an internal "RF Burst" trigger that is synced with an incoming pulse and the measurement interval is set to less than the duration of the "on time" of one burst to ensure that energy is only captured during a time in which the transmitter is operating at maximum power

4.4. Test Data

BAND	CHANNEL	Frequency [MHz]	BANDWIDTH	NO. RB	RB POS.	MODULATIO N	PAR [dB]
2	18900	1880.0	1.4	1	Low	QPSK	4.18
2	18900	1880.0	1.4	1	Low	16QAM	5.05
2	18900	1880.0	3.0	1	Low	QPSK	4.35
2	18900	1880.0	3.0	1	Low	16QAM	5.11
2	18900	1880.0	5.0	1	Low	QPSK	4.42
2	18900	1880.0	5.0	1	Low	16QAM	5.14
2	18900	1880.0	10.0	1	Low	QPSK	4.49
2	18900	1880.0	10.0	1	Low	16QAM	5.21
2	18900	1880.0	15.0	1	Low	QPSK	4.63
2	18900	1880.0	15.0	1	Low	16QAM	5.47
2	18900	1880.0	20.0	1	Low	QPSK	4.63
2	18900	1880.0	20.0	1	Low	16QAM	5.50
4	20175	1732.5	1.4	1	Low	QPSK	2.93
4	20175	1732.5	1.4	1	Low	16QAM	3.90
4	20175	1732.5	3.0	1	Low	QPSK	3.08
4	20175	1732.5	3.0	1	Low	16QAM	3.85
4	20175	1732.5	5.0	1	Low	QPSK	2.95
4	20175	1732.5	5.0	1	Low	16QAM	3.80
4	20175	1732.5	10.0	1	Low	QPSK	3.92
4	20175	1732.5	10.0	1	Low	16QAM	3.77
4	20175	1732.5	15.0	1	Low	QPSK	2.70
4	20175	1732.5	15.0	1	Low	16QAM	3.68
4	20175	1732.5	20.0	1	Low	QPSK	4.69
4	20175	1732.5	20.0	1	Low	16QAM	3.24
5	20525	836.5	1.4	1	Low	QPSK	3.43
5	20525	836.5	1.4	1	Low	16QAM	4.35
5	20525	836.5	3.0	1	Low	QPSK	3.52
5	20525	836.5	3.0	1	Low	16QAM	4.50
5	20525	836.5	5.0	1	Low	QPSK	3.49
5	20525	836.5	5.0	1	Low	16QAM	4.55
5	20525	836.5	10.0	1	Low	QPSK	3.72
5	20525	836.5	10.0	1	Low	16QAM	4.28
17	23790	710.0	5.0	1	Low	QPSK	4.98
17	23790	710.0	5.0	1	Low	16QAM	5.86
17	23790	710.0	10.0	1	Low	QPSK	4.93
17	23790	710.0	10.0	1	Low	16QAM	4.14

Test Plots

Band 2(Channel Bandwidth: 1.4 MHz)-QPSK

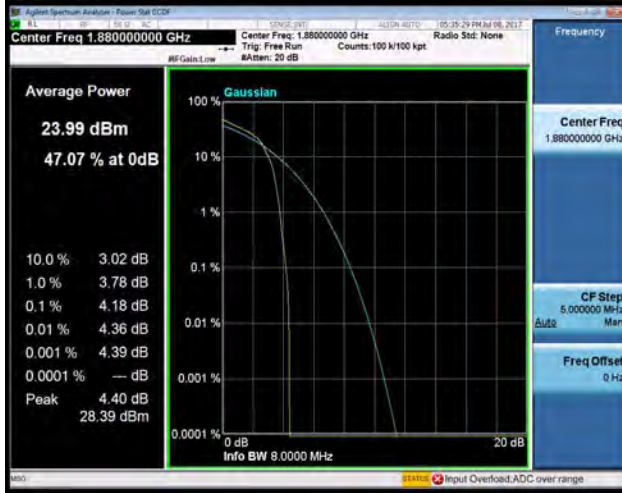

Band 4(Channel Bandwidth: 1.4 MHz)-QPSK

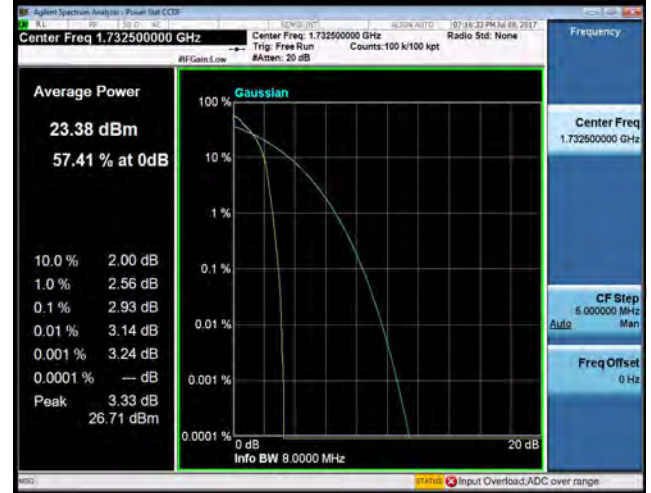

Band 2(Channel Bandwidth: 1.4 MHz)-16QAM

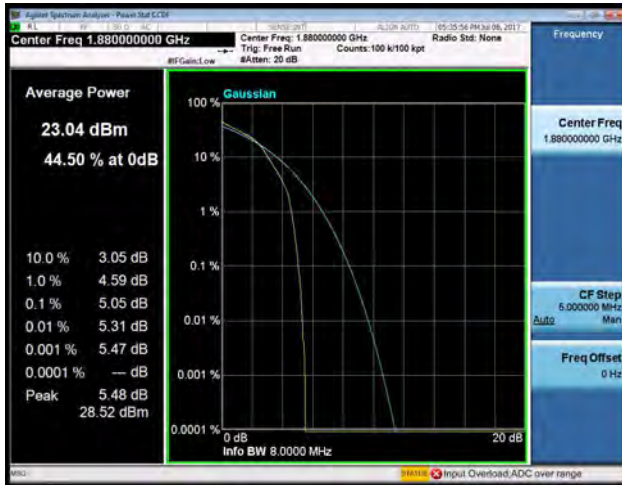

Band 4(Channel Bandwidth: 1.4 MHz)-16QAM

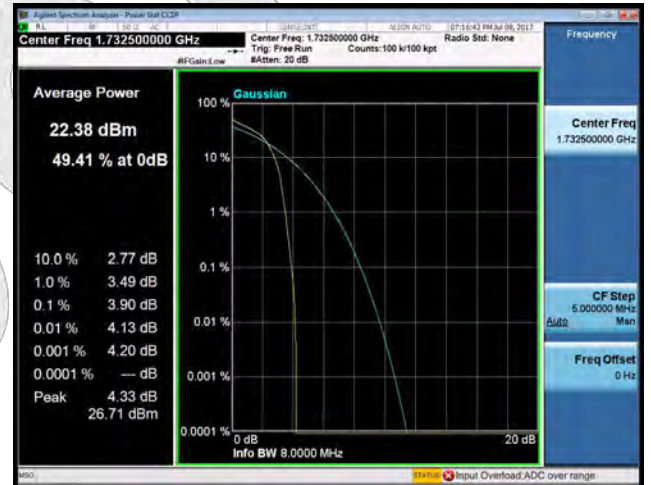

Band 2(Channel Bandwidth: 3 MHz)-QPSK

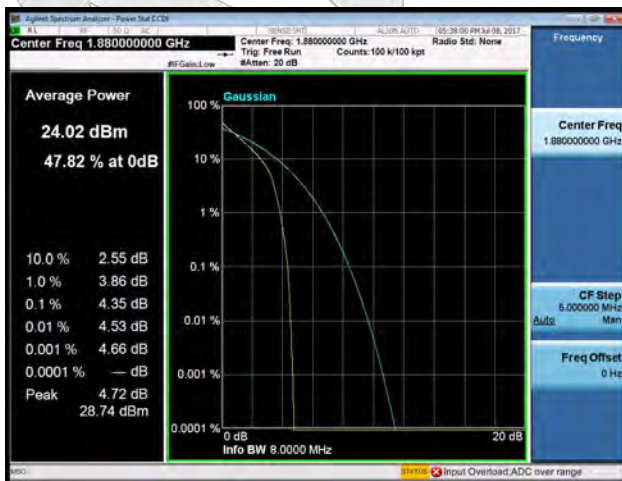

Band 4(Channel Bandwidth: 3 MHz)-QPSK



Band 2(Channel Bandwidth: 3 MHz)-16QAM

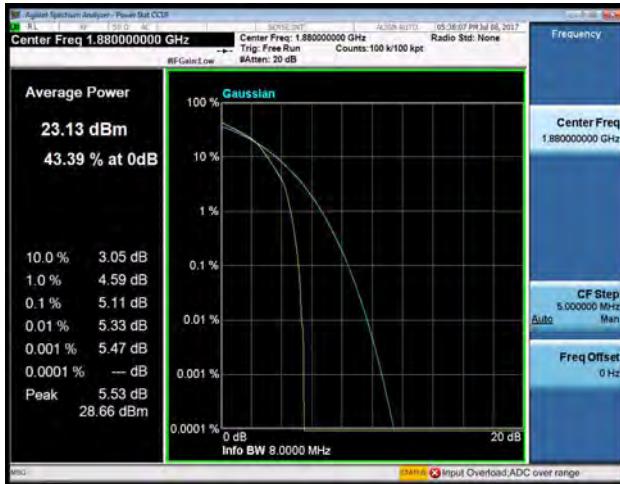

Band 4(Channel Bandwidth: 3 MHz)-16QAM



Band 2(Channel Bandwidth: 5 MHz)-QPSK



Band 4(Channel Bandwidth: 5 MHz)-QPSK

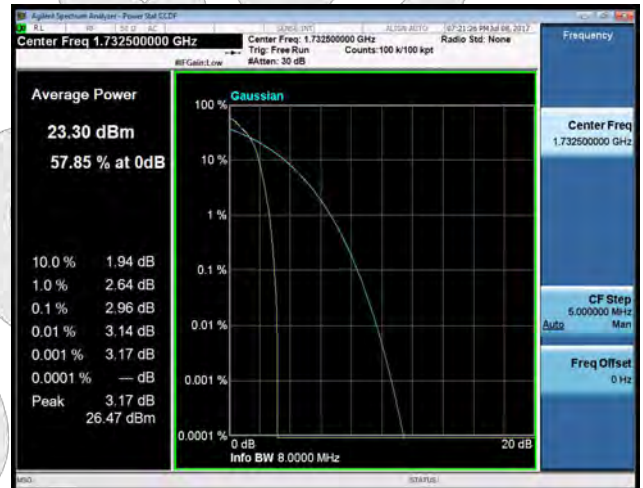

Band 2(Channel Bandwidth: 5 MHz)-16QAM



Band 4(Channel Bandwidth: 5 MHz)-16QAM



Band 2(Channel Bandwidth: 10 MHz)-QPSK



Band 4(Channel Bandwidth: 10 MHz)-QPSK

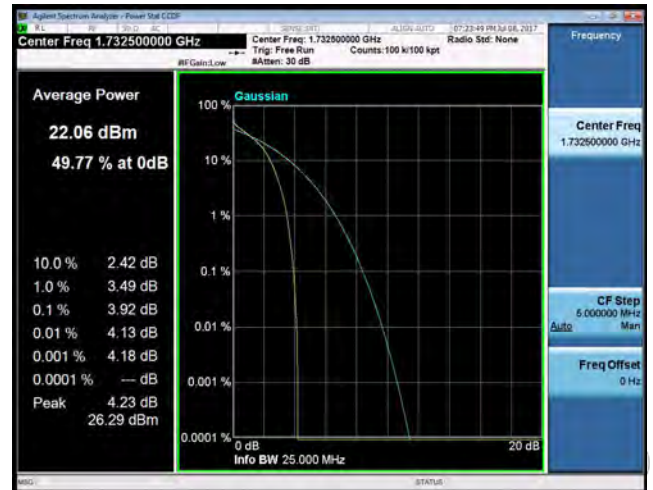

Band 2(Channel Bandwidth: 10 MHz)-16QAM

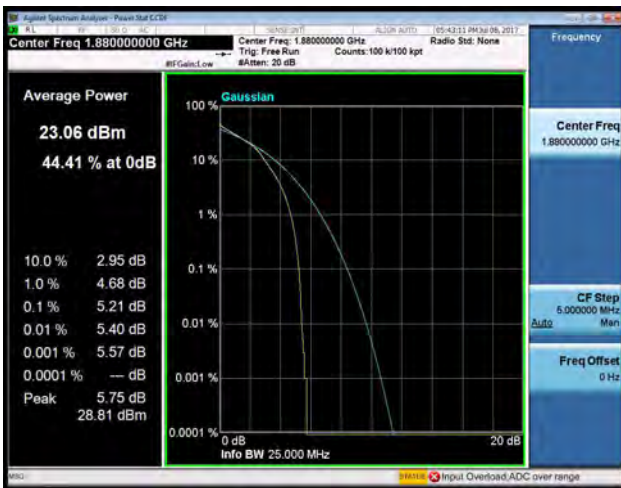

Band 4(Channel Bandwidth: 10 MHz)-16QAM

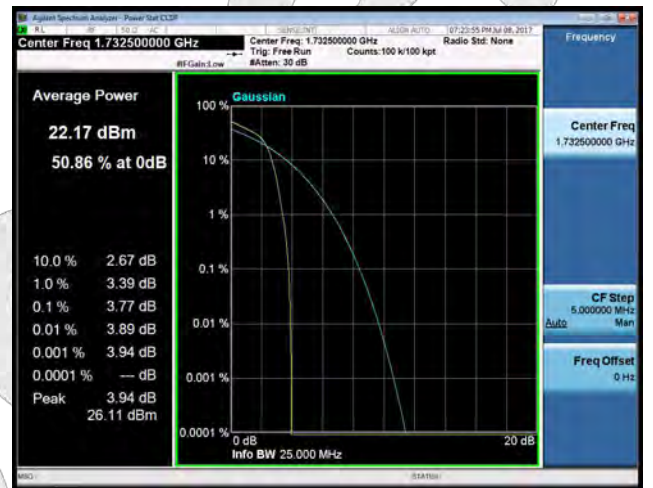

Band 2(Channel Bandwidth: 15 MHz)-QPSK



Band 4(Channel Bandwidth: 15 MHz)-QPSK



Band 2(Channel Bandwidth: 15 MHz)-16QAM

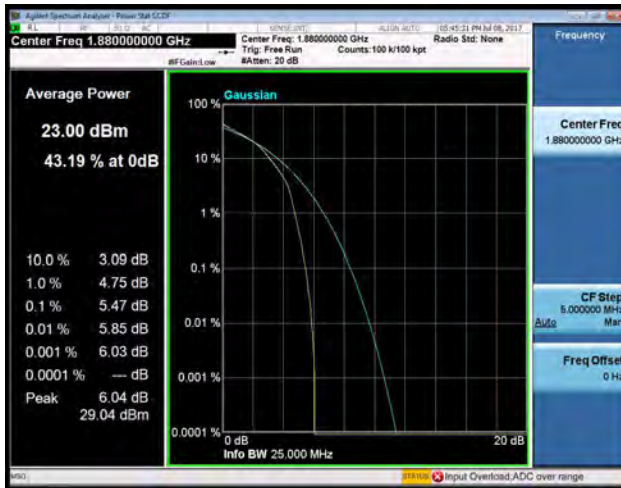

Band 4(Channel Bandwidth: 15 MHz)-16QAM



Band 2(Channel Bandwidth: 20 MHz)-QPSK

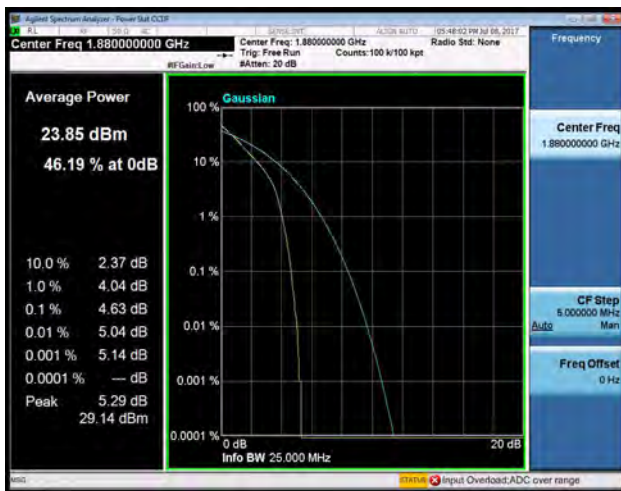

Band 4(Channel Bandwidth: 20 MHz)-QPSK



Band 2(Channel Bandwidth: 20 MHz)-16QAM



Band 4(Channel Bandwidth: 20 MHz)-16QAM

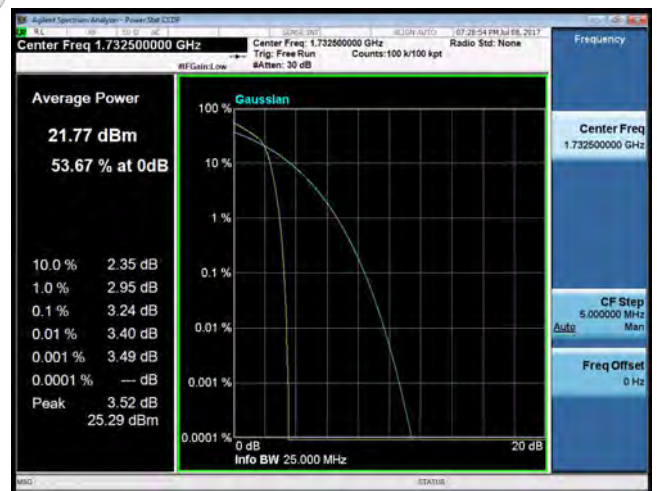

Band 5(Channel Bandwidth: 1.4 MHz)-QPSK

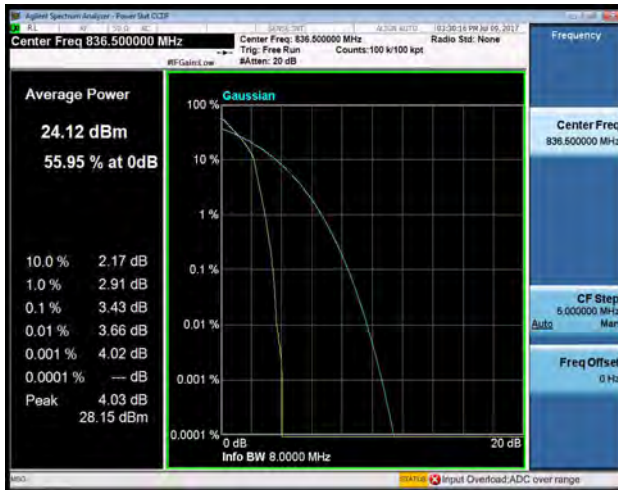

Band 17(Channel Bandwidth: 5 MHz)-QPSK

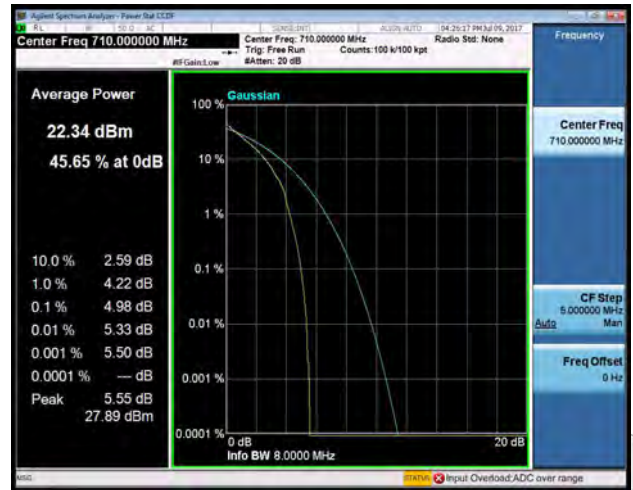

Band 5(Channel Bandwidth: 1.4 MHz)-16QAM



Band 17(Channel Bandwidth: 5MHz)-16QAM

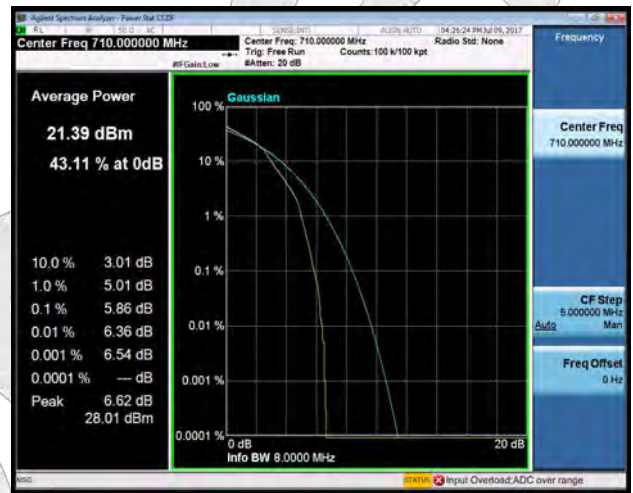

Band 5(Channel Bandwidth: 3 MHz)-QPSK

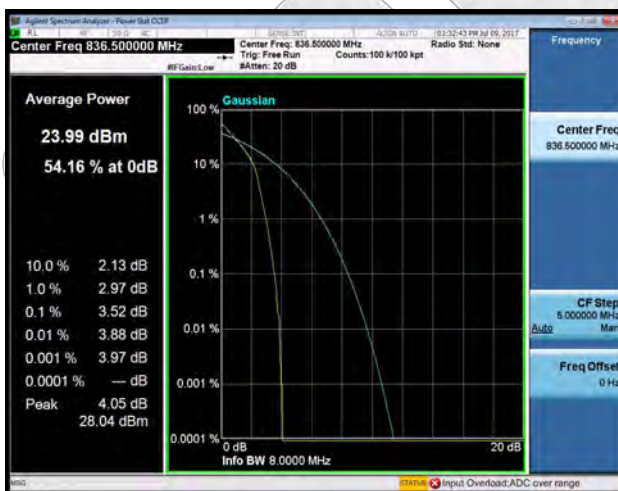

Band 17(Channel Bandwidth: 10 MHz)-QPSK



Band 5(Channel Bandwidth: 3 MHz)-16QAM



Band 17(Channel Bandwidth: 10 MHz)-16QAM

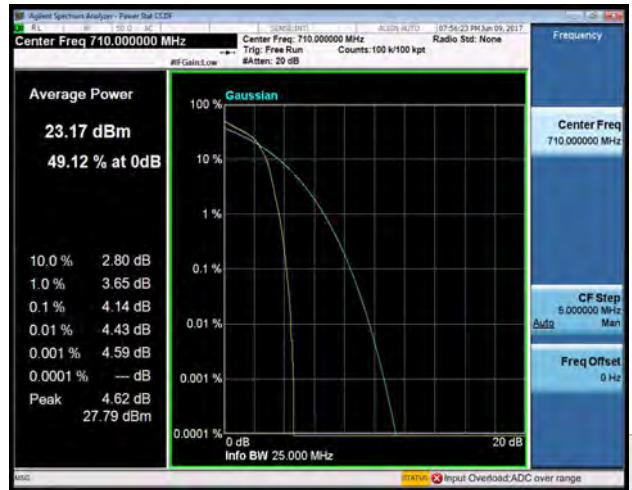

Band 5(Channel Bandwidth: 5 MHz)-QPSK

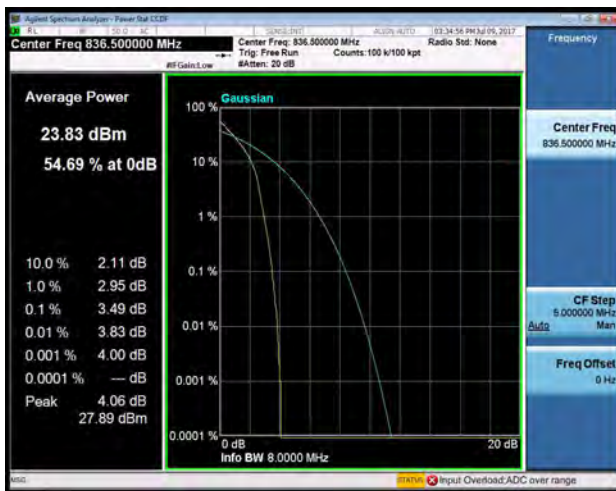

Band 5(Channel Bandwidth: 5 MHz)-16QAM



Band 5(Channel Bandwidth: 10 MHz)-QPSK

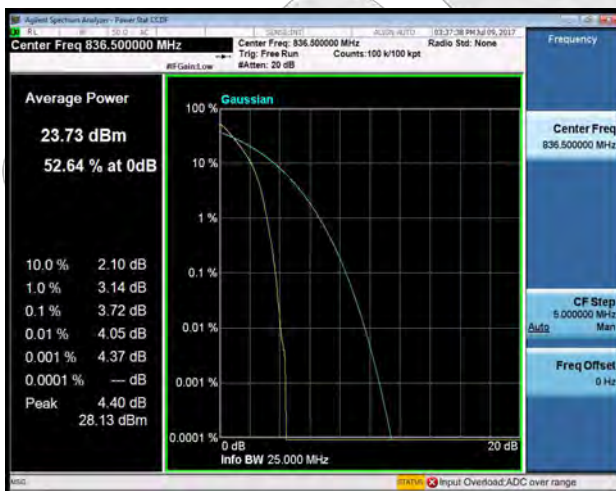

Band 5(Channel Bandwidth: 10 MHz)-16QAM

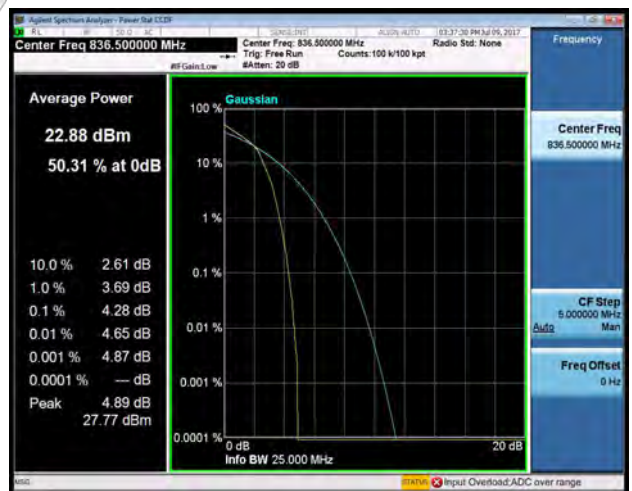

5. Modulation Characteristic

According to FCC § 2.1047(d), Part 22H, 24E there is no specific requirement for digital modulation, therefore modulation characteristic is not presented.

Anbotek

6. Occupied Bandwidth

6.1. Test Standard and Limit

Spec	Item	Requirement
§2.1049, §22.917, §22.905 §24.238 §27.53(a)	a)	99% Occupied Bandwidth(kHz)
	b)	26 dB Bandwidth(kHz)

6.2. Test Setup

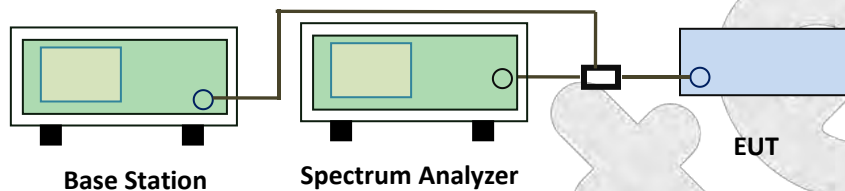

6.3. Test Procedure

The EUT was connected to Spectrum Analyzer and Base Station via power divider.
The 99% and 26 dB occupied bandwidth (BW) of the middle channel for the highest RF powers.

6.4. Test Data

LTE Band 2:

BW(MHz)	Channel	Frequency (MHz)	Modulation	99% Occupied Bandwidth (MHz)	26 dB Bandwidth (MHz)
1.4	18607	1850.7	QPSK	1.0794	1.236
			16QAM	1.0821	1.250
1.4	18900	1880	QPSK	1.0783	1.279
			16QAM	1.0817	1.294
1.4	19193	1909.3	QPSK	1.0950	1.548
			16QAM	1.0905	1.583
3	18615	1851.5	QPSK	2.6858	2.885
			16QAM	2.6859	2.895
3	18900	1880	QPSK	2.6877	2.903
			16QAM	2.6856	2.893
3	19185	1908.5	QPSK	2.6879	2.987
			16QAM	2.6882	3.015
5	18625	1852.5	QPSK	4.4846	4.838
			16QAM	4.4823	4.817
5	18900	1800	QPSK	4.4797	4.838
			16QAM	4.4797	4.875

5	19175	1907.5	QPSK	4.4833	4.858
			16QAM	4.4916	4.823
10	18650	1855	QPSK	8.9399	9.590
			16QAM	8.9294	9.499
10	18900	1880	QPSK	8.9438	9.472
			16QAM	8.9384	9.471
10	19150	1905	QPSK	8.9504	9.637
			16QAM	8.9602	9.490
15	18675	1857.5	QPSK	13.397	14.19
			16QAM	13.383	14.04
15	18900	1880	QPSK	13.416	14.21
			16QAM	13.427	14.12
15	19125	1902.5	QPSK	13.466	14.59
			16QAM	13.452	14.18
20	18700	1860	QPSK	17.822	18.56
			16QAM	17.822	18.59
20	18900	1880	QPSK	17.902	18.61
			16QAM	17.909	18.66
20	19100	1900	QPSK	17.907	18.71
			16QAM	17.909	18.66

LTE Band 4:

BW(MHz)	Channel	Frequency (MHz)	Modulation	99% Occupied Bandwidth (MHz)	26 dB Bandwidth (MHz)
1.4	19957	1710.7	QPSK	1.0794	1.237
			16QAM	1.0813	1.219
1.4	20175	1732.5	QPSK	1.0762	1.230
			16QAM	1.0788	1.224
1.4	20393	1754.3	QPSK	1.0780	1.225
			16QAM	1.0761	1.223
3	19965	1711.5	QPSK	2.6845	2.886
			16QAM	2.6805	2.874
3	20175	1732.5	QPSK	2.6863	2.879
			16QAM	2.6843	2.857
3	20385	1753.5	QPSK	2.6837	2.864
			16QAM	2.6816	2.886
5	19975	1712.5	QPSK	4.4845	4.798
			16QAM	4.4816	4.835
5	20175	1732.5	QPSK	4.4859	4.756
			16QAM	4.4768	4.822
5	20375	1752.5	QPSK	4.4799	4.895
			16QAM	4.4855	4.791

10	20000	1715	QPSK	8.9503	9.502
			16QAM	8.9419	9.462
10	20175	1732.5	QPSK	8.9238	9.483
			16QAM	8.9114	9.466
10	20350	1750	QPSK	8.9355	9.461
			16QAM	8.9452	9.530
15	20025	1717.5	QPSK	13.418	14.09
			16QAM	13.414	14.04
15	20175	1732.5	QPSK	13.369	14.10
			16QAM	13.382	14.00
15	20325	1747.5	QPSK	13.440	14.12
			16QAM	13.436	14.03
20	20050	1720	QPSK	17.890	18.57
			16QAM	17.893	18.57
20	20175	1732.5	QPSK	17.808	18.59
			16QAM	17.810	18.54
20	20300	1745	QPSK	17.925	18.71
			16QAM	17.896	18.64

LTE Band 5:

BW(MHz)	Channel	Frequency (MHz)	Modulation	99% Occupied Bandwidth (MHz)	26 dB Bandwidth (MHz)
1.4	20407	824.7	QPSK	1.0785	1.281
			16QAM	1.0825	1.231
1.4	20525	836.5	QPSK	1.0793	1.236
			16QAM	1.0803	1.248
1.4	20643	848.3	QPSK	1.0779	1.214
			16QAM	1.0780	1.228
3	20415	825.5	QPSK	2.6874	2.858
			16QAM	2.6837	2.876
3	20525	836.5	QPSK	2.6851	2.895
			16QAM	2.6852	2.896
3	20635	847.5	QPSK	2.6850	2.890
			16QAM	2.6891	2.886
5	20425	826.5	QPSK	4.4884	4.828
			16QAM	4.4805	4.846
5	20525	836.5	QPSK	4.4848	4.867
			16QAM	4.4904	4.803
5	20625	846.5	QPSK	4.4799	4.827
			16QAM	4.4859	4.868
10	20450	829.0	QPSK	8.9502	9.478
			16QAM	8.9477	9.464

10	20525	836.5	QPSK	8.9528	9.636
			16QAM	8.9606	9.593
10	20600	844.0	QPSK	8.9393	9.630
			16QAM	8.9459	9.452

LTE Band 17:

BW(MHz)	Channel	Frequency (MHz)	Modulation	99% Occupied Bandwidth (MHz)	26 dB Bandwidth (MHz)
5	23755	706.5	QPSK	4.4852	4.839
			16QAM	4.4805	4.831
5	23790	710	QPSK	4.4881	4.843
			16QAM	4.4947	4.805
5	23825	713.5	QPSK	4.4747	4.797
			16QAM	4.4688	4.811
10	23780	709	QPSK	8.9864	9.545
			16QAM	8.9888	9.506
10	23790	710	QPSK	8.9706	9.541
			16QAM	8.9724	9.391
10	23800	711	QPSK	8.9235	9.399
			16QAM	8.9472	9.383

Note: This test was only measured at maximum RB allocation for each LTE BW

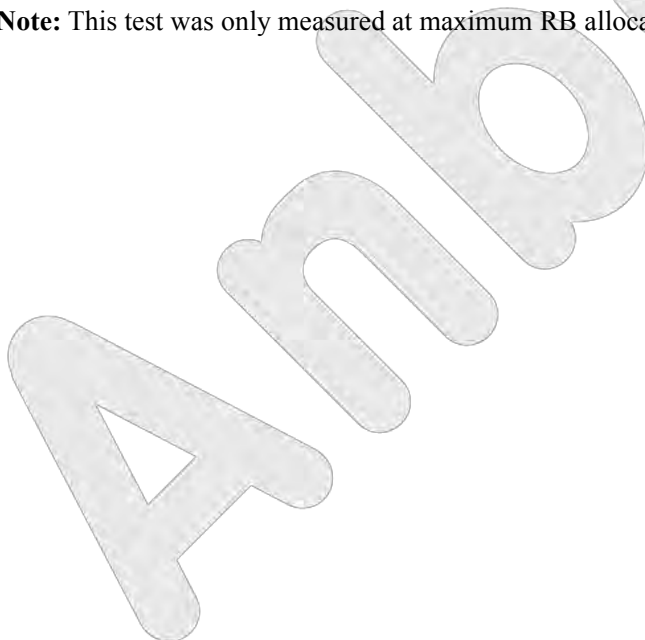

Test Plots

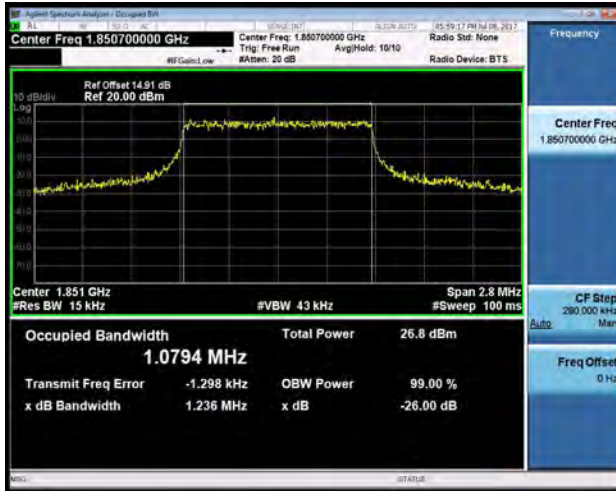

LTE band 2 - Low CH QPSK-1.4



LTE band 2 - Low CH 16QAM-1.4

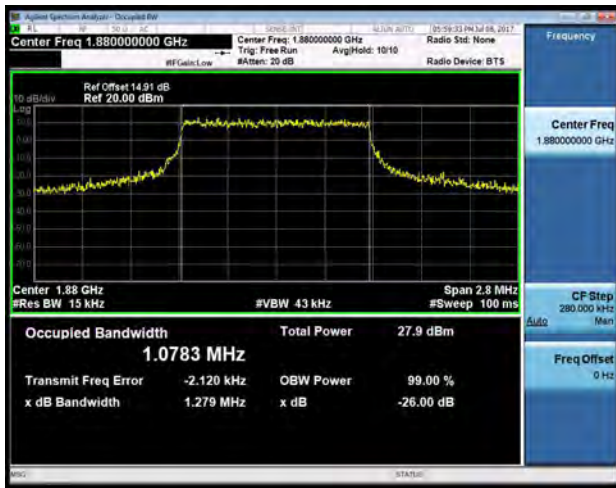

LTE band 2 - Middle CH QPSK-1.4



LTE band 2 - Middle CH 16QAM-1.4

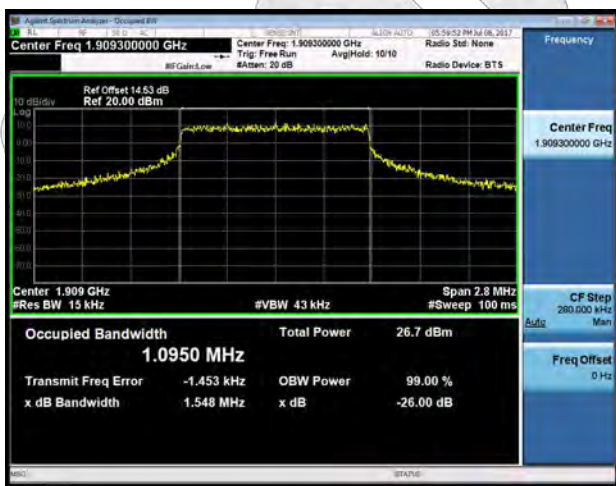

LTE band 2 - High CH QPSK-1.4



LTE band 2 -High CH 16QAM-1.4

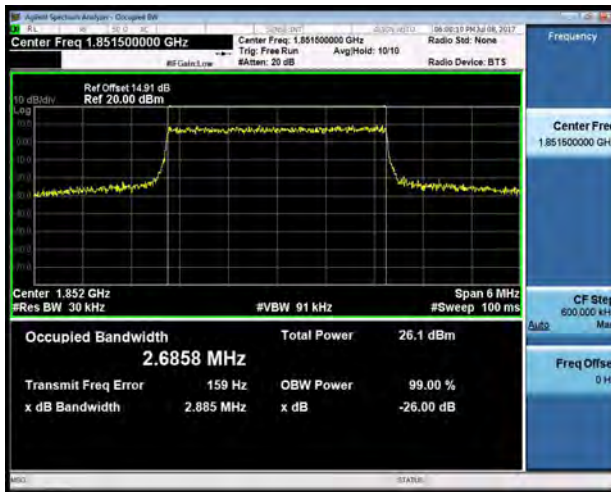

LTE band 2 - Low CH QPSK-3

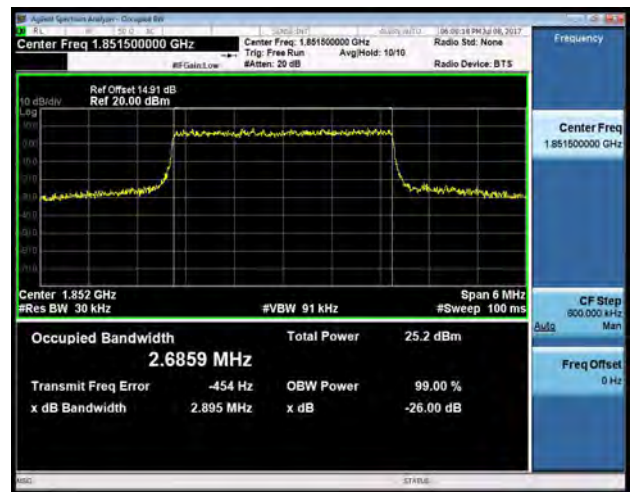

LTE band 2 - Low CH 16QAM-3

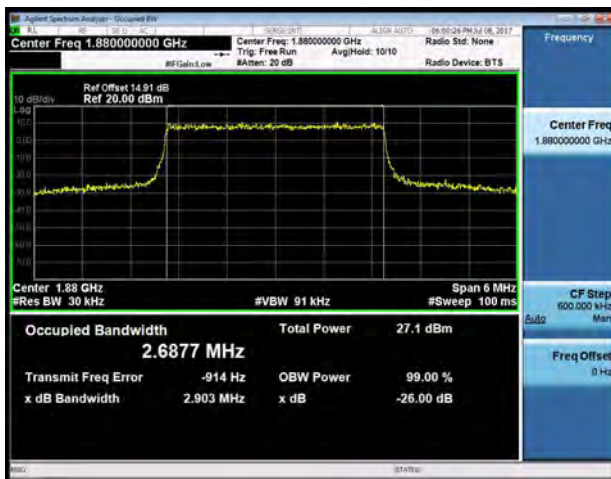

LTE band 2 - Middle CH QPSK-3

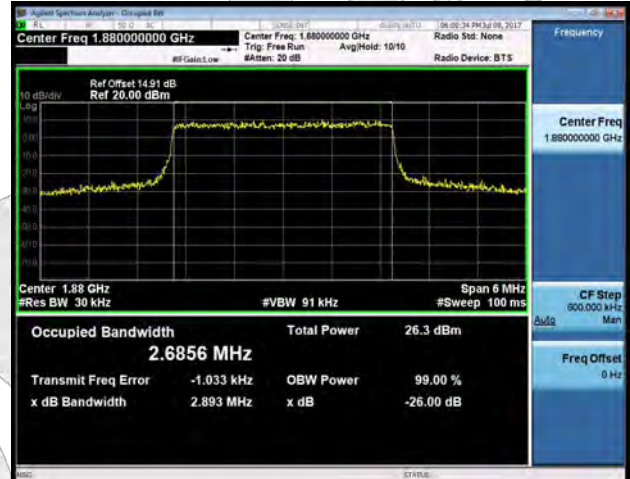

LTE band 2 - Middle CH 16QAM-3



LTE band 2 - High CH QPSK-3



LTE band 2 - High CH 16QAM-3

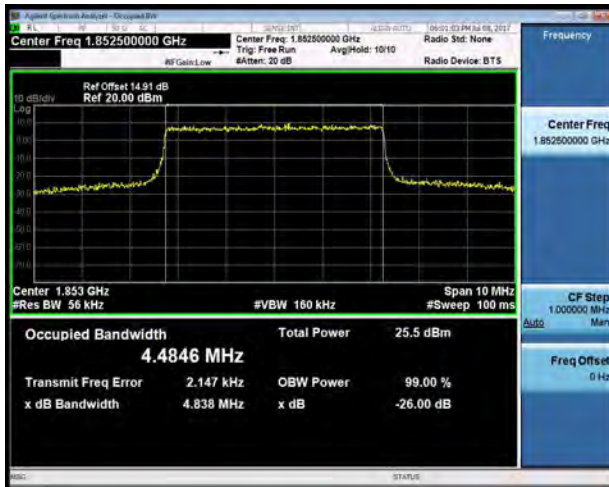

LTE band 2 - Low CH QPSK-5

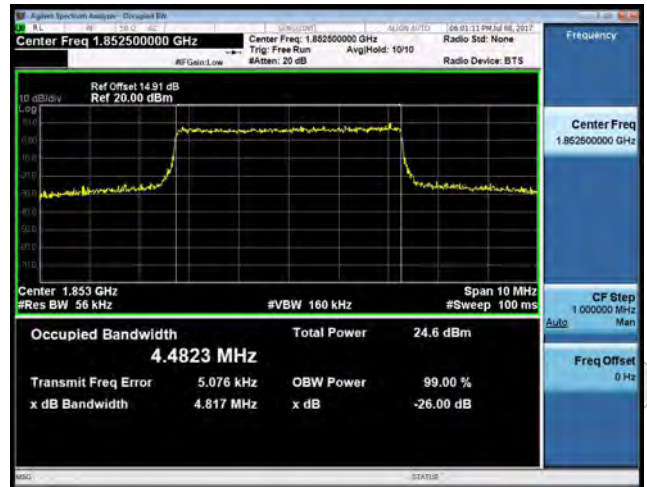

LTE band 2 - Low CH 16QAM-5

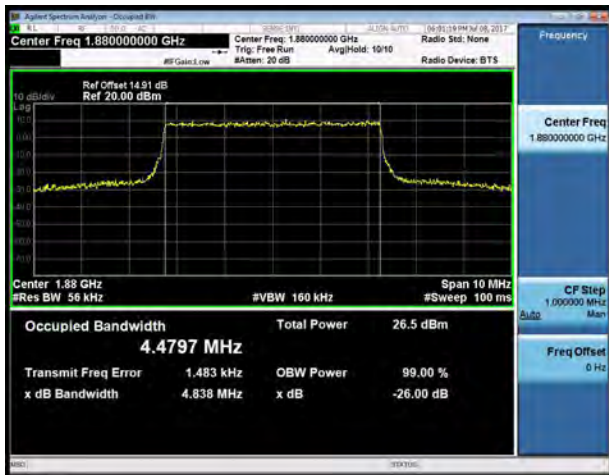

LTE band 2 - Middle CH QPSK-5



LTE band 2 - Middle CH 16QAM-5



LTE band 2 - High CH QPSK-5



LTE band 2 - High CH 16QAM-5

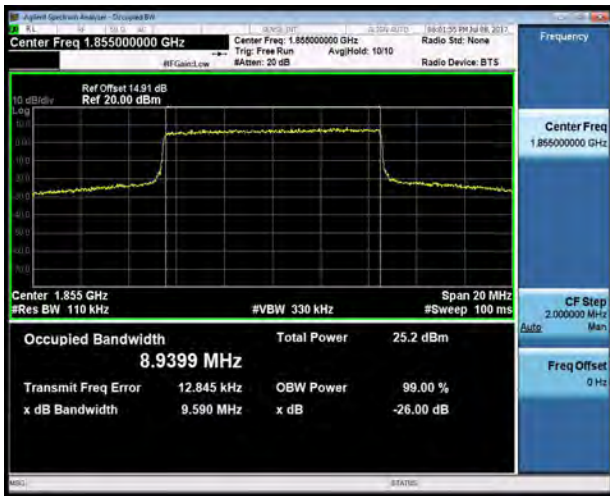

LTE band 2 - Low CH QPSK-10

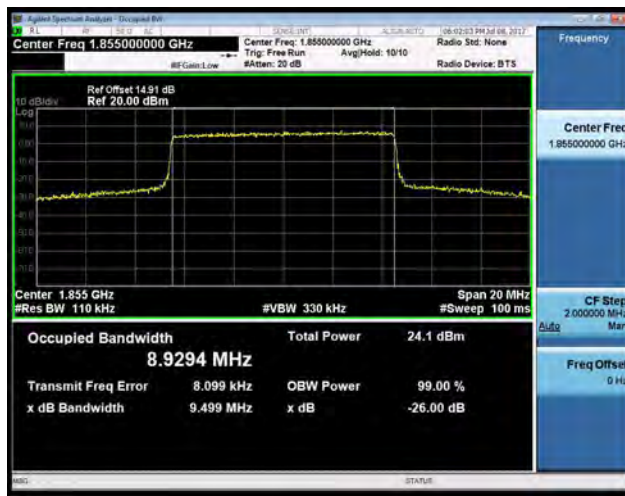

LTE band 2 - Low CH 16QAM-10



LTE band 2 - Middle CH QPSK-10



LTE band 2 - Middle CH 16QAM-10



LTE band 2 - High CH QPSK-10



LTE band 2 - High CH 16QAM-10

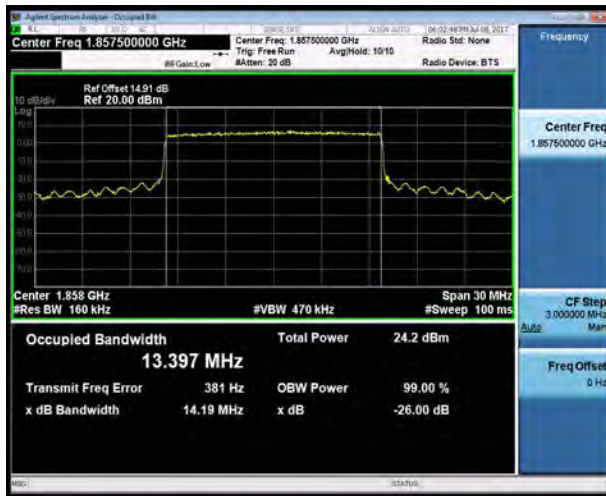

LTE band 2 - Low CH QPSK-15



LTE band 2 - Low CH 16QAM-15

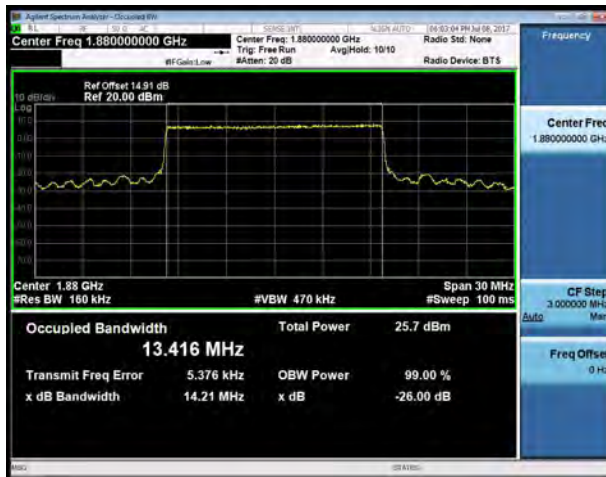

LTE band 2 - Middle CH QPSK-15

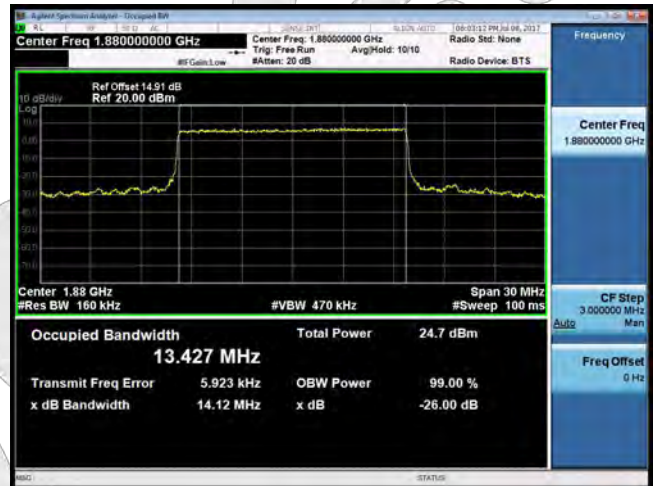

LTE band 2 - Middle CH 16QAM-15

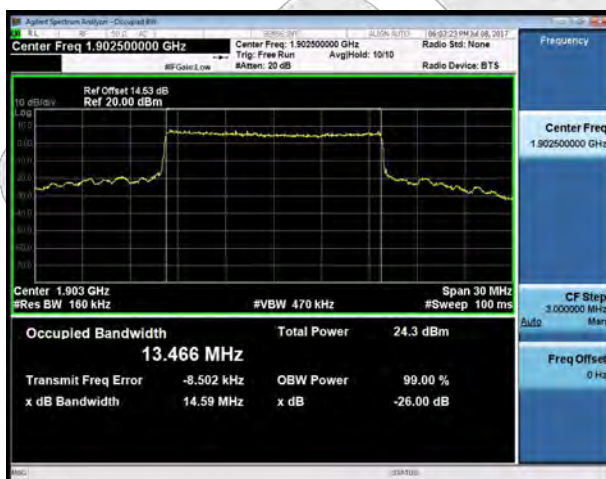

LTE band 2 - High CH QPSK-15



LTE band 2 -High CH 16QAM-15



LTE band 2 - Low CH QPSK-20



LTE band 2 - Low CH 16QAM-20



LTE band 2 - Middle CH QPSK-20



LTE band 2 - Middle CH 16QAM-20



LTE band 2 - High CH QPSK-20



LTE band 2 - High CH 16QAM-20

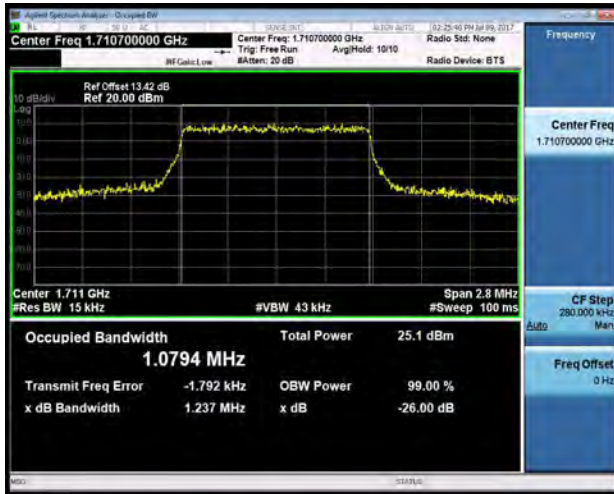

LTE band 4 - Low CH QPSK-1.4



LTE band 4 - Low CH 16QAM-1.4

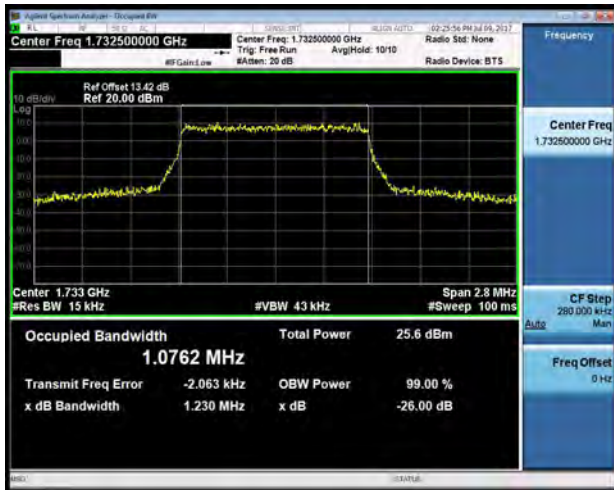

LTE band 4 - Middle CH QPSK-1.4

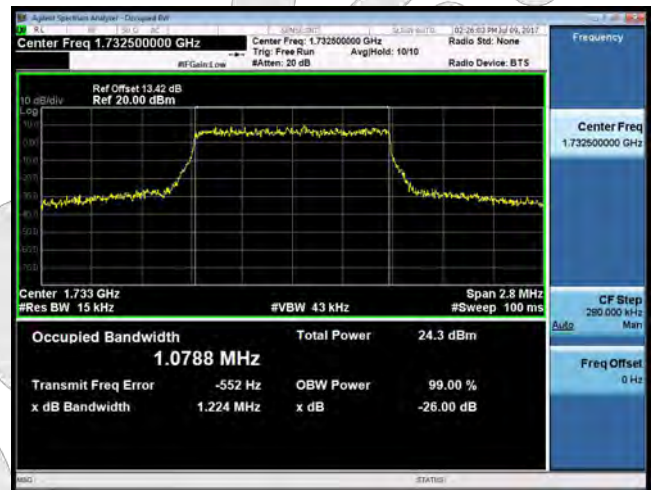

LTE band 4 - Middle CH 16QAM-1.4

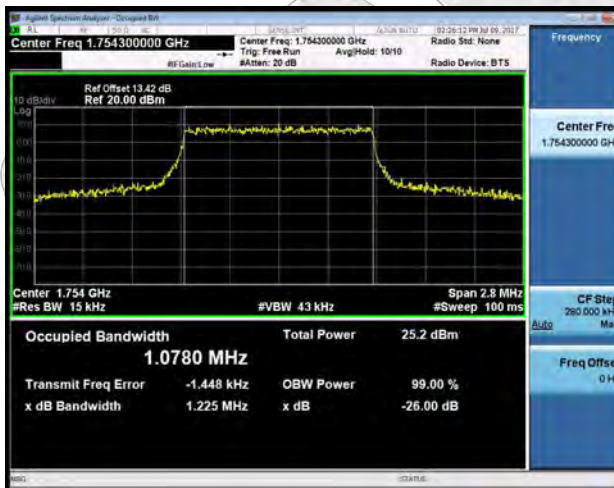

LTE band 4 - High CH QPSK-1.4



LTE band 4 - High CH 16QAM-1.4

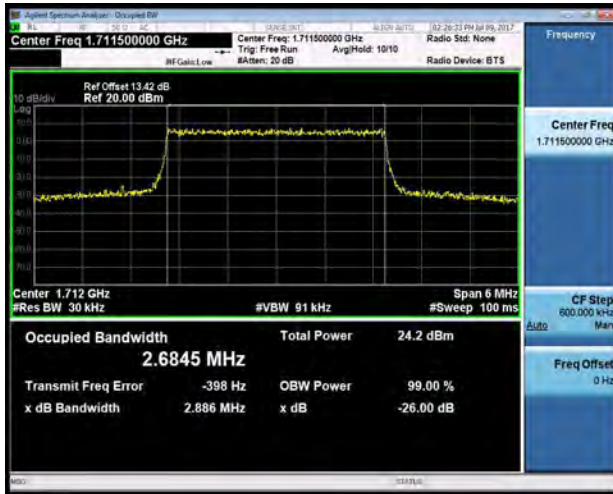

LTE band 4 - Low CH QPSK-3

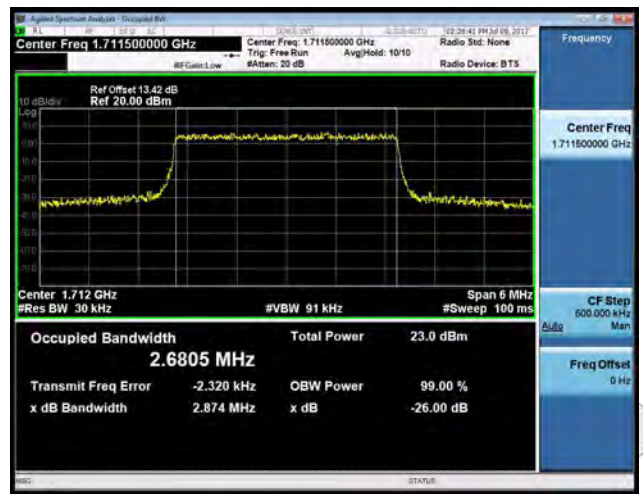

LTE band 4 - Low CH 16QAM-3

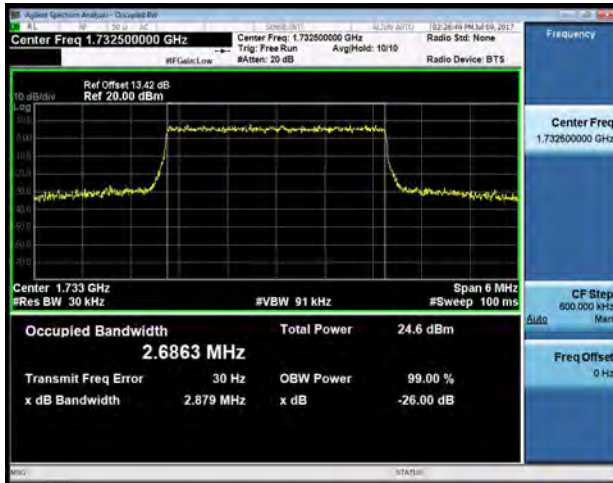

LTE band 4 - Middle CH QPSK-3

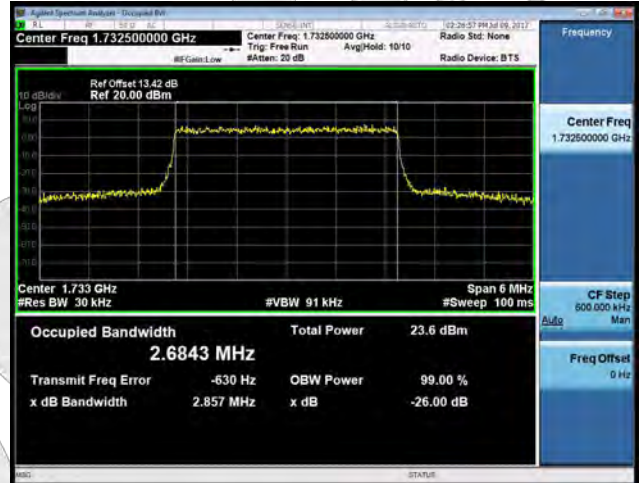

LTE band 4 - Middle CH 16QAM-3



LTE band 4 - High CH QPSK-3

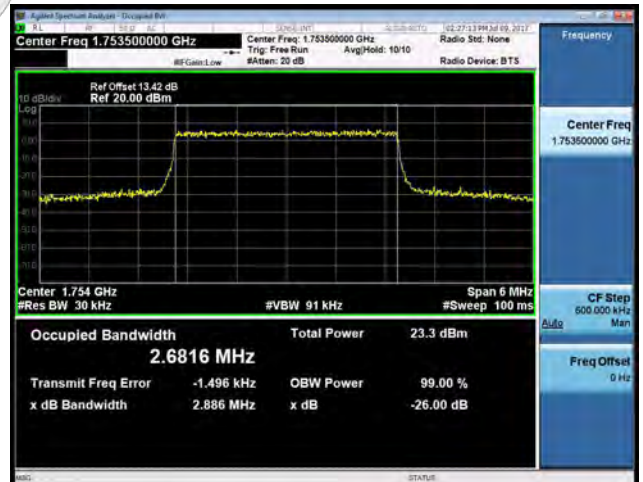

LTE band 4 - High CH 16QAM-3



LTE band 4 - Low CH QPSK-5

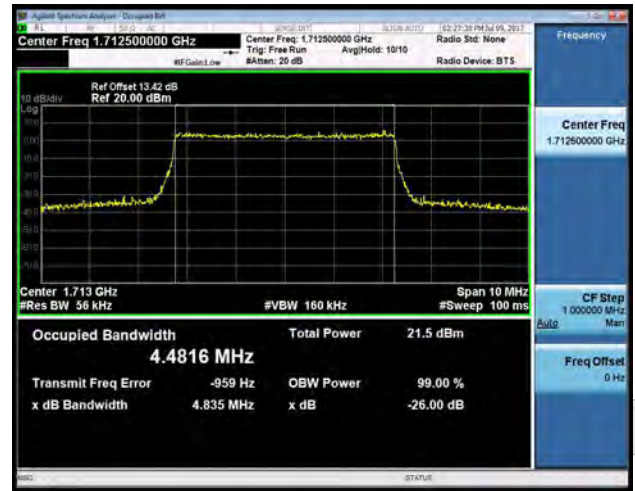

LTE band 4 - Low CH 16QAM-5

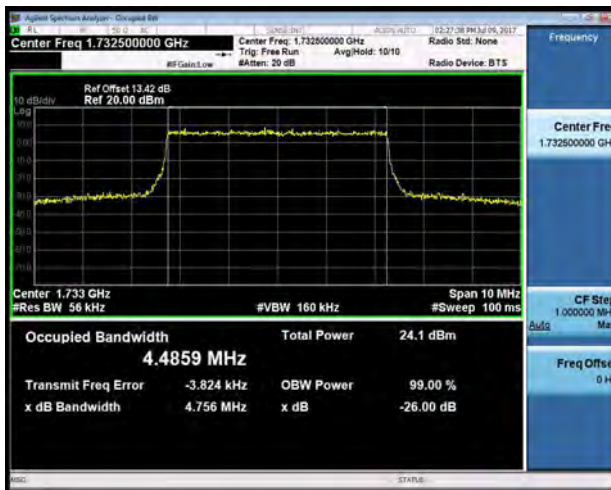

LTE band 4 - Middle CH QPSK-5



LTE band 4 - Middle CH 16QAM-5



LTE band 4 - High CH QPSK-5



LTE band 4 - High CH 16QAM-5



LTE band 4 - Low CH QPSK-10

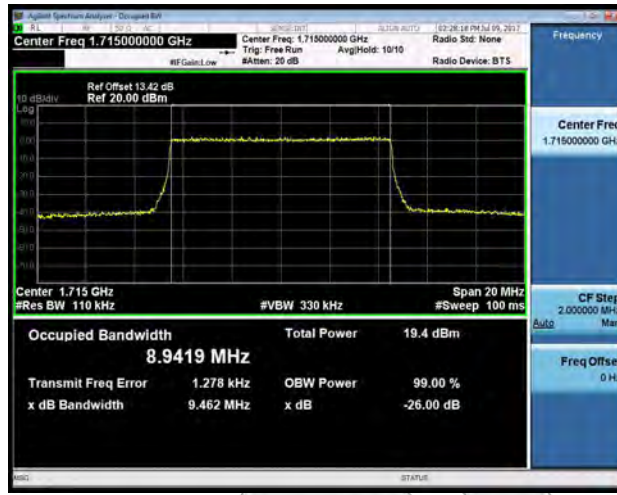

LTE band 4 - Low CH 16QAM-10



LTE band 4 - Middle CH QPSK-10

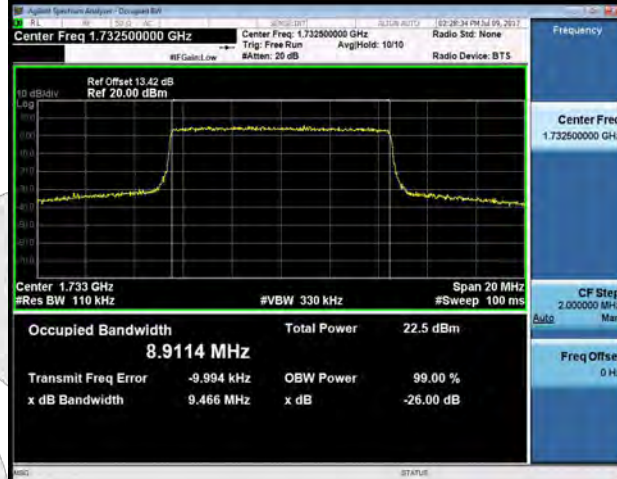

LTE band 4 - Middle CH 16QAM-10



LTE band 4 - High CH QPSK-10



LTE band 4 - High CH 16QAM-10



LTE band 4 - Low CH QPSK-15

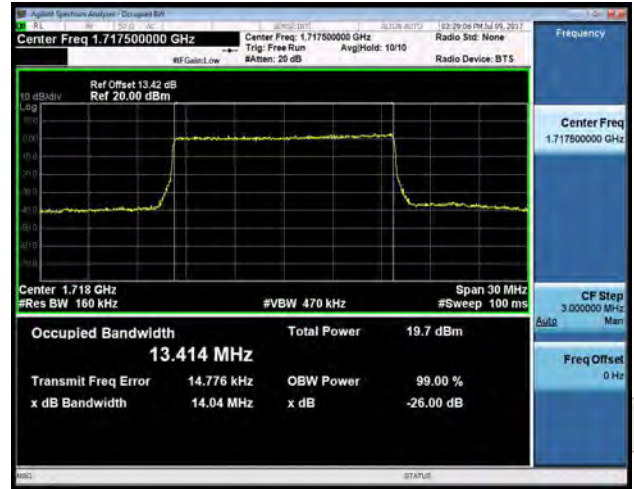

LTE band 4 - Low CH 16QAM-15

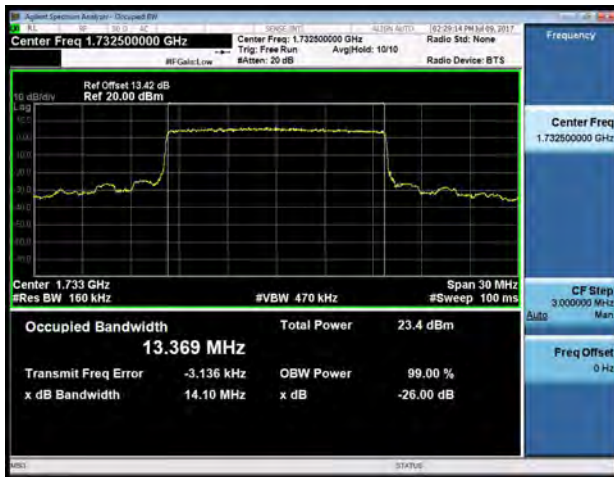

LTE band 4 - Middle CH QPSK-15

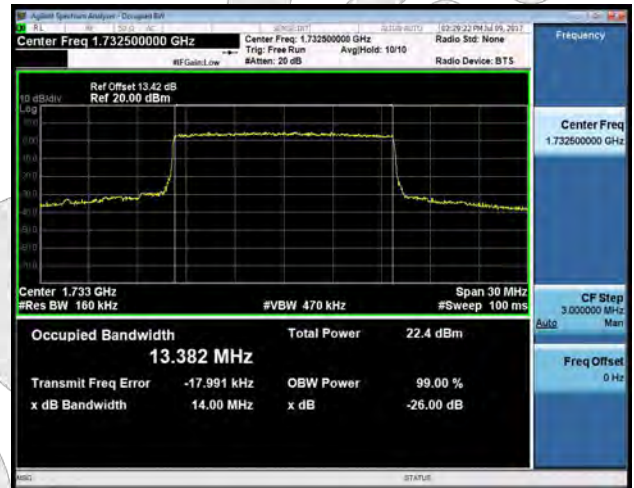

LTE band 4 - Middle CH 16QAM-15

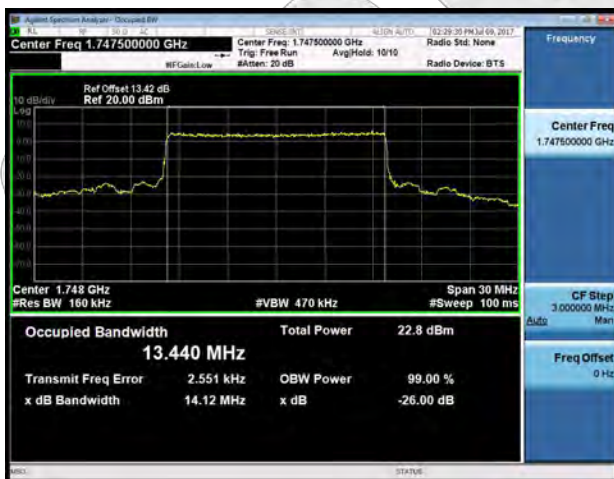

LTE band 4 - High CH QPSK-15

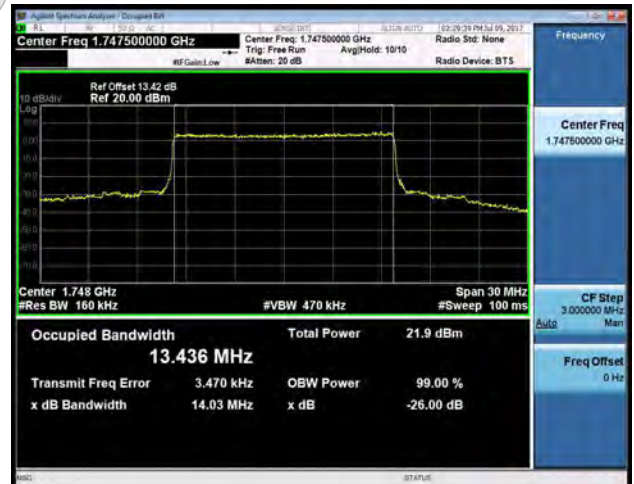

LTE band 4 - High CH 16QAM-15

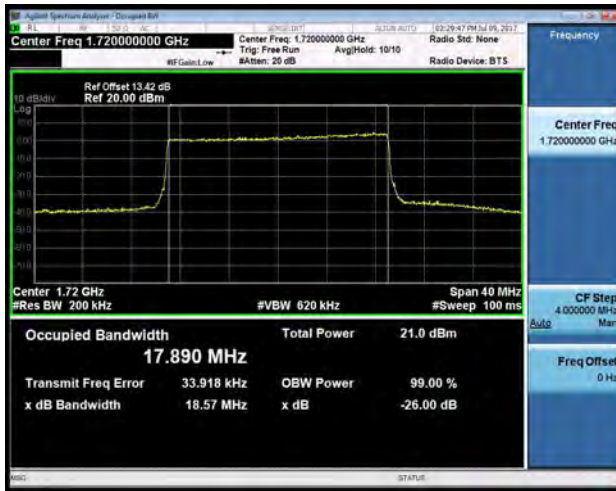

LTE band 4 - Low CH QPSK-20

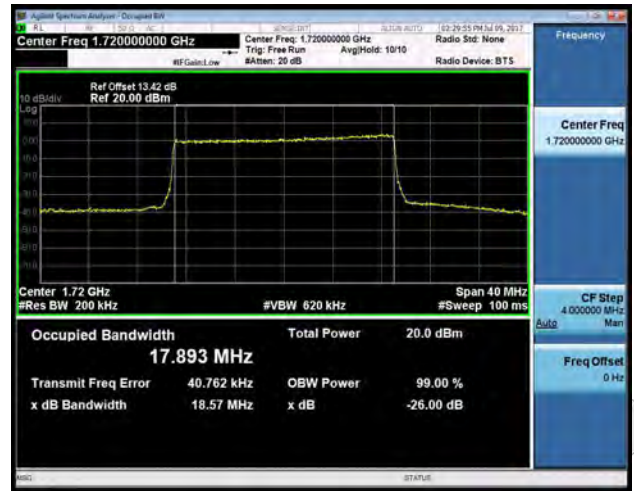

LTE band 4 - Low CH 16QAM-20

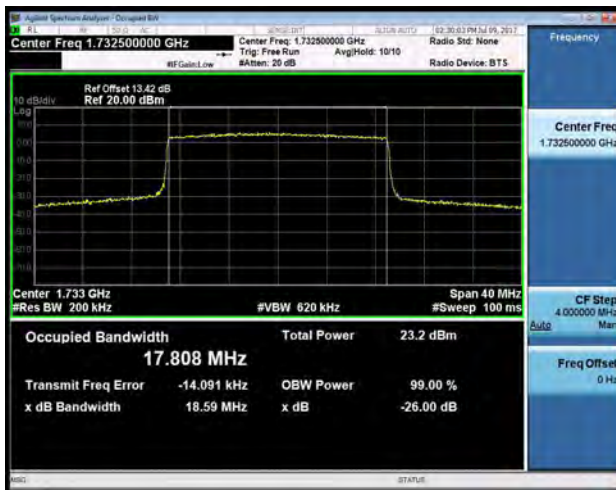

LTE band 4 - Middle CH QPSK-20



LTE band 4 - Middle CH 16QAM-20



LTE band 4 - High CH QPSK-20



LTE band 4 - High CH 16QAM-20



LTE band 5 - Low CH QPSK-1.4



LTE band 5 - Low CH 16QAM-1.4

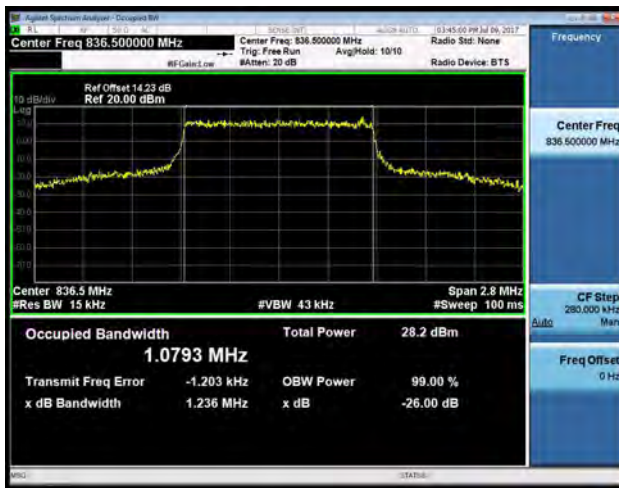

LTE band 5 - Middle CH QPSK-1.4

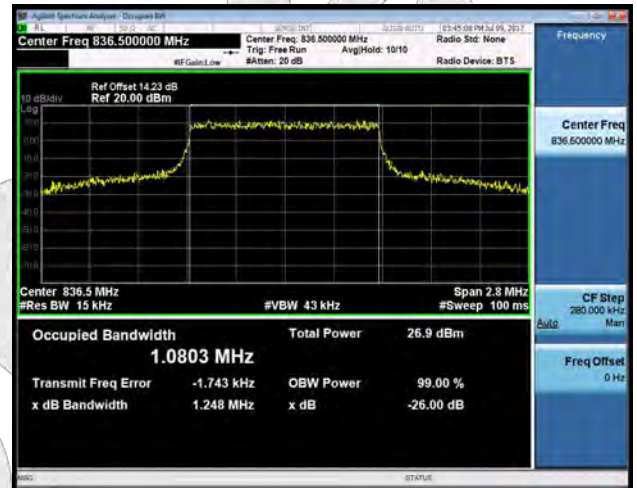

LTE band 5 - Middle CH 16QAM-1.4

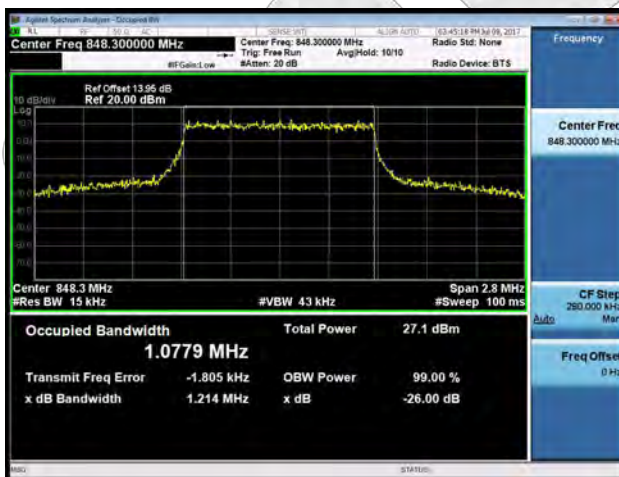

LTE band 5 - High CH QPSK-1.4

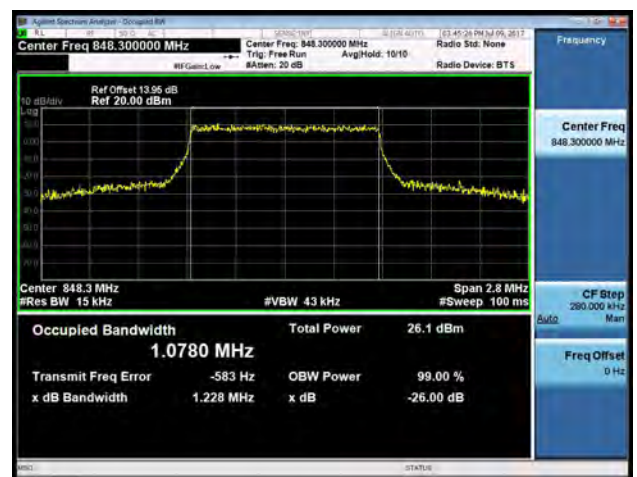

LTE band 5 -High CH 16QAM-1.4

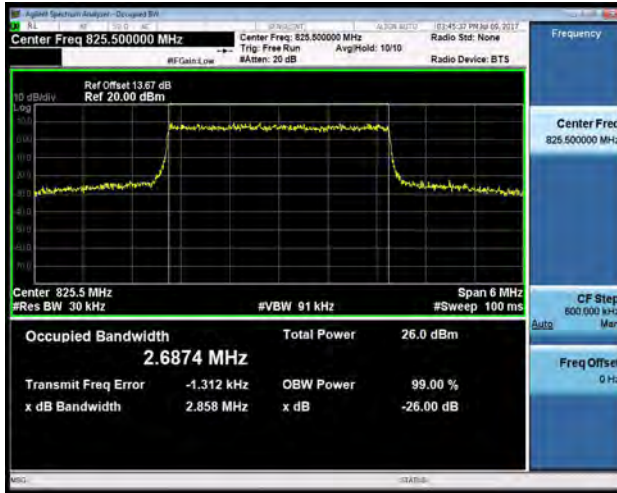

LTE band 5 - Low CH QPSK-3

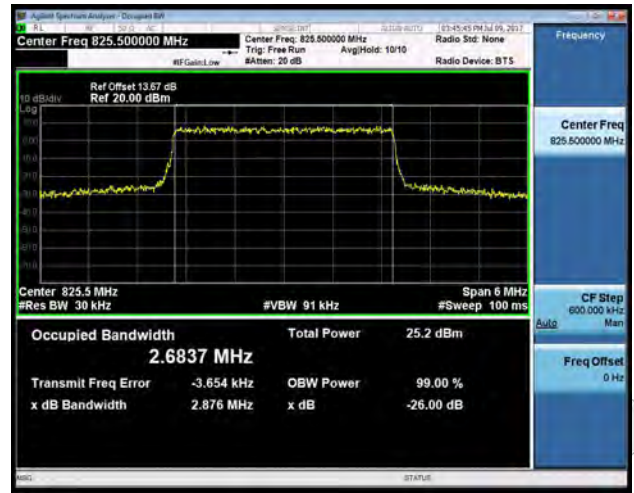

LTE band 5 - Low CH 16QAM-3



LTE band 5 - Middle CH QPSK-3

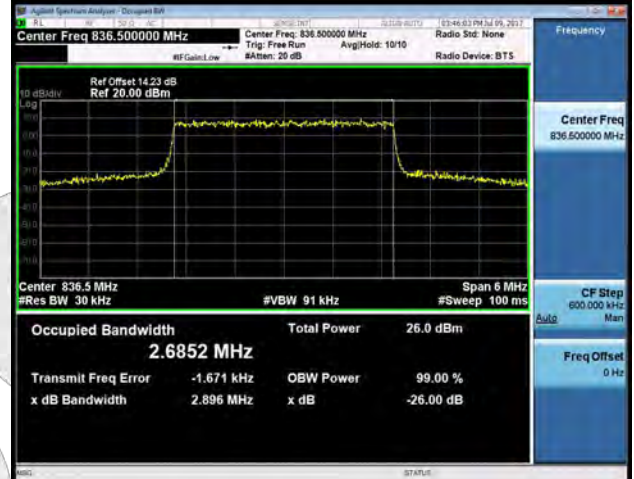

LTE band 5 - Middle CH 16QAM-3

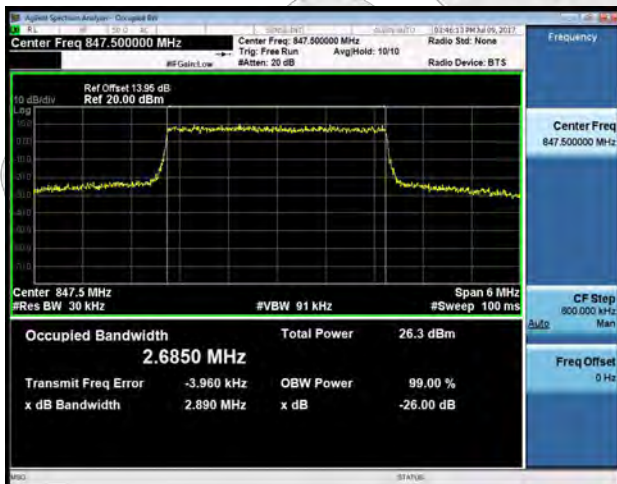

LTE band 5 - High CH QPSK-3

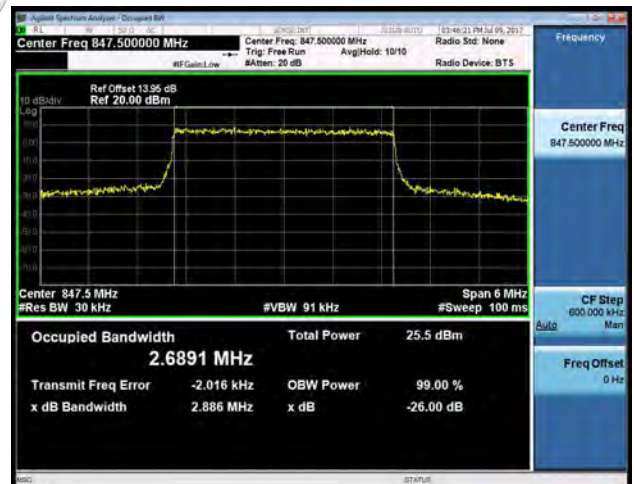

LTE band 5 - High CH 16QAM-3



LTE band 5 - Low CH QPSK-5

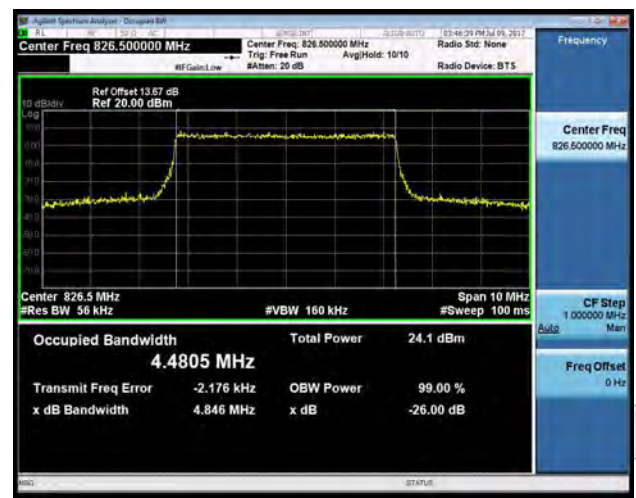

LTE band 5 - Low CH 16QAM-5



LTE band 5 - Middle CH QPSK-5

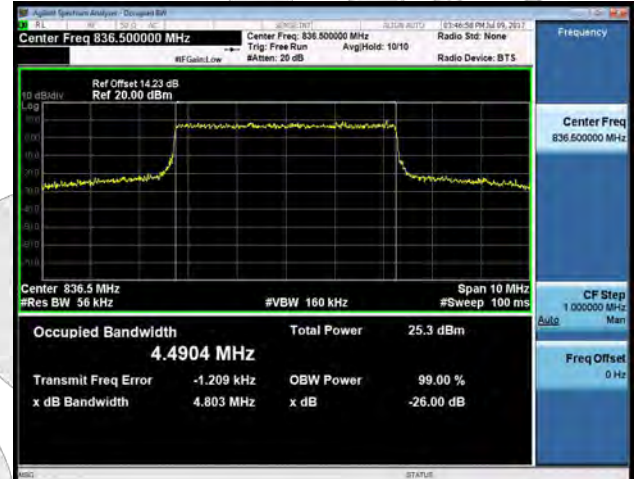

LTE band 5 - Middle CH 16QAM-5

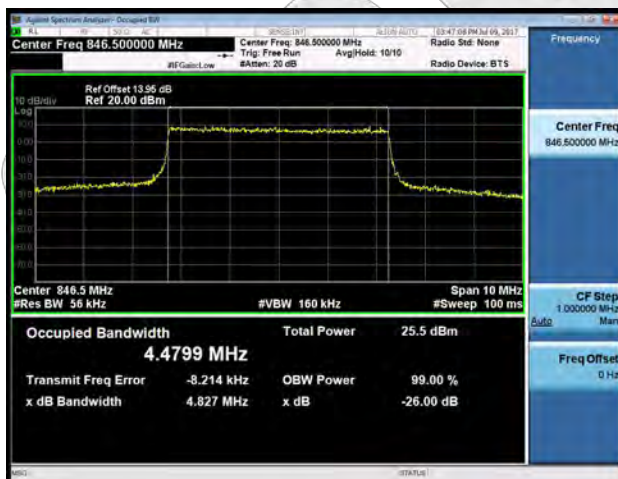

LTE band 5 - High CH QPSK-5



LTE band 5 - High CH 16QAM-5

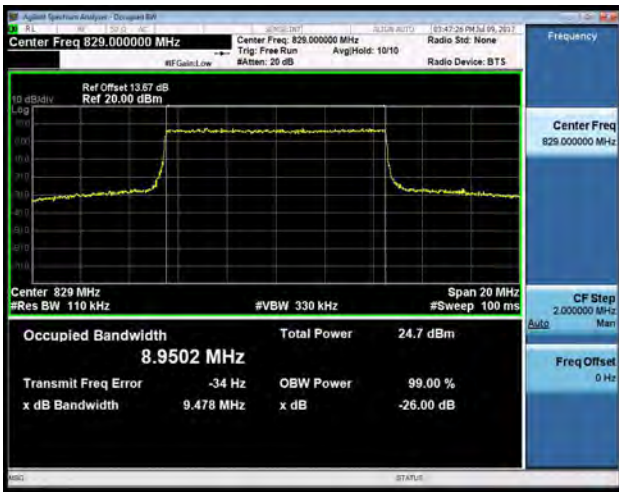

LTE band 5 - Low CH QPSK-10



LTE band 5 - Low CH 16QAM-10

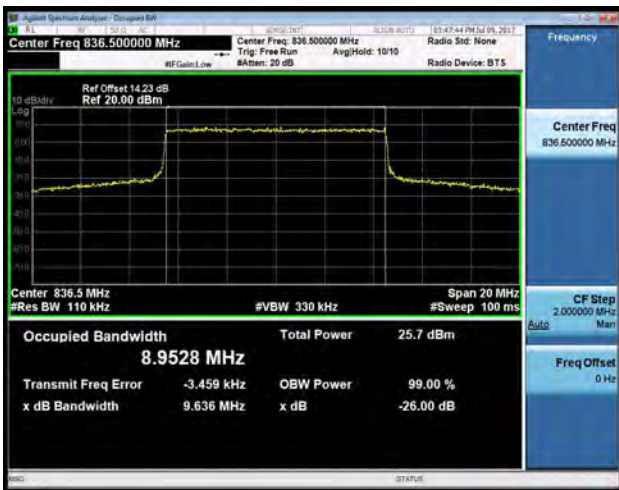

LTE band 5 - Middle CH QPSK-10



LTE band 5 - Middle CH 16QAM-10

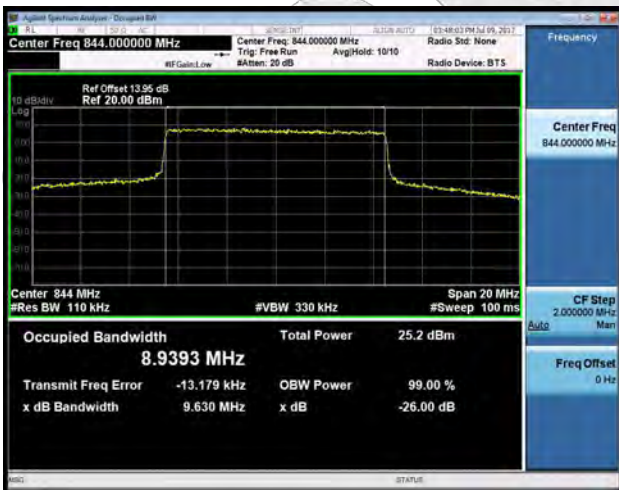

LTE band 5 - High CH QPSK-10



LTE band 5 - High CH 16QAM-10

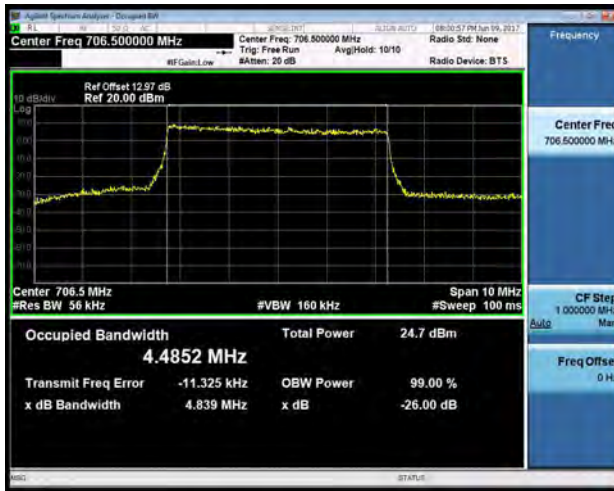

LTE band 17 - Low CH QPSK-5

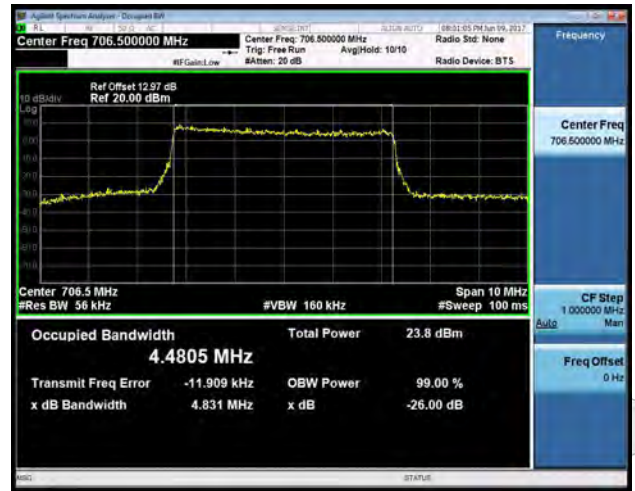

LTE band 17 - Low CH 16QAM-5

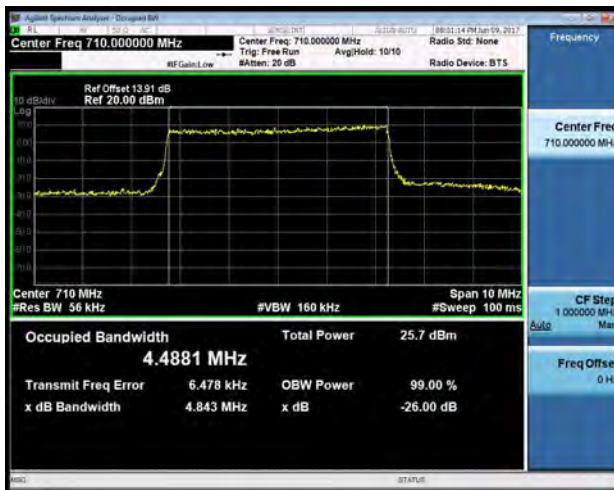

LTE band 17 - Middle CH QPSK-5



LTE band 17 - Middle CH 16QAM-5



LTE band 17 - High CH QPSK-5

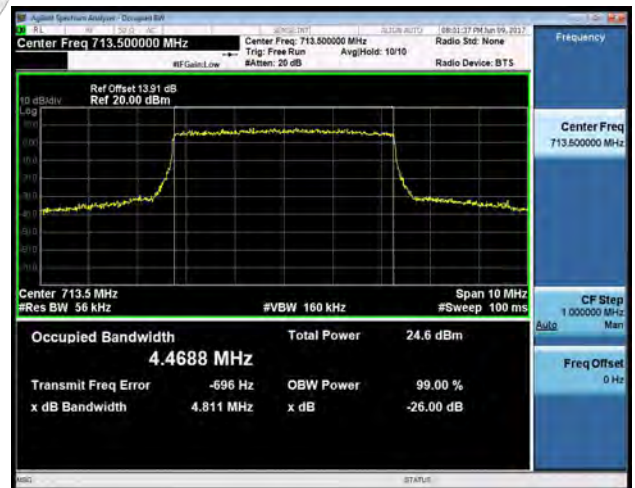

LTE band 17 - High CH 16QAM-5



LTE band 17 - Low CH QPSK-10



LTE band 17 - Low CH 16QAM-10



LTE band 17 - Middle CH QPSK-10



LTE band 17 - Middle CH 16QAM-10



LTE band 17 - High CH QPSK-10



LTE band 17 -High CH 16QAM-10

7. Spurious Emissions at Antenna Terminals

7.1. Test Standard and Limit

The mean power of emissions must be attenuated below the mean power of the unmodulated carrier (P) on any frequency outside the frequency band by at least $(43 + 10 \log P)$ dB, in this case, -13dBm.

7.2. Test Setup

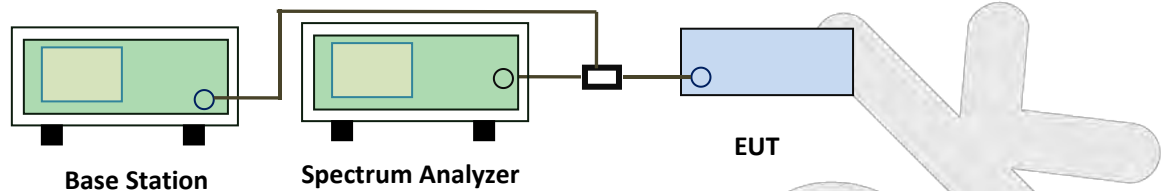

7.3. Test Procedure

The EUT was connected to Spectrum Analyzer and Base Station via power divider.
The Band Edges of low and high channels for the highest RF powers were measured.
Setting RBW as roughly $BW/100$.

7.4. Test Data

Test Plots

LTE BAND 2_LCH_1RB#0



LTE BAND 2_MCH_1RB#0



LTE BAND 2_HCH_1RB#0



LTE BAND 4_LCH_1RB#0



LTE BAND 4_MCH_1RB#0



LTE BAND 4_HCH_1RB#0



LTE BAND 5_LCH_1RB#0



LTE BAND 5_MCH_1RB#0



LTE BAND 5_HCH_1RB#0



LTE BAND 17_LCH_1RB#0



LTE BAND 17_MCH_1RB#0



LTE BAND 17_HCH_1RB#0



8. Spurious Radiated Emissions

8.1. Test Standard and Limit

The power of any emission outside of the authorized operating frequency ranges must be attenuated below the transmitter power (P) by a factor of at least $43 + 10 \log (P)$ dB. The spectrum is scanned from 30 MHz up to a frequency including its 10th harmonic.

8.2. Test Setup

For radiated test from 30MHz to 1GHz

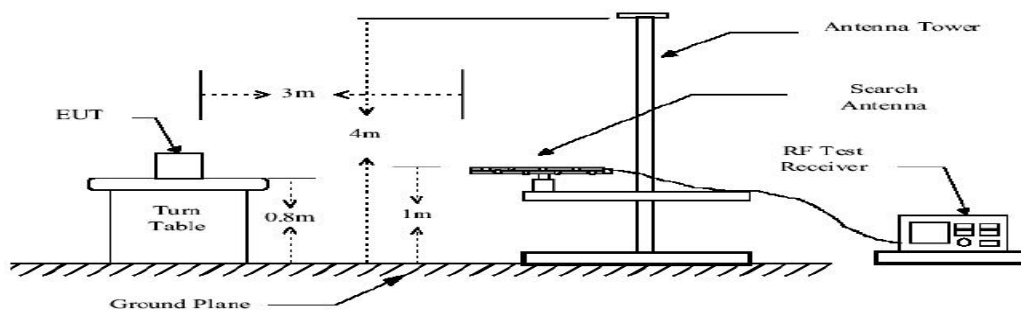

For radiated test from above 1GHz

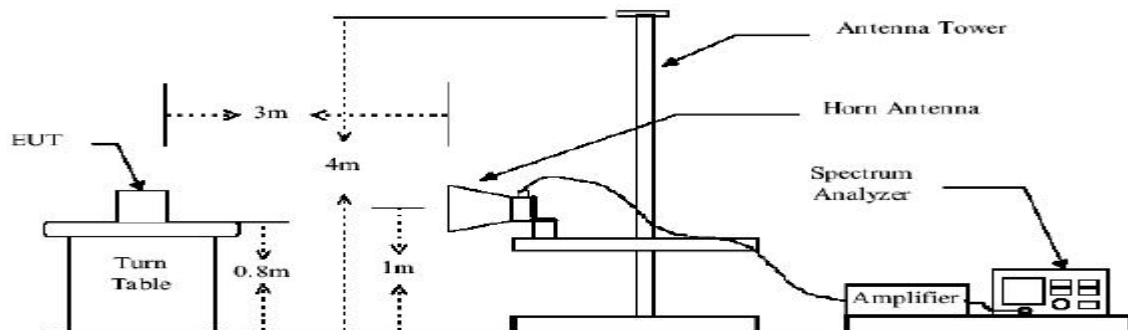

8.3. Test Procedure

1. The testing follows FCC KDB 971168 D01 Section 5.8 and ANSI/TIA-603-D-2010 – Section 2.2.12
2. RBW = 100kHz for emissions below 1GHz and 1MHz for emissions above 1GHz
3. VBW $\geq 3 \times$ RBW
4. Span = 1.5 times the OBW
5. No. of sweep points $> 2 \times$ span/RBW
6. Detector = Peak
7. Trace mode = max hold
8. The trace was allowed to stabilize

8.4. Test Data

Note: Test performed from 30MHz to 10th harmonics with low/middle/high channels, only the worst data were recorded.

LTE BAND 2						
Test Results for Channel 18607						
Frequency(MHz)	Power(dBm)	Antenna Gain (dBi)	Cable loss(dB)	PMea (dBm)	Limit (dBm)	Polarity
3701.4	-34.12	15.45	2.03	-20.7	-13.00	Horizontal
3701.4	-33.23	15.45	2.03	-19.81	-13.00	Vertical
5552.1	-35.34	19.63	2.51	-18.22	-13.00	Vertical
5552.1	-33.65	19.63	2.51	-16.53	-13.00	Horizontal
7402.8	-36.16	22.88	3.62	-16.9	-13.00	Horizontal
7402.8	-35.98	22.88	3.62	-16.72	-13.00	Vertical
Test Results for Channel 18900						
3760	-37.23	15.83	2.07	-23.47	-13.00	Horizontal
3760	-32.76	15.83	2.07	-19	-13.00	Vertical
5640	-41.87	20.32	2.76	-24.31	-13.00	Vertical
5640	-43.56	20.32	2.76	-26	-13.00	Horizontal
7520	-39.29	23.48	3.88	-19.69	-13.00	Horizontal
7520	-39.56	23.48	3.88	-19.96	-13.00	Vertical
Test Results for Channel 19193						
3818.6	-37.87	16.14	2.27	-24	-13.00	Horizontal
3818.6	-35.45	16.14	2.27	-21.58	-13.00	Vertical
5727.9	-36.34	20.43	2.77	-18.68	-13.00	Vertical
5727.9	-34.83	20.43	2.77	-17.17	-13.00	Horizontal
7637.2	-42.45	23.78	4.03	-22.7	-13.00	Horizontal
7637.2	-41.25	23.78	4.03	-21.5	-13.00	Vertical

NOTE:

1. All other emissions more than 30dB below the limit.
2. ALL mode were investigated. The results above show only the worst case

LTE BAND 4						
Test Results for Channel 19957						
Frequency(MHz)	Power(dBm)	Antenna Gain (dBi)	Cable loss(dB)	PMea (dBm)	Limit (dBm)	Polarity
3421.4	-35.45	14.12	1.91	-23.24	-13.00	Horizontal
3421.4	-36.45	14.12	1.91	-24.24	-13.00	Vertical
5132.1	-37.56	16.37	2.23	-23.42	-13.00	Vertical
5132.1	-36.85	16.37	2.23	-22.71	-13.00	Horizontal
6842.4	-38.67	21.35	3.24	-20.56	-13.00	Horizontal
6842.4	-37.86	21.35	3.24	-19.75	-13.00	Vertical
Test Results for Channel 20175						
3465	-38.76	14.31	1.92	-26.37	-13.00	Horizontal
3465	-39.23	14.31	1.92	-26.84	-13.00	Vertical
5197.5	-38.67	16.43	2.26	-24.5	-13.00	Vertical
5197.5	-40.04	16.43	2.26	-25.87	-13.00	Horizontal
6930	-39.87	21.48	3.26	-21.65	-13.00	Horizontal
6930	-39.12	21.48	3.26	-20.9	-13.00	Vertical
Test Results for Channel 20393						
3508.6	-37.65	14.36	2.27	-25.56	-13.00	Horizontal
3508.6	-36.78	14.36	2.27	-24.69	-13.00	Vertical
5262.9	-38.89	16.59	2.77	-25.07	-13.00	Vertical
5262.9	-35.87	16.59	2.77	-22.05	-13.00	Horizontal
7017.2	-43.45	21.62	3.32	-25.15	-13.00	Horizontal
7017.2	-44.27	21.62	3.32	-25.97	-13.00	Vertical

NOTE:

- 1.All other emissions more than 30dB below the limit.
- 2.ALL mode were investingated.The results above show only the worst case

LTE BAND 5						
Test Results for Channel 20407						
Frequency(MHz)	Power(dBm)	Antenna Gain (dBi)	Cable loss(dB)	PMea (dBm)	Limit (dBm)	Polarity
1649.4	-32.41	8.42	0.62	-24.61	-13.00	Vertical
1649.4	-33.23	8.42	0.62	-25.43	-13.00	Horizontal
2474.1	-32.54	12.0	1.0	-21.54	-13.00	Vertical
2474.1	-31.65	12.0	1.0	-20.65	-13.00	Horizontal
3298.8	-31.76	13.8	1.5	-19.46	-13.00	Horizontal
3298.8	-31.44	13.8	1.5	-19.14	-13.00	Vertical
Test Results for Channel 20525						
1673.0	-32.12	8.70	0.7	-24.12	-13.00	Vertical
1673.0	-32.17	8.70	0.7	-24.17	-13.00	Horizontal
2509.5	-34.24	12.2	1.0	-23.04	-13.00	Vertical
2509.5	-33.23	12.2	1.0	-22.03	-13.00	Horizontal
3346.0	-33.52	14.2	1.6	-20.92	-13.00	Horizontal
3346.0	-34.34	14.2	1.6	-21.74	-13.00	Vertical
Test Results for Channel 20643						
1696.6	-32.34	8.78	0.68	-24.24	-13.00	Vertical
1696.6	-33.23	8.78	0.68	-25.13	-13.00	Horizontal
2544.9	-34.12	12.69	1.0	-22.43	-13.00	Vertical
2544.9	-33.29	12.69	1.0	-21.6	-13.00	Horizontal
3393.2	-33.58	14.52	1.6	-20.66	-13.00	Horizontal
3393.2	-34.56	14.52	1.6	-21.64	-13.00	Vertical

NOTE:

1. All other emissions more than 30dB below the limit.
2. ALL mode were investigated. The results above show only the worst case

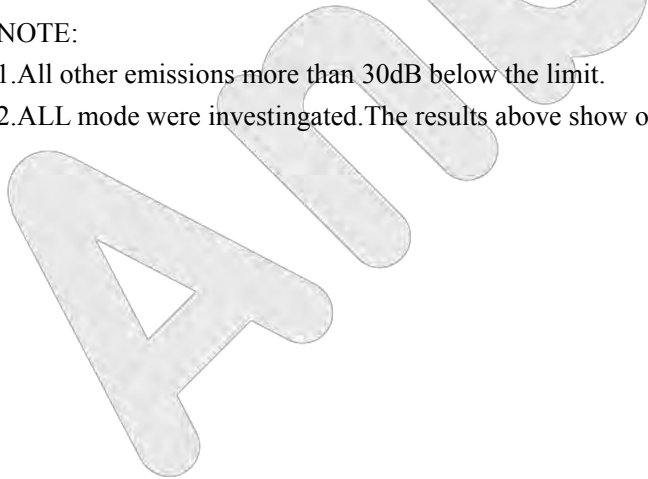

LTE BAND 17						
Test Results for Channel 23755						
Frequency(MHz)	Power(dBm)	Antenna Gain (dBi)	Cable loss(dB)	PMea (dBm)	Limit (dBm)	Polarity
1413.0	-33.23	7.42	0.51	-26.32	-13.00	Vertical
1413.0	-32.75	7.42	0.51	-25.84	-13.00	Horizontal
2119.5	-33.45	10.96	0.87	-23.36	-13.00	Vertical
2119.5	-34.03	10.96	0.87	-23.94	-13.00	Horizontal
2826.0	-32.54	12.38	1.35	-21.51	-13.00	Horizontal
2826.0	-33.76	12.38	1.35	-22.73	-13.00	Vertical
Test Results for Channel 23790						
1420.0	-33.52	7.42	0.57	-26.67	-13.00	Vertical
1420.0	-34.65	7.42	0.57	-27.8	-13.00	Horizontal
2130.0	-34.56	10.96	0.88	-24.48	-13.00	Vertical
2130.0	-35.87	10.96	0.88	-25.79	-13.00	Horizontal
2840.0	-34.53	12.4	1.36	-23.49	-13.00	Horizontal
2840.0	-34.52	12.4	1.36	-23.48	-13.00	Vertical
Test Results for Channel 23825						
1427.0	-33.35	7.42	0.68	-26.61	-13.00	Vertical
1427.0	-34.56	7.42	0.68	-27.82	-13.00	Horizontal
2140.5	-33.95	10.98	0.9	-23.87	-13.00	Vertical
2140.5	-34.24	10.98	0.9	-24.16	-13.00	Horizontal
2854.0	-35.34	12.43	1.38	-24.29	-13.00	Horizontal
2854.0	-36.51	12.43	1.38	-25.46	-13.00	Vertical

NOTE:

1. All other emissions more than 30dB below the limit.
2. ALL mode were investigated. The results above show only the worst case

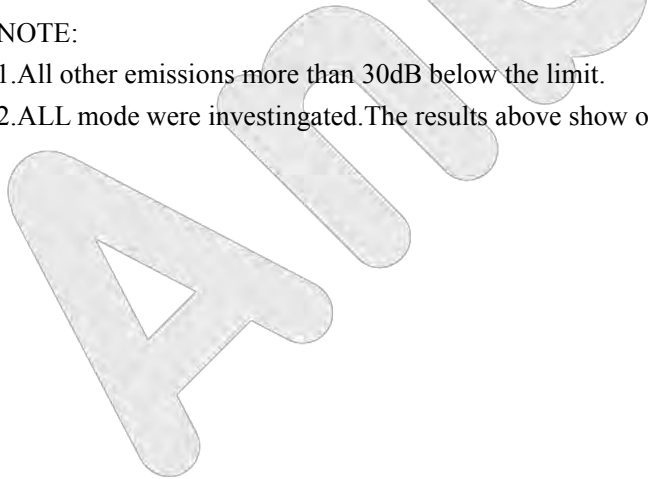

9. Band Edge Compliance

9.1. Test Standard and Limit

The power of any emission outside of the authorized operating frequency ranges must be lower than the transmitter power (P) by a factor of at least $43 + 10 \log (P)$ dB.

9.2. Test Setup

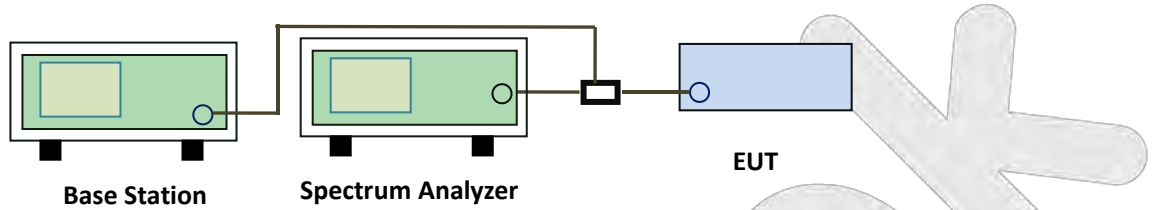

9.3. Test Procedure

The EUT was connected to Spectrum Analyzer and Base Station via power divider.

The Band Edges of low and high channels for the highest RF powers were measured. Setting RBW as roughly BW/100.

9.4. Test Data

All the modulation modes and Channels have been tested, the data of the worst mode are recorded in the following page

LTE Band 2

Channel Bandwidth: 1.4 MHz

(Channel Bandwidth: 1.4 MHz)_LCH_QPSK_6RB#0

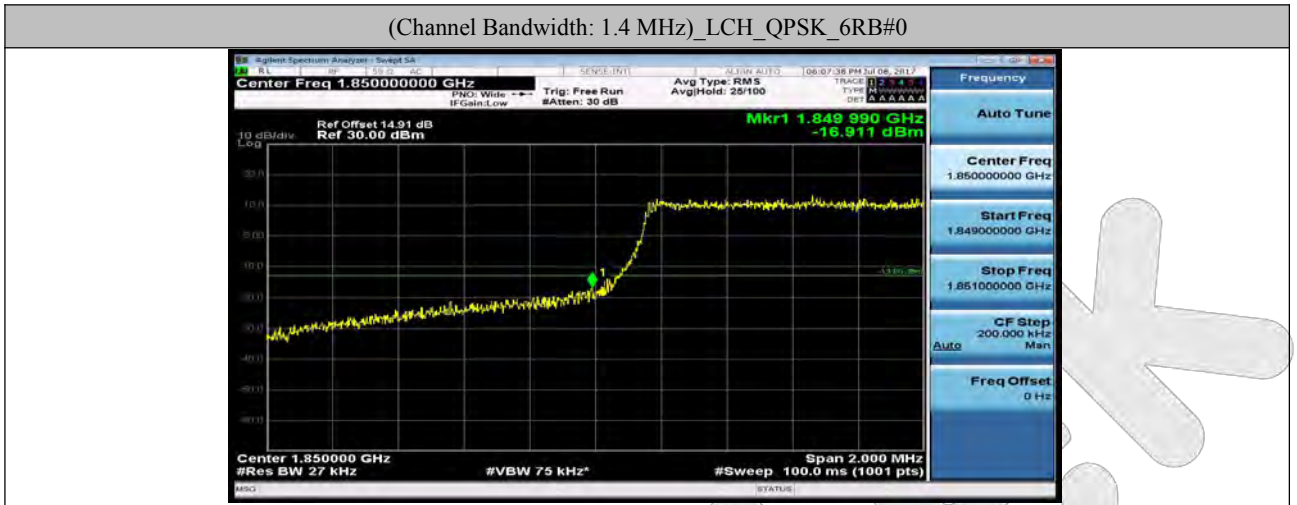

(Channel Bandwidth: 1.4 MHz)_HCH_QPSK_6RB#0



(Channel Bandwidth: 1.4 MHz)_LCH_16QAM_6RB#0

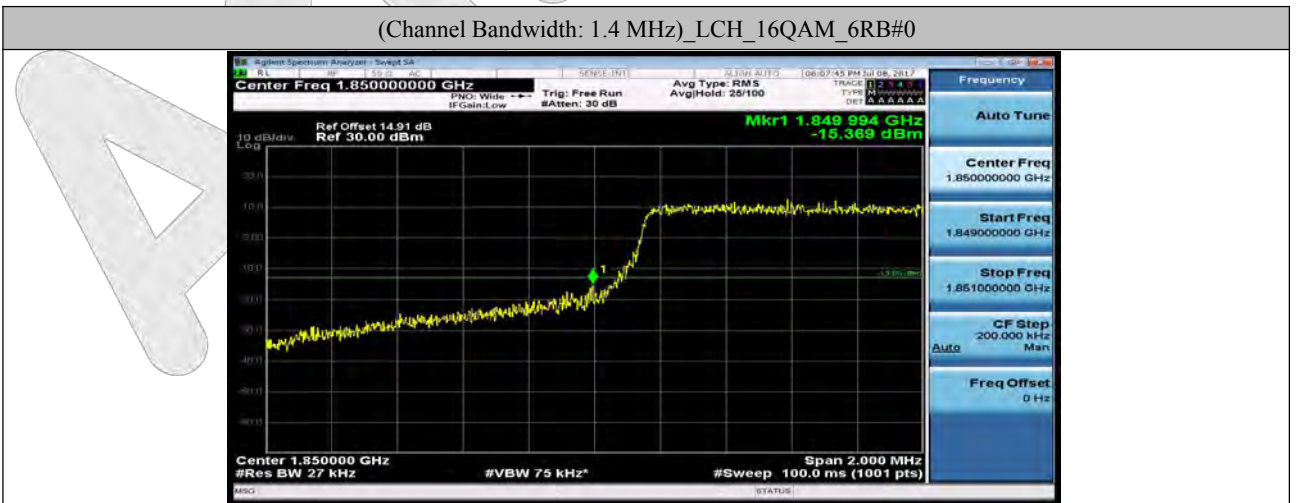

(Channel Bandwidth: 1.4 MHz)_HCH_16QAM_6RB#0



Channel Bandwidth: 3 MHz

(Channel Bandwidth: 3 MHz)_LCH_QPSK_15RB#0



(Channel Bandwidth: 3 MHz)_HCH_QPSK_15RB#0



(Channel Bandwidth: 3 MHz)_LCH_16QAM_15RB#0

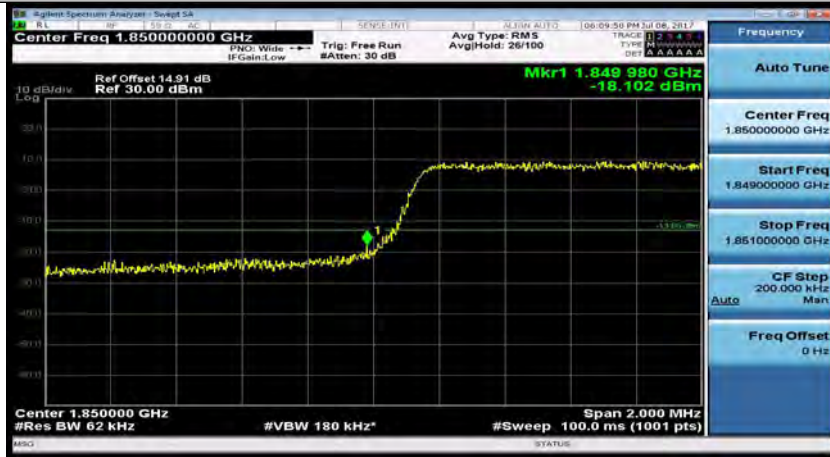

(Channel Bandwidth: 3 MHz)_HCH_16QAM_15RB#0

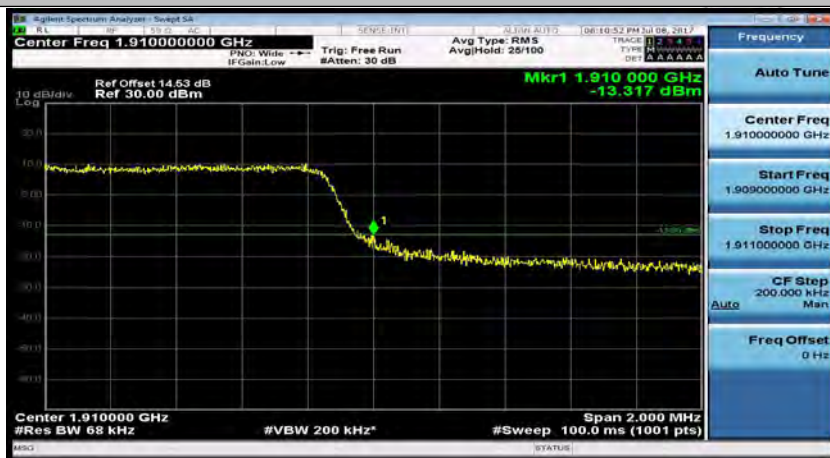

Channel Bandwidth: 5 MHz

(Channel Bandwidth: 5 MHz)_LCH_QPSK_25RB#0



(Channel Bandwidth: 5 MHz)_HCH_QPSK_25RB#0



(Channel Bandwidth: 5 MHz)_LCH_16QAM_25RB#0

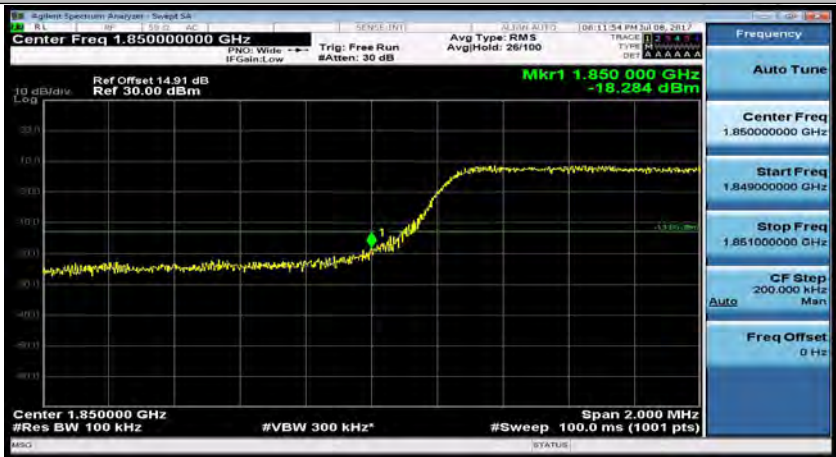

(Channel Bandwidth: 5 MHz)_HCH_16QAM_25RB#0

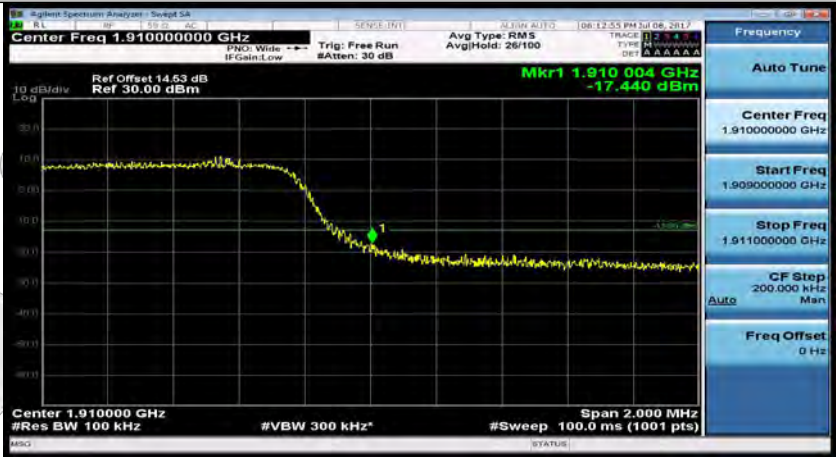

Channel Bandwidth: 10 MHz

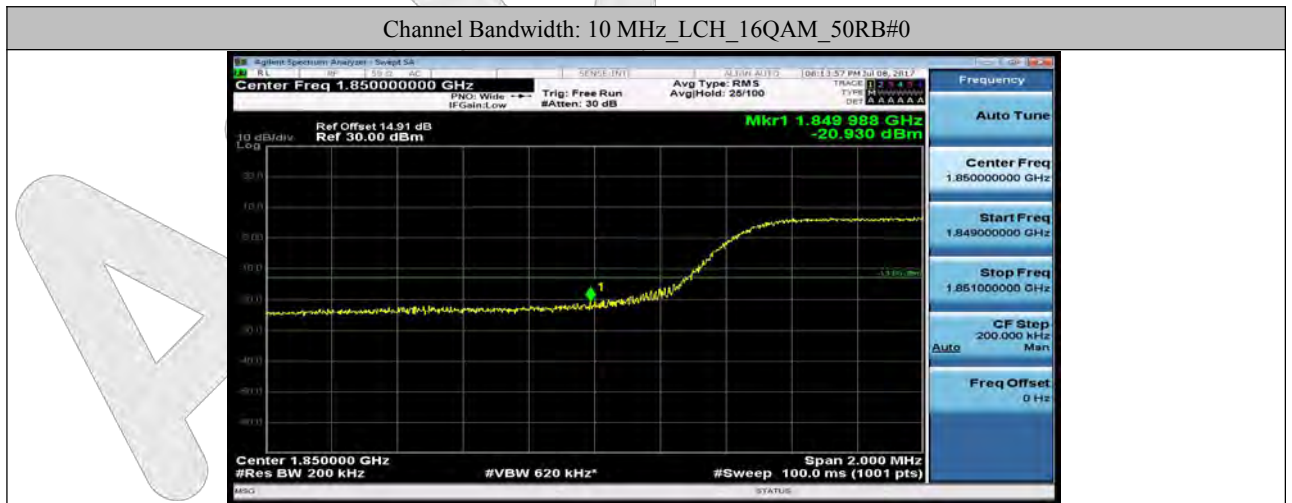
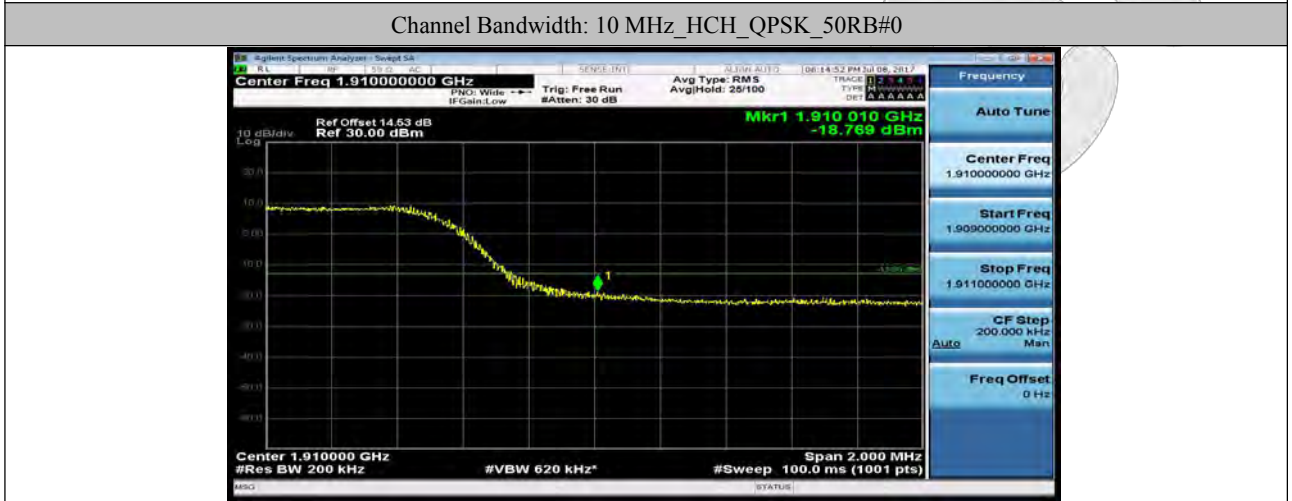
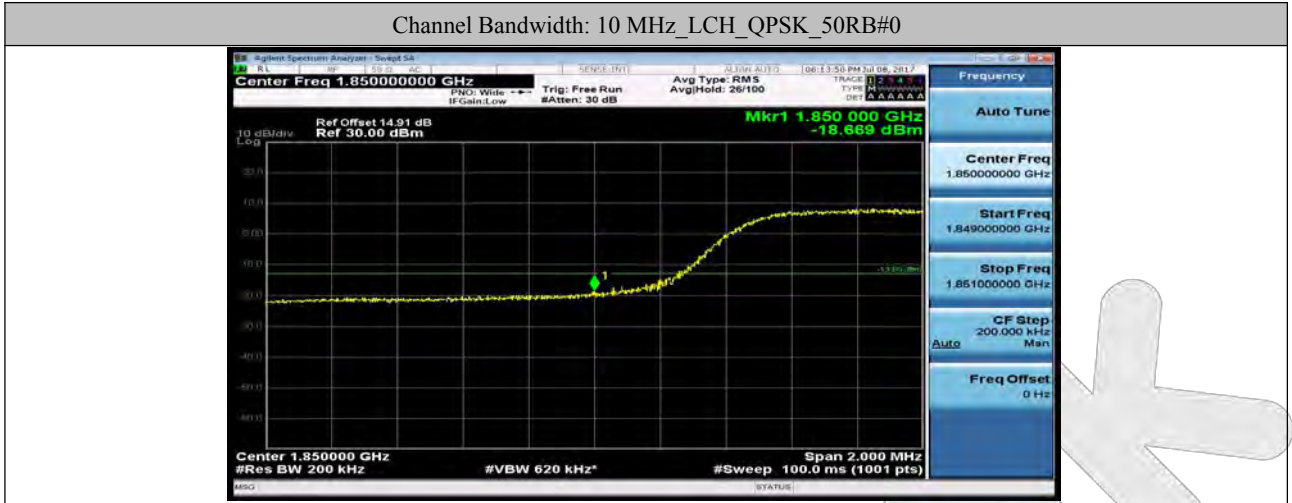

Channel Bandwidth: 10 MHz_HCH_16QAM_50RB#0



Channel Bandwidth: 15 MHz

(Channel Bandwidth:15 MHz)_LCH_QPSK_75RB#0



(Channel Bandwidth:15 MHz)_HCH_QPSK_75RB#0

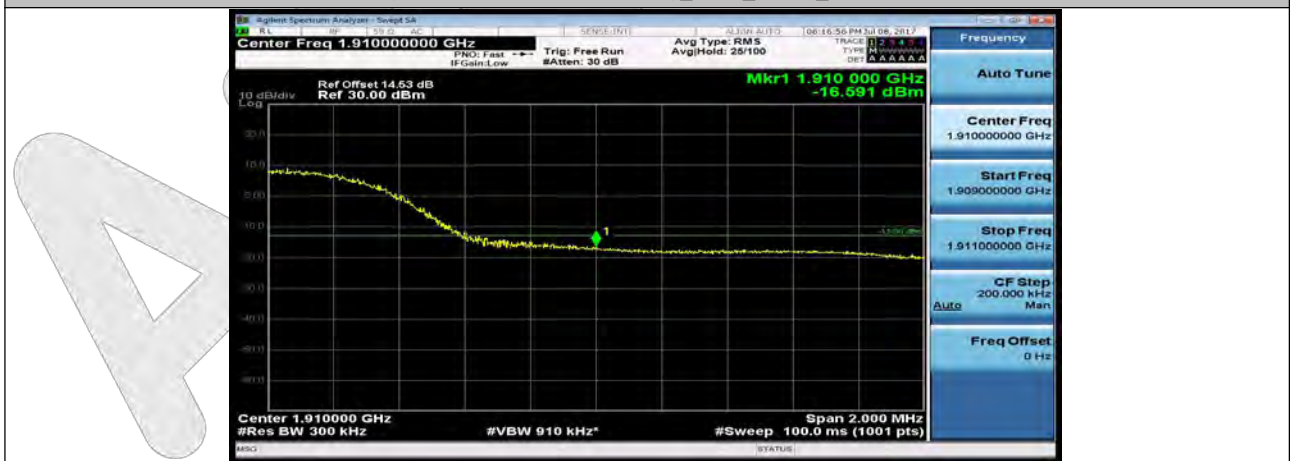

(Channel Bandwidth:15 MHz)_LCH_16QAM_75RB#0



(Channel Bandwidth:15 MHz)_HCH_16QAM_75RB#0

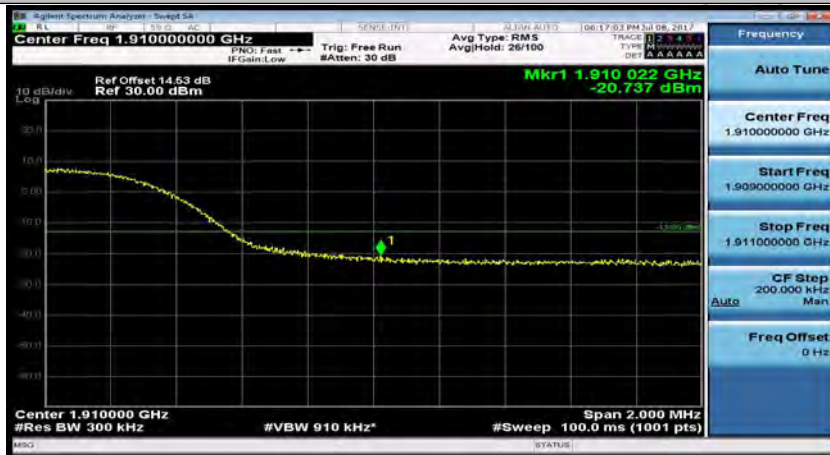

Channel Bandwidth: 20 MHz

(Channel Bandwidth:20 MHz)_LCH_QPSK_100RB#0



(Channel Bandwidth:20 MHz)_HCH_QPSK_100RB#0

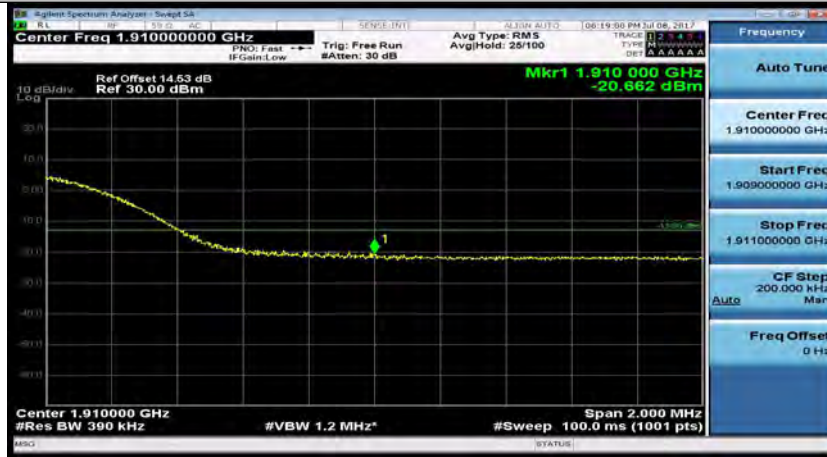

(Channel Bandwidth:20 MHz)_LCH_16QAM_100RB#0



(Channel Bandwidth:20 MHz)_HCH_16QAM_100RB#0

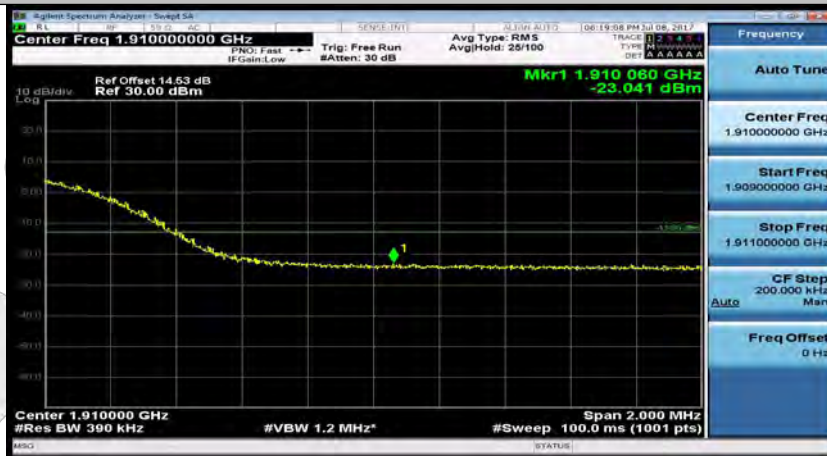

LTE BAND 4

Channel Bandwidth: 1.4 MHz

(Channel Bandwidth: 1.4 MHz)_LCH_QPSK_6RB#0

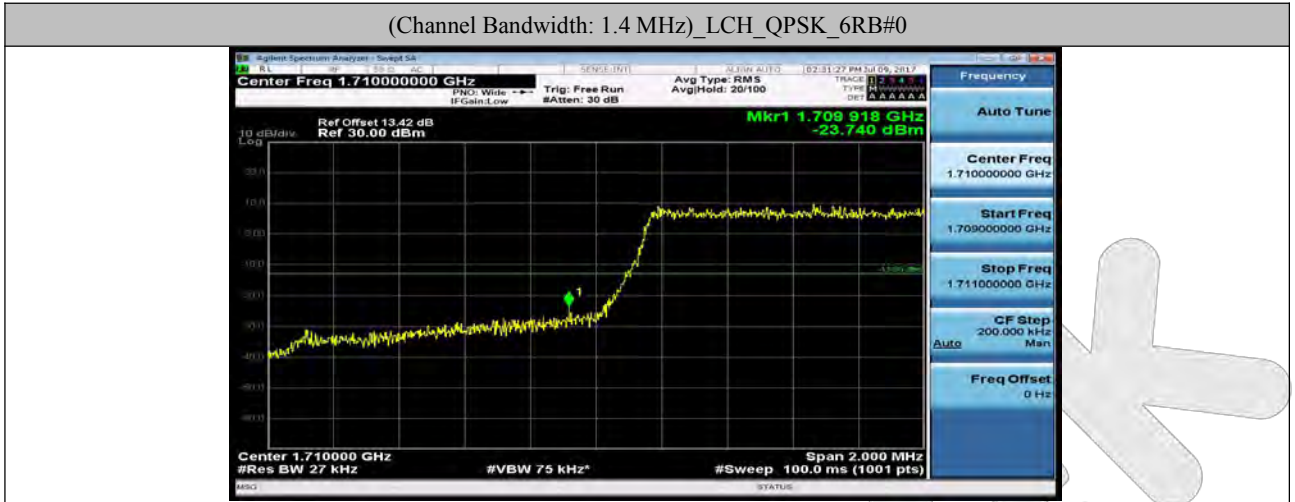

(Channel Bandwidth: 1.4 MHz)_HCH_QPSK_6RB#0



(Channel Bandwidth: 1.4 MHz)_LCH_16QAM_6RB#0

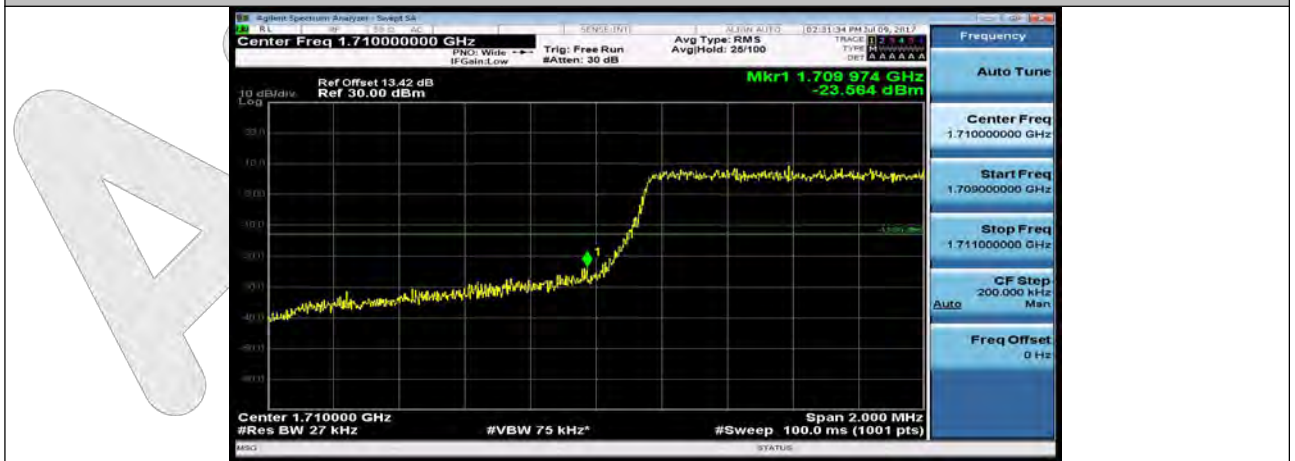

(Channel Bandwidth: 1.4 MHz)_HCH_16QAM_6RB#0



Channel Bandwidth: 3 MHz

(Channel Bandwidth: 3 MHz)_LCH_QPSK_15RB#0

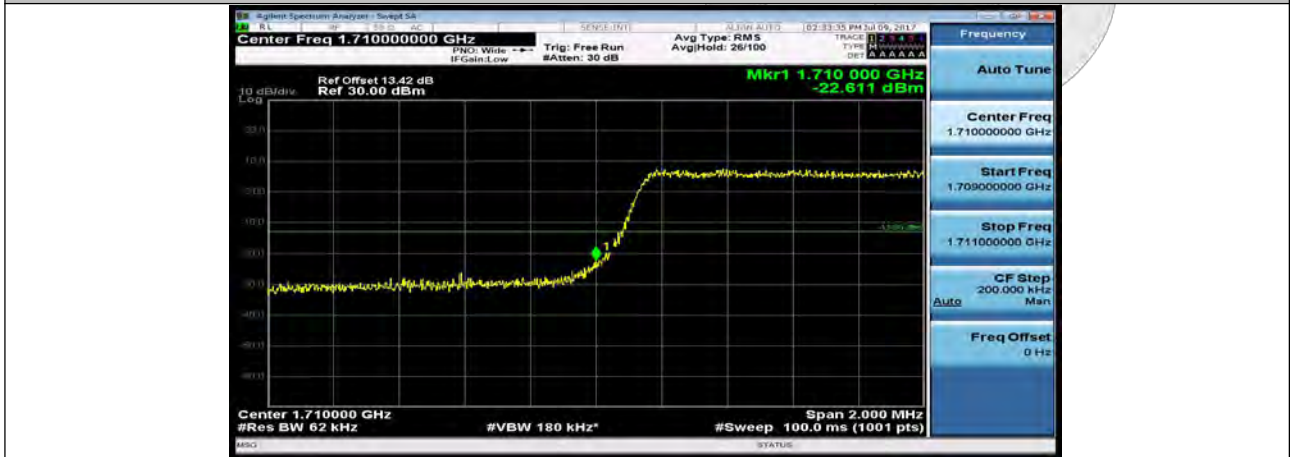

(Channel Bandwidth: 3 MHz)_HCH_QPSK_15RB#0



(Channel Bandwidth: 3 MHz)_LCH_16QAM_15RB#0

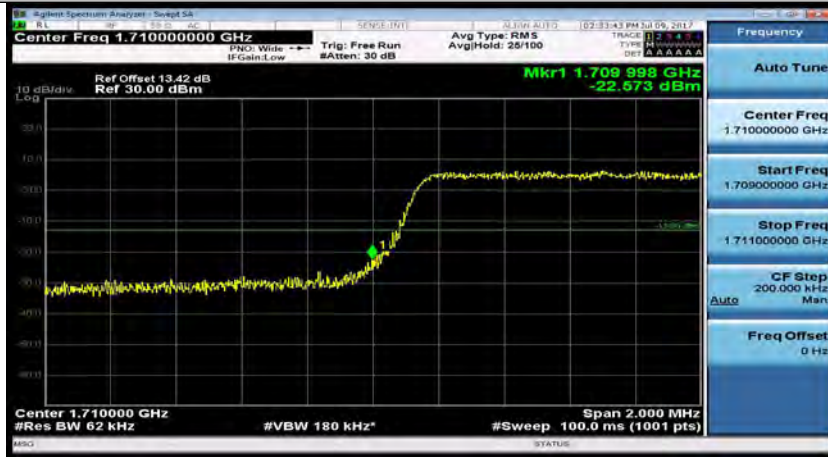

(Channel Bandwidth: 3 MHz)_HCH_16QAM_15RB#0

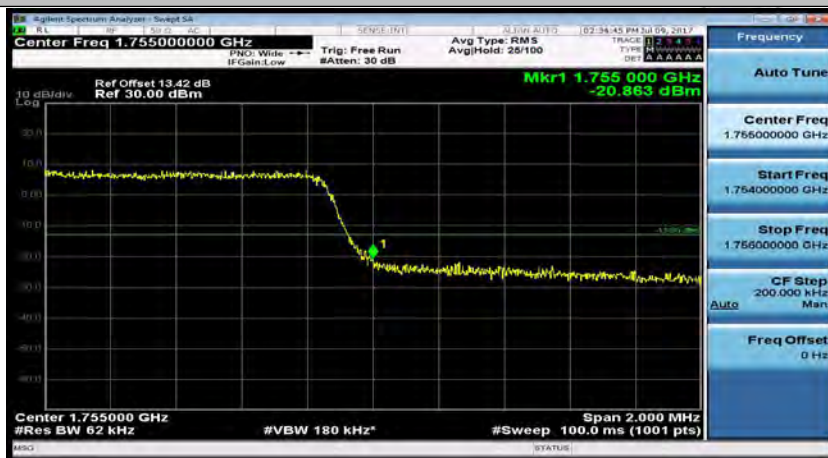

Channel Bandwidth: 5 MHz

(Channel Bandwidth: 5 MHz)_LCH_QPSK_25RB#0

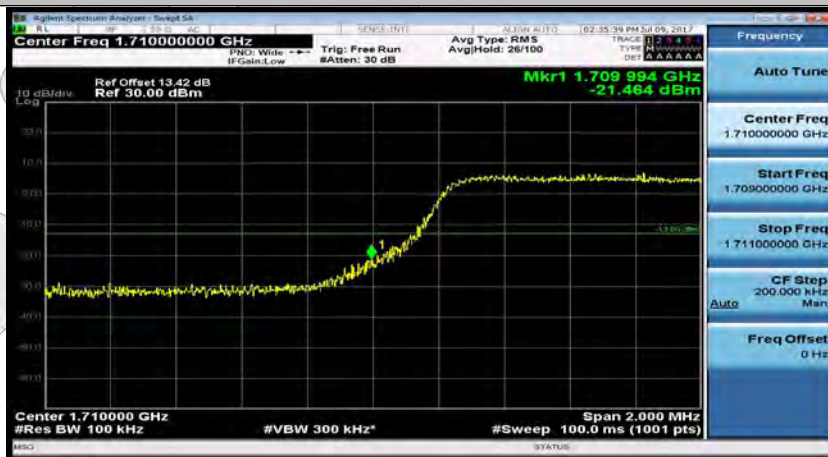

(Channel Bandwidth: 5 MHz)_HCH_QPSK_25RB#0



(Channel Bandwidth: 5 MHz)_LCH_16QAM_25RB#0

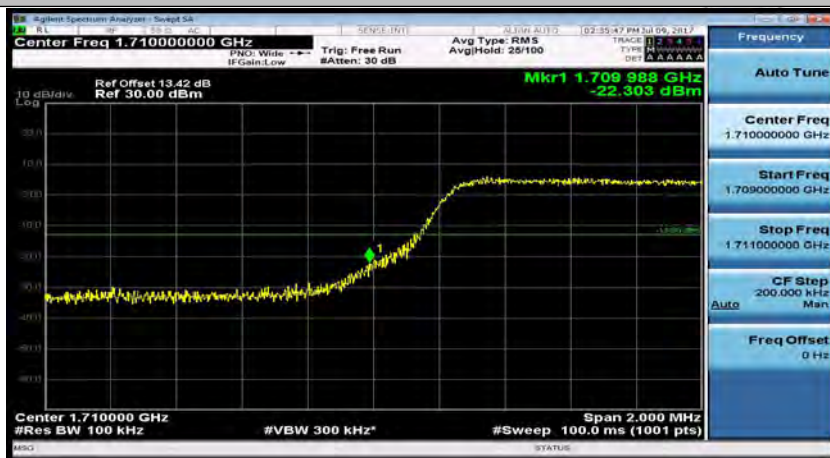

(Channel Bandwidth: 5 MHz)_HCH_16QAM_25RB#0

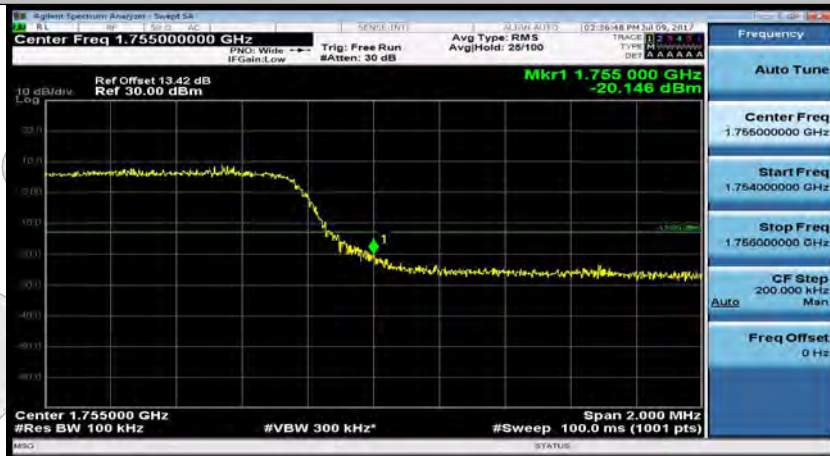

Channel Bandwidth: 10 MHz

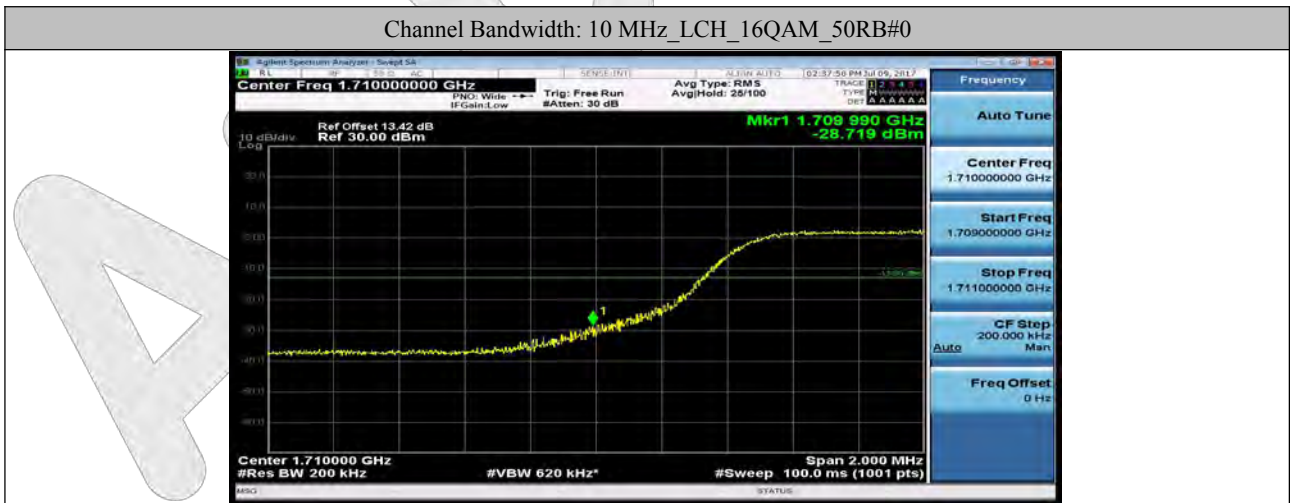
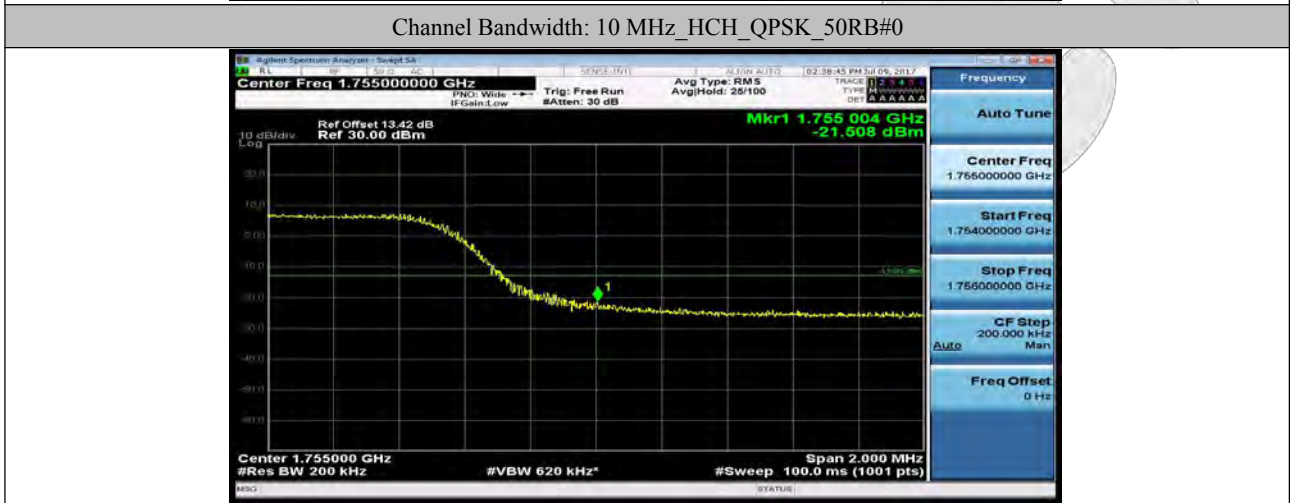
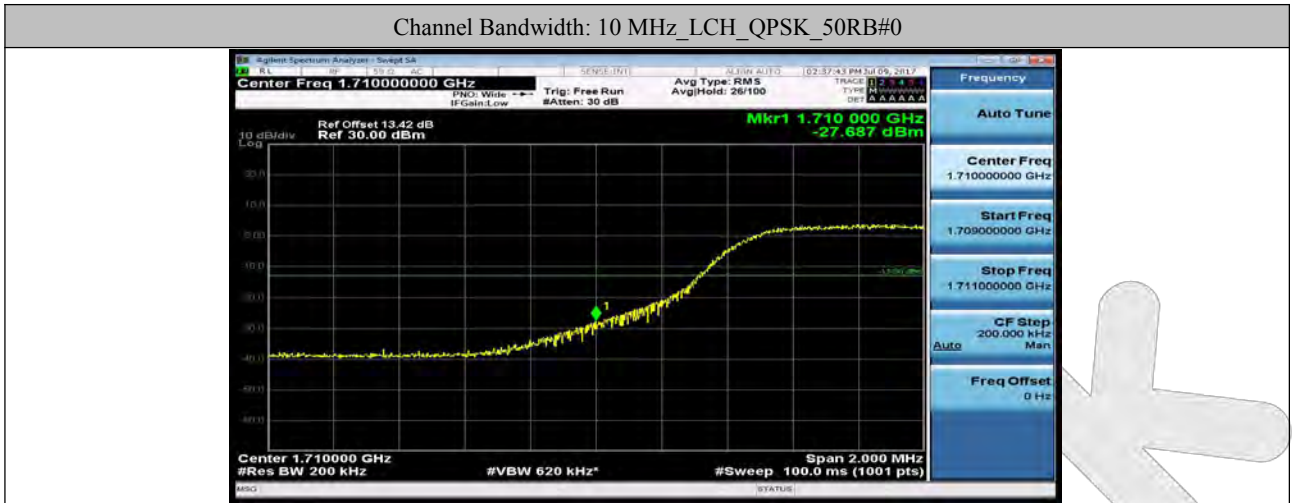

Channel Bandwidth: 10 MHz_HCH_16QAM_50RB#0

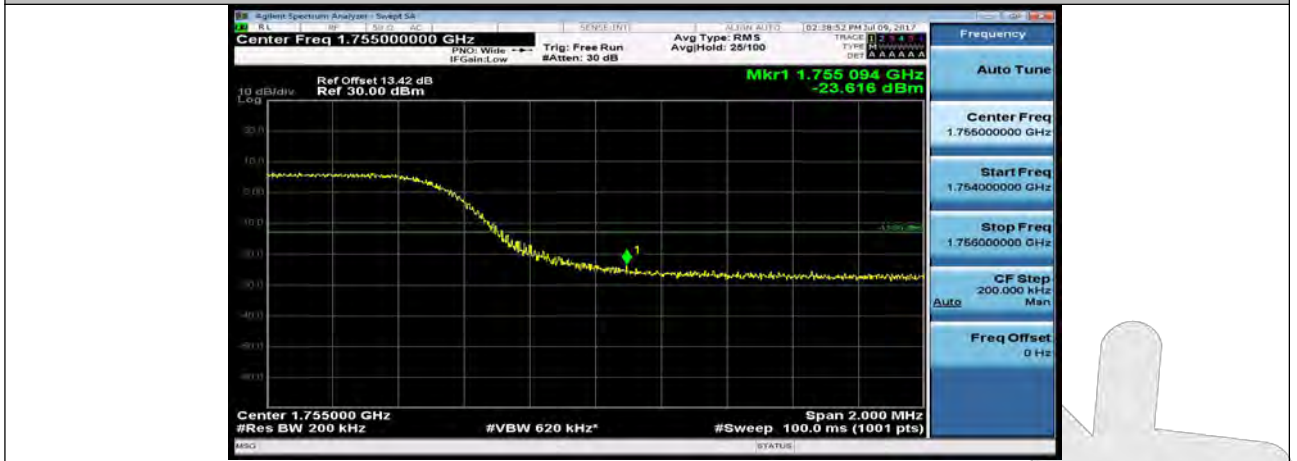

Channel Bandwidth: 15 MHz

(Channel Bandwidth:15 MHz)_LCH_QPSK_75RB#0



(Channel Bandwidth:15 MHz)_HCH_QPSK_75RB#0



(Channel Bandwidth:15 MHz)_LCH_16QAM_75RB#0



(Channel Bandwidth:15 MHz)_HCH_16QAM_75RB#0

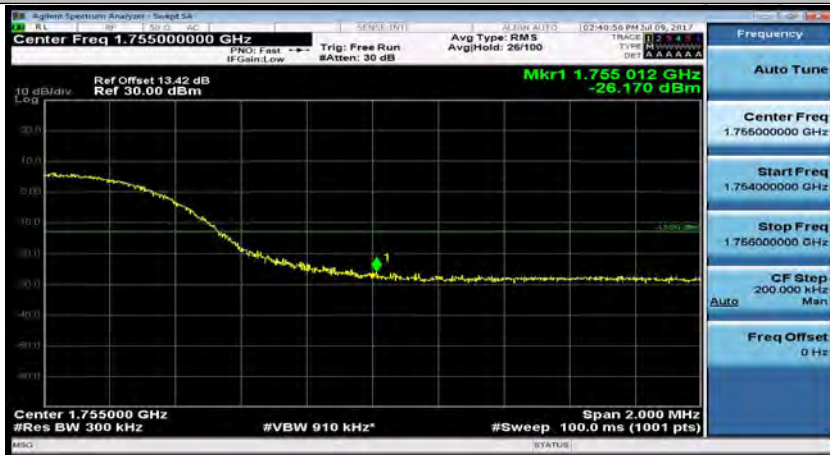

Channel Bandwidth: 20 MHz

(Channel Bandwidth:20 MHz)_LCH_QPSK_100RB#0

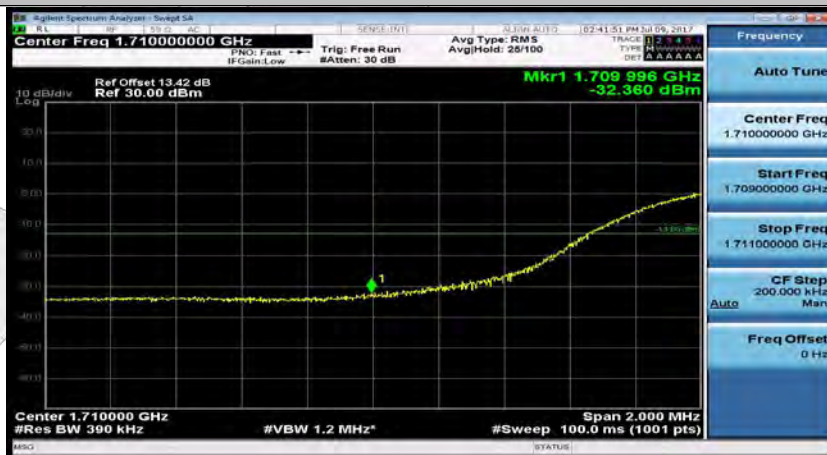

(Channel Bandwidth:20 MHz)_HCH_QPSK_100RB#0

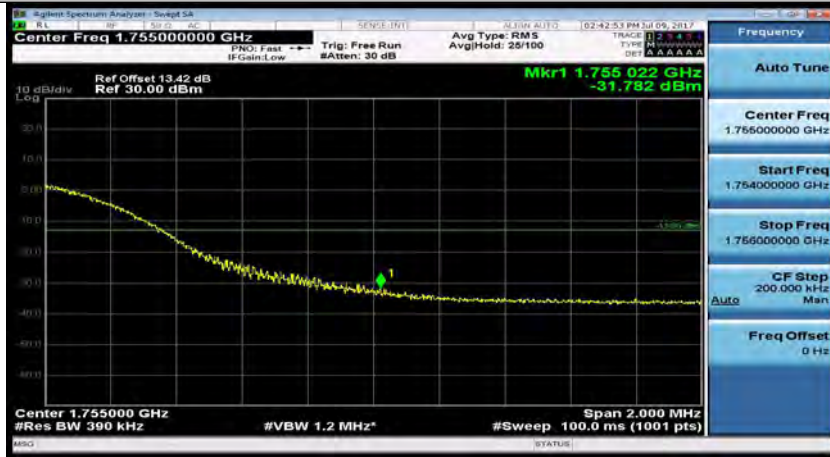

(Channel Bandwidth:20 MHz)_LCH_16QAM_100RB#0

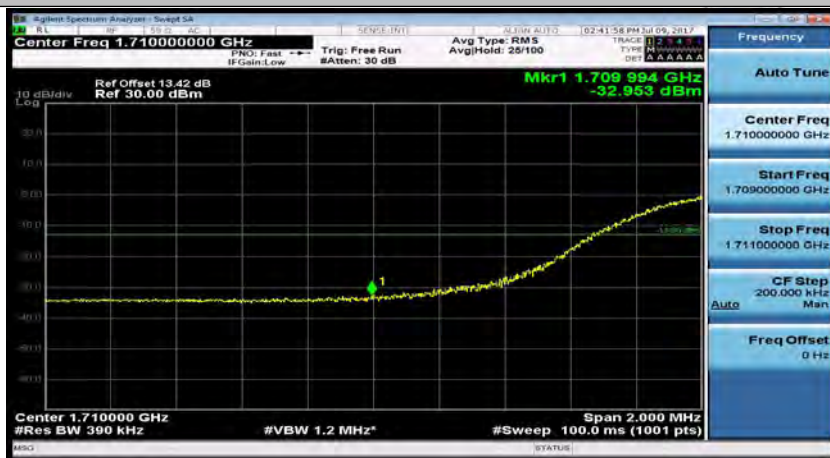

(Channel Bandwidth:20 MHz)_HCH_16QAM_100RB#0

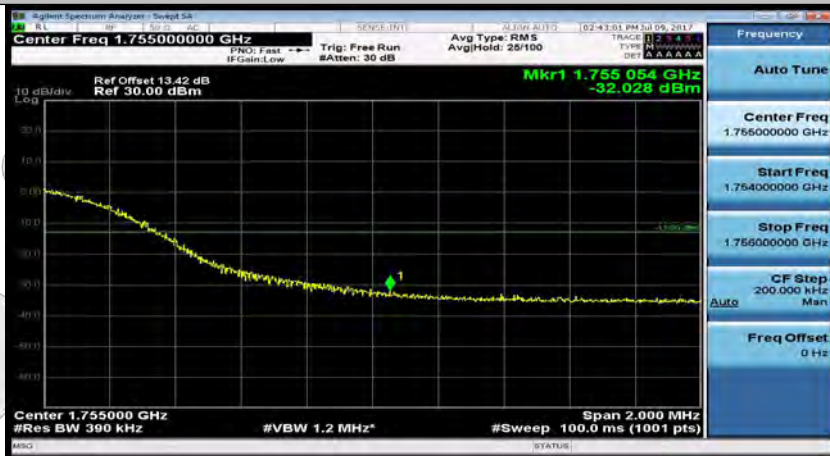

LTE BAND 5

Channel Bandwidth: 1.4 MHz

(Channel Bandwidth: 1.4 MHz)_LCH_QPSK_6RB#0

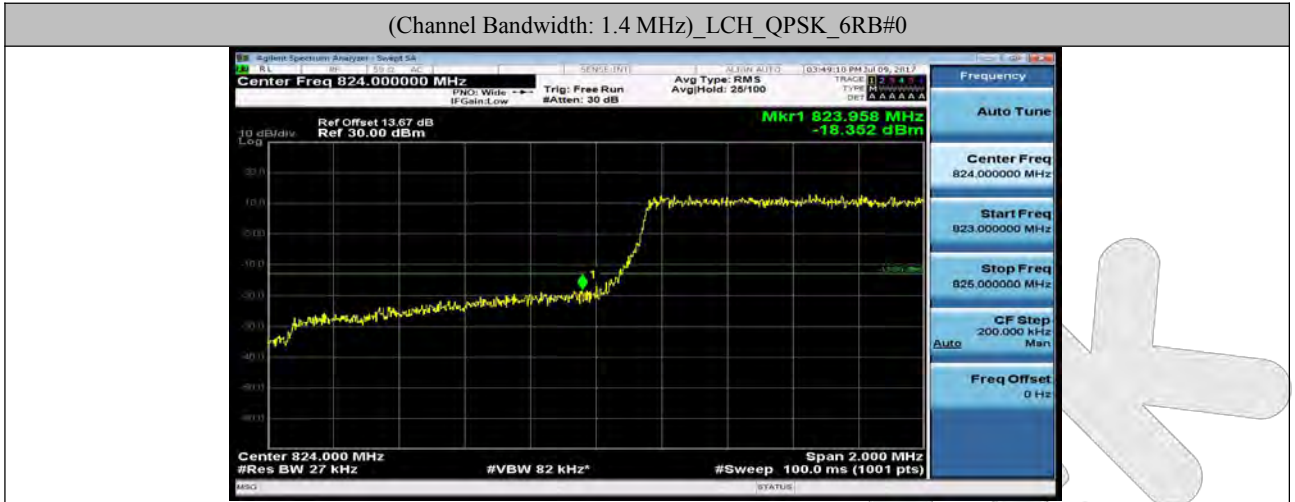

(Channel Bandwidth: 1.4 MHz)_HCH_QPSK_6RB#0



(Channel Bandwidth: 1.4 MHz)_LCH_16QAM_6RB#0

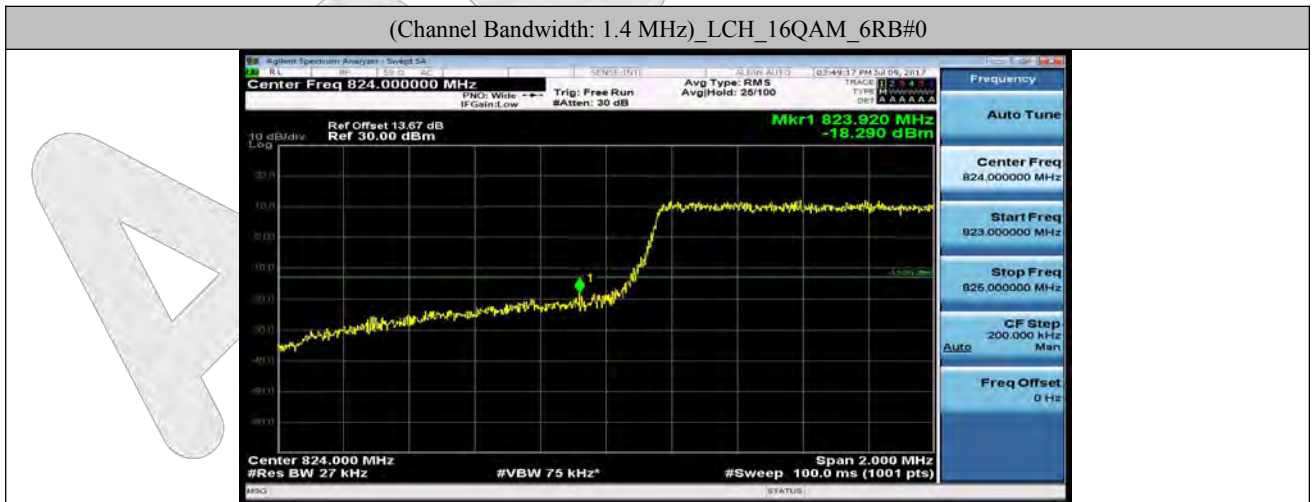

(Channel Bandwidth: 1.4 MHz)_HCH_16QAM_6RB#0



Channel Bandwidth: 3 MHz

(Channel Bandwidth: 3 MHz)_LCH_QPSK_15RB#0

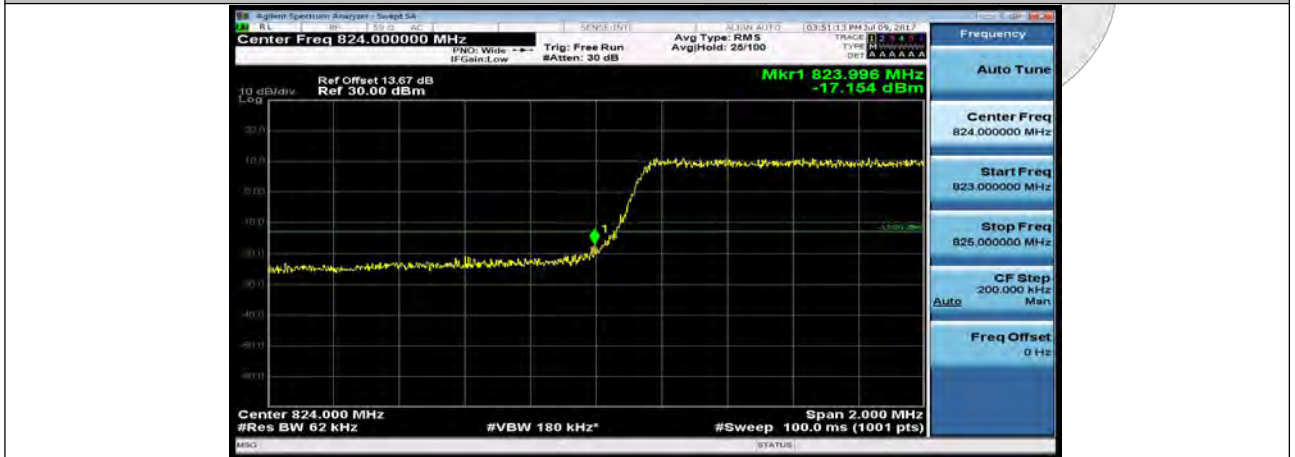

(Channel Bandwidth: 3 MHz)_HCH_QPSK_15RB#0



(Channel Bandwidth: 3 MHz)_LCH_16QAM_15RB#0



(Channel Bandwidth: 3 MHz)_HCH_16QAM_15RB#0

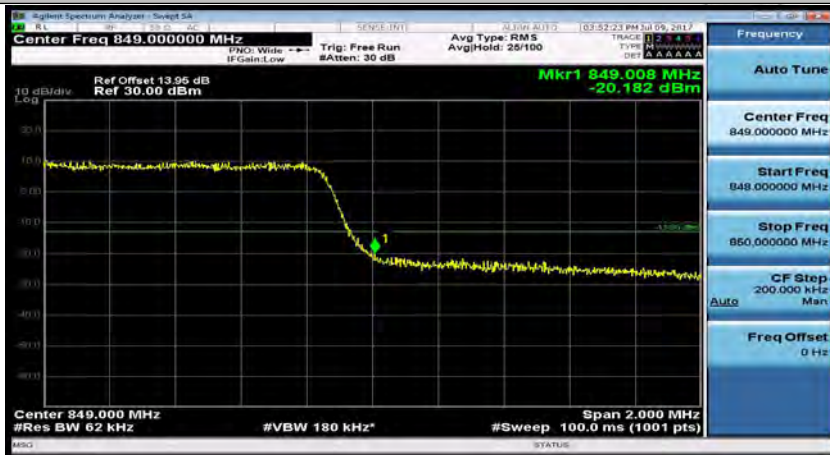

Channel Bandwidth: 5 MHz

(Channel Bandwidth: 5 MHz)_LCH_QPSK_25RB#0

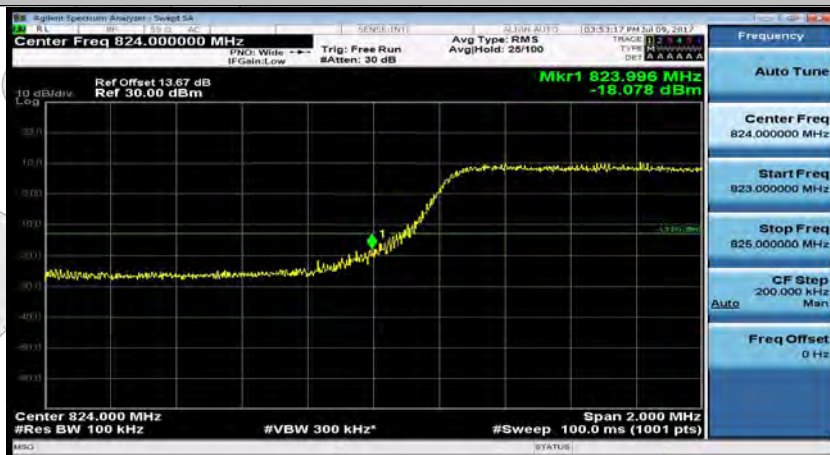

(Channel Bandwidth: 5 MHz)_HCH_QPSK_25RB#0



(Channel Bandwidth: 5 MHz)_LCH_16QAM_25RB#0



(Channel Bandwidth: 5 MHz)_HCH_16QAM_25RB#0



Channel Bandwidth: 10 MHz

Channel Bandwidth: 10 MHz_LCH_QPSK_50RB#0



Channel Bandwidth: 10 MHz_HCH_QPSK_50RB#0



Channel Bandwidth: 10 MHz_LCH_16QAM_50RB#0



Channel Bandwidth: 10 MHz_HCH_16QAM_50RB#0



LTE Band 17

Channel Bandwidth: 5 MHz

(Channel Bandwidth: 5 MHz)_LCH_QPSK_25RB#0

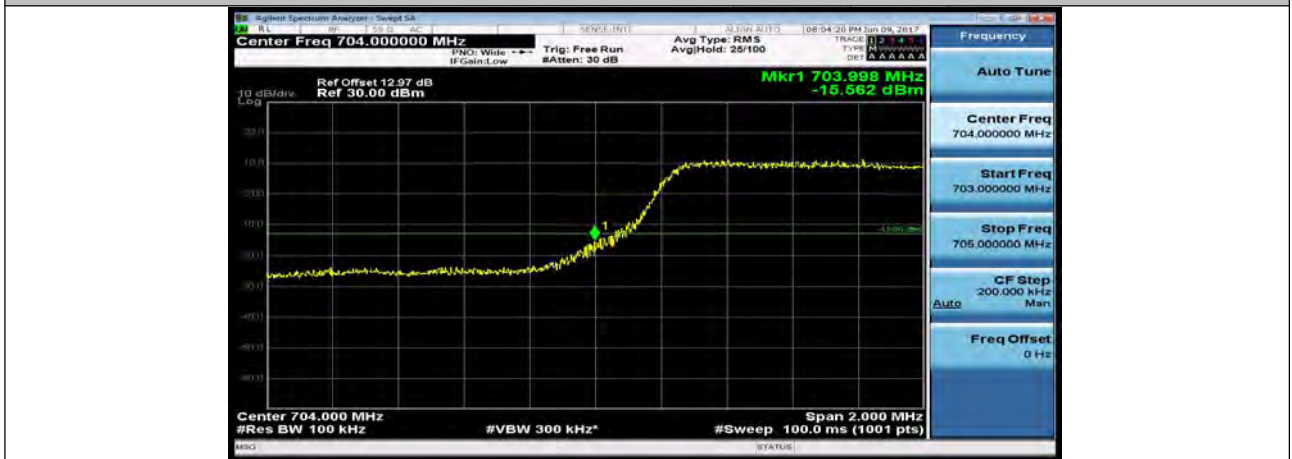

(Channel Bandwidth: 5 MHz)_HCH_QPSK_25RB#0

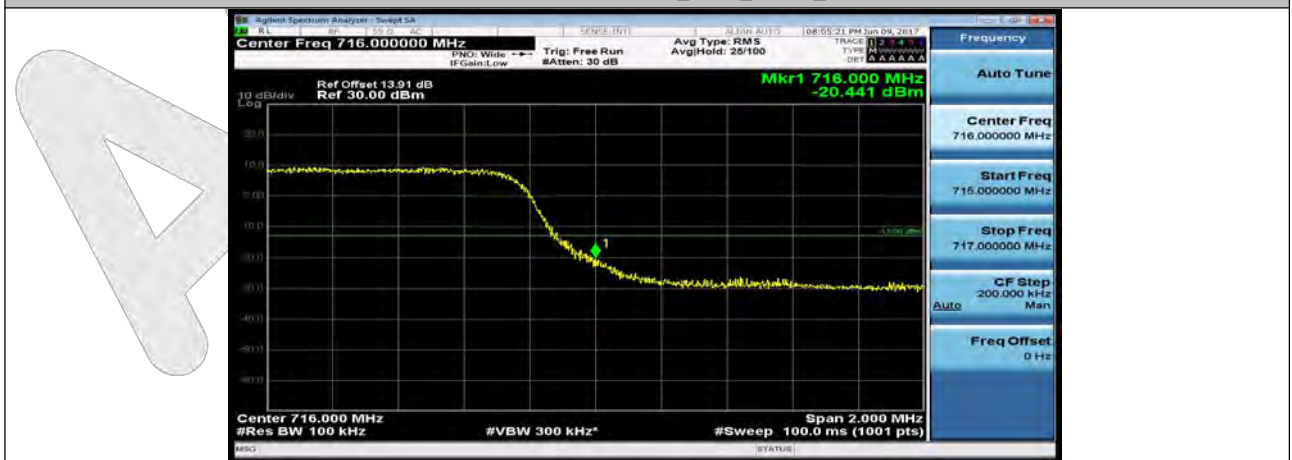

(Channel Bandwidth: 5 MHz)_LCH_16QAM_25RB#0



(Channel Bandwidth: 5 MHz)_HCH_16QAM_25RB#0



Channel Bandwidth: 10 MHz

Channel Bandwidth: 10 MHz_LCH_QPSK_50RB#0



Channel Bandwidth: 10 MHz_HCH_QPSK_50RB#0

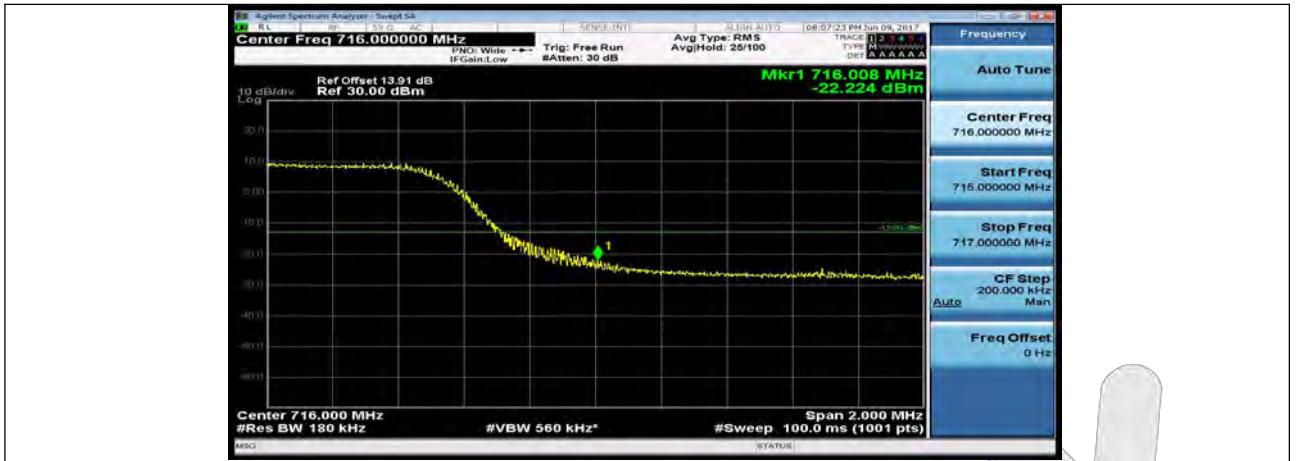

Channel Bandwidth: 10 MHz_LCH_16QAM_50RB#0



Channel Bandwidth: 10 MHz_HCH_16QAM_50RB#0



10. Frequency Stability

10.1. Test Standard and Limit

According to §22.355, the carrier frequency of each transmitter in the Public Mobile Services must be maintained within the tolerances given in Table below:

Frequency Tolerance for Transmitters in the Public Mobile Services

Frequency Range (MHz)	Base, fixed (ppm)	Mobile ≤ 3 watts (ppm)	Mobile ≤ 3 watts (ppm)
25 to 50	20.0	20.0	50.0
50 to 450	5.0	5.0	50.0
450 to 512	2.5	5.0	5.0
821 to 896	1.5	2.5	2.5
928 to 29.	.0	N/A	N/A
929 to 960.	1.5	N/A	N/A
2110 to 2220	10.0	N/A	N/A

According to §24.235, the frequency stability shall be sufficient to ensure that the fundamental emissions stay within the authorized frequency block.

10.2. Test Setup

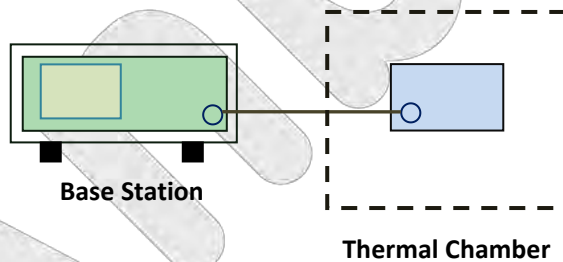

10.3. Test Procedure

A communication link was established between EUT and base station. The frequency error was monitored and measured by base station under variation of ambient temperature and variation of primary supply voltage.

Limit: The frequency stability of the transmitter shall be maintained within $\pm 0.00025\%$ ($\pm 2.5\text{ppm}$) of the center frequency.

10.4. Test Data

LTE BAND 2

Voltage							
Modulation	Channel	Voltage [Vdc]	Temperature (°C)	Deviation (Hz)	Deviation (ppm)	Limit (ppm)	Verdict
QPSK	MCH	VL	TN	-3.35	-0.001781	± 2.5	PASS
		VN	TN	3.59	0.001910	± 2.5	PASS
		VH	TN	5.06	0.002694	± 2.5	PASS
16QAM	MCH	VL	TN	5.95	0.003165	± 2.5	PASS
		VN	TN	-10.00	-0.005319	± 2.5	PASS
		VH	TN	22.92	0.012212	± 2.5	PASS
Temperature							
Modulation	Channel	Voltage [Vdc]	Temperature (°C)	Deviation (Hz)	Deviation (ppm)	Limit (ppm)	Verdict
QPSK	MCH	VN	-30	3.56	0.001895	± 2.5	PASS
		VN	-20	3.89	0.002070	± 2.5	PASS
		VN	-10	4.72	0.002511	± 2.5	PASS
		VN	0	23.00	0.012235	± 2.5	PASS
		VN	10	3.98	0.002115	± 2.5	PASS
		VN	20	4.82	0.002564	± 2.5	PASS
		VN	30	-16.71	-0.008887	± 2.5	PASS
		VN	40	4.82	0.002564	± 2.5	PASS
		VN	50	5.47	0.002907	± 2.5	PASS
16QAM	MCH	VN	-30	3.63	0.001933	± 2.5	PASS
		VN	-20	0.79	0.000419	± 2.5	PASS
		VN	-10	4.95	0.002633	± 2.5	PASS
		VN	0	2.66	0.001415	± 2.5	PASS
		VN	10	-13.62	-0.007244	± 2.5	PASS
		VN	20	25.75	0.013696	± 2.5	PASS
		VN	30	-9.23	-0.004908	± 2.5	PASS
		VN	40	4.84	0.002572	± 2.5	PASS
		VN	50	-1.69	-0.000898	± 2.5	PASS



LTE BAND 4

Voltage							
Modulation	Channel	Voltage [Vdc]	Temperature (°C)	Deviation (Hz)	Deviation (ppm)	Limit (ppm)	Verdict
QPSK	MCH	VL	TN	4.98	0.002873	± 2.5	PASS
		VN	TN	-4.18	-0.002411	± 2.5	PASS
		VH	TN	7.51	0.004335	± 2.5	PASS
16QAM	MCH	VL	TN	3.82	0.002205	± 2.5	PASS
		VN	TN	5.22	0.003014	± 2.5	PASS
		VH	TN	-17.95	-0.010362	± 2.5	PASS
Temperature							
Modulation	Channel	Voltage [Vdc]	Temperature (°C)	Deviation (Hz)	Deviation (ppm)	Limit (ppm)	Verdict
QPSK	MCH	VN	-30	2.02	0.001164	± 2.5	PASS
		VN	-20	-13.00	-0.007506	± 2.5	PASS
		VN	-10	22.70	0.013104	± 2.5	PASS
		VN	0	-1.82	-0.001049	± 2.5	PASS
		VN	10	1.90	0.001098	± 2.5	PASS
		VN	20	-21.49	-0.012118	± 2.5	PASS
		VN	30	4.75	0.002744	± 2.5	PASS
		VN	40	4.55	0.002626	± 2.5	PASS
		VN	50	-7.72	-0.00445	± 2.5	PASS
16QAM	MCH	VN	-30	8.89	0.005131	± 2.5	PASS
		VN	-20	8.71	0.005028	± 2.5	PASS
		VN	-10	-9.91	-0.00572	± 2.5	PASS
		VN	0	2.24	0.001291	± 2.5	PASS
		VN	10	-1.78	-0.00103	± 2.5	PASS
		VN	20	-3.18	-0.00184	± 2.5	PASS
		VN	30	-5.21	-0.00301	± 2.5	PASS
		VN	40	3.32	0.001917	± 2.5	PASS
		VN	50	6.94	0.004009	± 2.5	PASS

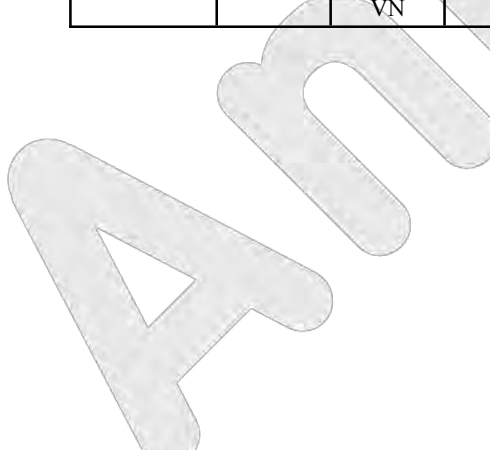

LTE BAND 5

Voltage							
Modulation	Channel	Voltage [Vdc]	Temperature (°C)	Deviation (Hz)	Deviation (ppm)	Limit (ppm)	Verdict
QPSK	MCH	VL	TN	6.72	0.008035	± 2.5	PASS
		VN	TN	9.61	0.011493	± 2.5	PASS
		VH	TN	7.98	0.009539	± 2.5	PASS
16QAM	MCH	VL	TN	1.30	0.001552	± 2.5	PASS
		VN	TN	-1.01	-0.001205	± 2.5	PASS
		VH	TN	-5.23	-0.006255	± 2.5	PASS
Temperature							
Modulation	Channel	Voltage [Vdc]	Temperature (°C)	Deviation (Hz)	Deviation (ppm)	Limit (ppm)	Verdict
QPSK	MCH	VN	-30	-7.05	-0.008427	± 2.5	PASS
		VN	-20	6.73	0.008048	± 2.5	PASS
		VN	-10	-3.01	-0.003596	± 2.5	PASS
		VN	0	-7.45	-0.008908	± 2.5	PASS
		VN	10	-4.19	-0.005005	± 2.5	PASS
		VN	20	5.19	0.006207	± 2.5	PASS
		VN	30	-7.55	-0.009022	± 2.5	PASS
		VN	40	-1.11	-0.001325	± 2.5	PASS
		VN	50	6.70	0.008013	± 2.5	PASS
16QAM	MCH	VN	-30	-8.40	-0.010040	± 2.5	PASS
		VN	-20	-6.48	-0.007743	± 2.5	PASS
		VN	-10	9.37	0.011196	± 2.5	PASS
		VN	0	8.16	0.009752	± 2.5	PASS
		VN	10	-5.95	-0.007111	± 2.5	PASS
		VN	20	2.31	0.002761	± 2.5	PASS
		VN	30	-2.60	-0.003110	± 2.5	PASS
		VN	40	1.17	0.001394	± 2.5	PASS
		VN	50	-4.12	-0.002376	± 2.5	PASS

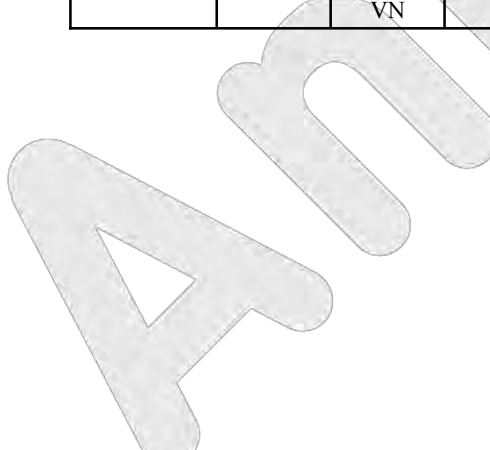

LTE BAND 17

Voltage							
Modulation	Channel	Voltage [Vdc]	Temperature (°C)	Deviation (Hz)	Deviation (ppm)	Limit (ppm)	Verdict
QPSK	MCH	VL	TN	-0.71	-0.000994	± 2.5	PASS
		VN	TN	-5.26	-0.007413	± 2.5	PASS
		VH	TN	3.58	0.005045	± 2.5	PASS
16QAM	MCH	VL	TN	0.72	0.001011	± 2.5	PASS
		VN	TN	-5.60	-0.007882	± 2.5	PASS
		VH	TN	0.15	0.000218	± 2.5	PASS
Temperature							
Modulation	Channel	Voltage [Vdc]	Temperature (°C)	Deviation (Hz)	Deviation (ppm)	Limit (ppm)	Verdict
QPSK	MCH	VN	-30	9.85	0.013878	± 2.5	PASS
		VN	-20	-0.88	-0.001236	± 2.5	PASS
		VN	-10	-6.37	-0.008974	± 2.5	PASS
		VN	0	-7.22	-0.010162	± 2.5	PASS
		VN	10	3.02	0.004252	± 2.5	PASS
		VN	20	5.77	0.008125	± 2.5	PASS
		VN	30	-1.64	-0.002316	± 2.5	PASS
		VN	40	-3.29	-0.004640	± 2.5	PASS
		VN	50	1.39	0.001962	± 2.5	PASS
16QAM	MCH	VN	-30	-2.15	-0.003024	± 2.5	PASS
		VN	-20	-4.37	-0.006153	± 2.5	PASS
		VN	-10	2.76	0.003888	± 2.5	PASS
		VN	0	-7.07	-0.009955	± 2.5	PASS
		VN	10	-1.09	-0.001531	± 2.5	PASS
		VN	20	-1.12	-0.001575	± 2.5	PASS
		VN	30	4.18	0.005881	± 2.5	PASS
		VN	40	-8.57	-0.012068	± 2.5	PASS
		VN	50	0.85	0.001201	± 2.5	PASS

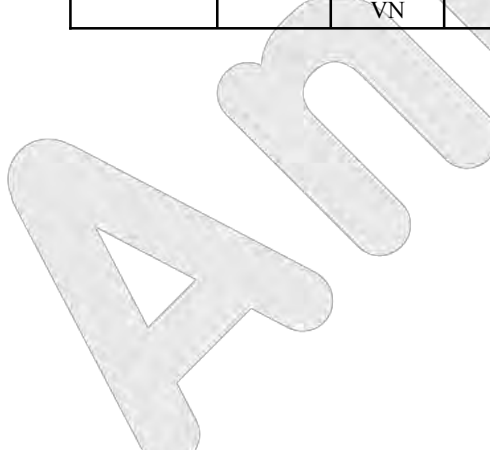

APPENDIX I -- TEST SETUP PHOTOGRAPH

Photo of Radiation Emission Test

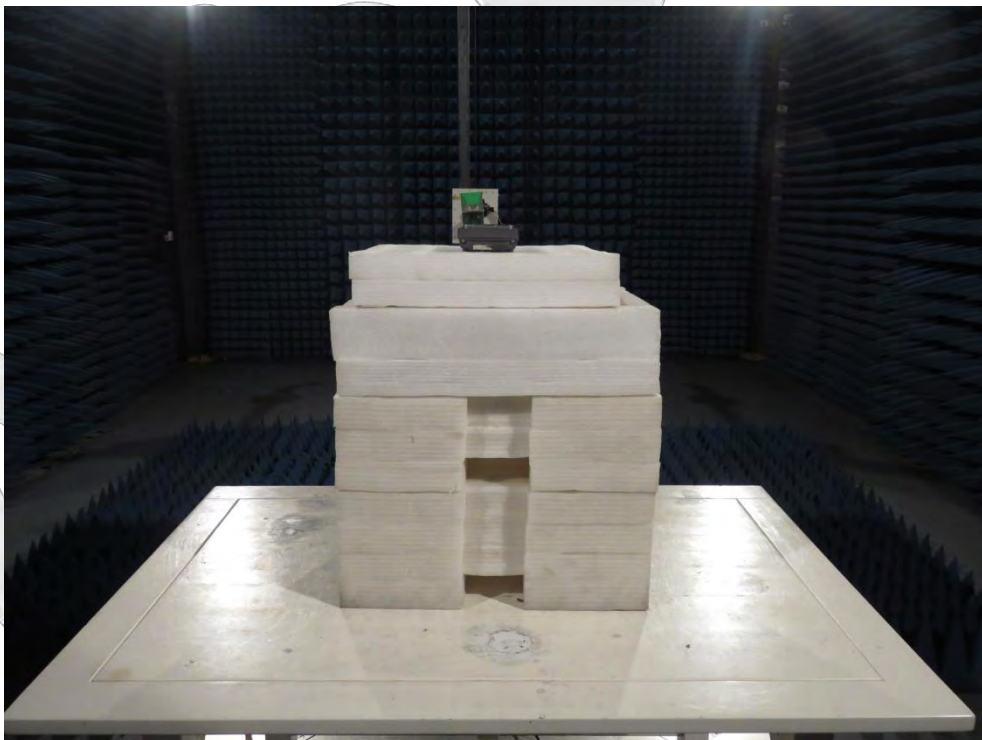
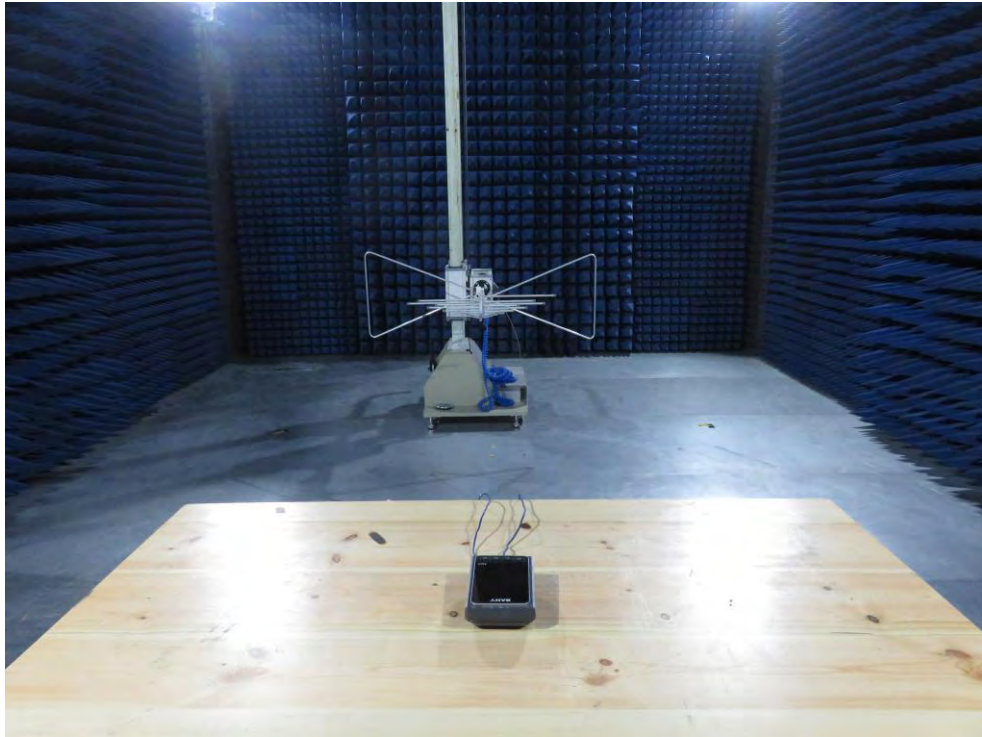

APPENDIX II -- PHOTOGRAPH

Reference to the test report No. R0217050061W1

Anbotek