

APPLICATION CERTIFICATION FCC Part 15C
On Behalf of
Hunan GM Innovation Technology Co., Ltd.

Vaxis wireless video system

Model No.: Vaxis Atom 500, Vaxis Atom500 pro, Vaxis Atom 500 DS,
Vaxis Atom 600, Vaxis Atom 600 pro, Vaxis Atom 600 DS

FCC ID: 2AJOF-ATOM500-TX

Prepared for : Hunan GM Innovation Technology Co., Ltd.
Address : No.46, Jiefang East Road, Furong District, Changsha
City, Hunan Province, China

Prepared by : Shenzhen Accurate Technology Co., Ltd.
Address : 1/F., Building A, Changyuan New Material Port,
Science & Industry Park, Nanshan District,
Shenzhen, Guangdong, P.R. China

Tel: (0755) 26503290
Fax: (0755) 26503396

Report No. : ATE20191739
Date of Test : Dec. 06, 2019-Dec. 23, 2019
Date of Report : Dec. 24, 2019

TABLE OF CONTENTS

Description	Page
Test Report Certification	
1. GENERAL INFORMATION	5
1.1. Description of Device (EUT).....	5
1.2. Special Accessory and Auxiliary Equipment.....	6
1.3. Model difference declaration	6
1.4. Laboratory Accreditation and Relationship to Customer	7
1.5. Measurement Uncertainty.....	7
2. MEASURING DEVICE AND TEST EQUIPMENT	8
2.1. For Radiated Emission Measurement	8
2.2. The Equipment Used to Measure Conducted Disturbance (L.I.S.N).....	9
3. OPERATION OF EUT DURING TESTING.....	10
3.1. Test setups.....	10
3.2. Configuration and peripherals.....	10
3.3. Test mode	10
4. TEST PROCEDURES AND RESULTS	11
5. 6DB OCCUPIED BANDWIDTH TEST	13
5.1. Block Diagram of Test Setup.....	13
5.2. EUT Configuration on Measurement	13
5.3. Operating Condition of EUT	13
5.4. Test Procedure	13
5.5. Test Result	14
6. 26DB OCCUPIED BANDWIDTH TEST	16
6.1. Block Diagram of Test Setup.....	16
6.2. EUT Configuration on Measurement	16
6.3. Operating Condition of EUT	16
6.4. Test Procedure	16
6.5. Test Result	17
7. 99% BANDWIDTH MEASUREMENT	20
7.1. Block Diagram of Test Setup.....	20
7.2. The Requirement For Section 15.407	20
7.3. EUT Configuration on Measurement	20
7.4. Operating Condition of EUT	20
7.5. Test Procedure	20
7.6. Test Result	21
8. DUTY CYCLE MEASUREMENT.....	24
8.1. Block Diagram of Test Setup.....	24
8.2. EUT Configuration on Measurement	24
8.3. Operating Condition of EUT	24
8.4. Test Procedure	24
8.5. Test Result	25
9. MAXIMUM POWER SPECTRAL DENSITY TEST	26
9.1. Block Diagram of Test Setup.....	26
9.2. The Requirement For Section 15.407	26
9.3. EUT Configuration on Measurement	26

9.4.	Operating Condition of EUT	26
9.5.	Test Procedure	27
9.6.	Test Result	28
10.	MAXIMUM CONDUCTED (AVERAGE) OUTPUT POWER	32
10.1.	Block Diagram of Test Setup.....	32
10.2.	The Requirement For Section 15.407	32
10.3.	EUT Configuration on Measurement	32
10.4.	Operating Condition of EUT	32
10.5.	Test Procedure	32
10.6.	Test Result	33
11.	RADIATED SPURIOUS EMISSION TEST	36
11.1.	Block Diagram of Test Setup.....	36
11.2.	Restricted bands of operation	38
11.3.	Configuration of EUT on Measurement	38
11.4.	The Limit For Section 15.407.....	39
11.5.	Operating Condition of EUT	39
11.6.	Test Procedure	39
11.7.	DATA SAMPLE	40
11.8.	The Field Strength of Radiation Emission Measurement Results	40
12.	BAND EDGE COMPLIANCE TEST	53
12.1.	Block Diagram of Test Setup.....	53
12.2.	The Requirement For Unwanted Emissions in the Restricted Bands	53
12.3.	EUT Configuration on Measurement	53
12.4.	Operating Condition of EUT	53
12.5.	Test Procedure	54
12.6.	Test Result	54
13.	IN BAND EMISSION	74
13.1.	Block Diagram of Test Setup.....	74
13.2.	For transmitters operating in the 5.725-5.85 GHz band:	74
13.3.	EUT Configuration on Measurement	74
13.4.	Operating Condition of EUT	74
13.5.	Test Procedure	74
13.6.	Test Result	74
14.	FREQUENCIES STABILITY	78
14.1.	Block Diagram of Test Setup.....	78
14.2.	EUT Configuration on Measurement	78
14.3.	Operating Condition of EUT	78
14.4.	Test Result	78
15.	POWER LINE CONDUCTED MEASUREMENT	80
15.1.	Block Diagram of Test Setup.....	80
15.2.	Power Line Conducted Emission Measurement Limits.....	80
15.3.	Configuration of EUT on Measurement	80
15.4.	Operating Condition of EUT	80
15.5.	Test Procedure	81
15.6.	DATA SAMPLE	81
15.7.	Power Line Conducted Emission Measurement Results	81
16.	ANTENNA REQUIREMENT.....	84
16.1.	The Requirement	84
16.2.	Antenna Construction	84

Test Report Certification

Applicant : Hunan GM Innovation Technology Co., Ltd.
Address : No.46, Jiefang East Road, Furong District, Changsha City, Hunan Province, China
Manufacturer : Hunan GM Innovation Technology Co., Ltd.
Address : No.46, Jiefang East Road, Furong District, Changsha City, Hunan Province, China
Product : Vaxis wireless video system
Model No. : Vaxis Atom 500, Vaxis Atom500 pro, Vaxis Atom 500 DS,
Vaxis Atom 600, Vaxis Atom 600 pro, Vaxis Atom 600 DS
Trade name : N/A

Measurement Procedure Used:

FCC Rules and Regulations Part 15 Subpart E Section 15.407

ANSI C63.10: 2013

KDB 789033 D02 General UNII Test Procedures New Rules v02r01



KDB 558074 D01 DTS Meas Guidance v05r02

KDB 662911 D01 Multiple Transmitter Output v02r01

The device described above is tested by SHENZHEN ACCURATE TECHNOLOGY CO., LTD. to determine the maximum emission levels emanating from the device. The maximum emission levels are compared to the FCC Part 15 Subpart E Section 15.407 limits. The measurement results are contained in this test report and SHENZHEN ACCURATE TECHNOLOGY CO., LTD. is assumed full responsibility for the accuracy and completeness of these measurements. Also, this report shows that the Equipment Under Test (EUT) is to be technically compliant with the FCC requirements.

This report applies to above tested sample only. This report shall not be reproduced in part without written approval of SHENZHEN ACCURATE TECHNOLOGY CO., LTD.

Date of Test : Dec. 06, 2019-Dec. 23, 2019
Date of Report : Dec. 24, 2019

Prepared by : 
(Tim  Engineering)

Approved & Authorized Signer : 
(Sean Liu, Manager)

1. GENERAL INFORMATION

1.1. Description of Device (EUT)

EUT	:	Vaxis wireless video system
Model Number	:	Vaxis Atom 500, Vaxis Atom500 pro, Vaxis Atom 500 DS, Vaxis Atom 600, Vaxis Atom 600 pro, Vaxis Atom 600 DS
IEEE 802.11 WLAN	:	802.11a (20 MHz channel bandwidth) , 802.11n (20 MHz channel bandwidth)
Frequency Range	:	U-NII(5150-5250, 5725-5850MHz)
Number of Channels	:	$f_c = 5000 \text{ MHz} + N * 5 \text{ MHz}$, where: - f_c = "Operating Frequency" in MHz, - N = "Channel Number". 5150-5250 MHz: $N = 36$ to 48 with step of 4 for the 20 MHz channel bandwidth. 5725-5850 MHz: $N = 149$ to 165 with step of 4 for the 20 MHz channel bandwidth.
$G_{ANT \text{ MAX}}$:	ANT1:2.5 dBi (per antenna port, max.) ANT2:2.5 dBi(per antenna port, max.)
Directional gain	:	5.51 Note: If any transmit signals are correlated with each other, Directional gain= $G_{ANT} + 10 \log(N_{ANT})$ dBi
Type of Antenna	:	SISO (for 802.11a/n) MIMO Antenna(for 802.11n)
Power Supply	:	DC 7.4V via battery or DC 5V via adapter
Modulation Type	:	BPSK/QPSK/16QAM/64QAM (OFDM)
TPC	:	Not Supported
Applicant Address	:	Hunan GM Innovation Technology Co., Ltd. No.46, Jiefang East Road, Furong District, Changsha City, Hunan Province, China

1.4.Laboratory Accreditation and Relationship to Customer

EMC Lab : Recognition of accreditation by Federal Communications Commission (FCC)
The Designation Number is CN1189
The Registration Number is 708358

Listed by Innovation, Science and Economic Development Canada (ISED)
The Registration Number is 5077A-2

Accredited by China National Accreditation Service for Conformity Assessment (CNAS)
The Registration Number is CNAS L3193

Accredited by American Association for Laboratory Accreditation (A2LA)
The Certificate Number is 4297.01

Name of Firm : Shenzhen Accurate Technology Co., Ltd.
Site Location : 1/F., Building A, Changyuan New Material Port, Science & Industry Park, Nanshan District, Shenzhen, Guangdong, P.R. China

1.5.Measurement Uncertainty

Conducted Emission Expanded Uncertainty = 2.72dB, k=2
(Mains ports, 9kHz-30MHz)

Radiated emission expanded uncertainty = 2.66dB, k=2
(9kHz-30MHz)

Radiated emission expanded uncertainty = 4.28dB, k=2
(30MHz-1000MHz)

Radiated emission expanded uncertainty = 4.98dB, k=2
(1G-18GHz)

Radiated emission expanded uncertainty = 5.06dB, k=2
(18G-26.5GHz)

2. MEASURING DEVICE AND TEST EQUIPMENT

2.1.For Radiated Emission Measurement

Item	Equipment	Manufacturer	Model No.	Serial No.	Last Cal.	Cal. Interval
1.	Spectrum Analyzer	Agilent	E7405A	MY45115511	Jan.05, 2019	1 Year
2.	Spectrum Analyzer	Rohde&Schwarz	FSV40	101495	Jan.05, 2019	1 Year
3.	Test Receiver	Rohde&Schwarz	ESCS30	100307	Jan.05, 2019	1 Year
4.	Test Receiver	Rohde& Schwarz	ESPI	100396/003	Jan.05, 2019	1 Year
5.	Test Receiver	Rohde& Schwarz	ESPI	101526/003	Jan.05, 2019	1 Year
6.	Test Receiver	Rohde& Schwarz	ESR	101817	Jan.05, 2019	1 Year
7.	Bilog Antenna	Schwarzbeck	VULB9163	9163-194	Jan.05, 2019	1 Year
8.	Bilog Antenna	Schwarzbeck	VULB9163	9163-323	Jan.05, 2019	1 Year
9.	Log.-Per.Antenna	Schwarzbeck	VUSLP 9111B	9111B-074	Jan.05, 2019	1 Year
10.	Biconical Broad Band Antenna	Schwarzbeck	VHBB 9124+BBA 9106	9124-617	Jan.05, 2019	1 Year
11.	Loop Antenna	Schwarzbeck	FMZB1516	1516131	Jan.05, 2019	1 Year
12.	Horn Antenna	Schwarzbeck	BBHA9120D	9120D-655	Jan.05, 2019	1 Year
13.	Horn Antenna	Schwarzbeck	BBHA9120D	9120D-1067	Jan.05, 2019	1 Year
14.	Vertical Active Monopole Antenna	Schwarzbeck	VAMP 9243	9243-370	Jan.05, 2019	1 Year
15.	RF Switching Unit+PreAMP	Compliance Direction	RSU-M2	38322	Jan.05, 2019	1 Year
16.	Pre-Amplifier	Agilent	8447D	294A10619	Jan.05, 2019	1 Year
17.	Pre-Amplifier	Rohde&Schwarz	CBLU11835 40-01	3791	Jan.05, 2019	1 Year
18.	50 Coaxial Switch	Anritsu Corp	MP59B	6200237248	Jan.05, 2019	1 Year
19.	50 Coaxial Switch	Anritsu Corp	MP59B	6200506474	Jan.05, 2019	1 Year
20.	RF Coaxial Cable	Schwarzbeck	N-5m	No.1	Jan.05, 2019	1 Year
21.	RF Coaxial Cable	Schwarzbeck	N-1m	No.6	Jan.05, 2019	1 Year
22.	RF Coaxial Cable	Schwarzbeck	N-1m	No.7	Jan.05, 2019	1 Year
23.	RF Coaxial Cable	SUHNER	N-3m	No.8	Jan.05, 2019	1 Year
24.	RF Coaxial Cable	RESENBERGER	N-3.5m	No.9	Jan.05, 2019	1 Year
25.	RF Coaxial Cable	SUHNER	N-6m	No.10	Jan.05, 2019	1 Year
26.	RF Coaxial Cable	RESENBERGER	N-12m	No.11	Jan.05, 2019	1 Year
27.	RF Coaxial Cable	RESENBERGER	N-0.5m	No.12	Jan.05, 2019	1 Year
28.	RF Coaxial Cable	SUHNER	N-2m	No.13	Jan.05, 2019	1 Year
29.	RF Coaxial Cable	SUHNER	N-0.5m	No.15	Jan.05, 2019	1 Year
30.	RF Coaxial Cable	SUHNER	N-2m	No.16	Jan.05, 2019	1 Year
31.	RF Coaxial Cable	RESENBERGER	N-6m	No.17	Jan.05, 2019	1 Year
Radiated Emission Measurement Software: EZ EMC V1.1.4.2						

2.2.The Equipment Used to Measure Conducted Disturbance (L.I.S.N)

Item	Equipment	Manufacturer	Model No.	Serial No.	Last Cal.	Cal. Interval
1.	Test Receiver	Rohde & Schwarz	ESCS30	100307	Jan.05, 2019	1 Year
2.	Test Receiver	Rohde & Schwarz	ESPI3	100396/003	Jan.05, 2019	1 Year
3.	Test Receiver	Rohde & Schwarz	ESPI3	101526/003	Jan.05, 2019	1 Year
4.	L.I.S.N.	Schwarzbeck	NLSK8126	8126431	Jan.05, 2019	1 Year
5.	L.I.S.N.	Rohde & Schwarz	ESH3-Z5	100305	Jan.05, 2019	1 Year
6.	L.I.S.N.	Rohde & Schwarz	ESH3-Z5	100310	Jan.05, 2019	1 Year
7.	L.I.S.N.	Rohde & Schwarz	ESH3-Z6	100132	Jan.05, 2019	1 Year
8.	Pulse Limiter	Rohde & Schwarz	ESH3-Z2	100305	Jan.05, 2019	1 Year
9.	Pulse Limiter	Rohde & Schwarz	ESH3-Z2	100312	Jan.05, 2019	1 Year
10.	Pulse Limiter	Rohde & Schwarz	ESH3-Z2	100815	Jan.05, 2019	1 Year
11.	50Ω Coaxial Switch	Anritsu Corp	MP59B	6200283936	Jan.05, 2019	1 Year
12.	50Ω Coaxial Switch	Anritsu Corp	MP59B	6200283933	Jan.05, 2019	1 Year
13.	50Ω Coaxial Switch	Anritsu Corp	MP59B	6200506474	Jan.05, 2019	1 Year
14.	VOLTAGE PROBE	Schwarzbeck	TK9416	N/A	Jan.05, 2019	1 Year
15.	RF CURRENT PROBE	Rohde & Schwarz	EZ-17	100048	Jan.05, 2019	1 Year
16.	8-Wire Impedance Stabilisation Network	Schwarzbeck	CAT5 8158	8158-0035	Jan.05, 2019	1 Year
17.	RF Coaxial Cable	SUHNER	N-2m	No.2	Jan.05, 2019	1 Year
18.	RF Coaxial Cable	SUHNER	N-2m	No.3	Jan.05, 2019	1 Year
19.	RF Coaxial Cable	SUHNER	N-2m	No.14	Jan.05, 2019	1 Year
Conducted Emission Measurement Software: ES-K1 V1.71						

3. OPERATION OF EUT DURING TESTING

3.1. Test setups

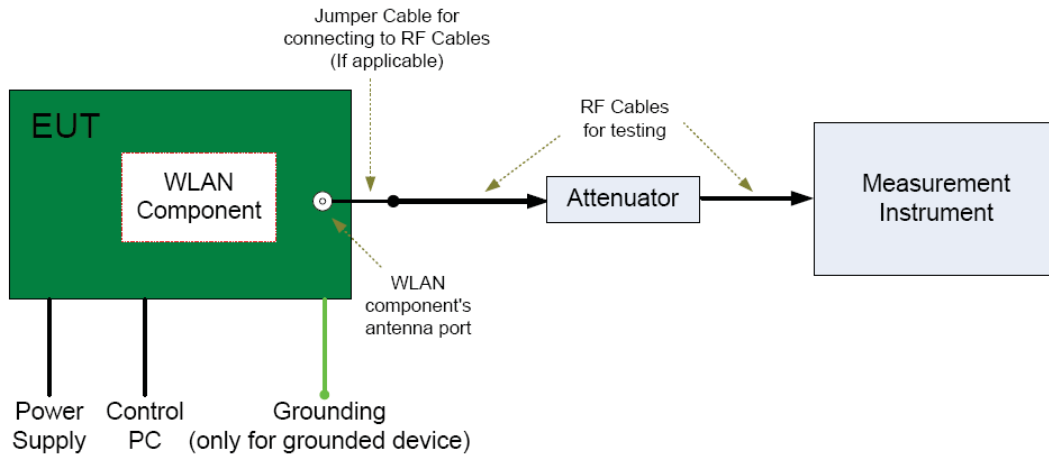

3.2. Configuration and peripherals

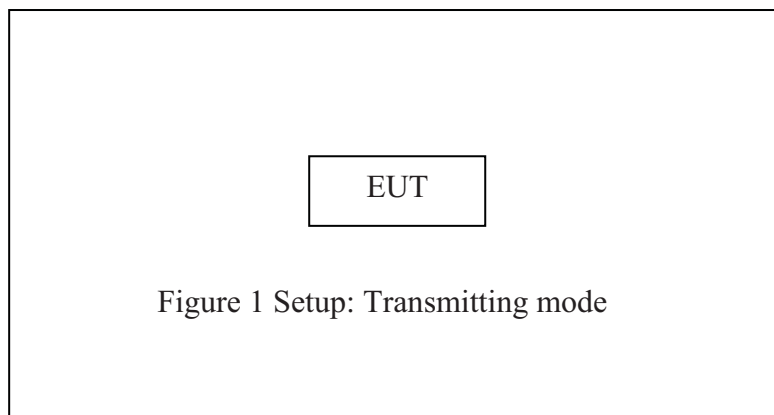

Note: The EUT have two antenna(1 and 2), They can transmit simultaneously

3.3. Test mode

Test Mode	Test Modes Description
11A	IEEE 802.11a with data rate of 6 Mbps using SISO mode.
11N20	IEEE 802.11n with data date of MCS0 and bandwidth of 20 MHz using SISO mode.
11N20m	IEEE 802.11n with data date of MCS8 and bandwidth of 20 MHz using MIMO mode.

NOTE: Worst cases for each IEEE 802.11 mode are selected to perform tests.

4. TEST PROCEDURES AND RESULTS

Description of Test	Band	FCC Rules	Requirements	Result
AC power Line Conducted Emission Test	5150-5250 5725-5850	15.207	N/A	Compliant
Emission Bandwidth	5150-5250	15.403(i), 15.407(a)(1)	No limit.	Compliant
	5725-5850	15.403(i), 15.407(e)	≥ 500 kHz.	
Occupied Bandwidth	5150-5250 5725-5850	KDB 789033 §D	No limit	Compliant
Duty Cycle	5150-5250 5725-5850	--	No limit	Compliant
Maximum Conducted Output Power	5150-5250	15.407(a)(1) 15.407(a)(4)	< 250mW (avg during transmission)	Compliant
	5725-5850	15.407(a)(3)	< 1W (avg during transmission)	
Peak Power Spectral Density	5150-5250	15.407(a)(1) 15.407(a)(4)	FCC: For client devices in the 5.15-5.25 GHz band <11dBm/MHz (avg during transmission)	Compliant
	5725-5850	15.407(a)(3) 15.407(a)(4)	<30dBm/500KHz (avg during transmission)	
Unwanted Emissions	5150-5250	15.407(b)(1) 15.407(b)(6) 15.407(b)(7) 15.209	F<1GHz: § 15.209/§7.2.5 limit (QP). F \geq 1GHz & out-restricted: <-27dBm/MHz PK e.i.r.p. (exl. 5.15-5.35 GHz). F \geq 1GHz & in-restricted: § 15.209/§7.2.5 limit (AV&PK).	
	5725-5850	15.407(b)(4) 15.407(b)(6) 15.407(b)(7) 15.209	F<1GHz: § 15.209/§7.2.5 limit (QP). All emissions shall be limited to a level of -27 dBm/MHz at 75 MHz or more above or below the band edge increasing linearly to 10 dBm/MHz at 25 MHz above or below the band edge, and from 25 MHz above or below the band edge increasing linearly to a level of 15.6 dBm/MHz at 5 MHz above or	

			below the band edge, and from 5 MHz above or below the band edge increasing linearly to a level of 27 dBm/MHz at the band edge F ≥ 1GHz & in-restricted: § 15.209/§7.2.5 limit (AV&PK).	
Frequency Stability	5150-5250 5725-5850	15.407(g)	FCC Part 15.407(g)	Compliant
Antenna Requirement	N/A	15.203, 15.204(b), 15.204(c), 15.212(a), 2.929(b)	N/A	Compliant

5. 6DB OCCUPIED BANDWIDTH TEST

5.1. Block Diagram of Test Setup

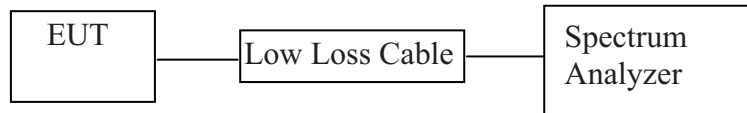

(EUT: Vaxis wireless video system)

5.2. EUT Configuration on Measurement

The equipment are installed on the emission measurement to meet the commission requirements and operating regulations in a manner which tends to maximize its emission characteristics in normal application.

Section 15.407(e) specifies the minimum 6 dB emission bandwidth of at least 500 kHz for the band 5.725-5.85 GHz

5.3. Operating Condition of EUT

5.3.1. Setup the EUT and simulator as shown as Section 5.1.

5.3.2. Turn on the power of all equipment.

5.3.3. Let the EUT work in TX modes measure it. The transmit frequency are 5725-5850MHz.

5.4. Test Procedure

5.4.1. The transmitter output was connected to the spectrum analyzer through a low loss cable.

5.4.2. Set RBW of spectrum analyzer to 100 kHz and VBW to 300 kHz.

5.4.3. The 6dB bandwidth is defined as the total spectrum the power of which is higher than peak power minus 6dB.

5.5. Test Result

The test was performed with 802.11a

Channel	Frequency (MHz)	6dB Bandwidth ANT 1 (MHz)	6dB Bandwidth ANT 2(MHz)	Limit (MHz)
149	5745	16.324	16.324	> 0.5MHz
165	5825	16.382	16.382	> 0.5MHz

The test was performed with 802.11n20

Channel	Frequency (MHz)	6dB Bandwidth ANT 1 (MHz)	6dB Bandwidth ANT 2(MHz)	Limit (MHz)
149	5745	17.598	17.598	> 0.5MHz
165	5825	17.598	17.598	> 0.5MHz

The spectrum analyzer plots are attached as below.

6dB Bandwidth

ANT 1(802.11A)

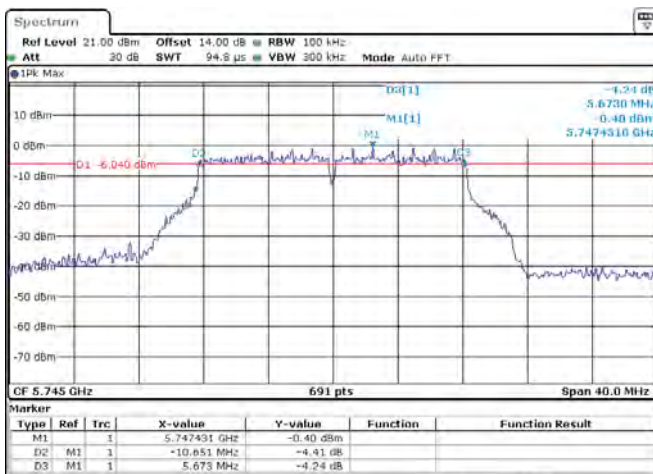

ANT 2(802.11A)

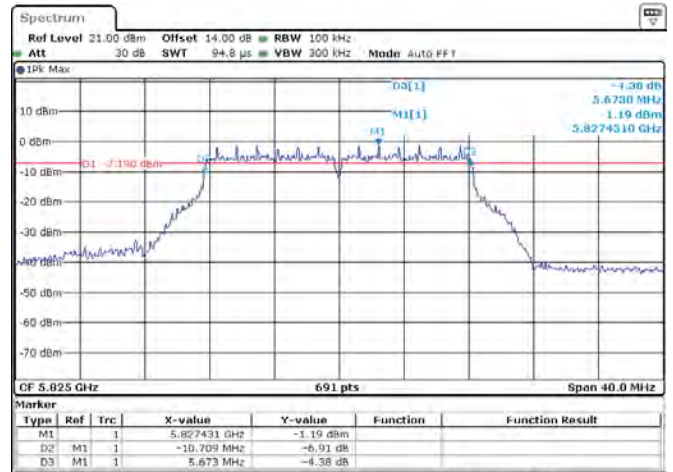
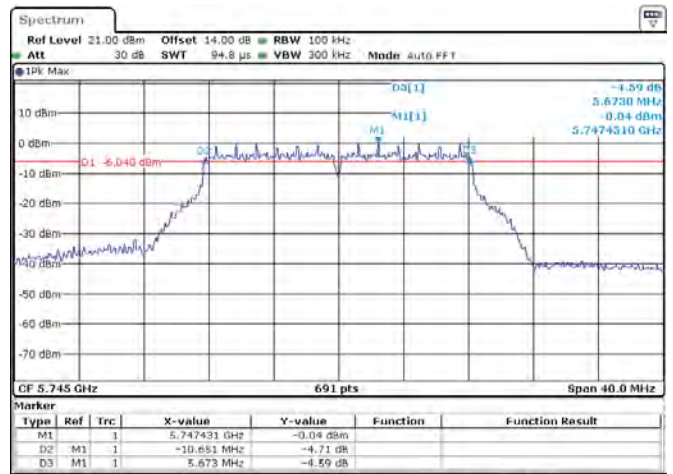

ANT 1(802.11N20)

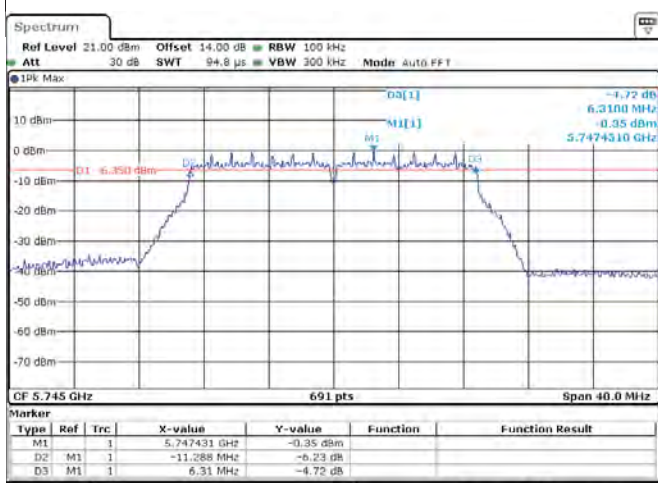

ANT 2(802.11N20)

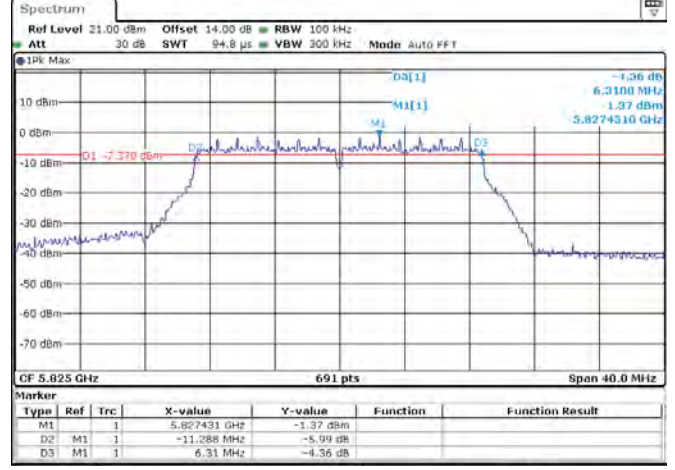
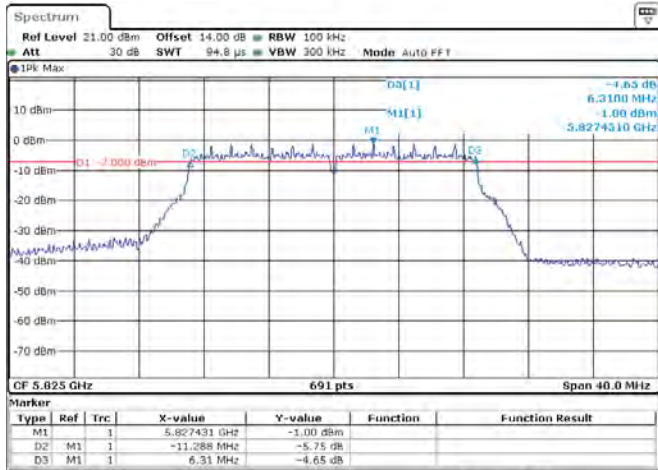
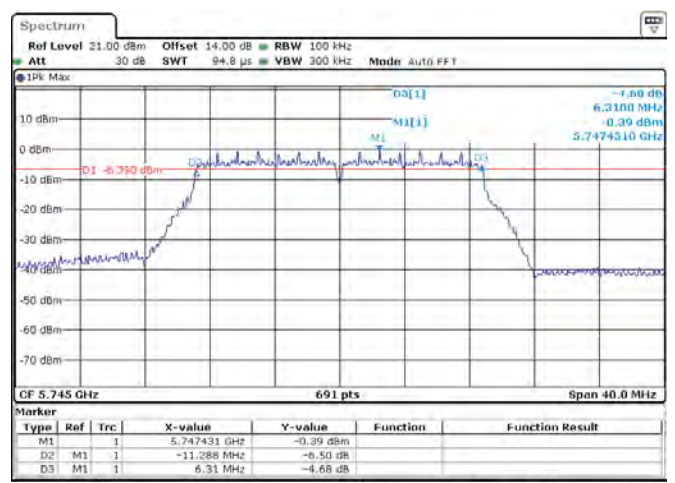

6. 26DB OCCUPIED BANDWIDTH TEST

6.1. Block Diagram of Test Setup

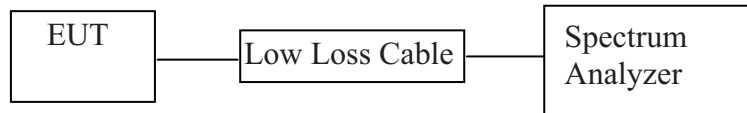

(EUT: Vaxis wireless video system)

6.2. EUT Configuration on Measurement

The equipment are installed on the emission measurement to meet the commission requirements and operating regulations in a manner which tends to maximize its emission characteristics in normal application.

6.3. Operating Condition of EUT

6.3.1. Setup the EUT and simulator as shown as Section 6.1.

6.3.2. Turn on the power of all equipment.

6.3.3. Let the EUT work in TX modes measure it. The transmit frequency are 5150-5250MHz.

6.4. Test Procedure

6.4.1. The transmitter output was connected to the spectrum analyzer through a low loss cable.

6.4.2. Set Set RBW = approximately 1% of the emission bandwidth.

6.4.3. Set the VBW > RBW.

6.4.4. Detector = Peak.

6.4.5. Trace mode = max hold.

6.4.6. Measure the maximum width of the emission that is 26 dB down from the maximum of the emission. Compare this with the RBW setting of the analyzer. Readjust RBW and repeat measurement as needed until the RBW/EBW ratio is approximately 1%.

6.5. Test Result

The test was performed with 802.11a			
Channel	Frequency (MHz)	26dB Bandwidth ANT 1 (MHz)	26dB Bandwidth ANT 2(MHz)
36	5180	21.823	21.823
48	5240	21.708	21.766

The test was performed with 802.11n20			
Channel	Frequency (MHz)	26dB Bandwidth ANT 1 (MHz)	26dB Bandwidth ANT 2(MHz)
36	5180	22.171	22.229
48	5240	22.229	22.055

The spectrum analyzer plots are attached as below.

26dB Bandwidth

ANT 1(11A)

ANT 2(11A)

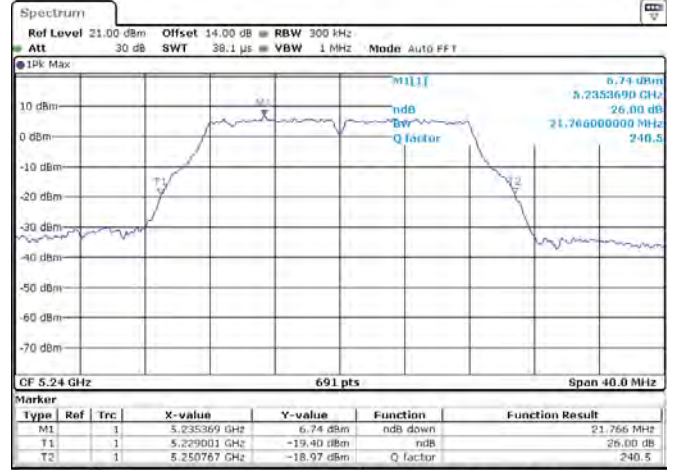
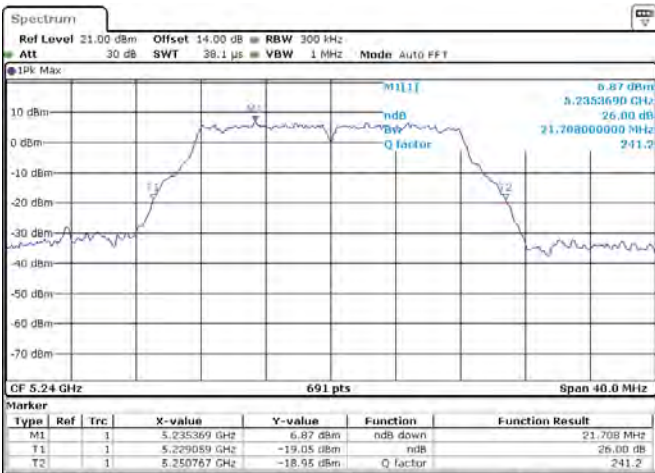
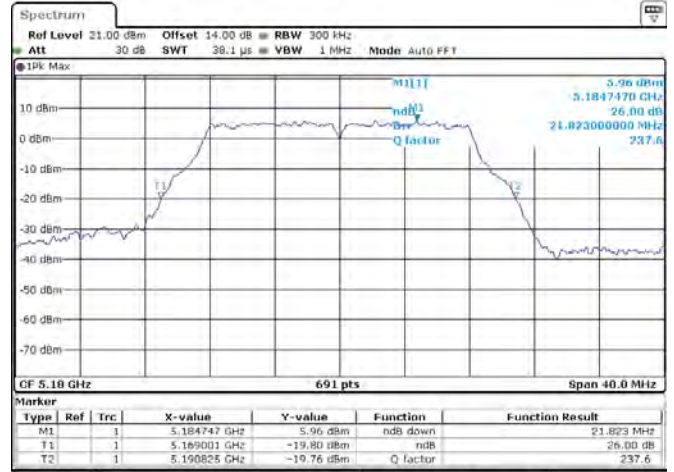
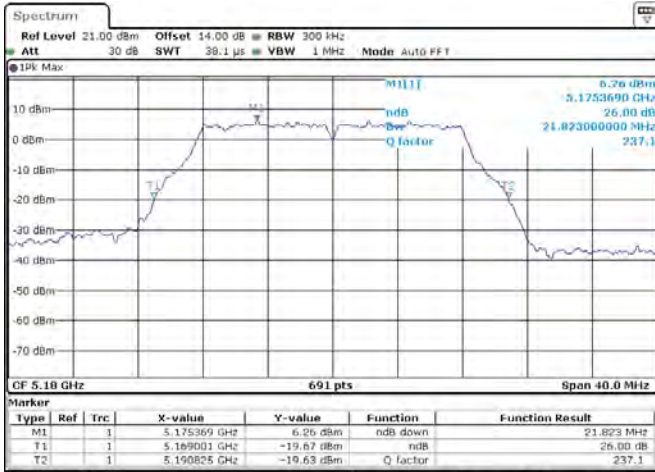

ANT 1(11N20)

ANT 2(11N20)

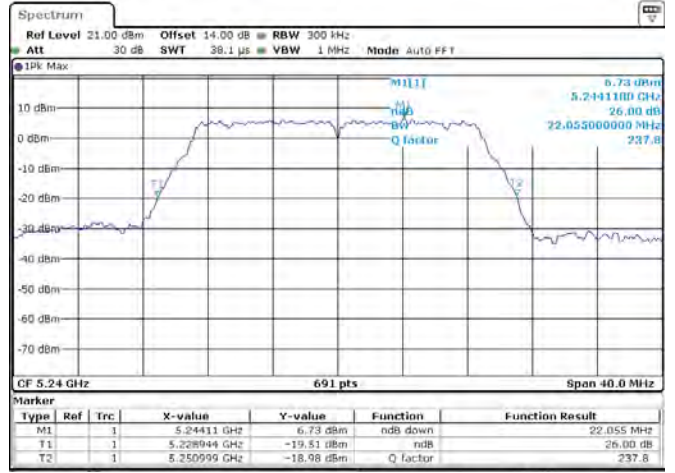
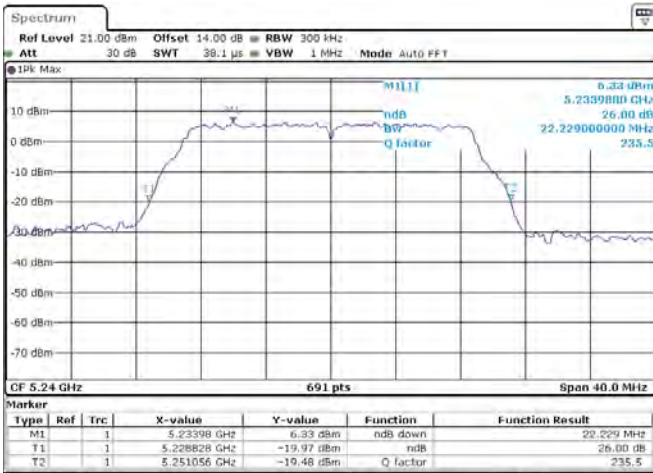
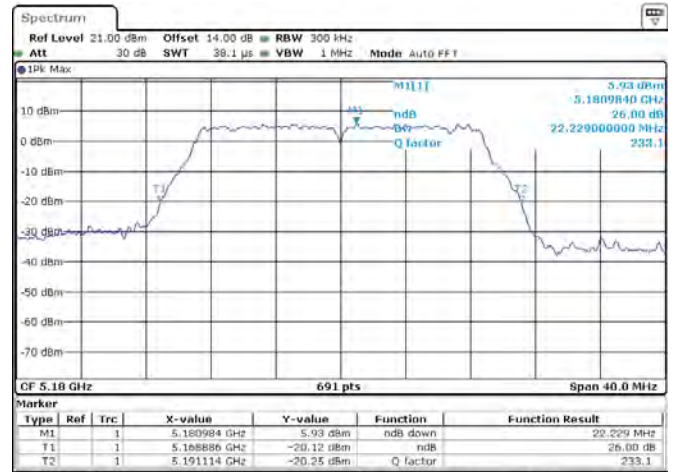
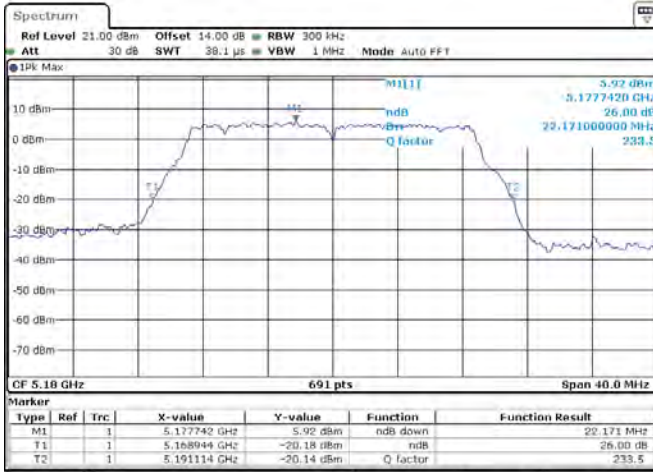

7. 99% BANDWIDTH MEASUREMENT

7.1. Block Diagram of Test Setup



7.2. The Requirement For Section 15.407

The 99% occupied bandwidth is the frequency bandwidth such that, below its lower and above its upper frequency limits, the mean powers are each equal to 0.5 % of the total mean power of the given emission. Measurement of the 99% occupied bandwidth is required only as a condition for using the optional band-edge measurement techniques described in section II.G.3.d). Measurements of 99% occupied bandwidth may also optionally be used in lieu of the EBW to define the minimum frequency range over which the spectrum is integrated when measuring maximum conducted output power as described in section II.E. However, the EBW must be measured to determine bandwidth dependent limits on maximum conducted output power in accordance with 15.407(a).

7.3. EUT Configuration on Measurement

The equipment are installed on the emission measurement to meet the commission requirements and operating regulations in a manner which tends to maximize its emission characteristics in normal application.

7.4. Operating Condition of EUT

7.4.1. Setup the EUT and simulator as shown as Section 7.1.

7.4.2. Turn on the power of all equipment.

7.4.3. Let the EUT work in TX modes measure it. The transmit frequency are 5150-5250 and 5725-5850MHz.

7.5. Test Procedure

1. Set center frequency to the nominal EUT channel center frequency.
2. Set span = 1.5 times to 5.0 times the OBW.
3. Set RBW = 1 % to 5 % of the OBW. Set VBW $\geq 3 * RBW$
4. Video averaging is not permitted. Where practical, a sample detection and single sweep mode shall be used. Otherwise, peak detection and max hold mode (until the trace stabilizes) shall be used.
5. Use the 99 % power bandwidth function of the instrument.

6. If the instrument does not have a 99 % power bandwidth function, the trace data points are recovered and directly summed in power units. The recovered amplitude data points, beginning at the lowest frequency, are placed in a running sum until 0.5 % of the total is reached; that frequency is recorded as the lower frequency. The process is repeated until 99.5 % of the total is reached; that frequency is recorded as the upper frequency. The 99% occupied bandwidth is the difference between these two frequencies.

7.6. Test Result

The test was performed with 802.11a				
Channel	Frequency (MHz)	99% Bandwidth ANT 1 (MHz)	99% Bandwidth ANT 2(MHz)	Verdict
36	5180	17.192	17.192	PASS
48	5240	17.192	17.192	PASS
149	5745	17.250	17.192	PASS
165	5825	17.192	17.250	PASS

The test was performed with 802.11n20				
Channel	Frequency (MHz)	99% Bandwidth ANT 1 (MHz)	99% Bandwidth ANT 2(MHz)	Verdict
36	5180	18.234	18.177	PASS
48	5240	18.350	18.292	PASS
149	5745	18.408	18.234	PASS
165	5825	18.292	18.234	PASS

The spectrum analyzer plots are attached as below.

99% Bandwidth

ANT 1(11A)

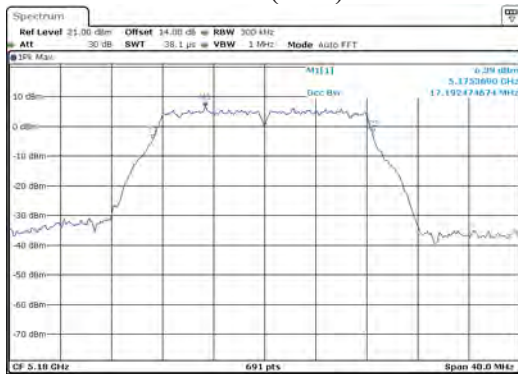

ANT 2(11A)

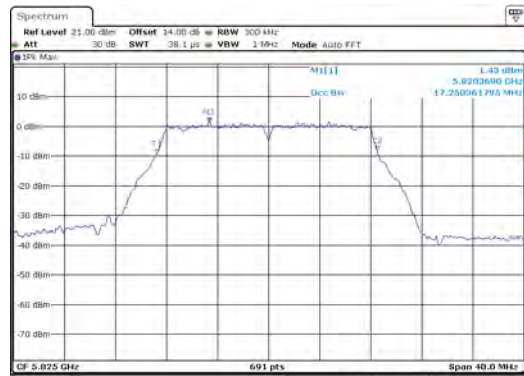
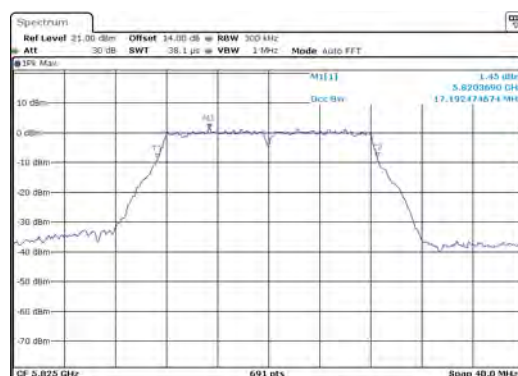
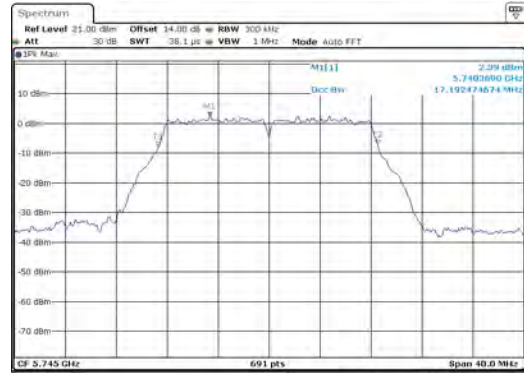
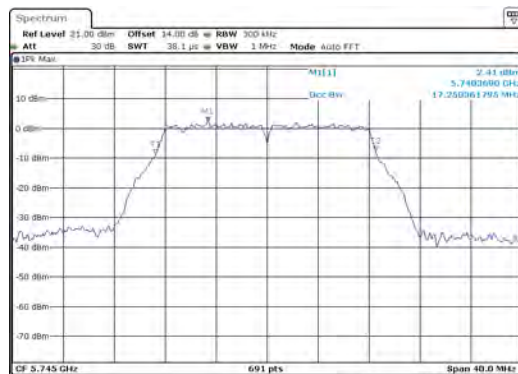
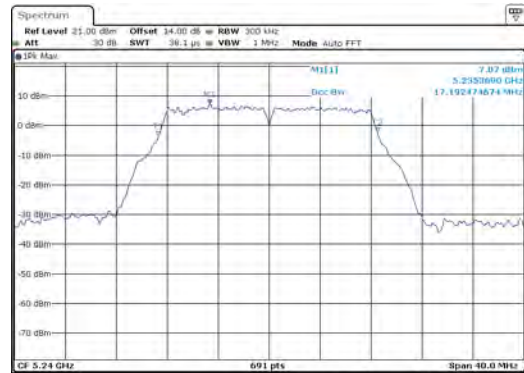
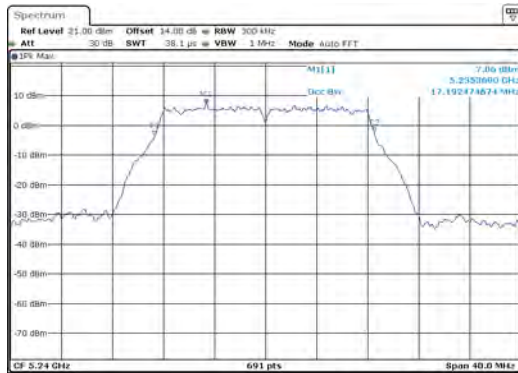
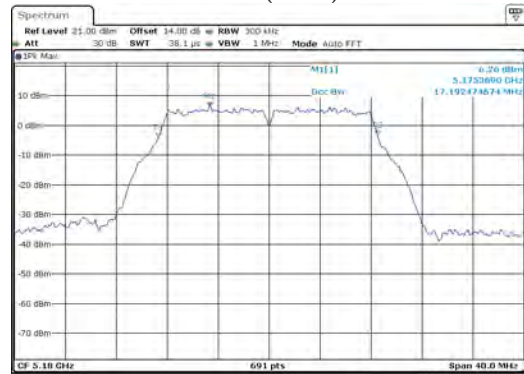

ANT 1(11N20)

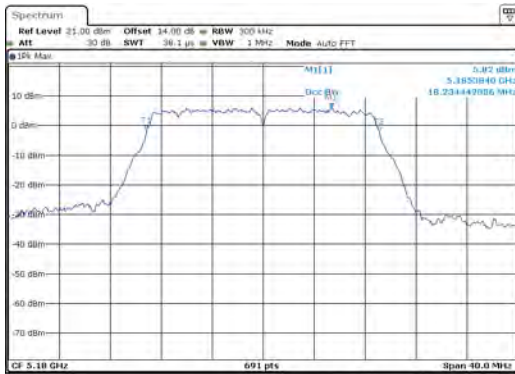

ANT 2(11N20)

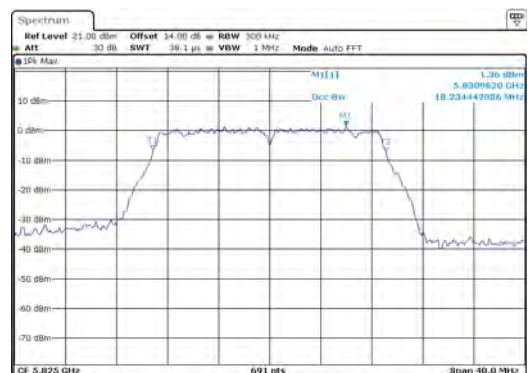
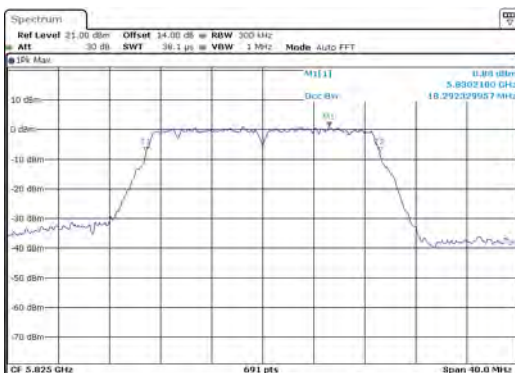
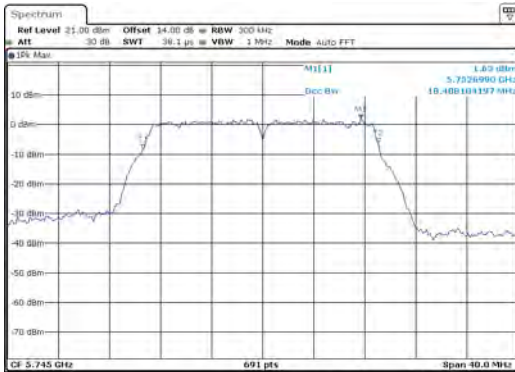
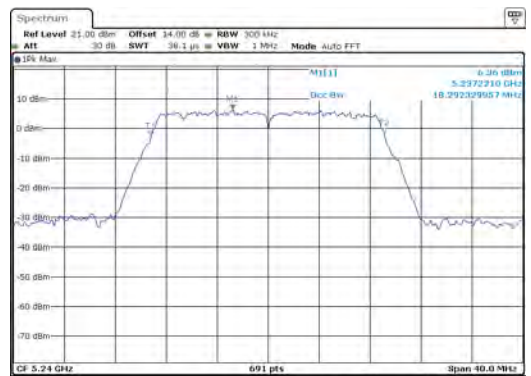
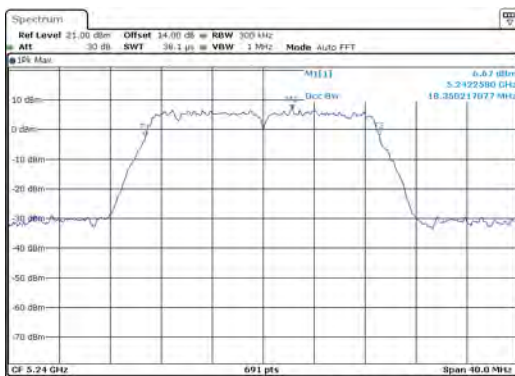
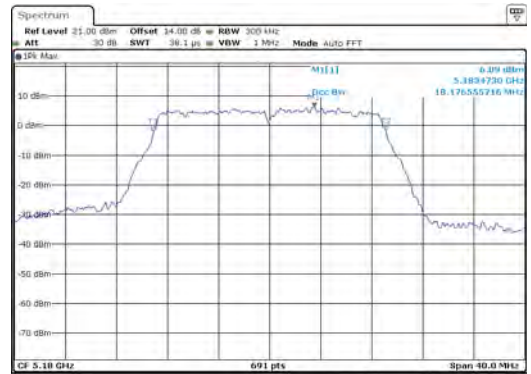

8. DUTY CYCLE MEASUREMENT

8.1. Block Diagram of Test Setup

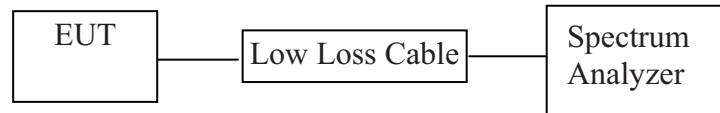

8.2. EUT Configuration on Measurement

The equipment are installed on the emission measurement to meet the commission requirements and operating regulations in a manner which tends to maximize its emission characteristics in normal application.

8.3. Operating Condition of EUT

8.3.1. Setup the EUT and simulator as shown as Section 8.1.

8.3.2. Turn on the power of all equipment.

8.3.3. Let the EUT work in TX modes measure it. The transmit frequency are 5150-5250 and 5725-5850MHz.

8.4. Test Procedure

Measurements of duty cycle and transmission duration shall be performed using one of the following techniques:

1. A diode detector and an oscilloscope that together have sufficiently short response time to permit accurate measurements of the on- and off-times of the transmitted signal.
2. The zero-span mode on a spectrum analyzer or EMI receiver if the response time and spacing between bins on the sweep are sufficient to permit accurate measurements of the on- and off-times of the transmitted signal
 - a. Set the center frequency of the instrument to the centre frequency of the transmission
 - b. Set $RBW \geq OBW$ if possible; otherwise, set RBW to the largest available value(10MHz).
 - c. Set detector = Peak or average.
 - d. The zero-span measurement method shall not be used unless both RBW and VBW are $> 50/T$ and the number of sweep points across duration T exceeds 100.
(For example, if VBW and/or RBW are limited to 3MHz, then the zero-span method of measuring duty cycle shall not be used if $T \leq 16.7$ microseconds.)

8.5. Test Result

Test mode	Frequency (MHz)	Duty cycle(%) ANT 1	Duty cycle(%) ANT 2	10log(1/x) ANT 1	10log(1/x) ANT 2
802.11a20	5180	96.86	96.86	0.14	0.14
802.11n20	5180	96.86	96.66	0.14	0.15

Note: The duty cycle of other frequency points in the same mode is the same, so we select a frequency point to test for each mode.

Duty cycle=x

The spectrum analyzer plots are attached as below.

802.11a20 5180MHz

ANT 1

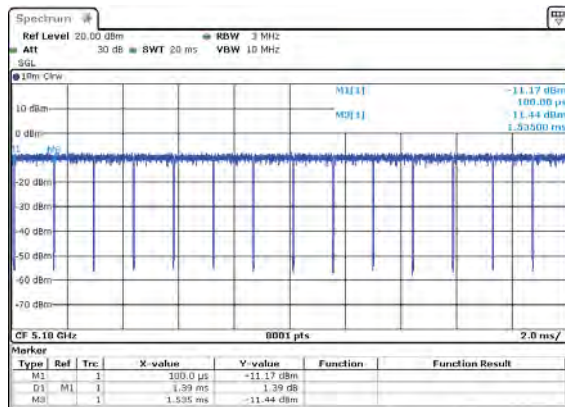

ANT 2

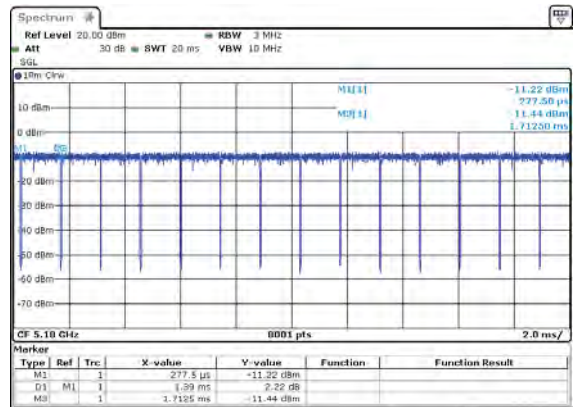

802.11n20 5180MHz

ANT 1

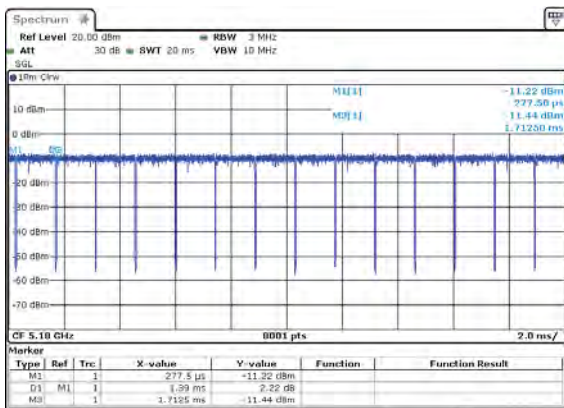

ANT 2

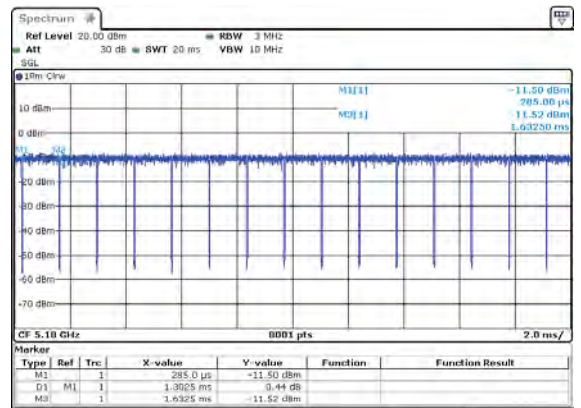

9. MAXIMUM POWER SPECTRAL DENSITY TEST

9.1. Block Diagram of Test Setup

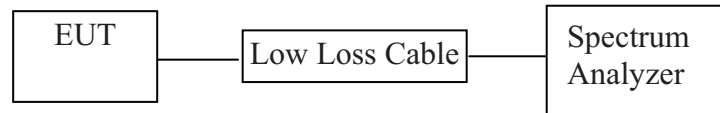

9.2. The Requirement For Section 15.407

Section 15.407: For mobile and portable client devices in the 5.15–5.25 GHz band, the maximum conducted output power over the frequency band of operation shall not exceed 250 mW provided the maximum antenna gain does not exceed 6 dBi. In addition, the maximum power spectral density shall not exceed 11 dBm in any 1 megahertz band. If transmitting antennas of directional gain greater than 6 dBi are used, both the maximum conducted output power and the maximum power spectral density shall be reduced by the amount in dB that the directional gain of the antenna exceeds 6 dBi.

For the band 5.725–5.85 GHz, the maximum conducted output power over the frequency band of operation shall not exceed 1 W. In addition, the maximum power spectral density shall not exceed 30 dBm in any 500-kHz band. If transmitting antennas of directional gain greater than 6 dBi are used, both the maximum conducted output power and the maximum power spectral density shall be reduced by the amount in dB that the directional gain of the antenna exceeds 6 dBi.

9.3. EUT Configuration on Measurement

The equipment are installed on the emission Measurement to meet the commission requirements and operating regulations in a manner which tends to maximize its emission characteristics in normal application.

9.4. Operating Condition of EUT

9.4.1. Setup the EUT and simulator as shown as Section 9.1.

9.4.2. Turn on the power of all equipment.

9.4.3. Let the EUT work in TX modes measure it. The transmit frequency are 5150-5250 and 5725-5850MHz.

9.5. Test Procedure

9.5.1. The transmitter output was connected to the spectrum analyzer through a low loss cable.

9.5.2. Measurement Procedure PKPSD:

For devices operating in the bands 5.15-5.25 GHz, 5.25-5.35 GHz, and 5.47-5.725 GHz, the above procedures make use of 1 MHz RBW to satisfy directly the 1 MHz reference bandwidth specified in § 15.407(a)(5). For devices operating in the band 5.725-5.85 GHz, the rules specify a measurement bandwidth of 500 kHz. Many spectrum analyzers do not have 500 kHz RBW, thus a narrower RBW may need to be used. The rules permit the use of a RBW less than 1 MHz, or 500 kHz, “provided that the measured power is integrated over the full reference bandwidth” to show the total power over the specified measurement bandwidth (i.e., 1 MHz, or 500 kHz). If measurements are performed using a reduced resolution bandwidth (< 1 MHz, or < 500 kHz) and integrated over 1 MHz, or 500 kHz bandwidth, the following adjustments to the procedures apply:

1. Set $RBW \geq 1/T$, where T is defined in section II.B.1.a). Set $VBW \geq 3 RBW$.
2. If measurement bandwidth of Maximum PSD is specified in 500 kHz, add $10 \log(500 \text{ kHz}/RBW)$ to the measured result, whereas RBW (< 500 kHz) is the reduced resolution bandwidth of the spectrum analyzer set during measurement.
3. If measurement bandwidth of Maximum PSD is specified in 1 MHz, add $10 \log(1\text{MHz}/RBW)$ to the measured result, whereas RBW (< 1 MHz) is the reduced resolution bandwidth of spectrum analyzer set during measurement.
4. Care must be taken to ensure that the measurements are performed during a period of continuous transmission or are corrected upward for duty cycle.
5. Detector = RMS.
6. Sweep time = auto couple.
7. Trace mode = max hold.
8. Allow trace to fully stabilize.
9. Use the peak marker function to determine the maximum amplitude level.

9.5.3. Measurement the maximum power spectral density.

9.6. Test Result

The test was performed with 802.11a(SISO)							
Channel	Frequency (MHz)	Power Spectral Density ANT 1 (dBm)	Power Spectral Density ANT 2 (dBm)	Final Power Spectral Density ANT 1 (dBm)	Final Power Spectral Density ANT 2 (dBm)	Limit (dBm)	Verdict
36	5180	2.54	2.53	2.68	2.67	11	PASS
48	5240	3.00	2.87	3.14	3.01	11	PASS
149	5745	-2.55	-2.72	-2.41	-2.68	30	PASS
165	5825	-3.51	-3.59	-3.37	-3.45	30	PASS

The test was performed with 802.11 n20 (SISO)							
Channel	Frequency (MHz)	Power Spectral Density ANT 1 (dBm)	Power Spectral Density ANT 2 (dBm)	Final Power Spectral Density ANT 1 (dBm)	Final Power Spectral Density ANT 2 (dBm)	Limit (dBm)	Verdict
36	5180	2.73	2.92	2.87	3.07	11	PASS
48	5240	3.70	3.19	3.84	3.34	11	PASS
149	5745	-2.42	-2.85	-2.28	-2.70	30	PASS
165	5825	-3.28	-3.28	-3.14	-3.13	30	PASS

The test was performed with 802.11 n20 (MIMO)							
Channel	Frequency (MHz)	Power Spectral Density ANT 1 (dBm)	Power Spectral Density ANT 2 (dBm)	Final Power Spectral Density ANT 1 (dBm)	Final Power Spectral Density ANT 2 (dBm)	Final Power Spectral Density Total(dBm)	Limit (dBm)
36	5180	3.42	2.84	3.56	2.99	6.29	11
48	5240	3.22	3.52	3.36	3.67	6.53	11
149	5745	-2.31	-2.61	-2.17	-2.46	0.70	30
165	5825	-3.55	-3.74	-3.41	-3.59	-0.49	30

Note: Final Power Spectral Density ANT 1= Power Spectral Density ANT 1+10log(1/x) ANT 1
 Final Power Spectral Density ANT 2= Power Spectral Density ANT 2+10log(1/x) ANT 2

The spectrum analyzer plots are attached as below.

TEST MODE:SISO

ANT 1(11A)

ANT 2(11A)

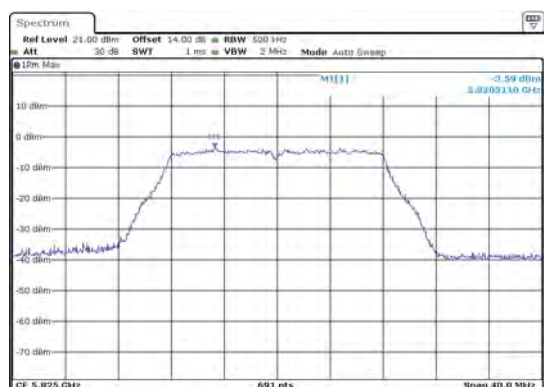
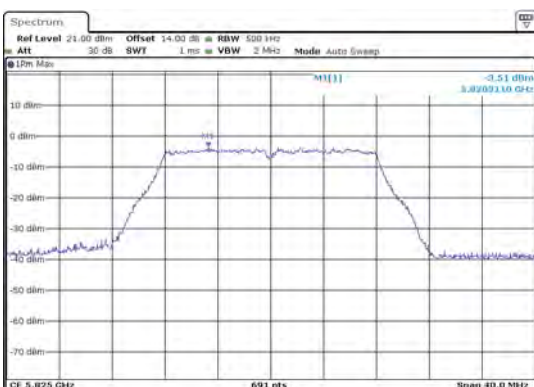
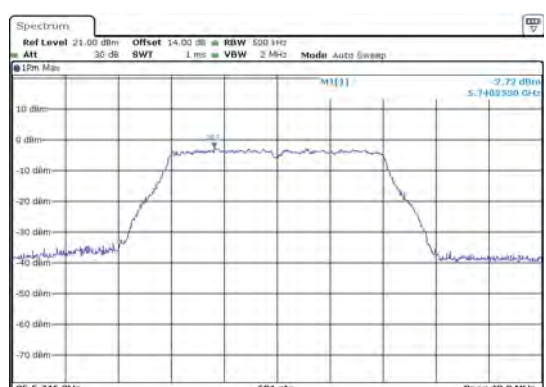
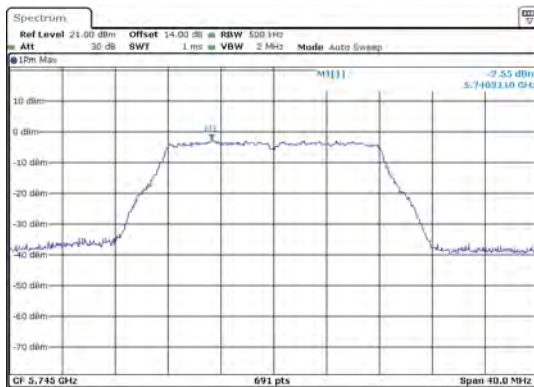
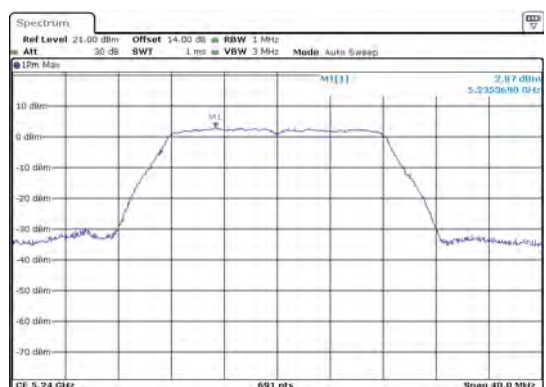
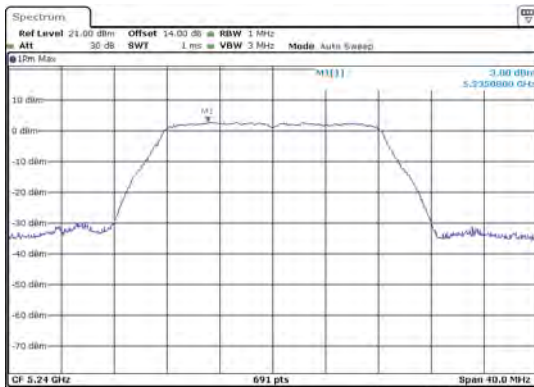
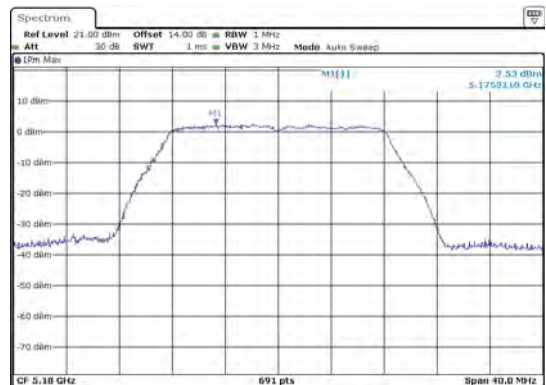
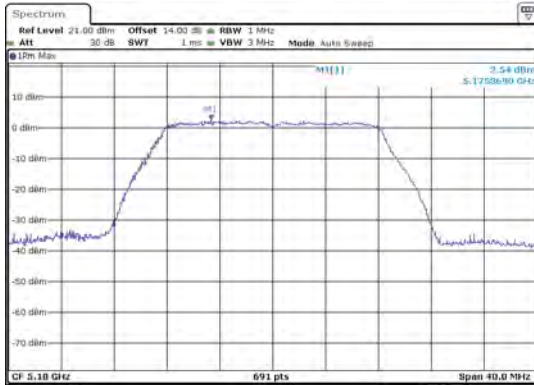

ANT 1(11N20)

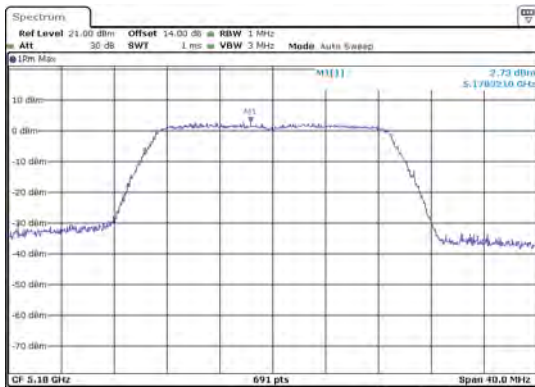

ANT 2(11N20)

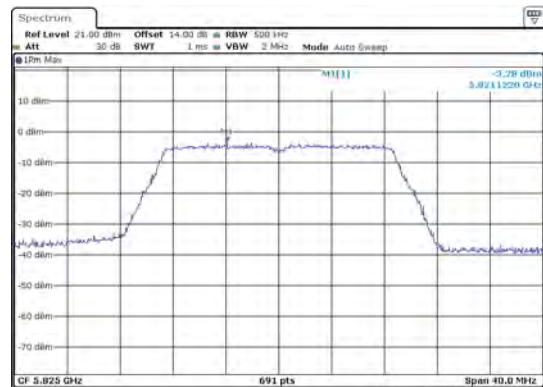
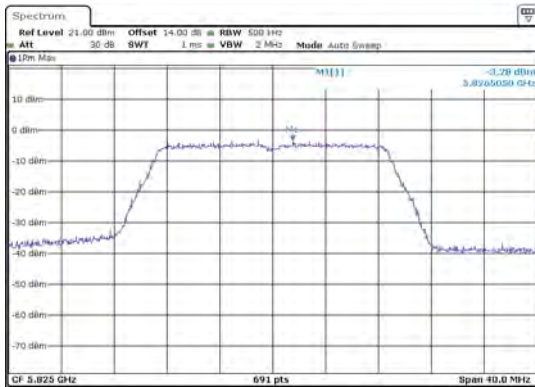
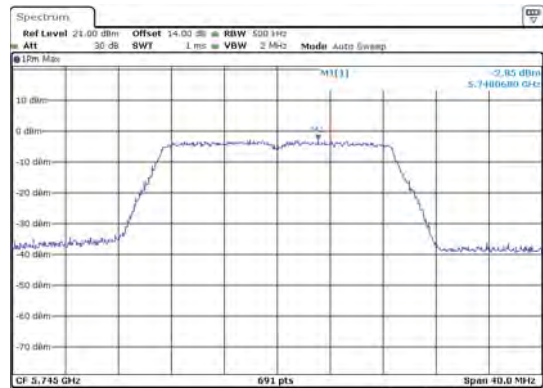
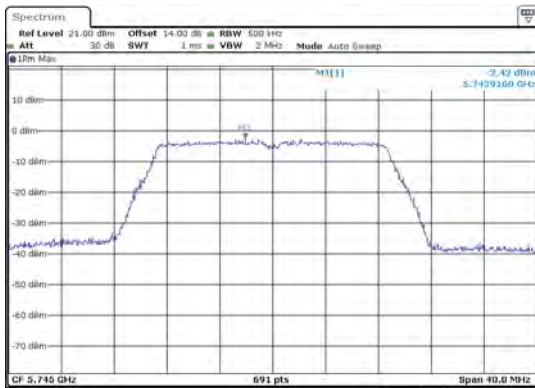
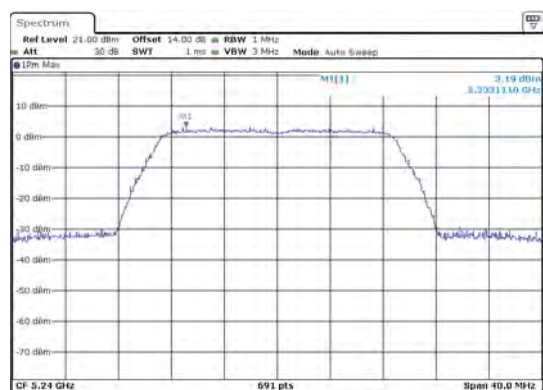
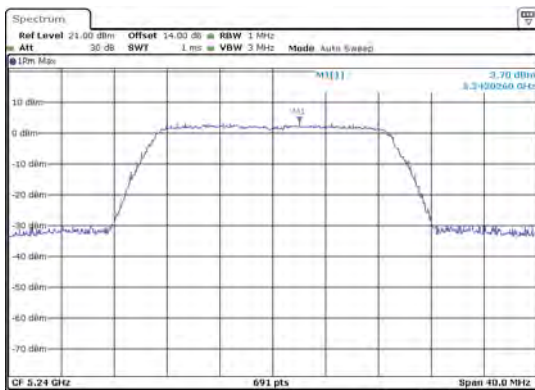
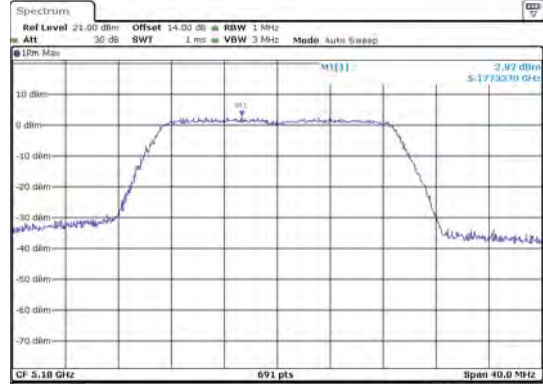

TEST MODE:MIMO

ANT 1(11N20)

ANT 2(11N20)

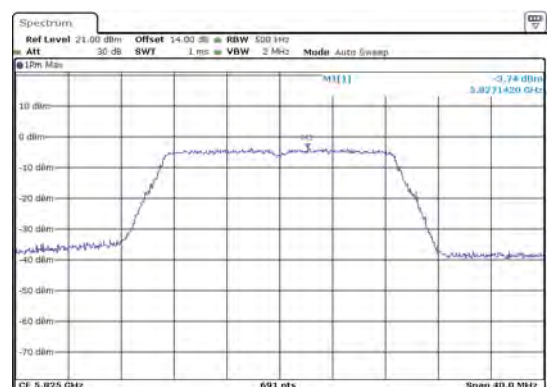
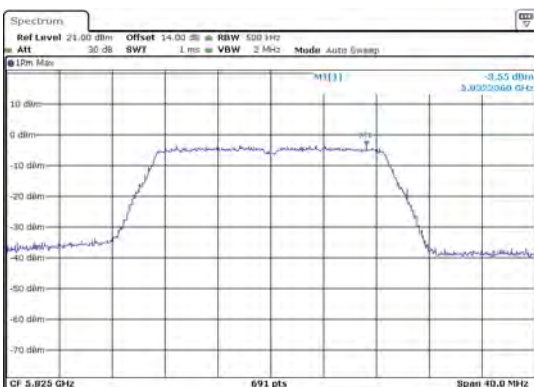
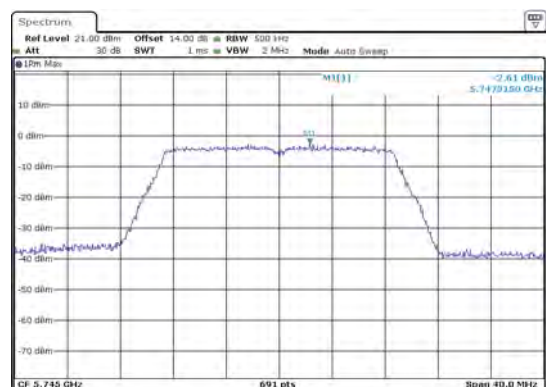
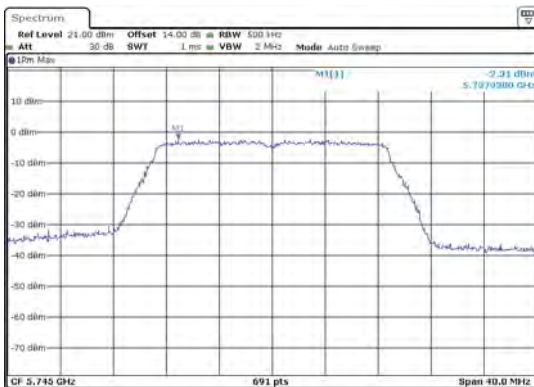
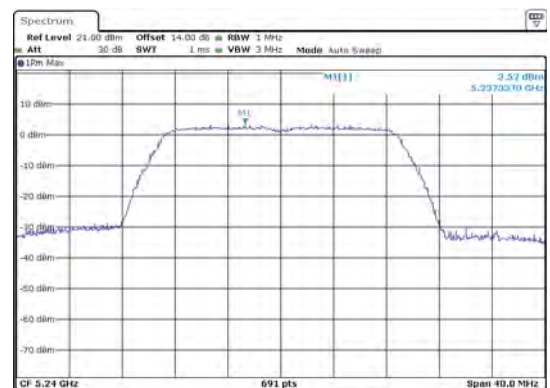
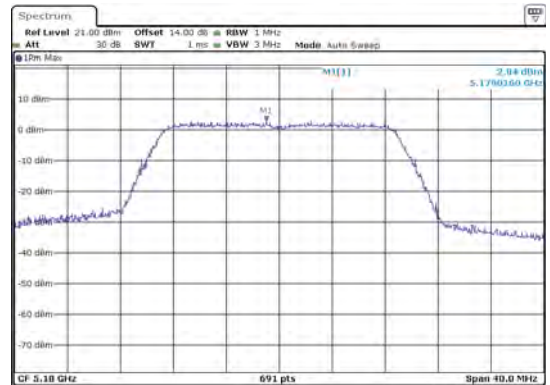
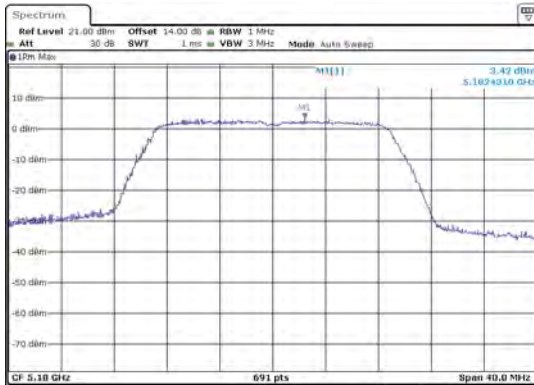

10. MAXIMUM CONDUCTED (AVERAGE) OUTPUT POWER

10.1. Block Diagram of Test Setup

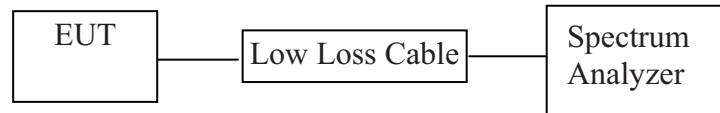

10.2. The Requirement For Section 15.407

Section 15.407: For the band 5.15–5.25 GHz, the maximum conducted output power over the frequency band of operation shall not exceed the lesser of 50 mW or $4 \text{ dBm} + 10 \log B$, where B is the 26-dB emission bandwidth in MHz.

For the band 5.725–5.825 GHz, the maximum conducted output power over the frequency band of operation shall not exceed the lesser of 1 W or $17 \text{ dBm} + 10 \log B$, where B is the 26-dB emission bandwidth in MHz.

10.3. EUT Configuration on Measurement

The equipment is installed on the emission Measurement to meet the commission requirements and operating regulations in a manner which tends to maximize its emission characteristics in normal application.

10.4. Operating Condition of EUT

10.4.1. Setup the EUT and simulator as shown as Section 10.1.

10.4.2. Turn on the power of all equipment.

10.4.3. Let the EUT work in TX modes measure it. The transmit frequency are 5150-5250 and 5725-5850MHz.

10.5. Test Procedure

10.5.1. The transmitter output was connected to the spectrum analyzer through a low loss cable.

10.5.2. Set $\text{RBW} = 1\text{-}5\%$ of the OBW, $\text{VBW} \geq 3 \times \text{RBW}$, Sweep time = auto, Set span to at least 1.5 times the OBW, Detector = RMS.

10.5.3. Measurement the Maximum conducted (average) output power.

10.6. Test Result

Final Ave output power ANT 1= Ave output power ANT 1+10log(1/x) ANT 1

Final Ave output power ANT 2= Ave output power ANT 2+10log(1/x) ANT 2

The test was performed with 802.11A					
Channel	Frequency (MHz)	Ave output power ANT 1(dBm)	Ave output power ANT 2 (dBm)	10log(1/x) ANT 1	10log(1/x) ANT 2
Low	5180	15.05	15.00	0.14	0.14
High	5240	15.29	15.53	0.14	0.14
Low	5745	12.83	12.80	0.14	0.14
High	5825	11.48	11.08	0.14	0.14

The test was performed with 802.11A						
Channel	Frequency (MHz)	Final Ave output power ANT 1(dBm)	Final Ave output power ANT 2 (dBm)	Final Ave output power ANT 1(mW)	Final Ave output power ANT 2 (mW)	Limits dBm
Low	5180	15.19	15.14	33.04	32.66	24 dBm
High	5240	15.43	15.67	34.91	36.90	24 dBm
Low	5745	12.97	12.94	19.82	19.68	30 dBm
High	5825	11.62	11.22	14.52	13.24	30 dBm

The test was performed with 802.11 N20					
Channel	Frequency (MHz)	Ave output power ANT 1(dBm)	Ave output power ANT 2 (dBm)	10log(1/x) ANT 1	10log(1/x) ANT 2
Low	5180	16.41	16.51	0.14	0.15
High	5240	16.69	16.81	0.14	0.15
Low	5745	12.43	12.69	0.14	0.15
High	5825	11.61	11.51	0.14	0.15

The test was performed with 802.11 N20						
Channel	Frequency (MHz)	Final Ave output power ANT 1(dBm)	Final Ave output power ANT 2 (dBm)	Ave output Total power (dBm)	Ave output Total power (mW)	Limits dBm
Low	5180	16.55	16.66	19.62	91.53	24 dBm
High	5240	16.83	16.96	19.91	97.85	24 dBm
Low	5745	12.57	12.84	15.72	37.30	30 dBm
High	5825	11.75	11.66	14.72	29.62	30 dBm

The spectrum analyzer plots are attached as below.

ANT 1(802.11A)

ANT 2(802.11A)

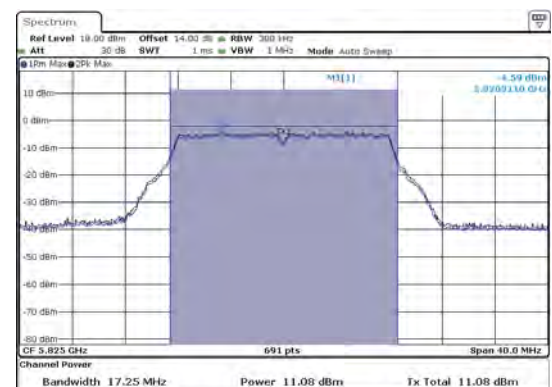
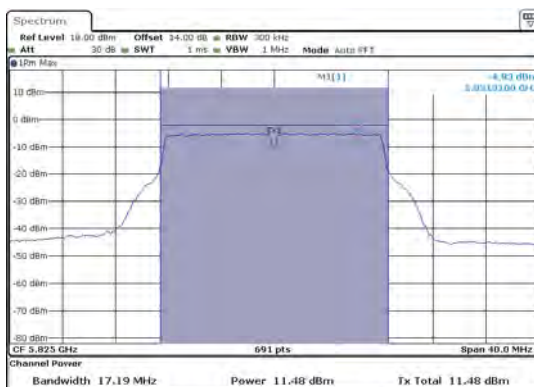
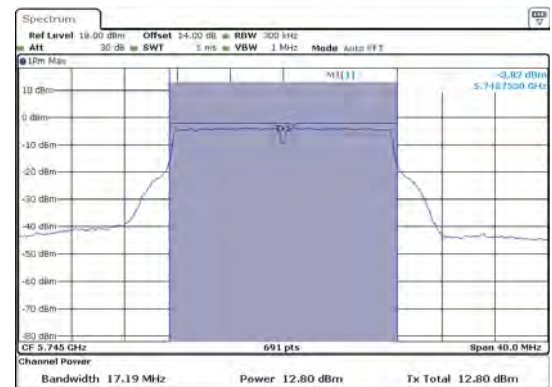
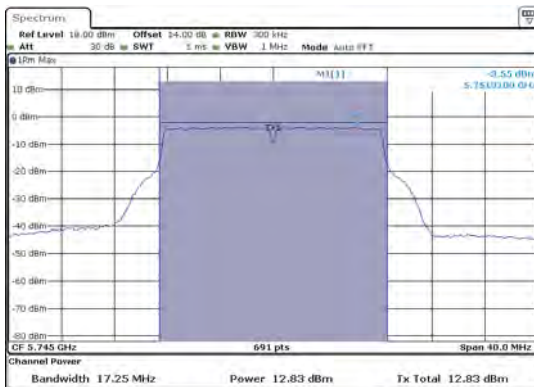
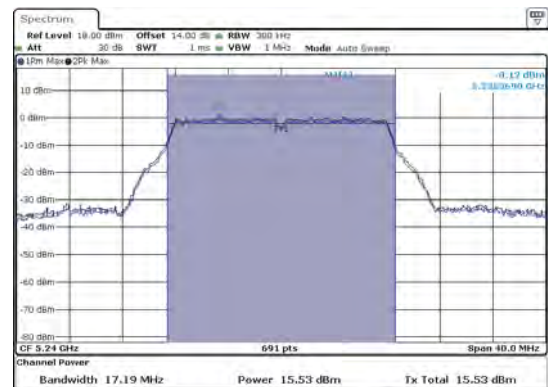
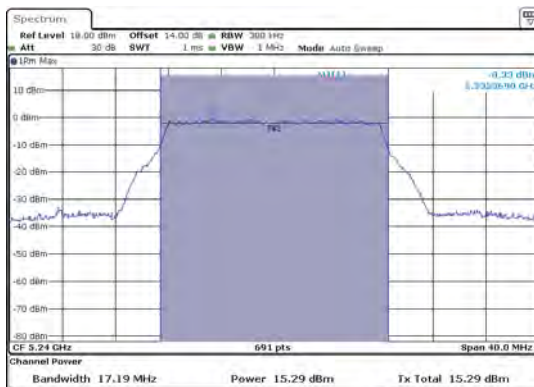
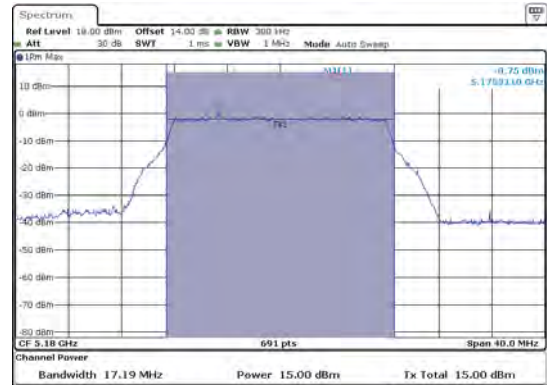
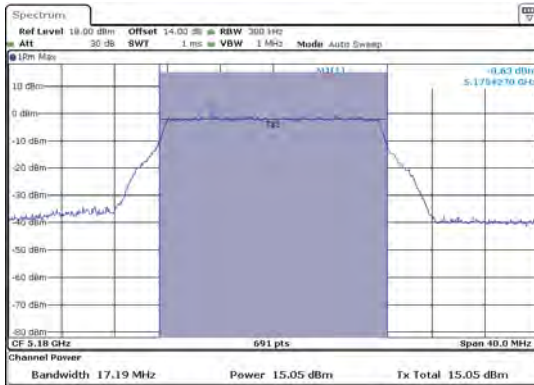

ANT 1(802.11N20)

ANT 2(802.11 N20)

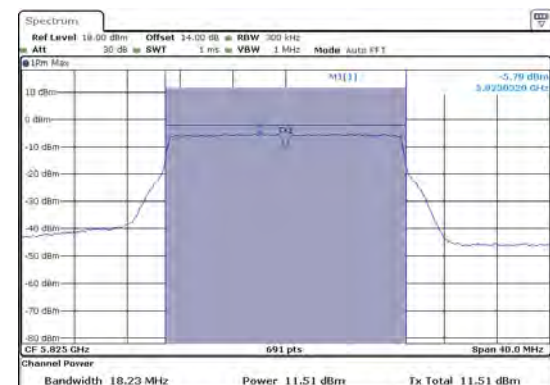
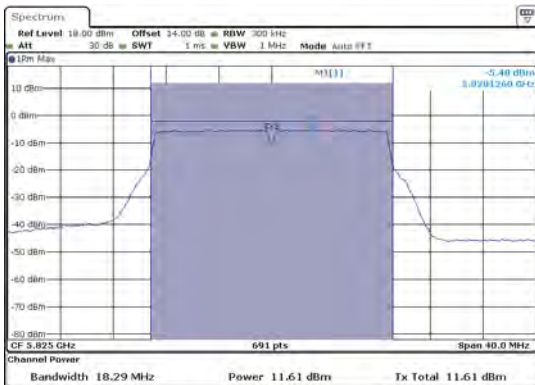
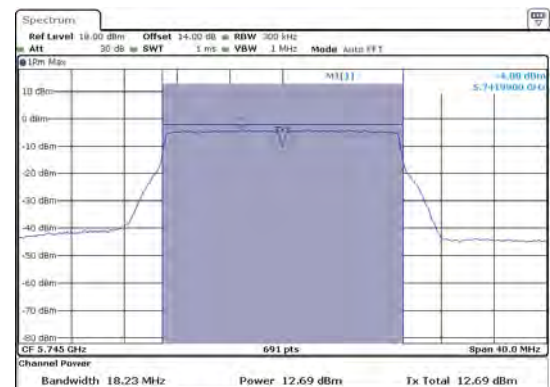
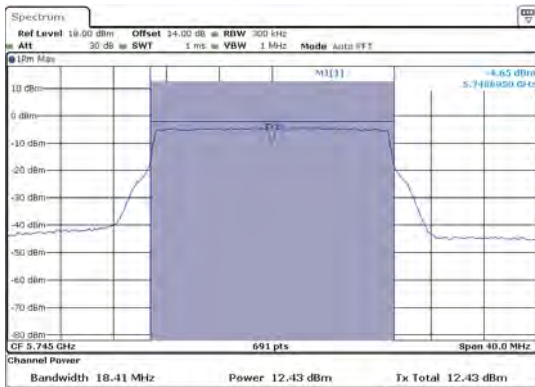
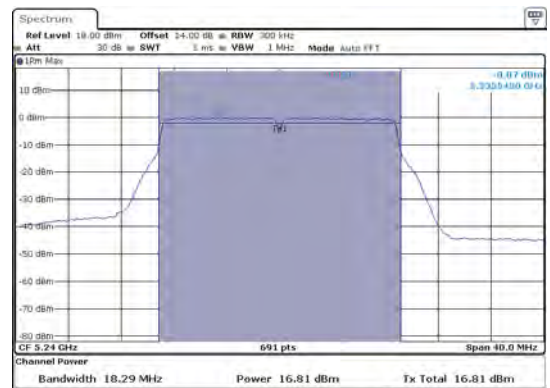
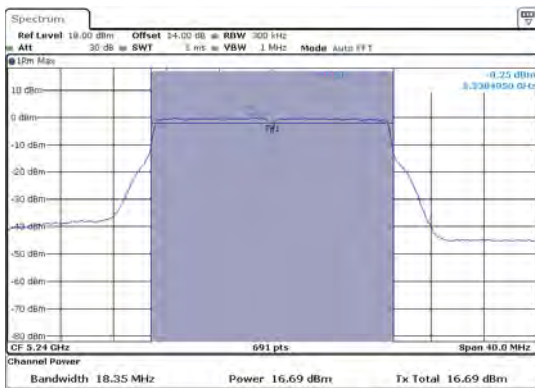
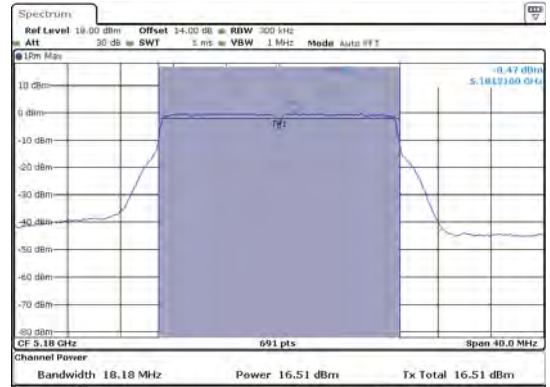
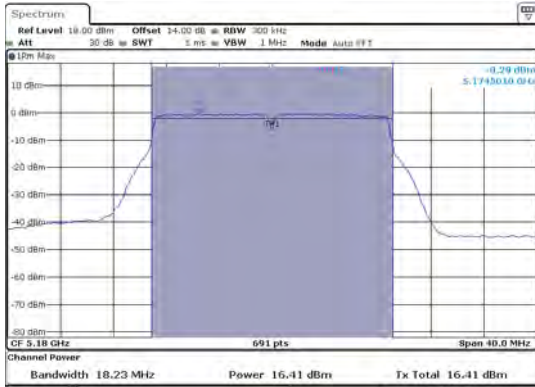

11. RADIATED SPURIOUS EMISSION TEST

11.1. Block Diagram of Test Setup

11.1.1. Block diagram of connection between the EUT and peripherals

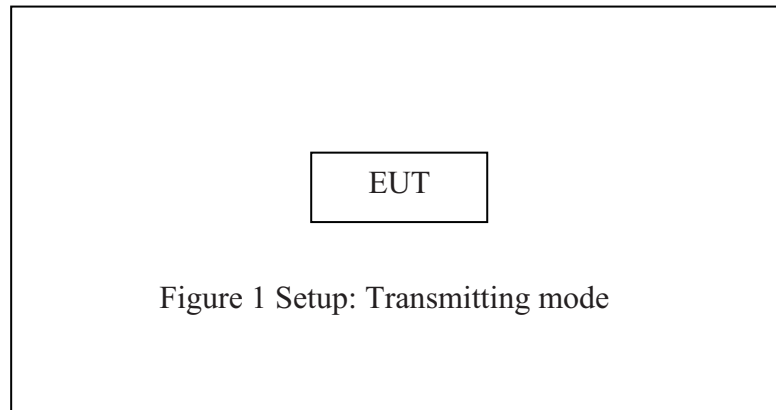

(EUT: Vaxis wireless video system)

11.1.2. Semi-Anechoic Chamber Test Setup Diagram

(A) Radiated Emission Test Set-Up, Frequency below 30MHz

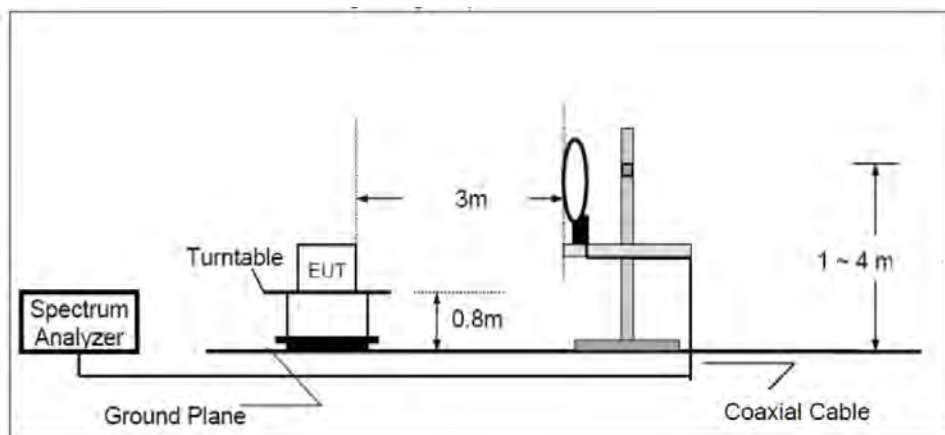

(B) Radiated Emission Test Set-Up, Frequency below 1GHz

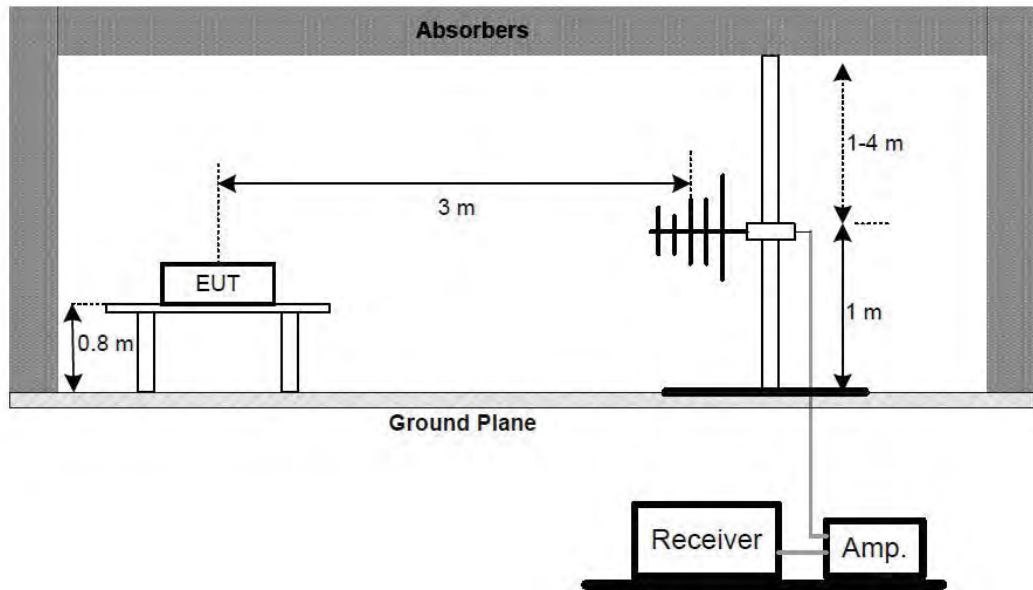

Above 1GHz:

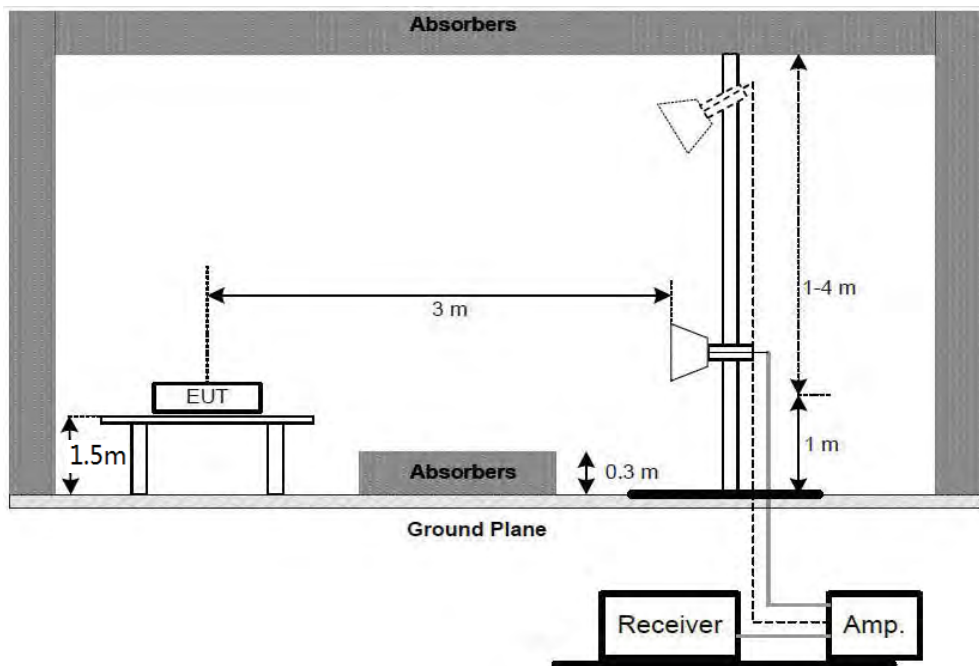

11.2.Restricted bands of operation

11.2.1.FCC Part 15.205 Restricted bands of operation

(a) Except as shown in paragraph (d) of this section, Only spurious emissions are permitted in any of the frequency bands listed below:

MHz	MHz	MHz	GHz
0.090-0.110	16.42-16.423	399.9-410	4.5-5.15
¹ 0.495-0.505	16.69475-16.69525	608-614	5.35-5.46
2.1735-2.1905	16.80425-16.80475	960-1240	7.25-7.75
4.125-4.128	25.5-25.67	1300-1427	8.025-8.5
4.17725-4.17775	37.5-38.25	1435-1626.5	9.0-9.2
4.20725-4.20775	73-74.6	1645.5-1646.5	9.3-9.5
6.215-6.218	74.8-75.2	1660-1710	10.6-12.7
6.26775-6.26825	108-121.94	1718.8-1722.2	13.25-13.4
6.31175-6.31225	123-138	2200-2300	14.47-14.5
8.291-8.294	149.9-150.05	2310-2390	15.35-16.2
8.362-8.366	156.52475-156.52525	2483.5-2500	17.7-21.4
8.37625-8.38675	156.7-156.9	2690-2900	22.01-23.12
8.41425-8.41475	162.0125-167.17	3260-3267	23.6-24.0
12.29-12.293	167.72-173.2	3332-3339	31.2-31.8
12.51975-12.52025	240-285	3345.8-3358	36.43-36.5
12.57675-12.57725	322-335.4	3600-4400	(²)
13.36-13.41			

¹Until February 1, 1999, this restricted band shall be 0.490-0.510

²Above 38.6

(b) Except as provided in paragraphs (d) and (e), the field strength of emission appearing within these frequency bands shall not exceed the limits shown in Section 15.209.

At frequencies equal to or less than 1000MHz, Compliance with the limits in Section 15.209 shall be demonstrated using measurement instrumentation employing a CISPR quasi-peak detector. Above 1000MHz, compliance with the emission limits in Section 15.209 shall be demonstrated

based on the average value of the measured emissions. The provisions in Section 15.35 apply to these measurements.

11.3.Configuration of EUT on Measurement

The equipment are installed on Radiated Emission Measurement to meet the commission requirements and operating regulations in a manner which tends to maximize its emission characteristics in normal application.

11.4.The Limit For Section 15.407

Section 15.247(d): For transmitters operating in the 5.15–5.25 GHz band: all emissions out-side of the 5.15–5.35 GHz band shall not exceed an EIRP of –27dBm/MHz.

For transmitters operating in the 5.725–5.825 GHz band: all emissions within the frequency range from the band edge to 10 MHz above or below the band edge shall not exceed an EIRP of –17dBm/MHz; for frequencies 10 MHz or greater above or below the band edge, emissions shall not exceed an EIRP of –27dBm/MHz.

11.5.Operating Condition of EUT

11.5.1.Setup the EUT and simulator as shown as Section 11.1.

11.5.2.Turn on the power of all equipment.

11.5.3.Let the EUT work in TX modes measure it. The transmit frequency are 5150-5250 and 5725-5850MHz.

11.6.Test Procedure

The EUT and its simulators are placed on a turntable, which is 0.8 meter high above ground(Below 1GHz). The EUT and its simulators are placed on a turntable, which is 1.5 meter high above ground(Above 1GHz). The turntable can rotate 360 degrees to determine the position of the maximum emission level. EUT is set 3.0 meters away from the receiving antenna, which is mounted on an antenna tower. The antenna can be moved up and down between 1.0 meter and 4 meters to find out the maximum emission level. Broadband antenna (calibrated bi-log antenna) is used as receiving antenna. Both horizontal and vertical polarizations of the antenna are set on measurement. In order to find the maximum emission levels, all of the EUT location must be manipulated according to ANSI C63.10:2013 on radiated emission measurement. The EUT was tested in 3 orthogonal planes.

The frequency range from 9KHz to 40000MHz is checked.

Result = Reading + Corrected Factor

Where Corrected Factor = Antenna Factor + Cable Loss – Amplifier Gain

During the radiated emission test, the spectrum analyzer was set with the following configurations:

1. The resolution bandwidth and video bandwidth of test receiver/spectrum analyzer is 120kHz for Quasi-peak at frequency below 1GHz.
2. The resolution bandwidth of test receiver/spectrum analyzer is 1MHz and video bandwidth is 3MHz for peak measurement with peak detector at frequency above 1GHz.
3. The resolution bandwidth of test receiver/spectrum analyzer is 1MHz and video bandwidth is 10Hz for Average measurement with peak detection at frequency above 1GHz.
4. All modes of operation were investigated and the worst-case emissions are reported.

11.7.DATA SAMPLE

Frequency (MHz)	Reading (dB μ v)	Factor (dB/m)	Result (dB μ v/m)	Limit (dB μ v/m)	Margin (dB)	Remark
X.XX	49.83	-22.03	27.80	43.50	-15.70	QP

Frequency(MHz) = Emission frequency in MHz

Reading(dB μ v) = Uncorrected Analyzer/Receiver reading

Factor (dB/m)= Antenna factor + Cable Loss – Amplifier gain

Result(dB μ v/m) = Reading + Factor

Limit (dB μ v/m)= Limit stated in standard

Margin (dB) = Result(dB μ v/m) - Limit (dB μ v/m)

Calculation Formula:

Margin(dB) = Result (dB μ v/m)–Limit(dB μ v/m)

Result(dB μ v/m)= Reading(dB μ v)+ Factor(dB/m)

The “Margin” column of the following data tables indicates the degree of compliance with the applicable limit. For example, a margin of -7dB means the emission is 7dB below the limit.

11.8.The Field Strength of Radiation Emission Measurement Results

Note: 1. Emissions attenuated more than 20 dB below the permissible value are not reported.

2. *: Denotes restricted band of operation.

3. The fundamental radiated emissions were reduced by Band Reject Filter in the attached plots.

4. The EUT is tested radiation emission at each test mode (802.11a/n) in three axes. Besides, We have tested the single antenna transmit mode and the dual antenna emission mode. The worst emissions are reflected in the following plots.

5. The radiation emissions from 9kHz-30MHz is not reported, because the test values lower than the limits of 20dB.

6. The average measurement was not performed when peak measured data under the limit of average detection.

Below 1G

Job No.: FRANK2019-W #447

Standard: FCC Class B 3M Radiated

Test item: Radiation Test

Temp.(C)/Hum.(%) 25 C / 55 %

EUT: Vaxis wireless video system

Mode: TX 5180MHz(802.11N)

Model: Vaxis Atom 500

Manufacturer: Hunan GM innovation technology Co., Ltd.

Polarization: Horizontal

Power Source: DC 7.4V

Date: 2019/12/06

Time: 16:08:00

Engineer Signature: CHARLEY

Distance: 3m

Note: Report NO.:ATE20191739

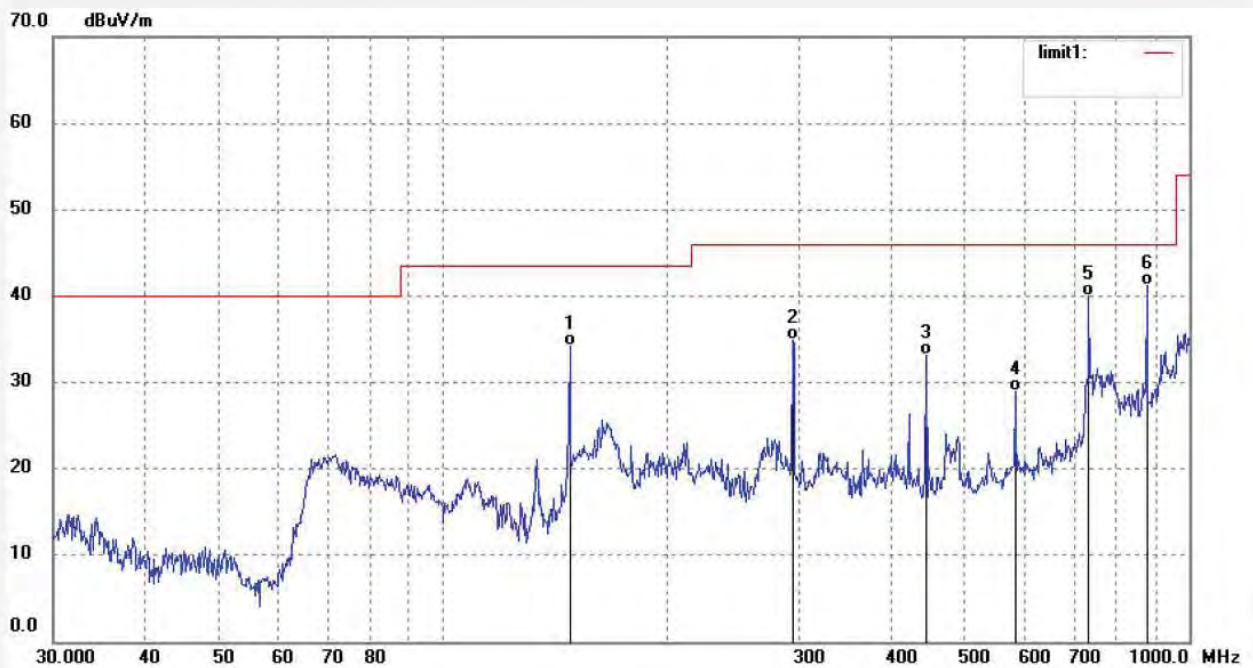

No.	Freq. (MHz)	Reading (dBuV/m)	Factor (dB)	Result (dBuV/m)	Limit (dBuV/m)	Margin (dB)	Detector	Height (cm)	Degree (deg.)	Remark
1	147.8745	62.31	-28.05	34.26	43.50	-9.24	QP	200	309	
2	294.4259	56.45	-21.45	35.00	46.00	-11.00	QP	200	84	
3	444.1299	50.52	-17.39	33.13	46.00	-12.87	QP	200	215	
4	584.1611	42.90	-14.02	28.88	46.00	-17.12	QP	200	332	
5	734.0371	50.66	-10.69	39.97	46.00	-6.03	QP	200	169	
6	878.0931	48.73	-7.56	41.17	46.00	-4.83	QP	200	326	

Job No.: FRANK2019-W #446

Standard: FCC Class B 3M Radiated

Test item: Radiation Test

Temp.(C)/Hum.(%) 25 C / 55 %

EUT: Vaxis wireless video system

Mode: TX 5180MHz(802.11N)

Model: Vaxis Atom 500

Manufacturer: Hunan GM innovation technology Co., Ltd.

Polarization: Vertical

Power Source: DC 7.4V

Date: 2019/12/06

Time: 16:06:25

Engineer Signature: CHARLEY

Distance: 3m

Note: Report NO.:ATE20191739

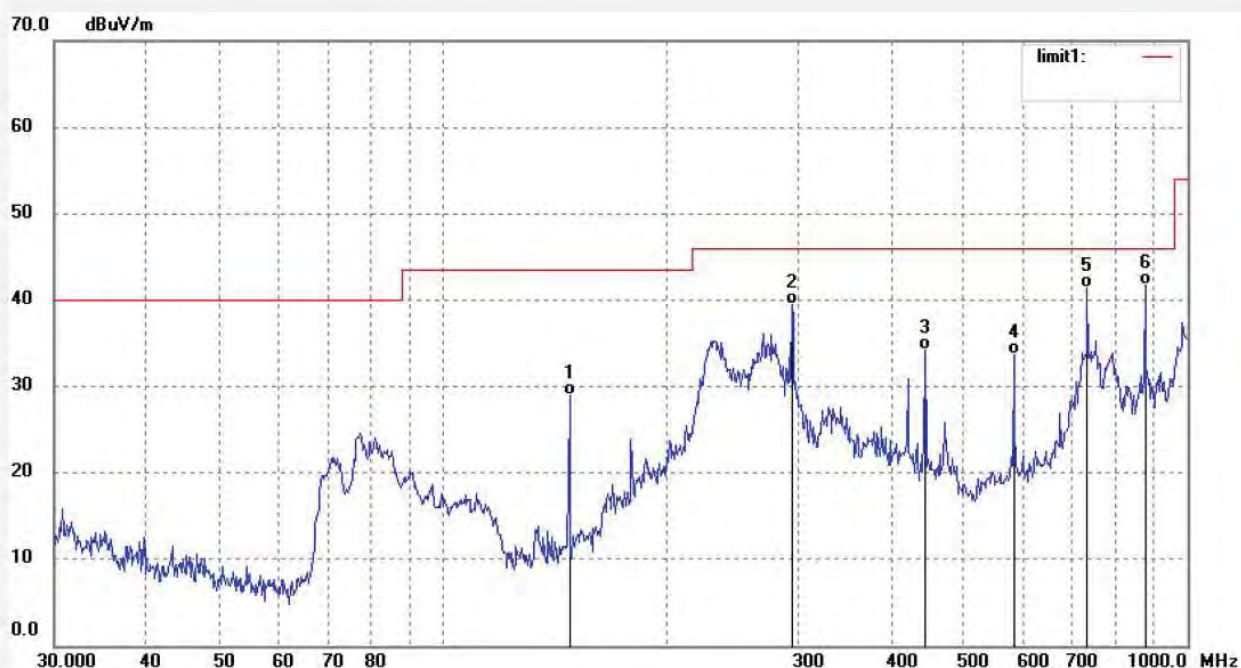

No.	Freq. (MHz)	Reading (dBuV/m)	Factor (dB)	Result (dBuV/m)	Limit (dBuV/m)	Margin (dB)	Detector	Height (cm)	Degree (deg.)	Remark
1	147.8745	56.93	-28.05	28.88	43.50	-14.62	QP	100	251	
2	294.4259	60.85	-21.45	39.40	46.00	-6.60	QP	100	109	
3	444.1299	51.66	-17.39	34.27	46.00	-11.73	QP	100	118	
4	584.1611	47.69	-14.02	33.67	46.00	-12.33	QP	100	92	
5	734.0371	52.07	-10.69	41.38	46.00	-4.62	QP	100	115	
6	878.0931	49.22	-7.56	41.66	46.00	-4.34	QP	100	302	

Job No.: FRANK2019-W #448

Standard: FCC Class B 3M Radiated

Test item: Radiation Test

Temp.(C)/Hum.(%) 25 C / 55 %

EUT: Vaxis wireless video system

Mode: TX 5240MHz(802.11N)

Model: Vaxis Atom 500

Manufacturer: Hunan GM innovation technology Co., Ltd.

Polarization: Horizontal

Power Source: DC 7.4V

Date: 2019/12/06

Time: 16:22:14

Engineer Signature: CHARLEY

Distance: 3m

Note: Report NO.:ATE20191739

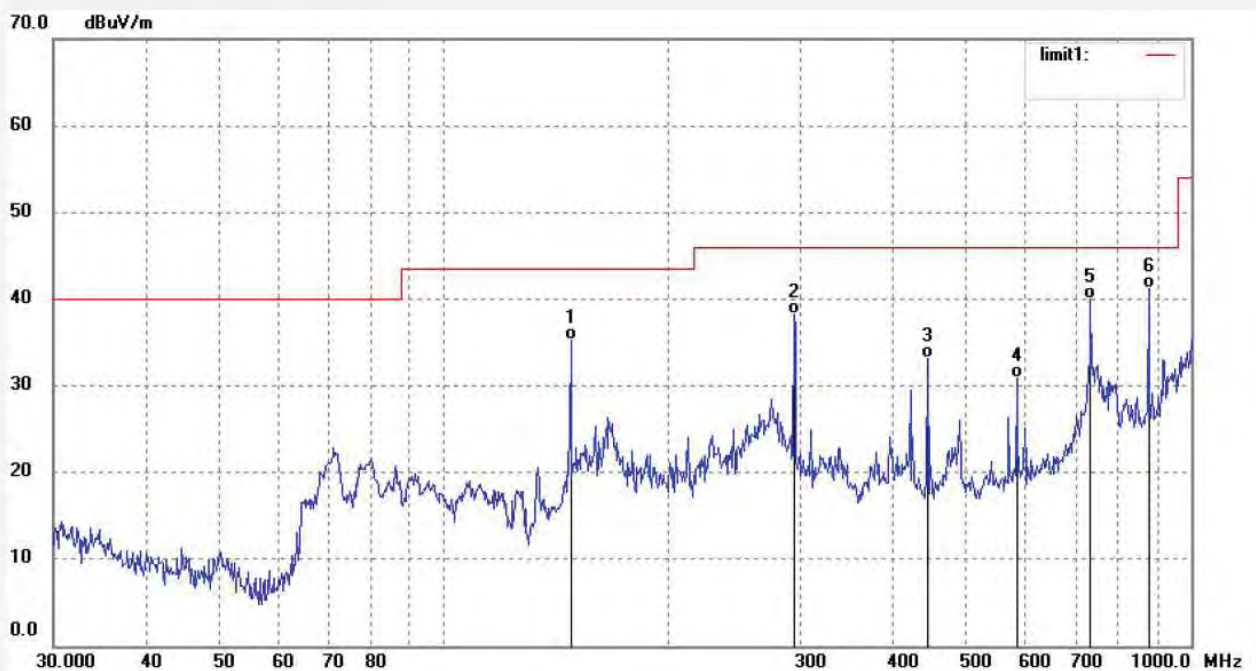

No.	Freq. (MHz)	Reading (dBuV/m)	Factor (dB)	Result (dBuV/m)	Limit (dBuV/m)	Margin (dB)	Detector	Height (cm)	Degree (deg.)	Remark
1	147.8745	63.32	-28.05	35.27	43.50	-8.23	QP	200	302	
2	294.4259	59.65	-21.45	38.20	46.00	-7.80	QP	200	210	
3	444.1299	50.47	-17.39	33.08	46.00	-12.92	QP	200	201	
4	584.1611	44.93	-14.02	30.91	46.00	-15.09	QP	200	58	
5	734.0371	50.70	-10.69	40.01	46.00	-5.99	QP	200	324	
6	878.0931	48.73	-7.56	41.17	46.00	-4.83	QP	200	106	

Job No.: FRANK2019-W #449

Standard: FCC Class B 3M Radiated

Test item: Radiation Test

Temp.(C)/Hum.(%) 25 C / 55 %

EUT: Vaxis wireless video system

Mode: TX 5240MHz(802.11N)

Model: Vaxis Atom 500

Manufacturer: Hunan GM innovation technology Co., Ltd.

Polarization: Vertical

Power Source: DC 7.4V

Date: 2019/12/06

Time: 16:24:07

Engineer Signature: CHARLEY

Distance: 3m

Note: Report NO.:ATE20191739

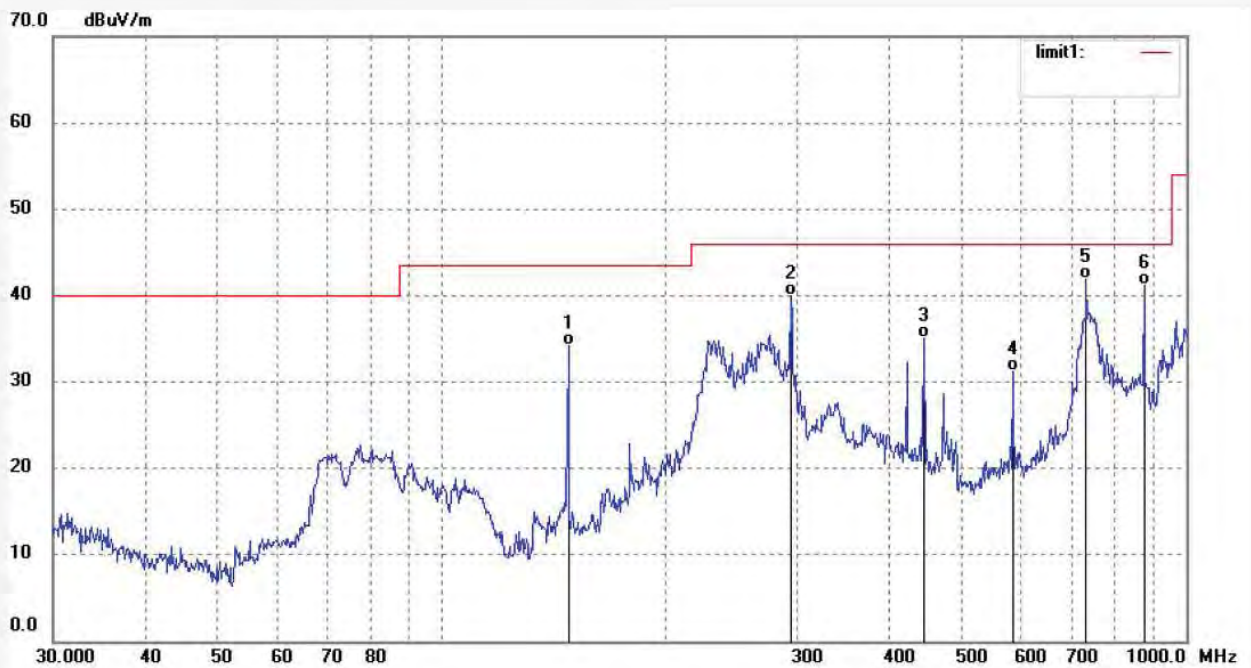

No.	Freq. (MHz)	Reading (dBuV/m)	Factor (dB)	Result (dBuV/m)	Limit (dBuV/m)	Margin (dB)	Detector	Height (cm)	Degree (deg.)	Remark
1	147.8745	62.30	-28.05	34.25	43.50	-9.25	QP	100	66	
2	294.4259	61.49	-21.45	40.04	46.00	-5.96	QP	100	305	
3	444.1299	52.41	-17.39	35.02	46.00	-10.98	QP	100	221	
4	584.1611	45.30	-14.02	31.28	46.00	-14.72	QP	100	93	
5	734.0371	52.53	-10.69	41.84	46.00	-4.16	QP	100	11	
6	878.0931	48.76	-7.56	41.20	46.00	-4.80	QP	100	302	

Job No.: FRANK2019-W #451

Standard: FCC Class B 3M Radiated

Test item: Radiation Test

Temp.(C)/Hum.(%) 25 C / 55 %

EUT: Vaxis wireless video system

Mode: TX 5745MHz(802.11N)

Model: Vaxis Atom 500

Manufacturer: Hunan GM innovation technology Co., Ltd.

Polarization: Horizontal

Power Source: DC 7.4V

Date: 2019/12/06

Time: 16:28:17

Engineer Signature: CHARLEY

Distance: 3m

Note: Report NO.:ATE20191739

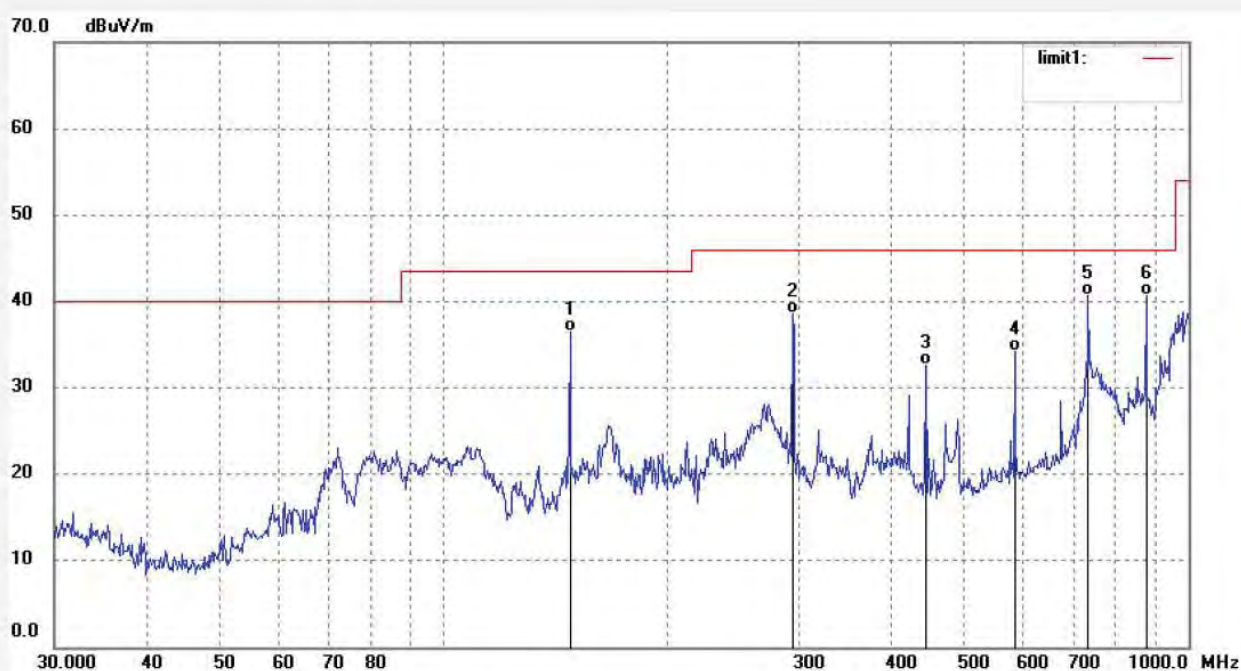

No.	Freq. (MHz)	Reading (dBuV/m)	Factor (dB)	Result (dBuV/m)	Limit (dBuV/m)	Margin (dB)	Detector	Height (cm)	Degree (deg.)	Remark
1	147.8745	64.57	-28.05	36.52	43.50	-6.98	QP	200	247	
2	294.4259	60.11	-21.45	38.66	46.00	-7.34	QP	200	331	
3	444.1299	50.07	-17.39	32.68	46.00	-13.32	QP	200	82	
4	584.1611	48.17	-14.02	34.15	46.00	-11.85	QP	200	118	
5	734.0371	51.37	-10.69	40.68	46.00	-5.32	QP	200	32	
6	878.0931	48.18	-7.56	40.62	46.00	-5.38	QP	200	305	

Job No.: FRANK2019-W #450

Standard: FCC Class B 3M Radiated

Test item: Radiation Test

Temp.(C)/Hum.(%) 25 C / 55 %

EUT: Vaxis wireless video system

Mode: TX 5745MHz(802.11N)

Model: Vaxis Atom 500

Manufacturer: Hunan GM innovation technology Co., Ltd.

Polarization: Vertical

Power Source: DC 7.4V

Date: 2019/12/06

Time: 16:25:54

Engineer Signature: CHARLEY

Distance: 3m

Note: Report NO.:ATE20191739

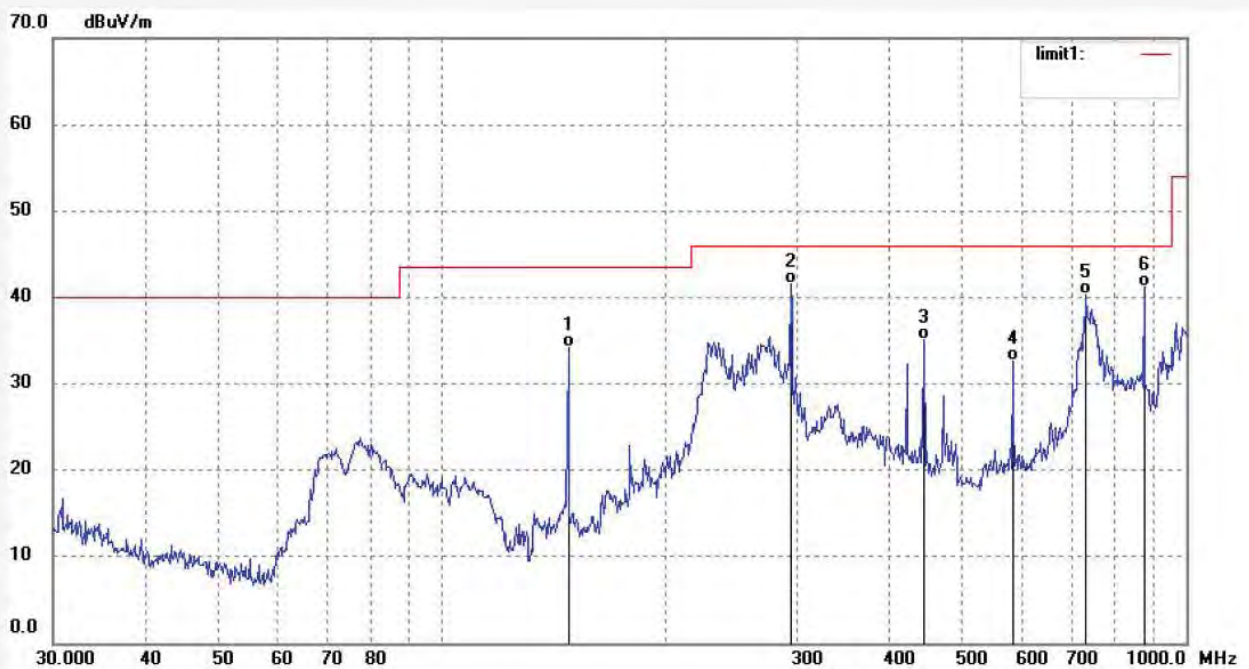

No.	Freq. (MHz)	Reading (dBuV/m)	Factor (dB)	Result (dBuV/m)	Limit (dBuV/m)	Margin (dB)	Detector	Height (cm)	Degree (deg.)	Remark
1	147.8745	62.30	-28.05	34.25	43.50	-9.25	QP	100	116	
2	294.4259	62.99	-21.45	41.54	46.00	-4.46	QP	100	201	
3	444.1299	52.41	-17.39	35.02	46.00	-10.98	QP	100	331	
4	584.1611	46.58	-14.02	32.56	46.00	-13.44	QP	100	96	
5	734.0371	51.03	-10.69	40.34	46.00	-5.66	QP	100	115	
6	878.0931	48.76	-7.56	41.20	46.00	-4.80	QP	100	302	

Job No.: FRANK2019-W #452

Standard: FCC Class B 3M Radiated

Test item: Radiation Test

Temp.(C)/Hum.(%) 25 C / 55 %

EUT: Vaxis wireless video system

Mode: TX 5825MHz(802.11N)

Model: Vaxis Atom 500

Manufacturer: Hunan GM innovation technology Co., Ltd.

Polarization: Horizontal

Power Source: DC 7.4V

Date: 2019/12/06

Time: 16:29:00

Engineer Signature: CHARLEY

Distance: 3m

Note: Report NO.:ATE20191739

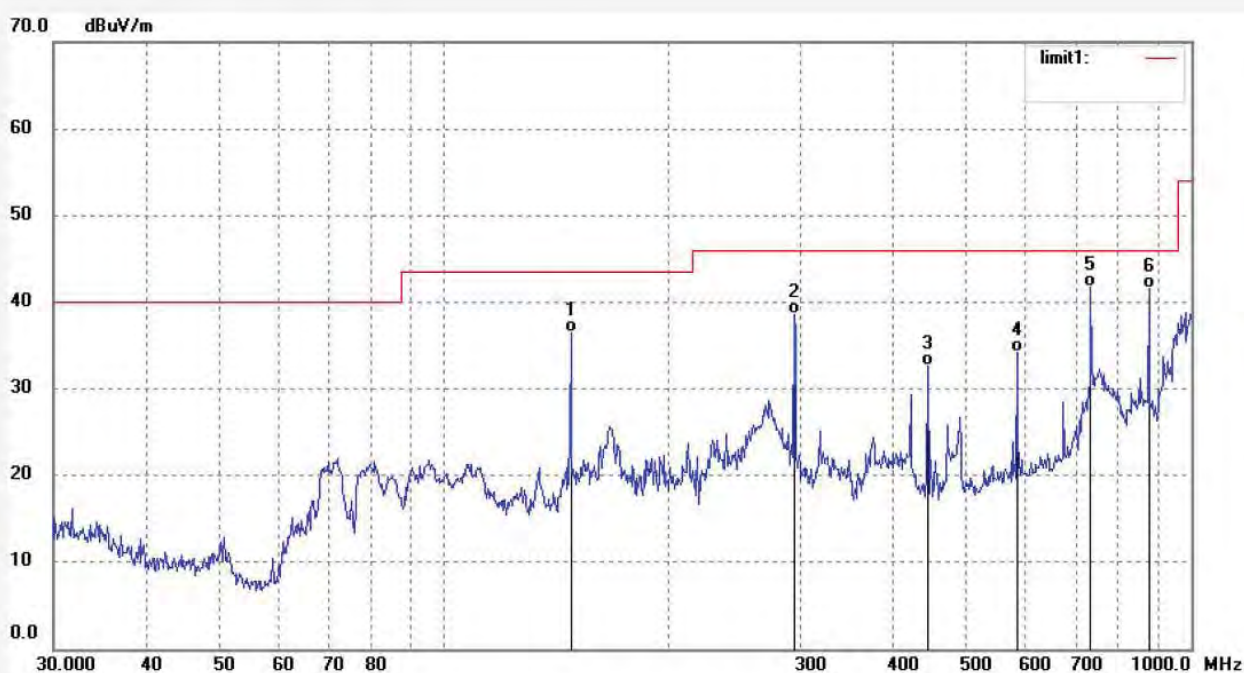

No.	Freq. (MHz)	Reading (dBuV/m)	Factor (dB)	Result (dBuV/m)	Limit (dBuV/m)	Margin (dB)	Detector	Height (cm)	Degree (deg.)	Remark
1	147.8745	64.57	-28.05	36.52	43.50	-6.98	QP	200	302	
2	294.4259	60.11	-21.45	38.66	46.00	-7.34	QP	200	55	
3	444.1299	50.07	-17.39	32.68	46.00	-13.32	QP	200	218	
4	584.1611	48.31	-14.02	34.29	46.00	-11.71	QP	200	96	
5	734.0371	52.37	-10.69	41.68	46.00	-4.32	QP	200	219	
6	878.0931	49.18	-7.56	41.62	46.00	-4.38	QP	200	306	

Job No.: FRANK2019-W #453

Standard: FCC Class B 3M Radiated

Test item: Radiation Test

Temp.(C)/Hum.(%) 25 C / 55 %

EUT: Vaxis wireless video system

Mode: TX 5825MHz(802.11N)

Model: Vaxis Atom 500

Manufacturer: Hunan GM innovation technology Co., Ltd.

Polarization: Vertical

Power Source: DC 7.4V

Date: 2019/12/06

Time: 16:30:50

Engineer Signature: CHARLEY

Distance: 3m

Note: Report NO.:ATE20191739

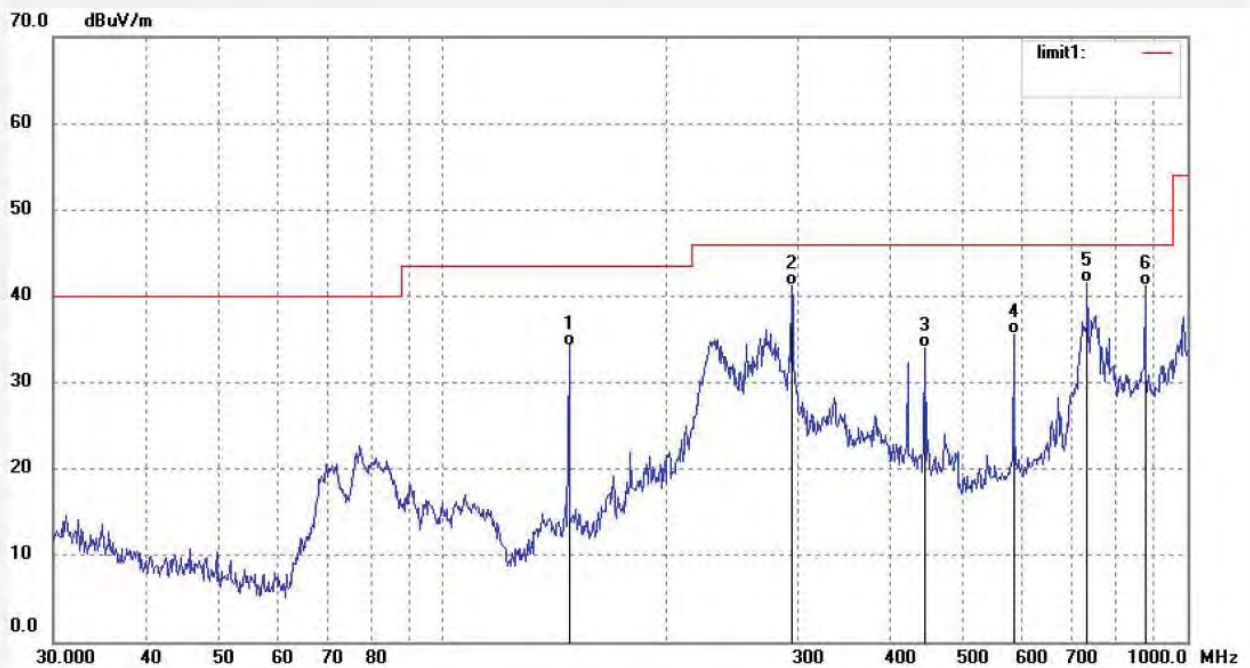

No.	Freq. (MHz)	Reading (dBuV/m)	Factor (dB)	Result (dBuV/m)	Limit (dBuV/m)	Margin (dB)	Detector	Height (cm)	Degree (deg.)	Remark
1	147.8745	62.35	-28.05	34.30	43.50	-9.20	QP	100	224	
2	294.4259	62.61	-21.45	41.16	46.00	-4.84	QP	100	216	
3	444.1299	51.35	-17.39	33.96	46.00	-12.04	QP	100	302	
4	584.1611	49.55	-14.02	35.53	46.00	-10.47	QP	100	61	
5	734.0371	52.30	-10.69	41.61	46.00	-4.39	QP	100	116	
6	878.0931	48.70	-7.56	41.14	46.00	-4.86	QP	100	302	

Above 1G(1G-26.5GHz)

802.11A(20MHz) TX Mode:

Indicated		Detector (PK/AV)	Table Angle Degree	Antenna		Correction Factor			FCC Part 15.407			
Frequency (MHz)	Receiver Reading (dBμV)			Height (m)	Polar (H/V)	Ant. Factor (dB/m)	Cable Loss (dB)	Pre-Amp. Gain (dB)	Cord. Amp. (dBμV/m)	Limit (dBμV/m)	Margin (dB)	Comment
Channel 36 (5180 MHz)												
10360	39.75	AV	128	1.5	V	31.2	4.3	26.7	48.55	54	5.45	harmonic
10360	38.12	AV	15	1.5	H	31.2	4.3	26.7	46.92	54	7.08	harmonic
10360	52.81	PK	128	1.5	V	31.2	4.3	26.7	61.61	74	12.39	harmonic
10360	51.98	PK	15	1.5	H	31.2	4.3	26.7	60.78	74	13.22	harmonic
Channel 48 (5240 MHz)												
10480	39.72	AV	310	1.5	V	31.2	4.3	26.7	48.52	54	5.48	harmonic
10480	37.15	AV	10	1.5	H	31.2	4.3	26.7	45.95	54	8.05	harmonic
10480	52.13	PK	310	1.5	V	31.2	4.3	26.7	60.93	74	13.07	harmonic
10480	51.53	PK	10	1.5	H	31.2	4.3	26.7	60.33	74	13.67	harmonic
Channel 149 (5745 MHz)												
11490	36.41	AV	125	1.5	V	31.9	4.4	26.6	46.11	54	7.89	harmonic
11490	36.24	AV	130	1.5	H	31.9	4.4	26.6	45.94	54	8.06	harmonic
11490	50.22	PK	125	1.5	V	31.9	4.4	26.6	59.92	74	14.08	harmonic
11490	49.42	PK	130	1.5	H	31.9	4.4	26.6	59.12	74	14.88	harmonic
Channel 165 (5825 MHz)												
11650	37.41	AV	25	1.5	V	31.9	4.4	26.6	47.11	54	6.89	harmonic
11650	37.24	AV	125	1.5	H	31.9	4.4	26.6	46.94	54	7.06	harmonic
11650	51.22	PK	25	1.5	V	31.9	4.4	26.6	60.92	74	13.08	harmonic
11650	50.42	PK	125	1.5	H	31.9	4.4	26.6	60.12	74	13.88	harmonic

802.11N(20MHz) TX Mode:

Indicated		Detector (PK/AV)	Table Angle Degree	Antenna		Correction Factor			FCC Part 15.407			
Frequency (MHz)	Receiver Reading (dBμV)			Height (m)	Polar (H/V)	Ant. Factor (dB/m)	Cable Loss (dB)	Pre-Amp. Gain (dB)	Cord. Amp. (dBμV/m)	Limit (dBμV/m)	Margin (dB)	Comment
Channel 36 (5180 MHz)												
10360	38.13	AV	146	1.5	V	31.2	4.3	26.7	46.93	54	7.07	harmonic
10360	37.64	AV	127	1.5	H	31.2	4.3	26.7	46.44	54	7.56	harmonic
10360	51.06	PK	146	1.5	V	31.2	4.3	26.7	59.86	74	14.14	harmonic
10360	50.48	PK	127	1.5	H	31.2	4.3	26.7	59.28	74	14.72	harmonic
Channel 48 (5240 MHz)												
10480	37.13	AV	330	1.5	V	31.2	4.3	26.7	45.93	54	8.07	harmonic
10480	36.87	AV	109	1.5	H	31.2	4.3	26.7	45.67	54	8.33	harmonic
10480	50.18	PK	330	1.5	V	31.2	4.3	26.7	58.98	74	15.02	harmonic
10480	49.32	PK	109	1.5	H	31.2	4.3	26.7	58.12	74	15.88	harmonic
Channel 149 (5745 MHz)												
11490	35.56	AV	167	1.5	V	31.9	4.4	26.6	45.26	54	8.74	harmonic
11490	37.10	AV	192	1.5	H	31.9	4.4	26.6	46.80	54	7.20	harmonic
11490	49.56	PK	167	1.5	V	31.9	4.4	26.6	59.26	74	14.74	harmonic
11490	48.45	PK	192	1.5	H	31.9	4.4	26.6	58.15	74	15.85	harmonic
Channel 165 (5825 MHz)												
11650	36.17	AV	225	1.5	V	31.9	4.4	26.6	45.87	54	8.13	harmonic
11650	36.78	AV	118	1.5	H	31.9	4.4	26.6	46.48	54	7.52	harmonic
11650	50.83	PK	225	1.5	V	31.9	4.4	26.6	60.53	74	13.47	harmonic
11650	51.02	PK	118	1.5	H	31.9	4.4	26.6	60.72	74	13.28	harmonic

Test mode: 802.11a, N20 TX Frequency: 5180MHz, 5240MHz

The EUT is tested radiation emission at each test mode in three axes. Besides, We have tested the single antenna transmit mode and the dual antenna emission mode. The worst emissions are reflected in the following plots

Common Information

Test Site: SMQ EMC Lab.
Environment Conditions:
Antenna Polarization: Horizontal
Operator Name:
Comment:

Copy of FCC Electric Field Strength 26.5-40GHz

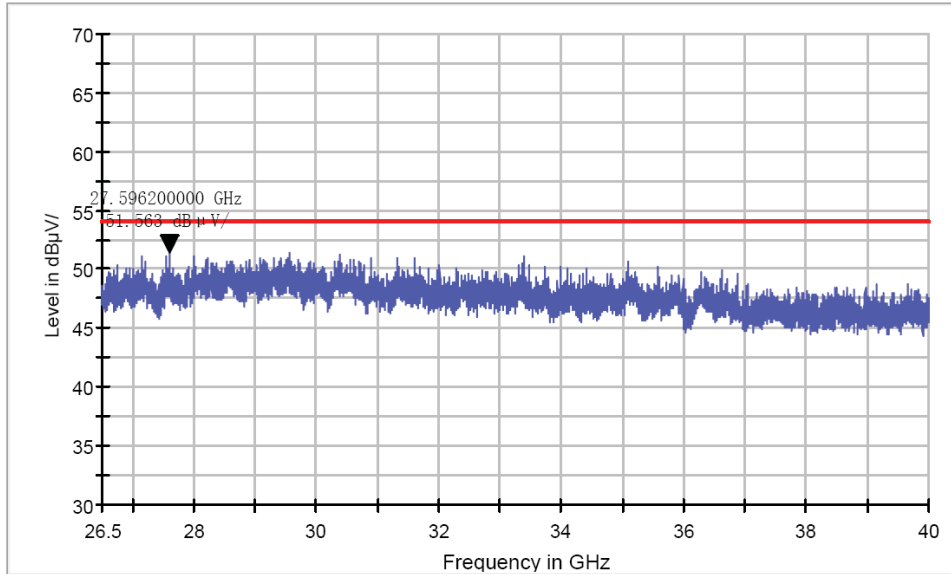

Common Information

Test Site: SMQ EMC Lab.
Environment Conditions:
Antenna Polarization: Vertical
Operator Name:
Comment:

Copy of FCC Electric Field Strength 26.5-40GHz

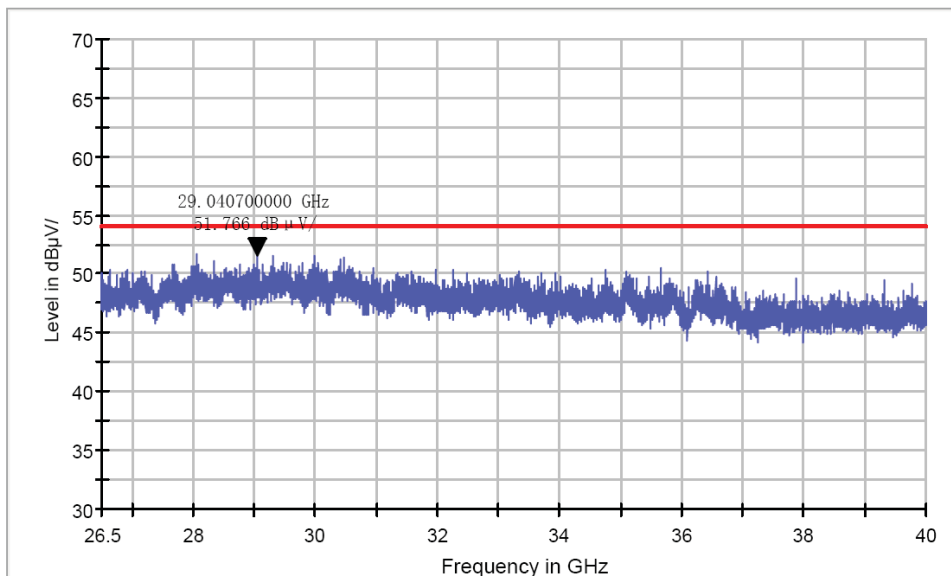

Test mode: 802.11a,N20 TX Frequency: 5745MHz, 5825MHz

The EUT is tested radiation emission at each test mode in three axes. Besides, We have tested the single antenna transmit mode and the dual antenna emission mode. The worst emissions are reflected in the following plots

Common Information

Test Site: SMQ EMC Lab.
Environment Conditions:
Antenna Polarization: Horizontal
Operator Name:
Comment:

Copy of FCC Electric Field Strength 26.5-40GHz

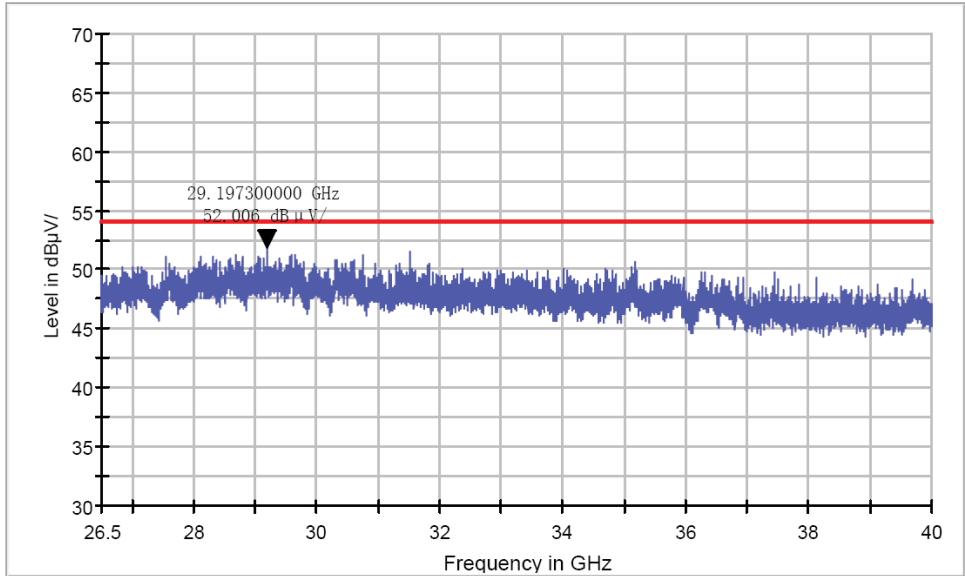

Common Information

Test Site: SMQ EMC Lab.
Environment Conditions:
Antenna Polarization: Vertical
Operator Name:
Comment:

Copy of FCC Electric Field Strength 26.5-40GHz

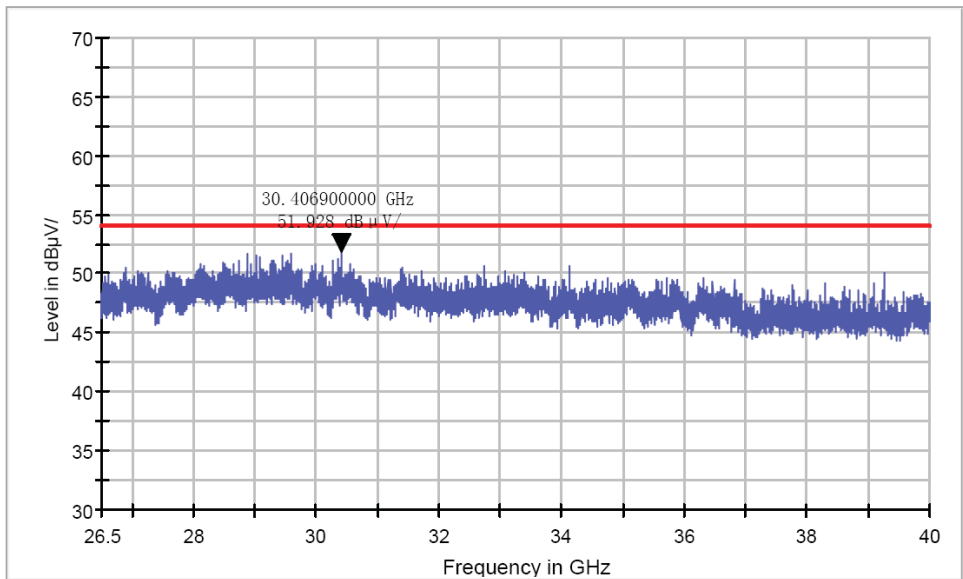

12. BAND EDGE COMPLIANCE TEST

12.1. Block Diagram of Test Setup

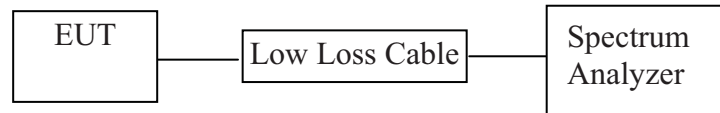

12.2. The Requirement For Unwanted Emissions in the Restricted Bands

1. For all measurements, follow the requirements in section II.G.3., “General Requirements for Unwanted Emissions Measurements.
2. At frequencies below 1000 MHz, use the procedure described in section II.G.4., “Procedure for Unwanted Emissions Measurements Below 1000 MHz.”
3. At frequencies above 1000 MHz, measurements performed using the peak and average measurement procedures described in sections II.G.5. and II.G.6, respectively, must satisfy the respective peak and average limits.

If all peak measurements satisfy the average limit, then average measurements are not required.

4. For conducted measurements above 1000 MHz, EIRP shall be computed as specified in section II.G.3.b) and then field strength shall be computed as follows (see KDB Publication 412172):

$$E[\text{dB}\mu\text{V}/\text{m}] = \text{EIRP}[\text{dBm}] - 20 \log(d[\text{meters}]) + 104.77,$$

where E = field strength and d = distance at which field strength limit is specified in the rules;

$$E[\text{dB}\mu\text{V}/\text{m}] = \text{EIRP}[\text{dBm}] + 95.2, \text{ for } d = 3 \text{ meters.}$$

12.3. EUT Configuration on Measurement

The equipment are installed on the emission Measurement to meet the commission requirements and operating regulations in a manner which tends to maximize its emission characteristics in normal application.

12.4. Operating Condition of EUT

12.4.1. Setup the EUT and simulator as shown as Section 12.1.

12.4.2. Turn on the power of all equipment.

12.4.3. Let the EUT work in TX modes measure it. The transmit frequency are 5150-5250 and 5725-5850MHz .

12.5. Test Procedure

Conducted Band Edge:

12.5.1. The transmitter output was connected to the spectrum analyzer via a low loss cable.

12.5.2. Set RBW of spectrum analyzer to 100kHz and VBW to 300kHz.

Radiate Band Edge:

12.5.3. The EUT is placed on a turntable, which is 1.5m above the ground plane and worked at highest radiated power.

12.5.4. The turntable was rotated for 360 degrees to determine the position of maximum emission level.

12.5.5. EUT is set 3m away from the receiving antenna, which is varied from 1m to 4m to find out the highest emission.

12.5.6. Set the spectrum analyzer in the following setting in order to capture the lower and upper band-edges of the emission:

12.5.7. RBW=1MHz, VBW=1MHz

12.5.8. The band edges was measured and recorded.

12.6. Test Result

PASS

ANT 1(11A)

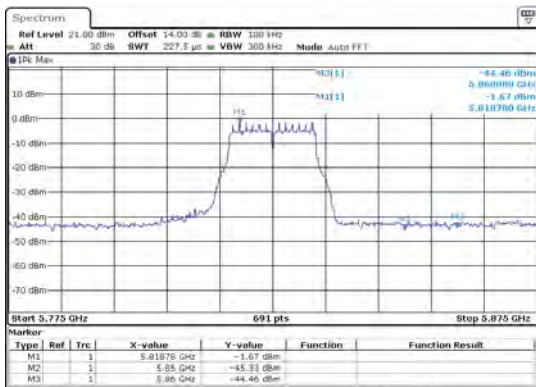
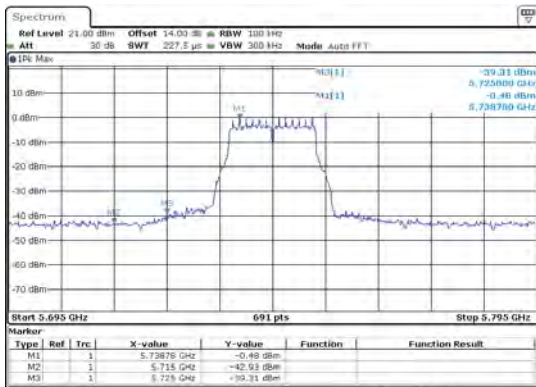
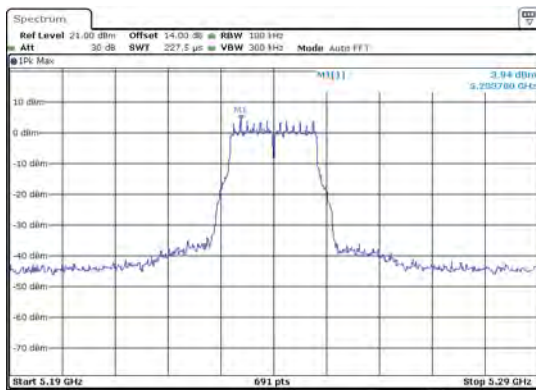
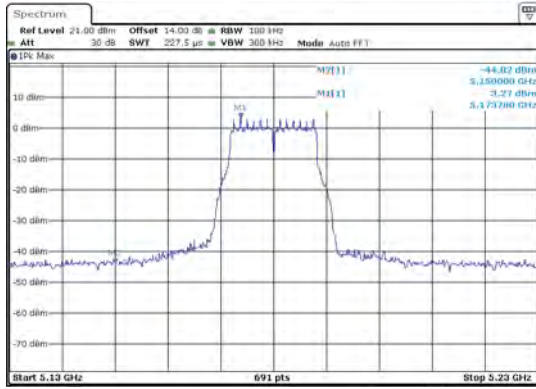

ANT 2(11A)

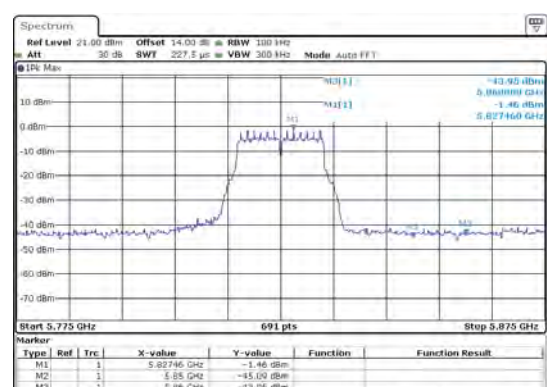
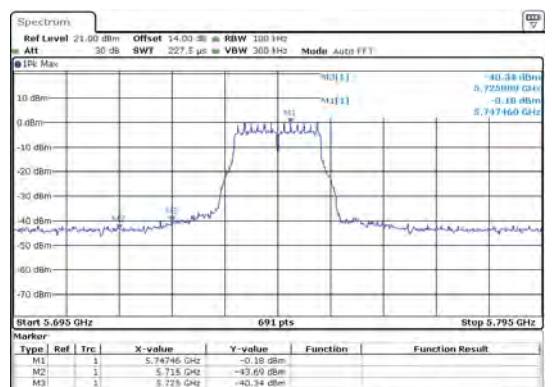
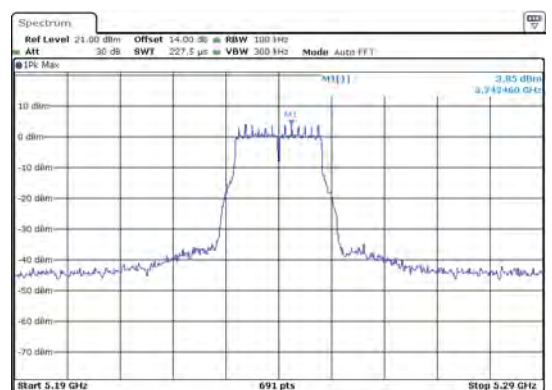
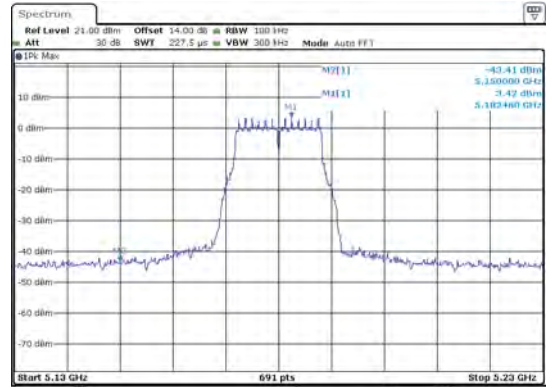

ANT 1(11N20)

ANT 2(11N20)

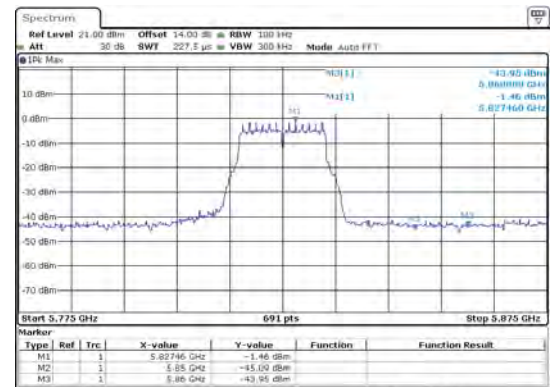
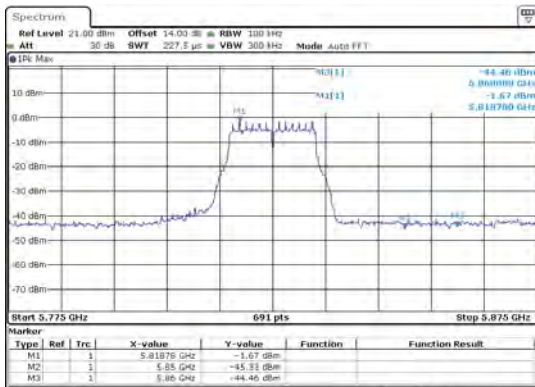
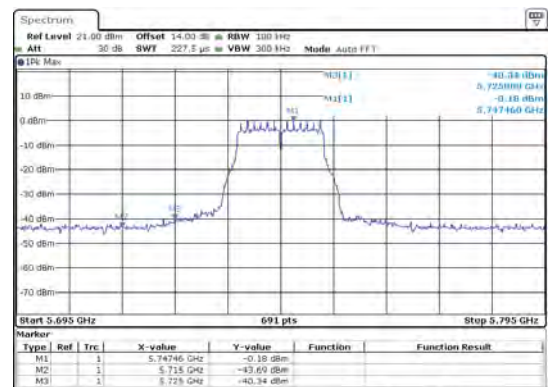
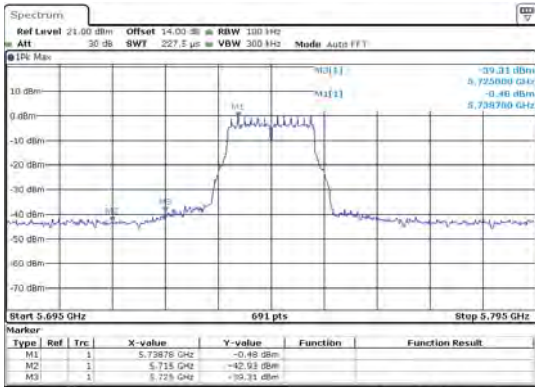
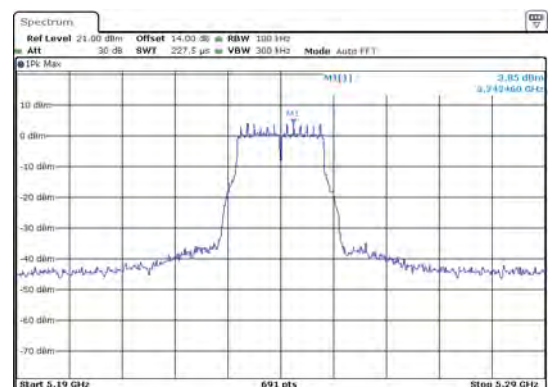
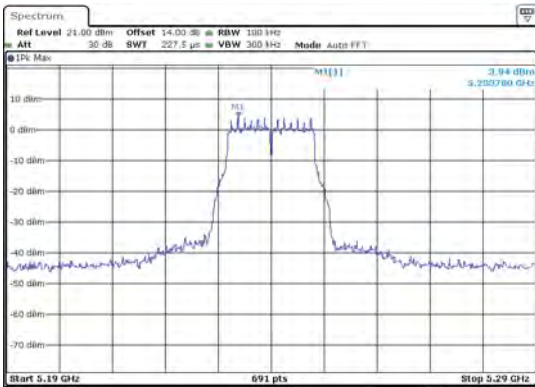
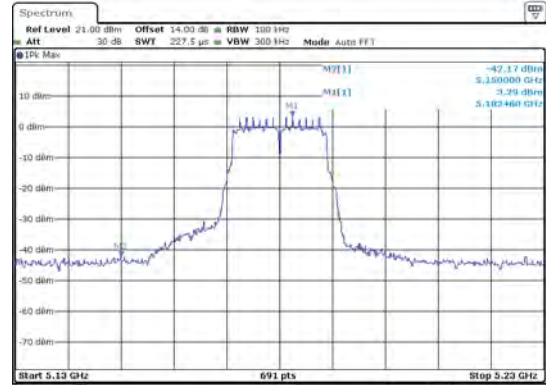
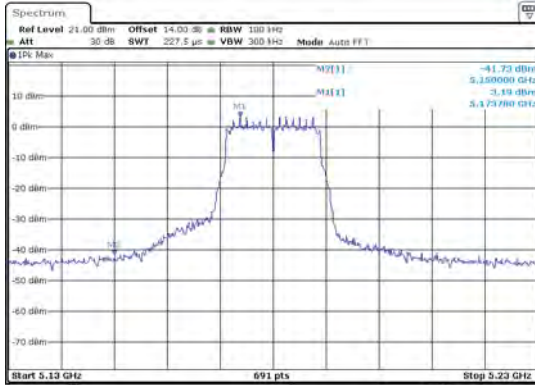

Radiated Band Edge Result

Note:

1. Emissions attenuated more than 20 dB below the permissible value are not reported.
2. The field strength is calculated by adding the antenna factor, high pass filter loss(if used) and cable loss, and subtracting the amplifier gain(if any)from the measured reading. The basic equation calculation is as follows:
$$\text{Result} = \text{Reading} + \text{Corrected Factor}$$
3. Display the measurement of peak values.
4. The EUT is tested radiation emission at each test mode (802.11a/n) in three axes. Besides, We have tested the single antenna transmit mode and the dual antenna emission mode. The worst emissions are reflected in the following plots.
5. The average measurement was not performed when peak measured data under the limit of average detection.

Test mode: 802.11a TX Frequency: 5180MHz, 5240MHz, 5745MHz, 5825MHz

The EUT is tested Radiated Band Edge at each test mode in three axes. Besides, We have tested the single antenna transmit mode and the dual antenna emission mode. The worst emissions are reflected in the following plots



ACCURATE TECHNOLOGY CO., LTD.

F1,Bldg,A,Changyuan New Material Port Keyuan Rd,
Science & Industry Park,Nanshan Shenzhen,P.R.China

Site: 1# Chamber

Tel:+86-0755-26503290

Fax:+86-0755-26503396

Job No.: FRANK2019-W #544	Polarization: Horizontal
Standard: FCC PK	Power Source: DC 7.4V
Test item: Radiation Test	Date: 19/12/16/
Temp.(C)/Hum.(%) 25 C / 55 %	Time: 10/21/09
EUT: Vaxis wireless video system	Engineer Signature: CHARLEY
Mode: TX Channel 36(802.11A)	Distance: 3m
Model: Vaxis Atom 500	
Manufacturer: Hunan GM innovation technology Co., Ltd.	

Note: Report NO.:ATE20191739

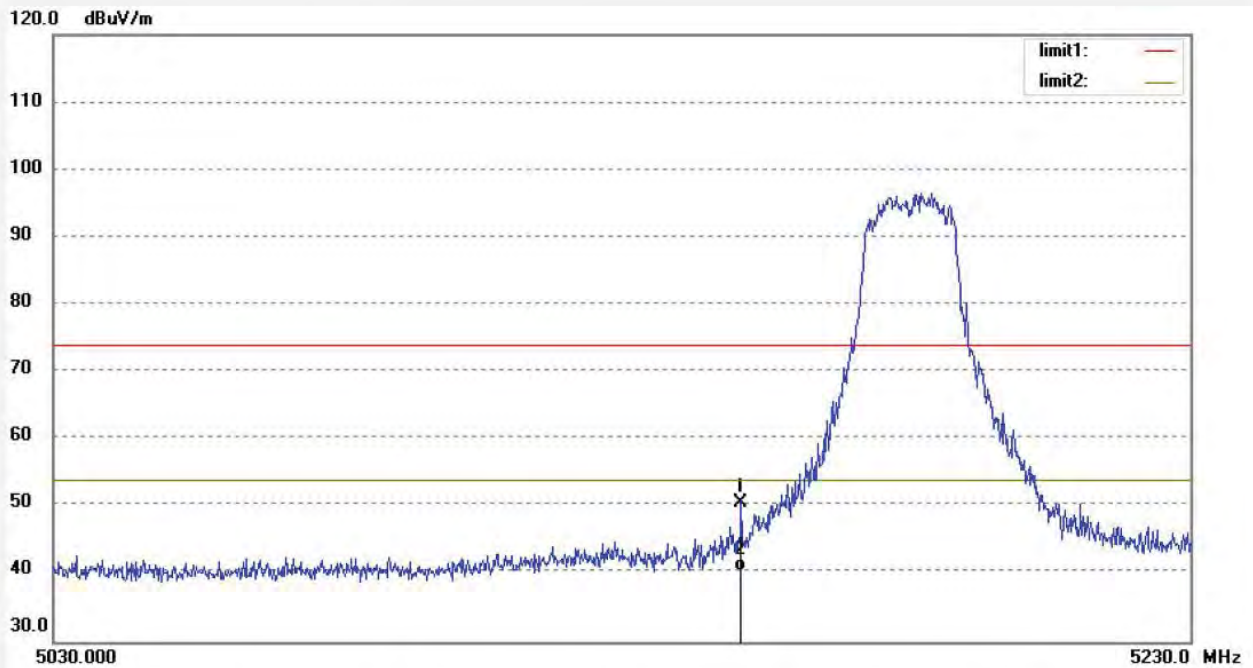

No.	Freq. (MHz)	Reading (dBuV/m)	Factor (dB)	Result (dBuV/m)	Limit (dBuV/m)	Margin (dB)	Detector	Height (cm)	Degree (deg.)	Remark
1	5150.000	48.65	2.04	50.69	74.00	-23.31	peak	200	236	
2	5150.000	38.46	2.04	40.50	54.00	-13.50	AVG	200	210	



ACCURATE TECHNOLOGY CO., LTD.

F1,Bldg,A,Changyuan New Material Port Keyuan Rd,
Science & Industry Park,Nanshan Shenzhen,P.R.China

Site: 1# Chamber

Tel:+86-0755-26503290

Fax:+86-0755-26503396

Job No.: FRANK2019-W #543	Polarization: Vertical
Standard: FCC PK	Power Source: DC 7.4V
Test item: Radiation Test	Date: 19/12/16/
Temp.(C)/Hum.(%) 25 C / 55 %	Time: 10/19/55
EUT: Vaxis wireless video system	Engineer Signature: CHARLEY
Mode: TX Channel 36(802.11A)	Distance: 3m
Model: Vaxis Atom 500	
Manufacturer: Hunan GM innovation technology Co., Ltd.	

Note: Report NO.:ATE20191739

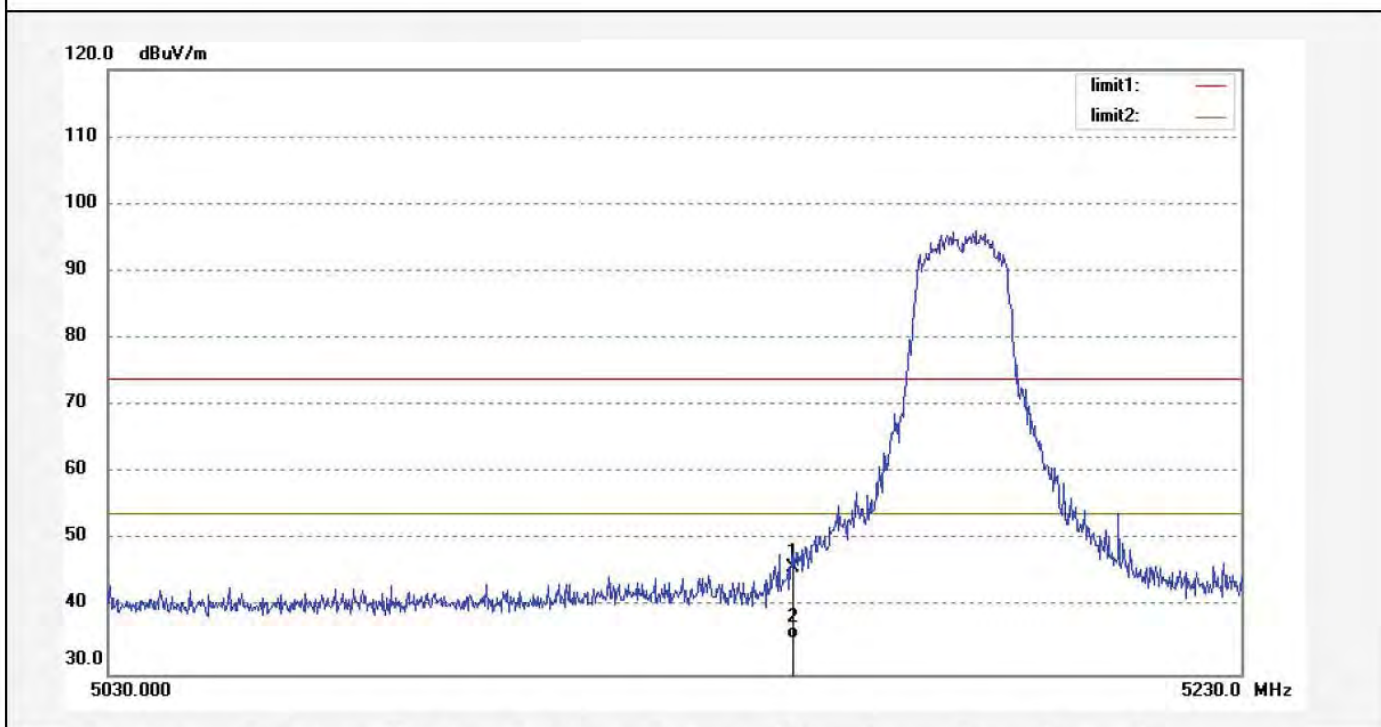

No.	Freq. (MHz)	Reading (dBuV/m)	Factor (dB)	Result (dBuV/m)	Limit (dBuV/m)	Margin (dB)	Detector	Height (cm)	Degree (deg.)	Remark
1	5150.000	43.89	2.04	45.93	74.00	-28.07	peak	150	32	
2	5150.000	33.15	2.04	35.19	54.00	-18.81	AVG	150	196	

Job No.: FRANK2019-W #545

Standard: FCC PK

Test item: Radiation Test

Temp.(C)/Hum.(%) 25 C / 55 %

EUT: Vaxis wireless video system

Mode: TX Channel 48(802.11A)

Model: Vaxis Atom 500

Manufacturer: Hunan GM innovation technology Co., Ltd.

Polarization: Horizontal

Power Source: DC 7.4V

Date: 19/12/16/

Time: 10/23/40

Engineer Signature: CHARLEY

Distance: 3m

Note: Report NO.:ATE20191739

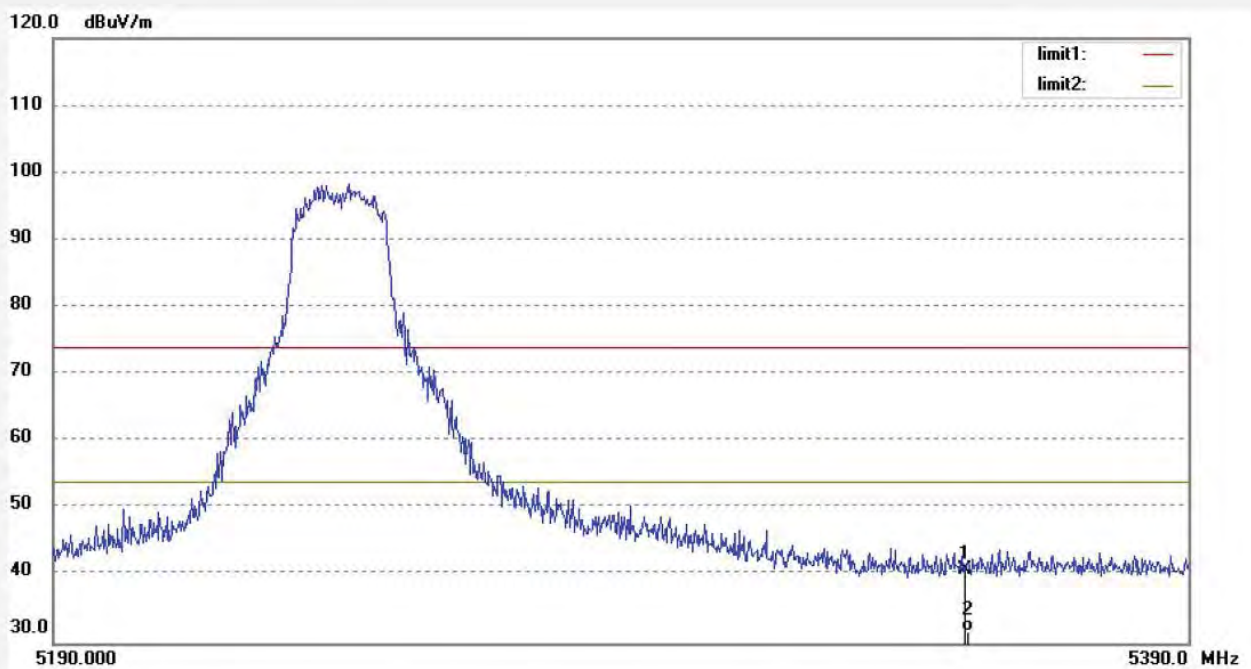

No.	Freq. (MHz)	Reading (dBuV/m)	Factor (dB)	Result (dBuV/m)	Limit (dBuV/m)	Margin (dB)	Detector	Height (cm)	Degree (deg.)	Remark
1	5350.000	38.64	2.28	40.92	74.00	-33.08	peak	200	119	
2	5350.000	29.46	2.28	31.74	54.00	-22.26	AVG	200	163	

Job No.: FRANK2019-W #546	Polarization: Vertical
Standard: FCC PK	Power Source: DC 7.4V
Test item: Radiation Test	Date: 19/12/16/
Temp.(C)/Hum.(%) 25 C / 55 %	Time: 10/24/48
EUT: Vaxis wireless video system	Engineer Signature: CHARLEY
Mode: TX Channel 48(802.11A)	Distance: 3m
Model: Vaxis Atom 500	
Manufacturer: Hunan GM innovation technology Co., Ltd.	

Note: Report NO.:ATE20191739

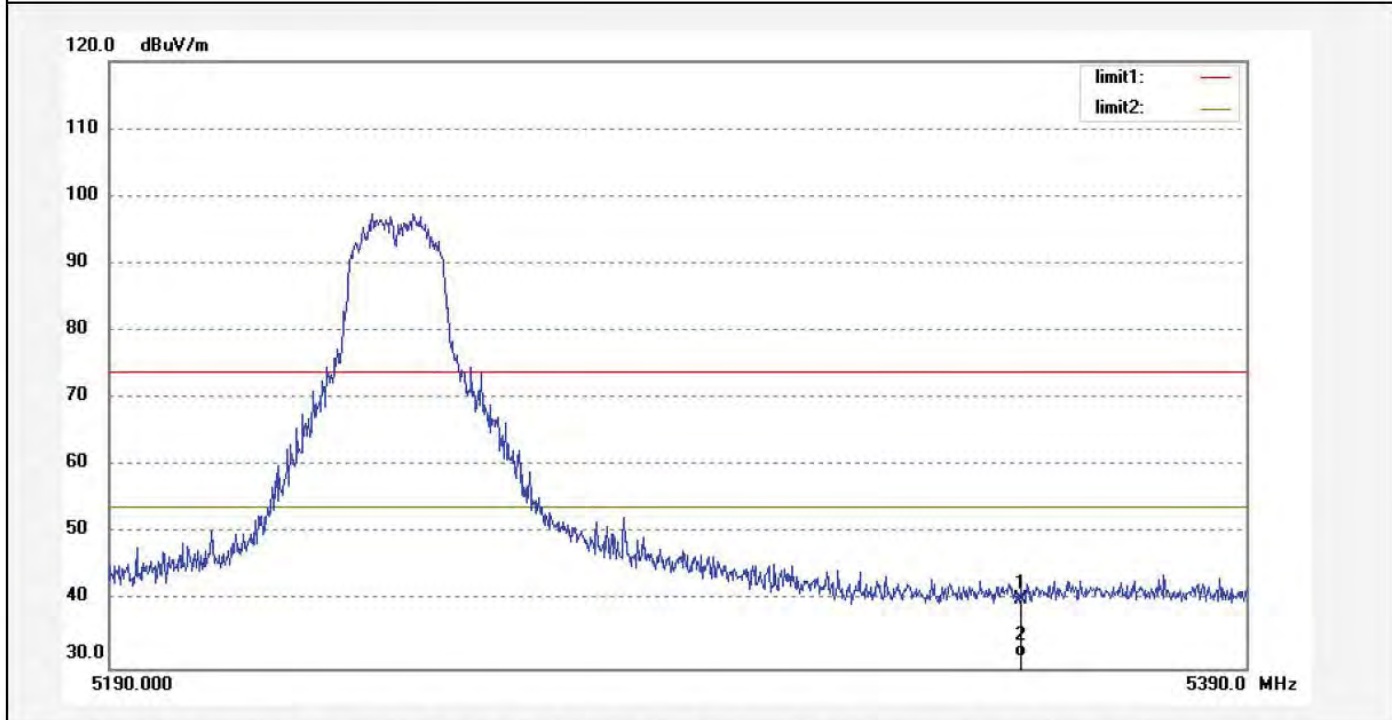

No.	Freq. (MHz)	Reading (dBuV/m)	Factor (dB)	Result (dBuV/m)	Limit (dBuV/m)	Margin (dB)	Detector	Height (cm)	Degree (deg.)	Remark
1	5350.000	38.05	2.28	40.33	74.00	-33.67	peak	150	109	
2	5350.000	29.35	2.28	31.63	54.00	-22.37	AVG	150	63	

Job No.: FRANK2019-W #549

Standard: FCC PK

Test item: Radiation Test

Temp.(C)/Hum.(%) 25 C / 55 %

EUT: Vaxis wireless video system

Mode: TX Channel 149(802.11A)

Model: Vaxis Atom 500

Manufacturer: Hunan GM innovation technology Co., Ltd.

Polarization: Horizontal

Power Source: DC 7.4V

Date: 19/12/16/

Time: 10/30/43

Engineer Signature: CHARLEY

Distance: 3m

Note: Report NO.:ATE20191739

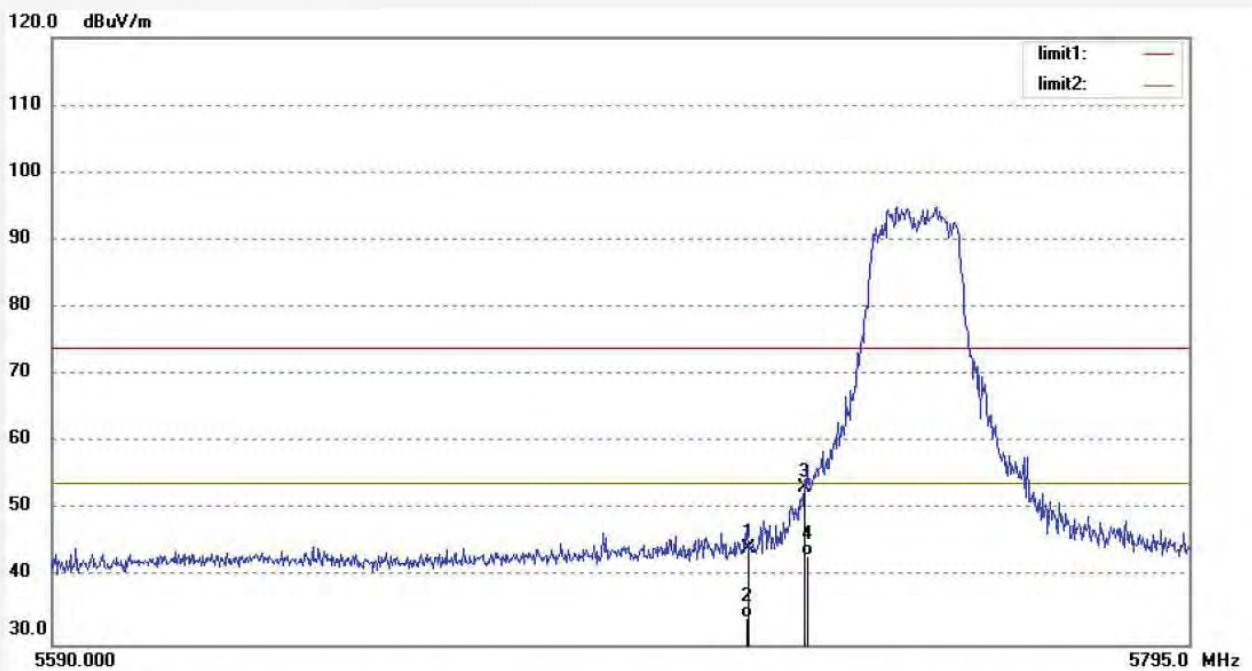

No.	Freq. (MHz)	Reading (dBuV/m)	Factor (dB)	Result (dBuV/m)	Limit (dBuV/m)	Margin (dB)	Detector	Height (cm)	Degree (deg.)	Remark
1	5715.000	41.49	2.74	44.23	74.00	-29.77	peak	200	106	
2	5715.000	31.21	2.74	33.95	54.00	-20.05	AVG	200	320	
3	5725.000	50.61	2.75	53.36	74.00	-20.64	peak	200	119	
4	5725.000	40.32	2.75	43.07	54.00	-10.93	AVG	200	63	

Job No.: FRANK2019-W #547

Standard: FCC PK

Test item: Radiation Test

Temp.(C)/Hum.(%) 25 C / 55 %

EUT: Vaxis wireless video system

Mode: TX Channel 149(802.11A)

Model: Vaxis Atom 500

Manufacturer: Hunan GM innovation technology Co., Ltd.

Polarization: Vertical

Power Source: DC 7.4V

Date: 19/12/16/

Time: 10/27/06

Engineer Signature: CHARLEY

Distance: 3m

Note: Report NO.:ATE20191739

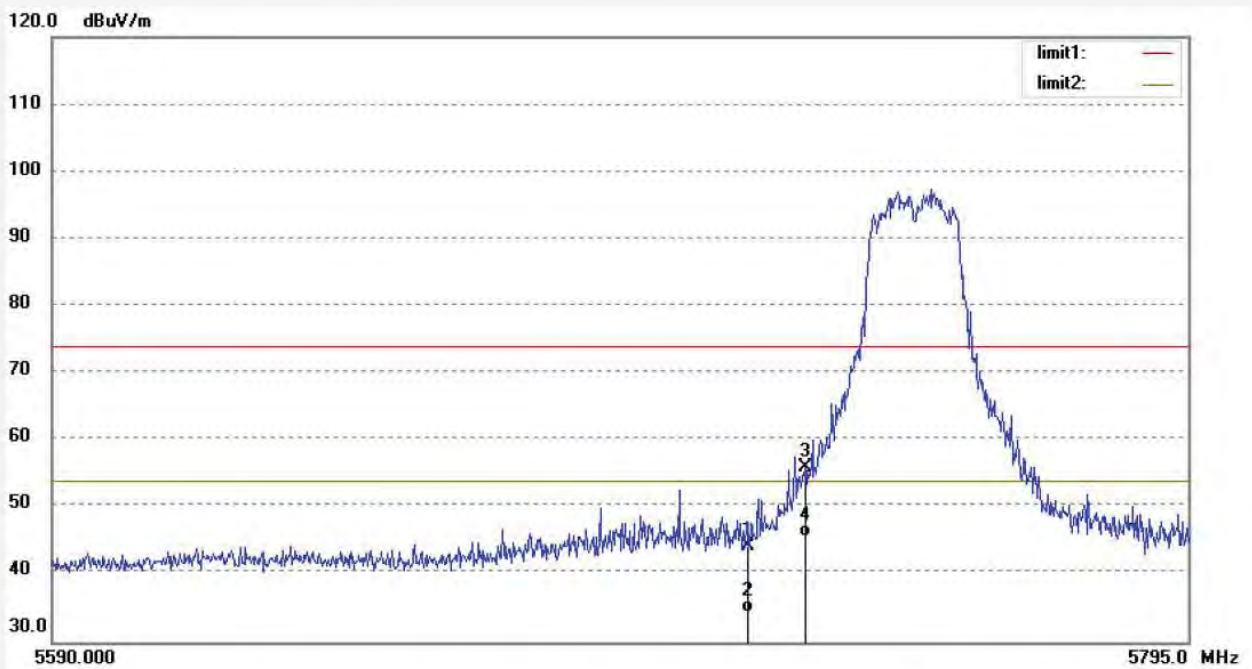

No.	Freq. (MHz)	Reading (dBuV/m)	Factor (dB)	Result (dBuV/m)	Limit (dBuV/m)	Margin (dB)	Detector	Height (cm)	Degree (deg.)	Remark
1	5715.000	41.50	2.74	44.24	74.00	-29.76	peak	150	109	
2	5715.000	31.56	2.74	34.30	54.00	-19.70	AVG	150	93	
3	5725.000	53.29	2.75	56.04	74.00	-17.96	peak	150	214	
4	5725.000	42.89	2.75	45.64	54.00	-8.36	AVG	150	201	

Job No.: FRANK2019-W #550

Standard: FCC PK

Test item: Radiation Test

Temp.(C)/Hum.(%) 25 C / 55 %

EUT: Vaxis wireless video system

Mode: TX Channel 165(802.11A)

Model: Vaxis Atom 500

Manufacturer: Hunan GM innovation technology Co., Ltd.

Polarization: Horizontal

Power Source: DC 7.4V

Date: 19/12/16/

Time: 10/32/47

Engineer Signature: CHARLEY

Distance: 3m

Note: Report NO.:ATE20191739

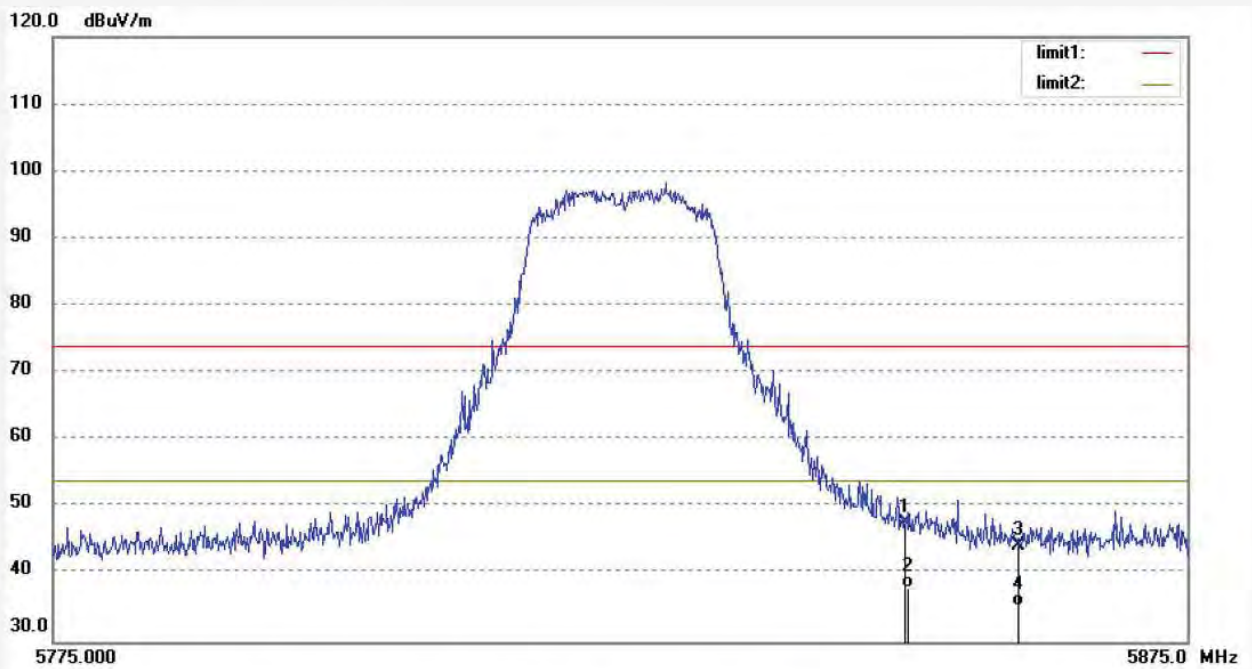

No.	Freq. (MHz)	Reading (dBuV/m)	Factor (dB)	Result (dBuV/m)	Limit (dBuV/m)	Margin (dB)	Detector	Height (cm)	Degree (deg.)	Remark
1	5850.000	44.65	2.93	47.58	74.00	-26.42	peak	200	106	
2	5850.000	35.15	2.93	38.08	54.00	-15.92	AVG	250	32	
3	5860.000	41.41	2.95	44.36	74.00	-29.64	peak	200	112	
4	5860.000	32.41	2.95	35.36	54.00	-18.64	AVG	250	201	

Job No.: FRANK2019-W #551

Standard: FCC PK

Test item: Radiation Test

Temp.(C)/Hum.(%) 25 C / 55 %

EUT: Vaxis wireless video system

Mode: TX Channel 165(802.11A)

Model: Vaxis Atom 500

Manufacturer: Hunan GM innovation technology Co., Ltd.

Polarization: Vertical

Power Source: DC 7.4V

Date: 19/12/16/

Time: 10/33/53

Engineer Signature: CHARLEY

Distance: 3m

Note: Report NO.:ATE20191739

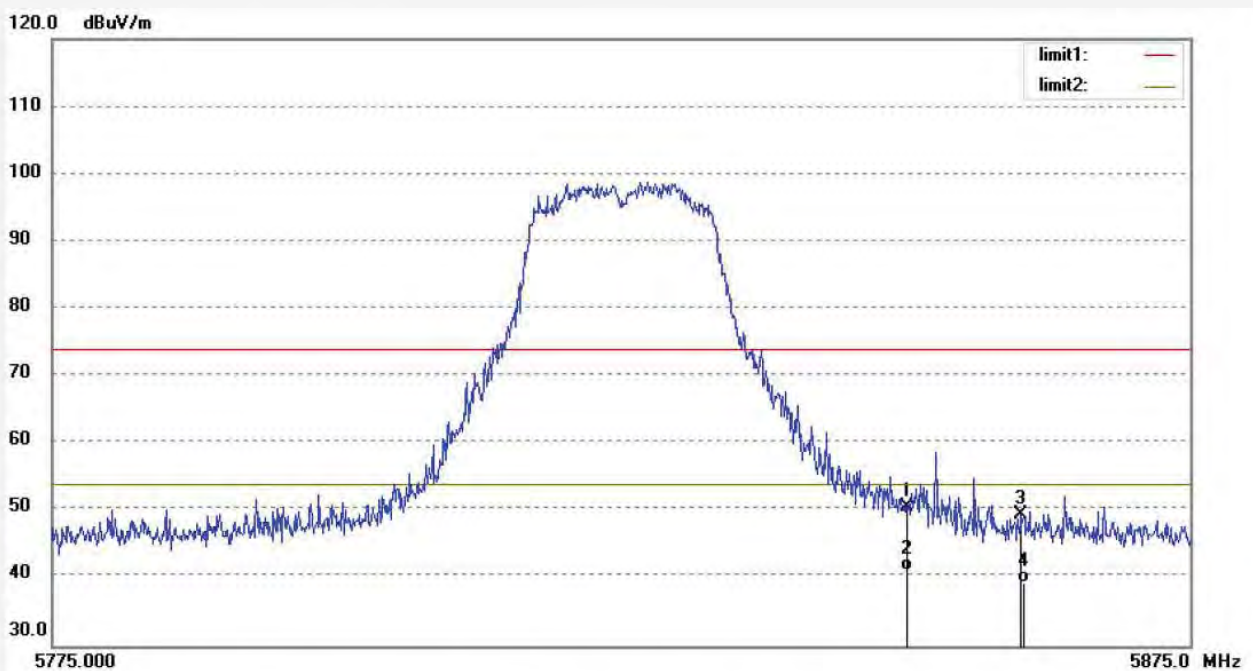

No.	Freq. (MHz)	Reading (dBuV/m)	Factor (dB)	Result (dBuV/m)	Limit (dBuV/m)	Margin (dB)	Detector	Height (cm)	Degree (deg.)	Remark
1	5850.000	47.67	2.93	50.60	74.00	-23.40	peak	150	104	
2	5850.000	38.15	2.93	41.08	54.00	-12.92	AVG	150	32	
3	5860.000	46.41	2.95	49.36	74.00	-24.64	peak	150	201	
4	5860.000	36.45	2.95	39.40	54.00	-14.60	AVG	150	359	

Test mode: 802.11n20 TX Frequency: 5180MHz, 5240MHz, 5745MHz, 5825MHz

The EUT is tested Radiated Band Edge at each test mode in three axes. Besides, We have tested the single antenna transmit mode and the dual antenna emission mode. The worst emissions are reflected in the following plots



ACCURATE TECHNOLOGY CO., LTD.

F1,Bldg,A,Changyuan New Material Port Keyuan Rd,
Science & Industry Park,Nanshan Shenzhen,P.R.China

Site: 1# Chamber

Tel:+86-0755-26503290

Fax:+86-0755-26503396

Job No.: FRANK2019-W #558	Polarization: Horizontal
Standard: FCC PK	Power Source: DC 7.4V
Test item: Radiation Test	Date: 19/12/16/
Temp.(C)/Hum.(%) 25 C / 55 %	Time: 10/43/47
EUT: Vaxis wireless video system	Engineer Signature: CHARLEY
Mode: TX Channel 36(802.11N)	Distance: 3m
Model: Vaxis Atom 500	
Manufacturer: Hunan GM innovation technology Co., Ltd.	

Note: Report NO.:ATE20191739

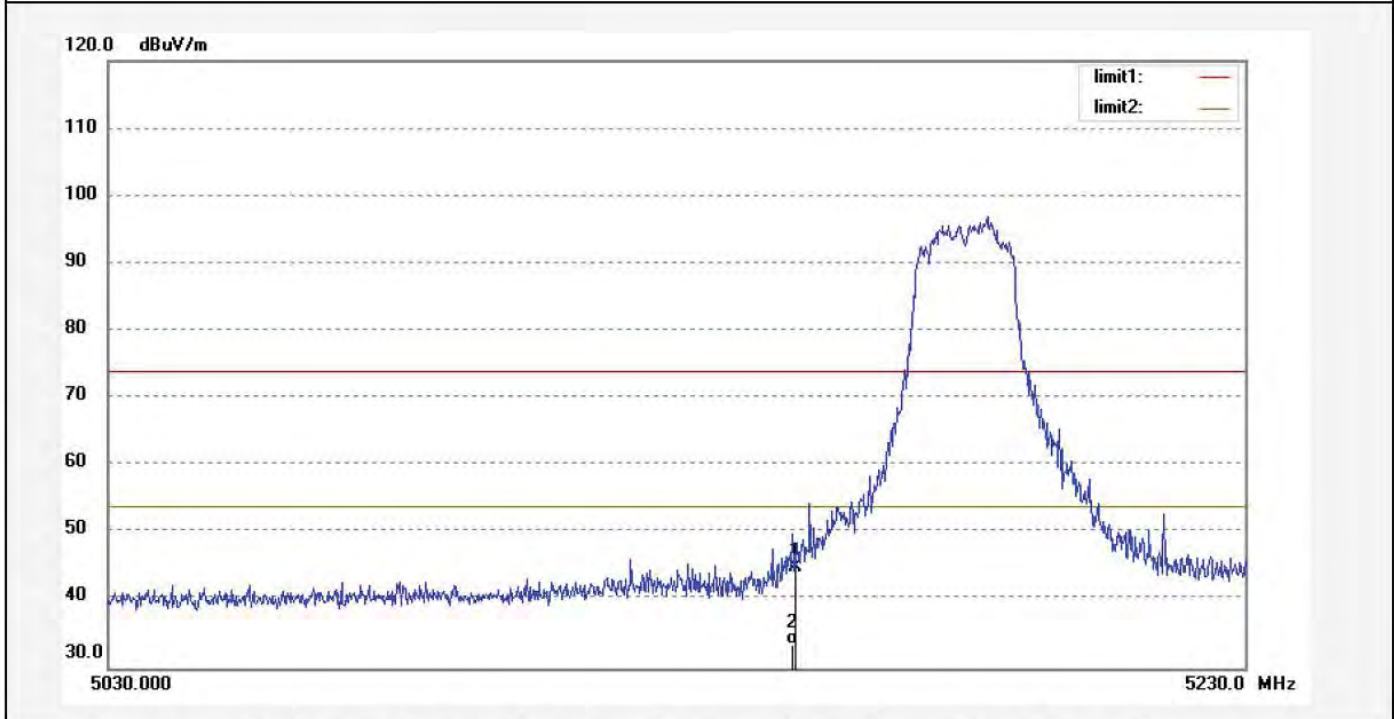

No.	Freq. (MHz)	Reading (dBuV/m)	Factor (dB)	Result (dBuV/m)	Limit (dBuV/m)	Margin (dB)	Detector	Height (cm)	Degree (deg.)	Remark
1	5150.000	42.86	2.04	44.90	74.00	-29.10	peak	200	62	
2	5150.000	31.54	2.04	33.58	54.00	-20.42	AVG	200	193	

Job No.: FRANK2019-W #559

Standard: FCC PK

Test item: Radiation Test

Temp.(C)/Hum.(%) 25 C / 55 %

EUT: Vaxis wireless video system

Mode: TX Channel 36(802.11N)

Model: Vaxis Atom 500

Manufacturer: Hunan GM innovation technology Co., Ltd.

Polarization: Vertical

Power Source: DC 7.4V

Date: 19/12/16/

Time: 10/45/03

Engineer Signature: CHARLEY

Distance: 3m

Note: Report NO.:ATE20191739

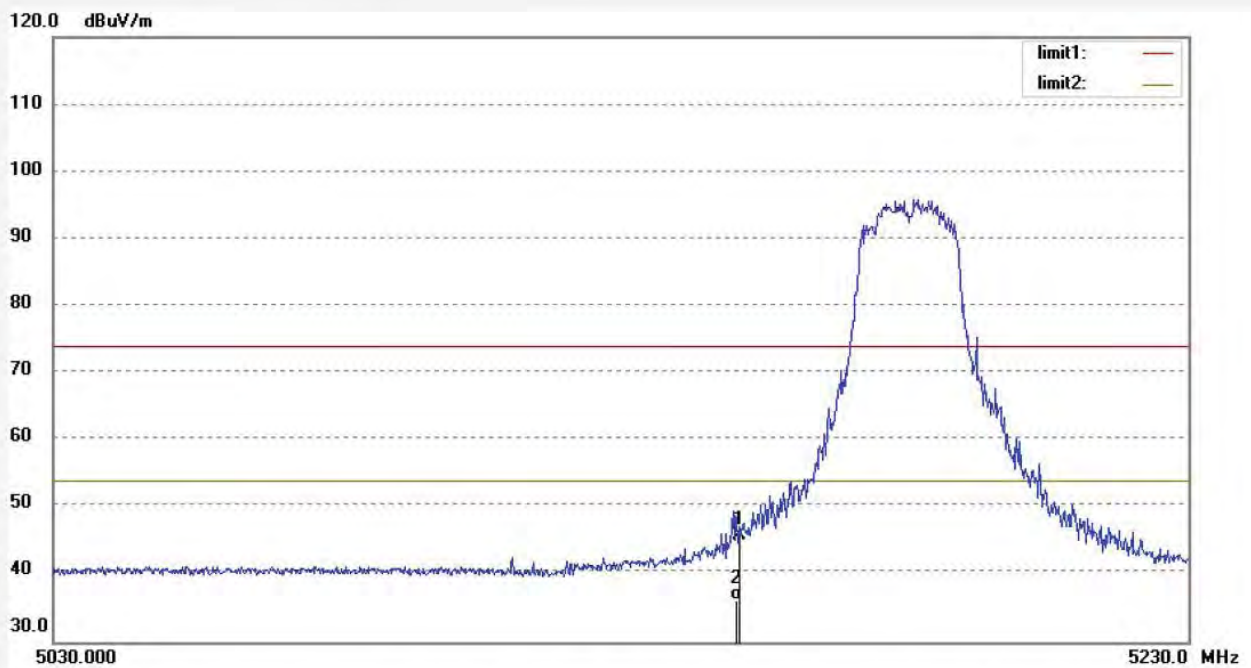

No.	Freq. (MHz)	Reading (dBuV/m)	Factor (dB)	Result (dBuV/m)	Limit (dBuV/m)	Margin (dB)	Detector	Height (cm)	Degree (deg.)	Remark
1	5150.000	43.86	2.04	45.90	74.00	-28.10	peak	150	179	
2	5150.000	34.22	2.04	36.26	54.00	-17.74	AVG	150	193	

Job No.: FRANK2019-W #557

Standard: FCC PK

Test item: Radiation Test

Temp.(C)/Hum.(%) 25 C / 55 %

EUT: Vaxis wireless video system

Mode: TX Channel 48(802.11N)

Model: Vaxis Atom 500

Manufacturer: Hunan GM innovation technology Co., Ltd.

Polarization: Horizontal

Power Source: DC 7.4V

Date: 19/12/16/

Time: 10/41/55

Engineer Signature: CHARLEY

Distance: 3m

Note: Report NO.:ATE20191739

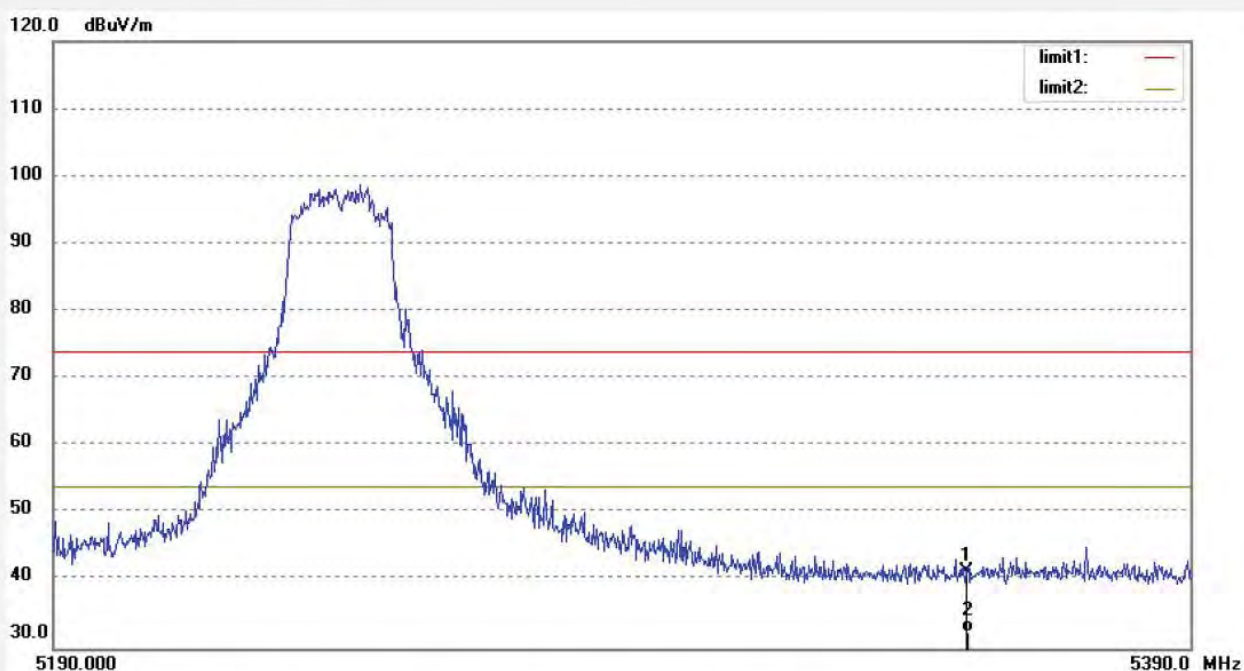

No.	Freq. (MHz)	Reading (dBuV/m)	Factor (dB)	Result (dBuV/m)	Limit (dBuV/m)	Margin (dB)	Detector	Height (cm)	Degree (deg.)	Remark
1	5350.000	39.01	2.28	41.29	74.00	-32.71	peak	200	193	
2	5350.000	30.12	2.28	32.40	54.00	-21.60	AVG	200	219	

Job No.: FRANK2019-W #556

Standard: FCC PK

Test item: Radiation Test

Temp.(C)/Hum.(%) 25 C / 55 %

EUT: Vaxis wireless video system

Mode: TX Channel 48(802.11N)

Model: Vaxis Atom 500

Manufacturer: Hunan GM innovation technology Co., Ltd.

Polarization: Vertical

Power Source: DC 7.4V

Date: 19/12/16/

Time: 10/40/28

Engineer Signature: CHARLEY

Distance: 3m

Note: Report NO.:ATE20191739

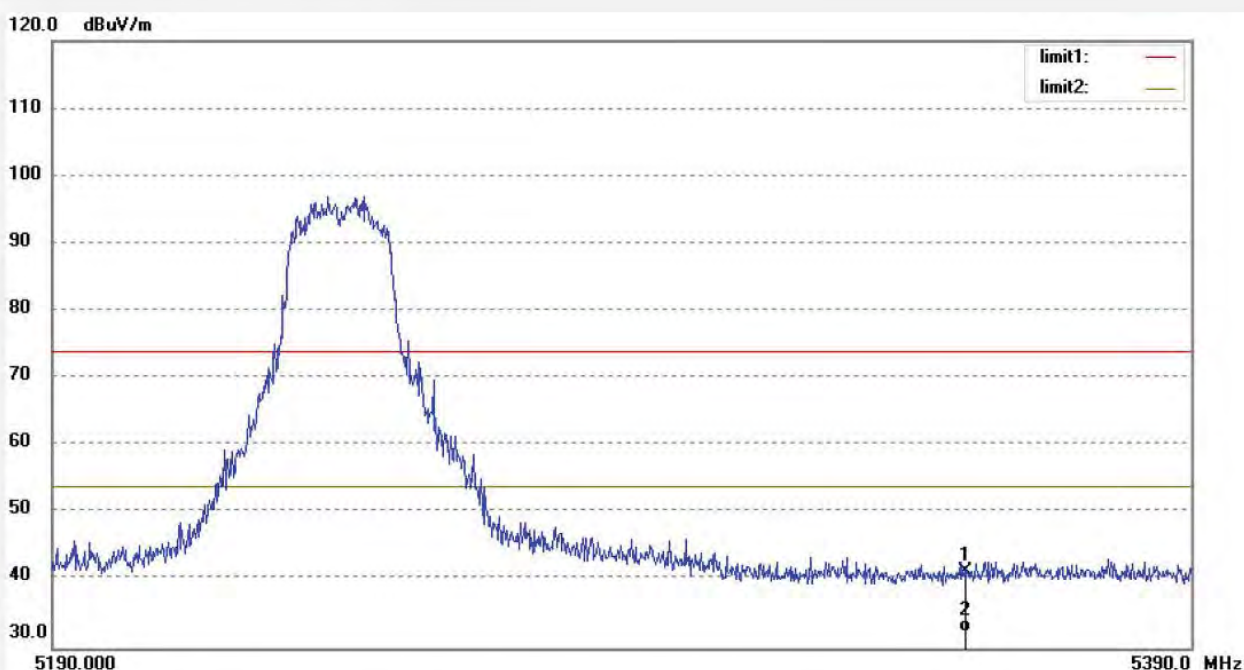

No.	Freq. (MHz)	Reading (dBuV/m)	Factor (dB)	Result (dBuV/m)	Limit (dBuV/m)	Margin (dB)	Detector	Height (cm)	Degree (deg.)	Remark
1	5350.000	39.06	2.28	41.34	74.00	-32.66	peak	150	193	
2	5350.000	30.12	2.28	32.40	54.00	-21.60	AVG	150	159	

Job No.: FRANK2019-W #554

Standard: FCC PK

Test item: Radiation Test

Temp.(C)/Hum.(%) 25 C / 55 %

EUT: Vaxis wireless video system

Mode: TX Channel 149(802.11N)

Model: Vaxis Atom 500

Manufacturer: Hunan GM innovation technology Co., Ltd.

Polarization: Horizontal

Power Source: DC 7.4V

Date: 19/12/16/

Time: 10/37/55

Engineer Signature: CHARLEY

Distance: 3m

Note: Report NO.:ATE20191739

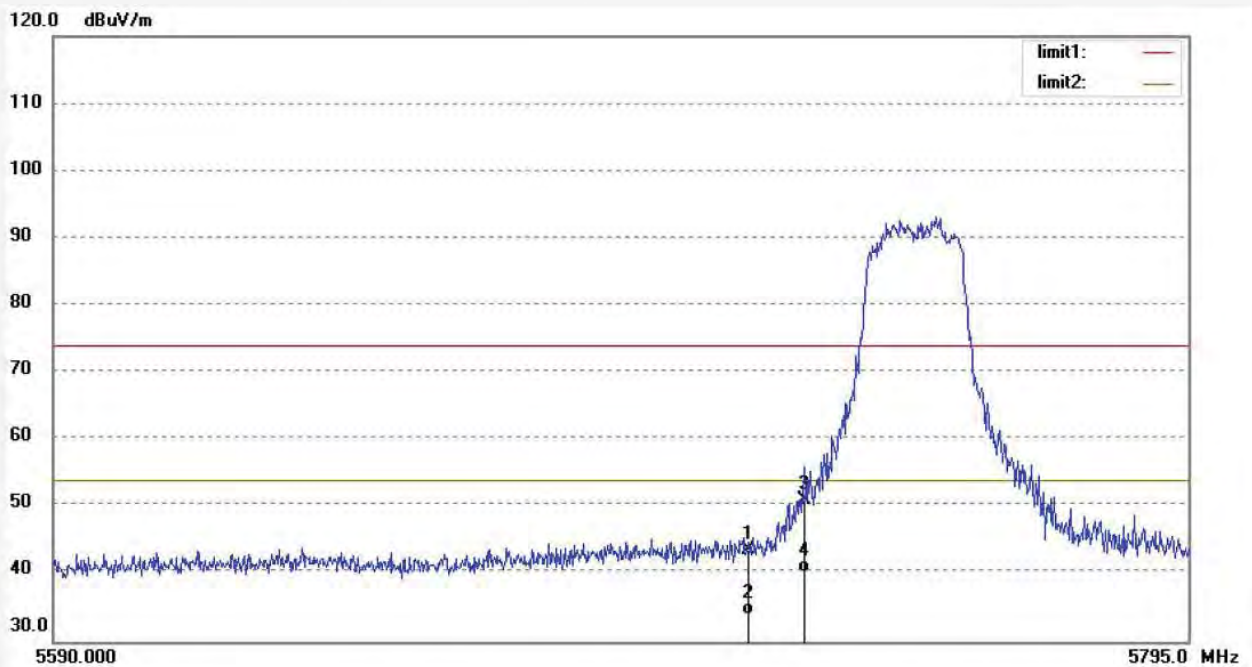

No.	Freq. (MHz)	Reading (dBuV/m)	Factor (dB)	Result (dBuV/m)	Limit (dBuV/m)	Margin (dB)	Detector	Height (cm)	Degree (deg.)	Remark
1	5715.000	40.89	2.74	43.63	74.00	-30.37	peak	200	163	
2	5715.000	31.21	2.74	33.95	54.00	-20.05	AVG	250	210	
3	5725.000	48.31	2.75	51.06	74.00	-22.94	peak	200	50	
4	5725.000	37.45	2.75	40.20	54.00	-13.80	AVG	250	148	

Job No.: FRANK2019-W #555

Standard: FCC PK

Test item: Radiation Test

Temp.(C)/Hum.(%) 25 C / 55 %

EUT: Vaxis wireless video system

Mode: TX Channel 149(802.11N)

Model: Vaxis Atom 500

Manufacturer: Hunan GM innovation technology Co., Ltd.

Polarization: Vertical

Power Source: DC 7.4V

Date: 19/12/16/

Time: 10/39/00

Engineer Signature: CHARLEY

Distance: 3m

Note: Report NO.:ATE20191739

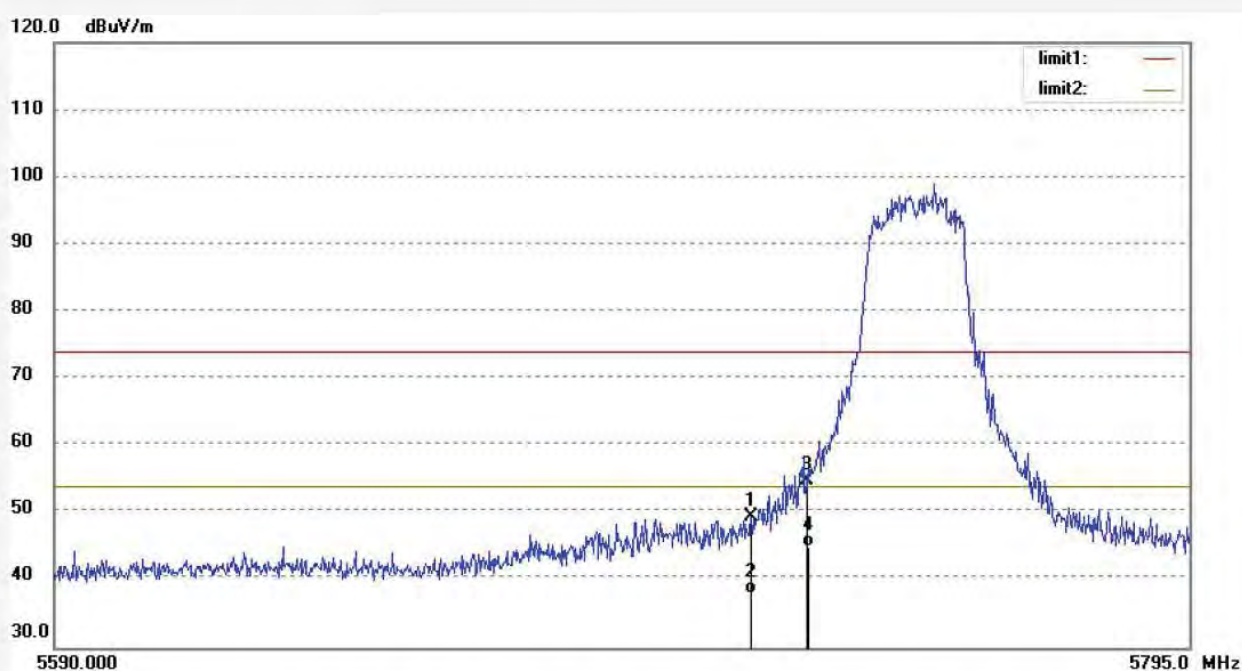

No.	Freq. (MHz)	Reading (dBuV/m)	Factor (dB)	Result (dBuV/m)	Limit (dBuV/m)	Margin (dB)	Detector	Height (cm)	Degree (deg.)	Remark
1	5715.000	46.62	2.74	49.36	74.00	-24.64	peak	150	185	
2	5715.000	35.15	2.74	37.89	54.00	-16.11	AVG	150	116	
3	5725.000	52.09	2.75	54.84	74.00	-19.16	peak	150	310	
4	5725.000	42.12	2.75	44.87	54.00	-9.13	AVG	150	122	

Job No.: FRANK2019-W #553

Standard: FCC PK

Test item: Radiation Test

Temp.(C)/Hum.(%) 25 C / 55 %

EUT: Vaxis wireless video system

Mode: TX Channel 165(802.11N)

Model: Vaxis Atom 500

Manufacturer: Hunan GM innovation technology Co., Ltd.

Polarization: Horizontal

Power Source: DC 7.4V

Date: 19/12/16/

Time: 10/36/28

Engineer Signature: CHARLEY

Distance: 3m

Note: Report NO.:ATE20191739

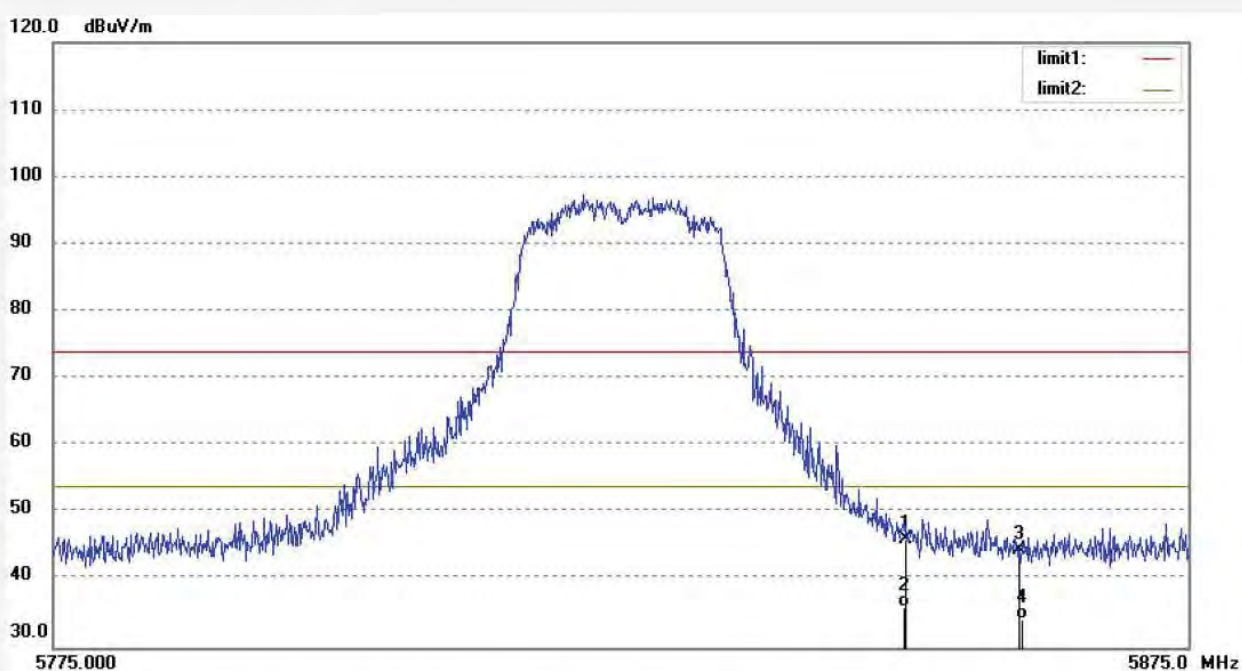

No.	Freq. (MHz)	Reading (dBuV/m)	Factor (dB)	Result (dBuV/m)	Limit (dBuV/m)	Margin (dB)	Detector	Height (cm)	Degree (deg.)	Remark
1	5850.000	43.06	2.93	45.99	74.00	-28.01	peak	200	106	
2	5850.000	33.12	2.93	36.05	54.00	-17.95	AVG	250	321	
3	5860.000	41.61	2.95	44.56	74.00	-29.44	peak	200	248	
4	5860.000	31.21	2.95	34.16	54.00	-19.84	AVG	200	92	

Job No.: FRANK2019-W #552

Standard: FCC PK

Test item: Radiation Test

Temp.(C)/Hum.(%) 25 C / 55 %

EUT: Vaxis wireless video system

Mode: TX Channel 165(802.11N)

Model: Vaxis Atom 500

Manufacturer: Hunan GM innovation technology Co., Ltd.

Polarization: Vertical

Power Source: DC 7.4V

Date: 19/12/16/

Time: 10/35/19

Engineer Signature: CHARLEY

Distance: 3m

Note: Report NO.:ATE20191739

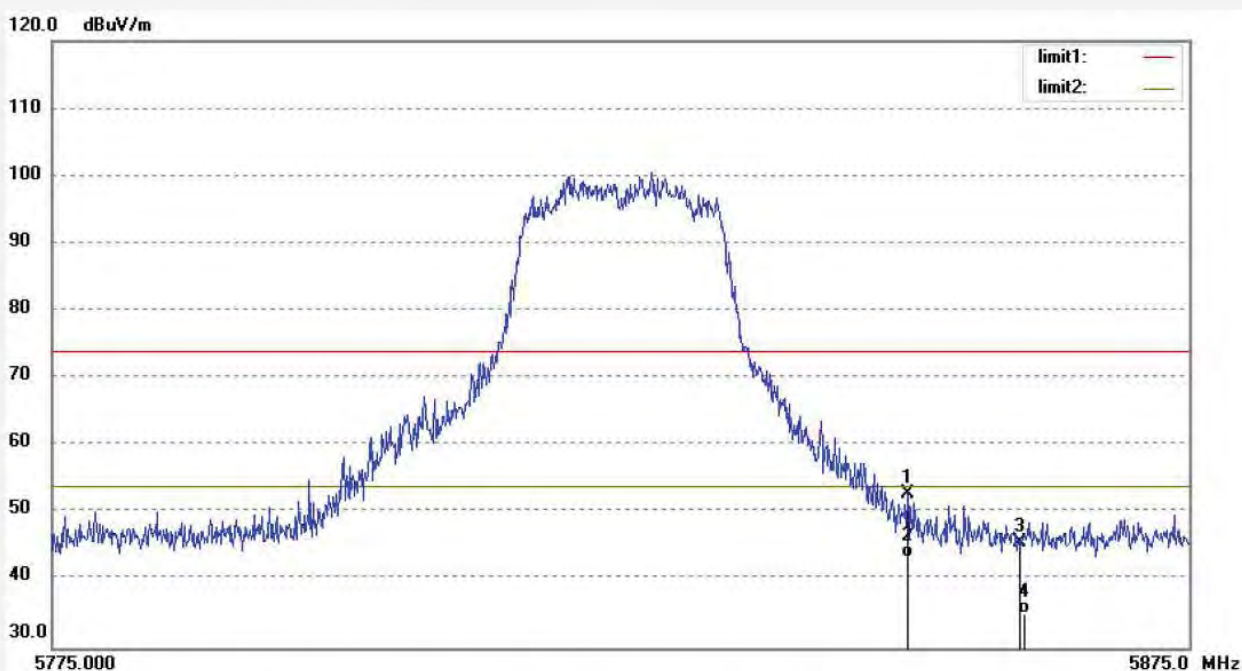

No.	Freq. (MHz)	Reading (dBuV/m)	Factor (dB)	Result (dBuV/m)	Limit (dBuV/m)	Margin (dB)	Detector	Height (cm)	Degree (deg.)	Remark
1	5850.000	49.80	2.93	52.73	74.00	-21.27	peak	150	82	
2	5850.000	40.45	2.93	43.38	54.00	-10.62	AVG	150	195	
3	5860.000	42.65	2.95	45.60	74.00	-28.40	peak	150	103	
4	5860.000	32.15	2.95	35.10	54.00	-18.90	AVG	150	63	

13. IN BAND EMISSION

13.1. Block Diagram of Test Setup

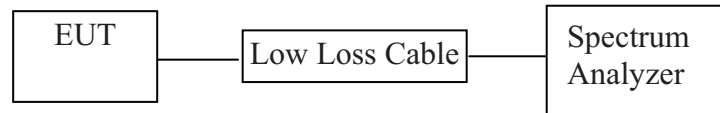

13.2. For transmitters operating in the 5.725-5.85 GHz band:

All emissions shall be limited to a level of -27 dBm/MHz at 75 MHz or more above or below the band edge increasing linearly to 10 dBm/MHz at 25 MHz above or below the band edge, and from 25 MHz above or below the band edge increasing linearly to a level of 15.6 dBm/MHz at 5 MHz above or below the band edge, and from 5 MHz above or below the band edge increasing linearly to a level of 27 dBm/MHz at the band edge.

13.3. EUT Configuration on Measurement

The equipment are installed on the emission Measurement to meet the commission requirements and operating regulations in a manner which tends to maximize its emission characteristics in normal application.

13.4. Operating Condition of EUT

13.4.1. Setup the EUT and simulator as shown as Section 13.1.

13.4.2. Turn on the power of all equipment.

13.4.3. Let the EUT work in TX modes measure it. The transmit frequency is 5725-5850MHz .

13.5. Test Procedure

13.5.1. The transmitter output was connected to the spectrum analyzer via a low loss cable.

13.5.2. Set RBW of spectrum analyzer to 1000kHz and VBW to 3000kHz.

13.6. Test Result

PASS

SISO mode

ANT 1(11A) 5745MHz

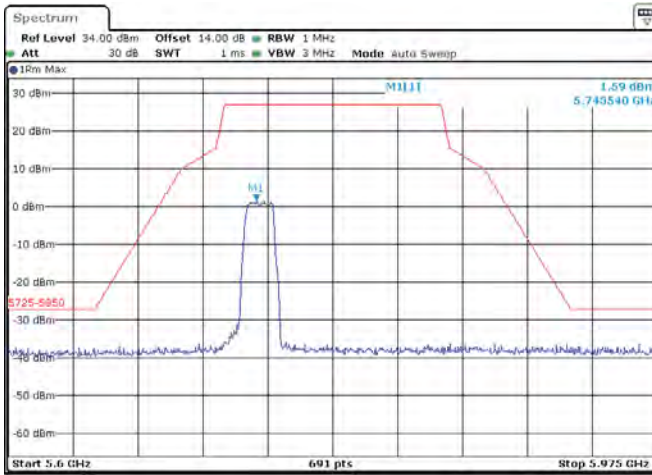

ANT 2(11A) 5745MHz

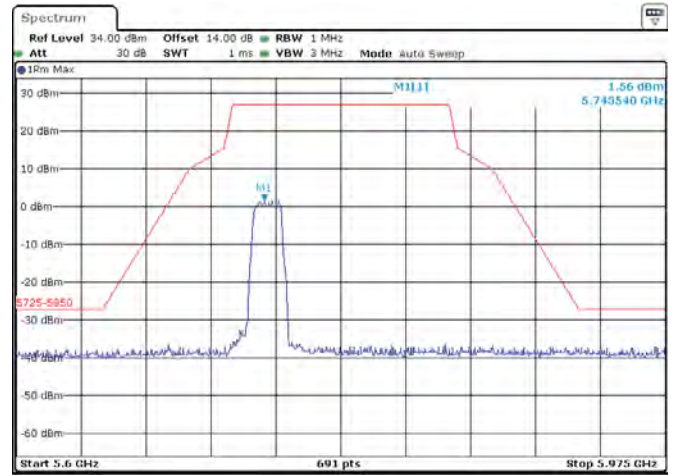

ANT 1(11A) 5825MHz

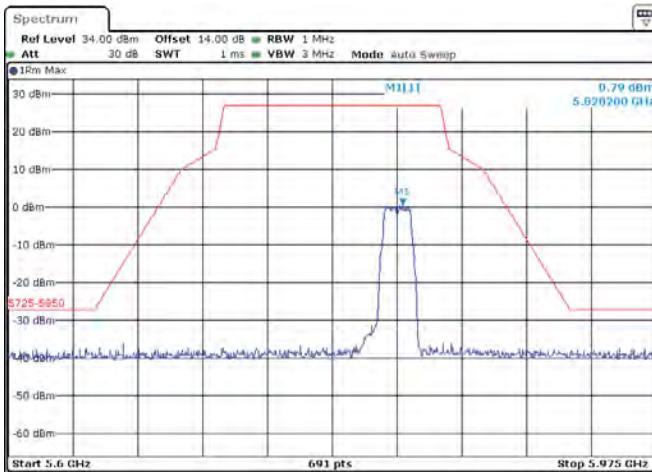

ANT 2(11A) 5825MHz

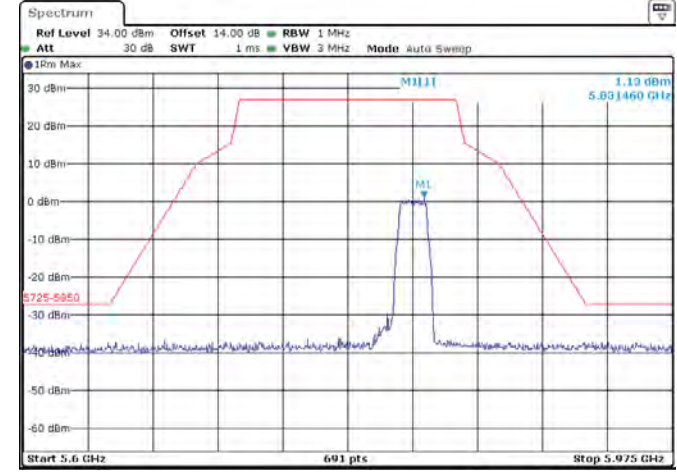

ANT 1(11N) 5745MHz

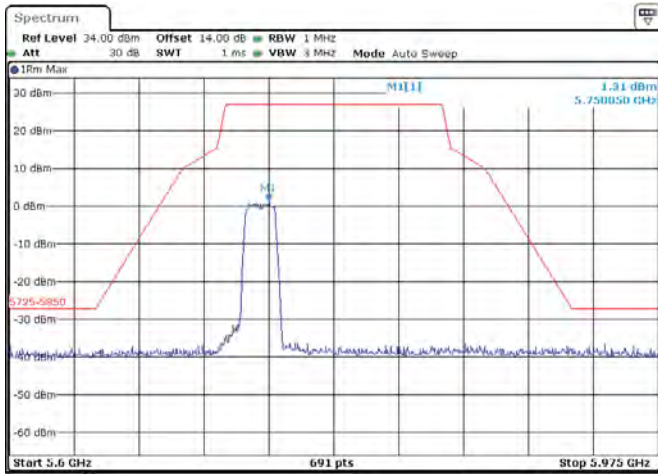

ANT 2(11N) 5745MHz

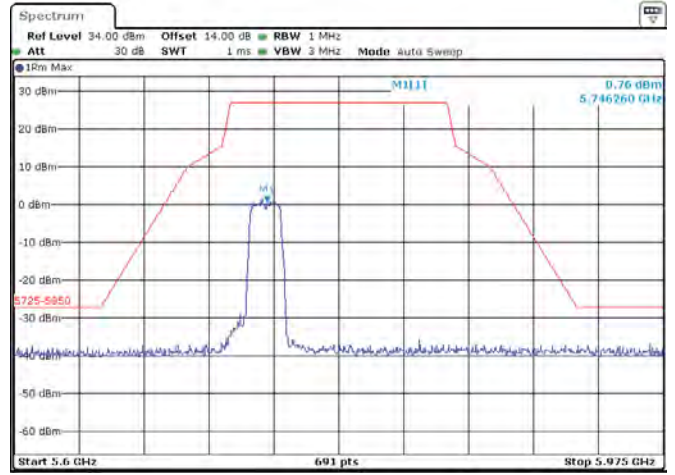

ANT 1(11N) 5825MHz

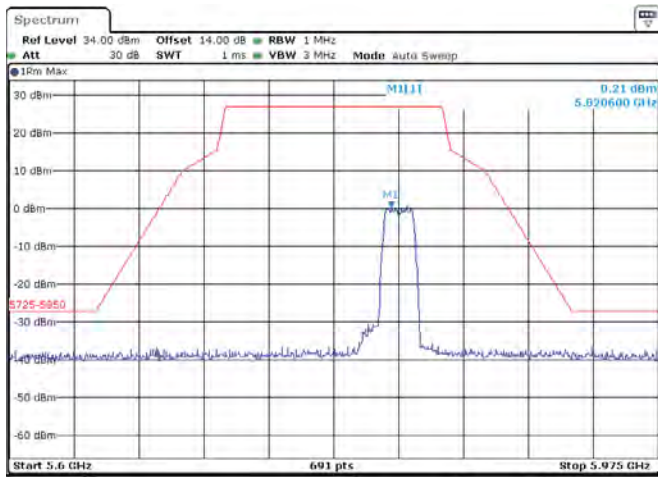

ANT 2(11N) 5825MHz

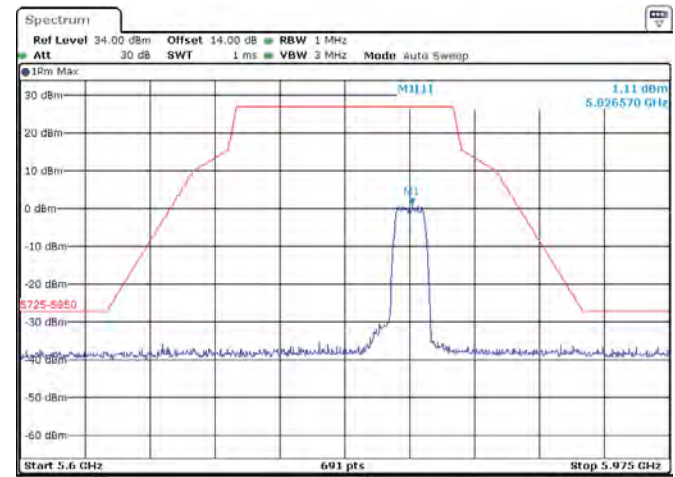

MIMO mode

ANT 1(11N) 5745MHz

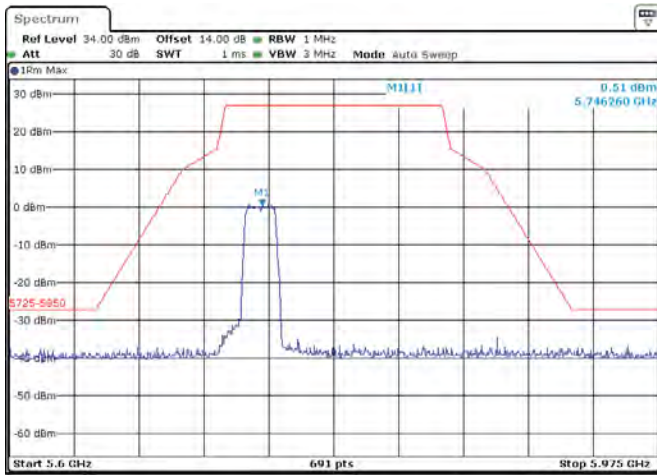

ANT 2(11N) 5745MHz

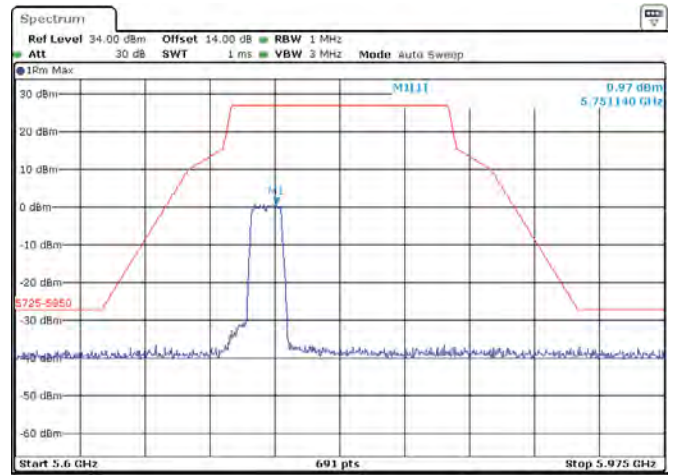

ANT 1(11N) 5825MHz

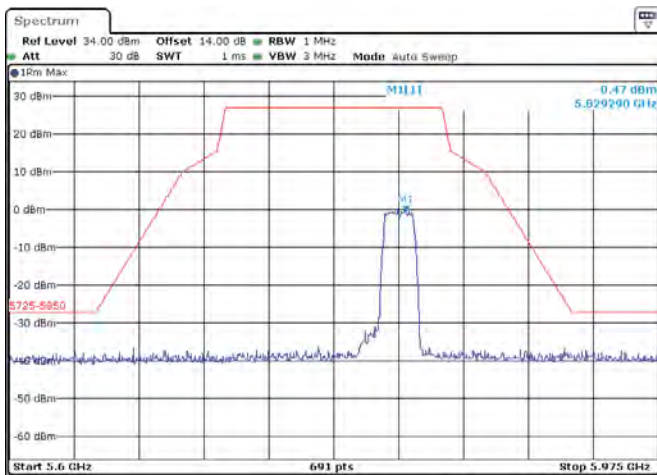

ANT 2(11N) 5825MHz

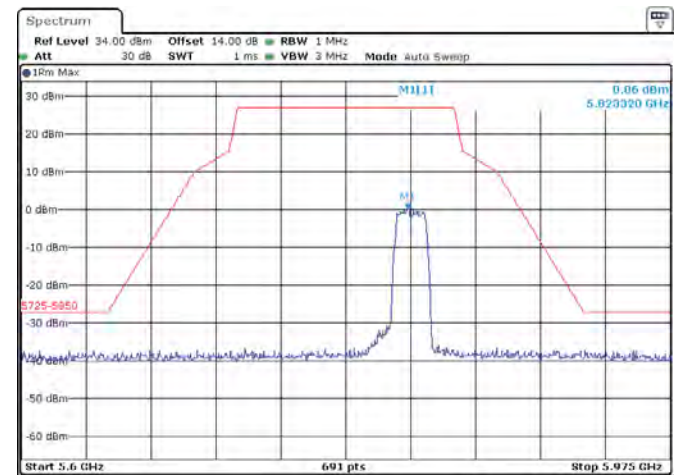

14.FREQUENCIES STABILITY

14.1.Block Diagram of Test Setup

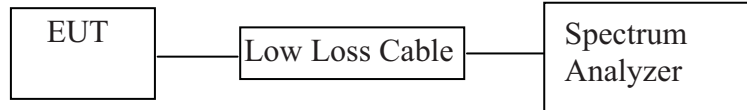

(EUT: Vaxis wireless video system)

14.2.EUT Configuration on Measurement

Manufacturers of U-NII devices are responsible for ensuring frequency stability such that an emission is maintained within the band of operation under all conditions of normal operation as specified in the user manual.

14.3.Operating Condition of EUT

14.3.1.Setup the EUT and simulator as shown as Section 14.1.

14.3.2.Turn on the power of all equipment.

14.3.3.Let the EUT work in TX modes measure it. The transmit frequency are 5150-5250 and 5725-5850MHz.

14.4.Test Result

Test Conditions	Measured Frequency(MHz) 5180
V nor(V)	5180.0077
V max(V)	5180.0081
V min(V)	5180.0092
Max. Deviation Frequency	0.0092
Max. Frequency Error (ppm)	1.78

Frequency Error vs. Temperature:

Test Conditions (°C)	Measured Frequency(MHz) 5180
-5	5180.0072
5	5180.0055
15	5180.0039
25	5180.0081
35	5180.0089
45	5180.0051
50	5180.0029
Max. Deviation Frequency	0.0089
Max. Frequency Error (ppm)	1.72

Test Conditions	Measured Frequency(MHz) 5825
V nor(V)	5825.0055
V max(V)	5825.0047
V min(V)	5825.0059
Max. Deviation Frequency	0.0059
Max. Frequency Error (ppm)	1.01

Frequency Error vs. Temperature:

Test Conditions (°C)	Measured Frequency(MHz) 5825
-5	5825.0033
5	5825.0051
15	5825.0059
25	5825.0062
35	5825.0041
45	5825.0062
50	5825.0071
Max. Deviation Frequency	0.0071
Max. Frequency Error (ppm)	1.22

15. POWER LINE CONDUCTED MEASUREMENT

15.1. Block Diagram of Test Setup

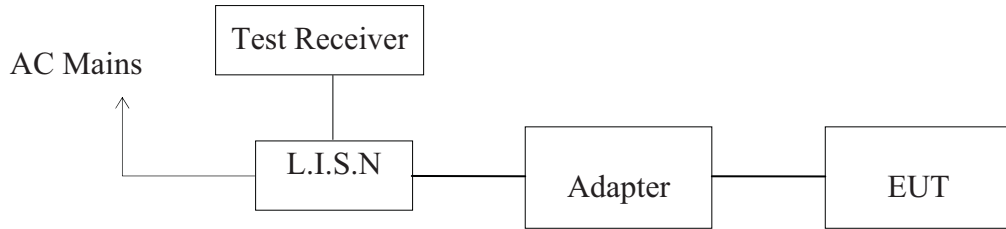

(EUT: Vaxis wireless video system)

15.2. Power Line Conducted Emission Measurement Limits

Frequency (MHz)	Limit dB(μ V)	
	Quasi-peak Level	Average Level
0.15 - 0.50	66.0 – 56.0 *	56.0 – 46.0 *
0.50 - 5.00	56.0	46.0
5.00 - 30.00	60.0	50.0

NOTE1: The lower limit shall apply at the transition frequencies.
 NOTE2: The limit decreases linearly with the logarithm of the frequency in the range 0.15MHz to 0.50MHz.

15.3. Configuration of EUT on Measurement

The following equipments are installed on Power Line Conducted Emission Measurement to meet the commission requirement and operating regulations in a manner, which tends to maximize its emission characteristics in a normal application.

15.4. Operating Condition of EUT

15.4.1. Setup the EUT and simulator as shown as Section 15.1.

15.4.2. Turn on the power of all equipment.

15.4.3. Let the EUT work in test mode and measure it.

15.5. Test Procedure

The EUT is put on the plane 0.8 m high above the ground by insulating support and is connected to the power mains through a line impedance stabilization network (L.I.S.N.). This provides a 50ohm coupling impedance for the EUT system. Please refer the block diagram of the test setup and photographs. Both sides of AC lines are checked to find out the maximum conducted emission. In order to find the maximum emission levels, the relative positions of equipment and all of the interface cables shall be changed according to ANSI C63.10: 2013 on Conducted Emission Measurement.

The bandwidth of test receiver (R & S ESCS30) is set at 9kHz.

The frequency range from 150kHz to 30MHz is checked.

15.6. DATA SAMPLE

Frequency (MHz)	Quasi Peak Level (dB μ v)	Average Level (dB μ v)	Transducer value (dB)	QuasiPeak Result (dB μ v)	Average Result (dB μ v)	Quasi Peak Limit (dB μ v)	Average Limit (dB μ v)	QuasiPeak Margin (dB)	Average Margin (dB)	Remark (Pass/Fail)
X.XX	29.4	18.3	11.1	40.5	29.4	56.0	56.0	15.5	16.6	Pass

Transducer value = Insertion loss of LISN + Cable Loss
 Result = Quasi-peak Level/Average Level + Transducer value
 Limit = Limit stated in standard

Calculation Formula:

Margin = Limit – Reading level value – Transducer value

15.7. Power Line Conducted Emission Measurement Results

PASS.

The frequency range from 150kHz to 30MHz is checked.

Emissions attenuated more than 20 dB below the permissible value are not reported.

The spectral diagrams are attached as below.

ACCURATE TECHNOLOGY CO.,LTD

CONDUCTED EMISSION STANDARD FCC PART 15B

EUT: Vaxis wireless video system M/N:Vaxis Atom 500
 Manufacturer: Hunan GM innovation technology Co.,Ltd.
 Operating Condition: WIFI OPERATION
 Test Site: 2#Shielding Room
 Operator: Frank
 Test Specification: N 120V/60Hz
 Comment: Report NO.:ATE20191739
 Start of Test: 2019-12-6 / 9:57:10

SCAN TABLE: "V 150K-30MHz fin"

Start	Stop	Step	Detector	Meas. Time	IF Bandw.	Transducer
150.0 kHz	30.0 MHz	4.5 kHz	QuasiPeak	1.0 s	9 kHz	NSLK8126 2008

Short Description: SUB STD VTERM2 1.70
 Average

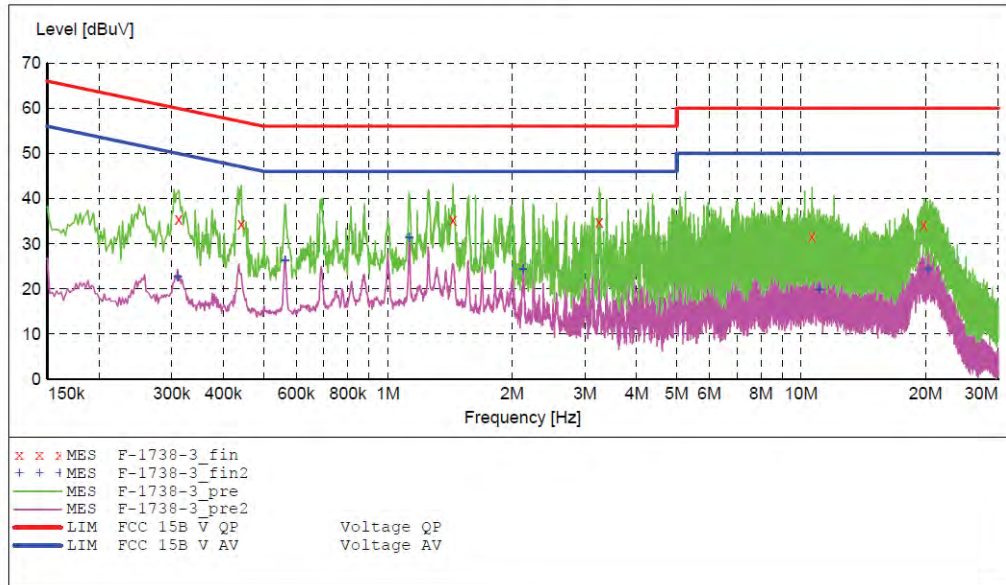

MEASUREMENT RESULT: "F-1739-3_fin"

2019-12-6 9:58

Frequency MHz	Level dBuV	Transd dB	Limit dBuV	Margin dB	Detector	Line	PE
0.312000	35.50	10.9	60	24.4	QP	N	GND
0.442000	34.40	11.0	57	22.6	QP	N	GND
1.438000	35.10	11.2	56	20.9	QP	N	GND
3.250000	34.70	11.4	56	21.3	QP	N	GND
10.625000	31.60	11.6	60	28.4	QP	N	GND
19.825000	34.10	11.7	60	25.9	QP	N	GND

MEASUREMENT RESULT: "F-1739-3_fin2"

2019-12-6 9:58

Frequency MHz	Level dBuV	Transd dB	Limit dBuV	Margin dB	Detector	Line	PE
0.310000	22.60	10.9	50	27.4	AV	N	GND
0.564000	26.20	11.0	46	19.8	AV	N	GND
1.126000	31.30	11.2	46	14.7	AV	N	GND
2.125000	24.30	11.3	46	21.7	AV	N	GND
11.070000	20.00	11.6	50	30.0	AV	N	GND
20.240000	24.40	11.7	50	25.6	AV	N	GND

ACCURATE TECHNOLOGY CO.,LTD

CONDUCTED EMISSION STANDARD FCC PART 15B

EUT: Vaxis wireless video system M/N:Vaxis Atom 500
 Manufacturer: Hunan GM innovation technology Co.,Ltd.
 Operating Condition: WIFI OPERATION
 Test Site: 2#Shielding Room
 Operator: Frank
 Test Specification: L 120V/60Hz
 Comment: Report NO.:ATE20191739
 Start of Test: 2019-12-6 / 9:59:35

SCAN TABLE: "V 150K-30MHz fin"

Start	Stop	Step	Detector	Meas. Time	IF Bandw.	Transducer
150.0 kHz	30.0 MHz	4.5 kHz	QuasiPeak	1.0 s	9 kHz	NSLK8126 2008

Short Description: SUB STD VTERM2 1.70
 Average

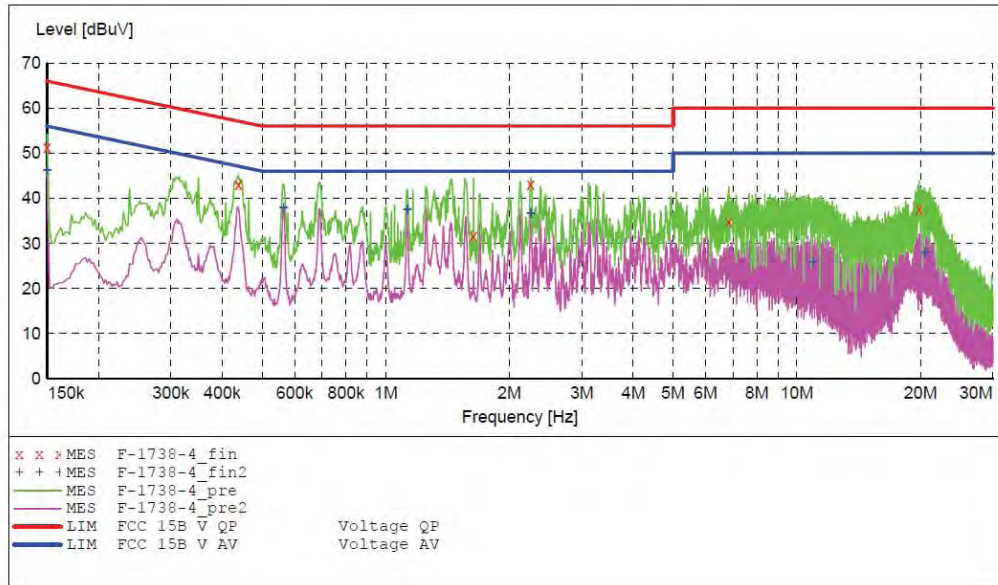

MEASUREMENT RESULT: "F-1739-4_fin"

2019-12-6 10:01

Frequency MHz	Level dBuV	Transd dB	Limit dBuV	Margin dB	Detector	Line	PE
0.150000	51.30	10.8	66	14.7	QP	L1	GND
0.438000	43.20	11.0	57	13.9	QP	L1	GND
1.636000	31.70	11.2	56	24.3	QP	L1	GND
2.255000	43.20	11.3	56	12.8	QP	L1	GND
6.835000	34.80	11.5	60	25.2	QP	L1	GND
19.840000	37.60	11.7	60	22.4	QP	L1	GND

MEASUREMENT RESULT: "F-1739-4_fin2"

2019-12-6 10:01

Frequency MHz	Level dBuV	Transd dB	Limit dBuV	Margin dB	Detector	Line	PE
0.150000	46.20	10.8	56	9.8	AV	L1	GND
0.564000	38.00	11.0	46	8.0	AV	L1	GND
1.128000	37.60	11.2	46	8.4	AV	L1	GND
2.255000	36.60	11.3	46	9.4	AV	L1	GND
10.930000	25.90	11.6	50	24.1	AV	L1	GND
20.515000	27.90	11.7	50	22.1	AV	L1	GND

16.ANTENNA REQUIREMENT

16.1.The Requirement

According to Section 15.203, an intentional radiator shall be designed to ensure that no antenna other than that furnished by the responsible party shall be used with the device.

16.2.Antenna Construction

Device is equipped with permanent attached antenna, which isn't displaced by other antenna. The maximum gain of each antenna is 2.5dBi. Therefore, the equipment complies with the antenna requirement of Section 15.203.

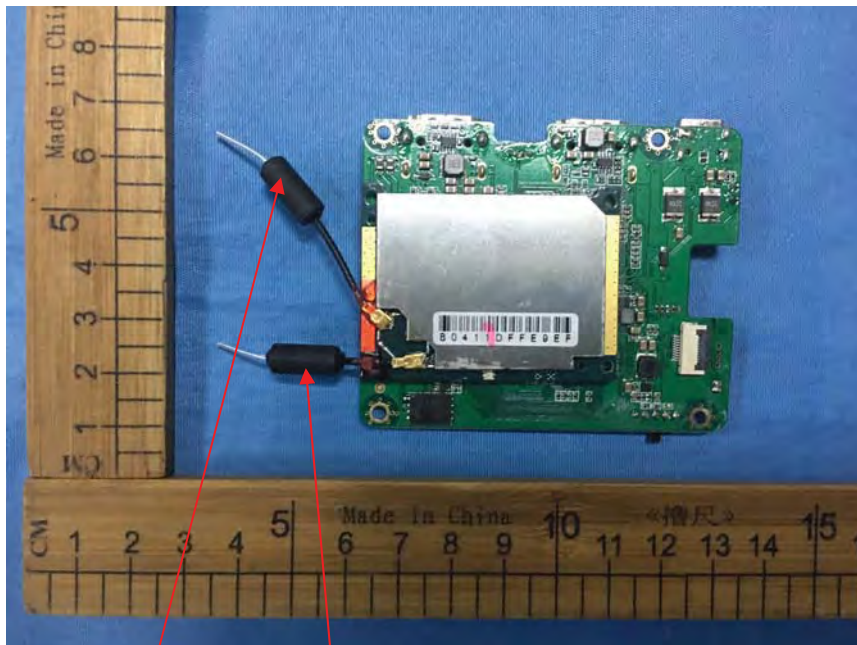

Antenna 1

Antenna 2