

AOK-5003A Instruction manual

Thank you for purchasing this Weather Station, Please read the operating instructions carefully to familiarize yourself with the features and modes of operation before using the instrument.

Keep the manual for future reference and pass it on with the device, if you pass on the device to other users.

NOTE: Always remember to use high quality batteries & change them at least once per year.

Package Contents

Carefully unpack and remove the contents:

- 1x Weather station main unit
- 1x Stainless steel mast
- 1x Thermo-hygro sensor
- 1x Rain sensor
- 1x Wind speed sensor
- 1x Wind direction sensor
- 1x Radiation shield
- Mounting screws
- Stainless steel accessory for fixing the mast.

Product overview

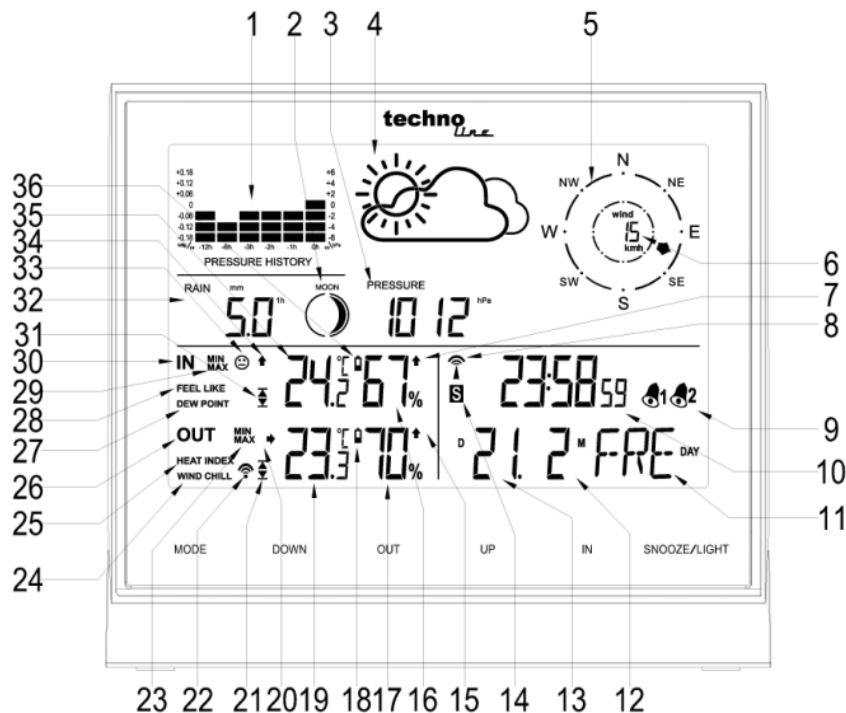

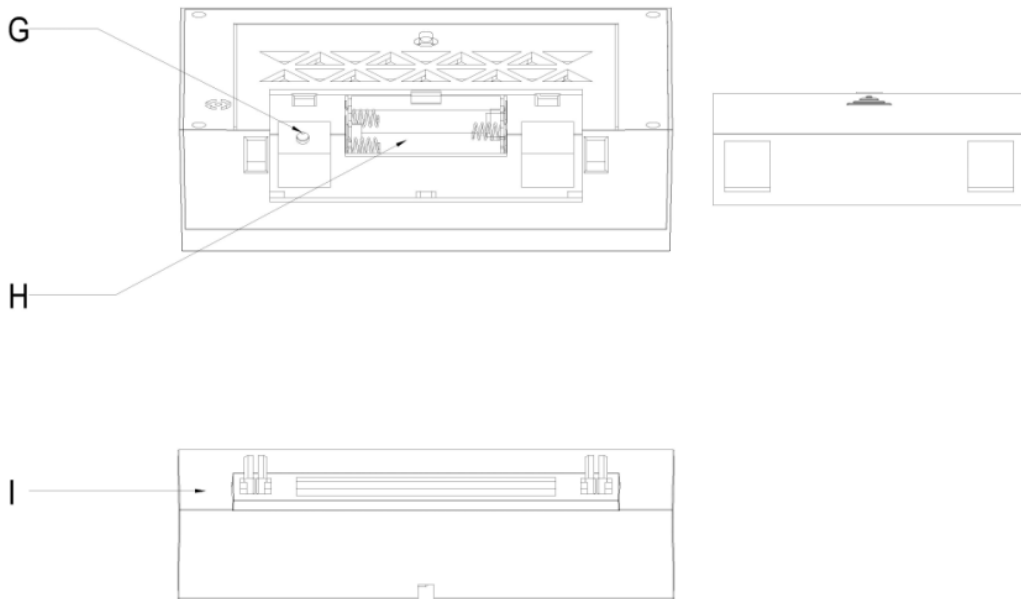
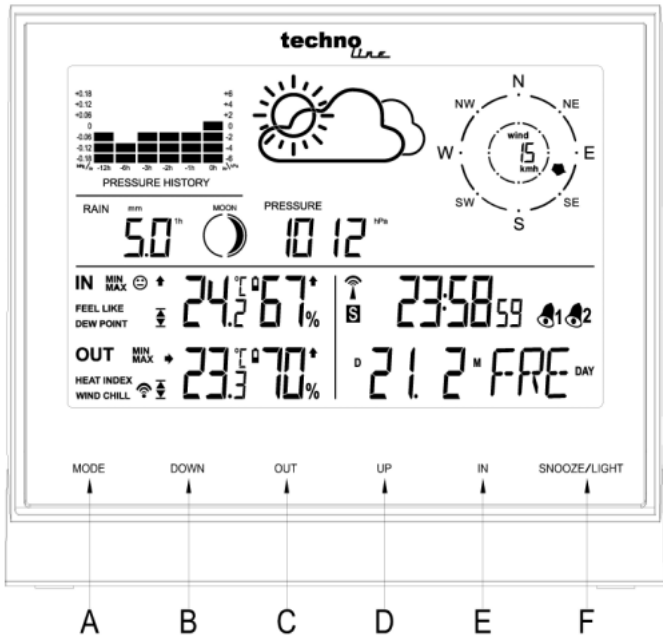

- | | |
|------------------------------------|---|
| 1 12 hour air pressure history bar | 9 Alarm |
| 2 Moon phase | 10 Time |
| 3 Air pressure | 11 Day of week |
| 4 Weather forecast | 12 Month (in DM mode) / Date (in MD mode) |
| 5 Wind direction | 13 Date (in DM mode) / Month (in MD mode) |
| 6 Wind speed | 14 Daylight Saving Time |
| 7 Indoor humidity trend | 15 Outdoor humidity trend |
| | 16 Indoor humidity |

- | | |
|--|---------------------------------|
| 17 Outdoor humidity | 29 Indoor MAX / MIN |
| 18 Outdoor low battery indicator | 30 Indoor information |
| 19 Outdoor temperature | 31 Indoor temperature alert |
| 20 Outdoor temperature trend | 32 Rainfall |
| 21 Outdoor temperature alert | 33 Living space icon |
| 22 RF outdoor sensor reception indicator | 34 Indoor temperature trend |
| 23 Outdoor MAX / MIN | 35 Indoor temperature |
| 24 Wind Chill | 36 Indoor low battery indicator |
| 25 Heat Index | |
| 26 Outdoor sensor information | G Power adaptor socket |
| 27 Dew point | H Battery compartment |
| 28 Feel like | I Stand |

	Press button	Hold button
(A) MODE	Time / Alarm1 / Alarm2 / In temp alert / Out temp alert mode switching	Setting the time, setting the alarm time, setting the temperature alert
(B) DOWN	1. One step back in setting 2. View the rainfall 1hr / 24hr / TOTAL 3. Alarm on / off in alarm mode	Clear the rainfall reading
(C) OUT	View heat index and wind chill	Search for Radio Frequency outdoor sensor
(D) UP	1. One step forward in setting 2. View the Max / Min temperature and humidity 3. Alarm on / off in alarm mode	Clear the Max / Min temperature and humidity record
(E) IN	View feel like / dew point	RCC reception or clear RCC reception
(F) SNOOZE/ LIGHT	1. Activates alarm snooze 2. Display black light (when without power adaptor plugged in) 3. Change display brightness (when power adaptor plugged in)	Altitude and weather icon setting

Getting Start with Power Supply

Insert Batteries

1. Gently remove the stand downwards and remove battery compartment cover from the main unit.
2. Insert the batteries, matching the polarities (+/-).

DC Power

1. Put the power cable pass through the hole in the stand, plug the power cable to the power jack and plug the power adapter into a suitable power outlet.

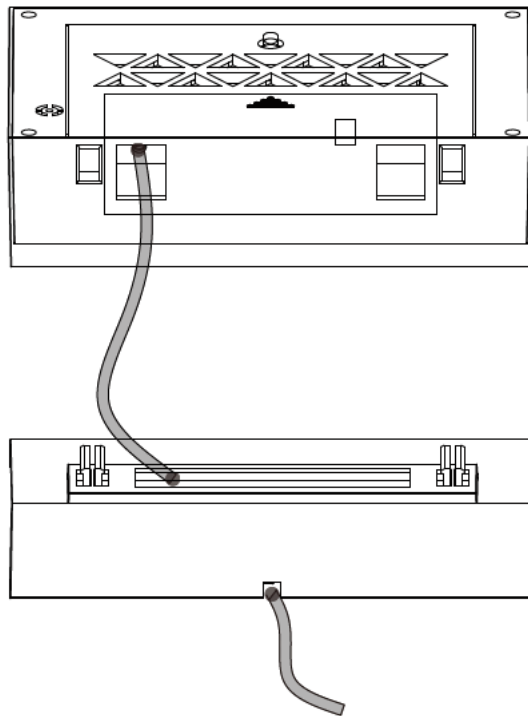

NOTE It is recommended to insert the battery as a backup power

Remote Sensor

1. Pull away the radiation shield of the thermo-hrgro sensor to reveal the 2 sockets.(for the wind sensor and rain sensor)
2. Open the thermo-hygro sensor battery door, insert the batteries, matching the polarities (+/-)

Note: To prevent water from entering the sensor, it is important to make sure the battery lid closes tightly.

3. Place the sensor near the main unit in order to establish an effective wireless transmission. Do not place the sensor outside until the transmission have be confirmed.
4. Observe the LCD screen to see OUT temperature and humidity displayed to confirm the transmission completed

NOTES:

- Every time the power adaptor unplugged and with no batteries inserted, the main unit will lose all the weather data.

1) Mounting the outdoor sensor onto the stainless steel mast

Attention!! Before assembly the outdoor sensor, the transmission between main unit and the thermo-hygro sensor must be established

For accurate results, the outdoor sensor mast should be securely mounted onto a horizontal surface and in an open area away from trees and other coverings where rainfall or wind speed may be reduced causing inaccurate reading.

The following diagram shows how the parts go together.

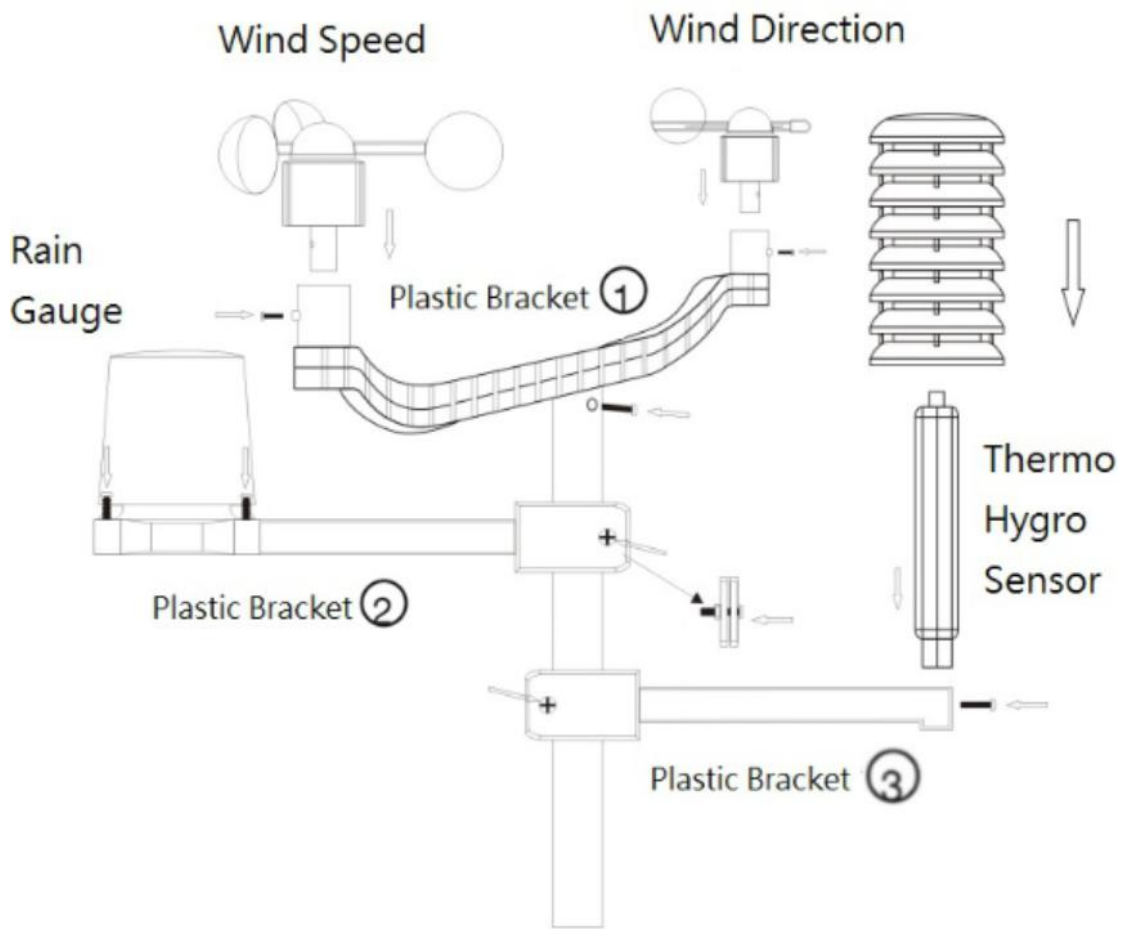

2) Mounting the wind speed sensor to the ① plastic bracket: first check the wind-fan can rotate freely before fixing. The wind speed sensor should now be mounted onto the bracket provided to allow the wind to travel around the sensor unhindered from all directions. Then fix it with bolt and screw. Please follow the below display:

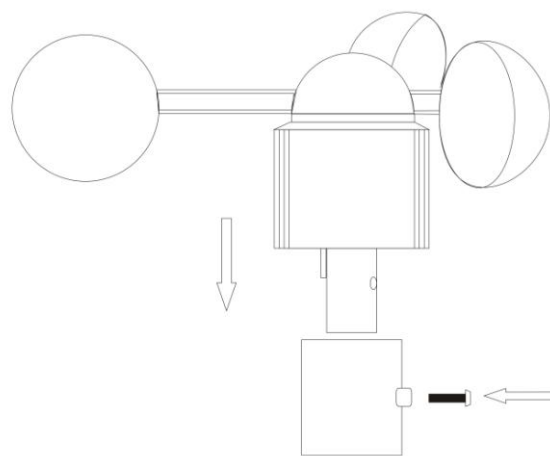

3) Mounting the wind direction sensor to the ① bracket: first check the wind direction sensor before fixing, the wind direction sensor should now be mounted onto the bracket provided to allow the wind to travel around the sensor unhindered from all directions. Then fix it with bolt and screw. there is one cable from wind speed sensor, please insert it into the socket under the wind direction sensor. please follow the below display:

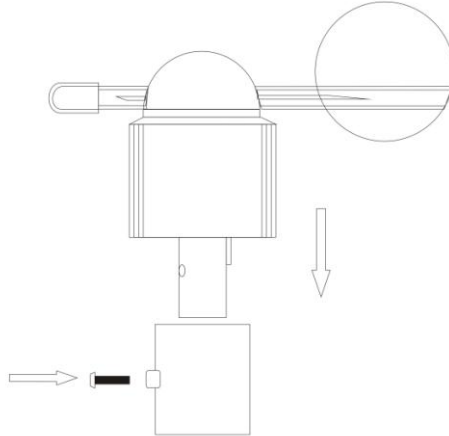

Attention!! Please align the “North” indicator sticker with the NORTH direction to enable it to record accurate reading

4) Mounting the rain sensor to the ② bracket: there are vertical engraved lines at the bottom edge of the round cover and the sensor part, you only need adjust the two line into one position, then turn clockwise, the rain sensor part will be connected well, then fix them with 4 screws and bolt onto the plastic bracket (don't use only 2 screws) please follow the below display:

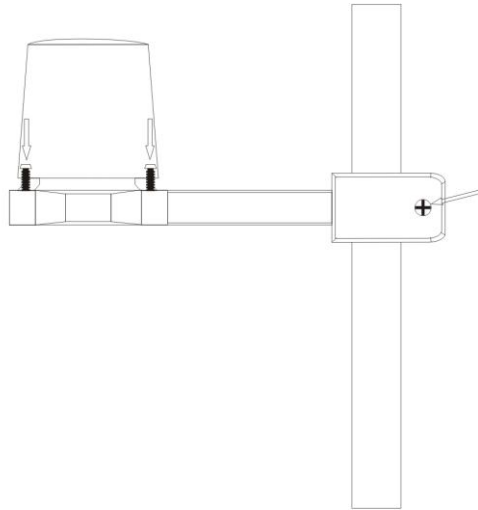

- Note: The cover of the Rain Gauge can be removed by rotating in an anti-clockwise direction. When replacing the cover it will only fit in one position. When you find the correct position it fits snugly on, and then rotate it clockwise to secure the cover in place.
- It is important that the cover is securely located.

5) Mounting the thermo-hygro sensor to the ③ bracket:

Once the wind sensors and rain sensor are fixed onto the bracket, insert the cables from the Wind Sensor & the Rain Gauge into the correct sockets. These are label on the plastic under the sockets.

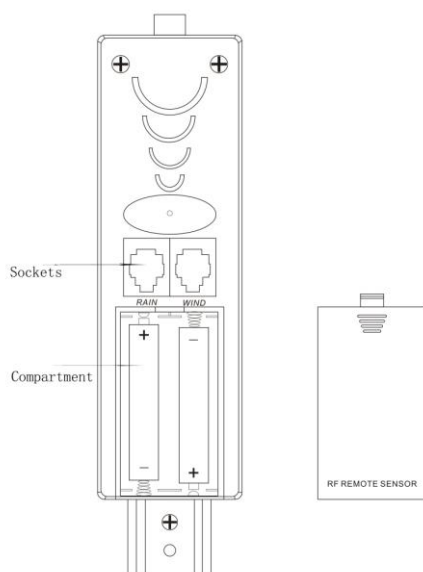

So that data can be transmitted to the main unit, then put the radiation shield onto the thermo-hygro sensor, please follow the below display:

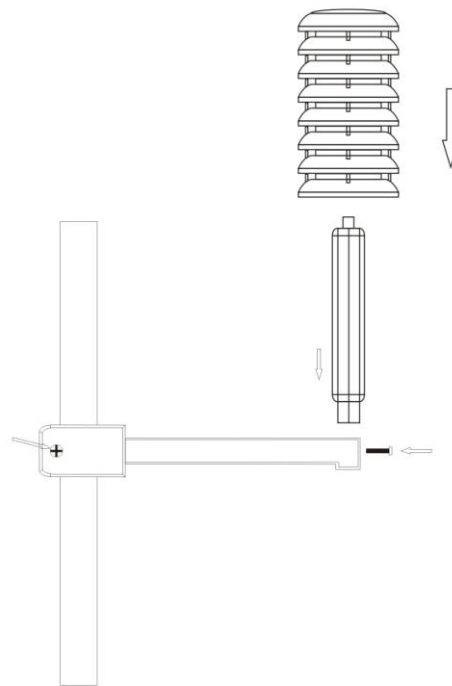

Note: please don't put in or take off the plug very often, or put the plug outside in the air so long time to avoid any damage of the plug, if so, there will be bad connection.

6) Mounting all the sensors onto the stainless steel mast and fix the whole parts at outdoor open area (please refer to the illustration above)

Note: please make sure all the cables are connected well into the sockets)

Initial Operation

- After inserting the batteries, the altitude flashing in meters, press **"UP "** or **"DOWN "** to set the altitude of your position, then press **"SNOOZE/LIGHT"** to confirm
- The weather icon flashing, press **"UP "** or **"DOWN "** to choose the weather, then press **"SNOOZE/LIGHT"** to confirm
- This process takes about 3 minutes. Then the display shows the outdoor temperature /humidity/wind speed/wind direction/rainfall, in case of failure of reception, please press **"OUT"** for more than 3 seconds to receive again.
- Once radio signal receiving is successful, the display shows the symbol "radio tower" continuously

Information

- Please observe a minimal distance of 2.5m to sources of interference such as televisions or computer screens.
- The radio signal is weaker in rooms with concrete walls (e.g. in the basement) and in office buildings. For extreme cases, please put the main unit near a window.
- There are less atmospheric disturbances at night. A radio time signal reception is usually possible at that time. One synchronization per day is sufficient to keep the time display accuracy at 1 second.

Manual set-up

- Press "**MODE**" to switch to the "Time display mode"
- Press and hold key "**MODE**" for 3 seconds.
- The 12/24 hour flashing. Use "**UP**" and "**DOWN**" to select
- Press "**MODE**" to confirm.
- The DM/MD flashing, Use "**UP**" and "**DOWN**" to select
- Press "**MODE**" to confirm.
- The display for the year is flashing. Use "**UP**" and "**DOWN**" to select the year.
- Press "**MODE**" to confirm.
- The display for the month is flashing. Use "**UP**" and "**DOWN**" to select the month.
- Press "**MODE**" to confirm.
- The display for the date is flashing. Use "**UP**" and "**DOWN**" to select the date.
- Press "**MODE**" to confirm.
- The display for the hour is flashing. Use "**UP**" and "**DOWN**" to select the hour.
- Press "**MODE**" to confirm.
- The display for the minutes is flashing. Use "**UP**" and "**DOWN**" to select the minutes..
- Press "**MODE**" to confirm.
- The language selection for the display of the weekdays is flashing. Use "**UP**" and "**DOWN**" to select the language (GER- German, ENG - English, ITA - Italian, FRE - French, DUT - Dutch, SPA - Spanish, DAN - Danish).
- Press "**MODE**" to confirm
- The F/C for temperature flashing, Use "**UP**" and "**DOWN**" to select.
- Press "**MODE**" to confirm.
- The hPa/inHg for air pressure flashing, Use "**UP**" and "**DOWN**" to select .
- Press "**MODE**" to confirm.
- The mm/inch for rainfall and kmh/mph flashing, Use "**UP**" and "**DOWN**" to select.
- Press "**MODE**" to confirm.

Information:

- The clock automatically exit the set-up mode if no keys are pressed for 20 seconds.

Daily alarm set-up

- Press “**MODE**” to switch to “Alarm1” mode, “A1” and the alarm displayed
- Press and hold the key “**MODE**” for 3 seconds ,the flashing alarm time are shown
- The hour display of the alarm time is flashing. Use “UP “and “DOWN “to select the hour. Press “**MODE**” to confirm.
- Then follow the minutes. Use “UP “ and “DOWN “ to select the minutes,
- Press “**MODE**” to confirm.
- Then press “**MODE**” to switch from A1 display to A2 display
- The same setting as for A2.

Daily alarm on/off

- Press “**MODE**” to switch from time display to “Alarm 1” or “Alarm 2” mode
 - When showing A1 or A2 alarm time, press “**UP**“or “**DOWN**” to activate the alarm with alarm symbol showing.
 - Press “**UP**’ or “**DOWN**” again to cancel the alarm
- Information:**
- The clock automatically changes from set-up mode to time mode if no keys are pressed for 20 seconds.
 - The alarm sounds for 2 minutes if no key is pressed to stop it.

Snooze function

To activate the snooze function, follow the steps below







- Press the key “**SNOOZE/LIGHT**“, while the alarm sounds, to activate the snooze function.
- If the snooze function is activated, alarm symbol is flashing.
- The alarm repeat after 5 minutes.
- The snooze function can be stopped by pressing any key.

Temperature alert set-up

- Press “**MODE**” to switch to “Temperature alert” mode
- In the “Temperature alert” mode, the indoor / outdoor temperature alert upper limit and the



icon displayed.

- Press “**MODE**” again the indoor / outdoor temperature alert lower limit and  icon displayed.
- In the “Temperature alert” mode, press and hold the “**MODE**” key, the “alert up / down”  flashing.
- Press “**UP**” or “**DOWN**” to set the alert on or off. The “alert up / down” icon  showed when it turned on.
- Press “**MODE**” to confirm
- The indoor upper limit temperature alert and the upper alert icon  are flashing, press “**UP**” or “**DOWN**” to set the maximum alert temperature.
- Press “**MODE**” to confirm
- The indoor lower limit temperature alert and the lower alert icon  are flashing, press “**UP**” or “**DOWN**” to set the minimum alert temperature.
- Press “**MODE**” to confirm
- The outdoor upper limit temperature alert and the upper alert icon  are flashing, press “**UP**” or “**DOWN**” to set the maximum alert temperature.
- Press “**MODE**” to confirm
- The outdoor lower limit temperature alert and the lower alert icon  are flashing, press “**UP**” or “**DOWN**” to set the minimum alert temperature.
- Press “**MODE**” to confirm, the weather station will return to the “Time display mode”

Information

- The clock automatically changes from temperature alert mode to time mode if no keys are pressed for 20 seconds.
- The lower alert temperature selected must at least be 1°C below the upper alert selected temperature.

Temperature alert ring:

- When the temperature reach the alert level and when alert turned on, the alert symbol  flash with alert sound
- Press any key to stop the alert sound, the alert symbol and corresponding temperature still flash until the temperature is out of alert range
- Or press “**MODE**” to switch to the “Temperature alert mode”, press and hold the “**MODE**” key to enter setup, then press “**UP**” or “**DOWN**” to deactivate the alert

12/24 hours mode

- The time display can be in 12 (AM/PM) or 24 hours mode, please follow the “Manual set-up” section to select

°F/°C temperature display

- The temperature display can be in °F or °C , please follow the “Manual set-up” section to select.

Max. / Min. for the indoor/outdoor temperature and humidity

- Press “**MODE**” to switch to “Time display” / “Indoor temperature alert” / “Outdoor temperature alert” mode
- Press “**UP**” to display indoor and outdoor max temperature and humidity,
- Press “**UP**” again to display indoor and outdoor min temperature and humidity
- Hold “**UP**” for more than 3 seconds to clear up the max./min.

Wind speed in mph/kmh (0~256kmh)

- The wind speed can be shown in **mph** and **kmh**, please follow the “Manual set-up” section to select **mph/kmh**, the display of the speed is updated in case of the sensor updated every 1 minute.

Wind direction





- There will be 16 wind directions, the display of the direction is updated in case of the sensor updated every 1 minutes

Rainfall display (0~999.99mm)

- Rain fall can be shown in **mm** and **inch**, please follow the “Manual set-up” section to select the **mm/inch**.
- Press “**MODE**” to switch to “Time display” mode.
- Press “**DOWN**” to switch to 1Hour, press again to 24 Hour, then Total wind speed and rainfall
- Press and hold “**DOWN**” to clear up the volume accordingly, such as if showing 1 hour, clear up the data in 1 hour, others unchanged, if showing 24 hours, clear up the data in 24 hour, others unchanged.

- The max. of the rainfall is up to 999.99mm (99.99inch), the display is flashing in case of the max., you have to clear up the data by hand, otherwise, the data can not be updated any more.

Weather forecast

				
Sunny	Slightly Sunny	Cloudy	Rainy	Heavy Rain

Remarks:



- As the weather forecast is calculated by air pressure only, the display will have discrepancy with the actual weather.
- Currently displayed icon means the forecast for the next 12–24 hours. It may not reflect the current state of the weather.

Altitude setting and barometer

- After inserting batteries or plugged in adaptor into the weather station, or by pressing and holding the “**SNOOZE/LIHT**” button, set your altitude for more precise pressure calculation.
- Use the “**UP**” and “**DOWN**” buttons to set a value in the range -190 m to 2000 m (10 m increment). , press “**SNOOZE/LIHT**” to confirm.
- After setting the altitude, use “**UP**” and “**DOWN**” buttons to set the weather forecast icon, press “**SNOOZE/LIHT**” to confirm
- For accurate barometric pressure trends, the weather station should operate at the same altitude for recordings (i.e. it should not be moved from the ground to the second floor of the house). When the unit is moved to a new location, discard readings for the next 12 hours and correct the height adjustment (see "Initial operation") if needed.

Temperature, humidity and pressure trends



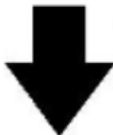





- The arrow shows the trends of values of the temperature and humidity measurements on sensor or station.

Indications on the display			
Temperature and	Rising	Constant	Falling

humidity trends			
-----------------	--	--	--

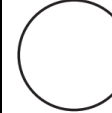

Moon phase display



Icons for the main phases of the moon are as follows:

							
New moon	Waxing crescent	First quarter	Waxing gibbous	Full moon	Waning gibbous	Last quarter	Waning crescent

Living space icon

The weather station uses saved data to determine the indoor humidity in the living space to show the respective symbols for your health and home environment.

Comfortable	
Dry	
Wet	

- If the indoor humidity is within 40–70 % RH and the temperature within 20–28 °C, the  icon (comfortable environment) will be displayed.
- If the indoor humidity is lower than 40 % RH, the  icon (dry environment) will be displayed.
- If the indoor humidity is higher than 70 % RH, the  icon (wet environment) will be displayed.
- If the temperature is not within 20–28 °C and humidity is within 40–70% RH, no icon will be displayed.

Feel Like and Dew Point

Press **"IN"** to display "Feel Like", press "IN" again to display "Dew Point"

- **"Feel Like"** temperature is a measurement of how hot or cold you really feel like. It is measured by the temperature, humidity, and wind speed.
- **"Dew point"** is the temperature to which air must be cooled to become saturated with water vapor.
- When the dew point value is below 0°C, "LL.L" display
- When the dew point value is above 60°C, "HH.H" display

Heat Index and Wind Chill

Press **"Out"** to display "Heat Index", press "Out" again to display "Wind Chill"

- **"Heat Index"** combines the factors of heat and humidity. It is the apparent temperature of how hot it feels to a human being.
- Note: Heat Index is only displayed when temperature above 26.7°C
- **"Wind Chill"** is a measure of how cold felt by the body on exposed skin due to the flow of air.
- Note: Wind Chill is only displayed when temperature below 5°C and wind speed above 3kmh

Backlight

- When plugged in power adaptor, press **"Snooze/Light"** to dim the backlight brightness or turn the display off
- When powered by batteries only, the backlight will be automatically off after 10 seconds without pressing any keys, press **"Snooze/Light"** to activate it for 10 seconds.

Low battery condition display

The weather station displays the low battery condition symbol to remind the batteries of the weather station or the outdoor sensor need to be exchanged.

- Weather station low battery condition display: within indoor area of the display
- Outdoor sensor low battery condition display: in the outdoor area of the display

Troubleshooting

Display screen not working	<ul style="list-style-type: none">• Check the batteries in main unit are inserted and power adaptor is plugged in correctly
No outdoor sensor reception	<ul style="list-style-type: none">• Check the batteries in sensor are inserted correctly• Battery may need to be replaced

	<ul style="list-style-type: none"> Relocate the weather station and the sensor. The maximum transmission range is 100m without obstruction Press and hold “OUT“ key for RF reception again Try to reset the units, take the sensor near the weather station, reinstall the batteries and replug power adaptor, place the sensor outdoor until reception success Check the distance of the weather station and the sensor from the sources of interference (computer monitors or television sets). It should be at least 1.5 to 2 m during the reception of the signal.
Rainfall display error	<ul style="list-style-type: none"> Remove rain gauge cover to see if any obstruction inside Make sure the rain gauge is mounted securely Make sure the outdoor sensor cable connect properly
Inaccurate weather forecast	<ul style="list-style-type: none"> Currently displayed icon means the forecast for the next 12–24 hours. It may not reflect the current state of the weather. Set the correct altitude For accurate barometric pressure trends, the weather station should operate at the same altitude for recordings (i.e. it should not be moved from the ground to the second floor of the house). When the unit is moved to a new location, discard readings for the next 12 hours and correct the height adjustment if needed
Wrong temperature	<ul style="list-style-type: none"> Press “MODE“ to check if it is in alert mode. In the alert mode, the unit will display the alert upper or lower limit.

Care and maintenance

- Read carefully the manual before using this product.
- Do not expose the main unit to direct sunlight, extreme cold and moisture, and sudden changes in temperature. This would reduce the accuracy of detection.
- Do not place the product in locations prone to vibration and shocks – these may cause damage.
- Do not expose the product to excessive force, impacts, dust, high temperatures or humidity - these may cause malfunction, shorter battery life, damage to batteries and deformation of plastic parts.
- Do not expose the main unit to rain or moisture, if it is not intended for outdoor use.
- Do not place any open flame sources on the product, e.g. a lit candle, etc.

- Do not place the product to places with inadequate air flow.
- Do not insert any objects in the product vents.
- Do not tamper with the internal electric circuits of the product – you may damage it, which will automatically terminate the guarantee. The product should only be repaired by a qualified professional.
- To clean the product, use a slightly moistened soft cloth. Do not use solvents or cleaning agents - they could scratch plastic parts and damage electric circuits.
- Do not immerse the product in water or other liquids.
- The main unit may not be exposed to dripping or splashing water.
- In the event of damage or defect of the product, do not perform any repairs by yourself.
- The transmitter of the wireless indoor/outdoor thermometer works down to -20°C, but at low temperatures, especially for a long period of time, the batteries may freeze, which may prevent the transmitter from transmitting the signal to the receiver and at the same time the transmission range is reduced at very low temperatures.
- This device is not intended for use by persons (including children) whose physical, sensory or mental disability or lack of experience and expertise prevents safe use, unless they are supervised or instructed regarding use of the appliance by a person responsible for their safety. It is necessary to supervise children to ensure they do not play with the device.

Note

- Manufacturer reserves the right to change specifications of the product.
- Manufacturer and supplier are not responsible for malfunction where interference occurs.
- This product is not intended for medical or commercial purposes.

Technical data

a) Main Unit

- Barometer unit: hPa / inHg
- Barometer pressure measuring range: 850hPa to 1050hPa
- Weather display: Sunny, Slightly Sunny, Cloudy, Rainy, Storm
- Temperature unit: °F / °C
- Temperature measurement range: 32~122°F (0 °C to +50 °C)
- Indoor temperature / humidity trend and max / min function
- Moon phase
- Humidity measurement range: 20 to 95%
- Living space humidity display
- Time display: 12/24 hour format
- Calendar: DD/MM or MM/DD
- Weekday in 7 languages: German, English, French, Italian, Dutch, Spanish, Danish
- Dual alarm with snooze function (5 minutes alarm interruption)

- Blue back light
- Power supply : 3 X AAA, UM-4, LR03 1.5V batteries, DC 5.0V power adapter

b) Outdoor sensor

- Transmission frequency: 433 MHz
- Transmission range: up to 100 m in open area with no obstruction
- Temperature measurement range: -68 to 158°F (-20 °C to +70 °C)
- Humidity measurement range: 20 to 95%
- Outdoor temperature / humidity trend and max / min function
- Rainfall measurement range: 0 to 999.99mm
- Wind speed measurement range: 0 to 256kmh
- Wind direction in 16 directions
- Power supply: 2 X AA, UM-3, LR6 1.5V batteries

FCC STATEMENT

This device complies with Part 15 of the FCC Rules. Operation is subject to the following two conditions: (1) This device may not cause harmful interference, and (2) This device must accept any interference received, including interference that may cause undesired operation.

WARNING Changes or modifications not expressly approved by the party responsible for compliance could void the user's authority to operate the equipment.

NOTE This equipment has been tested and found to comply with the limits for a Class B digital device, pursuant to Part 15 of the FCC Rules. These limits are designed to provide reasonable protection against harmful interference in a residential installation.

This equipment generates, uses and can radiate radio frequency energy and, if not installed and used in accordance with the instructions, may cause harmful interference to radio communications. However, there is no guarantee that interference will not occur in a particular installation. If this equipment does cause harmful interference to radio or television reception, which can be determined by turning the equipment off and on, the user is encouraged to try to correct the interference by one or more of the following measures:

Reorient or relocate the receiving antenna.

Increase the separation between the equipment and receiver.

Connect the equipment into an outlet on a circuit different from that to which the receiver is connected.

Consult the dealer or an experienced radio / TV technician for help.