



FCC RF Test Report

APPLICANT : Fibocom Wireless Inc.
EQUIPMENT : 5G Module
BRAND NAME : Fibocom
MODEL NAME : FM350-GL
FCC ID : ZMOFM350GL
STANDARD : 47 CFR Part 2, 22, 24, 27
CLASSIFICATION : PCS Licensed Transmitter (PCB)

The product was received on May 18, 2020 and completely tested on Mar. 07, 2021. We, Sporton International (ShenZhen) Inc., would like to declare that the tested sample has been evaluated in accordance with the procedures given in ANSI C63.26-2015 and shown compliance with the applicable technical standards.

The test results in this report apply exclusively to the tested model / sample. Without written approval of Sporton International (ShenZhen) Inc., the test report shall not be reproduced except in full.

Reviewed by: Derreck Chen / Supervisor

Approved by: Eric Shih / Manager



Sporton International (ShenZhen) Inc.

1/F, 2/F, Bldg 5, Shiling Industrial Zone, Xinwei Village, Xili, Nanshan, Shenzhen, 518055

People's Republic of China



TABLE OF CONTENTS

REVISION HISTORY...3
SUMMARY OF TEST RESULT...4
1 GENERAL DESCRIPTION...5
1.1 Applicant...5
1.2 Manufacturer...5
1.3 Product Feature of Equipment Under Test...5
1.4 Product Specification of Equipment Under Test...5
1.5 Modification of EUT...6
1.6 Maximum Conducted Power, Frequency Tolerance, and Emission Designator...6
1.7 Testing Location...7
1.8 Test Software...8
1.9 Applicable Standards...8
2 TEST CONFIGURATION OF EQUIPMENT UNDER TEST...9
2.1 Test Mode...9
2.2 Connection Diagram of Test System...11
2.3 Support Unit used in test configuration and system...11
2.4 Measurement Results Explanation Example...11
2.5 Frequency List of Low/Middle/High Channels...12
3 CONDUCTED TEST ITEMS...14
3.1 Measuring Instruments...14
3.2 Test Setup...14
3.3 Test Result of Conducted Test...14
3.4 Conducted Output Power and ERP/EIRP...15
3.5 Peak-to-Average Ratio...16
3.6 Occupied Bandwidth...17
3.7 Conducted Band Edge...18
3.8 Conducted Spurious Emission...19
3.9 Frequency Stability...20
4 RADIATED TEST ITEMS...21
4.1 Measuring Instruments...21
4.2 Test Setup...21
4.3 Test Result of Radiated Test...21
4.4 Radiated Spurious Emission...22
5 LIST OF MEASURING EQUIPMENT...23
6 UNCERTAINTY OF EVALUATION...24
APPENDIX A. TEST RESULTS OF CONDUCTED TEST
APPENDIX B. TEST RESULTS OF RADIATED TEST
APPENDIX C. TEST SETUP PHOTOGRAPHS



SUMMARY OF TEST RESULT

Report Section	FCC Rule	Description	Limit	Result	Remark
3.4	§2.1046	Conducted Output Power	Reporting Only	PASS	-
	§22.913(a)(5)	Effective Radiated Power (5G NR n5)	ERP < 7 Watt		
	§24.232(c)	Equivalent Isotropic Radiated Power (5G NR n2, n25)	EIRP < 2Watt		
	§27.50(d)(4)	Equivalent Isotropic Radiated Power (5G NR n66)	EIRP < 1Watt		
3.5	§24.232(d)	Peak-to-Average Ratio	<13 dB	PASS	-
3.6	§2.1049	Occupied Bandwidth	Reporting Only	PASS	-
3.7	§2.1051 §22.917(a) §24.238(a) §27.53(h)	Conducted Band Edge Measurement (5G NR n5) (5G NR n2, n25) (5G NR n66)	< 43+10log ₁₀ (P[Watts])	PASS	-
3.8	§2.1051 §22.917(a) §24.238(a) §27.53(h)	Conducted Spurious Emission (5G NR n5) (5G NR n2, n25) (5G NR n66)	< 43+10log ₁₀ (P[Watts])	PASS	-
3.9	§2.1055 §22.355	Frequency Stability Temperature & Voltage	< 2.5 ppm for Part 22	PASS	-
	§24.235 §27.54		Within Authorized Band		
4.4	§2.1053 §22.917(a) §24.238(a) §27.53(h)	Radiated Spurious Emission (5G NR n5) (5G NR n2, n25) (5G NR n66)	< 43+10log ₁₀ (P[Watts])	PASS	Under limit 9.99 dB at 14664.000 MHz

Declaration of Conformity:
 The test results with all measurement uncertainty excluded are presented in accordance with the regulation limits or requirements declared by manufacturers.

Comments and Explanations:
 The declared of product specification for EUT presented in the report are provided by the manufacturer, and the manufacturer takes all the responsibilities for the accuracy of product specification.



1 General Description

1.1 Applicant

Fibocom Wireless Inc.

1101,Tower A, Building 6, Shenzhen International Innovation Valley, Dashi 1st Rd, Nanshan,Shenzhen, China

1.2 Manufacturer

Fibocom Wireless Inc.

1101,Tower A, Building 6, Shenzhen International Innovation Valley, Dashi 1st Rd, Nanshan,Shenzhen, China

1.3 Product Feature of Equipment Under Test

Product Feature	
Equipment	5G Module
Brand Name	Fibocom
Model Name	FM350-GL
FCC ID	ZMOFM350GL
EUT supports Radios application	WCDMA/LTE/5G NR/GNSS
IMEI Code	Conducted: 862146050001310 Radiation: 882146050002276
HW Version	V1.0.6
SW Version	81600.0000.00.09.03.03
EUT Stage	Identical Prototype

Remark: The above EUT's information was declared by manufacturer. Please refer to the specifications or user's manual for more detailed description

1.4 Product Specification of Equipment Under Test

Standards-related Product Specification	
Tx Frequency	5G NR n2: 1850 MHz ~ 1910 MHz 5G NR n5: 824 MHz ~ 849 MHz 5G NR n25: 1850 MHz ~ 1915 MHz 5G NR n66: 1710 MHz ~ 1780 MHz
Rx Frequency	5G NR n2: 1930 MHz ~ 1990 MHz 5G NR n5: 869 MHz ~ 894 MHz 5G NR n25: 1930 MHz ~ 1995 MHz 5G NR n66: 2110 MHz~ 2200 MHz
Bandwidth	n2, n5, n25: 5MHz / 10MHz / 15MHz / 20MHz n66: 5MHz / 10MHz / 15MHz / 20MHz / 40MHz
SCS	n2, n5, n25, n66: 15KHz/30KHz
NR Mode	NSA: n2/n5/n66



	SA: n2/n5/n25/n66
Antenna Gain	5G NR n2: 4.00 dBi 5G NR n5: 3.00 dB 5G NR n25: 4.00 dBi 5G NR n66: 3.00 dB
Type of Modulation	CP-OFDM: QPSK / 16QAM / 64QAM / 256QAM DFT-s-OFDM: PI/2 BPSK / QPSK / 16QAM / 64QAM / 256QAM

1.5 Modification of EUT

No modifications are made to the EUT during all test items.

1.6 Maximum Conducted Power, Frequency Tolerance, and Emission Designator

NSA:

5G NR n2 (EN DC_5A-n2A)		PI/2 BPSK / QPSK		16QAM / 64QAM / 256QAM	
BW (MHz)	Frequency Range (MHz)	Emission Designator (99%OBW)	Conducted Power(W)	Emission Designator (99%OBW)	Conducted Power(W)
5	1852.5 ~ 1907.5	4M48G7D	0.2307	4M50W7D	0.1809
10	1855.0 ~ 1905.0	9M27G7D	0.2285	9M29W7D	0.1784
15	1857.5 ~ 1902.5	14M2G7D	0.2327	14M2W7D	0.1812
20	1860.0 ~ 1900.0	19M0G7D	0.2316	19M0W7D	0.1986
Frequency Tolerance (ppm)			0.0031		

5G NR n66 (EN DC_48A-n66A)		PI/2 BPSK / QPSK		16QAM / 64QAM / 256QAM	
BW (MHz)	Frequency Range (MHz)	Emission Designator (99%OBW)	Conducted Power(W)	Emission Designator (99%OBW)	Conducted Power(W)
5	1712.5 ~ 1777.5	4M49G7D	0.2191	4M48W7D	0.1642
10	1715.0 ~ 1775.0	9M31G7D	0.2176	9M31W7D	0.1611
15	1717.5 ~ 1772.5	14M2G7D	0.2221	14M2W7D	0.1634
20	1720.0 ~ 1770.0	19M0G7D	0.2171	19M0W7D	0.1634
40	1730.0 ~ 1760.0	38M7G7D	0.2036	38M9W7D	0.1572
Frequency Tolerance (ppm)			0.0031		



SA:

5G NR n5		PI/2 BPSK / QPSK		16QAM / 64QAM / 256QAM	
BW (MHz)	Frequency Range (MHz)	Emission Designator (99%OBW)	Conducted Power(W)	Emission Designator (99%OBW)	Conducted Power(W)
5	826.5 ~ 846.5	4M48G7D	0.2877	4M49W7D	0.2148
10	829.0 ~ 844.0	9M29G7D	0.2812	9M31W7D	0.2056
15	831.5 ~ 841.5	14M2G7D	0.2858	14M2W7D	0.2168
20	834.0 ~ 839.0	18M9G7D	0.2825	19M0W7D	0.2061
Frequency Tolerance (ppm)		0.0029			

5G NR n25		PI/2 BPSK / QPSK		16QAM / 64QAM / 256QAM	
BW (MHz)	Frequency Range (MHz)	Emission Designator (99%OBW)	Conducted Power(W)	Emission Designator (99%OBW)	Conducted Power(W)
5	1852.5 ~ 1912.5	4M49G7D	0.1897	4M49W7D	0.1560
10	1855.0 ~ 1910.0	9M25G7D	0.1875	9M31W7D	0.1574
15	1857.5 ~ 1907.5	14M1G7D	0.1897	14M1W7D	0.1578
20	1860.0 ~ 1905.0	18M9G7D	0.1892	18M9W7D	0.1560
Frequency Tolerance (ppm)		0.0025			

1.7 Testing Location

Sporton International (Shenzhen) Inc. is accredited to ISO/IEC 17025:2017 by American Association for Laboratory Accreditation with Certificate Number 5145.01.

Test Firm	Sporton International (Shenzhen) Inc.		
Test Site Location	1/F, 2/F, Bldg 5, Shiling Industrial Zone, Xinwei Village, Xili, Nanshan, Shenzhen, 518055 People's Republic of China TEL: +86-755-86379589 FAX: +86-755-86379595		
Test Site No.	Sporton Site No.	FCC Designation No.	FCC Test Firm Registration No.
	TH01-SZ	CN1256	421272

Test Firm	Sporton International (Shenzhen) Inc.		
Test Site Location	101, 1st Floor, Block B, Building 1, No. 2, Tengfeng 4th Road, Fenghuang Community, Fuyong Street, Baoan District, Shenzhen City Guangdong Province China 518103 TEL: +86-755-33202398		
Test Site No.	Sporton Site No.	FCC Designation No.	FCC Test Firm Registration No.
	03CH03-SZ	CN1256	421272



1.8 Test Software

Item	Site	Manufacturer	Name	Version
1.	03CH03-SZ	AUDIX	E3	6.2009-8-24

1.9 Applicable Standards

According to the specifications of the manufacturer, the EUT must comply with the requirements of the following standards:

- ♦ 47 CFR Part 2, 22(H), 24(E), 27(L)
- ♦ ANSI C63.26-2015
- ♦ FCC KDB 971168 D01 Power Meas License Digital Systems v03r01
- ♦ FCC KDB 412172 D01 Determining ERP and EIRP v01r01

Remark:

All test items were verified and recorded according to the standards and without any deviation during the test.



2 Test Configuration of Equipment Under Test

2.1 Test Mode

Antenna port conducted and radiated test items are performed according to KDB 971168 D01 Power Meas License Digital Systems v03r01 with maximum output power.

For radiated measurement, pre-scanned in three orthogonal panels, X, Y, Z. The worst cases were recorded in this report.

The device is investigated from 30MHz to 10 times of fundamental signal for radiated spurious emission test under different RB size/offset and modulations in exploratory test. Subsequently, only the worst case emissions are reported.

Orthogonal Planes of EUT	X Plane	Y Plane	Z Plane
			

Test Items	5G NR	Bandwidth (MHz)						Modulation					RB #			Test Channel		
		5	10	15	20	40	100	PI/2 BPSK	QPSK	16QAM	64QAM	256QAM	1	Half	Full	L	M	H
Max. Output Power	n2	v	v	v	v	-	-	v	v	v	v	v	v		v	v	v	v
	n5	v	v	v	v	-	-	v	v	v	v	v	v		v	v	v	v
	n25	v	v	v	v	-	-	v	v	v	v	v	v		v	v	v	v
	n66	v	v	v	v	v	-		v	v	v	v	v		v	v	v	v
Peak-to-Average Ratio	n2				v	-	-	v	v					v		v	v	v
	n5				v	-	-	v	v					v		v	v	v
	n25				v	-	-	v	v					v		v	v	v
	n66	v					-	v	v					v		v	v	v
26dB Bandwidth	n2	v	v	v	v	-	-		v	v	v	v			v		v	
	n5	v	v	v	v	-	-		v	v	v	v			v		v	
	n25	v	v	v	v	-	-		v	v	v	v			v		v	
	n66	v	v	v	v	v	-		v	v	v	v			v		v	
99% Bandwidth	n2	v	v	v	v	-	-		v	v	v	v			v		v	
	n5	v	v	v	v	-	-		v	v	v	v			v		v	
	n25	v	v	v	v	-	-		v	v	v	v			v		v	
	n66	v	v	v	v	v	-		v	v	v	v			v		v	



Test Items	Band	Bandwidth (MHz)						Modulation					RB #			Test Channel		
		5	10	15	20	40	100	PI/2 BPSK	QPSK	16QAM	64QAM	256QAM	1	Half	Full	L	M	H
Conducted Band Edge	n2	v	v		v	-	-	v	v				v		v	v		v
	n5	v	v		v	-	-	v	v				v		v	v		v
	n25	v	v		v	-	-	v	v				v		v	v		v
	n66	v		v		v	-	v	v				v		v	v		v
Conducted Spurious Emission	n2	v	v		v	-	-	v	v				v			v	v	v
	n5	v	v		v	-	-	v	v				v			v	v	v
	n25	v	v		v	-	-	v	v				v			v	v	v
	n66	v		v		v	-	v	v				v			v	v	v
Frequency Stability	n2				v	-	-	v							v		v	
	n5				v	-	-	v							v		v	
	n25				v	-	-	v							v		v	
	n66				v	-	-	v							v		v	
E.R.P / E.I.R.P	n2	v	v	v	v	-	-	v	v	v	v	v	v		v	v	v	v
	n5	v	v	v	v	-	-	v	v	v	v	v	v		v	v	v	v
	n25	v	v	v	v	-	-	v	v	v	v	v	v		v	v	v	v
	n66	v	v	v	v	v	-	v	v	v	v	v	v		v	v	v	v
Radiated Spurious Emission	n2	Worst Case													v	v	v	
	n5	Worst Case													v	v	v	
	n25	Worst Case													v	v	v	
	n66	Worst Case													v	v	v	
Note	<ol style="list-style-type: none"> The mark "v " means that this configuration is chosen for testing The mark "- " means that this bandwidth is not supported. The device is investigated from 30MHz to 10 times of fundamental signal for radiated spurious emission test under different RB size/offset and modulations in exploratory test. Subsequently, only the worst case emissions are reported. 5G NR supports SCS 15KHz and 30KHz, according to engineering evaluation, only choose the SCS 15KHz (the highest conducted power) perform for all tests. 5G NR supports SA and NSA mode (refer to the Operation Description). For NSA mode, according to engineering evaluation, only the worst EN-DC combination mode show in the report. Based on engineering evaluation, only the worst modulation test results are shown in the report. 																	

2.2 Connection Diagram of Test System

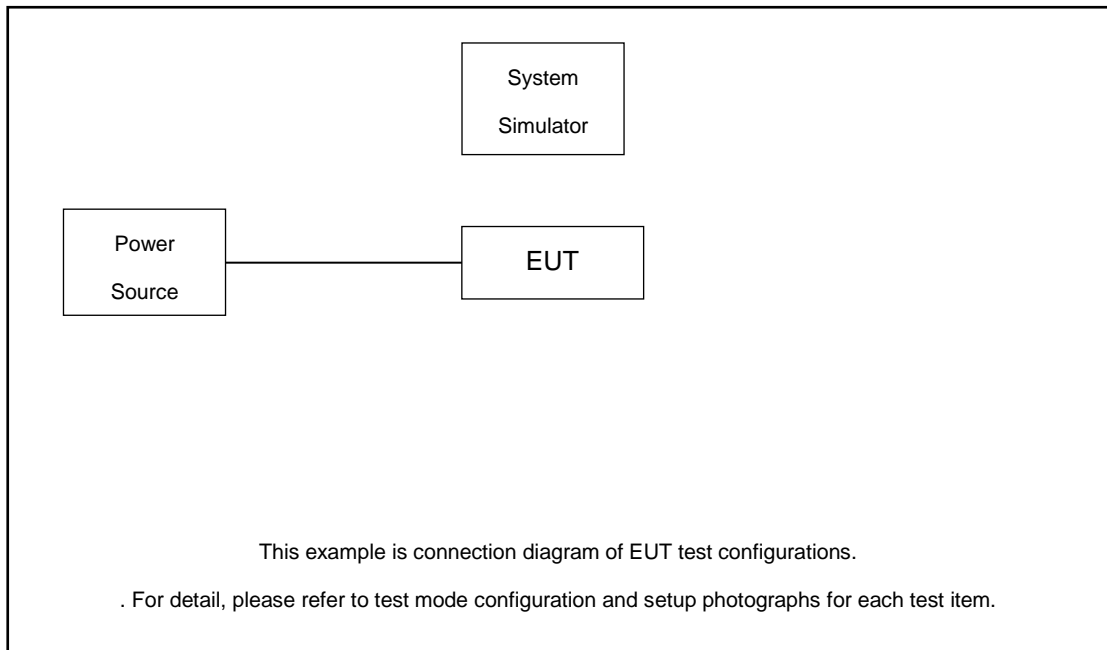

2.3 Support Unit used in test configuration and system

Item	Equipment	Trade Name	Model No.	FCC ID	Data Cable	Power Cord
1.	DC Power Supply	GW	GPS-3030D	N/A	N/A	Unshielded, 1.8 m
2.	Base Station	Keysight	UXM E7515B	Fcc DoC	N/A	Unshielded, 1.5 m
3.	Test Jig	N/A	N/A	N/A	N/A	N/A

2.4 Measurement Results Explanation Example

For all conducted test items:

The offset level is set in the spectrum analyzer to compensate the RF cable loss between EUT conducted output port and spectrum analyzer. With the offset compensation, the spectrum analyzer reading level is exactly the EUT RF output level.

The spectrum analyzer offset is derived from RF cable loss.

Offset = RF cable loss.

Following shows an offset computation example with cable loss 3.90 dB.

Example :

$$\begin{aligned} \text{Offset(dB)} &= \text{RF cable loss(dB)}. \\ &= 3.90 \text{ (dB)} \end{aligned}$$



2.5 Frequency List of Low/Middle/High Channels

5G NR n2 Channel and Frequency List				
BW [MHz]	Channel/Frequency(MHz)	Lowest	Middle	Highest
20	Channel	372000	376000	380000
	Frequency	1860	1880	1900
15	Channel	371500	376000	380500
	Frequency	1857.5	1880	1902.5
10	Channel	371000	376000	381000
	Frequency	1855	1880	1905
5	Channel	370500	376000	381500
	Frequency	1852.5	1880	1907.5

5G NR n5 Channel and Frequency List				
BW [MHz]	Channel/Frequency(MHz)	Lowest	Middle	Highest
20	Channel	166800	167300	167800
	Frequency	834	836.5	839
15	Channel	166300	167300	168300
	Frequency	831.5	836.5	841.5
10	Channel	165800	167300	168800
	Frequency	829	836.5	844
5	Channel	165300	167300	169300
	Frequency	826.5	836.5	846.5

5G NR n25 Channel and Frequency List				
BW [MHz]	Channel/Frequency(MHz)	Lowest	Middle	Highest
20	Channel	372000	376500	381000
	Frequency	1860	1882.5	1905
15	Channel	371500	376500	381500
	Frequency	1857.5	1882.5	1907.5
10	Channel	371000	376500	382000
	Frequency	1855	1882.5	1910
5	Channel	370500	376500	382500
	Frequency	1852.5	1882.5	1912.5



5G NR n66 Channel and Frequency List				
BW [MHz]	Channel/Frequency(MHz)	Lowest	Middle	Highest
40	Channel	346000	349000	352000
	Frequency	1730	1745	1760
20	Channel	344000	349000	354000
	Frequency	1720	1745	1770
15	Channel	343500	349000	354500
	Frequency	1717.5	1745	1772.5
10	Channel	343000	349000	355000
	Frequency	1715	1745	1775
5	Channel	342500	349000	355500
	Frequency	1712.5	1745	1777.5

3 Conducted Test Items

3.1 Measuring Instruments

See list of measuring instruments of this test report.

3.2 Test Setup

3.2.1 Conducted Output Power



3.2.2 Peak-to-Average Ratio, Occupied Bandwidth ,Conducted Band-Edge and Conducted Spurious Emission

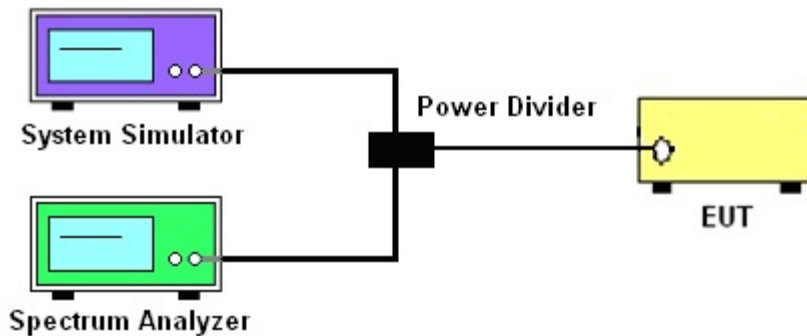

3.2.3 Frequency Stability

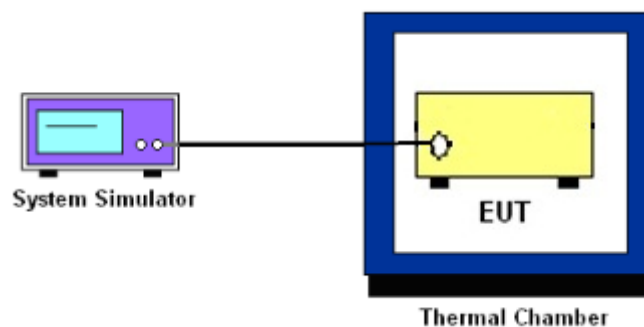

3.3 Test Result of Conducted Test

Please refer to Appendix A.



3.4 Conducted Output Power and ERP/EIRP

3.4.1 Description of the Conducted Output Power Measurement and ERP/EIRP Measurement

A system simulator was used to establish communication with the EUT. Its parameters were set to force the EUT transmitting at maximum output power. The measured power in the radio frequency on the transmitter output terminals shall be reported.

The ERP of mobile transmitters must not exceed 7 Watts for 5G NR n5.

The EIRP of mobile transmitters must not exceed 2 Watts for 5G NR n2 and n25.

The EIRP of mobile transmitters must not exceed 1 Watts for 5G NR n66.

According to KDB 412172 D01 Power Approach,

$EIRP = P_T + G_T - L_C$, $ERP = EIRP - 2.15$, where

P_T = transmitter output power in dBm

G_T = gain of the transmitting antenna in dBi

L_C = signal attenuation in the connecting cable between the transmitter and antenna in dB

3.4.2 Test Procedures

1. The testing follows ANSI C63.26 Section 5.2
2. The transmitter output port was connected to the system simulator.
3. Set EUT at maximum power through the system simulator.
4. Select lowest, middle, and highest channels for each band and different modulation.
5. Measure and record the power level from the system simulator.



3.5 Peak-to-Average Ratio

3.5.1 Description of the PAR Measurement

Power Complementary Cumulative Distribution Function (CCDF) curves provide a means for characterizing the power peaks of a digitally modulated signal on a statistical basis. A CCDF curve depicts the probability of the peak signal amplitude exceeding the average power level. Most contemporary measurement instrumentation include the capability to produce CCDF curves for an input signal provided that the instrument's resolution bandwidth can be set wide enough to accommodate the entire input signal bandwidth. In measuring transmissions in this band using an average power technique, the peak-to-average ratio (PAR) of the transmission may not exceed 13 dB.

3.5.2 Test Procedures

1. The testing follows ANSI C63.26 Section 5.2.3.4 (CCDF).
2. The EUT was connected to spectrum and system simulator via a power divider.
3. Set the CCDF (Complementary Cumulative Distribution Function) option in spectrum analyzer.
4. The highest RF powers were measured and recorded the maximum PAPR level associated with a probability of 0.1 %.
5. Record the deviation as Peak to Average Ratio.



3.6 Occupied Bandwidth

3.6.1 Description of Occupied Bandwidth Measurement

The occupied bandwidth is the width of a frequency band such that, below the lower and above the upper frequency limits, the mean powers emitted are each equal to a specified percentage 0.5% of the total mean transmitted power.

The 26 dB emission bandwidth is defined as the frequency range between two points, one above and one below the carrier frequency, at which the spectral density of the emission is attenuated 26 dB below the maximum in-band spectral density of the modulated signal. Spectral density (power per unit bandwidth) is to be measured with a detector of resolution bandwidth equal to approximately 1.0% of the emission bandwidth.

3.6.2 Test Procedures

1. The testing follows ANSI C63.26 Section 5.4
2. The EUT was connected to spectrum analyzer and system simulator via a power divider.
3. The spectrum analyzer center frequency is set to the nominal EUT channel center frequency. The span range for the spectrum analyzer shall be between two and five times the anticipated OBW.
4. The nominal resolution bandwidth (RBW) shall be in the range of 1 to 5 % of the anticipated OBW, and the VBW shall be at least 3 times the RBW.
5. Set the detection mode to peak, and the trace mode to max hold.
6. Determine the reference value: Set the EUT to transmit a modulated signal. Allow the trace to stabilize. Set the spectrum analyzer marker to the highest level of the displayed trace.
(this is the reference value)
7. Determine the “-26 dB down amplitude” as equal to (Reference Value – X).
8. Place two markers, one at the lowest and the other at the highest frequency of the envelope of the spectral display such that each marker is at or slightly below the “-X dB down amplitude” determined in step 6. If a marker is below this “-X dB down amplitude” value it shall be placed as close as possible to this value. The OBW is the positive frequency difference between the two markers.
9. Use the 99 % power bandwidth function of the spectrum analyzer and report the measured bandwidth.



3.7 Conducted Band Edge

3.7.1 Description of Conducted Band Edge Measurement

22.917(a)

For operations in the 824 – 849 MHz band, the FCC limit is $43 + 10\log_{10}(P[\text{Watts}])$ dB below the transmitter power P(Watts) in a 100kHz bandwidth. However, in the 1MHz bands immediately outside and adjacent to the licensee's frequency block, a resolution bandwidth of at least one percent of the emission bandwidth of the fundamental emission of the transmitter may be employed.

24.238 (a)

For operations in the 1850-1910 and 1930-1990 MHz band, the FCC limit is $43 + 10\log_{10}(P[\text{Watts}])$ dB below the transmitter power P(Watts) in a 1MHz bandwidth. However, in the 1 MHz bands immediately outside and adjacent to the frequency block a resolution bandwidth of at least one percent of the emission bandwidth of the fundamental emission of the transmitter may be employed.

27.53 (h)

For operations in the 1710 – 1755 MHz band, the FCC limit is $43 + 10\log_{10}(P[\text{Watts}])$ dB below the transmitter power P(Watts) in a 1 MHz bandwidth. However, in the 1MHz bands immediately outside and adjacent to the licensee's frequency block, a resolution bandwidth of at least one percent of the emission bandwidth of the fundamental emission of the transmitter may be employed.

3.7.2 Test Procedures

1. The testing follows ANSI C63.26 section 5.7
2. The EUT was connected to spectrum analyzer and system simulator via a power divider.
3. The band edges of low and high channels for the highest RF powers were measured.
4. Set RBW \geq 1% EBW in the 1MHz band immediately outside and adjacent to the band edge.
5. Beyond the 1 MHz band from the band edge, RBW=1MHz was used.
6. Set spectrum analyzer with RMS detector.
7. The RF fundamental frequency should be excluded against the limit line in the operating frequency band.
8. Checked that all the results comply with the emission limit line.

Example:

$$\begin{aligned} &\text{The limit line is derived from } 43 + 10\log(P)\text{dB below the transmitter power P(Watts)} \\ &= P(W) - [43 + 10\log(P)] \text{ (dB)} \\ &= [30 + 10\log(P)] \text{ (dBm)} - [43 + 10\log(P)] \text{ (dB)} = -13\text{dBm}. \end{aligned}$$



3.8 Conducted Spurious Emission

3.8.1 Description of Conducted Spurious Emission Measurement

The power of any emission outside of the authorized operating frequency ranges must be lower than the transmitter power (P) by a factor of at least $43 + 10 \log (P)$ dB.

It is measured by means of a calibrated spectrum analyzer and scanned from 30 MHz up to a frequency including its 10th harmonic.

3.8.2 Test Procedures

1. The testing follows ANSI C63.26 section 5.7
2. The EUT was connected to spectrum analyzer and system simulator via a power divider.
3. The RF output of EUT was connected to the spectrum analyzer by RF cable and attenuator. The path loss was compensated to the results for each measurement.
4. The middle channel for the highest RF power within the transmitting frequency was measured.
5. The conducted spurious emission for the whole frequency range was taken.
6. Make the measurement with the spectrum analyzer's RBW = 1MHz, VBW = 3MHz.
7. Set spectrum analyzer with RMS detector.
8. Taking the record of maximum spurious emission.
9. The RF fundamental frequency should be excluded against the limit line in the operating frequency band.
10. The limit line is derived from $43 + 10\log(P)$ dB below the transmitter power P(Watts)
= P(W)- [43 + 10log(P)] (dB)
= [30 + 10log(P)] (dBm) - [43 + 10log(P)] (dB)
= -13dBm.



3.9 Frequency Stability

3.9.1 Description of Frequency Stability Measurement

The frequency stability shall be measured by variation of ambient temperature and variation of primary supply voltage to ensure that the fundamental emission stays within the authorized frequency block. The frequency stability of the transmitter shall be maintained within $\pm 0.00025\%$ ($\pm 2.5\text{ppm}$) of the center frequency.

3.9.2 Test Procedures for Temperature Variation

1. The testing follows ANSI C63.26 section 5.6.4
2. The EUT was set up in the thermal chamber and connected with the system simulator.
3. With power OFF, the temperature was decreased to -30°C and the EUT was stabilized before testing. Power was applied and the maximum change in frequency was recorded within one minute.
4. With power OFF, the temperature was raised in 10°C step up to 50°C . The EUT was stabilized at each step for at least half an hour. Power was applied and the maximum frequency change was recorded within one minute.

3.9.3 Test Procedures for Voltage Variation

1. The testing follows ANSI C63.26 section 5.6.5
2. The EUT was placed in a temperature chamber at $20\pm 5^{\circ}\text{C}$ and connected with the system simulator.
3. The power supply voltage to the EUT was varied from 85% to 115% of the nominal value for other than hand carried battery equipment.
4. For hand carried, battery powered equipment, reduce the primary ac or dc supply voltage to the battery operating end point, which shall be specified by the manufacturer.
5. The variation in frequency was measured for the worst case.

4 Radiated Test Items

4.1 Measuring Instruments

See list of measuring instruments of this test report.

4.2 Test Setup

4.2.1 For radiated test from 30MHz to 1GHz

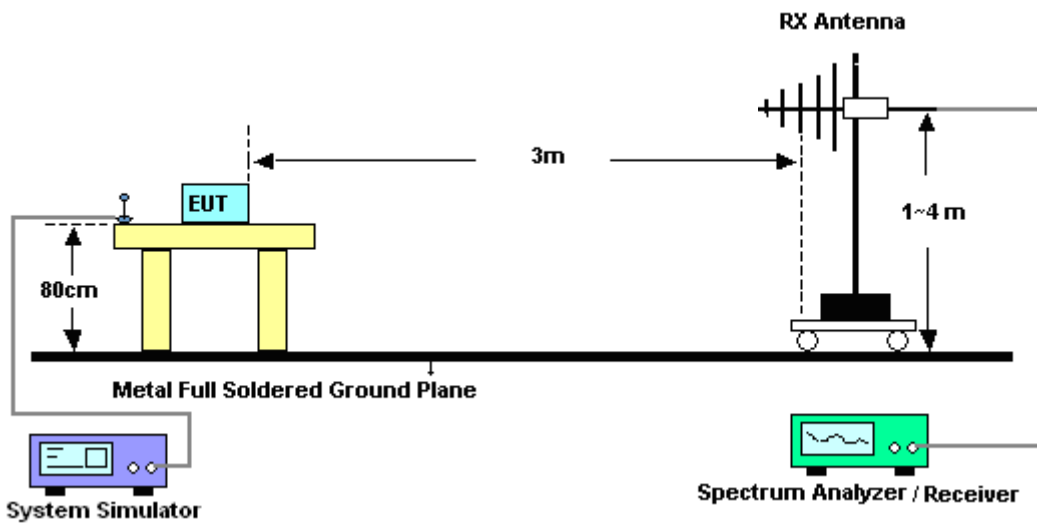

4.2.2 For radiated test above 1GHz

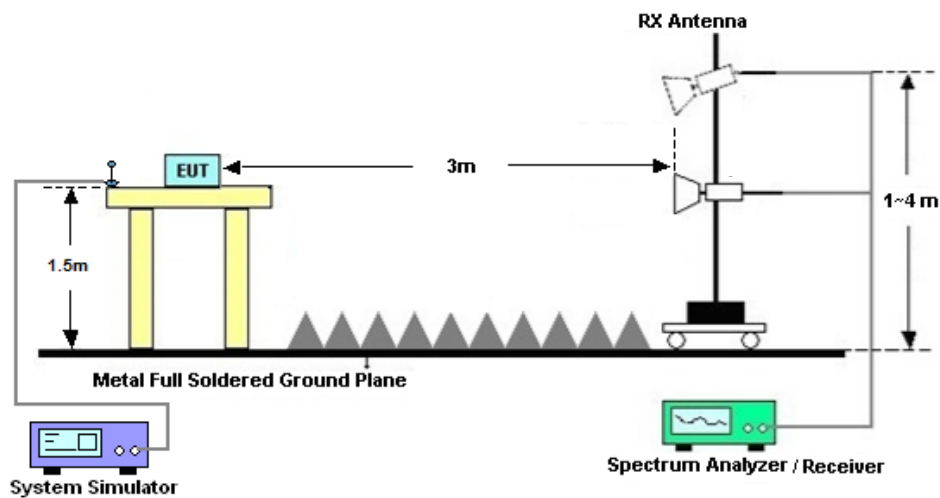

4.3 Test Result of Radiated Test

Please refer to Appendix B.



4.4 Radiated Spurious Emission

4.4.1 Description of Radiated Spurious Emission

The radiated spurious emission was measured by substitution method according to ANSI C63.26. The power of any emission outside of the authorized operating frequency ranges must be attenuated below the transmitter power (P) by a factor of at least $43 + 10 \log (P)$ dB.

The spectrum is scanned from 30 MHz up to a frequency including its 10th harmonic.

4.4.2 Test Procedures

1. The testing follows ANSI C63.26 Section 5.5
2. The EUT was placed on a turntable with 0.8 meter height for frequency below 1GHz and 1.5 meter height for frequency above 1GHz respectively above ground.
3. The EUT was set 3 meters from the receiving antenna mounted on the antenna tower.
4. The table was rotated 360 degrees to determine the position of the highest spurious emission.
5. The height of the receiving antenna is varied between 1m to 4m to search the maximum spurious emission for both horizontal and vertical polarizations.
6. During the measurement, the system simulator parameters were set to force the EUT transmitting at maximum output power.
7. Make the measurement with the spectrum analyzer's RBW = 1MHz, VBW = 3MHz, taking the record of maximum spurious emission.
8. A horn antenna was substituted in place of the EUT and was driven by a signal generator.
9. Tune the output power of signal generator to the same emission level with EUT maximum spurious emission.
10. $EIRP (dBm) = S.G. Power - Tx Cable Loss + Tx Antenna Gain$
11. $ERP (dBm) = EIRP - 2.15$
12. The RF fundamental frequency should be excluded against the limit line in the operating frequency band.

The limit line is derived from $43 + 10\log(P)$ dB below the transmitter power P(Watts)
 $= P(W) - [43 + 10\log(P)] (dB)$
 $= [30 + 10\log(P)] (dBm) - [43 + 10\log(P)] (dB)$
 $= -13dBm.$



5 List of Measuring Equipment

Instrument	Manufacturer	Model No.	Serial No.	Characteristics	Calibration Date	Test Date	Due Date	Remark
Spectrum Analyzer	R&S	FSV40	101078	10Hz~40GHz	Apr. 17, 2020	Jan. 11, 2021~Jan. 16, 2021	Apr. 16, 2021	Conducted (TH01-SZ)
Thermal Chamber	Ten Billion Hongzhangroup	LP-150U	H2014081803	-40~+150°C	Jul. 22, 2020	Jan. 11, 2021~Jan. 16, 2021	Jul. 21, 2021	Conducted (TH01-SZ)
EMI Test Receiver&SA	KEYSIGHT	N9038A	MY54450083	20Hz~8.4GHz	Apr. 17, 2020	Jan. 27, 2021~Mar. 07, 2021	Apr. 16, 2021	Radiation (03CH03-SZ)
EXA Spectrum Analyzer	KEYSIGHT	N9010A	MY55150246	10Hz~44GHz;	Apr. 17, 2020	Jan. 27, 2021~Mar. 07, 2021	Apr. 16, 2021	Radiation (03CH03-SZ)
Bilog Antenna	TeseQ	CBL6112D	35408	30MHz-2GHz	Jun. 22, 2020	Jan. 27, 2021~Mar. 07, 2021	Jun. 21, 2021	Radiation (03CH03-SZ)
Double Ridge Horn Antenna	SCHWARZBECK	BBHA9120D	9120D-1355	1GHz~18GHz	Apr. 30, 2020	Jan. 27, 2021~Mar. 07, 2021	Apr. 29, 2021	Radiation (03CH03-SZ)
Amplifier	Burgeon	BPA-530	102210	0.01Hz ~3000MHz	Oct. 17, 2019	Jan. 27, 2021~Mar. 07, 2021	Oct. 16, 2021	Radiation (03CH03-SZ)
HF Amplifier	MITEQ	TTA1840-35-HG	1871923	18GHz~40GHz	Jul. 21, 2020	Jan. 27, 2021~Mar. 07, 2021	Jul. 20, 2021	Radiation (03CH03-SZ)
SHF-EHF Horn	com-power	AH-840	101071	18Ghz-40GHz	Apr. 23, 2020	Jan. 27, 2021~Mar. 07, 2021	Apr. 22, 2021	Radiation (03CH03-SZ)
Amplifier	Agilent Technologies	83017A	MY39501302	500MHz~26.5GHz	Dec. 25, 2020	Jan. 27, 2021~Mar. 07, 2021	Dec. 24, 2021	Radiation (03CH03-SZ)
AC Power Source	Chroma	61601	616010001985	N/A	NCR	Jan. 27, 2021~Mar. 07, 2021	NCR	Radiation (03CH03-SZ)
Turn Table	EM	EM1000	N/A	0~360 degree	NCR	Jan. 27, 2021~Mar. 07, 2021	NCR	Radiation (03CH03-SZ)
Antenna Mast	EM	EM1000	N/A	1 m~4 m	NCR	Jan. 27, 2021~Mar. 07, 2021	NCR	Radiation (03CH03-SZ)

NCR: No Calibration Required



6 Uncertainty of Evaluation

The measurement uncertainties shown below were calculated in accordance with the requirements of ANSI 63.26-2015. All the measurement uncertainty value were shown with a coverage K=2 to indicate 95% level of confidence. The measurement data show herein meets or exceeds the CISPR measurement uncertainty values specified in CISPR 16-4-2 and can be compared directly to specified limit to determine compliance.

Uncertainty of Radiated Emission Measurement (30 MHz ~ 1000 MHz)

Measuring Uncertainty for a Level of Confidence of 95% (U = 2Uc(y))	3.0dB
---	-------

Uncertainty of Radiated Emission Measurement (1 GHz ~ 18 GHz)

Measuring Uncertainty for a Level of Confidence of 95% (U = 2Uc(y))	3.6dB
---	-------

Uncertainty of Radiated Emission Measurement (18 GHz ~ 40 GHz)

Measuring Uncertainty for a Level of Confidence of 95% (U = 2Uc(y))	3.8dB
---	-------



Appendix A. Test Results of Conducted Test

Conducted Output Power(Average power and EIRP)

EN-DC n2 (ANT M2)+5A (ANT M)Combination 20MHz+10MHz(LTE)(GT - LC = 4 dB)									
Channel	Mode	NR		LTE		Conducted		EIRP	
		RB		RB		Power(dBm)	Power(Watts)	EIRP(dBm)	EIRP(W)
		Size	Offset	Size	Offset				
Lowest	Pi/2 BPSK DFT-s-OFDM	1	1	1	0	23.24	0.2108	27.24	0.5296
		1	104	1	49	23.49	0.2233	27.49	0.5608
		50	25	50	0	23.43	0.2202	27.43	0.5532
	QPSK DFT-s-OFDM	1	1	1	0	23.43	0.2202	27.43	0.5531
		1	104	1	49	23.54	0.2259	27.54	0.5673
		50	25	50	0	23.50	0.2238	27.50	0.5621
	16QAM DFT-s-OFDM	1	1	1	0	22.57	0.1808	26.57	0.4541
		1	104	1	49	22.55	0.1799	26.55	0.452
		50	25	50	0	22.36	0.1723	26.36	0.4328
	64QAM DFT-s-OFDM	1	1	1	0	21.17	0.1309	25.17	0.3289
		1	104	1	49	21.14	0.13	25.14	0.3266
		50	25	50	0	20.86	0.122	24.86	0.3064
	256QAM DFT-s-OFDM	1	1	1	0	18.74	0.0749	22.74	0.188
		1	104	1	49	18.76	0.0752	22.76	0.1888
		50	25	50	0	18.88	0.0773	22.88	0.1941
Middle	Pi/2 BPSK DFT-s-OFDM	1	1	1	0	23.61	0.2295	27.61	0.5764
		1	104	1	49	23.48	0.2227	27.48	0.5595
		50	25	50	0	23.56	0.2269	27.56	0.5699
	QPSK DFT-s-OFDM	1	1	1	0	23.59	0.2284	27.59	0.5737
		1	104	1	49	23.58	0.2279	27.58	0.5725
		50	25	50	0	23.65	0.2316	27.65	0.5818
	16QAM DFT-s-OFDM	1	1	1	0	22.35	0.1719	26.35	0.4318
		1	104	1	49	22.57	0.1808	26.57	0.4542
		50	25	50	0	22.55	0.18	26.55	0.4521
	64QAM DFT-s-OFDM	1	1	1	0	20.94	0.1242	24.94	0.312
		1	104	1	49	20.95	0.1245	24.95	0.3127
		50	25	50	0	20.91	0.1234	24.91	0.3098
	256QAM DFT-s-OFDM	1	1	1	0	18.70	0.0742	22.70	0.1864
		1	104	1	49	18.89	0.0775	22.89	0.1946
		50	25	50	0	18.88	0.0773	22.88	0.1941
QPSK CP-OFDM	1	1	1	0	21.78	0.1505	25.78	0.3782	
	1	104	1	49	21.90	0.1547	25.90	0.3887	
	53	26	50	0	21.94	0.1561	25.94	0.3922	
Highest	Pi/2 BPSK DFT-s-OFDM	1	1	1	0	23.48	0.2228	27.48	0.5596
		1	104	1	49	23.31	0.2142	27.31	0.5381
		50	25	50	0	23.54	0.2258	27.54	0.5672
	QPSK DFT-s-OFDM	1	1	1	0	23.51	0.2243	27.51	0.5634
		1	104	1	49	23.46	0.2217	27.46	0.5569
		50	25	50	0	23.54	0.2258	27.54	0.5672
	16QAM DFT-s-OFDM	1	1	1	0	22.58	0.1812	26.58	0.4552
		1	104	1	49	22.98	0.1986	26.98	0.4989
		50	25	50	0	22.49	0.1775	26.49	0.4459
	64QAM DFT-s-OFDM	1	1	1	0	21.18	0.1312	25.18	0.3296
		1	104	1	49	21.15	0.1303	25.15	0.3273
		50	25	50	0	21.09	0.1285	25.09	0.3229
	256QAM DFT-s-OFDM	1	1	1	0	18.76	0.0752	22.76	0.1889
		1	104	1	49	18.93	0.0782	22.93	0.1963
		50	25	50	0	19.00	0.0794	23.00	0.1995

EN-DC n2 (ANT M2)+5A (ANT M)Combination 15MHz+10MHz(LTE)(GT - LC = 4 dB)									
Channel	Mode	NR		LTE		Conducted		EIRP	
		RB		RB		Power(dBm)	Power(Watts)	EIRP(dBm)	EIRP(W)
		Size	Offset	Size	Offset				
Lowest	Pi/2 BPSK DFT-s-OFDM	1	1	1	0	23.38	0.2177	27.38	0.5469
		1	77	1	49	23.49	0.2233	27.49	0.5608
		36	18	50	0	23.41	0.2192	27.41	0.5506
	QPSK DFT-s-OFDM	1	1	1	0	23.43	0.2202	27.43	0.5532
		1	77	1	49	23.47	0.2222	27.47	0.5583
		36	18	50	0	23.44	0.2207	27.44	0.5544
	16QAM DFT-s-OFDM	1	1	1	0	22.51	0.1783	26.51	0.4479
		1	77	1	49	22.43	0.1751	26.43	0.4399
		36	18	50	0	22.33	0.1711	26.33	0.4299
	64QAM DFT-s-OFDM	1	1	1	0	21.08	0.1283	25.08	0.3222
		1	77	1	49	21.07	0.1279	25.07	0.3214
		36	18	50	0	20.88	0.1225	24.88	0.3077
	256QAM DFT-s-OFDM	1	1	1	0	18.67	0.0737	22.67	0.1851
		1	77	1	49	18.68	0.0738	22.68	0.1855
		36	18	50	0	18.88	0.0773	22.88	0.1941
Middle	Pi/2 BPSK DFT-s-OFDM	1	1	1	0	23.56	0.2269	27.56	0.5699
		1	77	1	49	23.54	0.2259	27.54	0.5673
		36	18	50	0	23.60	0.229	27.60	0.5752
	QPSK DFT-s-OFDM	1	1	1	0	23.64	0.2311	27.64	0.5804
		1	77	1	49	23.67	0.2327	27.67	0.5844
		36	18	50	0	23.65	0.2316	27.65	0.5818
	16QAM DFT-s-OFDM	1	1	1	0	22.41	0.1743	26.41	0.4377
		1	77	1	49	22.54	0.1796	26.54	0.451
		36	18	50	0	22.30	0.1699	26.30	0.4269
	64QAM DFT-s-OFDM	1	1	1	0	20.95	0.1245	24.95	0.3127
		1	77	1	49	21.12	0.1295	25.12	0.3252
		36	18	50	0	20.86	0.122	24.86	0.3065
	256QAM DFT-s-OFDM	1	1	1	0	18.71	0.0742	22.71	0.1864
		1	77	1	49	18.78	0.0756	22.78	0.1898
		36	18	50	0	18.92	0.078	22.92	0.196
	QPSK CP-OFDM	1	1	1	0	21.80	0.1512	25.80	0.3799
		1	77	1	49	21.86	0.1536	25.86	0.3859
		39	19	50	0	21.86	0.1533	25.86	0.3851
Highest	Pi/2 BPSK DFT-s-OFDM	1	1	1	0	23.48	0.2228	27.48	0.5596
		1	77	1	49	23.47	0.2223	27.47	0.5583
		36	18	50	0	23.49	0.2233	27.49	0.5609
	QPSK DFT-s-OFDM	1	1	1	0	23.43	0.2202	27.43	0.5532
		1	77	1	49	23.42	0.2197	27.42	0.5519
		36	18	50	0	23.46	0.2217	27.46	0.557
	16QAM DFT-s-OFDM	1	1	1	0	22.44	0.1755	26.44	0.4409
		1	77	1	49	22.58	0.1812	26.58	0.4552
		36	18	50	0	22.34	0.1715	26.34	0.4309
	64QAM DFT-s-OFDM	1	1	1	0	21.05	0.1274	25.05	0.32
		1	77	1	49	21.12	0.1294	25.12	0.3251
		36	18	50	0	20.89	0.1228	24.89	0.3085
	256QAM DFT-s-OFDM	1	1	1	0	18.67	0.0736	22.67	0.1848
		1	77	1	49	18.87	0.0772	22.87	0.1938
		36	18	50	0	18.88	0.0773	22.88	0.1943

EN-DC n2 (ANT M2)+5A (ANT M)Combination 10MHz+10MHz(LTE)(GT - LC = 4 dB)									
Channel	Mode	NR		LTE		Conducted		EIRP	
		RB		RB		Power(dBm)	Power(Watts)	EIRP(dBm)	EIRP(W)
		Size	Offset	Size	Offset				
Lowest	Pi/2 BPSK DFT-s-OFDM	1	1	1	0	23.30	0.2137	27.30	0.5369
		1	50	1	49	23.40	0.2187	27.40	0.5493
		25	12	50	0	23.29	0.2132	27.29	0.5356
	QPSK DFT-s-OFDM	1	1	1	0	23.32	0.2147	27.32	0.5393
		1	50	1	49	23.38	0.2177	27.38	0.5468
		25	12	50	0	23.34	0.2157	27.34	0.5418
	16QAM DFT-s-OFDM	1	1	1	0	22.35	0.1719	26.35	0.4318
		1	50	1	49	22.33	0.1712	26.33	0.4299
		25	12	50	0	22.14	0.1635	26.14	0.4107
	64QAM DFT-s-OFDM	1	1	1	0	20.86	0.122	24.86	0.3065
		1	50	1	49	20.81	0.1206	24.81	0.303
		25	12	50	0	20.74	0.1187	24.74	0.2982
	256QAM DFT-s-OFDM	1	1	1	0	18.59	0.0722	22.59	0.1814
		1	50	1	49	18.57	0.0719	22.57	0.1805
		25	12	50	0	18.61	0.0726	22.61	0.1823
Middle	Pi/2 BPSK DFT-s-OFDM	1	1	1	0	23.45	0.2212	27.45	0.5557
		1	50	1	49	23.47	0.2222	27.47	0.5582
		25	12	50	0	23.49	0.2232	27.49	0.5608
	QPSK DFT-s-OFDM	1	1	1	0	23.59	0.2285	27.59	0.5739
		1	50	1	49	23.56	0.2269	27.56	0.5699
		25	12	50	0	23.44	0.2207	27.44	0.5545
	16QAM DFT-s-OFDM	1	1	1	0	22.33	0.1712	26.33	0.4299
		1	50	1	49	22.43	0.1751	26.43	0.4398
		25	12	50	0	22.12	0.1631	26.12	0.4097
	64QAM DFT-s-OFDM	1	1	1	0	20.94	0.1243	24.94	0.3121
		1	50	1	49	20.96	0.1248	24.96	0.3135
		25	12	50	0	20.59	0.1144	24.59	0.2874
	256QAM DFT-s-OFDM	1	1	1	0	18.57	0.0719	22.57	0.1805
		1	50	1	49	18.69	0.0739	22.69	0.1856
		25	12	50	0	18.60	0.0724	22.60	0.1818
	QPSK CP-OFDM	1	1	1	0	21.71	0.1482	25.71	0.3722
		1	50	1	49	21.82	0.1519	25.82	0.3816
			26	13	50	0	21.66	0.1465	25.66
Highest	Pi/2 BPSK DFT-s-OFDM	1	1	1	0	23.34	0.2157	27.34	0.5418
		1	50	1	49	23.40	0.2187	27.40	0.5494
		25	12	50	0	23.38	0.2177	27.38	0.5469
	QPSK DFT-s-OFDM	1	1	1	0	23.39	0.2182	27.39	0.5481
		1	50	1	49	23.43	0.2202	27.43	0.5531
		25	12	50	0	23.41	0.2192	27.41	0.5507
	16QAM DFT-s-OFDM	1	1	1	0	22.38	0.1731	26.38	0.4348
		1	50	1	49	22.51	0.1784	26.51	0.448
		25	12	50	0	22.18	0.1654	26.18	0.4154
	64QAM DFT-s-OFDM	1	1	1	0	20.88	0.1226	24.88	0.3079
		1	50	1	49	21.07	0.128	25.07	0.3215
		25	12	50	0	20.70	0.1176	24.70	0.2954
	256QAM DFT-s-OFDM	1	1	1	0	18.69	0.074	22.69	0.186
		1	50	1	49	18.82	0.0763	22.82	0.1916
			25	12	50	0	18.70	0.074	22.70

EN-DC n2 (ANT M2)+5A (ANT M)Combination 5MHz+10MHz(LTE)(GT - LC = 4 dB)									
Channel	Mode	NR		LTE		Conducted		EIRP	
		RB		RB		Power(dBm)	Power(Watts)	EIRP(dBm)	EIRP(W)
		Size	Offset	Size	Offset				
Lowest	Pi/2 BPSK DFT-s-OFDM	1	1	1	0	23.25	0.2115	27.25	0.5312
		1	23	1	49	23.21	0.2095	27.21	0.5263
		12	6	50	0	23.33	0.2153	27.33	0.5409
	QPSK DFT-s-OFDM	1	1	1	0	23.39	0.2183	27.39	0.5484
		1	23	1	49	23.36	0.2168	27.36	0.5447
		12	6	50	0	23.30	0.2139	27.30	0.5372
	16QAM DFT-s-OFDM	1	1	1	0	22.37	0.1724	26.37	0.4331
		1	23	1	49	22.39	0.1732	26.39	0.4351
		12	6	50	0	22.24	0.1674	26.24	0.4205
	64QAM DFT-s-OFDM	1	1	1	0	20.93	0.1239	24.93	0.3112
		1	23	1	49	20.91	0.1232	24.91	0.3095
		12	6	50	0	20.75	0.1189	24.75	0.2986
256QAM DFT-s-OFDM	1	1	1	0	18.61	0.0725	22.61	0.1822	
	1	23	1	49	18.63	0.073	22.63	0.1834	
	12	6	50	0	18.79	0.0757	22.79	0.1903	
Middle	Pi/2 BPSK DFT-s-OFDM	1	1	1	0	23.50	0.2239	27.50	0.5624
		1	23	1	49	23.49	0.2234	27.49	0.5611
		12	6	50	0	23.58	0.228	27.58	0.5728
	QPSK DFT-s-OFDM	1	1	1	0	23.60	0.2291	27.60	0.5755
		1	23	1	49	23.57	0.2275	27.57	0.5714
		12	6	50	0	23.63	0.2307	27.63	0.5795
	16QAM DFT-s-OFDM	1	1	1	0	22.56	0.1805	26.56	0.4534
		1	23	1	49	22.48	0.1769	26.48	0.4442
		12	6	50	0	22.27	0.1686	26.27	0.4236
	64QAM DFT-s-OFDM	1	1	1	0	21.05	0.1272	25.05	0.3195
		1	23	1	49	20.98	0.1253	24.98	0.3147
		12	6	50	0	20.88	0.1224	24.88	0.3075
256QAM DFT-s-OFDM	1	1	1	0	18.72	0.0745	22.72	0.1872	
	1	23	1	49	18.79	0.0757	22.79	0.1903	
	12	6	50	0	18.89	0.0774	22.89	0.1945	
QPSK CP-OFDM	1	1	1	0	21.91	0.1553	25.91	0.3901	
	1	23	1	49	21.85	0.1531	25.85	0.3847	
		13	6	50	0	21.79	0.151	25.79	0.3793
Highest	Pi/2 BPSK DFT-s-OFDM	1	1	1	0	23.26	0.2119	27.26	0.5324
		1	23	1	49	23.33	0.2154	27.33	0.541
		12	6	50	0	23.43	0.2204	27.43	0.5535
	QPSK DFT-s-OFDM	1	1	1	0	23.42	0.2198	27.42	0.5522
		1	23	1	49	23.38	0.2178	27.38	0.5472
		12	6	50	0	23.39	0.2183	27.39	0.5484
	16QAM DFT-s-OFDM	1	1	1	0	22.57	0.1809	26.57	0.4544
		1	23	1	49	22.57	0.1805	26.57	0.4535
		12	6	50	0	22.42	0.1744	26.42	0.4381
	64QAM DFT-s-OFDM	1	1	1	0	21.05	0.1272	25.05	0.3196
		1	23	1	49	21.01	0.1262	25.01	0.3169
		12	6	50	0	20.92	0.1235	24.92	0.3102
256QAM DFT-s-OFDM	1	1	1	0	18.85	0.0768	22.85	0.1929	
	1	23	1	49	18.94	0.0783	22.94	0.1968	
		12	6	50	0	19.00	0.0794	23.00	0.1995

EN-DC n5 (ANT M)+2A (ANT M2)Combination 20MHz+10MHz(LTE)(GT - LC = 3 dB)									
Channel	Mode	NR		LTE		Conducted		ERP	
		RB		RB					
		Size	Offset	Size	Offset	Power(dBm)	Power(Watts)	ERP(dBm)	ERP(W)
Lowest	PI/2 BPSK DFT-s-	1	1	1	0	24.20	0.2633	25.05	0.3202
		1	104	1	99	24.25	0.2663	25.10	0.3239
		50	25	100	0	24.29	0.2688	25.14	0.327
	QPSK DFT-s- OFDM	1	1	1	0	24.10	0.2573	24.95	0.313
		1	104	1	99	24.23	0.2651	25.08	0.3224
		50	25	100	0	24.26	0.2669	25.11	0.3246
	16QAM DFT-s- OFDM	1	1	1	0	22.90	0.1949	23.75	0.2371
		1	104	1	99	23.09	0.2037	23.94	0.2477
		50	25	100	0	23.16	0.207	24.01	0.2517
	64QAM DFT-s- OFDM	1	1	1	0	21.59	0.1444	22.44	0.1756
		1	104	1	99	21.65	0.1461	22.50	0.1776
		50	25	100	0	21.71	0.1484	22.56	0.1805
	256QA M DFT-s-	1	1	1	0	19.68	0.0929	20.53	0.113
		1	104	1	99	19.82	0.096	20.67	0.1167
		50	25	100	0	19.70	0.0934	20.55	0.1135
Middle	PI/2 BPSK DFT-s-	1	1	1	0	24.24	0.2657	25.09	0.3231
		1	104	1	99	24.22	0.2645	25.07	0.3216
		50	25	100	0	24.27	0.2676	25.12	0.3255
	QPSK DFT-s- OFDM	1	1	1	0	24.19	0.2627	25.04	0.3195
		1	104	1	99	24.21	0.2638	25.06	0.3209
		50	25	100	0	24.26	0.2669	25.11	0.3246
	16QAM DFT-s- OFDM	1	1	1	0	23.04	0.2013	23.89	0.2448
		1	104	1	99	23.07	0.2027	23.92	0.2465
		50	25	100	0	23.23	0.2102	24.08	0.2557
	64QAM DFT-s- OFDM	1	1	1	0	21.74	0.1492	22.59	0.1814
		1	104	1	99	21.79	0.1509	22.64	0.1835
		50	25	100	0	21.75	0.1498	22.60	0.1821
	256QA M DFT-s-	1	1	1	0	19.80	0.0955	20.65	0.1161
		1	104	1	99	19.78	0.095	20.63	0.1156
		50	25	100	0	19.88	0.0972	20.73	0.1183
QPSK CP- OFDM	1	1	1	0	22.48	0.1771	23.33	0.2154	
	1	104	1	99	22.59	0.1816	23.44	0.2209	
	53	26	100	0	22.75	0.1883	23.60	0.2291	
Highest	PI/2 BPSK DFT-s-	1	1	1	0	24.27	0.2676	25.12	0.3254
		1	104	1	99	23.54	0.2257	24.39	0.2746
		50	25	100	0	24.27	0.2675	25.12	0.3254
	QPSK DFT-s- OFDM	1	1	1	0	24.10	0.2573	24.95	0.3129
		1	104	1	99	23.51	0.2243	24.36	0.2727
		50	25	100	0	24.27	0.2675	25.12	0.3253
	16QAM DFT-s- OFDM	1	1	1	0	22.99	0.199	23.84	0.242
		1	104	1	99	22.52	0.1787	23.37	0.2173
		50	25	100	0	23.19	0.2083	24.04	0.2534
	64QAM DFT-s- OFDM	1	1	1	0	21.67	0.1468	22.52	0.1785
		1	104	1	99	21.44	0.1392	22.29	0.1693
		50	25	100	0	21.77	0.1505	22.62	0.183
	256QA M DFT-s-	1	1	1	0	19.72	0.0938	20.57	0.1141
		1	104	1	99	19.73	0.094	20.58	0.1143
		50	25	100	0	19.76	0.0946	20.61	0.1151

EN-DC n5 (ANT M)+2A (ANT M2) Combination 15MHz+20MHz(LTE)(GT - LC = 3 dB)									
Channel	Mode	NR		LTE		Conducted		ERP	
		RB		RB					
		Size	Offset	Size	Offset	Power(dBm)	Power(Watts)	ERP(dBm)	ERP(W)
Lowest	PI/2 BPSK DFT-s-	1	1	1	0	24.24	0.2657	25.09	0.3231
		1	77	1	99	24.22	0.2645	25.07	0.3217
		36	18	100	0	24.27	0.2676	25.12	0.3254
	QPSK DFT-s- OFDM	1	1	1	0	24.19	0.2627	25.04	0.3195
		1	77	1	99	24.25	0.2658	25.10	0.3232
		36	18	100	0	24.25	0.2664	25.10	0.324
	16QAM DFT-s- OFDM	1	1	1	0	23.03	0.2008	23.88	0.2442
		1	77	1	99	23.14	0.206	23.99	0.2505
		36	18	100	0	23.16	0.2069	24.01	0.2516
	64QAM DFT-s- OFDM	1	1	1	0	21.68	0.1471	22.53	0.1789
		1	77	1	99	21.70	0.1478	22.55	0.1797
		36	18	100	0	21.67	0.1468	22.52	0.1785
	256QA M DFT-s-	1	1	1	0	19.76	0.0946	20.61	0.115
		1	77	1	99	19.83	0.0961	20.68	0.1169
		36	18	100	0	19.65	0.0923	20.50	0.1123
Middle	PI/2 BPSK DFT-s-	1	1	1	0	24.27	0.2675	25.12	0.3253
		1	77	1	99	24.25	0.2664	25.10	0.324
		36	18	100	0	24.23	0.2646	25.08	0.3218
	QPSK DFT-s- OFDM	1	1	1	0	24.25	0.2663	25.10	0.3239
		1	77	1	99	24.28	0.2682	25.13	0.3262
		36	18	100	0	24.24	0.2657	25.09	0.3232
	16QAM DFT-s- OFDM	1	1	1	0	23.11	0.2046	23.96	0.2488
		1	77	1	99	23.18	0.2078	24.03	0.2528
		36	18	100	0	23.23	0.2103	24.08	0.2557
	64QAM DFT-s- OFDM	1	1	1	0	21.74	0.1494	22.59	0.1818
		1	77	1	99	21.86	0.1536	22.71	0.1868
		36	18	100	0	21.75	0.1495	22.60	0.1818
	256QA M DFT-s-	1	1	1	0	19.78	0.0951	20.63	0.1156
		1	77	1	99	19.85	0.0966	20.70	0.1174
		36	18	100	0	19.69	0.0932	20.54	0.1133
QPSK CP- OFDM	1	1	1	0	22.76	0.1888	23.61	0.2296	
	1	77	1	99	22.60	0.182	23.45	0.2213	
	39	19	100	0	22.73	0.1875	23.58	0.228	
Highest	PI/2 BPSK DFT-s-	1	1	1	0	24.29	0.2688	25.14	0.3269
		1	77	1	99	23.61	0.2294	24.46	0.279
		36	18	100	0	24.28	0.2681	25.13	0.3261
	QPSK DFT-s- OFDM	1	1	1	0	24.22	0.2645	25.07	0.3216
		1	77	1	99	23.58	0.2278	24.43	0.2771
		36	18	100	0	24.24	0.2657	25.09	0.3231
	16QAM DFT-s- OFDM	1	1	1	0	23.11	0.2045	23.96	0.2487
		1	77	1	99	22.55	0.18	23.40	0.2189
		36	18	100	0	23.17	0.2074	24.02	0.2522
	64QAM DFT-s- OFDM	1	1	1	0	21.78	0.1505	22.63	0.1831
		1	77	1	99	21.45	0.1396	22.30	0.1698
		36	18	100	0	21.71	0.1484	22.56	0.1805
	256QA M DFT-s-	1	1	1	0	19.79	0.0953	20.64	0.1159
		1	77	1	99	19.71	0.0936	20.56	0.1138
		36	18	100	0	19.56	0.0904	20.41	0.11

EN-DC n5 (ANT M)+2A (ANT M2) Combination 10MHz+20MHz(LTE)(GT - LC = 3 dB)									
Channel	Mode	NR		LTE		Conducted		ERP	
		RB		RB					
		Size	Offset	Size	Offset	Power(dBm)	Power(Watts)	ERP(dBm)	ERP(W)
Lowest	PI/2 BPSK DFT-s-	1	1	1	0	24.13	0.2591	24.98	0.3151
		1	77	1	99	24.26	0.2669	25.11	0.3246
		36	18	100	0	24.15	0.2597	25.00	0.3159
	QPSK DFT-s- OFDM	1	1	1	0	24.06	0.2549	24.91	0.3101
		1	77	1	99	24.20	0.2632	25.05	0.3202
		36	18	100	0	24.12	0.2584	24.97	0.3143
	16QAM DFT-s- OFDM	1	1	1	0	22.94	0.1967	23.79	0.2393
		1	77	1	99	22.95	0.1972	23.80	0.2399
		36	18	100	0	23.06	0.2023	23.91	0.246
	64QAM DFT-s- OFDM	1	1	1	0	21.56	0.1431	22.41	0.174
		1	77	1	99	21.62	0.1451	22.47	0.1765
		36	18	100	0	21.54	0.1424	22.39	0.1732
	256QA M DFT-s-	1	1	1	0	19.57	0.0906	20.42	0.1102
		1	77	1	99	19.66	0.0925	20.51	0.1125
		36	18	100	0	19.47	0.0885	20.32	0.1077
Middle	PI/2 BPSK DFT-s-	1	1	1	0	24.24	0.2657	25.09	0.3231
		1	77	1	99	24.22	0.2644	25.07	0.3216
		36	18	100	0	24.17	0.2609	25.02	0.3173
	QPSK DFT-s- OFDM	1	1	1	0	24.21	0.2633	25.06	0.3203
		1	77	1	99	24.20	0.2627	25.05	0.3195
		36	18	100	0	24.16	0.2603	25.01	0.3166
	16QAM DFT-s- OFDM	1	1	1	0	23.06	0.2023	23.91	0.246
		1	77	1	99	23.09	0.2037	23.94	0.2477
		36	18	100	0	23.05	0.2017	23.90	0.2453
	64QAM DFT-s- OFDM	1	1	1	0	21.72	0.1484	22.57	0.1805
		1	77	1	99	21.76	0.1501	22.61	0.1826
		36	18	100	0	21.56	0.1431	22.41	0.174
	256QA M DFT-s-	1	1	1	0	19.73	0.0939	20.58	0.1142
		1	77	1	99	19.75	0.0945	20.60	0.1149
		36	18	100	0	19.49	0.089	20.34	0.1082
QPSK CP- OFDM	1	1	1	0	22.49	0.1774	23.34	0.2158	
	1	77	1	99	22.53	0.1791	23.38	0.2178	
	39	19	100	0	22.56	0.1803	23.41	0.2193	
Highest	PI/2 BPSK DFT-s-	1	1	1	0	24.23	0.2651	25.08	0.3224
		1	77	1	99	24.27	0.2676	25.12	0.3255
		36	18	100	0	24.20	0.2633	25.05	0.3202
	QPSK DFT-s- OFDM	1	1	1	0	24.10	0.2573	24.95	0.3129
		1	77	1	99	24.13	0.2585	24.98	0.3144
		36	18	100	0	24.18	0.262	25.03	0.3187
	16QAM DFT-s- OFDM	1	1	1	0	22.87	0.1936	23.72	0.2355
		1	77	1	99	22.96	0.1977	23.81	0.2404
		36	18	100	0	23.03	0.2008	23.88	0.2442
	64QAM DFT-s- OFDM	1	1	1	0	21.57	0.1435	22.42	0.1745
		1	77	1	99	21.62	0.1451	22.47	0.1764
		36	18	100	0	21.46	0.1398	22.31	0.1701
	256QA M DFT-s-	1	1	1	0	19.65	0.0923	20.50	0.1122
		1	77	1	99	19.61	0.0915	20.46	0.1112
		36	18	100	0	19.47	0.0885	20.32	0.1077

EN-DC n5 (ANT M)+2A (ANT M2) Combination 5MHz+20MHz(LTE)(GT - LC = 3 dB)									
Channel	Mode	NR		LTE		Conducted		ERP	
		RB		RB					
		Size	Offset	Size	Offset	Power(dBm)	Power(Watts)	ERP(dBm)	ERP(W)
Lowest	PI/2 BPSK DFT-s-	1	1	1	0	24.22	0.2645	25.07	0.3216
		1	23	1	99	24.20	0.2633	25.05	0.3202
		12	6	100	0	24.26	0.2669	25.11	0.3246
	QPSK DFT-s- OFDM	1	1	1	0	24.16	0.2609	25.01	0.3173
		1	23	1	99	24.26	0.267	25.11	0.3247
		12	6	100	0	24.27	0.2675	25.12	0.3254
	16QAM DFT-s- OFDM	1	1	1	0	23.04	0.2013	23.89	0.2448
		1	23	1	99	23.06	0.2023	23.91	0.246
		12	6	100	0	23.23	0.2103	24.08	0.2558
	64QAM DFT-s- OFDM	1	1	1	0	21.68	0.1474	22.53	0.1792
		1	23	1	99	21.75	0.1498	22.60	0.1822
		12	6	100	0	21.67	0.1467	22.52	0.1785
256QA M DFT-s-	1	1	1	0	19.78	0.095	20.63	0.1156	
	1	23	1	99	19.76	0.0947	20.61	0.1151	
	12	6	100	0	19.70	0.0933	20.55	0.1135	
Middle	PI/2 BPSK DFT-s-	1	1	1	0	24.17	0.2614	25.02	0.318
		1	23	1	99	24.25	0.2664	25.10	0.324
		12	6	100	0	24.23	0.2651	25.08	0.3224
	QPSK DFT-s- OFDM	1	1	1	0	24.24	0.2657	25.09	0.3231
		1	23	1	99	24.21	0.2639	25.06	0.3209
		12	6	100	0	24.26	0.267	25.11	0.3247
	16QAM DFT-s- OFDM	1	1	1	0	23.11	0.2046	23.96	0.2488
		1	23	1	99	23.08	0.2032	23.93	0.2471
		12	6	100	0	23.27	0.2122	24.12	0.2581
	64QAM DFT-s- OFDM	1	1	1	0	21.80	0.1515	22.65	0.1842
		1	23	1	99	21.54	0.1427	22.39	0.1736
		12	6	100	0	21.72	0.1485	22.57	0.1806
256QA M DFT-s-	1	1	1	0	19.83	0.0962	20.68	0.117	
	1	23	1	99	19.81	0.0958	20.66	0.1165	
	12	6	100	0	19.69	0.0932	20.54	0.1133	
QPSK CP- OFDM	1	1	1	0	22.58	0.1812	23.43	0.2204	
	1	23	1	99	22.56	0.1804	23.41	0.2194	
	13	6	100	0	22.71	0.1866	23.56	0.2269	
Highest	PI/2 BPSK DFT-s-	1	1	1	0	24.25	0.2664	25.10	0.3239
		1	23	1	99	24.19	0.2627	25.04	0.3195
		12	6	100	0	24.18	0.262	25.03	0.3187
	QPSK DFT-s- OFDM	1	1	1	0	24.26	0.2669	25.11	0.3247
		1	23	1	99	24.22	0.2645	25.07	0.3217
		12	6	100	0	24.24	0.2657	25.09	0.3231
	16QAM DFT-s- OFDM	1	1	1	0	23.06	0.2022	23.91	0.2459
		1	23	1	99	23.09	0.2037	23.94	0.2477
		12	6	100	0	23.23	0.2103	24.08	0.2557
	64QAM DFT-s- OFDM	1	1	1	0	21.74	0.1494	22.59	0.1817
		1	23	1	99	21.79	0.1509	22.64	0.1835
		12	6	100	0	21.67	0.1468	22.52	0.1785
256QA M DFT-s-	1	1	1	0	19.72	0.0937	20.57	0.114	
	1	23	1	99	19.76	0.0946	20.61	0.1151	
	12	6	100	0	19.73	0.094	20.58	0.1143	

EN-DC n66 (ANT M)+48A (ANT M2)Combination 40MHz+20MHz(LTE)(GT - LC = 3 dB)									
Channel	Mode	NR		LTE		Conducted		EIRP	
		RB		RB		Power(dBm)	Power(Watts)	EIRP(dBm)	EIRP(W)
		Size	Offset	Size	Offset				
Lowest	PI/2 BPSK DFT-s-	1	1	1	0	21.91	0.1553	24.91	0.3099
		1	214	1	99	22.69	0.1857	25.69	0.3706
		108	54	100	0	22.92	0.1958	25.92	0.3907
	QPSK DFT-s- OFDM	1	1	1	0	22.53	0.179	25.53	0.3572
		1	214	1	99	22.67	0.1849	25.67	0.369
		108	54	100	0	22.96	0.1976	25.96	0.3943
	16QAM DFT-s- OFDM	1	1	1	0	21.45	0.1396	24.45	0.2785
		1	214	1	99	21.45	0.1398	24.45	0.2789
		108	54	100	0	21.93	0.1561	24.93	0.3114
	64QAM DFT-s- OFDM	1	1	1	0	20.10	0.1023	23.10	0.2041
		1	214	1	99	20.15	0.1036	23.15	0.2068
		108	54	100	0	20.36	0.1087	23.36	0.2169
	256QA M DFT-s-	1	1	1	0	18.09	0.0644	21.09	0.1285
		1	214	1	99	18.22	0.0663	21.22	0.1323
		108	54	100	0	18.51	0.071	21.51	0.1416
Middle	PI/2 BPSK DFT-s-	1	1	1	0	22.46	0.1762	25.46	0.3516
		1	214	1	99	22.81	0.191	25.81	0.381
		108	54	100	0	23.09	0.2036	26.09	0.4062
	QPSK DFT-s- OFDM	1	1	1	0	22.53	0.1791	25.53	0.3573
		1	214	1	99	22.74	0.1879	25.74	0.3749
		108	54	100	0	23.05	0.2017	26.05	0.4025
	16QAM DFT-s- OFDM	1	1	1	0	21.44	0.1392	24.44	0.2777
		1	214	1	99	21.50	0.1411	24.50	0.2815
		108	54	100	0	21.96	0.1572	24.96	0.3136
	64QAM DFT-s- OFDM	1	1	1	0	20.18	0.1041	23.18	0.2077
		1	214	1	99	20.15	0.1036	23.15	0.2067
		108	54	100	0	20.44	0.1108	23.44	0.221
	256QA M DFT-s-	1	1	1	0	18.21	0.0662	21.21	0.1322
		1	214	1	99	18.23	0.0666	21.23	0.1329
		108	54	100	0	18.49	0.0707	21.49	0.141
QPSK CP- OFDM	1	1	1	0	21.01	0.1262	24.01	0.2517	
	1	214	1	49	20.94	0.1241	23.94	0.2477	
	108	54	50	0	21.46	0.1398	24.46	0.279	
Highest	PI/2 BPSK DFT-s-	1	1	1	0	22.51	0.1783	25.51	0.3558
		1	214	1	99	22.64	0.1836	25.64	0.3664
		108	54	100	0	23.08	0.2031	26.08	0.4053
	QPSK DFT-s- OFDM	1	1	1	0	22.57	0.1807	25.57	0.3606
		1	214	1	99	22.84	0.1923	25.84	0.3836
		108	54	100	0	23.05	0.2017	26.05	0.4025
	16QAM DFT-s- OFDM	1	1	1	0	21.42	0.1386	24.42	0.2765
		1	214	1	99	21.43	0.1391	24.43	0.2776
		108	54	100	0	21.88	0.1543	24.88	0.3079
	64QAM DFT-s- OFDM	1	1	1	0	20.11	0.1025	23.11	0.2045
		1	214	1	99	20.18	0.1041	23.18	0.2078
		108	54	100	0	20.35	0.1085	23.35	0.2164
	256QA M DFT-s-	1	1	1	0	18.09	0.0644	21.09	0.1284
		1	214	1	99	18.15	0.0653	21.15	0.1303
		108	54	100	0	18.40	0.0692	21.40	0.1382

EN-DC n66 (ANT M)+48A (ANT M2)Combination 20MHz+20MHz(LTE)(GT - LC = 3 dB)									
Channel	Mode	NR		LTE		Conducted		EIRP	
		RB		RB		Power(dBm)	Power(Watts)	EIRP(dBm)	EIRP(W)
		Size	Offset	Size	Offset				
Lowest	PI/2 BPSK DFT-s-	1	1	1	0	23.09	0.2036	26.09	0.4063
		1	104	1	99	23.00	0.1995	26.00	0.398
		50	25	100	0	23.05	0.2017	26.05	0.4025
	QPSK DFT-s- OFDM	1	1	1	0	23.03	0.2008	26.03	0.4007
		1	104	1	99	22.91	0.1954	25.91	0.3898
		50	25	100	0	23.04	0.2013	26.04	0.4016
	16QAM DFT-s- OFDM	1	1	1	0	21.88	0.1543	24.88	0.308
		1	104	1	99	22.03	0.1597	25.03	0.3186
		50	25	100	0	22.11	0.1626	25.11	0.3245
	64QAM DFT-s- OFDM	1	1	1	0	20.59	0.1146	23.59	0.2287
		1	104	1	99	20.62	0.1154	23.62	0.2302
		50	25	100	0	20.65	0.1162	23.65	0.2318
	256QA M DFT-s-	1	1	1	0	18.63	0.073	21.63	0.1456
		1	104	1	99	18.72	0.0745	21.72	0.1486
		50	25	100	0	18.60	0.0724	21.60	0.1445
Middle	PI/2 BPSK DFT-s-	1	1	1	0	22.99	0.199	25.99	0.3971
		1	104	1	99	22.90	0.195	25.90	0.389
		50	25	100	0	22.74	0.1879	25.74	0.3748
	QPSK DFT-s- OFDM	1	1	1	0	22.98	0.1985	25.98	0.3961
		1	104	1	99	23.06	0.2023	26.06	0.4036
		50	25	100	0	22.79	0.1901	25.79	0.3793
	16QAM DFT-s- OFDM	1	1	1	0	21.96	0.1572	24.96	0.3136
		1	104	1	99	22.04	0.1601	25.04	0.3194
		50	25	100	0	22.13	0.1634	25.13	0.326
	64QAM DFT-s- OFDM	1	1	1	0	20.56	0.1138	23.56	0.2271
		1	104	1	99	20.71	0.1178	23.71	0.2351
		50	25	100	0	20.60	0.1149	23.60	0.2292
	256QA M DFT-s-	1	1	1	0	18.67	0.0736	21.67	0.1469
		1	104	1	99	18.74	0.0748	21.74	0.1493
		50	25	100	0	18.63	0.073	21.63	0.1456
QPSK CP- OFDM	1	1	1	0	21.37	0.137	24.37	0.2734	
	1	104	1	49	21.42	0.1386	24.42	0.2765	
	53	26	50	0	21.62	0.1451	24.62	0.2895	
Highest	PI/2 BPSK DFT-s-	1	1	1	0	22.97	0.1981	25.97	0.3952
		1	104	1	99	23.11	0.2045	26.11	0.408
		50	25	100	0	23.37	0.2171	26.37	0.4332
	QPSK DFT-s- OFDM	1	1	1	0	23.04	0.2013	26.04	0.4017
		1	104	1	99	23.14	0.206	26.14	0.411
		50	25	100	0	23.30	0.2137	26.30	0.4263
	16QAM DFT-s- OFDM	1	1	1	0	21.81	0.1516	24.81	0.3024
		1	104	1	99	22.04	0.1601	25.04	0.3194
		50	25	100	0	21.95	0.1568	24.95	0.3128
	64QAM DFT-s- OFDM	1	1	1	0	20.46	0.1112	23.46	0.2219
		1	104	1	99	20.55	0.1136	23.55	0.2266
		50	25	100	0	20.47	0.1115	23.47	0.2225
	256QA M DFT-s-	1	1	1	0	18.50	0.0708	21.50	0.1413
		1	104	1	99	18.69	0.074	21.69	0.1476
		50	25	100	0	18.57	0.072	21.57	0.1437

EN-DC n66 (ANT M)+48A (ANT M2)Combination 15MHz+20MHz(LTE)(GT - LC =3 dB)									
Channel	Mode	NR		LTE		Conducted		EIRP	
		RB		RB		Power(dBm)	Power(Watts)	IRP(dBm)	EIRP(W)
		Size	Offset	Size	Offset				
Lowest	PI/2 BPSK DFT-s-	1	1	1	0	22.89	0.1945	25.89	0.3881
		1	77	1	99	22.69	0.1858	25.69	0.3707
		36	18	100	0	22.91	0.1954	25.91	0.3898
	QPSK DFT-s- OFDM	1	1	1	0	23.05	0.2017	26.05	0.4025
		1	77	1	99	22.89	0.1945	25.89	0.388
		36	18	100	0	23.00	0.1995	26.00	0.398
	16QAM DFT-s- OFDM	1	1	1	0	21.99	0.1583	24.99	0.3158
		1	77	1	99	21.98	0.1579	24.98	0.315
		36	18	100	0	22.13	0.1634	25.13	0.326
	64QAM DFT-s- OFDM	1	1	1	0	20.66	0.1165	23.66	0.2324
		1	77	1	99	20.70	0.1175	23.70	0.2345
		36	18	100	0	20.64	0.116	23.64	0.2314
	256QA M DFT-s-	1	1	1	0	18.69	0.074	21.69	0.1476
		1	77	1	99	18.74	0.0749	21.74	0.1494
		36	18	100	0	18.57	0.072	21.57	0.1436
Middle	PI/2 BPSK DFT-s-	1	1	1	0	22.80	0.1905	25.80	0.3801
		1	77	1	99	23.03	0.2008	26.03	0.4006
		36	18	100	0	22.81	0.191	25.81	0.381
	QPSK DFT-s- OFDM	1	1	1	0	22.91	0.1954	25.91	0.3898
		1	77	1	99	23.00	0.1995	26.00	0.398
		36	18	100	0	22.86	0.1932	25.86	0.3854
	16QAM DFT-s- OFDM	1	1	1	0	22.08	0.1615	25.08	0.3223
		1	77	1	99	22.04	0.1601	25.04	0.3195
		36	18	100	0	22.13	0.1634	25.13	0.326
	64QAM DFT-s- OFDM	1	1	1	0	20.70	0.1176	23.70	0.2346
		1	77	1	99	20.76	0.1192	23.76	0.2378
		36	18	100	0	20.64	0.116	23.64	0.2314
	256QA M DFT-s-	1	1	1	0	18.76	0.0751	21.76	0.1499
		1	77	1	99	18.78	0.0754	21.78	0.1505
		36	18	100	0	18.47	0.0703	21.47	0.1403
QPSK CP- OFDM	1	1	1	0	21.48	0.1405	24.48	0.2803	
	1	77	1	49	21.50	0.1412	24.50	0.2817	
	39	19	50	0	21.56	0.1431	24.56	0.2855	
Highest	PI/2 BPSK DFT-s-	1	1	1	0	23.23	0.2103	26.23	0.4196
		1	77	1	99	23.31	0.2141	26.31	0.4273
		36	18	100	0	23.40	0.2186	26.40	0.4362
	QPSK DFT-s- OFDM	1	1	1	0	23.35	0.2162	26.35	0.4313
		1	77	1	99	23.43	0.2201	26.43	0.4392
		36	18	100	0	23.47	0.2221	26.47	0.4432
	16QAM DFT-s- OFDM	1	1	1	0	21.83	0.1525	24.83	0.3043
		1	77	1	99	22.03	0.1597	25.03	0.3187
		36	18	100	0	22.00	0.1586	25.00	0.3165
	64QAM DFT-s- OFDM	1	1	1	0	20.48	0.1117	23.48	0.223
		1	77	1	99	20.75	0.1189	23.75	0.2372
		36	18	100	0	20.50	0.1123	23.50	0.2241
	256QA M DFT-s-	1	1	1	0	18.59	0.0723	21.59	0.1443
		1	77	1	99	18.70	0.0742	21.70	0.148
		36	18	100	0	18.39	0.069	21.39	0.1376

EN-DC n66 (ANT M)+48A (ANT M2)Combination 10MHz+20MHz(LTE)(GT - LC =3 dB)									
Channel	Mode	NR		LTE		Conducted		EIRP	
		RB		RB		Power(dBm)	Power(Watts)	EIRP(dBm)	EIRP(W)
		Size	Offset	Size	Offset				
Lowest	PI/2 BPSK DFT-s-	1	1	1	0	23.00	0.1994	26.00	0.3979
		1	50	1	99	23.06	0.2022	26.06	0.4035
		25	12	100	0	23.04	0.2013	26.04	0.4016
	QPSK DFT-s- OFDM	1	1	1	0	23.13	0.2055	26.13	0.4099
		1	50	1	99	23.05	0.2017	26.05	0.4025
		25	12	100	0	23.03	0.2008	26.03	0.4007
	16QAM DFT-s- OFDM	1	1	1	0	21.87	0.1539	24.87	0.3072
		1	50	1	99	22.07	0.1611	25.07	0.3215
		25	12	100	0	21.95	0.1568	24.95	0.3129
	64QAM DFT-s- OFDM	1	1	1	0	20.56	0.1138	23.56	0.2271
		1	50	1	99	20.67	0.1167	23.67	0.2329
		25	12	100	0	20.50	0.1123	23.50	0.2241
	256QA M DFT-s-	1	1	1	0	18.62	0.0728	21.62	0.1453
		1	50	1	99	18.70	0.0741	21.70	0.1478
		25	12	100	0	18.50	0.0708	21.50	0.1413
Middle	PI/2 BPSK DFT-s-	1	1	1	0	22.77	0.1892	25.77	0.3776
		1	50	1	99	22.99	0.199	25.99	0.3971
		25	12	100	0	22.86	0.1932	25.86	0.3854
	QPSK DFT-s- OFDM	1	1	1	0	22.70	0.1862	25.70	0.3716
		1	50	1	99	22.92	0.1958	25.92	0.3907
		25	12	100	0	22.84	0.1923	25.84	0.3836
	16QAM DFT-s- OFDM	1	1	1	0	21.89	0.1547	24.89	0.3087
		1	50	1	99	21.90	0.155	24.90	0.3093
		25	12	100	0	21.96	0.1572	24.96	0.3137
	64QAM DFT-s- OFDM	1	1	1	0	20.59	0.1146	23.59	0.2286
		1	50	1	99	20.62	0.1154	23.62	0.2302
		25	12	100	0	20.42	0.1102	23.42	0.22
	256QA M DFT-s-	1	1	1	0	18.60	0.0725	21.60	0.1446
		1	50	1	99	18.69	0.0739	21.69	0.1475
		25	12	100	0	18.47	0.0704	21.47	0.1404
QPSK CP- OFDM	1	1	1	0	21.38	0.1373	24.38	0.274	
	1	50	1	49	21.47	0.1401	24.47	0.2796	
	26	13	50	0	21.45	0.1396	24.45	0.2785	
Highest	PI/2 BPSK DFT-s-	1	1	1	0	23.19	0.2084	26.19	0.4158
		1	50	1	99	23.27	0.2122	26.27	0.4233
		25	12	100	0	23.29	0.2132	26.29	0.4253
	QPSK DFT-s- OFDM	1	1	1	0	23.38	0.2176	26.38	0.4342
		1	50	1	99	23.25	0.2112	26.25	0.4215
		25	12	100	0	23.33	0.2151	26.33	0.4292
	16QAM DFT-s- OFDM	1	1	1	0	21.80	0.1512	24.80	0.3017
		1	50	1	99	21.94	0.1564	24.94	0.3121
		25	12	100	0	13.13	0.0205	16.13	0.041
	64QAM DFT-s- OFDM	1	1	1	0	20.54	0.1133	23.54	0.2261
		1	50	1	99	20.69	0.1173	23.69	0.2339
		25	12	100	0	20.47	0.1115	23.47	0.2224
	256QA M DFT-s-	1	1	1	0	18.54	0.0715	21.54	0.1426
		1	50	1	99	18.69	0.074	21.69	0.1476
		25	12	100	0	18.43	0.0697	21.43	0.1391

EN-DC n66 (ANT M)+48A (ANT M2)Combination 5MHz+20MHz(LTE)(GT - LC =3 dB)									
Channel	Mode	NR		LTE		Conducted		EIRP	
		RB		RB					
		Size	Offset	Size	Offset	Power(dBm)	Power(Watts)	ERP(dBm)	EIRP(W)
Lowest	PI/2 BPSK DFT-s-	1	1	1	0	23.13	0.2055	26.13	0.4101
		1	23	1	99	23.09	0.2036	26.09	0.4062
		12	6	100	0	23.03	0.2008	26.03	0.4007
	QPSK DFT-s- OFDM	1	1	1	0	23.10	0.204	26.10	0.4071
		1	23	1	99	23.05	0.2017	26.05	0.4025
		12	6	100	0	23.08	0.2031	26.08	0.4053
	16QAM DFT-s- OFDM	1	1	1	0	21.88	0.1543	24.88	0.3079
		1	23	1	99	22.05	0.1605	25.05	0.3202
		12	6	100	0	22.10	0.1623	25.10	0.3238
	64QAM DFT-s- OFDM	1	1	1	0	20.57	0.1141	23.57	0.2277
		1	23	1	99	20.66	0.1165	23.66	0.2324
		12	6	100	0	20.52	0.1128	23.52	0.2251
256QA M DFT-s-	1	1	1	0	18.63	0.073	21.63	0.1456	
	1	23	1	99	18.71	0.0743	21.71	0.1483	
	12	6	100	0	18.53	0.0714	21.53	0.1424	
Middle	PI/2 BPSK DFT-s-	1	1	1	0	23.03	0.2008	26.03	0.4007
		1	23	1	99	22.84	0.1923	25.84	0.3836
		12	6	100	0	23.09	0.2036	26.09	0.4063
	QPSK DFT-s- OFDM	1	1	1	0	23.05	0.2018	26.05	0.4026
		1	23	1	99	22.93	0.1963	25.93	0.3916
		12	6	100	0	23.11	0.2045	26.11	0.4081
	16QAM DFT-s- OFDM	1	1	1	0	22.01	0.159	25.01	0.3172
		1	23	1	99	22.06	0.1608	25.06	0.3209
		12	6	100	0	22.14	0.1638	25.14	0.3268
	64QAM DFT-s- OFDM	1	1	1	0	20.66	0.1165	23.66	0.2324
		1	23	1	99	20.67	0.1168	23.67	0.233
		12	6	100	0	20.62	0.1154	23.62	0.2303
256QA M DFT-s-	1	1	1	0	18.78	0.0755	21.78	0.1506	
	1	23	1	99	18.73	0.0747	21.73	0.149	
	12	6	100	0	18.62	0.0728	21.62	0.1453	
QPSK CP- OFDM	1	1	1	0	21.57	0.1434	24.57	0.2862	
	1	23	1	49	21.41	0.1382	24.41	0.2758	
	13	6	50	0	21.56	0.1431	24.56	0.2855	
Highest	PI/2 BPSK DFT-s-	1	1	1	0	23.31	0.2141	26.31	0.4272
		1	23	1	99	23.18	0.2079	26.18	0.4147
		12	6	100	0	23.41	0.2191	26.41	0.4371
	QPSK DFT-s- OFDM	1	1	1	0	23.33	0.2151	26.33	0.4292
		1	23	1	99	23.16	0.2069	26.16	0.4129
		12	6	100	0	23.34	0.2156	26.34	0.4302
	16QAM DFT-s- OFDM	1	1	1	0	22.06	0.1608	25.06	0.3208
		1	23	1	99	21.98	0.1578	24.98	0.315
		12	6	100	0	22.15	0.1642	25.15	0.3275
	64QAM DFT-s- OFDM	1	1	1	0	20.72	0.1181	23.72	0.2356
		1	23	1	99	20.64	0.1159	23.64	0.2313
		12	6	100	0	20.65	0.1162	23.65	0.2319
256QA M DFT-s-	1	1	1	0	18.77	0.0754	21.77	0.1504	
	1	23	1	99	18.78	0.0754	21.78	0.1505	
	12	6	100	0	18.61	0.0726	21.61	0.1449	

SA n2 (ANT M) 20MHz (GT - LC = 4 dB)							
Channel	Mode	NR		Conducted		EIRP	
		RB		Power(dBm)	Power(Watts)	EIRP(dBm)	EIRP(W)
		Size	Offset				
Lowest	PI/2 BPSK DFT-s- OFDM	1	1	22.83	0.1919	26.83	0.4819
		1	104	23.08	0.2032	27.08	0.5105
		50	25	23.12	0.2051	27.12	0.5152
	QPSK DFT-s- OFDM	1	1	22.98	0.1986	26.98	0.4989
		1	104	23.06	0.2023	27.06	0.5082
		50	25	23.25	0.2113	27.25	0.5309
	16QAM DFT-s- OFDM	1	1	21.75	0.1496	25.75	0.3758
		1	104	21.73	0.1489	25.73	0.3741
		50	25	21.65	0.1462	25.65	0.3673
	64QAM DFT-s- OFDM	1	1	19.98	0.0995	23.98	0.25
		1	104	20.14	0.1033	24.14	0.2594
		50	25	20.22	0.1052	24.22	0.2642
	256QA M DFT-s- OFDM	1	1	18.25	0.0668	22.25	0.1679
		1	104	18.12	0.0649	22.12	0.1629
50		25	18.22	0.0664	22.22	0.1667	
Middle	PI/2 BPSK DFT-s- OFDM	1	1	23.19	0.2084	27.19	0.5236
		1	104	23.25	0.2113	27.25	0.5309
		50	25	23.27	0.2123	27.27	0.5333
	QPSK DFT-s- OFDM	1	1	23.09	0.2037	27.09	0.5117
		1	104	23.11	0.2046	27.11	0.514
		50	25	23.27	0.2123	27.27	0.5333
	16QAM DFT-s- OFDM	1	1	21.51	0.1416	25.51	0.3556
		1	104	21.86	0.1535	25.86	0.3855
		50	25	21.79	0.151	25.79	0.3793
	64QAM DFT-s- OFDM	1	1	20.09	0.1021	24.09	0.2564
		1	104	20.35	0.1084	24.35	0.2723
		50	25	20.31	0.1074	24.31	0.2698
	256QA M DFT-s- OFDM	1	1	18.06	0.064	22.06	0.1607
		1	104	18.35	0.0684	22.35	0.1718
50		25	18.33	0.0681	22.33	0.171	
QPSK CP-s- OFDM	1	1	21.22	0.1324	25.22	0.3327	
	1	104	21.42	0.1387	25.42	0.3483	
	53	26	21.29	0.1346	25.29	0.3381	
Highest	PI/2 BPSK DFT-s- OFDM	1	1	23.02	0.2004	27.02	0.5035
		1	104	22.81	0.191	26.81	0.4797
		50	25	22.96	0.1977	26.96	0.4966
	QPSK DFT-s- OFDM	1	1	23.03	0.2009	27.03	0.5047
		1	104	22.76	0.1888	26.76	0.4742
		50	25	23.01	0.2	27.01	0.5023
	16QAM DFT-s- OFDM	1	1	21.82	0.1521	25.82	0.3819
		1	104	21.81	0.1517	25.81	0.3811
		50	25	21.96	0.157	25.96	0.3945
	64QAM DFT-s- OFDM	1	1	20.29	0.1069	24.29	0.2685
		1	104	20.19	0.1045	24.19	0.2624
		50	25	20.44	0.1107	24.44	0.278
	256QA M DFT-s- OFDM	1	1	18.29	0.0675	22.29	0.1694
		1	104	18.35	0.0684	22.35	0.1718
50		25	18.37	0.0687	22.37	0.1726	

SA n2 (ANT M) 15MHz (GT - LC = 4 dB)							
Channel	Mode	NR		Conducted		EIRP	
		RB		Power(dBm)	Power(Watts)	EIRP(dBm)	EIRP(W)
		Size	Offset				
Lowest	PI/2 BPSK DFT-s- OFDM	1	1	22.45	0.1758	26.45	0.4416
		1	77	22.27	0.1687	26.27	0.4236
		36	18	22.42	0.1746	26.42	0.4385
	QPSK DFT-s- OFDM	1	1	22.47	0.1766	26.47	0.4436
		1	77	22.28	0.169	26.28	0.4246
		36	18	22.46	0.1762	26.46	0.4426
	16QAM DFT-s- OFDM	1	1	21.75	0.1496	25.75	0.3758
		1	77	21.72	0.1486	25.72	0.3733
		36	18	21.74	0.1493	25.74	0.375
	64QAM DFT-s- OFDM	1	1	20.11	0.1026	24.11	0.2576
		1	77	20.24	0.1057	24.24	0.2655
		36	18	20.23	0.1054	24.23	0.2649
	256QA M DFT-s- OFDM	1	1	18.23	0.0665	22.23	0.1671
		1	77	18.21	0.0662	22.21	0.1663
36		18	18.27	0.0671	22.27	0.1687	
Middle	PI/2 BPSK DFT-s- OFDM	1	1	22.14	0.1637	26.14	0.4111
		1	77	22.19	0.1656	26.19	0.4159
		36	18	22.22	0.1667	26.22	0.4188
	QPSK DFT-s- OFDM	1	1	22.04	0.16	26.04	0.4018
		1	77	22.15	0.1641	26.15	0.4121
		36	18	22.17	0.1648	26.17	0.414
	16QAM DFT-s- OFDM	1	1	21.64	0.1459	25.64	0.3664
		1	77	21.92	0.1556	25.92	0.3908
		36	18	21.82	0.1521	25.82	0.3819
	64QAM DFT-s- OFDM	1	1	20.18	0.1042	24.18	0.2618
		1	77	20.43	0.1104	24.43	0.2773
		36	18	20.33	0.1079	24.33	0.271
	256QA M DFT-s- OFDM	1	1	18.17	0.0656	22.17	0.1648
		1	77	18.43	0.0697	22.43	0.175
36		18	18.35	0.0684	22.35	0.1718	
QPSK CP-s- OFDM	1	1	21.34	0.1361	25.34	0.342	
	1	77	21.52	0.1419	25.52	0.3565	
	39	19	21.30	0.1349	25.30	0.3388	
Highest	PI/2 BPSK DFT-s- OFDM	1	1	22.22	0.1667	26.22	0.4188
		1	77	22.32	0.1706	26.32	0.4285
		36	18	22.38	0.173	26.38	0.4345
	QPSK DFT-s- OFDM	1	1	22.27	0.1687	26.27	0.4236
		1	77	22.35	0.1718	26.35	0.4315
		36	18	22.41	0.1742	26.41	0.4375
	16QAM DFT-s- OFDM	1	1	21.86	0.1535	25.86	0.3855
		1	77	21.96	0.157	25.96	0.3945
		36	18	21.92	0.1556	25.92	0.3908
	64QAM DFT-s- OFDM	1	1	20.24	0.1057	24.24	0.2655
		1	77	20.28	0.1067	24.28	0.2679
		36	18	20.44	0.1107	24.44	0.278
	256QA M DFT-s- OFDM	1	1	18.31	0.0678	22.31	0.1702
		1	77	18.53	0.0713	22.53	0.1791
36		18	18.41	0.0693	22.41	0.1742	

SA n2 (ANT M) 10MHz (GT - LC = 4 dB)							
Channel	Mode	NR		Conducted		EIRP	
		RB		Power(dBm)	Power(Watts)	EIRP(dBm)	EIRP(W)
		Size	Offset				
Lowest	PI/2 BPSK DFT-s-OFDM	1	1	22.29	0.1694	26.29	0.4256
		1	50	22.27	0.1687	26.27	0.4236
		25	12	22.34	0.1714	26.34	0.4305
	QPSK DFT-s-OFDM	1	1	22.27	0.1687	26.27	0.4236
		1	50	22.25	0.1679	26.25	0.4217
		25	12	22.32	0.1706	26.32	0.4285
	16QAM DFT-s-OFDM	1	1	21.63	0.1455	25.63	0.3656
		1	50	21.67	0.1469	25.67	0.369
		25	12	21.59	0.1442	25.59	0.3622
	64QAM DFT-s-OFDM	1	1	20.12	0.1028	24.12	0.2582
		1	50	20.22	0.1052	24.22	0.2642
		25	12	20.16	0.1038	24.16	0.2606
	256QA M DFT-s-OFDM	1	1	18.14	0.0652	22.14	0.1637
		1	50	18.16	0.0655	22.16	0.1644
25		12	18.13	0.065	22.13	0.1633	
Middle	PI/2 BPSK DFT-s-OFDM	1	1	22.03	0.1596	26.03	0.4009
		1	50	22.23	0.1671	26.23	0.4198
		25	12	22.08	0.1614	26.08	0.4055
	QPSK DFT-s-OFDM	1	1	22.02	0.1592	26.02	0.3999
		1	50	22.23	0.1671	26.23	0.4198
		25	12	22.07	0.1611	26.07	0.4046
	16QAM DFT-s-OFDM	1	1	21.58	0.1439	25.58	0.3614
		1	50	21.79	0.151	25.79	0.3793
		25	12	21.61	0.1449	25.61	0.3639
	64QAM DFT-s-OFDM	1	1	20.10	0.1023	24.10	0.257
		1	50	20.28	0.1067	24.28	0.2679
		25	12	20.25	0.1059	24.25	0.2661
	256QA M DFT-s-OFDM	1	1	18.10	0.0646	22.10	0.1622
		1	50	18.32	0.0679	22.32	0.1706
25		12	18.22	0.0664	22.22	0.1667	
QPSK CP-s-OFDM	1	1	21.24	0.133	25.24	0.3342	
	1	50	21.46	0.14	25.46	0.3516	
	26	13	21.15	0.1303	25.15	0.3273	
Highest	PI/2 BPSK DFT-s-OFDM	1	1	22.15	0.1641	26.15	0.4121
		1	50	22.37	0.1726	26.37	0.4335
		25	12	22.37	0.1726	26.37	0.4335
	QPSK DFT-s-OFDM	1	1	22.33	0.171	26.33	0.4295
		1	50	22.37	0.1726	26.37	0.4335
		25	12	22.38	0.173	26.38	0.4345
	16QAM DFT-s-OFDM	1	1	21.89	0.1545	25.89	0.3882
		1	50	21.90	0.1549	25.90	0.389
		25	12	21.75	0.1496	25.75	0.3758
	64QAM DFT-s-OFDM	1	1	20.21	0.105	24.21	0.2636
		1	50	20.24	0.1057	24.24	0.2655
		25	12	20.35	0.1084	24.35	0.2723
	256QA M DFT-s-OFDM	1	1	18.51	0.071	22.51	0.1782
		1	50	18.36	0.0685	22.36	0.1722
25		12	18.25	0.0668	22.25	0.1679	

SA n2 (ANT M) 5MHz (GT - LC = 4 dB)							
Channel	Mode	NR		Conducted		EIRP	
		RB		Power(dBm)	Power(Watts)	EIRP(dBm)	EIRP(W)
		Size	Offset				
Lowest	PI/2 BPSK DFT-s- OFDM	1	1	22.41	0.1742	26.41	0.4375
		1	23	22.35	0.1718	26.35	0.4315
		12	6	22.53	0.1791	26.53	0.4498
	QPSK DFT-s- OFDM	1	1	22.48	0.177	26.48	0.4446
		1	23	22.29	0.1694	26.29	0.4256
		12	6	22.51	0.1782	26.51	0.4477
	16QAM DFT-s- OFDM	1	1	21.85	0.1531	25.85	0.3846
		1	23	21.76	0.15	25.76	0.3767
		12	6	21.89	0.1545	25.89	0.3882
	64QAM DFT-s- OFDM	1	1	20.22	0.1052	24.22	0.2642
		1	23	20.24	0.1057	24.24	0.2655
		12	6	20.23	0.1054	24.23	0.2649
256QA M DFT-s- OFDM	1	1	18.32	0.0679	22.32	0.1706	
	1	23	18.26	0.067	22.26	0.1683	
	12	6	18.27	0.0671	22.27	0.1687	
Middle	PI/2 BPSK DFT-s- OFDM	1	1	22.21	0.1663	26.21	0.4178
		1	23	22.29	0.1694	26.29	0.4256
		12	6	22.27	0.1687	26.27	0.4236
	QPSK DFT-s- OFDM	1	1	22.18	0.1652	26.18	0.415
		1	23	22.22	0.1667	26.22	0.4188
		12	6	22.24	0.1675	26.24	0.4207
	16QAM DFT-s- OFDM	1	1	21.87	0.1538	25.87	0.3864
		1	23	21.86	0.1535	25.86	0.3855
		12	6	21.91	0.1552	25.91	0.3899
	64QAM DFT-s- OFDM	1	1	20.31	0.1074	24.31	0.2698
		1	23	20.36	0.1086	24.36	0.2729
		12	6	20.38	0.1091	24.38	0.2742
256QA M DFT-s- OFDM	1	1	18.33	0.0681	22.33	0.171	
	1	23	18.42	0.0695	22.42	0.1746	
	12	6	18.28	0.0673	22.28	0.169	
QPSK CP-s- OFDM	1	1	21.46	0.14	25.46	0.3516	
	1	23	21.48	0.1406	25.48	0.3532	
	13	6	21.28	0.1343	25.28	0.3373	
Highest	PI/2 BPSK DFT-s- OFDM	1	1	22.40	0.1738	26.40	0.4365
		1	23	22.41	0.1742	26.41	0.4375
		12	6	22.54	0.1795	26.54	0.4508
	QPSK DFT-s- OFDM	1	1	22.43	0.175	26.43	0.4395
		1	23	22.45	0.1758	26.45	0.4416
		12	6	22.59	0.1816	26.59	0.456
	16QAM DFT-s- OFDM	1	1	21.94	0.1563	25.94	0.3926
		1	23	21.87	0.1538	25.87	0.3864
		12	6	22.12	0.1629	26.12	0.4093
	64QAM DFT-s- OFDM	1	1	20.31	0.1074	24.31	0.2698
		1	23	20.37	0.1089	24.37	0.2735
		12	6	20.43	0.1104	24.43	0.2773
256QA M DFT-s- OFDM	1	1	18.65	0.0733	22.65	0.1841	
	1	23	18.58	0.0721	22.58	0.1811	
	12	6	18.52	0.0711	22.52	0.1786	

SA n5 (ANT M) 20MHz (GT - LC = 3 dB)								
Channel	Mode	NR		Conducted		ERP		
		RB		Power(dBm)	Power(Watts)	ERP(dBm)	ERP(W)	
		Size	Offset					
Lowest	PI/2 BPSK DFT-s-	1	1	24.46	0.2793	25.31	0.3396	
		1	104	24.51	0.2825	25.36	0.3436	
		50	25	24.36	0.2729	25.21	0.3319	
	QPSK DFT-s- OFDM	1	1	24.40	0.2754	25.25	0.335	
		1	104	24.30	0.2692	25.15	0.3273	
		50	25	24.43	0.2773	25.28	0.3373	
	16QAM DFT-s- OFDM	1	1	22.58	0.1811	23.43	0.2203	
		1	104	22.71	0.1866	23.56	0.227	
		50	25	22.70	0.1862	23.55	0.2265	
	64QAM DFT-s- OFDM	1	1	21.25	0.1334	22.10	0.1622	
		1	104	21.26	0.1337	22.11	0.1626	
		50	25	21.21	0.1321	22.06	0.1607	
	256QA M DFT-s-	1	1	18.93	0.0782	19.78	0.0951	
		1	104	19.04	0.0802	19.89	0.0975	
		50	25	19.09	0.0811	19.94	0.0986	
	Middle	PI/2 BPSK DFT-s-	1	1	24.47	0.2799	25.32	0.3404
			1	104	24.50	0.2818	25.35	0.3428
			50	25	24.42	0.2767	25.27	0.3365
QPSK DFT-s- OFDM		1	1	24.33	0.271	25.18	0.3296	
		1	104	24.38	0.2742	25.23	0.3334	
		50	25	24.42	0.2767	25.27	0.3365	
16QAM DFT-s- OFDM		1	1	23.12	0.2051	23.97	0.2495	
		1	104	23.05	0.2018	23.90	0.2455	
		50	25	23.14	0.2061	23.99	0.2506	
64QAM DFT-s- OFDM		1	1	21.55	0.1429	22.40	0.1738	
		1	104	21.68	0.1472	22.53	0.1791	
		50	25	21.63	0.1455	22.48	0.177	
256QA M DFT-s-		1	1	19.54	0.0899	20.39	0.1094	
		1	104	19.61	0.0914	20.46	0.1112	
		50	25	19.53	0.0897	20.38	0.1091	
QPSK CP-s- OFDM		1	1	22.51	0.1782	23.36	0.2168	
		1	104	22.49	0.1774	23.34	0.2158	
		53	26	22.55	0.1799	23.40	0.2188	
Highest	PI/2 BPSK DFT-s-	1	1	24.44	0.278	25.29	0.3381	
		1	104	24.47	0.2799	25.32	0.3404	
		50	25	24.39	0.2748	25.24	0.3342	
	QPSK DFT-s- OFDM	1	1	24.26	0.2667	25.11	0.3243	
		1	104	24.35	0.2723	25.20	0.3311	
		50	25	24.49	0.2812	25.34	0.342	
	16QAM DFT-s- OFDM	1	1	22.63	0.1832	23.48	0.2228	
		1	104	22.09	0.1618	22.94	0.1968	
		50	25	22.73	0.1875	23.58	0.228	
	64QAM DFT-s- OFDM	1	1	21.04	0.1271	21.89	0.1545	
		1	104	20.90	0.123	21.75	0.1496	
		50	25	21.24	0.133	22.09	0.1618	
	256QA M DFT-s-	1	1	19.17	0.0826	20.02	0.1005	
		1	104	19.44	0.0879	20.29	0.1069	
		50	25	19.16	0.0824	20.01	0.1002	

SA n5 (ANT M) 15MHz (GT - LC = 4 dB)							
Channel	Mode	NR		Conducted		ERP	
		RB		Power(dBm)	Power(Watts)	ERP(dBm)	E RP(W)
		Size	Offset				
Lowest	PI/2 BPSK DFT-s-	1	1	24.56	0.2858	25.41	0.3475
		1	77	24.49	0.2812	25.34	0.342
		36	18	24.38	0.2742	25.23	0.3334
	QPSK DFT-s- OFDM	1	1	24.37	0.2735	25.22	0.3327
		1	77	24.39	0.2748	25.24	0.3342
		36	18	24.43	0.2773	25.28	0.3373
	16QAM DFT-s- OFDM	1	1	23.20	0.2089	24.05	0.2541
		1	77	23.31	0.2143	24.16	0.2606
		36	18	23.05	0.2018	23.90	0.2455
	64QAM DFT-s- OFDM	1	1	21.41	0.1384	22.26	0.1683
		1	77	21.43	0.139	22.28	0.169
		36	18	21.49	0.1409	22.34	0.1714
	256QA M DFT-s-	1	1	19.63	0.0918	20.48	0.1117
		1	77	19.68	0.0929	20.53	0.113
		36	18	19.51	0.0893	20.36	0.1086
Middle	PI/2 BPSK DFT-s-	1	1	24.55	0.2851	25.40	0.3467
		1	77	24.51	0.2825	25.36	0.3436
		36	18	24.46	0.2793	25.31	0.3396
	QPSK DFT-s- OFDM	1	1	24.29	0.2685	25.14	0.3266
		1	77	24.39	0.2748	25.24	0.3342
		36	18	24.49	0.2812	25.34	0.342
	16QAM DFT-s- OFDM	1	1	23.23	0.2104	24.08	0.2559
		1	77	23.36	0.2168	24.21	0.2636
		36	18	23.13	0.2056	23.98	0.25
	64QAM DFT-s- OFDM	1	1	21.47	0.1403	22.32	0.1706
		1	77	21.48	0.1406	22.33	0.171
		36	18	21.52	0.1419	22.37	0.1726
	256QA M DFT-s-	1	1	19.58	0.0908	20.43	0.1104
		1	77	19.64	0.092	20.49	0.1119
		36	18	19.61	0.0914	20.46	0.1112
QPSK CP-s- OFDM	1	1	22.48	0.177	23.33	0.2153	
	1	77	22.36	0.1722	23.21	0.2094	
	39	19	22.52	0.1786	23.37	0.2173	
Highest	PI/2 BPSK DFT-s-	1	1	24.46	0.2793	25.31	0.3396
		1	77	24.52	0.2831	25.37	0.3443
		36	18	24.39	0.2748	25.24	0.3342
	QPSK DFT-s- OFDM	1	1	24.28	0.2679	25.13	0.3258
		1	77	24.42	0.2767	25.27	0.3365
		36	18	24.41	0.2761	25.26	0.3357
	16QAM DFT-s- OFDM	1	1	23.35	0.2163	24.20	0.263
		1	77	22.88	0.1941	23.73	0.236
		36	18	23.05	0.2018	23.90	0.2455
	64QAM DFT-s- OFDM	1	1	21.42	0.1387	22.27	0.1687
		1	77	21.38	0.1374	22.23	0.1671
		36	18	21.43	0.139	22.28	0.169
	256QA M DFT-s-	1	1	19.56	0.0904	20.41	0.1099
		1	77	19.63	0.0918	20.48	0.1117
		36	18	19.48	0.0887	20.33	0.1079

SA n5 (ANT) 10MHz (GT - LC = 4 dB)							
Channel	Mode	NR		Conducted		ERP	
		RB		Power(dBm)	Power(Watts)	ERP(dBm)	ERP(W)
		Size	Offset				
Lowest	PI/2 BPSK DFT-s-	1	1	24.18	0.2618	25.03	0.3184
		1	50	24.38	0.2742	25.23	0.3334
		25	12	24.21	0.2636	25.06	0.3206
	QPSK DFT-s- OFDM	1	1	24.11	0.2576	24.96	0.3133
		1	50	24.28	0.2679	25.13	0.3258
		25	12	24.23	0.2649	25.08	0.3221
	16QAM DFT-s- OFDM	1	1	23.02	0.2004	23.87	0.2438
		1	50	22.93	0.1963	23.78	0.2388
		25	12	23.01	0.2	23.86	0.2432
	64QAM DFT-s- OFDM	1	1	21.28	0.1343	22.13	0.1633
		1	50	21.81	0.1517	22.66	0.1845
		25	12	21.66	0.1466	22.51	0.1782
	256QA M DFT-s-	1	1	19.48	0.0887	20.33	0.1079
		1	50	19.45	0.0881	20.30	0.1072
		25	12	19.46	0.0883	20.31	0.1074
Middle	PI/2 BPSK DFT-s-	1	1	24.46	0.2793	25.31	0.3396
		1	50	24.49	0.2812	25.34	0.342
		25	12	24.45	0.2786	25.30	0.3388
	QPSK DFT-s- OFDM	1	1	24.26	0.2667	25.11	0.3243
		1	50	24.42	0.2767	25.27	0.3365
		25	12	24.34	0.2716	25.19	0.3304
	16QAM DFT-s- OFDM	1	1	23.11	0.2046	23.96	0.2489
		1	50	23.13	0.2056	23.98	0.25
		25	12	23.03	0.2009	23.88	0.2443
	64QAM DFT-s- OFDM	1	1	21.35	0.1365	22.20	0.166
		1	50	21.37	0.1371	22.22	0.1667
		25	12	21.55	0.1429	22.40	0.1738
	256QA M DFT-s-	1	1	19.59	0.091	20.44	0.1107
		1	50	19.45	0.0881	20.30	0.1072
		25	12	19.52	0.0895	20.37	0.1089
QPSK CP-s- OFDM	1	1	22.55	0.1799	23.40	0.2188	
	1	50	22.53	0.1791	23.38	0.2178	
	26	13	22.48	0.177	23.33	0.2153	
Highest	PI/2 BPSK DFT-s-	1	1	24.17	0.2612	25.02	0.3177
		1	50	24.28	0.2679	25.13	0.3258
		25	12	24.35	0.2723	25.20	0.3311
	QPSK DFT-s- OFDM	1	1	24.05	0.2541	24.90	0.309
		1	50	24.00	0.2512	24.85	0.3055
		25	12	24.32	0.2704	25.17	0.3289
	16QAM DFT-s- OFDM	1	1	23.01	0.2	23.86	0.2432
		1	50	23.08	0.2032	23.93	0.2472
		25	12	23.05	0.2018	23.90	0.2455
	64QAM DFT-s- OFDM	1	1	21.62	0.1452	22.47	0.1766
		1	50	21.78	0.1507	22.63	0.1832
		25	12	21.47	0.1403	22.32	0.1706
	256QA M DFT-s-	1	1	19.62	0.0916	20.47	0.1114
		1	50	19.54	0.0899	20.39	0.1094
		25	12	19.47	0.0885	20.32	0.1076

SA n5 (ANT) 5MHz (GT - LC = 4 dB)								
Channel	Mode	NR		Conducted		ERP		
		RB		Power(dBm)	Power(Watts)	ERP(dBm)	ERP(W)	
		Size	Offset					
Lowest	PI/2 BPSK DFT-s-	1	1	24.34	0.2716	25.19	0.3304	
		1	23	24.41	0.2761	25.26	0.3357	
		12	6	24.42	0.2767	25.27	0.3365	
	QPSK DFT-s- OFDM	1	1	24.31	0.2698	25.16	0.3281	
		1	23	24.32	0.2704	25.17	0.3289	
		12	6	24.43	0.2773	25.28	0.3373	
	16QAM DFT-s- OFDM	1	1	23.01	0.2	23.86	0.2432	
		1	23	23.07	0.2028	23.92	0.2466	
		12	6	23.01	0.2	23.86	0.2432	
	64QAM DFT-s- OFDM	1	1	21.52	0.1419	22.37	0.1726	
		1	23	21.48	0.1406	22.33	0.171	
		12	6	21.49	0.1409	22.34	0.1714	
	256QA M DFT-s-	1	1	19.46	0.0883	20.31	0.1074	
		1	23	19.50	0.0891	20.35	0.1084	
		12	6	19.37	0.0865	20.22	0.1052	
	Middle	PI/2 BPSK DFT-s-	1	1	24.59	0.2877	25.44	0.3499
			1	23	24.53	0.2838	25.38	0.3451
			12	6	24.46	0.2793	25.31	0.3396
QPSK DFT-s- OFDM		1	1	24.34	0.2716	25.19	0.3304	
		1	23	24.31	0.2698	25.16	0.3281	
		12	6	24.47	0.2799	25.32	0.3404	
16QAM DFT-s- OFDM		1	1	23.21	0.2094	24.06	0.2547	
		1	23	23.16	0.207	24.01	0.2518	
		12	6	23.18	0.208	24.03	0.2529	
64QAM DFT-s- OFDM		1	1	21.94	0.1563	22.79	0.1901	
		1	23	21.85	0.1531	22.70	0.1862	
		12	6	21.61	0.1449	22.46	0.1762	
256QA M DFT-s-		1	1	19.61	0.0914	20.46	0.1112	
		1	23	19.52	0.0895	20.37	0.1089	
		12	6	19.74	0.0942	20.59	0.1146	
QPSK CP-s- OFDM		1	1	22.79	0.1901	23.64	0.2312	
		1	23	22.69	0.1858	23.54	0.2259	
		13	6	22.65	0.1841	23.50	0.2239	
Highest	PI/2 BPSK DFT-s-	1	1	24.28	0.2679	25.13	0.3258	
		1	23	24.32	0.2704	25.17	0.3289	
		12	6	24.41	0.2761	25.26	0.3357	
	QPSK DFT-s- OFDM	1	1	24.31	0.2698	25.16	0.3281	
		1	23	24.21	0.2636	25.06	0.3206	
		12	6	24.43	0.2773	25.28	0.3373	
	16QAM DFT-s- OFDM	1	1	23.23	0.2104	24.08	0.2559	
		1	23	23.32	0.2148	24.17	0.2612	
		12	6	23.19	0.2084	24.04	0.2535	
	64QAM DFT-s- OFDM	1	1	21.78	0.1507	22.63	0.1832	
		1	23	21.81	0.1517	22.66	0.1845	
		12	6	21.58	0.1439	22.43	0.175	
	256QA M DFT-s-	1	1	19.75	0.0944	20.60	0.1148	
		1	23	19.58	0.0908	20.43	0.1104	
		12	6	19.65	0.0923	20.50	0.1122	

SA n25 (ANT M) 20MHz (GT - LC = 4 dB)							
Channel	Mode	NR		Conducted		EIRP	
		RB		Power(dBm)	Power(Watts)	EIRP(dBm)	EIRP(W)
		Size	Offset				
Lowest	PI/2 BPSK DFT-s- OFDM	1	1	22.37	0.1726	26.37	0.4335
		1	104	22.31	0.1702	26.31	0.4276
		50	25	22.52	0.1786	26.52	0.4487
	QPSK DFT-s- OFDM	1	1	22.43	0.175	26.43	0.4395
		1	104	22.18	0.1652	26.18	0.415
		50	25	22.54	0.1795	26.54	0.4508
	16QAM DFT-s- OFDM	1	1	21.76	0.15	25.76	0.3767
		1	104	21.91	0.1552	25.91	0.3899
		50	25	21.74	0.1493	25.74	0.375
	64QAM DFT-s- OFDM	1	1	20.41	0.1099	24.41	0.2761
		1	104	20.58	0.1143	24.58	0.2871
		50	25	20.77	0.1194	24.77	0.2999
256QA M DFT-s- OFDM	1	1	18.28	0.0673	22.28	0.169	
	1	104	18.44	0.0698	22.44	0.1754	
	50	25	18.31	0.0678	22.31	0.1702	
Middle	PI/2 BPSK DFT-s- OFDM	1	1	22.21	0.1663	26.21	0.4178
		1	104	22.48	0.177	26.48	0.4446
		50	25	22.49	0.1774	26.49	0.4457
	QPSK DFT-s- OFDM	1	1	22.13	0.1633	26.13	0.4102
		1	104	22.51	0.1782	26.51	0.4477
		50	25	22.52	0.1786	26.52	0.4487
	16QAM DFT-s- OFDM	1	1	21.82	0.1521	25.82	0.3819
		1	104	21.69	0.1476	25.69	0.3707
		50	25	21.92	0.1556	25.92	0.3908
	64QAM DFT-s- OFDM	1	1	20.43	0.1104	24.43	0.2773
		1	104	20.55	0.1135	24.55	0.2851
		50	25	20.60	0.1148	24.60	0.2884
256QA M DFT-s- OFDM	1	1	18.51	0.071	22.51	0.1782	
	1	104	18.36	0.0685	22.36	0.1722	
	50	25	18.28	0.0673	22.28	0.169	
QPSK CP-s- OFDM	1	1	21.25	0.1334	25.25	0.335	
	1	104	21.23	0.1327	25.23	0.3334	
	53	26	21.19	0.1315	25.19	0.3304	
Highest	PI/2 BPSK DFT-s- OFDM	1	1	22.62	0.1828	26.62	0.4592
		1	104	22.74	0.1879	26.74	0.4721
		50	25	22.76	0.1888	26.76	0.4742
	QPSK DFT-s- OFDM	1	1	22.44	0.1754	26.44	0.4406
		1	104	22.66	0.1845	26.66	0.4634
		50	25	22.77	0.1892	26.77	0.4753
	16QAM DFT-s- OFDM	1	1	21.66	0.1466	25.66	0.3681
		1	104	21.65	0.1462	25.65	0.3673
		50	25	21.79	0.151	25.79	0.3793
	64QAM DFT-s- OFDM	1	1	20.46	0.1112	24.46	0.2793
		1	104	20.43	0.1104	24.43	0.2773
		50	25	20.41	0.1099	24.41	0.2761
256QA M DFT-s- OFDM	1	1	18.28	0.0673	22.28	0.169	
	1	104	18.35	0.0684	22.35	0.1718	
	50	25	18.45	0.07	22.45	0.1758	

SA n25 (ANT M) 15MHz (GT - LC = 4 dB)							
Channel	Mode	NR		Conducted		EIRP	
		RB		Power(dBm)	Power(Watts)	EIRP(dBm)	EIRP(W)
		Size	Offset				
Lowest	PI/2 BPSK DFT-s- OFDM	1	1	22.57	0.1807	26.57	0.4539
		1	50	22.46	0.1762	26.46	0.4426
		25	12	22.54	0.1795	26.54	0.4508
	QPSK DFT-s- OFDM	1	1	22.41	0.1742	26.41	0.4375
		1	50	22.31	0.1702	26.31	0.4276
		25	12	22.16	0.1644	26.16	0.413
	16QAM DFT-s- OFDM	1	1	21.79	0.151	25.79	0.3793
		1	50	21.80	0.1514	25.80	0.3802
		25	12	21.93	0.156	25.93	0.3917
	64QAM DFT-s- OFDM	1	1	20.76	0.1191	24.76	0.2992
		1	50	20.64	0.1159	24.64	0.2911
		25	12	20.43	0.1104	24.43	0.2773
	256QA M DFT-s- OFDM	1	1	18.25	0.0668	22.25	0.1679
		1	50	18.51	0.071	22.51	0.1782
		25	12	18.46	0.0701	22.46	0.1762
Middle	PI/2 BPSK DFT-s- OFDM	1	1	22.28	0.169	26.28	0.4246
		1	50	22.10	0.1622	26.10	0.4074
		25	12	22.41	0.1742	26.41	0.4375
	QPSK DFT-s- OFDM	1	1	22.21	0.1663	26.21	0.4178
		1	50	22.42	0.1746	26.42	0.4385
		25	12	22.36	0.1722	26.36	0.4325
	16QAM DFT-s- OFDM	1	1	21.87	0.1538	25.87	0.3864
		1	50	21.72	0.1486	25.72	0.3733
		25	12	21.72	0.1486	25.72	0.3733
	64QAM DFT-s- OFDM	1	1	20.44	0.1107	24.44	0.278
		1	50	20.67	0.1167	24.67	0.2931
		25	12	20.79	0.1199	24.79	0.3013
	256QA M DFT-s- OFDM	1	1	18.24	0.0667	22.24	0.1675
		1	50	18.41	0.0693	22.41	0.1742
		25	12	18.25	0.0668	22.25	0.1679
QPSK CP-s- OFDM	1	1	21.18	0.1312	25.18	0.3296	
	1	50	21.29	0.1346	25.29	0.3381	
	26	13	21.15	0.1303	25.15	0.3273	
Highest	PI/2 BPSK DFT-s- OFDM	1	1	22.70	0.1862	26.70	0.4677
		1	50	22.71	0.1866	26.71	0.4688
		25	12	22.74	0.1879	26.74	0.4721
	QPSK DFT-s- OFDM	1	1	22.53	0.1791	26.53	0.4498
		1	50	22.66	0.1845	26.66	0.4634
		25	12	22.78	0.1897	26.78	0.4764
	16QAM DFT-s- OFDM	1	1	21.73	0.1489	25.73	0.3741
		1	50	21.98	0.1578	25.98	0.3963
		25	12	21.84	0.1528	25.84	0.3837
	64QAM DFT-s- OFDM	1	1	20.42	0.1102	24.42	0.2767
		1	50	20.53	0.113	24.53	0.2838
		25	12	20.46	0.1112	24.46	0.2793
	256QA M DFT-s- OFDM	1	1	18.36	0.0685	22.36	0.1722
		1	50	18.48	0.0705	22.48	0.177
		25	12	18.45	0.07	22.45	0.1758

SA n25 (ANT M) 10MHz (GT - LC = 4 dB)							
Channel	Mode	NR		Conducted		EIRP	
		RB		Power(dBm)	Power(Watts)	EIRP(dBm)	EIRP(W)
		Size	Offset				
Lowest	PI/2 BPSK DFT-s- OFDM	1	1	22.48	0.177	26.48	0.4446
		1	50	22.47	0.1766	26.47	0.4436
		25	12	22.49	0.1774	26.49	0.4457
	QPSK DFT-s- OFDM	1	1	22.37	0.1726	26.37	0.4335
		1	50	22.36	0.1722	26.36	0.4325
		25	12	22.51	0.1782	26.51	0.4477
	16QAM DFT-s- OFDM	1	1	21.71	0.1483	25.71	0.3724
		1	50	21.97	0.1574	25.97	0.3954
		25	12	21.75	0.1496	25.75	0.3758
	64QAM DFT-s- OFDM	1	1	20.67	0.1167	24.67	0.2931
		1	50	20.62	0.1153	24.62	0.2897
		25	12	20.69	0.1172	24.69	0.2944
256QA M DFT-s- OFDM	1	1	18.35	0.0684	22.35	0.1718	
	1	50	18.36	0.0685	22.36	0.1722	
	25	12	18.29	0.0675	22.29	0.1694	
Middle	PI/2 BPSK DFT-s- OFDM	1	1	22.25	0.1679	26.25	0.4217
		1	50	22.54	0.1795	26.54	0.4508
		25	12	22.29	0.1694	26.29	0.4256
	QPSK DFT-s- OFDM	1	1	22.17	0.1648	26.17	0.414
		1	50	22.39	0.1734	26.39	0.4355
		25	12	22.32	0.1706	26.32	0.4285
	16QAM DFT-s- OFDM	1	1	21.86	0.1535	25.86	0.3855
		1	50	21.64	0.1459	25.64	0.3664
		25	12	21.87	0.1538	25.87	0.3864
	64QAM DFT-s- OFDM	1	1	20.73	0.1183	24.73	0.2972
		1	50	20.65	0.1161	24.65	0.2917
		25	12	20.45	0.1109	24.45	0.2786
256QA M DFT-s- OFDM	1	1	18.21	0.0662	22.21	0.1663	
	1	50	18.45	0.07	22.45	0.1758	
	25	12	18.36	0.0685	22.36	0.1722	
QPSK CP-s- OFDM	1	1	21.31	0.1352	25.31	0.3396	
	1	50	21.16	0.1306	25.16	0.3281	
	26	13	21.32	0.1355	25.32	0.3404	
Highest	PI/2 BPSK DFT-s- OFDM	1	1	22.61	0.1824	26.61	0.4581
		1	50	22.63	0.1832	26.63	0.4603
		25	12	22.54	0.1795	26.54	0.4508
	QPSK DFT-s- OFDM	1	1	22.48	0.177	26.48	0.4446
		1	50	22.56	0.1803	26.56	0.4529
		25	12	22.57	0.1807	26.57	0.4539
	16QAM DFT-s- OFDM	1	1	21.69	0.1476	25.69	0.3707
		1	50	21.92	0.1556	25.92	0.3908
		25	12	21.68	0.1472	25.68	0.3698
	64QAM DFT-s- OFDM	1	1	20.56	0.1138	24.56	0.2858
		1	50	20.66	0.1164	24.66	0.2924
		25	12	20.41	0.1099	24.41	0.2761
256QA M DFT-s- OFDM	1	1	18.44	0.0698	22.44	0.1754	
	1	50	18.39	0.069	22.39	0.1734	
	25	12	18.31	0.0678	22.31	0.1702	

SA n25 (ANT M) 5MHz (GT - LC = 4 dB)							
Channel	Mode	NR		Conducted		EIRP	
		RB		Power(dBm)	Power(Watts)	EIRP(dBm)	EIRP(W)
		Size	Offset				
Lowest	PI/2 BPSK DFT-s- OFDM	1	1	22.48	0.177	26.48	0.4446
		1	23	22.41	0.1742	26.41	0.4375
		12	6	22.51	0.1782	26.51	0.4477
	QPSK DFT-s- OFDM	1	1	22.36	0.1722	26.36	0.4325
		1	23	22.32	0.1706	26.32	0.4285
		12	6	22.49	0.1774	26.49	0.4457
	16QAM DFT-s- OFDM	1	1	21.73	0.1489	25.73	0.3741
		1	23	21.92	0.1556	25.92	0.3908
		12	6	21.79	0.151	25.79	0.3793
	64QAM DFT-s- OFDM	1	1	20.58	0.1143	24.58	0.2871
		1	23	20.43	0.1104	24.43	0.2773
		12	6	20.63	0.1156	24.63	0.2904
	256QA M DFT-s- OFDM	1	1	18.39	0.069	22.39	0.1734
		1	23	18.24	0.0667	22.24	0.1675
12		6	18.21	0.0662	22.21	0.1663	
Middle	PI/2 BPSK DFT-s- OFDM	1	1	22.41	0.1742	26.41	0.4375
		1	23	22.52	0.1786	26.52	0.4487
		12	6	22.57	0.1807	26.57	0.4539
	QPSK DFT-s- OFDM	1	1	22.29	0.1694	26.29	0.4256
		1	23	22.34	0.1714	26.34	0.4305
		12	6	22.51	0.1782	26.51	0.4477
	16QAM DFT-s- OFDM	1	1	21.75	0.1496	25.75	0.3758
		1	23	21.68	0.1472	25.68	0.3698
		12	6	21.78	0.1507	25.78	0.3784
	64QAM DFT-s- OFDM	1	1	20.79	0.1199	24.79	0.3013
		1	23	20.82	0.1208	24.82	0.3034
		12	6	20.43	0.1104	24.43	0.2773
	256QA M DFT-s- OFDM	1	1	18.41	0.0693	22.41	0.1742
		1	23	18.46	0.0701	22.46	0.1762
12		6	18.29	0.0675	22.29	0.1694	
QPSK CP-s- OFDM	1	1	21.29	0.1346	25.29	0.3381	
	1	23	21.16	0.1306	25.16	0.3281	
	13	6	21.14	0.13	25.14	0.3266	
Highest	PI/2 BPSK DFT-s- OFDM	1	1	22.72	0.1871	26.72	0.4699
		1	23	22.71	0.1866	26.71	0.4688
		12	6	22.78	0.1897	26.78	0.4764
	QPSK DFT-s- OFDM	1	1	22.59	0.1816	26.59	0.456
		1	23	22.57	0.1807	26.57	0.4539
		12	6	22.77	0.1892	26.77	0.4753
	16QAM DFT-s- OFDM	1	1	21.65	0.1462	25.65	0.3673
		1	23	21.93	0.156	25.93	0.3917
		12	6	21.81	0.1517	25.81	0.3811
	64QAM DFT-s- OFDM	1	1	20.84	0.1213	24.84	0.3048
		1	23	20.46	0.1112	24.46	0.2793
		12	6	20.76	0.1191	24.76	0.2992
	256QA M DFT-s- OFDM	1	1	18.27	0.0671	22.27	0.1687
		1	23	18.51	0.071	22.51	0.1782
12		6	18.43	0.0697	22.43	0.175	

SA n66 (ANT M) 40MHz (GT - LC = 3 dB)							
Channel	Mode	NR		Conducted		EIRP	
		RB		Power(dB)	Power(Watts)	EIRP(dBm)	EIRP(W)
		Size	Offset				
Lowest	PI/2 BPSK DFT-s-OFDM	1	1	22.50	0.1778	25.50	0.3548
		1	214	22.67	0.1849	25.67	0.369
		108	54	23.08	0.2032	26.08	0.4055
	QPSK DFT-s-OFDM	1	1	22.43	0.175	25.43	0.3491
		1	214	22.55	0.1799	25.55	0.3589
		108	54	23.02	0.2004	26.02	0.3999
	16QAM DFT-s-OFDM	1	1	21.48	0.1406	24.48	0.2805
		1	214	21.49	0.1409	24.49	0.2812
		108	54	21.74	0.1493	24.74	0.2979
	64QAM DFT-s-OFDM	1	1	19.63	0.0918	22.63	0.1832
		1	214	19.76	0.0946	22.76	0.1888
		108	54	20.17	0.104	23.17	0.2075
	256QAM DFT-s-OFDM	1	1	17.59	0.0574	20.59	0.1146
		1	214	17.63	0.0579	20.63	0.1156
		108	54	18.19	0.0659	21.19	0.1315
Middle	PI/2 BPSK DFT-s-OFDM	1	1	22.63	0.1832	25.63	0.3656
		1	214	22.53	0.1791	25.53	0.3573
		108	54	23.09	0.2037	26.09	0.4064
	QPSK DFT-s-OFDM	1	1	22.54	0.1795	25.54	0.3581
		1	214	22.44	0.1754	25.44	0.3499
		108	54	23.20	0.2089	26.20	0.4169
	16QAM DFT-s-OFDM	1	1	21.13	0.1297	24.13	0.2588
		1	214	21.61	0.1449	24.61	0.2891
		108	54	21.77	0.1503	24.77	0.2999
	64QAM DFT-s-OFDM	1	1	19.71	0.0935	22.71	0.1866
		1	214	19.86	0.0968	22.86	0.1932
		108	54	20.27	0.1064	23.27	0.2123
	256QAM DFT-s-OFDM	1	1	17.63	0.0579	20.63	0.1156
		1	214	17.77	0.0598	20.77	0.1194
		108	54	18.24	0.0667	21.24	0.133
QPSK CP-OFDM	1	1	20.71	0.1178	23.71	0.235	
	1	214	20.91	0.1233	23.91	0.246	
	108	54	21.22	0.1324	24.22	0.2642	
Highest	PI/2 BPSK DFT-s-OFDM	1	1	22.53	0.1791	25.53	0.3573
		1	214	22.16	0.1644	25.16	0.3281
		108	54	22.92	0.1959	25.92	0.3908
	QPSK DFT-s-OFDM	1	1	22.58	0.1811	25.58	0.3614
		1	214	22.16	0.1644	25.16	0.3281
		108	54	22.94	0.1968	25.94	0.3926
	16QAM DFT-s-OFDM	1	1	21.49	0.1409	24.49	0.2812
		1	214	21.88	0.1542	24.88	0.3076
		108	54	21.74	0.1493	24.74	0.2979
	64QAM DFT-s-OFDM	1	1	19.87	0.0971	22.87	0.1936
		1	214	19.97	0.0993	22.97	0.1982
		108	54	20.24	0.1057	23.24	0.2109
	256QAM DFT-s-OFDM	1	1	17.66	0.0583	20.66	0.1164
		1	214	17.73	0.0593	20.73	0.1183
		108	54	18.24	0.0667	21.24	0.133

SA n66 (ANT M) 20MHz (GT - LC = 3 dB)							
Channel	Mode	NR		Conducted		EIRP	
		RB		Power(dB)	Power(Watts)	EIRP(dBm)	EIRP(W)
		Size	Offset				
Lowest	PI/2 BPSK DFT-s-OFDM	1	1	22.92	0.1959	25.92	0.3908
		1	104	23.12	0.2051	26.12	0.4093
		50	25	23.03	0.2009	26.03	0.4009
	QPSK DFT-s-OFDM	1	1	22.79	0.1901	25.79	0.3793
		1	104	23.01	0.2	26.01	0.399
		50	25	23.04	0.2014	26.04	0.4018
	16QAM DFT-s-OFDM	1	1	21.72	0.1486	24.72	0.2965
		1	104	21.95	0.1567	24.95	0.3126
		50	25	21.73	0.1489	24.73	0.2972
	64QAM DFT-s-OFDM	1	1	20.03	0.1007	23.03	0.2009
		1	104	20.13	0.103	23.13	0.2056
		50	25	20.15	0.1035	23.15	0.2065
256QAM DFT-s-OFDM	1	1	17.93	0.0621	20.93	0.1239	
	1	104	18.01	0.0632	21.01	0.1262	
	50	25	18.23	0.0665	21.23	0.1327	
Middle	PI/2 BPSK DFT-s-OFDM	1	1	23.02	0.2004	26.02	0.3999
		1	104	23.06	0.2023	26.06	0.4036
		50	25	23.15	0.2065	26.15	0.4121
	QPSK DFT-s-OFDM	1	1	23.05	0.2018	26.05	0.4027
		1	104	22.97	0.1982	25.97	0.3954
		50	25	23.18	0.208	26.18	0.415
	16QAM DFT-s-OFDM	1	1	21.91	0.1552	24.91	0.3097
		1	104	21.97	0.1574	24.97	0.3141
		50	25	21.82	0.1521	24.82	0.3034
	64QAM DFT-s-OFDM	1	1	20.21	0.105	23.21	0.2094
		1	104	20.29	0.1069	23.29	0.2133
		50	25	20.32	0.1076	23.32	0.2148
	256QAM DFT-s-OFDM	1	1	18.04	0.0637	21.04	0.1271
		1	104	18.15	0.0653	21.15	0.1303
		50	25	18.34	0.0682	21.34	0.1361
QPSK CP-OFDM	1	1	21.26	0.1337	24.26	0.2667	
	1	104	21.27	0.134	24.27	0.2673	
	53	26	21.34	0.1361	24.34	0.2716	
Highest	PI/2 BPSK DFT-s-OFDM	1	1	22.70	0.1862	25.70	0.3715
		1	104	22.56	0.1803	25.56	0.3597
		50	25	22.81	0.191	25.81	0.3811
	QPSK DFT-s-OFDM	1	1	22.65	0.1841	25.65	0.3673
		1	104	22.53	0.1791	25.53	0.3573
		50	25	22.81	0.191	25.81	0.3811
	16QAM DFT-s-OFDM	1	1	21.79	0.151	24.79	0.3013
		1	104	21.92	0.1556	24.92	0.3105
		50	25	21.81	0.1517	24.81	0.3027
	64QAM DFT-s-OFDM	1	1	20.33	0.1079	23.33	0.2153
		1	104	20.34	0.1081	23.34	0.2158
		50	25	20.24	0.1057	23.24	0.2109
	256QAM DFT-s-OFDM	1	1	17.98	0.0628	20.98	0.1253
		1	104	18.01	0.0632	21.01	0.1262
		50	25	18.29	0.0675	21.29	0.1346

SA n66 (ANT M) 15MHz (GT - LC = 3 dB)							
Channel	Mode	NR		Conducted		EIRP	
		RB		Power(dB)	Power(Watts)	EIRP(dBm)	EIRP(W)
		Size	Offset				
Lowest	PI/2 BPSK DFT-s-OFDM	1	1	22.94	0.1968	25.94	0.3926
		1	77	23.08	0.2032	26.08	0.4055
		36	18	23.03	0.2009	26.03	0.4009
	QPSK DFT-s-OFDM	1	1	22.89	0.1945	25.89	0.3882
		1	77	23.04	0.2014	26.04	0.4018
		36	18	23.11	0.2046	26.11	0.4083
	16QAM DFT-s-OFDM	1	1	21.87	0.1538	24.87	0.3069
		1	77	21.92	0.1556	24.92	0.3105
		36	18	21.74	0.1493	24.74	0.2979
	64QAM DFT-s-OFDM	1	1	20.13	0.103	23.13	0.2056
		1	77	20.16	0.1038	23.16	0.207
		36	18	20.19	0.1045	23.19	0.2084
	256QAM DFT-s-OFDM	1	1	17.92	0.0619	20.92	0.1236
		1	77	18.04	0.0637	21.04	0.1271
36		18	18.36	0.0685	21.36	0.1368	
Middle	PI/2 BPSK DFT-s-OFDM	1	1	23.17	0.2075	26.17	0.414
		1	77	23.09	0.2037	26.09	0.4064
		36	18	23.19	0.2084	26.19	0.4159
	QPSK DFT-s-OFDM	1	1	23.10	0.2042	26.10	0.4074
		1	77	22.95	0.1972	25.95	0.3936
		36	18	23.12	0.2051	26.12	0.4093
	16QAM DFT-s-OFDM	1	1	21.98	0.1578	24.98	0.3148
		1	77	22.02	0.1592	25.02	0.3177
		36	18	21.82	0.1521	24.82	0.3034
	64QAM DFT-s-OFDM	1	1	20.28	0.1067	23.28	0.2128
		1	77	20.37	0.1089	23.37	0.2173
		36	18	20.35	0.1084	23.35	0.2163
	256QAM DFT-s-OFDM	1	1	18.16	0.0655	21.16	0.1306
		1	77	18.13	0.065	21.13	0.1297
36		18	18.34	0.0682	21.34	0.1361	
QPSK CP-OFDM	1	1	21.29	0.1346	24.29	0.2685	
	1	77	21.22	0.1324	24.22	0.2642	
		39	19	21.23	0.1327	24.23	0.2649
Highest	PI/2 BPSK DFT-s-OFDM	1	1	22.73	0.1875	25.73	0.3741
		1	77	22.64	0.1837	25.64	0.3664
		36	18	22.72	0.1871	25.72	0.3733
	QPSK DFT-s-OFDM	1	1	22.67	0.1849	25.67	0.369
		1	77	22.55	0.1799	25.55	0.3589
		36	18	22.73	0.1875	25.73	0.3741
	16QAM DFT-s-OFDM	1	1	21.84	0.1528	24.84	0.3048
		1	77	21.97	0.1574	24.97	0.3141
		36	18	21.74	0.1493	24.74	0.2979
	64QAM DFT-s-OFDM	1	1	20.13	0.103	23.13	0.2056
		1	77	20.37	0.1089	23.37	0.2173
		36	18	20.21	0.105	23.21	0.2094
	256QAM DFT-s-OFDM	1	1	18.04	0.0637	21.04	0.1271
		1	77	18.16	0.0655	21.16	0.1306
36		18	18.28	0.0673	21.28	0.1343	

SA n66 (ANT M) 10MHz (GT - LC = 3 dB)							
Channel	Mode	NR		Conducted		EIRP	
		RB		Power(dB)	Power(Watts)	EIRP(dBm)	EIRP(W)
		Size	Offset				
Lowest	PI/2 BPSK DFT-s-OFDM	1	1	22.91	0.1954	25.91	0.3899
		1	50	23.04	0.2014	26.04	0.4018
		25	12	22.94	0.1968	25.94	0.3926
	QPSK DFT-s-OFDM	1	1	22.81	0.191	25.81	0.3811
		1	50	23.01	0.2	26.01	0.399
		25	12	22.98	0.1986	25.98	0.3963
	16QAM DFT-s-OFDM	1	1	21.81	0.1517	24.81	0.3027
		1	50	21.95	0.1567	24.95	0.3126
		25	12	21.59	0.1442	24.59	0.2877
	64QAM DFT-s-OFDM	1	1	20.10	0.1023	23.10	0.2042
		1	50	20.18	0.1042	23.18	0.208
		25	12	20.22	0.1052	23.22	0.2099
	256QAM DFT-s-OFDM	1	1	17.92	0.0619	20.92	0.1236
		1	50	18.02	0.0634	21.02	0.1265
		25	12	18.04	0.0637	21.04	0.1271
Middle	PI/2 BPSK DFT-s-OFDM	1	1	22.95	0.1972	25.95	0.3936
		1	50	22.99	0.1991	25.99	0.3972
		25	12	22.96	0.1977	25.96	0.3945
	QPSK DFT-s-OFDM	1	1	22.98	0.1986	25.98	0.3963
		1	50	22.84	0.1923	25.84	0.3837
		25	12	23.02	0.2004	26.02	0.3999
	16QAM DFT-s-OFDM	1	1	21.88	0.1542	24.88	0.3076
		1	50	21.87	0.1538	24.87	0.3069
		25	12	21.65	0.1462	24.65	0.2917
	64QAM DFT-s-OFDM	1	1	20.16	0.1038	23.16	0.207
		1	50	20.20	0.1047	23.20	0.2089
		25	12	20.15	0.1035	23.15	0.2065
	256QAM DFT-s-OFDM	1	1	18.01	0.0632	21.01	0.1262
		1	50	17.98	0.0628	20.98	0.1253
		25	12	18.07	0.0641	21.07	0.1279
QPSK CP-OFDM	1	1	21.17	0.1309	24.17	0.2612	
	1	50	21.21	0.1321	24.21	0.2636	
	26	13	21.09	0.1285	24.09	0.2564	
Highest	PI/2 BPSK DFT-s-OFDM	1	1	22.68	0.1854	25.68	0.3698
		1	50	22.55	0.1799	25.55	0.3589
		25	12	22.57	0.1807	25.57	0.3606
	QPSK DFT-s-OFDM	1	1	22.58	0.1811	25.58	0.3614
		1	50	22.63	0.1832	25.63	0.3656
		25	12	22.64	0.1837	25.64	0.3664
	16QAM DFT-s-OFDM	1	1	21.88	0.1542	24.88	0.3076
		1	50	21.95	0.1567	24.95	0.3126
		25	12	21.67	0.1469	24.67	0.2931
	64QAM DFT-s-OFDM	1	1	20.27	0.1064	23.27	0.2123
		1	50	20.35	0.1084	23.35	0.2163
		25	12	20.25	0.1059	23.25	0.2113
	256QAM DFT-s-OFDM	1	1	18.05	0.0638	21.05	0.1274
		1	50	18.11	0.0647	21.11	0.1291
		25	12	18.12	0.0649	21.12	0.1294

SA n66 (ANT M) 5MHz (GT - LC = 3 dB)							
Channel	Mode	NR		Conducted		EIRP	
		RB		Power(dB)	Power(Watts)	EIRP(dBm)	EIRP(W)
		Size	Offset				
Lowest	PI/2 BPSK DFT-s-OFDM	1	1	22.96	0.1977	25.96	0.3945
		1	23	23.07	0.2028	26.07	0.4046
		12	6	23.01	0.2	26.01	0.399
	QPSK DFT-s-OFDM	1	1	22.89	0.1945	25.89	0.3882
		1	23	22.99	0.1991	25.99	0.3972
		12	6	23.03	0.2009	26.03	0.4009
	16QAM DFT-s-OFDM	1	1	21.81	0.1517	24.81	0.3027
		1	23	21.87	0.1538	24.87	0.3069
		12	6	21.74	0.1493	24.74	0.2979
	64QAM DFT-s-OFDM	1	1	20.09	0.1021	23.09	0.2037
		1	23	20.18	0.1042	23.18	0.208
		12	6	20.20	0.1047	23.20	0.2089
256QAM DFT-s-OFDM	1	1	17.91	0.0618	20.91	0.1233	
	1	23	18.02	0.0634	21.02	0.1265	
	12	6	18.21	0.0662	21.21	0.1321	
Middle	PI/2 BPSK DFT-s-OFDM	1	1	23.11	0.2046	26.11	0.4083
		1	23	23.13	0.2056	26.13	0.4102
		12	6	23.16	0.207	26.16	0.413
	QPSK DFT-s-OFDM	1	1	23.12	0.2051	26.12	0.4093
		1	23	23.08	0.2032	26.08	0.4055
		12	6	23.16	0.207	26.16	0.413
	16QAM DFT-s-OFDM	1	1	21.98	0.1578	24.98	0.3148
		1	23	21.96	0.157	24.96	0.3133
		12	6	21.84	0.1528	24.84	0.3048
	64QAM DFT-s-OFDM	1	1	20.43	0.1104	23.43	0.2203
		1	23	20.35	0.1084	23.35	0.2163
		12	6	20.33	0.1079	23.33	0.2153
	256QAM DFT-s-OFDM	1	1	18.11	0.0647	21.11	0.1291
		1	23	18.14	0.0652	21.14	0.13
		12	6	18.34	0.0682	21.34	0.1361
QPSK CP-OFDM	1	1	21.38	0.1374	24.38	0.2742	
	1	23	21.34	0.1361	24.34	0.2716	
	13	6	21.33	0.1358	24.33	0.271	
Highest	PI/2 BPSK DFT-s-OFDM	1	1	22.67	0.1849	25.67	0.369
		1	23	22.56	0.1803	25.56	0.3597
		12	6	22.66	0.1845	25.66	0.3681
	QPSK DFT-s-OFDM	1	1	22.57	0.1807	25.57	0.3606
		1	23	22.52	0.1786	25.52	0.3565
		12	6	22.71	0.1866	25.71	0.3724
	16QAM DFT-s-OFDM	1	1	21.93	0.156	24.93	0.3112
		1	23	21.94	0.1563	24.94	0.3119
		12	6	21.90	0.1549	24.90	0.309
	64QAM DFT-s-OFDM	1	1	20.37	0.1089	23.37	0.2173
		1	23	20.32	0.1076	23.32	0.2148
		12	6	20.33	0.1079	23.33	0.2153
256QAM DFT-s-OFDM	1	1	18.12	0.0649	21.12	0.1294	
	1	23	18.06	0.064	21.06	0.1276	
	12	6	18.34	0.0682	21.34	0.1361	



FR1 n2 SA

Peak-to-Average Ratio

Mode	FR1 n2 / 20MHz / DFT-S OFDM				
Mod.	PI/2 BPSK	PI/2 BPSK	QPSK	QPSK	Limit: 13dB
RB Size	1RB	Full RB	1RB	Full RB	Result
Lowest CH	3.45	3.88	4.26	5.22	PASS
Middle CH	4.29	3.62	5.57	5.16	
Highest CH	3.80	3.57	5.54	4.96	



FR1 n2 / 20MHz / DFT-S OFDM

PI/2 BPSK

QPSK

Lowest Channel / 1RB

Lowest Channel / 1RB

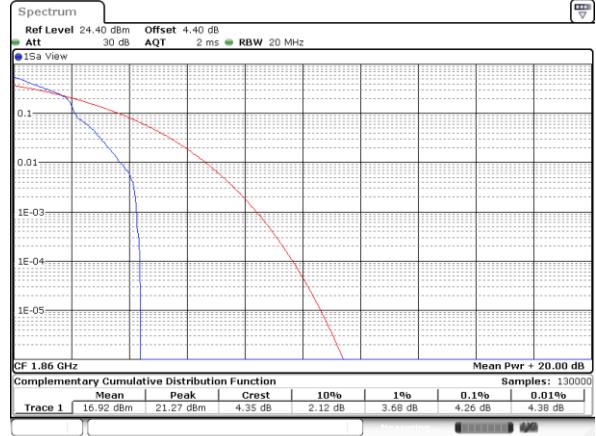
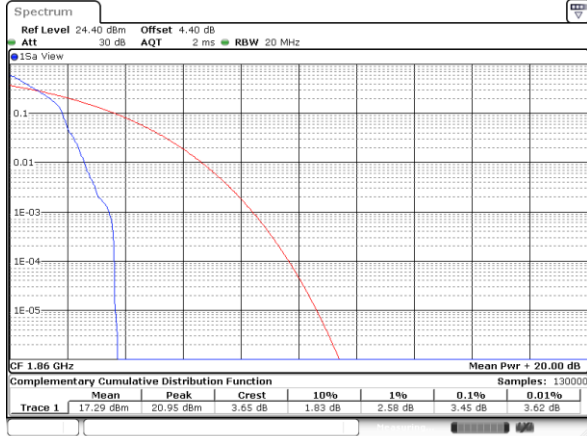

Date: 11_JAN.2021 06:55:41

Date: 11_JAN.2021 06:55:20

Middle Channel / 1 RB

Middle Channel / 1 RB

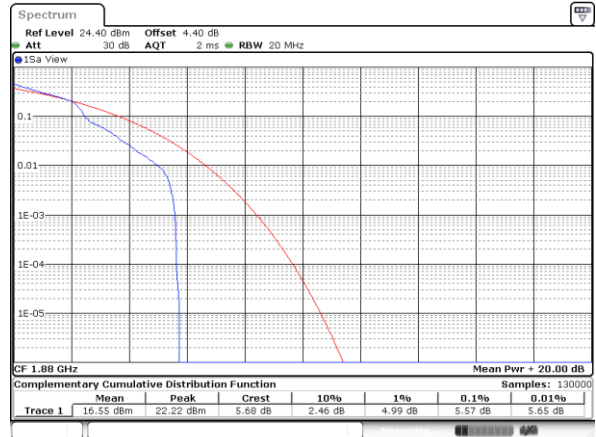
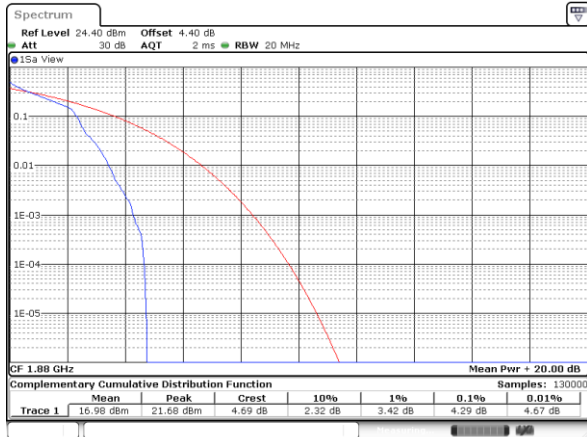

Date: 11_JAN.2021 06:58:09

Date: 11_JAN.2021 06:58:22

Highest Channel / 1 RB

Highest Channel / 1 RB

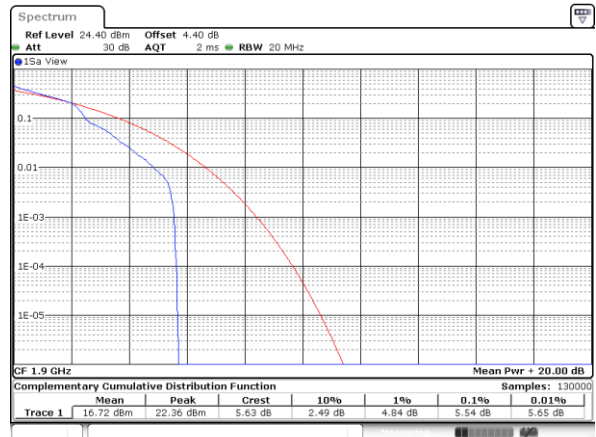
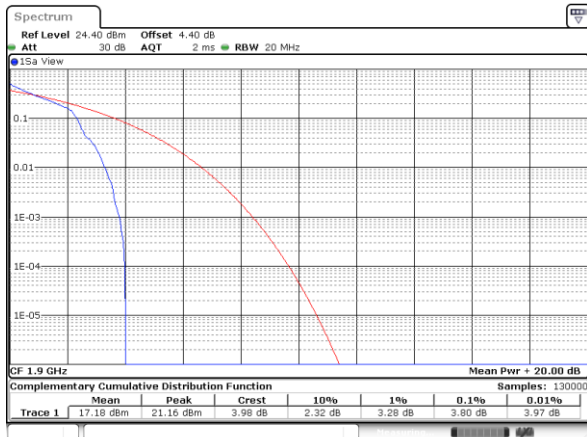

Date: 11_JAN.2021 06:59:26

Date: 11_JAN.2021 06:59:15



FR1 n2 / 20MHz / DFT-S OFDM

PI/2 BPSK

QPSK

Lowest Channel / Full RB

Lowest Channel / Full RB

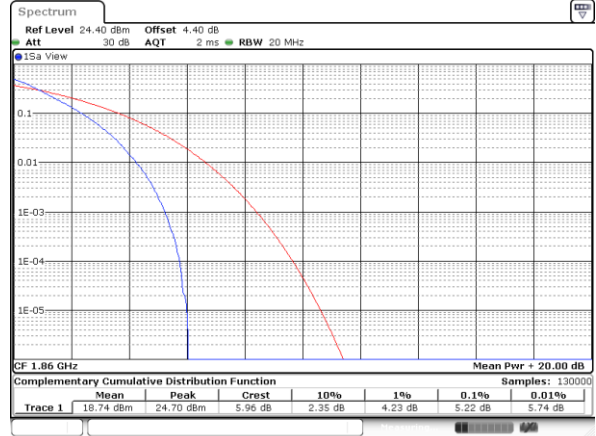
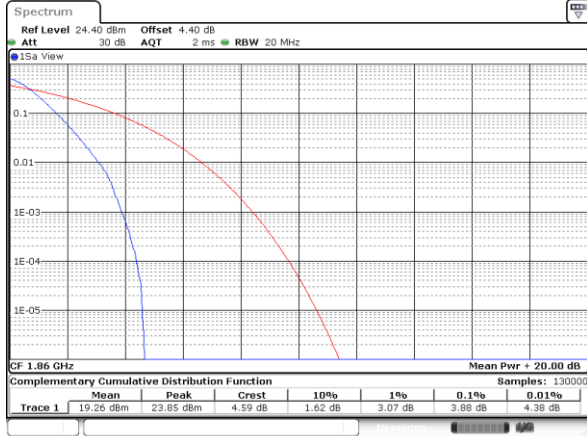

Date: 11_JAN_2021 06:56:04

Date: 11_JAN_2021 06:56:28

Middle Channel / Full RB

Middle Channel / Full RB

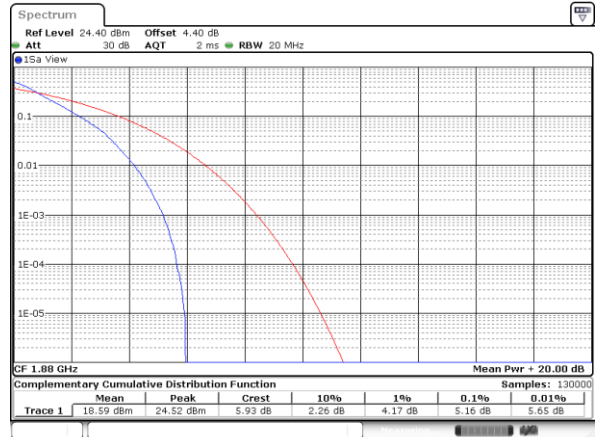
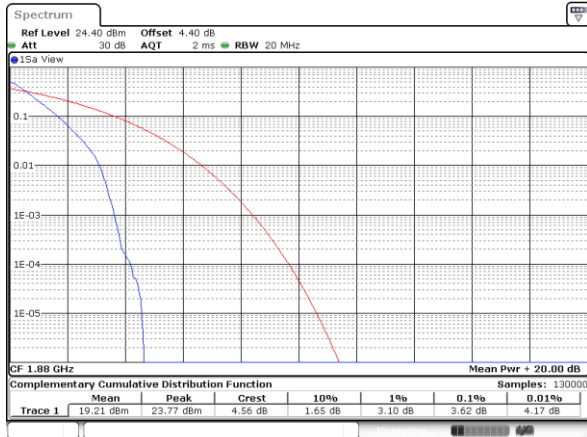

Date: 11_JAN_2021 06:57:38

Date: 11_JAN_2021 06:57:14

Highest Channel / Full RB

Highest Channel / Full RB

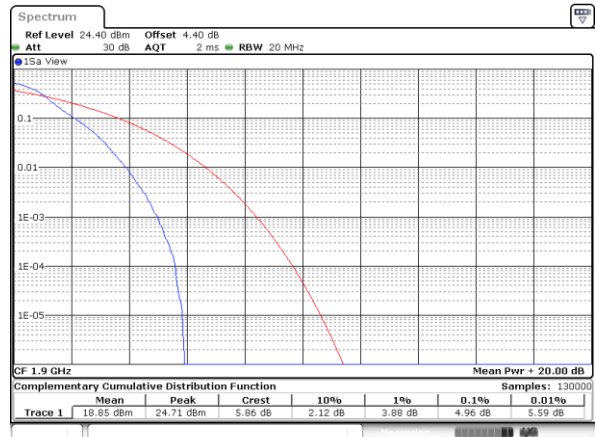
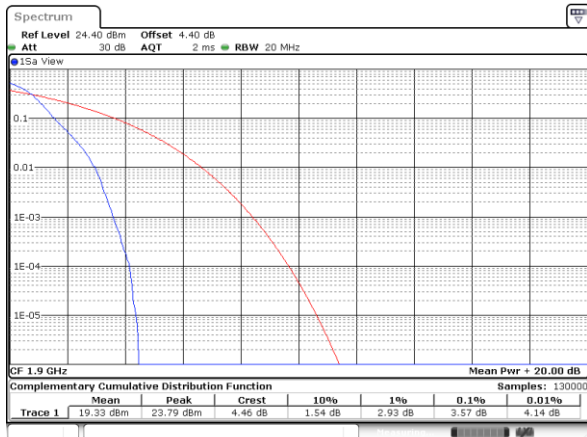

Date: 11_JAN_2021 06:59:53

Date: 11_JAN_2021 07:00:05



26dB Bandwidth

Mode	FR1 n2 : 26dB BW(MHz) / CP-OFDM							
BW	5MHz	5MHz	5MHz	5MHz				
Mod.	QPSK	16QAM	64QAM	256QAM				
Middle CH	4.83	4.83	4.83	4.86				

Mode	FR1 n2 : 26dB BW(MHz) / CP-OFDM							
BW	10MHz	10MHz	10MHz	10MHz				
Mod.	QPSK	16QAM	64QAM	256QAM				
Middle CH	9.77	9.79	9.77	9.75				

Mode	FR1 n2 : 26dB BW(MHz) / CP-OFDM							
BW	15MHz	15MHz	15MHz	15MHz				
Mod.	QPSK	16QAM	64QAM	256QAM				
Middle CH	14.96	14.96	14.93	14.89				

Mode	FR1 n2 : 26dB BW(MHz) / CP-OFDM							
BW	20MHz	20MHz	20MHz	20MHz				
Mod.	QPSK	16QAM	64QAM	256QAM				
Middle CH	19.98	19.82	19.98	19.70				

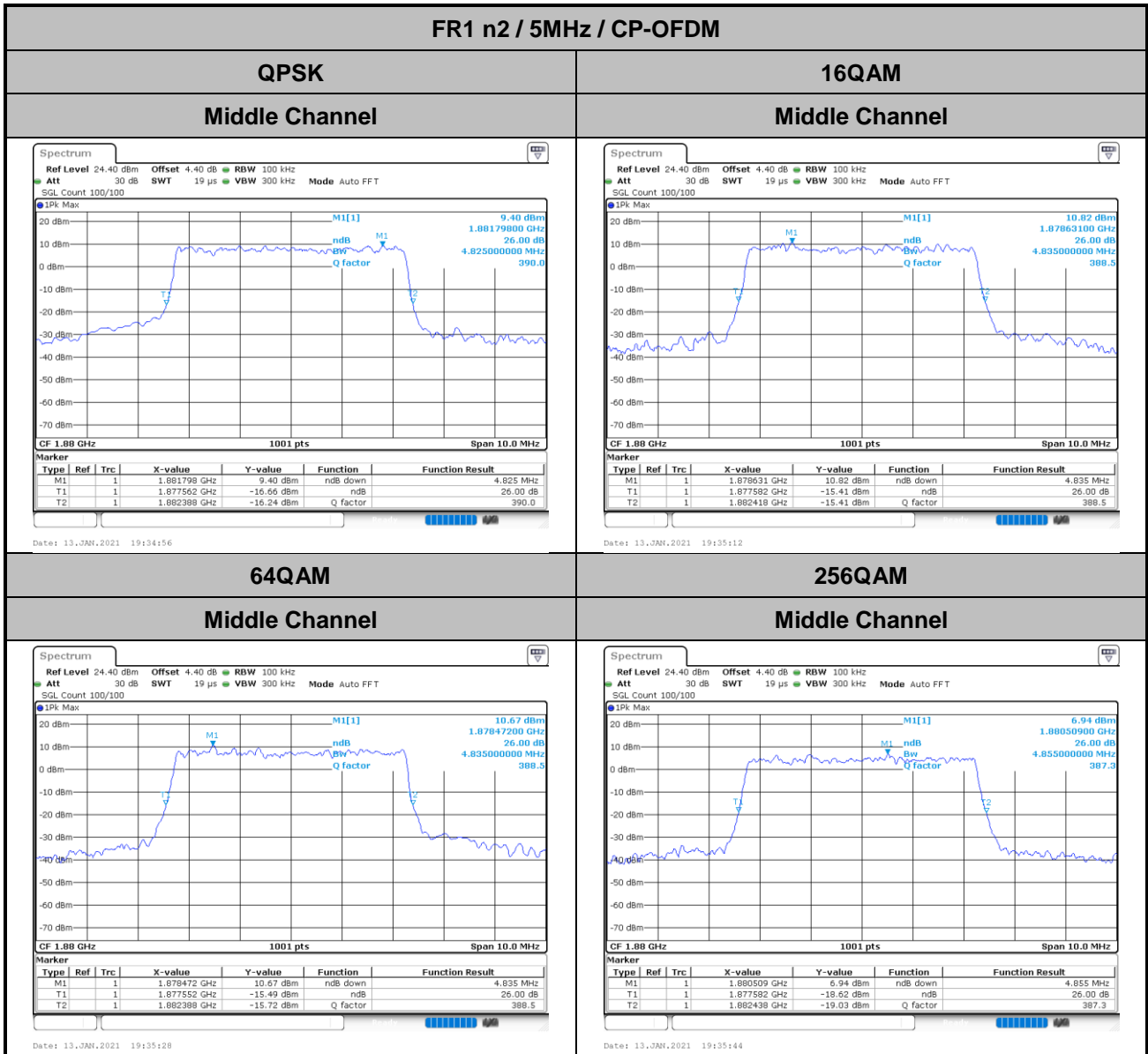

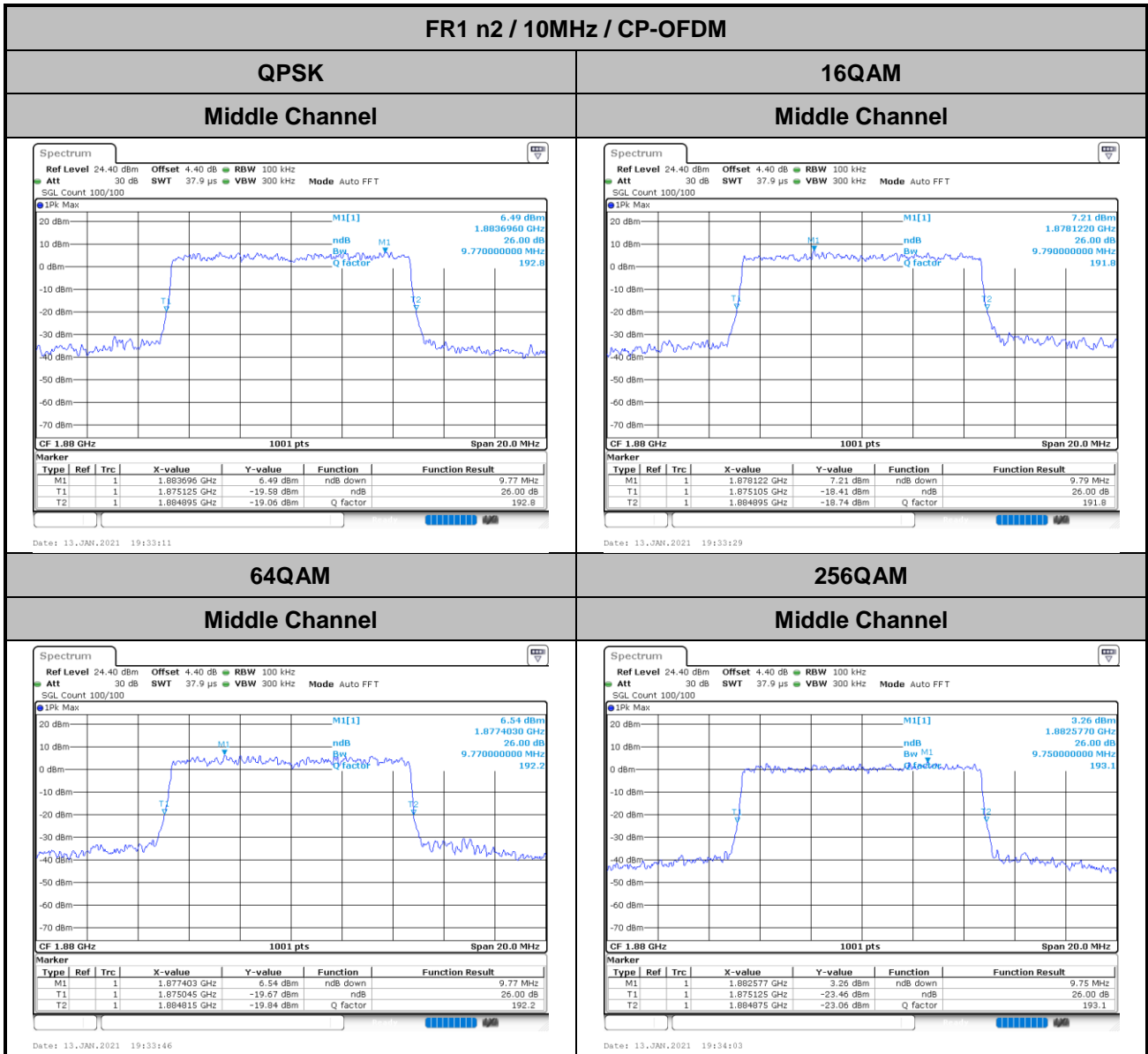

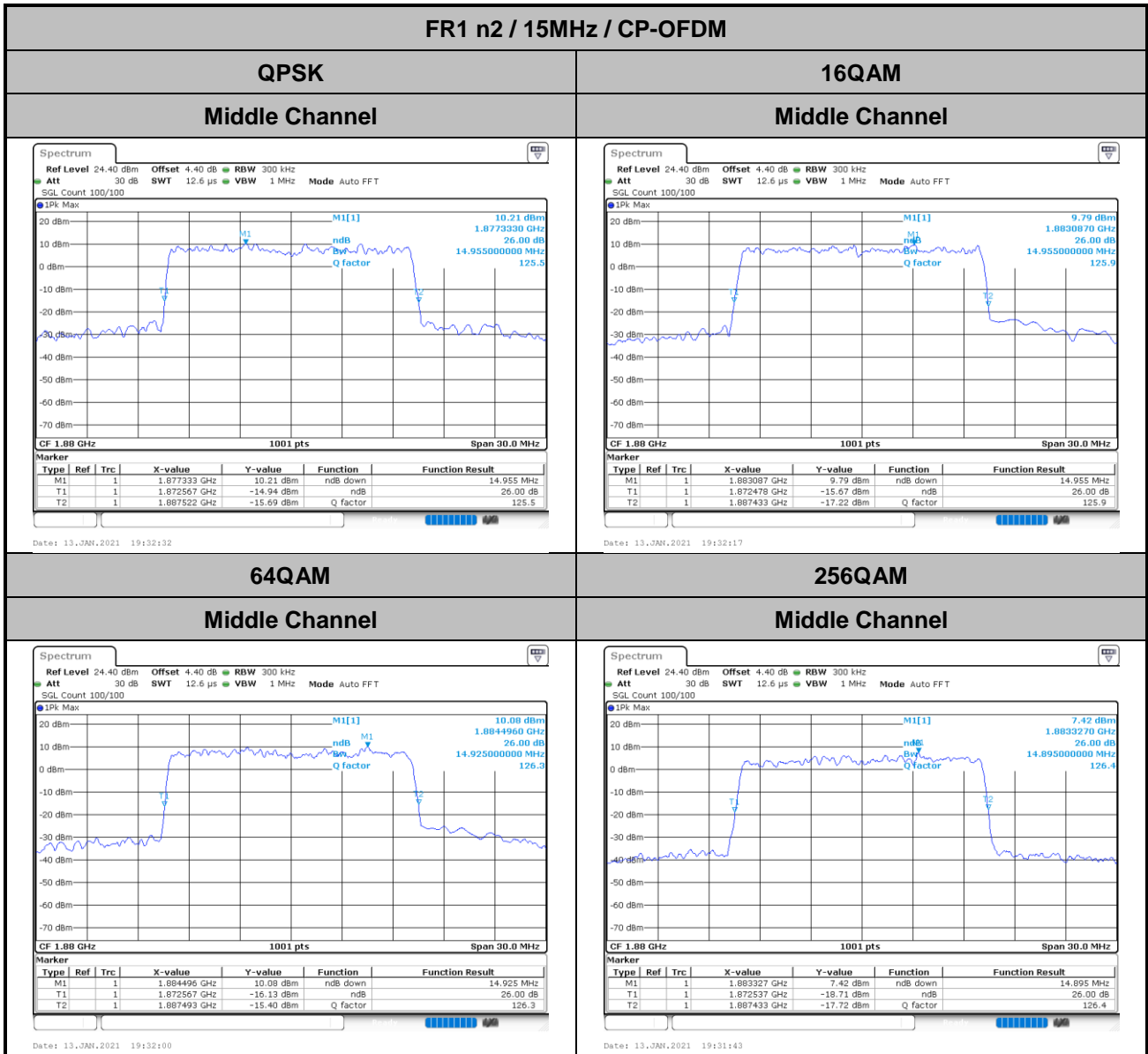



FR1 n2 / 20MHz / CP-OFDM

QPSK

16QAM

Middle Channel

Middle Channel

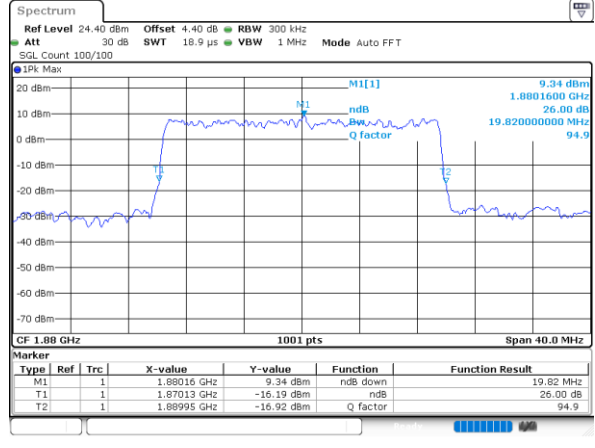
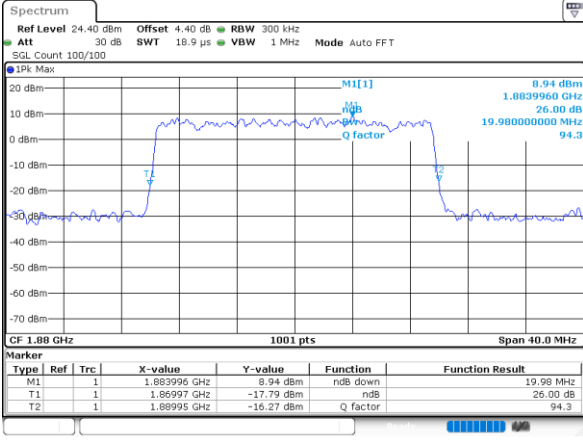

Date: 13, JAN, 2021 19:22:39

Date: 13, JAN, 2021 19:22:58

64QAM

256QAM

Middle Channel

Middle Channel

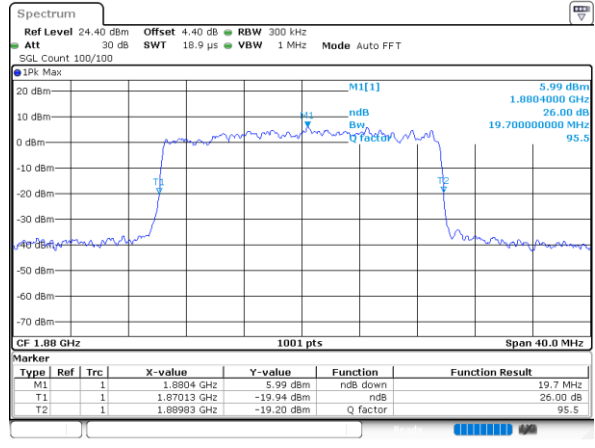
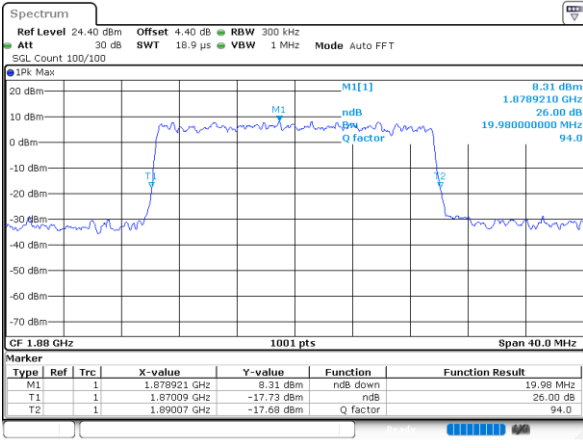

Date: 13, JAN, 2021 19:23:16

Date: 13, JAN, 2021 19:23:33



Occupied Bandwidth

Mode	FR1 n2 : OBW(MHz) / CP-OFDM							
BW	5MHz	5MHz	5MHz	5MHz				
Mod.	QPSK	16QAM	64QAM	256QAM				
Middle CH	4.50	4.47	4.52	4.48				

Mode	FR1 n2 : OBW(MHz) / CP-OFDM							
BW	10MHz	10MHz	10MHz	10MHz				
Mod.	QPSK	16QAM	64QAM	256QAM				
Middle CH	9.29	9.29	9.31	9.25				

Mode	FR1 n2 : OBW(MHz) / CP-OFDM							
BW	15MHz	15MHz	15MHz	15MHz				
Mod.	QPSK	16QAM	64QAM	256QAM				
Middle CH	14.18	14.15	14.12	14.06				

Mode	FR1 n2 : OBW(MHz) / CP-OFDM							
BW	20MHz	20MHz	20MHz	20MHz				
Mod.	QPSK	16QAM	64QAM	256QAM				
Middle CH	18.98	18.90	18.94	18.90				

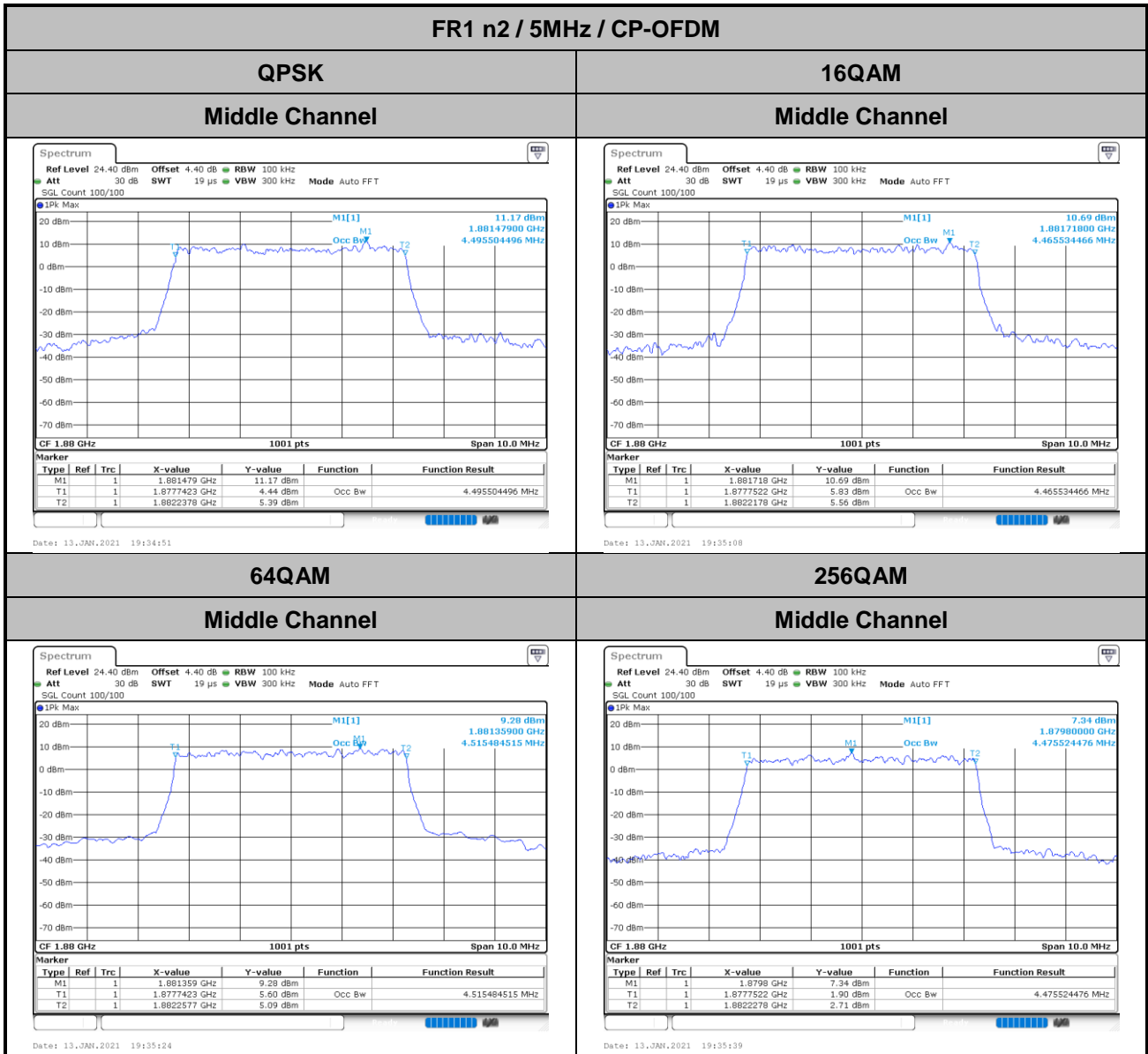

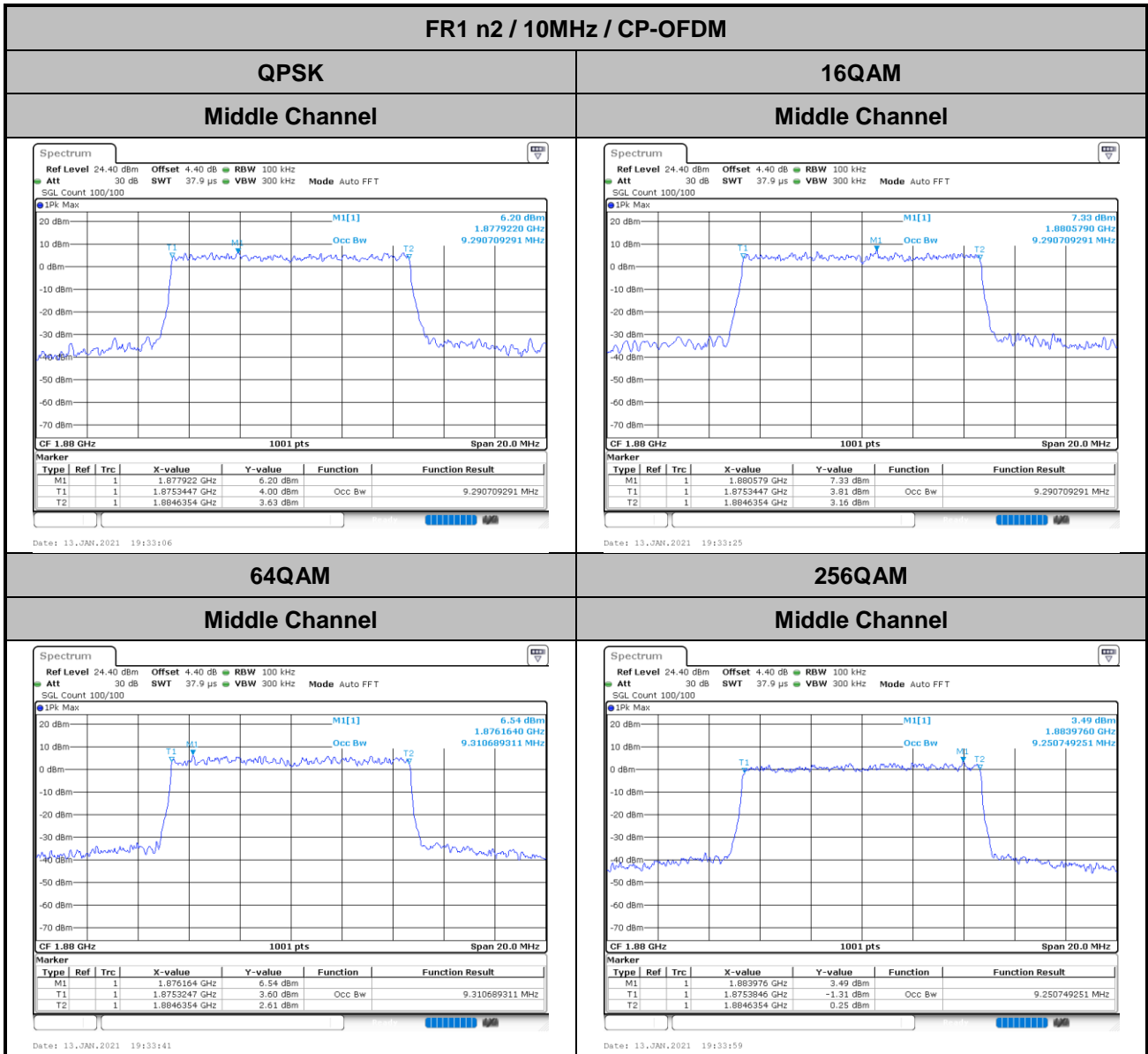

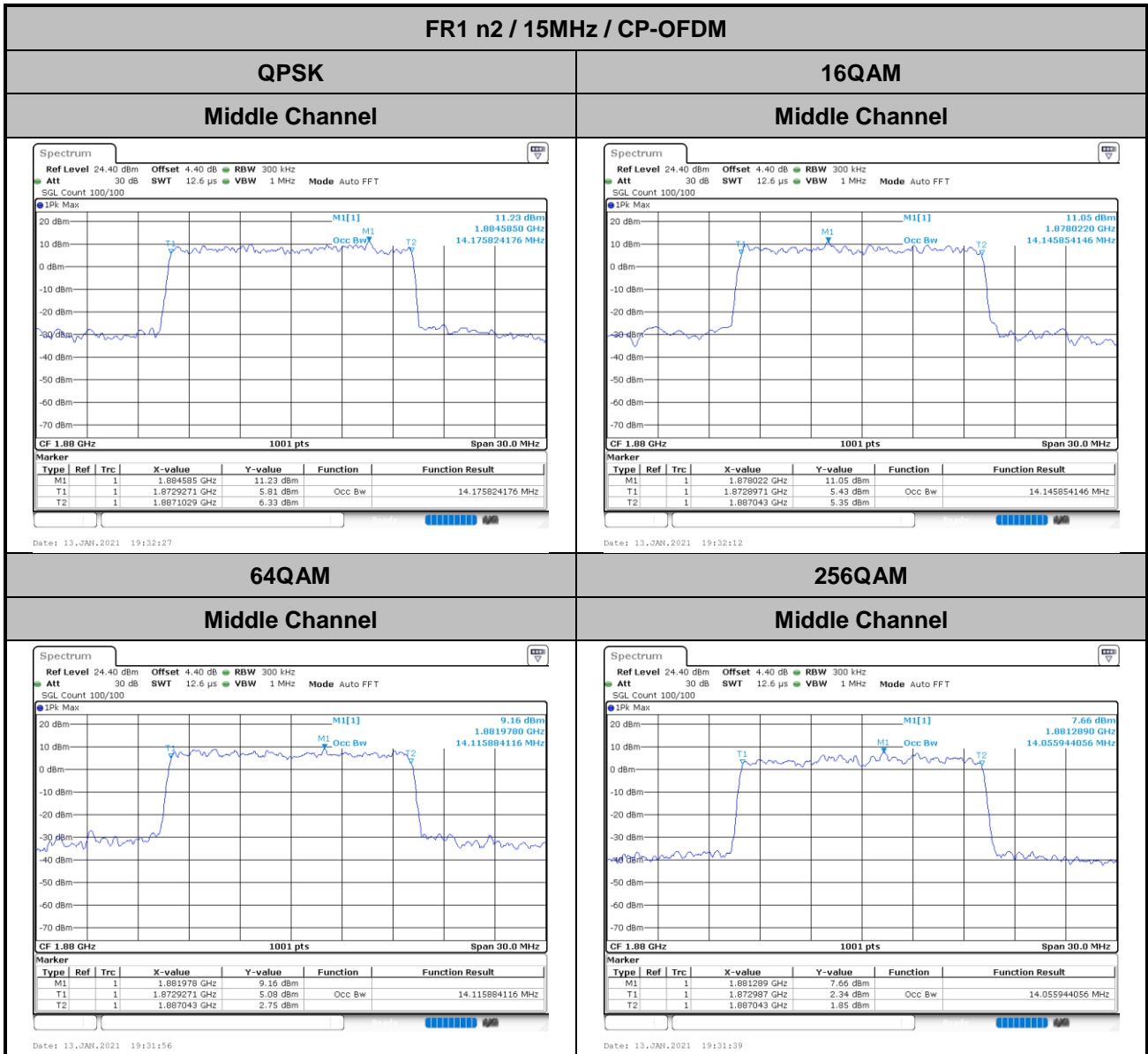



FR1 n2 / 20MHz / CP-OFDM

QPSK

16QAM

Middle Channel

Middle Channel

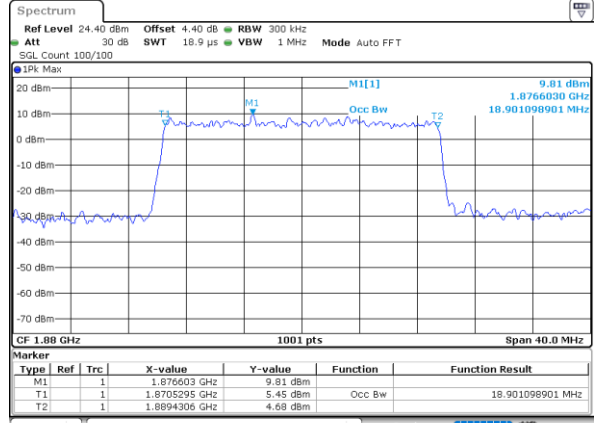
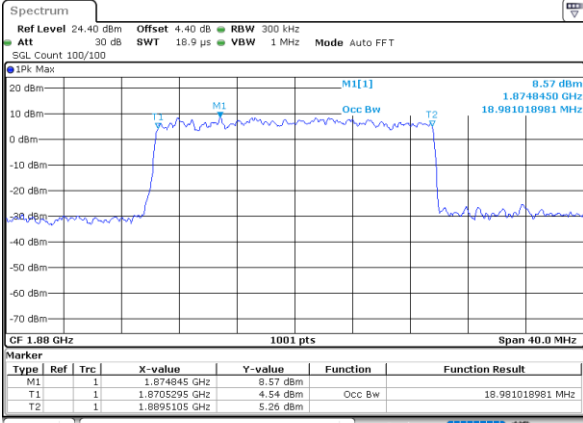

Date: 13_JAN.2021 19:22:33

Date: 13_JAN.2021 19:22:52

64QAM

256QAM

Middle Channel

Middle Channel

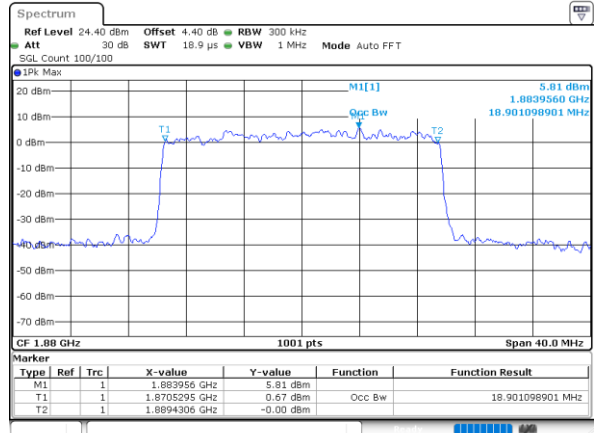
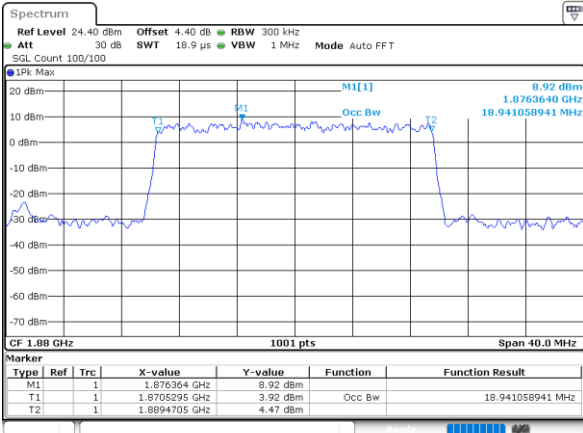

Date: 13_JAN.2021 19:23:11

Date: 13_JAN.2021 19:23:28



Conducted Band Edge

FR1 n2 / 5MHz / DFT-S OFDM BPSK

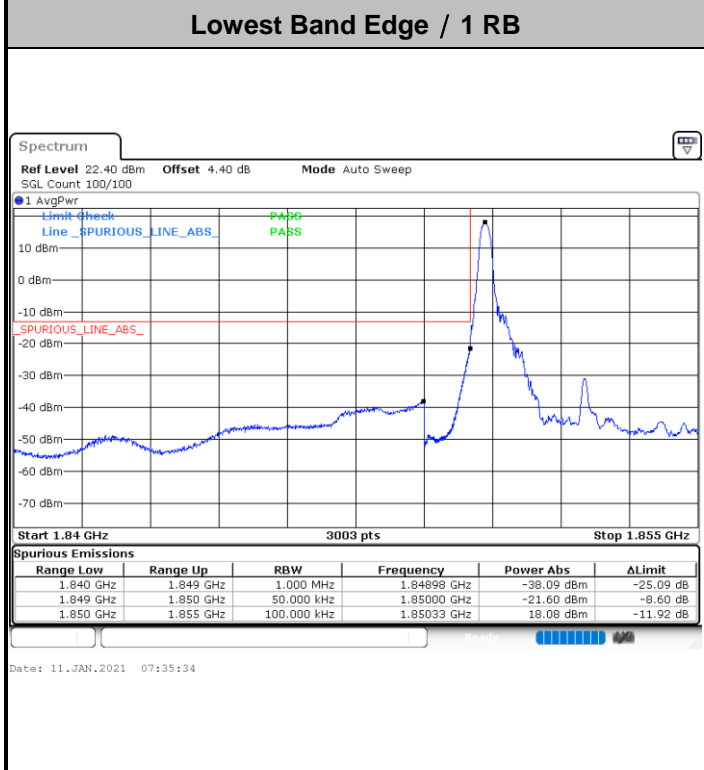

Channel Power < -13dBm Pass

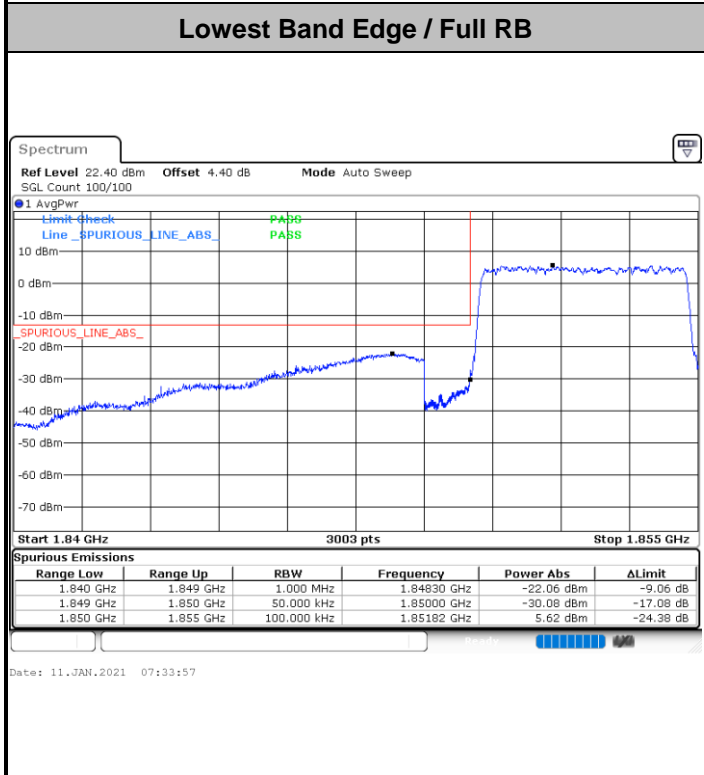

Channel Power < -13dBm Pass



FR1 n2 / 5MHz / DFT-S OFDM BPSK

Highest Band Edge / 1 RB

Channel Power < -13dBm Pass

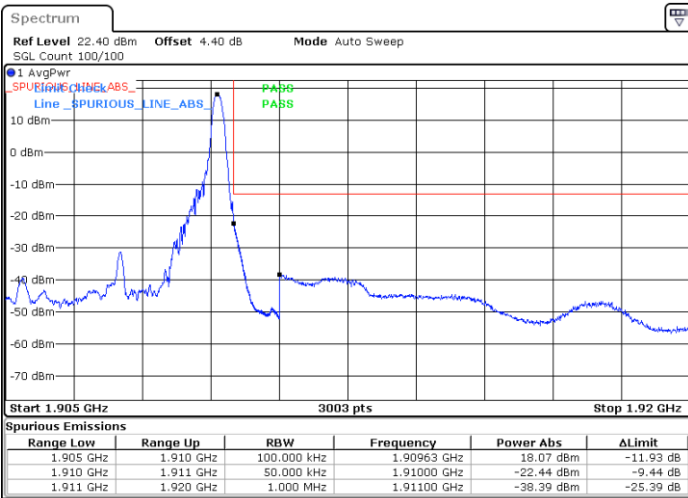

Date: 11.JAN.2021 07:31:06

Highest Band Edge / Full RB

Channel Power < -13dBm Pass

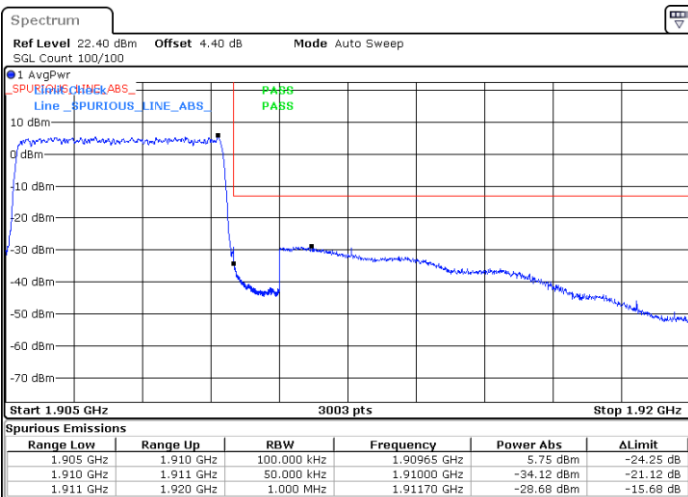

Date: 11.JAN.2021 07:32:22



FR1 n2 / 5MHz / DFT-S OFDM QPSK

Lowest Band Edge / 1 RB

Channel Power < -13dBm Pass

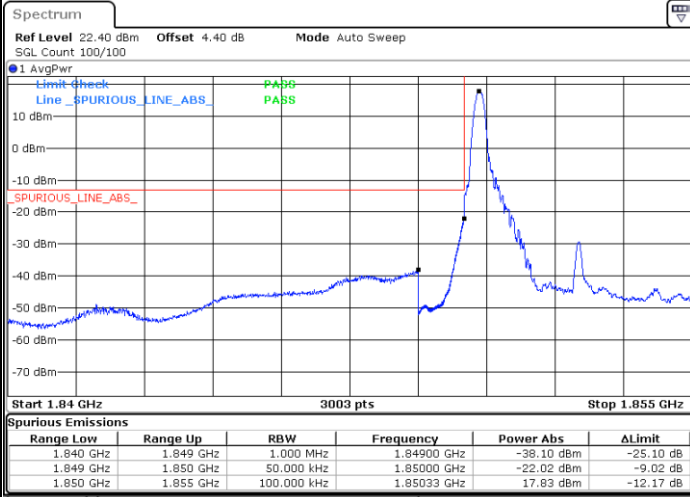

Date: 11.JAN.2021 07:35:08

Lowest Band Edge / Full RB

Channel Power < -13dBm Pass

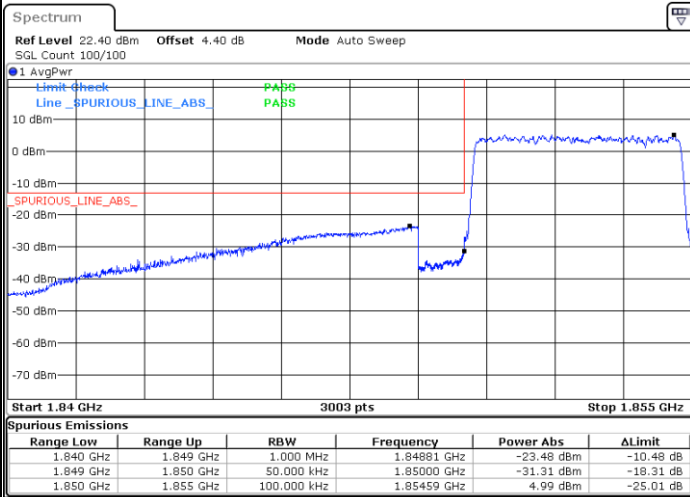

Date: 11.JAN.2021 07:34:43



FR1 n2 / 5MHz / DFT-S OFDM QPSK

Highest Band Edge / 1 RB

Channel Power < -13dBm Pass

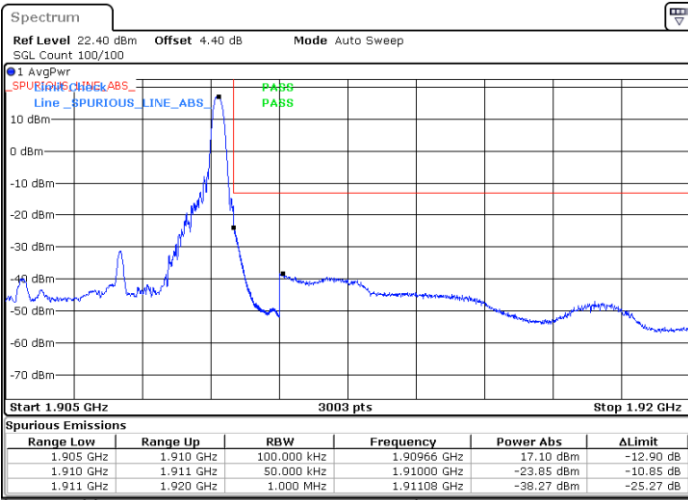

Date: 11.JAN.2021 07:31:32

Highest Band Edge / Full RB

Channel Power < -13dBm Pass

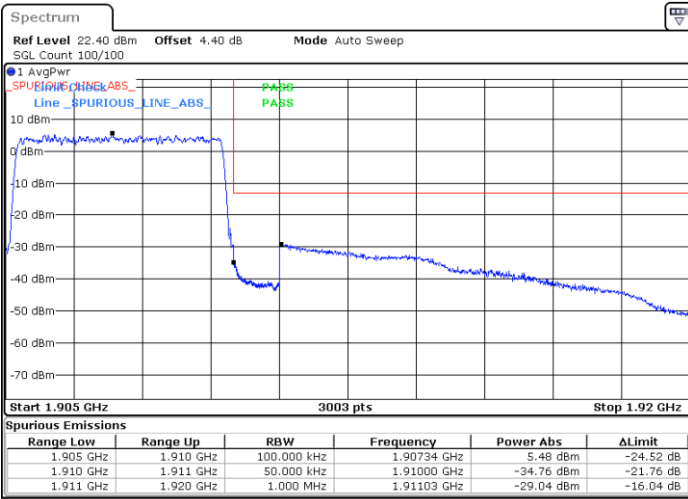

Date: 11.JAN.2021 07:31:57



FR1 n2 / 10MHz / DFT-S OFDM BPSK

Lowest Band Edge / 1 RB

Channel Power < -13dBm Pass

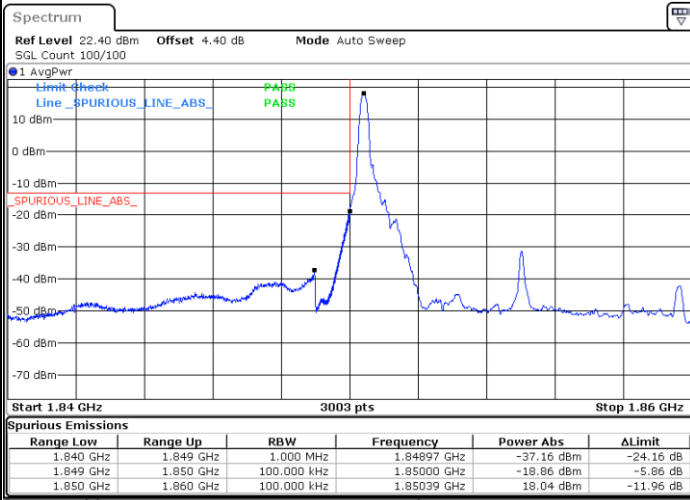

Date: 11.JAN.2021 07:12:48

Lowest Band Edge / Full RB

Channel Power < -13dBm Pass

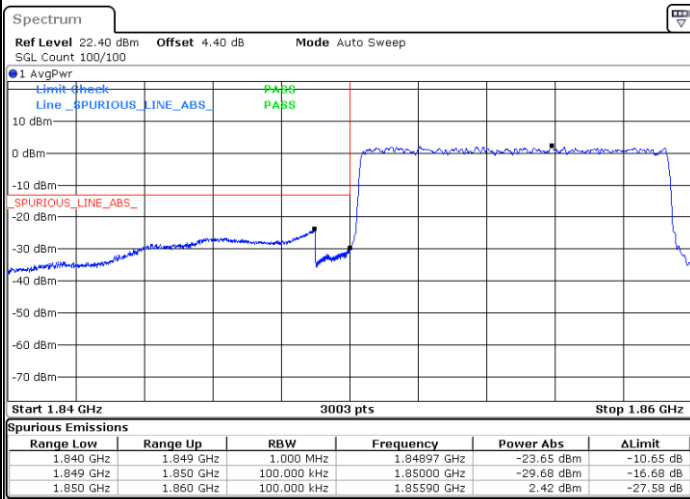

Date: 11.JAN.2021 07:11:54



FR1 n2 / 10MHz / DFT-S OFDM BPSK

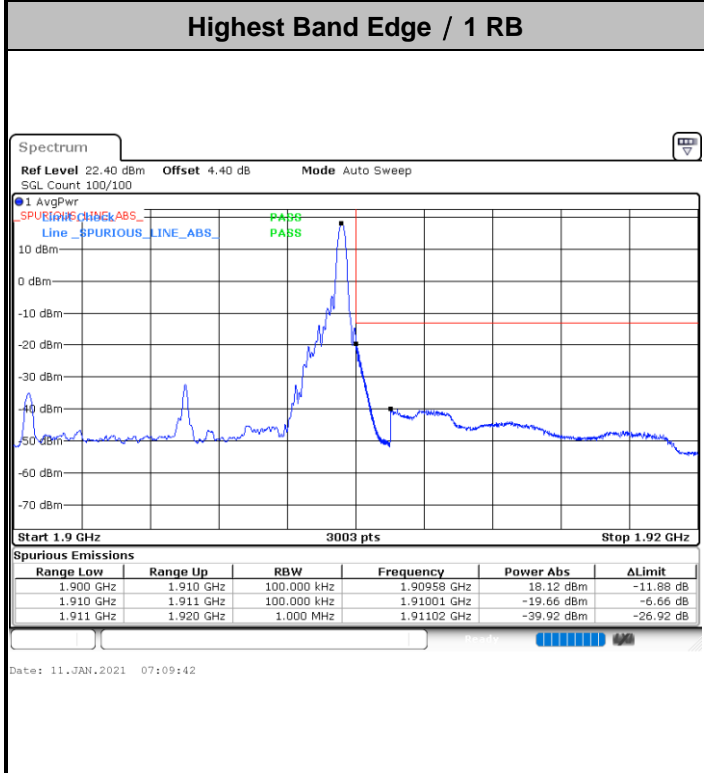

Channel Power < -13dBm Pass

/

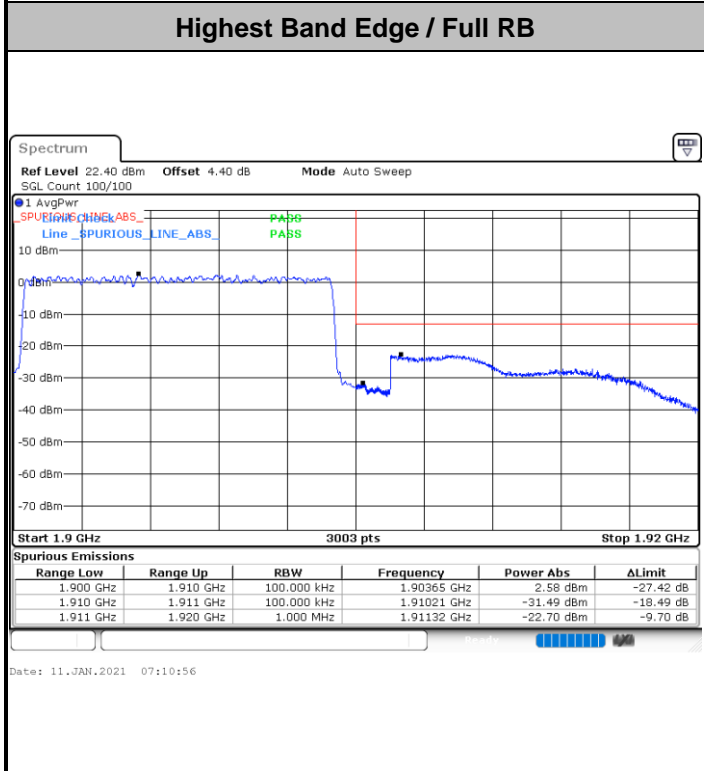

Channel Power < -13dBm Pass

/



FR1 n2 / 10MHz / DFT-S OFDM QPSK

Lowest Band Edge / 1 RB

Channel Power < -13dBm Pass

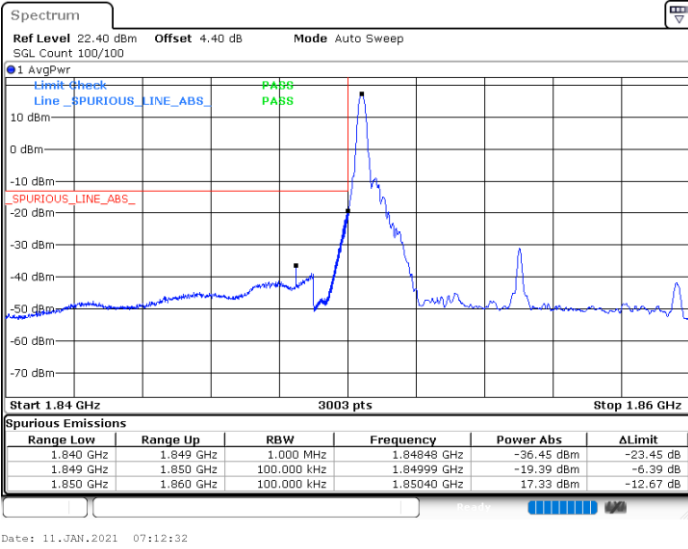

/

Lowest Band Edge / Full RB

Channel Power < -13dBm Pass

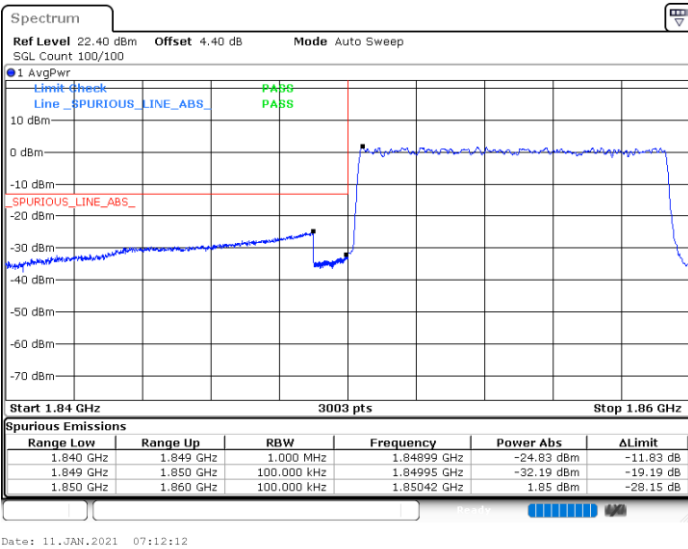

/



FR1 n2 / 10MHz / DFT-S OFDM QPSK

Highest Band Edge / 1 RB

Channel Power < -13dBm Pass

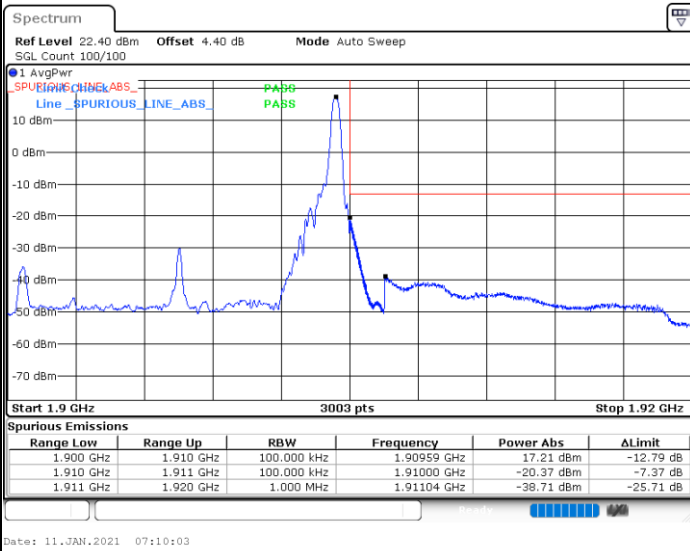

/

Highest Band Edge / Full RB

Channel Power < -13dBm Pass

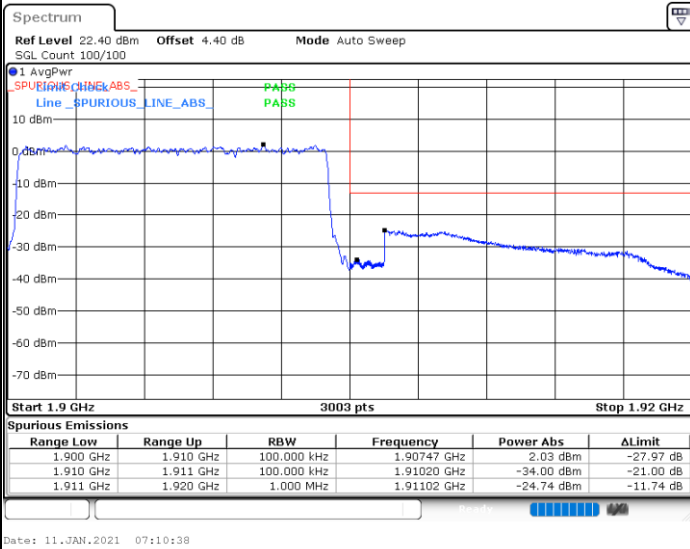

/



FR1 n2 / 20MHz / DFT-S OFDM BPSK

Lowest Band Edge / 1 RB

Channel Power < -13dBm Pass

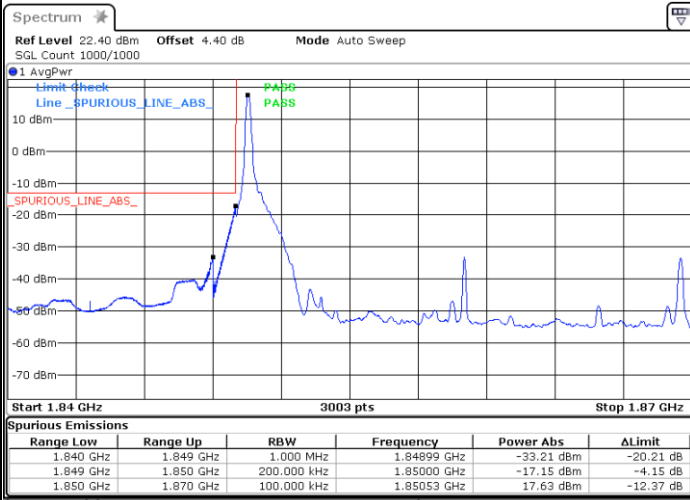

Date: 11.JAN.2021 06:54:39

Lowest Band Edge / Full RB

Channel Power < -13dBm Pass

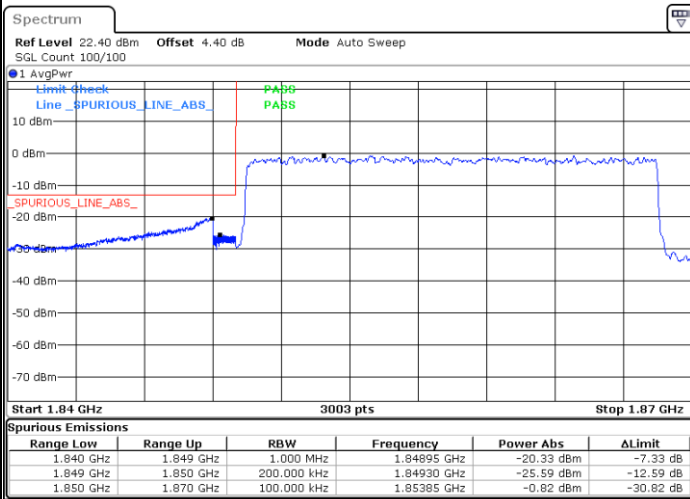

Date: 11.JAN.2021 06:53:51



FR1 n2 / 20MHz / DFT-S OFDM BPSK

Highest Band Edge / 1 RB

Channel Power < -13dBm Pass

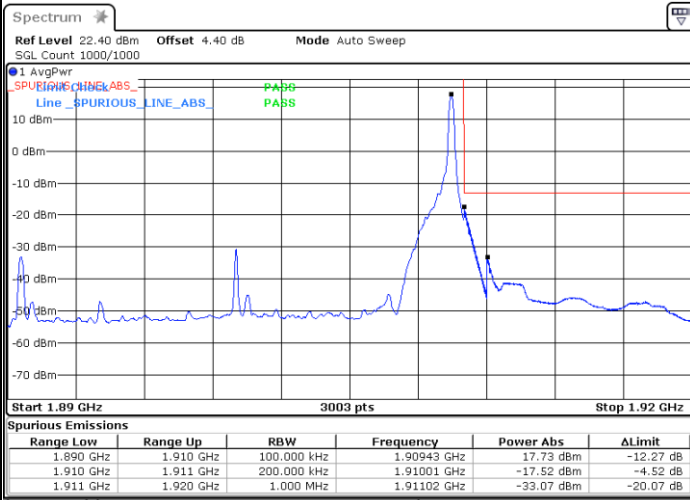

Date: 11.JAN.2021 06:50:07

Highest Band Edge / Full RB

Channel Power < -13dBm Pass

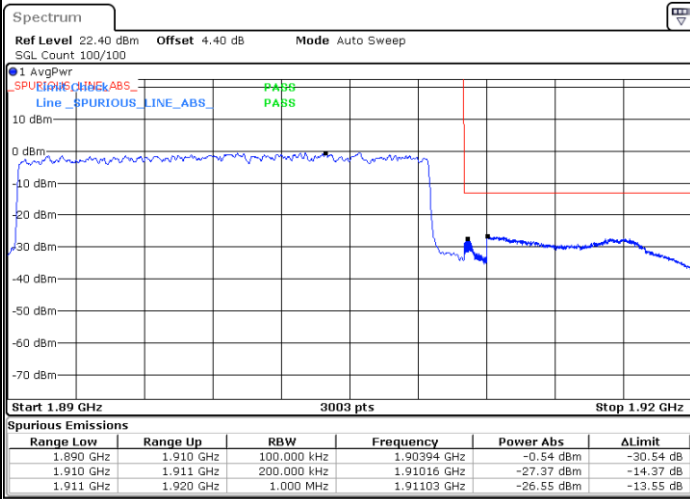

Date: 11.JAN.2021 06:50:31



FR1 n2 / 20MHz / DFT-S OFDM QPSK

Lowest Band Edge / 1 RB

Channel Power < -13dBm Pass

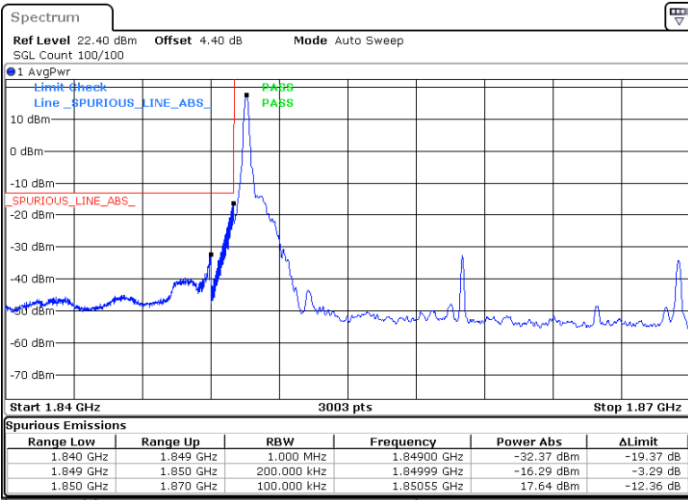

Date: 11.JAN.2021 06:55:05

Lowest Band Edge / Full RB

Channel Power < -13dBm Pass

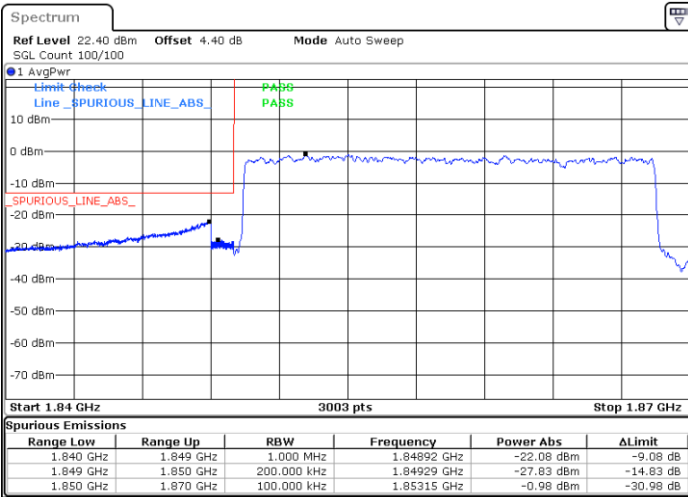

Date: 11.JAN.2021 06:53:36



FR1 n2 / 20MHz / DFT-S OFDM QPSK

Highest Band Edge / 1 RB

Channel Power < -13dBm Pass

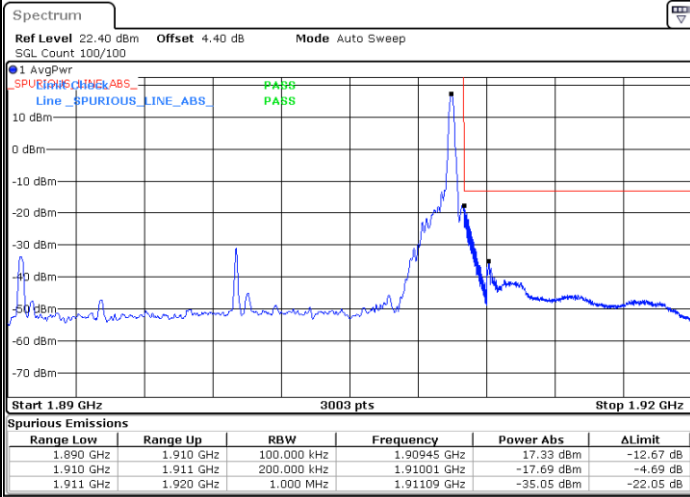

Date: 11.JAN.2021 06:49:15

Highest Band Edge / Full RB

Channel Power < -13dBm Pass

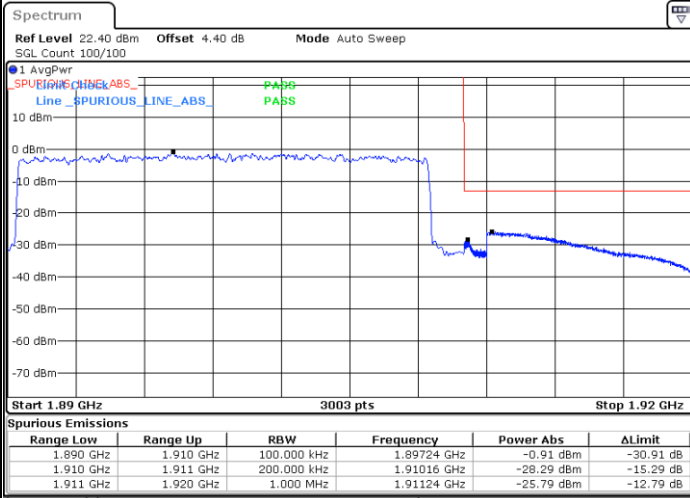

Date: 11.JAN.2021 06:50:49



Conducted Spurious Emission

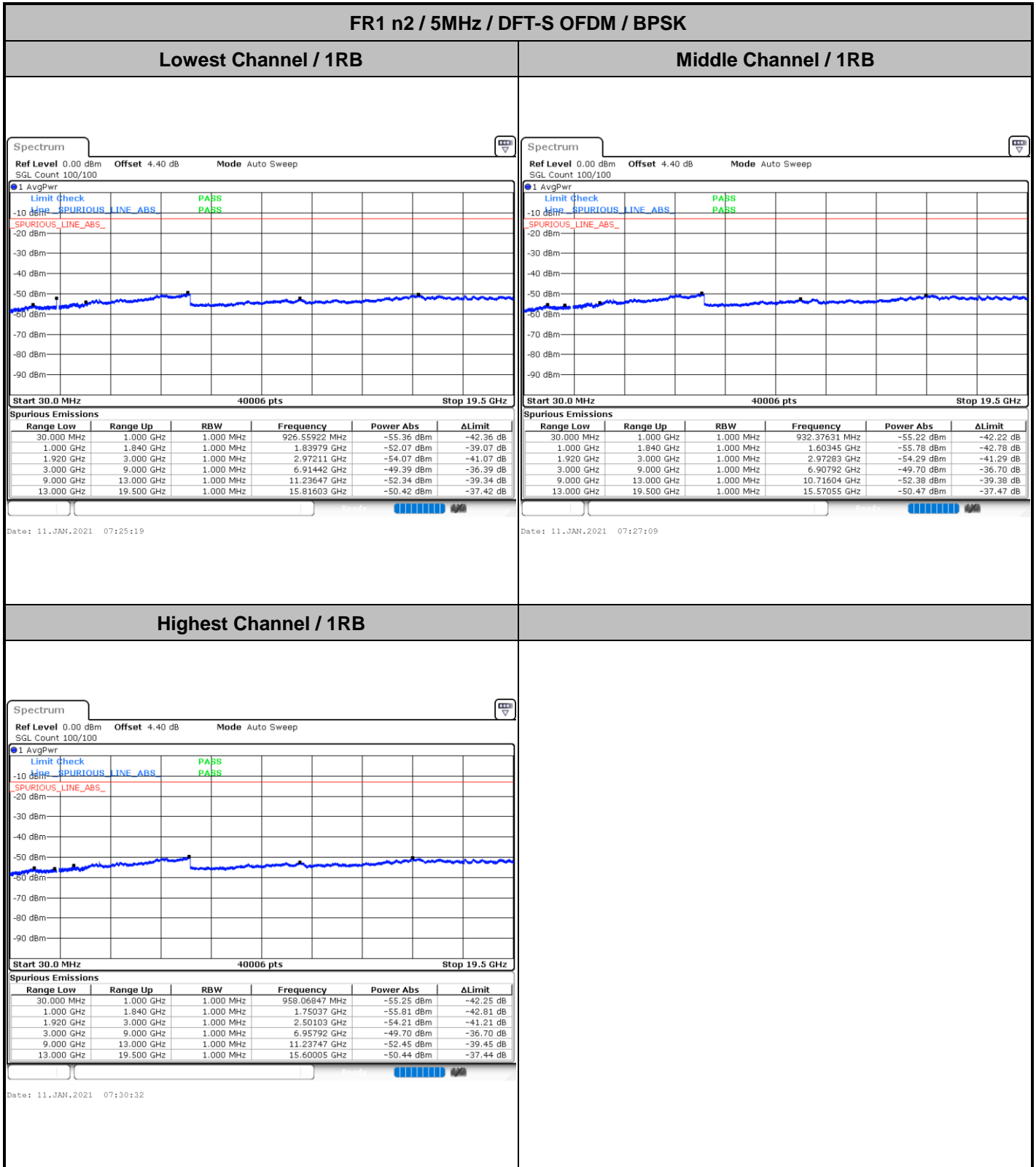



FR1 n2 / 5MHz / DFT-S OFDM / QPSK

Lowest Channel / 1RB

Middle Channel / 1RB

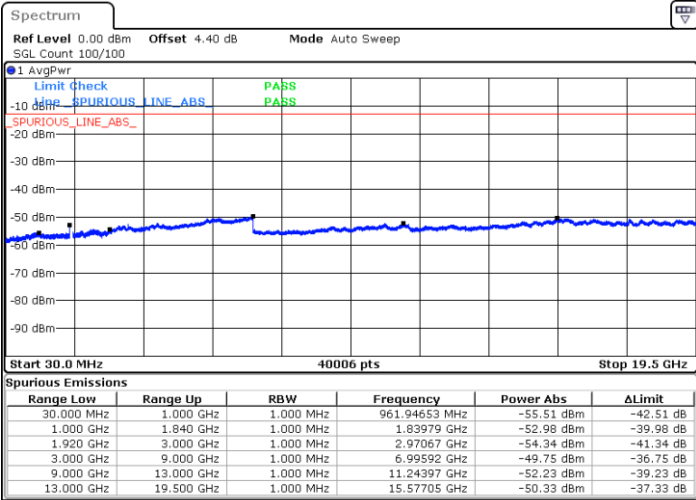

Date: 11.JAN.2021 07:23:47

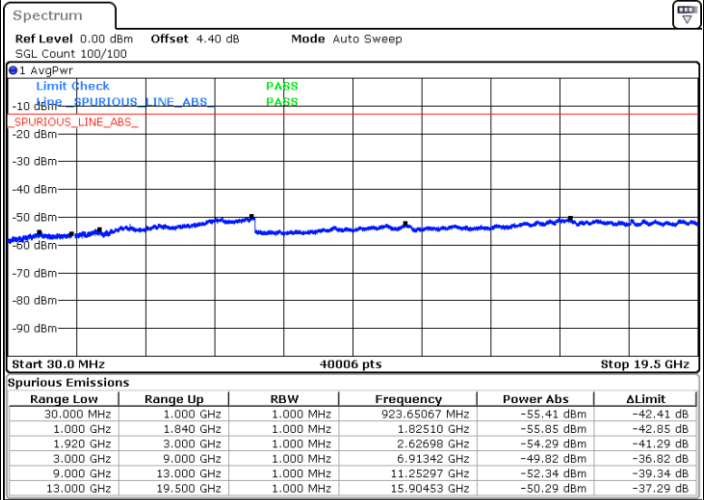

Date: 11.JAN.2021 07:27:58

Highest Channel / 1RB

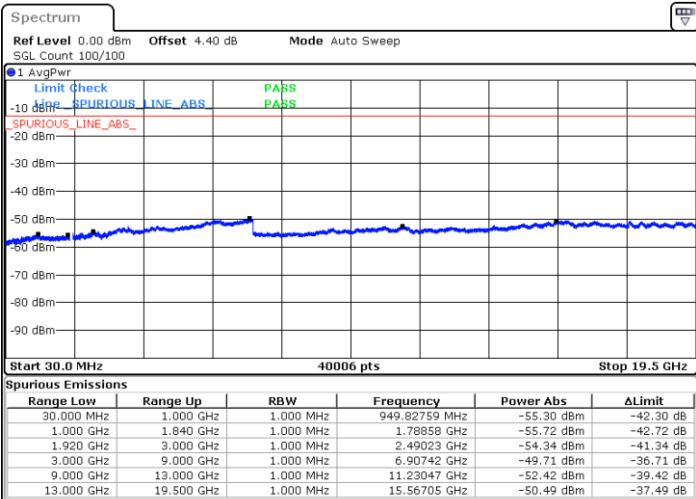

Date: 11.JAN.2021 07:29:44



FR1 n2 / 10MHz / DFT-S OFDM / BPSK

Lowest Channel / 1RB

Middle Channel / 1RB

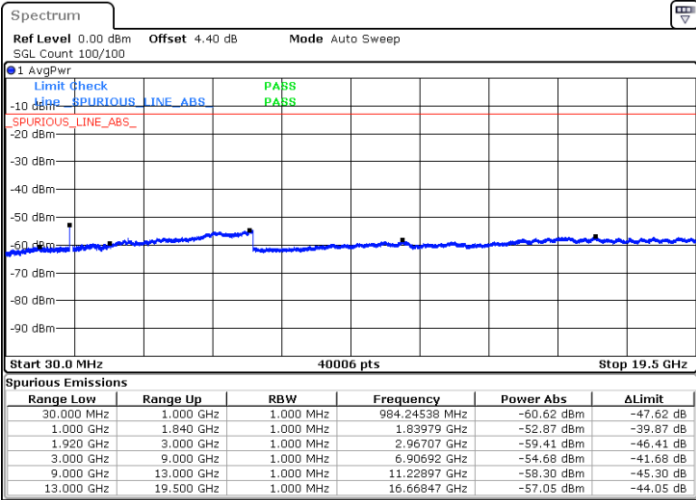

Date: 11.JAN.2021 07:03:36

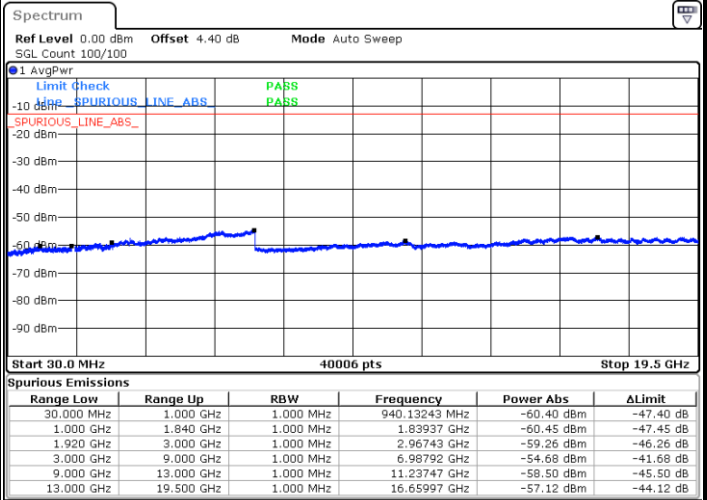

Date: 11.JAN.2021 07:05:14

Highest Channel / 1RB

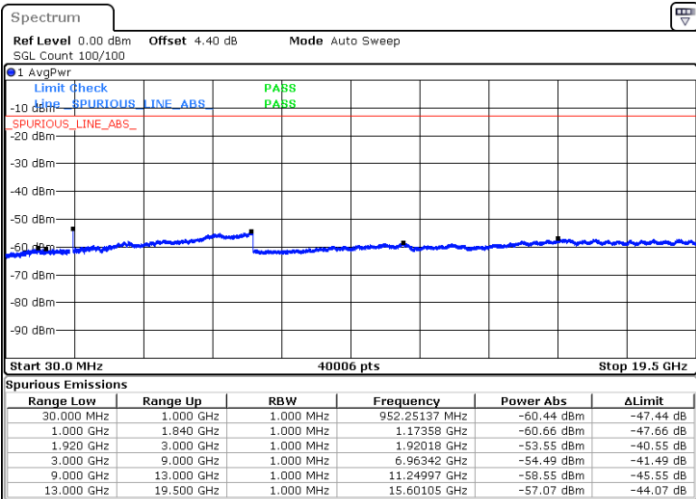

Date: 11.JAN.2021 07:09:12



FR1 n2 / 10MHz / DFT-S OFDM / QPSK

Lowest Channel / 1RB

Middle Channel / 1RB

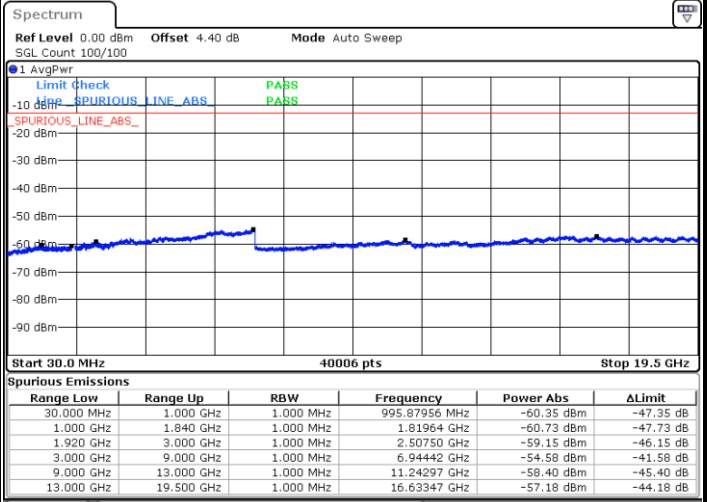
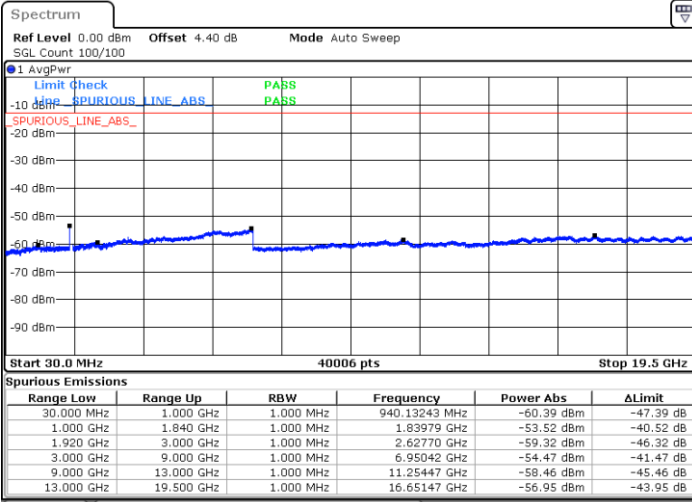

Date: 11.JAN.2021 07:02:02

Date: 11.JAN.2021 07:06:08

Highest Channel / 1RB

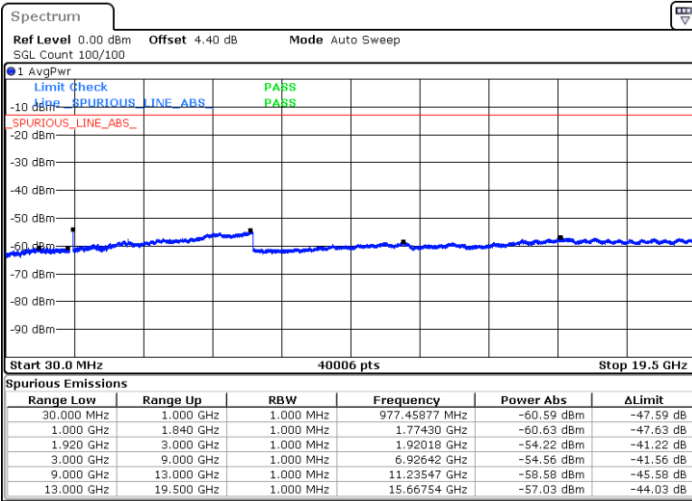

Date: 11.JAN.2021 07:08:26



FR1 n2 / 20MHz / DFT-S OFDM / BPSK

Lowest Channel / 1RB

Middle Channel / 1RB

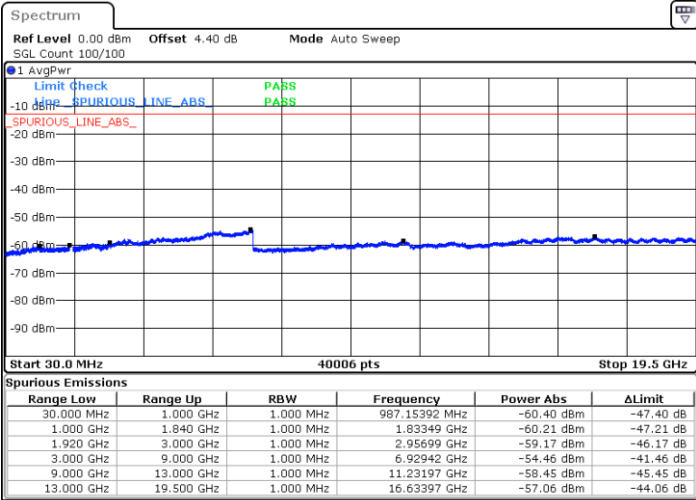

Date: 11.JAN.2021 06:42:57

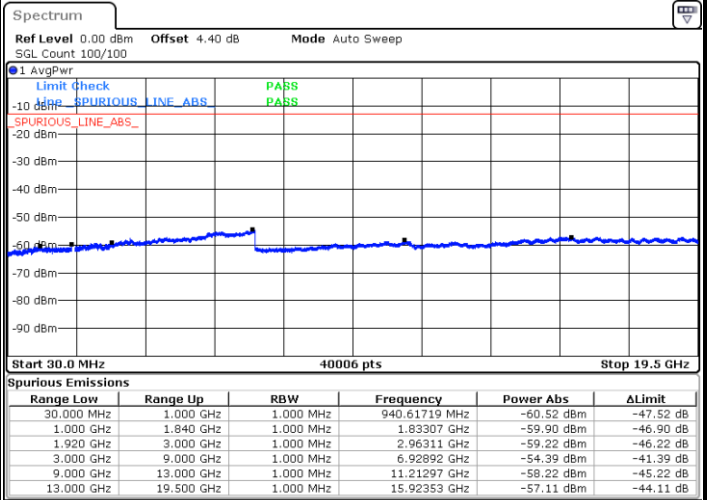

Date: 11.JAN.2021 06:46:22

Highest Channel / 1RB

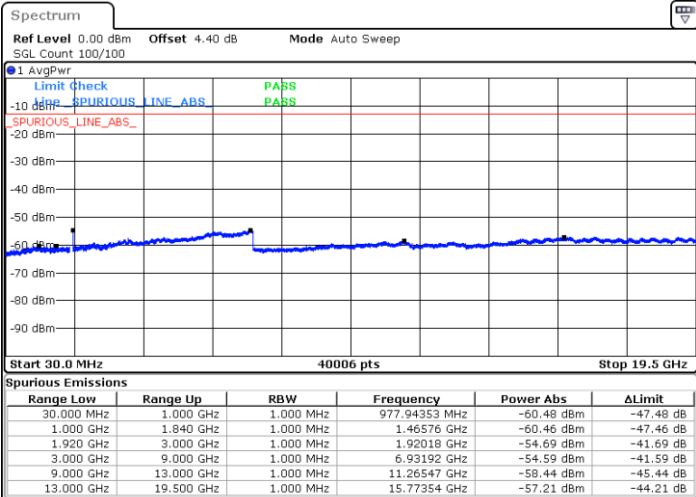

Date: 11.JAN.2021 06:48:05



FR1 n2 / 20MHz / DFT-S OFDM / QPSK

Lowest Channel / 1RB

Middle Channel / 1RB

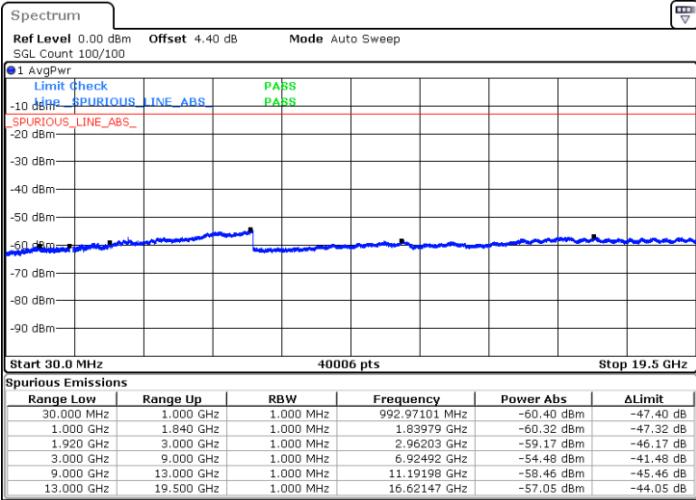

Date: 11.JAN.2021 06:44:49

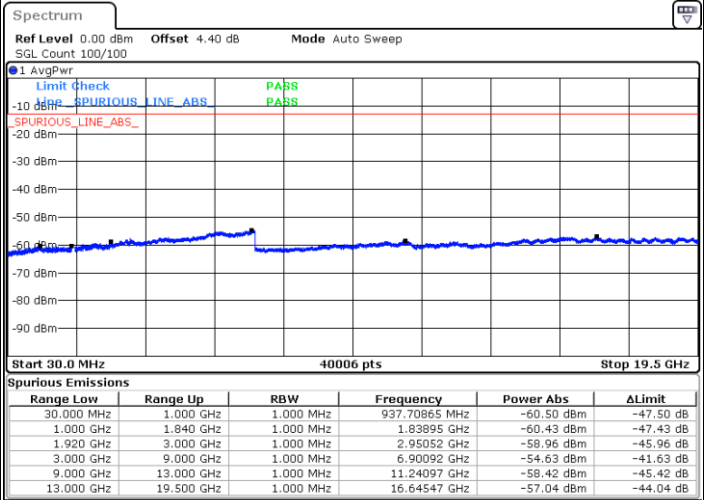

Date: 11.JAN.2021 06:45:37

Highest Channel / 1RB

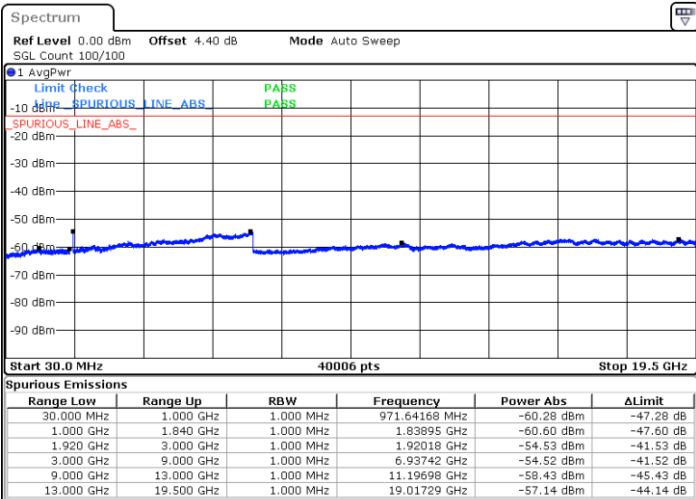

Date: 11.JAN.2021 06:48:51



Frequency Stability

Test Conditions		NR n2 (BPSK) / Middle Channel	Limit
Temperature (°C)	Voltage (Volt)	BW 20MHz	Within Band
		Deviation (ppm)	Result
50	Normal Voltage	0.0015	PASS
40	Normal Voltage	0.0017	
30	Normal Voltage	0.0012	
20(Ref.)	Normal Voltage	0.0013	
10	Normal Voltage	0.0018	
0	Normal Voltage	0.0012	
-10	Normal Voltage	0.0019	
-20	Normal Voltage	0.0015	
-30	Normal Voltage	0.0011	
20	Maximum Voltage	0.0019	
20	Normal Voltage	0.0015	
20	Battery End Point	0.0011	

Note:

1. Normal Voltage =3.3 V. ; Battery End Point (BEP) =3.14 V. ; Maximum Voltage =4.4 V.
2. Note: The frequency fundamental emissions stay within the authorized frequency block.



FR1 n2 NSA

Peak-to-Average Ratio

Mode	FR1 n2+5A / 20MHz / DFT-S OFDM				
Mod.	PI/2 BPSK	PI/2 BPSK	QPSK	QPSK	Limit: 13dB
RB Size	1RB	Full RB	1RB	Full RB	Result
Lowest CH	3.30	4.49	4.99	5.77	PASS
Middle CH	3.65	4.03	5.48	5.59	
Highest CH	3.57	3.59	5.39	5.04	