

FCC Radio Test Report

FCC ID: 2AJN7-TP00143AL

Report No. : BTL-FCCP-12-2112T127
Equipment : Notebook Computer
Model Name : TP00143AL
Brand Name : Lenovo
Applicant : LC Future Center
Address : 7F., No. 780, Beian Rd., Zhongshan Dist., Taipei City 104, Taiwan
Manufacturer : Lenovo PC HK Limited
Address : 23/F, Lincoln House, Taikoo Place 979 King's Road, Quarry Bay, Hong Kong, P.R. China

Radio Function : WCDMA Band II, LTE Band 2, 25

FCC Rule Part(s) : FCC CFR Title 47, Part 24, Subpart E
Measurement : ANSI C63.26-2015
Procedure(s) : ANSI/TIA-603-E-2016
FCC KDB 971168 D01 Power Meas License Digital Systems v03r01

Date of Receipt : 2022/1/13
Date of Test : 2022/1/13 ~ 2022/3/11
Issued Date : 2022/3/31

The above equipment has been tested and found in compliance with the requirement of the above standards by BTL Inc.

Prepared by : Eric Lee
Eric Lee, Engineer

Approved by : Jerry Chuang
Jerry Chuang, Supervisor

**BTL Inc.**

No.18, Ln. 171, Sec. 2, Jiuzong Rd., Neihu Dist., Taipei City 114, Taiwan

Tel: +886-2-2657-3299

Fax: +886-2-2657-3331

Web: www.newbtl.com

Declaration

BTL represents to the client that testing is done in accordance with standard procedures as applicable and that test instruments used has been calibrated with standards traceable to international standard(s) and/or national standard(s).

BTL's reports apply only to the specific samples tested under conditions. It is manufacture's responsibility to ensure that additional production units of this model are manufactured with the identical electrical and mechanical components. **BTL** shall have no liability for any declarations, inferences or generalizations drawn by the client or others from **BTL** issued reports.

This report is the confidential property of the client. As a mutual protection to the clients, the public and ourselves, the test report shall not be reproduced, except in full, without our written approval.

BTL's laboratory quality assurance procedures are in compliance with the **ISO/IEC 17025** requirements, and accredited by the conformity assessment authorities listed in this test report.

BTL is not responsible for the sampling stage, so the results only apply to the sample as received.

The information, data and test plan are provided by manufacturer which may affect the validity of results, so it is manufacturer's responsibility to ensure that the apparatus meets the essential requirements of applied standards and in all the possible configurations as representative of its intended use.

Limitation

For the use of the authority's logo is limited unless the Test Standard(s)/Scope(s)/Item(s) mentioned in this test report is (are) included in the conformity assessment authorities acceptance respective.

Please note that the measurement uncertainty is provided for informational purpose only and are not use in determining the Pass/Fail results.

CONTENTS

| | | |
|------------|--|----|
| 1 | SUMMARY OF TEST RESULTS | 5 |
| 1.1 | TEST FACILITY | 6 |
| 1.2 | MEASUREMENT UNCERTAINTY | 6 |
| 1.3 | TEST ENVIRONMENT CONDITIONS | 6 |
| 2 | GENERAL INFORMATION | 7 |
| 2.1 | DESCRIPTION OF EUT | 7 |
| 2.2 | TEST MODES | 8 |
| 2.3 | BLOCK DIAGRAM SHOWING THE CONFIGURATION OF SYSTEM TESTED | 9 |
| 2.4 | SUPPORT UNITS | 9 |
| 3 | AC POWER LINE CONDUCTED EMISSIONS TEST | 10 |
| 3.1 | LIMIT | 10 |
| 3.2 | TEST PROCEDURE | 10 |
| 3.3 | DEVIATION FROM TEST STANDARD | 10 |
| 3.4 | TEST SETUP | 11 |
| 3.5 | TEST RESULT | 11 |
| 4 | EFFECTIVE ISOTROPICAL RADIATED POWER MEASUREMENT | 12 |
| 4.1 | LIMIT | 12 |
| 4.2 | TEST PROCEDURE | 12 |
| 4.3 | DEVIATION FROM TEST STANDARD | 12 |
| 4.4 | TEST SETUP | 13 |
| 4.5 | EUT OPERATING CONDITIONS | 13 |
| 4.6 | TEST RESULT | 13 |
| 5 | RADIATED SPURIOUS EMISSIONS MEASUREMENT | 14 |
| 5.1 | LIMIT | 14 |
| 5.2 | TEST PROCEDURE | 14 |
| 5.3 | DEVIATION FROM TEST STANDARD | 14 |
| 5.4 | TEST SETUP | 15 |
| 5.5 | EUT OPERATING CONDITIONS | 15 |
| 5.6 | TEST RESULT | 15 |
| 6 | LIST OF MEASURING EQUIPMENTS | 16 |
| 7 | EUT TEST PHOTO | 17 |
| 8 | EUT PHOTOS | 17 |
| APPENDIX A | AC POWER LINE CONDUCTED EMISSIONS | 18 |
| APPENDIX B | EFFECTIVE ISOTROPIC RADIATED POWER | 23 |
| APPENDIX C | RADIATED SPURIOUS EMISSIONS | 55 |

REVISION HISTORY

| Report No. | Version | Description | Issued Date | Note |
|----------------------|---------|------------------|-------------|-------|
| BTL-FCCP-12-2112T127 | R00 | Original Report. | 2022/3/31 | Valid |

1 SUMMARY OF TEST RESULTS

Test procedures according to the technical standards.

| Standard(s) Section | Description | Test Result | Judgement | Remark |
|---------------------|--|-------------|-----------|--------|
| 15.207 | AC Power Line Conducted Emissions | APPENDIX A | Pass | ----- |
| 2.1046 24.232(c) | Conducted Output Power Effective Isotropic Radiated Power | APPENDIX B | Pass | ----- |
| 24.232(d) | Peak To Average Ratio | NOTE (3) | Pass | ----- |
| 2.1049 | Occupied Bandwidth | NOTE (3) | Pass | ----- |
| 24.238(a) | Band Edge Measurements | NOTE (3) | Pass | ----- |
| 2.1051 24.238(a) | Conducted Spurious Emissions | NOTE (3) | Pass | ----- |
| 2.1055 24.235 | Frequency Stability Temperature & Voltage | NOTE (3) | Pass | ----- |
| 2.1053 24.238(a) | Radiated Spurious Emissions | APPENDIX C | Pass | ----- |

NOTE:

- (1) "N/A" denotes test is not applicable in this Test Report.
- (2) The report format version is TP.1.1.1.
- (3) This item is demonstrated to full compliance referring to the test report number FG003022A, FG003022B of the integrated module (model name: L860-GL-16, FCC ID: ZMOL860GL16), according to KDB 996369 D02 Q1 a) 2).
- (4) The ac power lines conducted emissions and radiated emissions are tested to demonstrate full compliance of both module integrated into the host and host itself.

1.1 TEST FACILITY

The test facilities used to collect the test data in this report:

No. 68-1, Ln. 169, Sec. 2, Datong Rd., Xizhi Dist., New Taipei City 221, Taiwan

The test sites and facilities are covered under FCC RN: 355421 and DN: TW1099.

- C05 CB08 CB11 CB15 CB16
 SR05

1.2 MEASUREMENT UNCERTAINTY

The reported uncertainty of measurement $y \pm U$, where expanded uncertainty U is based on a standard uncertainty multiplied by a coverage factor of $k = 2$, providing a level of confidence of approximately **95 %**. The measurement instrumentation uncertainty considerations contained in CISPR 16-4-2. The BTL measurement uncertainty is less than the CISPR 16-4-2 U_{cispr} requirement.

A. AC power line conducted emissions test:

| Test Site | Method | Measurement Frequency Range | U (dB) |
|-----------|--------|-----------------------------|--------|
| C05 | CISPR | 150 kHz ~ 30MHz | 3.44 |

B. Effective Isotropic Radiated Power and Radiated emissions test :

| Test Site | Measurement Frequency Range | U,(dB) |
|-----------|-----------------------------|--------|
| CB15 | 0.03 GHz ~ 0.2 GHz | 4.17 |
| | 0.2 GHz ~ 1 GHz | 4.72 |
| | 1 GHz ~ 6 GHz | 5.21 |
| | 6 GHz ~ 18 GHz | 5.51 |
| | 18 GHz ~ 26 GHz | 3.69 |
| | 26 GHz ~ 40 GHz | 4.23 |

NOTE:

Unless specifically mentioned, the uncertainty of measurement has not been taken into account to declare the compliance or non-compliance to the specification.

1.3 TEST ENVIRONMENT CONDITIONS

| Test Item | Environment Condition | Test Voltage | Tested by |
|------------------------------------|-----------------------|--------------|--------------------------|
| AC Power Line Conducted Emissions | 23 °C, 60 % | AC 120V | Angela Wang |
| Conducted Output Power | 23.5 °C, 58.5 % | AC 120V | William Wei |
| Effective Isotropic Radiated Power | Refer to data | AC 120V | Vincent Lee Eddie Lee |
| Radiated Spurious Emissions | Refer to data | AC 120V | Vincent Lee Eddie Lee |

2 GENERAL INFORMATION

2.1 DESCRIPTION OF EUT

| | | | | | |
|---------------------|---|--------------------|--------------------|-----------|-------|
| Equipment | Notebook Computer | | | | |
| Model Name | TP00143AL | | | | |
| Brand Name | Lenovo | | | | |
| Model Difference | N/A | | | | |
| Power Source | DC voltage supplied from External Power Supply. (Lenovo/ ADL135SLC3A, ADL135SCC2A) | | | | |
| Power Rating | I/P: 100-240V~ 2.5A 50-60Hz O/P: DC20.0V 6.75A 135.0W | | | | |
| WWAN Module | Fibocom / L860-GL-16 | | | | |
| Operation Frequency | Band | UL Frequency (MHz) | DL Frequency (MHz) | | |
| | WCDMA II | 1850 ~ 1910 | 1930 ~ 1990 | | |
| | LTE 2 | 1850 ~ 1910 | 1930 ~ 1990 | | |
| | LTE 25 | 1850 ~ 1915 | 1930 ~ 1995 | | |
| Maximum EIRP | Band | BW (MHz) | Mode | Power (W) | |
| | WCDMA II | - | - | 0.322 | |
| | LTE 2 | 1.4 | - | QPSK | 0.263 |
| | | | | 16QAM | 0.212 |
| | | 3 | - | QPSK | 0.265 |
| | | | | 16QAM | 0.214 |
| | | 5 | - | QPSK | 0.270 |
| | | | | 16QAM | 0.218 |
| | | 10 | - | QPSK | 0.275 |
| | | | | 16QAM | 0.222 |
| | 15 | - | QPSK | 0.278 | |
| | | | 16QAM | 0.224 | |
| | LTE 25 | 1.4 | - | QPSK | 0.256 |
| | | | | 16QAM | 0.207 |
| | | 3 | - | QPSK | 0.259 |
| | | | | 16QAM | 0.209 |
| | | 5 | - | QPSK | 0.264 |
| | | | | 16QAM | 0.213 |
| | | 10 | - | QPSK | 0.268 |
| | | | | 16QAM | 0.216 |
| 15 | - | QPSK | 0.271 | | |
| | | 16QAM | 0.219 | | |
| 20 | - | QPSK | 0.279 | | |
| | | 16QAM | 0.225 | | |
| Test Model | TP00143AL | | | | |
| Sample Status | Engineering Sample | | | | |
| EUT Modification(s) | N/A | | | | |

NOTE:

(1) For a more detailed features description, please refer to the manufacturer's specifications or the user's manual.

(2) Table for Filed Antenna:

| Antenna | Manufacture | Parts Number | Type | Connector | Gain (dBi) | Note |
|---------|-------------|--------------|------|-----------|------------|---------------|
| Main | AWAN | DC33001WF00 | PIFA | I-PEX | 0.69 | WCDMA Band II |
| | | | | | 0.57 | LTE Band 2 |
| Aux | AWAN | DC33001WF10 | PIFA | I-PEX | - | LTE Band 25 |
| | | | | | | RX only |

2.2 TEST MODES

| Test Items | Band | Test Mode | Note |
|------------------------------------|---------------|--------------------------------|------|
| AC Power Line Conducted Emissions | - | Normal/Idle | - |
| Conducted Output Power | WCDMA Band II | Refer to APPENDIX B | - |
| | LTE Band 2 | | |
| | LTE Band 25 | | |
| Effective Isotropic Radiated Power | WCDMA Band II | TX Mode (CH 9262/9400/9538) | - |
| | LTE Band 2 | TX Mode (CH 18700/18900/19100) | - |
| | LTE Band 25 | TX Mode (CH 26140/26365/26590) | - |
| Radiated Spurious Emissions | WCDMA Band II | TX Mode (CH 9400) | - |
| | LTE Band 2 | TX Mode (CH 18900) | - |
| | LTE Band 25 | TX Mode (CH 26365) | - |

NOTE:

- (1) All X, Y and Z axes are evaluated, but only the worst case (Y axis) is recorded.
- (2) For Radiated Spurious Emissions both QPSK and 16QAM are evaluated, but only the worst case (QPSK) is recorded.

2.3 BLOCK DIAGRAM SHOWING THE CONFIGURATION OF SYSTEM TESTED

Equipment letters and Cable numbers refer to item numbers described in the tables of clause 2.4.

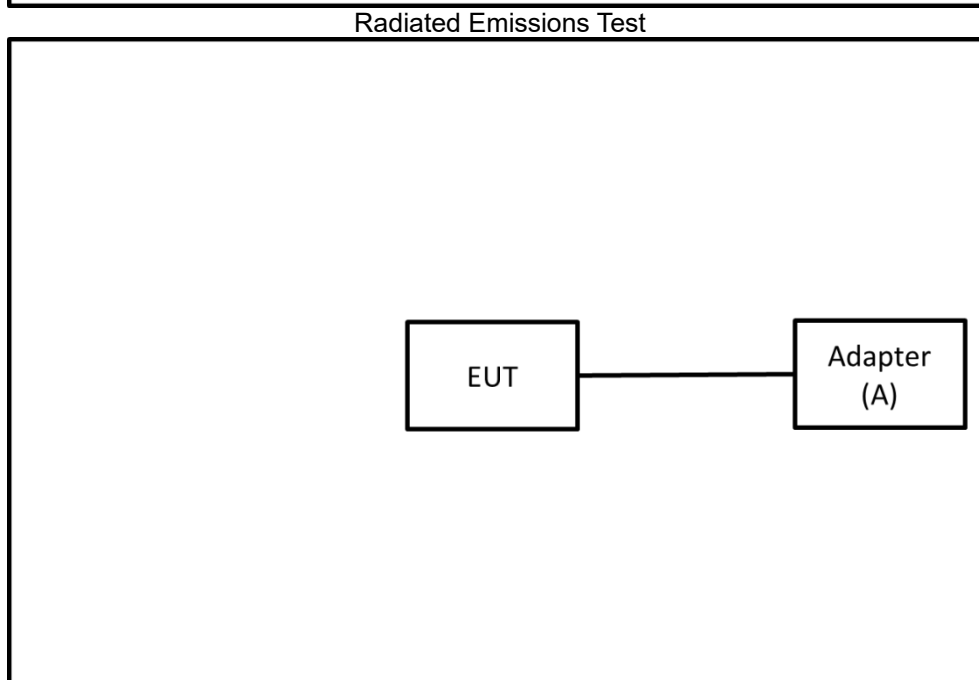
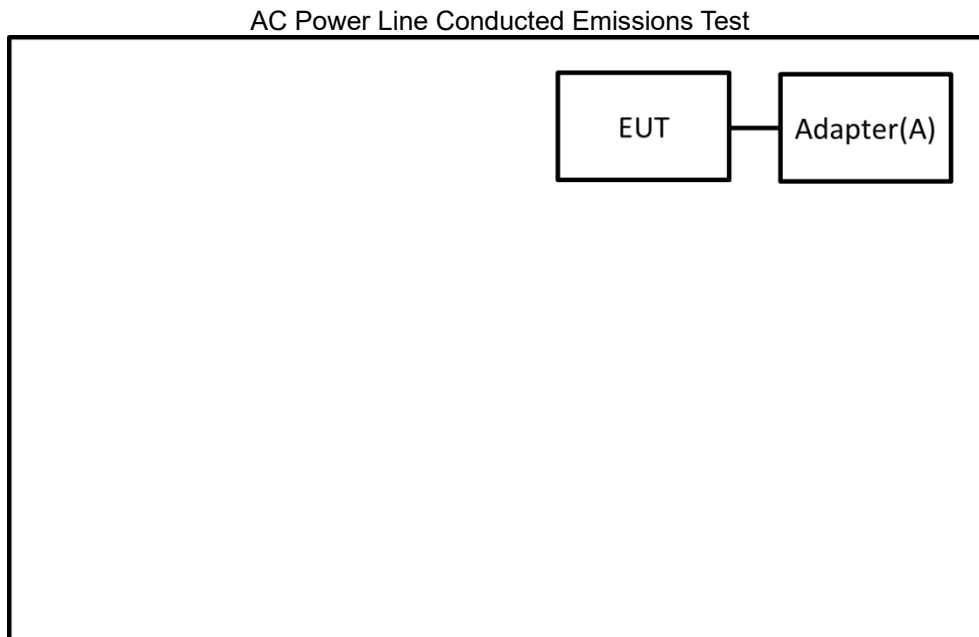

2.4 SUPPORT UNITS

| Item | Equipment | Brand | Model No. | Series No. | Remarks |
|------|-----------|--------|-------------|------------|-----------------------------|
| A | Adapter | Lenovo | ADL135SLC3A | N/A | Supplied by test requester. |

| Item | Shielded | Ferrite Core | Length | Cable Type | Remarks |
|------|----------|--------------|--------|------------|---------|
| - | - | - | - | - | - |

3 AC POWER LINE CONDUCTED EMISSIONS TEST

3.1 LIMIT

| Frequency (MHz) | Limit (dB μ V) | |
|-----------------|--------------------|-----------|
| | Quasi-peak | Average |
| 0.15 - 0.5 | 66 - 56 * | 56 - 46 * |
| 0.50 - 5.0 | 56 | 46 |
| 5.0 - 30.0 | 60 | 50 |

NOTE:

- (1) The tighter limit applies at the band edges.
- (2) The limit of " * " marked band means the limitation decreases linearly with the logarithm of the frequency in the range.
- (3) The test result calculated as following:
 Measurement Value = Reading Level + Correct Factor
 Correct Factor = Insertion Loss + Cable Loss + Attenuator Factor (if use)
 Margin Level = Measurement Value – Limit Value
 Calculation example:

| Reading Level | | Correct Factor | | Measurement Value |
|---------------|---|----------------|---|-------------------|
| 38.22 | + | 3.45 | = | 41.67 |

| Measurement Value | | Limit Value | | Margin Level |
|-------------------|---|-------------|---|--------------|
| 41.67 | - | 60 | = | -18.33 |

The following table is the setting of the receiver.

| Receiver Parameter | Setting |
|--------------------|----------|
| Attenuation | 10 dB |
| Start Frequency | 0.15 MHz |
| Stop Frequency | 30 MHz |
| IF Bandwidth | 9 KHz |

3.2 TEST PROCEDURE

- a. The EUT was placed 0.8 m above the horizontal ground plane with the EUT being connected to the power mains through a line impedance stabilization network (LISN).
 All other support equipment were powered from an additional LISN(s).
 The LISN provides 50 Ohm/50uH of impedance for the measuring instrument.
- b. Interconnecting cables that hang closer than 40 cm to the ground plane shall be folded back and forth in the center forming a bundle to keep the cable above 40 cm.
- c. Excess I/O cables that are not connected to a peripheral shall be bundled in the center.
 The end of the cable will be terminated, using the correct terminating impedance.
 The overall length shall not exceed 1 m.
- d. The LISN is spaced at least 80 cm from the nearest part of the EUT chassis.
- e. For the actual test configuration, please refer to the related Item - EUT TEST PHOTO.

NOTE:

- (1) In the results, each reading is marked as Peak, QP or AVG per the detector used.
 BW=9 kHz (6 dB Bandwidth)
- (2) All readings are Peak unless otherwise stated QP or AVG in column of Note. Both the QP and the AVG readings must be less than the limit for compliance.

3.3 DEVIATION FROM TEST STANDARD

No deviation.

3.4 TEST SETUP

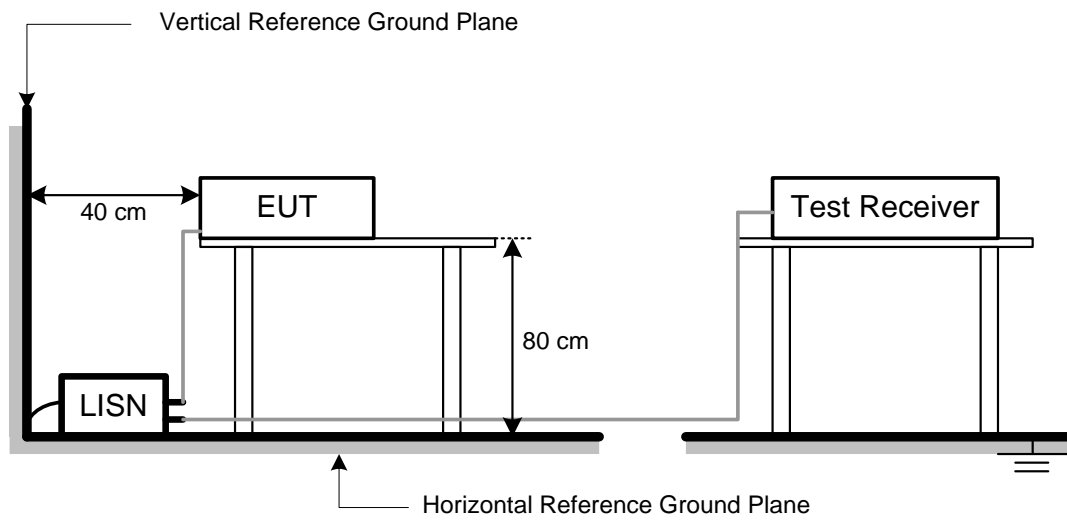

3.5 TEST RESULT

Please refer to the APPENDIX A.

4 EFFECTIVE ISOTROPICAL RADIATED POWER MEASUREMENT

4.1 LIMIT

Mobile / Portable station are limited to 2 watts e.i.r.p.

NOTE:

(1) The test result calculated as following:

Measurement Value = Reading Level + Correct Factor

Correct Factor = Antenna Factor + Cable Loss - Amplifier Gain(if use)

Margin Level = Measurement Value - Limit Value

Calculation example:

| | | | | |
|---------------|---|----------------|---|-------------------|
| Reading Level | | Correct Factor | | Measurement Value |
| -29.66 | + | 34.26 | = | 4.60 |

| | | | | |
|-------------------|---|-------------|---|--------------|
| Measurement Value | | Limit Value | | Margin Level |
| 4.60 | - | 38.45 | = | -33.85 |

4.2 TEST PROCEDURE

The testing follows FCC KDB 971168 v03r01 Section 5.8.

- Substitution method is used for E.I.R.P measurement. In the semi-anechoic chamber, EUT placed on the 0.8m height of Turn Table, rotated the table around 360 degrees to search the maximum radiation power and receiver antenna shall be rotated vertical and horizontal polarization and moved height from 1m to 4m to find the maximum polar radiated power. The "Read Value" is the spectrum reading the maximum power value.
- The substitution horn antenna is substituted for EUT at the same position and signals generator export the CW signal to the substitution antenna via a TX cable. Rotated the Turn Table and moved receiving antenna to find the maximum radiation power. Adjust output power level of S.G to get a Value of spectrum reading equal to "Read Value " of step a. Record the power level of S.G
- EIRP = Output power level of S.G – TX cable loss + Antenna gain of substitution horn.
- ERP can be calculated form EIRP by subtracting the gain of dipole, $ERP = EIPR - 2.15dBi.$
- The resolution bandwidth and video bandwidth of test receiver/spectrum analyzer is 1MHz/3MHz.

4.3 DEVIATION FROM TEST STANDARD

No deviation.

4.4 TEST SETUP

Conducted Measurement:

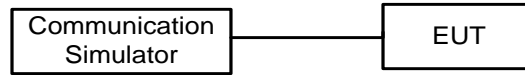

Radiated Measurement:

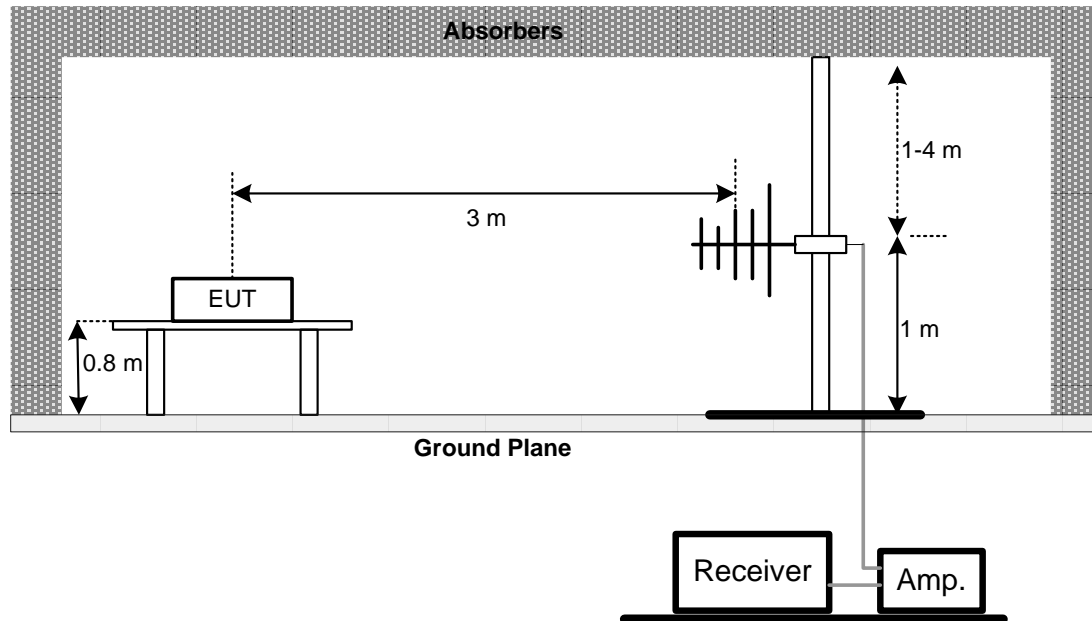

4.5 EUT OPERATING CONDITIONS

The EUT was programmed to be in continuously transmitting mode.

4.6 TEST RESULT

Please refer to the APPENDIX B.

5 RADIATED SPURIOUS EMISSIONS MEASUREMENT

5.1 LIMIT

The power of any emission outside of the authorized operating frequency ranges must be attenuated below the transmitting power (P) by a factor of at least $43 + 10 \log(P)$ dB. The emission limit equal to -13dBm.

NOTE:

(1) The test result calculated as following:

Measurement Value = Reading Level + Correct Factor

Correct Factor = Antenna Factor + Cable Loss - Amplifier Gain(if use)

Margin Level = Measurement Value - Limit Value

Calculation example:

| | | | | |
|---------------|---|----------------|---|-------------------|
| Reading Level | | Correct Factor | | Measurement Value |
| -50.43 | + | -2.11 | = | -52.54 |

| | | | | |
|-------------------|---|-------------|---|--------------|
| Measurement Value | | Limit Value | | Margin Level |
| -52.54 | - | -13 | = | -39.54 |

5.2 TEST PROCEDURE

The testing follows FCC KDB 971168 v03r01 Section 6.2.

- f. In the semi-anechoic chamber, EUT placed on the 0.8m height of Turn Table, rotated the table around 360 degrees to search the maximum radiation power and receiver antenna shall be rotated vertical and horizontal polarization and moved height from 1m to 4m to find the maximum polar radiated power. The "Read Value" is the spectrum reading the maximum power value.
- g. The substitution horn antenna is substituted for EUT at the same position and signals generator export the CW signal to the substitution antenna via a TX cable. Rotated the Turn Table and moved receiving antenna to find the maximum radiation power. Adjust output power level of S.G to get a Value of spectrum reading equal to "Read Value " of step a. Record the power level of S.G
- h. $EIRP = \text{Output power level of S.G} - \text{TX cable loss} + \text{Antenna gain of substitution horn.}$
- i. ERP power can be calculated form EIRP power by subtracting the gain of dipole,
 $ERP \text{ power} = EIRP \text{ power} - 2.15 \text{ dBi.}$
- j. The resolution bandwidth and video bandwidth of test receiver/spectrum analyzer is 1 MHz / 3 MHz.

5.3 DEVIATION FROM TEST STANDARD

No deviation.

5.4 TEST SETUP

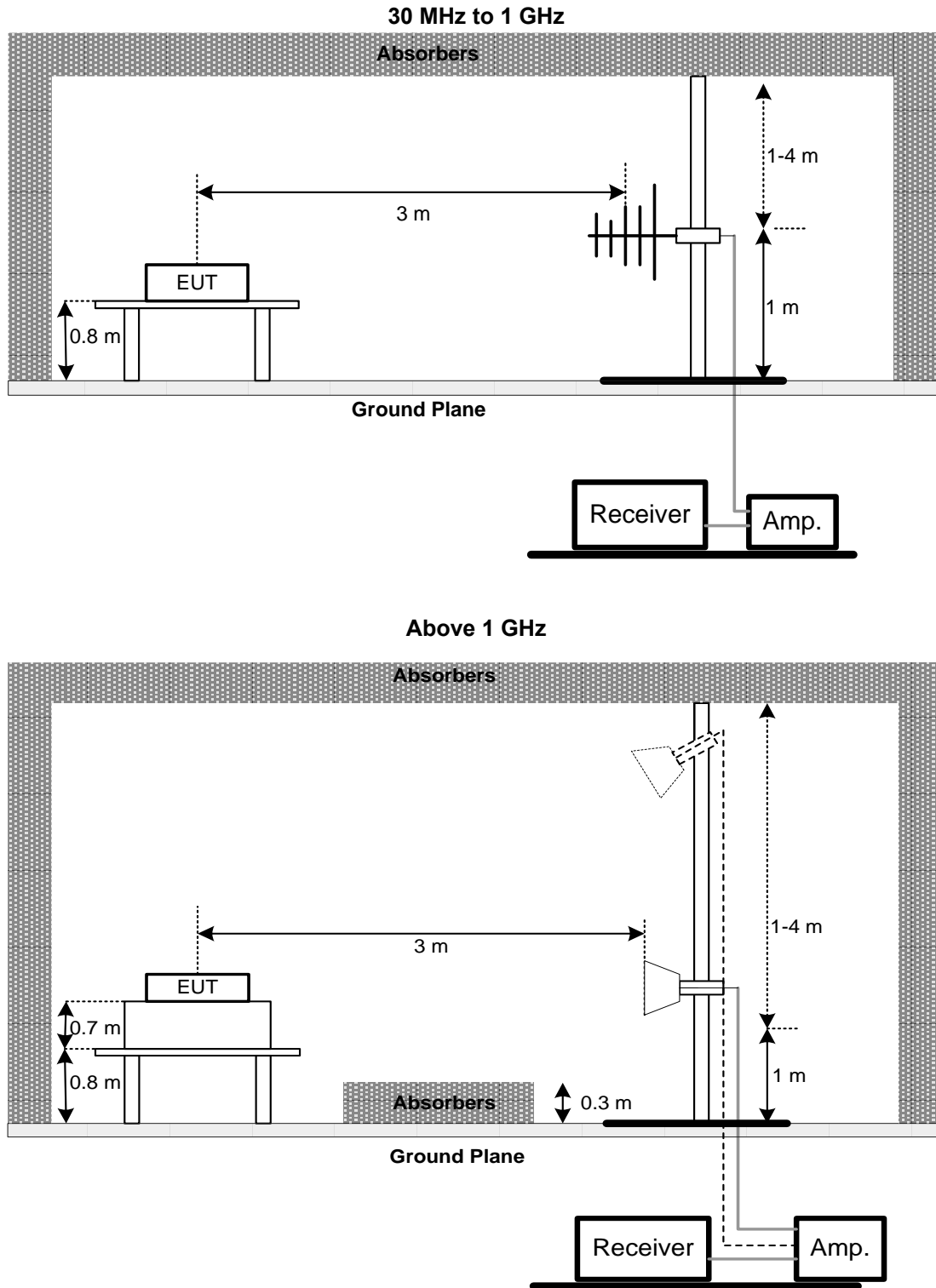

5.5 EUT OPERATING CONDITIONS

The EUT was programmed to be in continuously transmitting mode.

5.6 TEST RESULT

Please refer to the APPENDIX C.

6 LIST OF MEASURING EQUIPMENTS

| AC Power Line Conducted Emissions | | | | | | |
|-----------------------------------|----------------------|--------------|-----------------------------|------------|-----------------|------------------|
| Item | Kind of Equipment | Manufacturer | Type No. | Serial No. | Calibrated Date | Calibrated Until |
| 1 | TWO-LINE V-NETWORK | R&S | ENV216 | 101339 | 2021/3/10 | 2022/3/9 |
| 2 | Test Cable | EMCI | EMCCFD300-BM-BMR-6000 | 170714 | 2021/6/7 | 2022/6/6 |
| 3 | EMI Test Receiver | R&S | ESR 7 | 101433 | 2021/11/24 | 2022/11/23 |
| 4 | Measurement Software | EZ | EZ EMC (Version NB-03A1-01) | N/A | N/A | N/A |

| Conducted Output Power | | | | | | |
|------------------------|--------------------------------------|--------------|----------|------------|-----------------|------------------|
| Item | Kind of Equipment | Manufacturer | Type No. | Serial No. | Calibrated Date | Calibrated Until |
| 1 | 8960 Series 10 Wireless Com Test Set | Agilent | E5515C | GB47390193 | 2021/7/23 | 2022/7/22 |
| 2 | Radio Communication Analyzer | Anritsu | MT8820C | 6201381608 | 2021/12/15 | 2022/12/14 |

| Effective Isotropic Radiated Power and Radiated Emissions | | | | | | |
|---|--------------------------------------|--------------|-----------------------------|------------|-----------------|------------------|
| Item | Kind of Equipment | Manufacturer | Type No. | Serial No. | Calibrated Date | Calibrated Until |
| 1 | Preamplifier | EMCI | EMC02325 | 980217 | 2021/4/8 | 2022/4/7 |
| 2 | Preamplifier | EMCI | EMC012645B | 980222 | 2021/4/8 | 2022/4/7 |
| 3 | Test Cable | EMCI | EMC104-SM-1000 | 180809 | 2021/4/8 | 2022/4/7 |
| 4 | Test Cable | EMCI | EMC104-SM-SM-3000 | 151205 | 2021/4/8 | 2022/4/7 |
| 5 | Test Cable | EMCI | EMC-SM-SM-7000 | 180408 | 2021/4/8 | 2022/4/7 |
| 6 | MXE EMI Receiver | Agilent | N9038A | MY56400087 | 2021/5/27 | 2022/5/26 |
| 7 | Signal Analyzer | Agilent | N9010A | MY56480554 | 2021/8/25 | 2022/8/24 |
| 8 | Horn Ant | SCHWARZBECK | BBHA 9120D | 9120D-1342 | 2021/6/2 | 2022/6/1 |
| 9 | Horn Ant | Schwarzbeck | BBHA 9170 | 340 | 2021/7/9 | 2022/7/8 |
| 10 | Trilog-Broadband Antenna | Schwarzbeck | VULB 9168 | 9168-352 | 2021/8/11 | 2022/8/10 |
| 11 | 5dB Attenuator | EMCI | EMCI-N-6-05 | AT-N0625 | 2021/8/11 | 2022/8/10 |
| 12 | Measurement Software | EZ | EZ EMC (Version NB-03A1-01) | N/A | N/A | N/A |
| 13 | 8960 Series 10 Wireless Com Test Set | Agilent | E5515C | GB47390193 | 2021/7/23 | 2022/7/22 |
| 14 | Radio Communication Analyzer (LTE) | Anritsu | MT8821C | 6262044728 | 2021/11/28 | 2022/11/27 |

Remark: "N/A" denotes no model name, no serial no. or no calibration specified.
All calibration period of equipment list is one year.

7 EUT TEST PHOTO

Please refer to document Appendix No.: TP-2112T127-1 (APPENDIX-TEST PHOTOS).

8 EUT PHOTOS

Please refer to document Appendix No.: EP-2112T127-1 (APPENDIX-EUT PHOTOS).

APPENDIX A AC POWER LINE CONDUCTED EMISSIONS

| | | | |
|----------------|--------|-------------|-----------|
| Test Mode | Normal | Tested Date | 2022/2/16 |
| Test Frequency | - | Phase | Line |

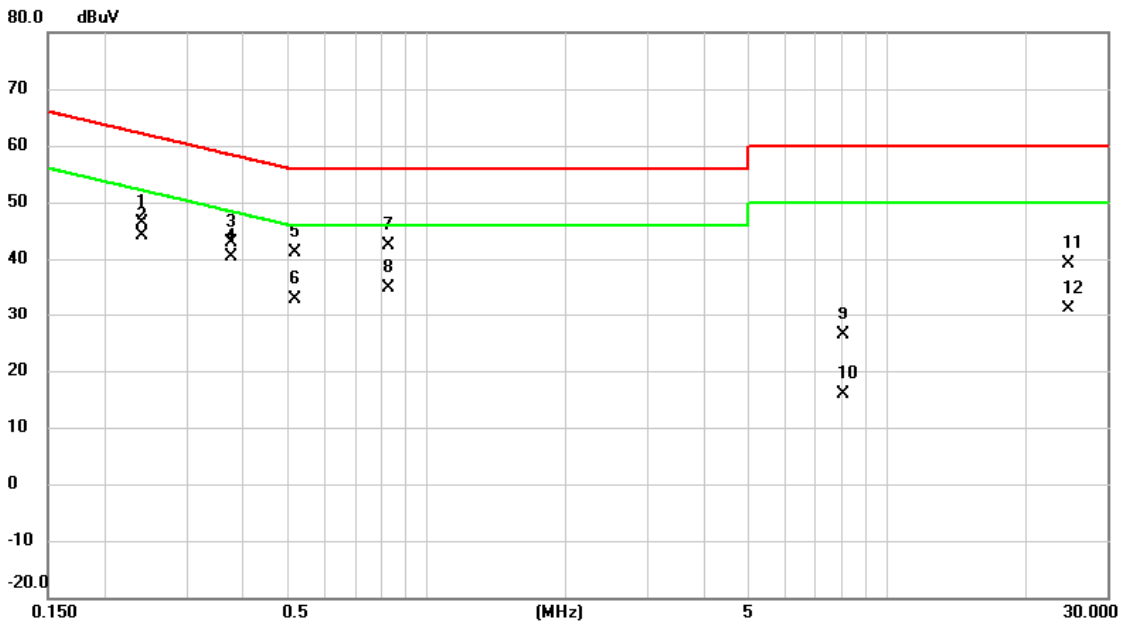

| No. | Mk. | Freq. MHz | Reading Level dBuV | Correct Factor dB | Measure- ment dBuV | Limit dBuV | Over dB | Detector | Comment |
|-----|-----|--------------|--------------------------|-------------------------|--------------------------|---------------|------------|----------|---------|
| 1 | | 0.2400 | 36.70 | 9.72 | 46.42 | 62.10 | -15.68 | QP | |
| 2 | | 0.2400 | 34.34 | 9.72 | 44.06 | 52.10 | -8.04 | AVG | |
| 3 | | 0.3772 | 33.21 | 9.72 | 42.93 | 58.34 | -15.41 | QP | |
| 4 | * | 0.3772 | 30.69 | 9.72 | 40.41 | 48.34 | -7.93 | AVG | |
| 5 | | 0.5190 | 31.49 | 9.73 | 41.22 | 56.00 | -14.78 | QP | |
| 6 | | 0.5190 | 23.23 | 9.73 | 32.96 | 46.00 | -13.04 | AVG | |
| 7 | | 0.8272 | 32.56 | 9.74 | 42.30 | 56.00 | -13.70 | QP | |
| 8 | | 0.8272 | 25.06 | 9.74 | 34.80 | 46.00 | -11.20 | AVG | |
| 9 | | 8.0520 | 16.43 | 10.06 | 26.49 | 60.00 | -33.51 | QP | |
| 10 | | 8.0520 | 5.78 | 10.06 | 15.84 | 50.00 | -34.16 | AVG | |
| 11 | | 24.6525 | 28.97 | 10.24 | 39.21 | 60.00 | -20.79 | QP | |
| 12 | | 24.6525 | 20.84 | 10.24 | 31.08 | 50.00 | -18.92 | AVG | |

REMARKS:

- (1) Measurement Value = Reading Level + Correct Factor.
- (2) Margin Level = Measurement Value - Limit Value.

| | | | |
|----------------|--------|-------------|-----------|
| Test Mode | Normal | Tested Date | 2022/2/16 |
| Test Frequency | - | Phase | Neutral |

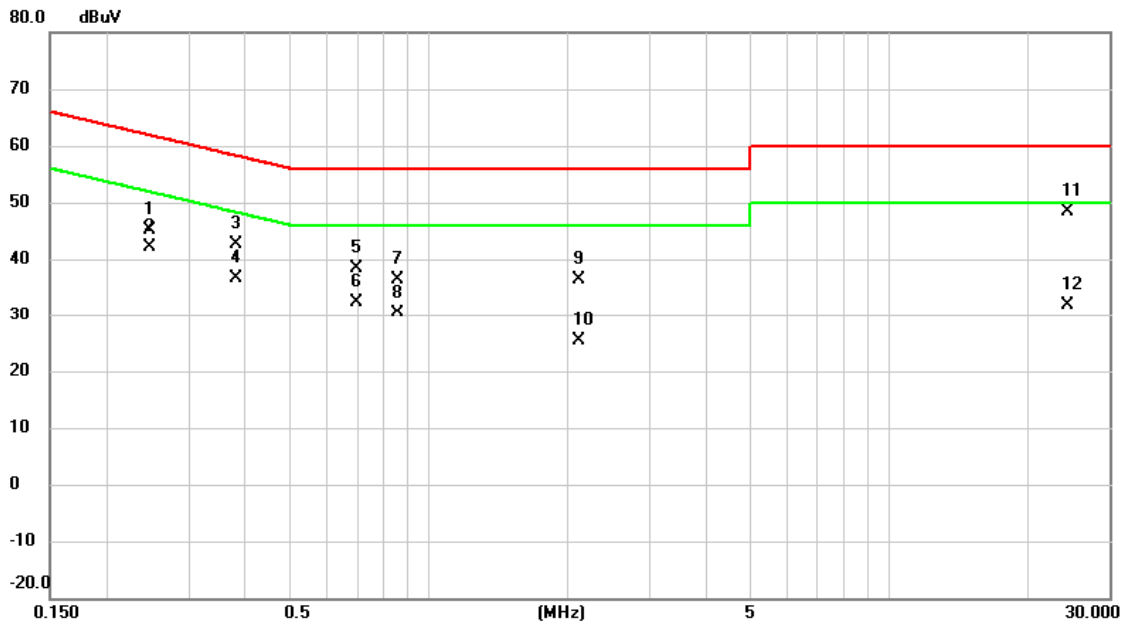

| No. | Mk. | Freq. | Reading Level | Correct Factor | Measurement | Limit | Over | Detector | Comment |
|-----|-----|---------|---------------|----------------|-------------|-------|--------|----------|---------|
| | | MHz | dBuV | dB | dBuV | dBuV | dB | | |
| 1 | | 0.2468 | 35.34 | 9.72 | 45.06 | 61.86 | -16.80 | QP | |
| 2 | * | 0.2468 | 32.44 | 9.72 | 42.16 | 51.86 | -9.70 | AVG | |
| 3 | | 0.3817 | 32.96 | 9.73 | 42.69 | 58.24 | -15.55 | QP | |
| 4 | | 0.3817 | 26.99 | 9.73 | 36.72 | 48.24 | -11.52 | AVG | |
| 5 | | 0.6990 | 28.70 | 9.74 | 38.44 | 56.00 | -17.56 | QP | |
| 6 | | 0.6990 | 22.76 | 9.74 | 32.50 | 46.00 | -13.50 | AVG | |
| 7 | | 0.8587 | 26.55 | 9.75 | 36.30 | 56.00 | -19.70 | QP | |
| 8 | | 0.8587 | 20.65 | 9.75 | 30.40 | 46.00 | -15.60 | AVG | |
| 9 | | 2.1188 | 26.67 | 9.78 | 36.45 | 56.00 | -19.55 | QP | |
| 10 | | 2.1188 | 15.59 | 9.78 | 25.37 | 46.00 | -20.63 | AVG | |
| 11 | | 24.4298 | 38.03 | 10.41 | 48.44 | 60.00 | -11.56 | QP | |
| 12 | | 24.4298 | 21.56 | 10.41 | 31.97 | 50.00 | -18.03 | AVG | |

REMARKS:

- (1) Measurement Value = Reading Level + Correct Factor.
- (2) Margin Level = Measurement Value - Limit Value.

| | | | |
|----------------|------|-------------|-----------|
| Test Mode | Idle | Tested Date | 2022/2/16 |
| Test Frequency | - | Phase | Line |

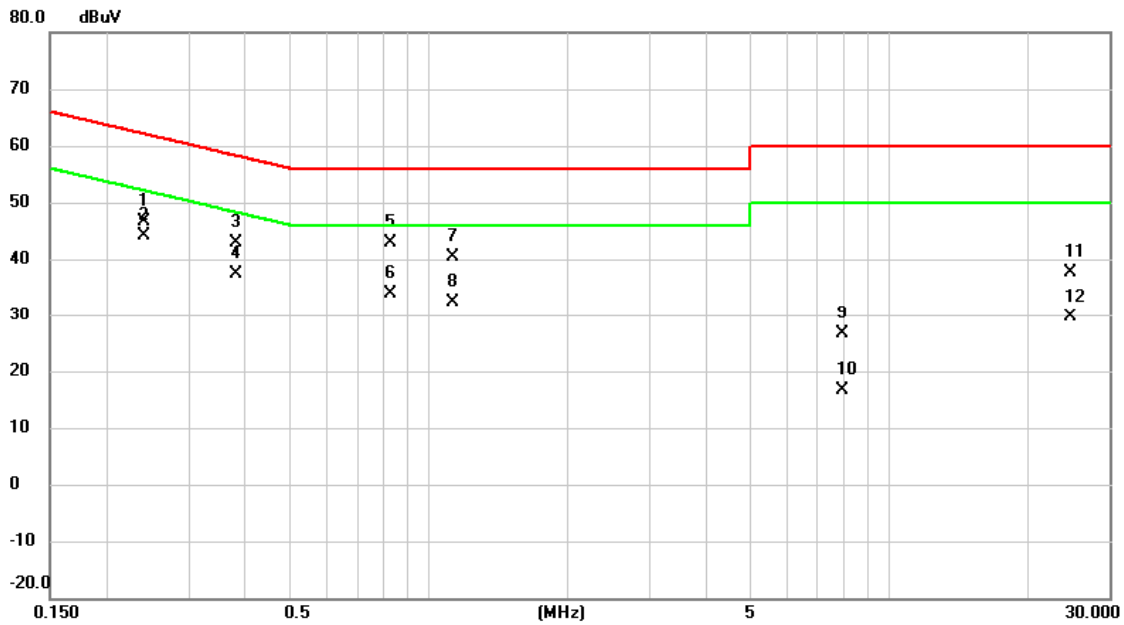

| No. | Mk. | Freq. MHz | Reading Level dBuV | Correct Factor dB | Measure- ment dBuV | Limit dBuV | Over dB | Detector | Comment |
|-----|-----|--------------|--------------------------|-------------------------|--------------------------|---------------|------------|----------|---------|
| 1 | | 0.2400 | 36.86 | 9.72 | 46.58 | 62.10 | -15.52 | QP | |
| 2 | * | 0.2400 | 34.53 | 9.72 | 44.25 | 52.10 | -7.85 | AVG | |
| 3 | | 0.3817 | 33.21 | 9.72 | 42.93 | 58.24 | -15.31 | QP | |
| 4 | | 0.3817 | 27.63 | 9.72 | 37.35 | 48.24 | -10.89 | AVG | |
| 5 | | 0.8250 | 33.19 | 9.74 | 42.93 | 56.00 | -13.07 | QP | |
| 6 | | 0.8250 | 24.12 | 9.74 | 33.86 | 46.00 | -12.14 | AVG | |
| 7 | | 1.1242 | 30.66 | 9.74 | 40.40 | 56.00 | -15.60 | QP | |
| 8 | | 1.1242 | 22.63 | 9.74 | 32.37 | 46.00 | -13.63 | AVG | |
| 9 | | 7.9148 | 16.47 | 10.05 | 26.52 | 60.00 | -33.48 | QP | |
| 10 | | 7.9148 | 6.52 | 10.05 | 16.57 | 50.00 | -33.43 | AVG | |
| 11 | | 24.6480 | 27.37 | 10.24 | 37.61 | 60.00 | -22.39 | QP | |
| 12 | | 24.6480 | 19.51 | 10.24 | 29.75 | 50.00 | -20.25 | AVG | |

REMARKS:

- (1) Measurement Value = Reading Level + Correct Factor.
- (2) Margin Level = Measurement Value - Limit Value.

| | | | |
|----------------|------|-------------|-----------|
| Test Mode | Idle | Tested Date | 2022/2/16 |
| Test Frequency | - | Phase | Neutral |

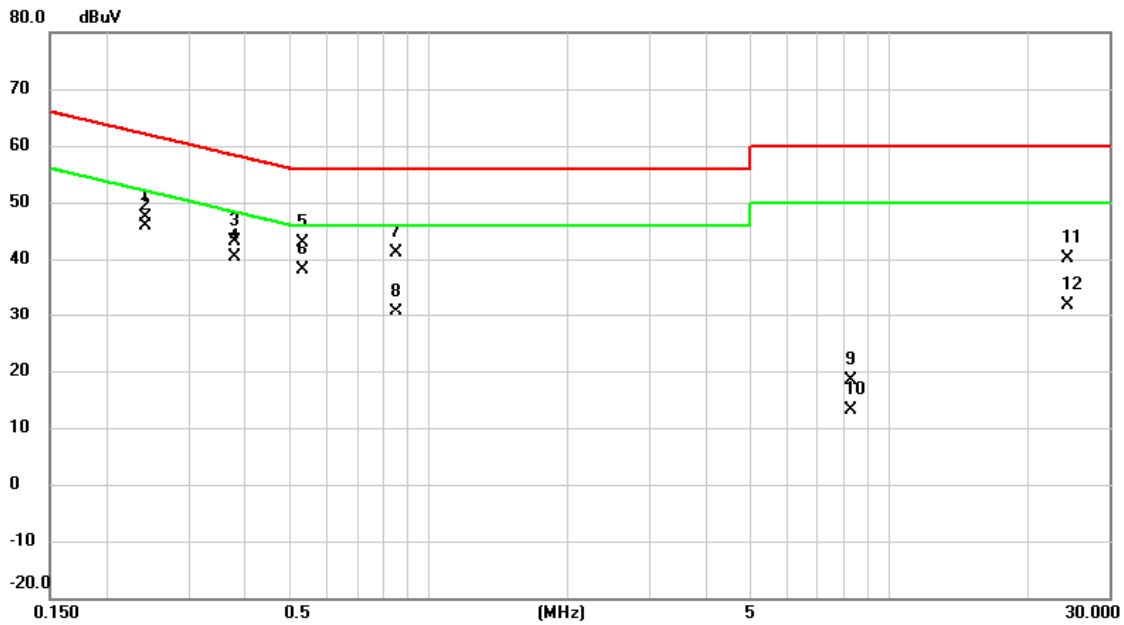

| No. | Mk. | Freq. MHz | Reading Level dBuV | Correct Factor dB | Measure- ment dBuV | Limit dBuV | Over dB | Detector | Comment |
|-----|-----|--------------|--------------------------|-------------------------|--------------------------|---------------|------------|----------|---------|
| 1 | | 0.2423 | 37.60 | 9.72 | 47.32 | 62.02 | -14.70 | QP | |
| 2 | * | 0.2423 | 36.16 | 9.72 | 45.88 | 52.02 | -6.14 | AVG | |
| 3 | | 0.3795 | 33.46 | 9.73 | 43.19 | 58.29 | -15.10 | QP | |
| 4 | | 0.3795 | 30.71 | 9.73 | 40.44 | 48.29 | -7.85 | AVG | |
| 5 | | 0.5347 | 33.14 | 9.74 | 42.88 | 56.00 | -13.12 | QP | |
| 6 | | 0.5347 | 28.43 | 9.74 | 38.17 | 46.00 | -7.83 | AVG | |
| 7 | | 0.8475 | 31.31 | 9.75 | 41.06 | 56.00 | -14.94 | QP | |
| 8 | | 0.8475 | 20.86 | 9.75 | 30.61 | 46.00 | -15.39 | AVG | |
| 9 | | 8.2703 | 8.38 | 10.10 | 18.48 | 60.00 | -41.52 | QP | |
| 10 | | 8.2703 | 2.96 | 10.10 | 13.06 | 50.00 | -36.94 | AVG | |
| 11 | | 24.4410 | 29.74 | 10.41 | 40.15 | 60.00 | -19.85 | QP | |
| 12 | | 24.4410 | 21.53 | 10.41 | 31.94 | 50.00 | -18.06 | AVG | |

REMARKS:

- (1) Measurement Value = Reading Level + Correct Factor.
- (2) Margin Level = Measurement Value - Limit Value.

APPENDIX B EFFECTIVE ISOTROPIC RADIATED POWER

Conducted Output Power and Calculated EIRP:
WCDMA Band II Power:

| Band | Mode | UL/DL Channel No. | Frequency(MHz) | Average power(dBm) | EIRP power (dBm) | EIRP power (W) |
|---------------|--------|-------------------|----------------|--------------------|------------------|----------------|
| WCDMA Band II | Rel 99 | 9262/9662 | 1852.4 | 23.34 | 24.03 | 0.253 |
| | | 9400/9800 | 1880.0 | 24.39 | 25.08 | 0.322 |
| | | 9538/9938 | 1907.6 | 24.33 | 25.02 | 0.318 |

| Band | Sub-test | UL/DL Channel No. | Frequency(MHz) | Average power(dBm) | EIRP power (dBm) | EIRP power (W) |
|---------------|----------|-------------------|----------------|--------------------|------------------|----------------|
| HSDPA Band II | 1 | 9262/9662 | 1852.4 | 24.26 | 24.95 | 0.313 |
| | | 9400/9800 | 1880.0 | 24.31 | 25.00 | 0.316 |
| | | 9538/9938 | 1907.6 | 24.26 | 24.95 | 0.313 |
| | 2 | 9262/9662 | 1852.4 | 23.76 | 24.45 | 0.279 |
| | | 9400/9800 | 1880.0 | 23.83 | 24.52 | 0.283 |
| | | 9538/9938 | 1907.6 | 23.76 | 24.45 | 0.279 |
| | 3 | 9262/9662 | 1852.4 | 23.27 | 23.96 | 0.249 |
| | | 9400/9800 | 1880.0 | 23.34 | 24.03 | 0.253 |
| | | 9538/9938 | 1907.6 | 23.31 | 24.00 | 0.251 |
| | 4 | 9262/9662 | 1852.4 | 23.31 | 24.00 | 0.251 |
| | | 9400/9800 | 1880.0 | 23.38 | 24.07 | 0.255 |
| | | 9538/9938 | 1907.6 | 23.28 | 23.97 | 0.249 |

| Band | Sub-test | UL/DL Channel No. | Frequency(MHz) | Average power(dBm) | EIRP power (dBm) | EIRP power (W) |
|---------------|----------|-------------------|----------------|--------------------|------------------|----------------|
| HSUPA Band II | 1 | 9262/9662 | 1852.4 | 24.21 | 24.90 | 0.309 |
| | | 9400/9800 | 1880.0 | 24.23 | 24.92 | 0.310 |
| | | 9538/9938 | 1907.6 | 24.22 | 24.91 | 0.310 |
| | 2 | 9262/9662 | 1852.4 | 22.23 | 22.92 | 0.196 |
| | | 9400/9800 | 1880.0 | 22.28 | 22.97 | 0.198 |
| | | 9538/9938 | 1907.6 | 22.23 | 22.92 | 0.196 |
| | 3 | 9262/9662 | 1852.4 | 23.26 | 23.95 | 0.248 |
| | | 9400/9800 | 1880.0 | 23.27 | 23.96 | 0.249 |
| | | 9538/9938 | 1907.6 | 23.23 | 23.92 | 0.247 |
| | 4 | 9262/9662 | 1852.4 | 22.26 | 22.95 | 0.197 |
| | | 9400/9800 | 1880.0 | 22.24 | 22.93 | 0.196 |
| | | 9538/9938 | 1907.6 | 22.25 | 22.94 | 0.197 |
| | 5 | 9262/9662 | 1852.4 | 24.16 | 24.85 | 0.305 |
| | | 9400/9800 | 1880.0 | 24.16 | 24.85 | 0.305 |
| | | 9538/9938 | 1907.6 | 24.13 | 24.82 | 0.303 |

NOTE:

(1) EIRP = Average power + Antenna gain.

(2) ERP = EIRP - 2.15.

 (3) $P(W) = 1 W \cdot 10^{(P(dBm) / 10) / 1000}$

LTE Band 2 Power:

| Band | BW (MHz) | Channel | Frequency (MHz) | Mode | UL RB Allocation | UL RB Offset | MPR | Average power (dBm) | EIRP power (dBm) | EIRP power (W) | | | |
|-------|----------|---------|-----------------|-------|------------------|--------------|-------|---------------------|------------------|----------------|-------|-------|-------|
| 2 | 1.4 | 18607 | 1850.7 | QPSK | 1 | 0 | 0 | 23.5 | 24.1 | 0.259 | | | |
| | | | | | 1 | 2 | 0 | 23.3 | 24.0 | 0.253 | | | |
| | | | | | 1 | 5 | 0 | 23.3 | 23.9 | 0.248 | | | |
| | | | | | 3 | 0 | 0 | 22.5 | 23.2 | 0.210 | | | |
| | | | | | 3 | 1 | 0 | 22.4 | 23.1 | 0.203 | | | |
| | | | | | 3 | 2 | 0 | 22.3 | 23.0 | 0.200 | | | |
| | | | | 16QAM | 6 | 0 | 1 | 22.5 | 23.2 | 0.208 | | | |
| | | | | | 1 | 0 | 1 | 22.5 | 23.2 | 0.209 | | | |
| | | | | | 1 | 2 | 1 | 22.4 | 23.1 | 0.205 | | | |
| | | | | | 1 | 5 | 1 | 22.4 | 23.0 | 0.201 | | | |
| | | | | | 3 | 0 | 1 | 21.4 | 22.1 | 0.163 | | | |
| | | | | | 3 | 1 | 1 | 21.3 | 22.0 | 0.158 | | | |
| | | 18900 | 1880.0 | QPSK | 1880.0 | QPSK | 3 | 2 | 1 | 21.2 | 21.9 | 0.155 | |
| | | | | | | | 6 | 0 | 2 | 21.4 | 22.1 | 0.162 | |
| | | | | | | | 1 | 0 | 0 | 23.5 | 24.2 | 0.263 | |
| | | | | | | | 1 | 2 | 0 | 23.4 | 24.1 | 0.258 | |
| | | | | | | | 1 | 5 | 0 | 23.4 | 24.0 | 0.254 | |
| | | | | | | | 3 | 0 | 0 | 22.6 | 23.3 | 0.213 | |
| | | | | 16QAM | 16QAM | 16QAM | 16QAM | 3 | 1 | 0 | 22.5 | 23.2 | 0.207 |
| | | | | | | | | 3 | 2 | 0 | 22.4 | 23.1 | 0.205 |
| | | | | | | | | 6 | 0 | 1 | 22.6 | 23.2 | 0.211 |
| | | | | | | | | 1 | 0 | 1 | 22.6 | 23.3 | 0.212 |
| | | | | | | | | 1 | 2 | 1 | 22.5 | 23.2 | 0.209 |
| | | | | | | | | 1 | 5 | 1 | 22.5 | 23.1 | 0.206 |
| | | 19192 | 1909.2 | QPSK | 1909.2 | QPSK | 3 | 0 | 1 | 21.5 | 22.2 | 0.164 | |
| | | | | | | | 3 | 1 | 1 | 21.4 | 22.0 | 0.160 | |
| | | | | | | | 3 | 2 | 1 | 21.3 | 21.9 | 0.156 | |
| | | | | | | | 6 | 0 | 2 | 21.4 | 22.1 | 0.161 | |
| | | | | | | | 1 | 0 | 0 | 23.5 | 24.2 | 0.261 | |
| | | | | | | | 1 | 2 | 0 | 23.3 | 24.0 | 0.253 | |
| 16QAM | 16QAM | | | 16QAM | 16QAM | 1 | 5 | 0 | 23.3 | 24.0 | 0.248 | | |
| | | | | | | 3 | 0 | 0 | 22.6 | 23.3 | 0.212 | | |
| | | | | | | 3 | 1 | 0 | 22.4 | 23.1 | 0.203 | | |
| | | | | | | 3 | 2 | 0 | 22.3 | 23.0 | 0.200 | | |
| | | | | | | 6 | 0 | 1 | 22.5 | 23.2 | 0.209 | | |
| | | | | | | 1 | 0 | 1 | 22.6 | 23.2 | 0.211 | | |
| 16QAM | 16QAM | 16QAM | 16QAM | 1 | 2 | 1 | 22.4 | 23.1 | 0.205 | | | | |
| | | | | 1 | 5 | 1 | 22.4 | 23.1 | 0.202 | | | | |
| | | | | 3 | 0 | 1 | 21.4 | 22.1 | 0.162 | | | | |
| | | | | 3 | 1 | 1 | 21.2 | 21.9 | 0.156 | | | | |
| | | | | 3 | 2 | 1 | 21.4 | 22.1 | 0.160 | | | | |
| | | | | 6 | 0 | 2 | 21.4 | 22.1 | 0.160 | | | | |

NOTE:

(1) EIRP = Average power + Antenna gain.

(2) ERP = EIRP - 2.15.

 (3) P(W) = $1 \text{ W} \cdot 10^{(P(\text{dBm}) / 10) / 1000}$

| Band | BW (MHz) | Channel | Frequency (MHz) | Mode | UL RB Allocation | UL RB Offset | MPR | Average power (dBm) | EIRP power (dBm) | EIRP power (W) |
|-------|----------|---------|-----------------|-------|------------------|--------------|-----|---------------------|------------------|----------------|
| 2 | 3 | 18615 | 1851.5 | QPSK | 1 | 0 | 0 | 23.5 | 24.2 | 0.262 |
| | | | | | 1 | 7 | 0 | 23.4 | 24.1 | 0.255 |
| | | | | | 1 | 14 | 0 | 23.3 | 24.0 | 0.250 |
| | | | | | 8 | 0 | 1 | 22.6 | 23.3 | 0.212 |
| | | | | | 8 | 4 | 1 | 22.4 | 23.1 | 0.205 |
| | | | | | 8 | 7 | 1 | 22.4 | 23.1 | 0.202 |
| | | | | 16QAM | 15 | 0 | 1 | 22.5 | 23.2 | 0.210 |
| | | | | | 1 | 0 | 1 | 22.6 | 23.3 | 0.211 |
| | | | | | 1 | 7 | 1 | 22.5 | 23.2 | 0.207 |
| | | | | | 1 | 14 | 1 | 22.4 | 23.1 | 0.203 |
| | | | | | 8 | 0 | 2 | 21.5 | 22.2 | 0.165 |
| | | | | | 8 | 4 | 2 | 21.4 | 22.0 | 0.160 |
| | | 18900 | 1880.0 | QPSK | 8 | 7 | 2 | 21.2 | 21.9 | 0.156 |
| | | | | | 8 | 0 | 2 | 21.5 | 22.1 | 0.164 |
| | | | | | 15 | 0 | 2 | 21.5 | 22.1 | 0.164 |
| | | | | | 1 | 0 | 0 | 23.6 | 24.2 | 0.265 |
| | | | | | 1 | 7 | 0 | 23.5 | 24.2 | 0.261 |
| | | | | | 1 | 14 | 0 | 23.4 | 24.1 | 0.256 |
| | | | | 16QAM | 8 | 0 | 1 | 22.6 | 23.3 | 0.215 |
| | | | | | 8 | 4 | 1 | 22.5 | 23.2 | 0.209 |
| | | | | | 8 | 7 | 1 | 22.5 | 23.2 | 0.207 |
| | | | | | 15 | 0 | 1 | 22.6 | 23.3 | 0.213 |
| | | | | | 1 | 0 | 1 | 22.6 | 23.3 | 0.214 |
| | | | | | 1 | 7 | 1 | 22.6 | 23.2 | 0.211 |
| | | 19184 | 1908.4 | QPSK | 8 | 14 | 1 | 22.5 | 23.2 | 0.208 |
| | | | | | 8 | 0 | 2 | 21.5 | 22.2 | 0.166 |
| | | | | | 8 | 4 | 2 | 21.4 | 22.1 | 0.161 |
| | | | | | 8 | 7 | 2 | 21.3 | 22.0 | 0.158 |
| | | | | | 15 | 0 | 2 | 21.4 | 22.1 | 0.162 |
| | | | | | 15 | 0 | 2 | 21.4 | 22.1 | 0.162 |
| | | | | 16QAM | 1 | 0 | 0 | 23.5 | 24.2 | 0.264 |
| | | | | | 1 | 7 | 0 | 23.4 | 24.1 | 0.255 |
| | | | | | 1 | 14 | 0 | 23.3 | 24.0 | 0.251 |
| | | | | | 8 | 0 | 1 | 22.6 | 23.3 | 0.214 |
| | | | | | 8 | 4 | 1 | 22.4 | 23.1 | 0.205 |
| | | | | | 8 | 7 | 1 | 22.4 | 23.1 | 0.202 |
| 16QAM | 15 | 0 | 1 | 22.6 | 23.3 | 0.211 | | | | |
| | 1 | 0 | 1 | 22.6 | 23.3 | 0.213 | | | | |
| | 1 | 7 | 1 | 22.5 | 23.2 | 0.207 | | | | |
| | 1 | 14 | 1 | 22.4 | 23.1 | 0.204 | | | | |
| | 8 | 0 | 2 | 21.5 | 22.1 | 0.164 | | | | |
| | 8 | 4 | 2 | 21.3 | 22.0 | 0.157 | | | | |
| 8 | 7 | 2 | 21.4 | 22.1 | 0.162 | | | | | |
| 15 | 0 | 2 | 21.4 | 22.1 | 0.162 | | | | | |

NOTE:

(1) EIRP = Average power + Antenna gain.

(2) ERP = EIRP - 2.15.

 (3) $P(W) = 1 W \cdot 10^{(P(dBm) / 10) / 1000}$

| Band | BW (MHz) | Channel | Frequency (MHz) | Mode | UL RB Allocation | UL RB Offset | MPR | Average power (dBm) | EIRP power (dBm) | EIRP power (W) |
|------|----------|---------|-----------------|------|------------------|--------------|-------|---------------------|------------------|----------------|
| 2 | 5 | 18625 | 1852.5 | QPSK | 1 | 0 | 0 | 23.6 | 24.3 | 0.267 |
| | | | | | 1 | 12 | 0 | 23.5 | 24.2 | 0.260 |
| | | | | | 1 | 24 | 0 | 23.4 | 24.1 | 0.255 |
| | | | | | 12 | 0 | 1 | 22.7 | 23.4 | 0.216 |
| | | | | | 12 | 6 | 1 | 22.5 | 23.2 | 0.209 |
| | | | | | 12 | 11 | 1 | 22.4 | 23.1 | 0.206 |
| | | | | 25 | 0 | 1 | 22.6 | 23.3 | 0.214 | |
| | | | | 1 | 0 | 1 | 22.6 | 23.3 | 0.215 | |
| | | | | 1 | 12 | 1 | 22.5 | 23.2 | 0.210 | |
| | | | | 1 | 24 | 1 | 22.5 | 23.2 | 0.207 | |
| | | | | 12 | 0 | 2 | 21.6 | 22.3 | 0.168 | |
| | | | | 12 | 6 | 2 | 21.4 | 22.1 | 0.163 | |
| | | 12 | 11 | 2 | 21.3 | 22.0 | 0.159 | | | |
| | | 25 | 0 | 2 | 21.5 | 22.2 | 0.167 | | | |
| | | 1 | 0 | 0 | 23.6 | 24.3 | 0.270 | | | |
| | | 1 | 12 | 0 | 23.6 | 24.2 | 0.265 | | | |
| | | 1 | 24 | 0 | 23.5 | 24.2 | 0.261 | | | |
| | | 12 | 0 | 1 | 22.7 | 23.4 | 0.219 | | | |
| | | 12 | 6 | 1 | 22.6 | 23.3 | 0.213 | | | |
| | | 12 | 11 | 1 | 22.5 | 23.2 | 0.210 | | | |
| | | 25 | 0 | 1 | 22.7 | 23.4 | 0.217 | | | |
| | | 1 | 0 | 1 | 22.7 | 23.4 | 0.218 | | | |
| | | 1 | 12 | 1 | 22.6 | 23.3 | 0.215 | | | |
| | | 1 | 24 | 1 | 22.6 | 23.3 | 0.212 | | | |
| | | 12 | 0 | 2 | 21.6 | 22.3 | 0.169 | | | |
| | | 12 | 6 | 2 | 21.5 | 22.2 | 0.164 | | | |
| | | 12 | 11 | 2 | 21.4 | 22.1 | 0.161 | | | |
| | | 25 | 0 | 2 | 21.5 | 22.2 | 0.165 | | | |
| | | 1 | 0 | 0 | 23.6 | 24.3 | 0.269 | | | |
| | | 1 | 12 | 0 | 23.5 | 24.2 | 0.260 | | | |
| | | 1 | 24 | 0 | 23.4 | 24.1 | 0.255 | | | |
| | | 12 | 0 | 1 | 22.7 | 23.4 | 0.218 | | | |
| | | 12 | 6 | 1 | 22.5 | 23.2 | 0.209 | | | |
| | | 12 | 11 | 1 | 22.5 | 23.1 | 0.206 | | | |
| | | 25 | 0 | 1 | 22.6 | 23.3 | 0.215 | | | |
| | | 1 | 0 | 1 | 22.7 | 23.4 | 0.217 | | | |
| 1 | 12 | 1 | 22.5 | 23.2 | 0.210 | | | | | |
| 1 | 24 | 1 | 22.5 | 23.2 | 0.207 | | | | | |
| 12 | 0 | 2 | 21.5 | 22.2 | 0.167 | | | | | |
| 12 | 6 | 2 | 21.4 | 22.1 | 0.160 | | | | | |
| 12 | 11 | 2 | 21.5 | 22.2 | 0.165 | | | | | |
| 25 | 0 | 2 | 21.5 | 22.2 | 0.165 | | | | | |

NOTE:

(1) EIRP = Average power + Antenna gain.

(2) ERP = EIRP - 2.15.

(3) P(W) = $1 \text{ W} \cdot 10^{(P(\text{dBm}) / 10) / 1000}$

| Band | BW (MHz) | Channel | Frequency (MHz) | Mode | UL RB Allocation | UL RB Offset | MPR | Average power (dBm) | EIRP power (dBm) | EIRP power (W) | | | |
|-------|----------|---------|-----------------|-------|------------------|--------------|-------|---------------------|------------------|----------------|-------|-------|-------|
| 2 | 10 | 18650 | 1855.0 | QPSK | 1 | 0 | 0 | 23.6 | 24.3 | 0.271 | | | |
| | | | | | 1 | 24 | 0 | 23.5 | 24.2 | 0.264 | | | |
| | | | | | 1 | 49 | 0 | 23.4 | 24.1 | 0.259 | | | |
| | | | | | 25 | 0 | 1 | 22.7 | 23.4 | 0.220 | | | |
| | | | | | 25 | 12 | 1 | 22.6 | 23.3 | 0.212 | | | |
| | | | | | 25 | 24 | 1 | 22.5 | 23.2 | 0.209 | | | |
| | | | | 16QAM | 50 | 0 | 1 | 22.7 | 23.4 | 0.217 | | | |
| | | | | | 1 | 0 | 1 | 22.7 | 23.4 | 0.219 | | | |
| | | | | | 1 | 24 | 1 | 22.6 | 23.3 | 0.214 | | | |
| | | | | | 1 | 49 | 1 | 22.5 | 23.2 | 0.210 | | | |
| | | | | | 25 | 0 | 2 | 21.6 | 22.3 | 0.171 | | | |
| | | | | | 25 | 12 | 2 | 21.5 | 22.2 | 0.166 | | | |
| | | 18900 | 1880.0 | QPSK | 1880.0 | QPSK | 25 | 24 | 2 | 21.4 | 22.1 | 0.161 | |
| | | | | | | | 25 | 24 | 2 | 21.4 | 22.1 | 0.161 | |
| | | | | | | | 50 | 0 | 2 | 21.6 | 22.3 | 0.169 | |
| | | | | | | | 1 | 0 | 0 | 23.7 | 24.4 | 0.275 | |
| | | | | | | | 1 | 24 | 0 | 23.6 | 24.3 | 0.270 | |
| | | | | | | | 1 | 49 | 0 | 23.5 | 24.2 | 0.265 | |
| | | | | 16QAM | 16QAM | 16QAM | 16QAM | 25 | 0 | 1 | 22.8 | 23.5 | 0.222 |
| | | | | | | | | 1 | 24 | 1 | 22.7 | 23.4 | 0.218 |
| | | | | | | | | 1 | 49 | 1 | 22.6 | 23.3 | 0.215 |
| | | | | | | | | 25 | 0 | 2 | 21.7 | 22.4 | 0.172 |
| | | | | | | | | 25 | 12 | 2 | 21.5 | 22.2 | 0.167 |
| | | | | | | | | 25 | 24 | 2 | 21.4 | 22.1 | 0.163 |
| | | 19150 | 1905.0 | QPSK | 1905.0 | QPSK | 50 | 0 | 2 | 21.6 | 22.3 | 0.168 | |
| | | | | | | | 1 | 0 | 0 | 23.7 | 24.4 | 0.273 | |
| | | | | | | | 1 | 24 | 0 | 23.5 | 24.2 | 0.264 | |
| | | | | | | | 1 | 49 | 0 | 23.5 | 24.1 | 0.259 | |
| | | | | | | | 25 | 0 | 1 | 22.8 | 23.5 | 0.221 | |
| | | | | | | | 25 | 12 | 1 | 22.6 | 23.3 | 0.212 | |
| 16QAM | 16QAM | | | 16QAM | 16QAM | 25 | 24 | 1 | 22.5 | 23.2 | 0.209 | | |
| | | | | | | 25 | 24 | 1 | 22.5 | 23.2 | 0.209 | | |
| | | | | | | 50 | 0 | 1 | 22.7 | 23.4 | 0.219 | | |
| | | | | | | 1 | 0 | 1 | 22.7 | 23.4 | 0.220 | | |
| | | | | | | 1 | 24 | 1 | 22.6 | 23.3 | 0.214 | | |
| | | | | | | 1 | 49 | 1 | 22.6 | 23.2 | 0.211 | | |
| 25 | 0 | 2 | 21.6 | 22.3 | 0.169 | | | | | | | | |
| 25 | 12 | 2 | 21.4 | 22.1 | 0.163 | | | | | | | | |
| 25 | 24 | 2 | 21.6 | 22.2 | 0.167 | | | | | | | | |
| 50 | 0 | 2 | 21.6 | 22.2 | 0.167 | | | | | | | | |

NOTE:

(1) EIRP = Average power + Antenna gain.

(2) ERP = EIRP - 2.15.

 (3) $P(W) = 1 W \cdot 10^{(P(dBm) / 10) / 1000}$

| Band | BW (MHz) | Channel | Frequency (MHz) | Mode | UL RB Allocation | UL RB Offset | MPR | Average power (dBm) | EIRP power (dBm) | EIRP power (W) |
|------|----------|---------|-----------------|------|------------------|--------------|-------|---------------------|------------------|----------------|
| 2 | 15 | 18675 | 1857.5 | QPSK | 1 | 0 | 0 | 23.7 | 24.4 | 0.274 |
| | | | | | 1 | 37 | 0 | 23.6 | 24.3 | 0.267 |
| | | | | | 1 | 74 | 0 | 23.5 | 24.2 | 0.262 |
| | | | | | 36 | 0 | 1 | 22.8 | 23.5 | 0.222 |
| | | | | | 36 | 18 | 1 | 22.6 | 23.3 | 0.215 |
| | | | | | 36 | 35 | 1 | 22.6 | 23.3 | 0.211 |
| | | | | 75 | 0 | 1 | 22.7 | 23.4 | 0.220 | |
| | | | | 1 | 0 | 1 | 22.8 | 23.5 | 0.221 | |
| | | | | 1 | 37 | 1 | 22.7 | 23.4 | 0.216 | |
| | | | | 1 | 74 | 1 | 22.6 | 23.3 | 0.213 | |
| | | | | 36 | 0 | 2 | 21.7 | 22.4 | 0.173 | |
| | | | | 36 | 18 | 2 | 21.6 | 22.2 | 0.167 | |
| | | 36 | 35 | 2 | 21.4 | 22.1 | 0.163 | | | |
| | | 75 | 0 | 2 | 21.7 | 22.3 | 0.171 | | | |
| | | 1 | 0 | 0 | 23.8 | 24.4 | 0.278 | | | |
| | | 1 | 37 | 0 | 23.7 | 24.4 | 0.273 | | | |
| | | 1 | 74 | 0 | 23.6 | 24.3 | 0.268 | | | |
| | | 36 | 0 | 1 | 22.8 | 23.5 | 0.225 | | | |
| | | 36 | 18 | 1 | 22.7 | 23.4 | 0.219 | | | |
| | | 36 | 35 | 1 | 22.7 | 23.4 | 0.216 | | | |
| | | 75 | 0 | 1 | 22.8 | 23.5 | 0.223 | | | |
| | | 1 | 0 | 1 | 22.8 | 23.5 | 0.224 | | | |
| | | 1 | 37 | 1 | 22.8 | 23.4 | 0.221 | | | |
| | | 1 | 74 | 1 | 22.7 | 23.4 | 0.218 | | | |
| | | 36 | 0 | 2 | 21.7 | 22.4 | 0.174 | | | |
| | | 36 | 18 | 2 | 21.6 | 22.3 | 0.169 | | | |
| | | 36 | 35 | 2 | 21.5 | 22.2 | 0.165 | | | |
| | | 75 | 0 | 2 | 21.6 | 22.3 | 0.170 | | | |
| | | 1 | 0 | 0 | 23.7 | 24.4 | 0.276 | | | |
| | | 1 | 37 | 0 | 23.6 | 24.3 | 0.267 | | | |
| | | 1 | 74 | 0 | 23.5 | 24.2 | 0.262 | | | |
| | | 36 | 0 | 1 | 22.8 | 23.5 | 0.224 | | | |
| | | 36 | 18 | 1 | 22.6 | 23.3 | 0.215 | | | |
| | | 36 | 35 | 1 | 22.6 | 23.3 | 0.212 | | | |
| | | 75 | 0 | 1 | 22.8 | 23.5 | 0.221 | | | |
| | | 1 | 0 | 1 | 22.8 | 23.5 | 0.223 | | | |
| 1 | 37 | 1 | 22.7 | 23.4 | 0.216 | | | | | |
| 1 | 74 | 1 | 22.6 | 23.3 | 0.213 | | | | | |
| 36 | 0 | 2 | 21.7 | 22.3 | 0.171 | | | | | |
| 36 | 18 | 2 | 21.5 | 22.2 | 0.165 | | | | | |
| 36 | 35 | 2 | 21.6 | 22.3 | 0.169 | | | | | |
| 75 | 0 | 2 | 21.6 | 22.3 | 0.169 | | | | | |

NOTE:

(1) EIRP = Average power + Antenna gain.

(2) ERP = EIRP - 2.15.

 (3) $P(W) = 1 W \cdot 10^{(P(dBm) / 10) / 1000}$

| Band | BW (MHz) | Channel | Frequency (MHz) | Mode | UL RB Allocation | UL RB Offset | MPR | Average power (dBm) | EIRP power (dBm) | EIRP power (W) | | |
|-------|----------|---------|-----------------|-------|------------------|--------------|-----|---------------------|------------------|----------------|------|-------|
| 2 | 20 | 18700 | 1860.0 | QPSK | 1 | 0 | 0 | 23.8 | 24.5 | 0.282 | | |
| | | | | | 1 | 49 | 0 | 23.7 | 24.4 | 0.275 | | |
| | | | | | 1 | 99 | 0 | 23.6 | 24.3 | 0.270 | | |
| | | | | | 50 | 0 | 1 | 22.9 | 23.6 | 0.229 | | |
| | | | | | 50 | 24 | 1 | 22.8 | 23.5 | 0.221 | | |
| | | | | | 50 | 49 | 1 | 22.7 | 23.4 | 0.218 | | |
| | | | | 16QAM | 100 | 0 | 1 | 22.9 | 23.6 | 0.226 | | |
| | | | | | 1 | 0 | 1 | 22.9 | 23.6 | 0.228 | | |
| | | | | | 1 | 49 | 1 | 22.8 | 23.5 | 0.223 | | |
| | | | | | 1 | 99 | 1 | 22.7 | 23.4 | 0.219 | | |
| | | | | | 50 | 0 | 2 | 21.8 | 22.5 | 0.178 | | |
| | | | | | 50 | 24 | 2 | 21.7 | 22.4 | 0.173 | | |
| | | 18900 | 1880.0 | QPSK | 1880.0 | QPSK | 50 | 49 | 2 | 21.6 | 22.3 | 0.168 |
| | | | | | | | 100 | 0 | 2 | 21.8 | 22.5 | 0.177 |
| | | | | | | | 1 | 0 | 0 | 23.9 | 24.6 | 0.286 |
| | | | | | | | 1 | 49 | 0 | 23.8 | 24.5 | 0.281 |
| | | | | | | | 1 | 99 | 0 | 23.7 | 24.4 | 0.276 |
| | | | | | | | 50 | 0 | 1 | 23.0 | 23.7 | 0.232 |
| | | | | 16QAM | 50 | 24 | 1 | 22.9 | 23.5 | 0.226 | | |
| | | | | | 50 | 49 | 1 | 22.8 | 23.5 | 0.223 | | |
| | | | | | 100 | 0 | 1 | 22.9 | 23.6 | 0.230 | | |
| | | | | | 1 | 0 | 1 | 23.0 | 23.6 | 0.231 | | |
| | | | | | 1 | 49 | 1 | 22.9 | 23.6 | 0.228 | | |
| | | | | | 1 | 99 | 1 | 22.8 | 23.5 | 0.224 | | |
| | | 19100 | 1900.0 | QPSK | 1900.0 | QPSK | 50 | 0 | 2 | 21.8 | 22.5 | 0.179 |
| | | | | | | | 50 | 24 | 2 | 21.7 | 22.4 | 0.174 |
| | | | | | | | 50 | 49 | 2 | 21.6 | 22.3 | 0.170 |
| | | | | | | | 100 | 0 | 2 | 21.7 | 22.4 | 0.175 |
| | | | | | | | 1 | 0 | 0 | 23.9 | 24.5 | 0.284 |
| | | | | | | | 1 | 49 | 0 | 23.7 | 24.4 | 0.275 |
| | | | | 16QAM | 1 | 99 | 0 | 23.6 | 24.3 | 0.270 | | |
| | | | | | 50 | 0 | 1 | 22.9 | 23.6 | 0.231 | | |
| | | | | | 50 | 24 | 1 | 22.8 | 23.5 | 0.221 | | |
| | | | | | 50 | 49 | 1 | 22.7 | 23.4 | 0.218 | | |
| | | | | | 100 | 0 | 1 | 22.9 | 23.6 | 0.228 | | |
| | | | | | 1 | 0 | 1 | 22.9 | 23.6 | 0.230 | | |
| 16QAM | 1 | 49 | 1 | 22.8 | 23.5 | 0.223 | | | | | | |
| | 1 | 99 | 1 | 22.7 | 23.4 | 0.220 | | | | | | |
| | 50 | 0 | 2 | 21.8 | 22.5 | 0.177 | | | | | | |
| | 50 | 24 | 2 | 21.6 | 22.3 | 0.170 | | | | | | |
| | 50 | 49 | 2 | 21.7 | 22.4 | 0.175 | | | | | | |
| | 100 | 0 | 2 | 21.7 | 22.4 | 0.175 | | | | | | |

NOTE:

(1) EIRP = Average power + Antenna gain.

(2) ERP = EIRP - 2.15.

 (3) $P(W) = 1 W \cdot 10^{(P(dBm) / 10) / 1000}$

LTE Band 25 Power:

| Band | BW (MHz) | Channel | Frequency (MHz) | Mode | UL RB Allocation | UL RB Offset | MPR | Average power | EIRP power (dBm) | EIRP power (W) |
|-------|----------|---------|-----------------|-------|------------------|--------------|-------|---------------|------------------|----------------|
| 25 | 1.4 | 26047 | 1850.7 | QPSK | 1 | 0 | 0 | 23.45 | 24.02 | 0.252 |
| | | | | | 1 | 2 | 0 | 23.34 | 23.91 | 0.246 |
| | | | | | 1 | 5 | 0 | 23.25 | 23.82 | 0.241 |
| | | | | | 3 | 0 | 0 | 22.54 | 23.11 | 0.205 |
| | | | | | 3 | 1 | 0 | 22.39 | 22.96 | 0.198 |
| | | | | | 3 | 2 | 0 | 22.32 | 22.89 | 0.195 |
| | | 6 | 0 | 1 | 22.49 | 23.06 | 0.202 | | | |
| | | 16QAM | 1 | 0 | 1 | 22.52 | 23.09 | 0.204 | | |
| | | | 1 | 2 | 1 | 22.42 | 22.99 | 0.199 | | |
| | | | 1 | 5 | 1 | 22.35 | 22.92 | 0.196 | | |
| | | | 3 | 0 | 1 | 21.44 | 22.01 | 0.159 | | |
| | | | 3 | 1 | 1 | 21.31 | 21.88 | 0.154 | | |
| | | | 3 | 2 | 1 | 21.20 | 21.77 | 0.150 | | |
| | | 26365 | 1882.5 | QPSK | 1 | 0 | 0 | 23.52 | 24.09 | 0.256 |
| | | | | | 1 | 2 | 0 | 23.37 | 23.94 | 0.248 |
| | | | | | 1 | 5 | 0 | 23.29 | 23.86 | 0.243 |
| | | | | | 3 | 0 | 0 | 22.61 | 23.18 | 0.208 |
| | | | | | 3 | 1 | 0 | 22.42 | 22.99 | 0.199 |
| | 3 | | | | 2 | 0 | 22.36 | 22.93 | 0.196 | |
| | 16QAM | 6 | 0 | 1 | 22.56 | 23.13 | 0.206 | | | |
| | | 1 | 0 | 1 | 22.59 | 23.16 | 0.207 | | | |
| | | 1 | 2 | 1 | 22.45 | 23.02 | 0.200 | | | |
| | | 1 | 5 | 1 | 22.39 | 22.96 | 0.198 | | | |
| | | 3 | 0 | 1 | 21.48 | 22.05 | 0.160 | | | |
| | | 3 | 1 | 1 | 21.29 | 21.86 | 0.153 | | | |
| | 26683 | 1914.3 | QPSK | 3 | 2 | 1 | 21.19 | 21.76 | 0.150 | |
| | | | | 6 | 0 | 2 | 21.38 | 21.95 | 0.157 | |
| | | | | 1 | 0 | 0 | 23.48 | 24.05 | 0.254 | |
| | | | | 1 | 2 | 0 | 23.36 | 23.93 | 0.247 | |
| | | | | 1 | 5 | 0 | 23.31 | 23.88 | 0.244 | |
| | | | | 3 | 0 | 0 | 22.57 | 23.14 | 0.206 | |
| | 16QAM | 3 | 1 | 0 | 22.41 | 22.98 | 0.199 | | | |
| | | 3 | 2 | 0 | 22.38 | 22.95 | 0.197 | | | |
| | | 6 | 0 | 1 | 22.52 | 23.09 | 0.204 | | | |
| | | 1 | 0 | 1 | 22.55 | 23.12 | 0.205 | | | |
| | | 1 | 2 | 1 | 22.44 | 23.01 | 0.200 | | | |
| 1 | | 5 | 1 | 22.41 | 22.98 | 0.199 | | | | |
| 26683 | 1914.3 | 16QAM | 3 | 0 | 1 | 21.41 | 21.98 | 0.158 | | |
| | | | 3 | 1 | 1 | 21.26 | 21.83 | 0.152 | | |
| | | | 3 | 2 | 1 | 21.41 | 21.98 | 0.158 | | |
| | | | 6 | 0 | 2 | 21.36 | 21.93 | 0.156 | | |

NOTE:

- (1) EIRP = Average power + Antenna gain.
- (2) ERP = EIRP - 2.15.
- (3) P(W) = $1 \text{ W} \cdot 10^{(P(\text{dBm}) / 10)} / 1000$

| Band | BW (MHz) | Channel | Frequency (MHz) | Mode | UL RB Allocation | UL RB Offset | MPR | Average power | EIRP power (dBm) | EIRP power (W) | |
|------|----------|---------|-----------------|--------|------------------|--------------|-------|---------------|------------------|----------------|-------|
| 25 | 3 | 26055 | 1851.5 | QPSK | 1 | 0 | 0 | 23.49 | 24.06 | 0.255 | |
| | | | | | 1 | 7 | 0 | 23.38 | 23.95 | 0.248 | |
| | | | | | 1 | 14 | 0 | 23.29 | 23.86 | 0.243 | |
| | | | | | 8 | 0 | 1 | 22.58 | 23.15 | 0.207 | |
| | | | | | 8 | 4 | 1 | 22.43 | 23.00 | 0.200 | |
| | | | | | 8 | 7 | 1 | 22.36 | 22.93 | 0.196 | |
| | | | | 15 | 0 | 1 | 22.53 | 23.10 | 0.204 | | |
| | | | | 16QAM | 1 | 0 | 1 | 22.56 | 23.13 | 0.206 | |
| | | | | | 1 | 7 | 1 | 22.46 | 23.03 | 0.201 | |
| | | | | | 1 | 14 | 1 | 22.39 | 22.96 | 0.198 | |
| | | | | | 8 | 0 | 2 | 21.48 | 22.05 | 0.160 | |
| | | | | | 8 | 4 | 2 | 21.35 | 21.92 | 0.156 | |
| | | | | | 8 | 7 | 2 | 21.24 | 21.81 | 0.152 | |
| | | | | | 15 | 0 | 2 | 21.45 | 22.02 | 0.159 | |
| | | | | | 26365 | 1882.5 | QPSK | 1 | 0 | 0 | 23.56 |
| | | 1 | 7 | | | | | 0 | 23.41 | 23.98 | 0.250 |
| | | 1 | 14 | 0 | | | | 23.33 | 23.90 | 0.245 | |
| | | 8 | 0 | 1 | | | | 22.65 | 23.22 | 0.210 | |
| | | 8 | 4 | 1 | | | | 22.46 | 23.03 | 0.201 | |
| | | 8 | 7 | 1 | | | | 22.40 | 22.97 | 0.198 | |
| | | 15 | 0 | 1 | | | 22.60 | 23.17 | 0.207 | | |
| | | 16QAM | 1 | 0 | | | 1 | 22.63 | 23.20 | 0.209 | |
| | | | 1 | 7 | | | 1 | 22.49 | 23.06 | 0.202 | |
| | | | 1 | 14 | | | 1 | 22.43 | 23.00 | 0.200 | |
| | | | 8 | 0 | | | 2 | 21.52 | 22.09 | 0.162 | |
| | | | 8 | 4 | | | 2 | 21.33 | 21.90 | 0.155 | |
| | | | 8 | 7 | | | 2 | 21.23 | 21.80 | 0.151 | |
| | | | 15 | 0 | | | 2 | 21.42 | 21.99 | 0.158 | |
| | | | 26675 | 1913.5 | | | QPSK | 1 | 0 | 0 | 23.52 |
| | | | | | 1 | 7 | | 0 | 23.40 | 23.97 | 0.249 |
| | | 1 | | | 14 | 0 | | 23.35 | 23.92 | 0.247 | |
| | | 8 | | | 0 | 1 | | 22.61 | 23.18 | 0.208 | |
| | | 8 | | | 4 | 1 | | 22.45 | 23.02 | 0.200 | |
| | | 8 | | | 7 | 1 | | 22.42 | 22.99 | 0.199 | |
| | | 15 | | | 0 | 1 | 22.56 | 23.13 | 0.206 | | |
| | | 16QAM | | | 1 | 0 | 1 | 22.59 | 23.16 | 0.207 | |
| | | | | | 1 | 7 | 1 | 22.48 | 23.05 | 0.202 | |
| | | | | | 1 | 14 | 1 | 22.45 | 23.02 | 0.200 | |
| | | | | | 8 | 0 | 2 | 21.45 | 22.02 | 0.159 | |
| | | | | | 8 | 4 | 2 | 21.30 | 21.87 | 0.154 | |
| | | | | | 8 | 7 | 2 | 21.45 | 22.02 | 0.159 | |
| | | | | | 15 | 0 | 2 | 21.40 | 21.97 | 0.157 | |

NOTE:

- (1) EIRP = Average power + Antenna gain.
- (2) ERP = EIRP - 2.15.
- (3) P(W) = $1 \text{ W} \cdot 10^{(P(\text{dBm}) / 10) / 1000}$

| Band | BW (MHz) | Channel | Frequency (MHz) | Mode | UL RB Allocation | UL RB Offset | MPR | Average power | EIRP power (dBm) | EIRP power (W) | | |
|-------|----------|---------|-----------------|-------|------------------|--------------|-----|---------------|------------------|----------------|-------|-------|
| 25 | 5 | 26065 | 1852.5 | QPSK | 1 | 0 | 0 | 23.57 | 24.14 | 0.259 | | |
| | | | | | 1 | 12 | 0 | 23.46 | 24.03 | 0.253 | | |
| | | | | | 1 | 24 | 0 | 23.37 | 23.94 | 0.248 | | |
| | | | | | 12 | 0 | 1 | 22.66 | 23.23 | 0.210 | | |
| | | | | | 12 | 6 | 1 | 22.51 | 23.08 | 0.203 | | |
| | | | | | 12 | 11 | 1 | 22.44 | 23.01 | 0.200 | | |
| | | | | 16QAM | 25 | 0 | 1 | 22.61 | 23.18 | 0.208 | | |
| | | | | | 1 | 0 | 1 | 22.64 | 23.21 | 0.209 | | |
| | | | | | 1 | 12 | 1 | 22.54 | 23.11 | 0.205 | | |
| | | | | | 1 | 24 | 1 | 22.47 | 23.04 | 0.201 | | |
| | | | | | 12 | 0 | 2 | 21.56 | 22.13 | 0.163 | | |
| | | | | | 12 | 6 | 2 | 21.43 | 22.00 | 0.158 | | |
| | | 26365 | 1882.5 | QPSK | 1882.5 | QPSK | 12 | 11 | 2 | 21.32 | 21.89 | 0.155 |
| | | | | | | | 25 | 0 | 2 | 21.53 | 22.10 | 0.162 |
| | | | | | | | 1 | 0 | 0 | 23.64 | 24.21 | 0.264 |
| | | | | | | | 1 | 12 | 0 | 23.49 | 24.06 | 0.255 |
| | | | | | | | 1 | 24 | 0 | 23.41 | 23.98 | 0.250 |
| | | | | | | | 12 | 0 | 1 | 22.73 | 23.30 | 0.214 |
| | | | | 16QAM | 12 | 6 | 1 | 22.54 | 23.11 | 0.205 | | |
| | | | | | 12 | 11 | 1 | 22.48 | 23.05 | 0.202 | | |
| | | | | | 25 | 0 | 1 | 22.68 | 23.25 | 0.211 | | |
| | | | | | 1 | 0 | 1 | 22.71 | 23.28 | 0.213 | | |
| | | | | | 1 | 12 | 1 | 22.57 | 23.14 | 0.206 | | |
| | | | | | 1 | 24 | 1 | 22.51 | 23.08 | 0.203 | | |
| | | 26665 | 1912.5 | QPSK | 1912.5 | QPSK | 12 | 0 | 2 | 21.60 | 22.17 | 0.165 |
| | | | | | | | 12 | 6 | 2 | 21.41 | 21.98 | 0.158 |
| | | | | | | | 12 | 11 | 2 | 21.31 | 21.88 | 0.154 |
| | | | | | | | 25 | 0 | 2 | 21.50 | 22.07 | 0.161 |
| | | | | | | | 1 | 0 | 0 | 23.60 | 24.17 | 0.261 |
| | | | | | | | 1 | 12 | 0 | 23.48 | 24.05 | 0.254 |
| | | | | 16QAM | 1 | 24 | 0 | 23.43 | 24.00 | 0.251 | | |
| | | | | | 12 | 0 | 1 | 22.69 | 23.26 | 0.212 | | |
| | | | | | 12 | 6 | 1 | 22.53 | 23.10 | 0.204 | | |
| | | | | | 12 | 11 | 1 | 22.50 | 23.07 | 0.203 | | |
| | | | | | 25 | 0 | 1 | 22.64 | 23.21 | 0.209 | | |
| | | | | | 1 | 0 | 1 | 22.67 | 23.24 | 0.211 | | |
| 16QAM | 1 | 12 | 1 | 22.56 | 23.13 | 0.206 | | | | | | |
| | 1 | 24 | 1 | 22.53 | 23.10 | 0.204 | | | | | | |
| | 12 | 0 | 2 | 21.53 | 22.10 | 0.162 | | | | | | |
| | 12 | 6 | 2 | 21.38 | 21.95 | 0.157 | | | | | | |
| | 12 | 11 | 2 | 21.53 | 22.10 | 0.162 | | | | | | |
| | 25 | 0 | 2 | 21.48 | 22.05 | 0.160 | | | | | | |

NOTE:

- (1) EIRP = Average power + Antenna gain.
- (2) ERP = EIRP - 2.15.
- (3) $P(W) = 1 W \cdot 10^{(P(dBm) / 10) / 1000}$

| Band | BW (MHz) | Channel | Frequency (MHz) | Mode | UL RB Allocation | UL RB Offset | MPR | Average power | EIRP power (dBm) | EIRP power (W) |
|-------|----------|---------|-----------------|-------|------------------|--------------|-------|---------------|------------------|----------------|
| 25 | 10 | 26090 | 1855.0 | QPSK | 1 | 0 | 0 | 23.64 | 24.21 | 0.264 |
| | | | | | 1 | 24 | 0 | 23.53 | 24.10 | 0.257 |
| | | | | | 1 | 49 | 0 | 23.44 | 24.01 | 0.252 |
| | | | | | 25 | 0 | 1 | 22.73 | 23.30 | 0.214 |
| | | | | | 25 | 12 | 1 | 22.58 | 23.15 | 0.207 |
| | | | | 25 | 24 | 1 | 22.51 | 23.08 | 0.203 | |
| | | | | 50 | 0 | 1 | 22.68 | 23.25 | 0.211 | |
| | | | | 16QAM | 1 | 0 | 1 | 22.71 | 23.28 | 0.213 |
| | | | | | 1 | 24 | 1 | 22.61 | 23.18 | 0.208 |
| | | | | | 1 | 49 | 1 | 22.54 | 23.11 | 0.205 |
| | | 25 | 0 | | 2 | 21.63 | 22.20 | 0.166 | | |
| | | 25 | 12 | | 2 | 21.50 | 22.07 | 0.161 | | |
| | | 25 | 24 | 2 | 21.39 | 21.96 | 0.157 | | | |
| | | 50 | 0 | 2 | 21.60 | 22.17 | 0.165 | | | |
| | | 26365 | 1882.5 | QPSK | 1 | 0 | 0 | 23.71 | 24.28 | 0.268 |
| | | | | | 1 | 24 | 0 | 23.56 | 24.13 | 0.259 |
| | | | | | 1 | 49 | 0 | 23.48 | 24.05 | 0.254 |
| | | | | | 25 | 0 | 1 | 22.80 | 23.37 | 0.217 |
| | | | | | 25 | 12 | 1 | 22.61 | 23.18 | 0.208 |
| | | | | 25 | 24 | 1 | 22.55 | 23.12 | 0.205 | |
| | | | | 50 | 0 | 1 | 22.75 | 23.32 | 0.215 | |
| | | | | 16QAM | 1 | 0 | 1 | 22.78 | 23.35 | 0.216 |
| | | | | | 1 | 24 | 1 | 22.64 | 23.21 | 0.209 |
| | | | | | 1 | 49 | 1 | 22.58 | 23.15 | 0.207 |
| | | 25 | 0 | | 2 | 21.67 | 22.24 | 0.167 | | |
| | | 25 | 12 | | 2 | 21.48 | 22.05 | 0.160 | | |
| | | 25 | 24 | 2 | 21.38 | 21.95 | 0.157 | | | |
| | | 50 | 0 | 2 | 21.57 | 22.14 | 0.164 | | | |
| | | 26640 | 1910.0 | QPSK | 1 | 0 | 0 | 23.67 | 24.24 | 0.265 |
| | | | | | 1 | 24 | 0 | 23.55 | 24.12 | 0.258 |
| 1 | 49 | | | | 0 | 23.50 | 24.07 | 0.255 | | |
| 25 | 0 | | | | 1 | 22.76 | 23.33 | 0.215 | | |
| 25 | 12 | | | | 1 | 22.60 | 23.17 | 0.207 | | |
| 25 | 24 | | | 1 | 22.57 | 23.14 | 0.206 | | | |
| 50 | 0 | | | 1 | 22.71 | 23.28 | 0.213 | | | |
| 16QAM | 1 | | | 0 | 1 | 22.74 | 23.31 | 0.214 | | |
| | 1 | | | 24 | 1 | 22.63 | 23.20 | 0.209 | | |
| | 1 | | | 49 | 1 | 22.60 | 23.17 | 0.207 | | |
| | 25 | 0 | 2 | 21.60 | 22.17 | 0.165 | | | | |
| | 25 | 12 | 2 | 21.45 | 22.02 | 0.159 | | | | |
| 25 | 24 | 2 | 21.60 | 22.17 | 0.165 | | | | | |
| 50 | 0 | 2 | 21.55 | 22.12 | 0.163 | | | | | |

NOTE:

- (1) EIRP = Average power + Antenna gain.
- (2) ERP = EIRP - 2.15.
- (3) P(W) = $1 \text{ W} \cdot 10^{(P(\text{dBm}) / 10) / 1000}$

| Band | BW (MHz) | Channel | Frequency (MHz) | Mode | UL RB Allocation | UL RB Offset | MPR | Average power | EIRP power (dBm) | EIRP power (W) |
|------|----------|---------|-----------------|-------|------------------|--------------|-------|---------------|------------------|----------------|
| 25 | 15 | 26115 | 1857.5 | QPSK | 1 | 0 | 0 | 23.69 | 24.26 | 0.267 |
| | | | | | 1 | 37 | 0 | 23.58 | 24.15 | 0.260 |
| | | | | | 1 | 74 | 0 | 23.49 | 24.06 | 0.255 |
| | | | | | 36 | 0 | 1 | 22.78 | 23.35 | 0.216 |
| | | | | | 36 | 18 | 1 | 22.63 | 23.20 | 0.209 |
| | | | | | 36 | 37 | 1 | 22.56 | 23.13 | 0.206 |
| | | | | 75 | 0 | 1 | 22.73 | 23.30 | 0.214 | |
| | | | | 16QAM | 1 | 0 | 1 | 22.76 | 23.33 | 0.215 |
| | | | | | 1 | 37 | 1 | 22.66 | 23.23 | 0.210 |
| | | 1 | 74 | | 1 | 22.59 | 23.16 | 0.207 | | |
| | | 36 | 0 | | 2 | 21.68 | 22.25 | 0.168 | | |
| | | 36 | 18 | | 2 | 21.55 | 22.12 | 0.163 | | |
| | | 36 | 37 | | 2 | 21.44 | 22.01 | 0.159 | | |
| | | 26365 | 1882.5 | QPSK | 1 | 0 | 0 | 23.76 | 24.33 | 0.271 |
| | | | | | 1 | 37 | 0 | 23.61 | 24.18 | 0.262 |
| | | | | | 1 | 74 | 0 | 23.53 | 24.10 | 0.257 |
| | | | | | 36 | 0 | 1 | 22.85 | 23.42 | 0.220 |
| | | | | | 36 | 18 | 1 | 22.66 | 23.23 | 0.210 |
| | 36 | | | | 37 | 1 | 22.60 | 23.17 | 0.207 | |
| | 75 | | | 0 | 1 | 22.80 | 23.37 | 0.217 | | |
| | 16QAM | | | 1 | 0 | 1 | 22.83 | 23.40 | 0.219 | |
| | | | | 1 | 37 | 1 | 22.69 | 23.26 | 0.212 | |
| | | 1 | 74 | 1 | 22.63 | 23.20 | 0.209 | | | |
| | | 36 | 0 | 2 | 21.72 | 22.29 | 0.169 | | | |
| | | 36 | 18 | 2 | 21.53 | 22.10 | 0.162 | | | |
| | | 36 | 37 | 2 | 21.43 | 22.00 | 0.158 | | | |
| | 26615 | 1907.5 | QPSK | 75 | 0 | 2 | 21.62 | 22.19 | 0.166 | |
| | | | | 1 | 0 | 0 | 23.72 | 24.29 | 0.269 | |
| | | | | 1 | 37 | 0 | 23.60 | 24.17 | 0.261 | |
| | | | | 1 | 74 | 0 | 23.55 | 24.12 | 0.258 | |
| | | | | 36 | 0 | 1 | 22.81 | 23.38 | 0.218 | |
| | | | | 36 | 18 | 1 | 22.65 | 23.22 | 0.210 | |
| | | | 36 | 37 | 1 | 22.62 | 23.19 | 0.208 | | |
| | | | 75 | 0 | 1 | 22.76 | 23.33 | 0.215 | | |
| | | | 16QAM | 1 | 0 | 1 | 22.79 | 23.36 | 0.217 | |
| | 1 | 37 | | 1 | 22.68 | 23.25 | 0.211 | | | |
| 1 | 74 | 1 | | 22.65 | 23.22 | 0.210 | | | | |
| 36 | 0 | 2 | | 21.65 | 22.22 | 0.167 | | | | |
| 36 | 18 | 2 | | 21.50 | 22.07 | 0.161 | | | | |
| 36 | 37 | 2 | | 21.65 | 22.22 | 0.167 | | | | |
| 75 | 0 | 2 | 21.60 | 22.17 | 0.165 | | | | | |

NOTE:

- (1) EIRP = Average power + Antenna gain.
- (2) ERP = EIRP - 2.15.
- (3) P(W) = $1 \text{ W} \cdot 10^{(P(\text{dBm}) / 10) / 1000}$

| Band | BW (MHz) | Channel | Frequency (MHz) | Mode | UL RB Allocation | UL RB Offset | MPR | Average power | EIRP power (dBm) | EIRP power (W) | | |
|-------|----------|---------|-----------------|-------|------------------|--------------|-------|---------------|------------------|----------------|-------|-------|
| 25 | 20 | 26140 | 1860.0 | QPSK | 1 | 0 | 0 | 23.82 | 24.39 | 0.275 | | |
| | | | | | 1 | 49 | 0 | 23.71 | 24.28 | 0.268 | | |
| | | | | | 1 | 99 | 0 | 23.62 | 24.19 | 0.262 | | |
| | | | | | 50 | 0 | 1 | 22.91 | 23.48 | 0.223 | | |
| | | | | | 50 | 24 | 1 | 22.76 | 23.33 | 0.215 | | |
| | | | | | 50 | 49 | 1 | 22.69 | 23.26 | 0.212 | | |
| | | | | 100 | 0 | 1 | 22.86 | 23.43 | 0.220 | | | |
| | | | | 16QAM | 1 | 0 | 1 | 22.89 | 23.46 | 0.222 | | |
| | | | | | 1 | 49 | 1 | 22.79 | 23.36 | 0.217 | | |
| | | | | | 1 | 99 | 1 | 22.72 | 23.29 | 0.213 | | |
| | | | | | 50 | 0 | 2 | 21.81 | 22.38 | 0.173 | | |
| | | | | | 50 | 24 | 2 | 21.68 | 22.25 | 0.168 | | |
| | | 50 | 49 | | 2 | 21.57 | 22.14 | 0.164 | | | | |
| | | 26365 | 1882.5 | QPSK | 1882.5 | QPSK | 100 | 0 | 2 | 21.78 | 22.35 | 0.172 |
| | | | | | | | 1 | 0 | 0 | 23.89 | 24.46 | 0.279 |
| | | | | | | | 1 | 49 | 0 | 23.74 | 24.31 | 0.270 |
| | | | | | | | 1 | 99 | 0 | 23.66 | 24.23 | 0.265 |
| | | | | | | | 50 | 0 | 1 | 22.98 | 23.55 | 0.226 |
| | | | | | | | 50 | 24 | 1 | 22.79 | 23.36 | 0.217 |
| | | | | 50 | 49 | 1 | 22.73 | 23.30 | 0.214 | | | |
| | | | | 100 | 0 | 1 | 22.93 | 23.50 | 0.224 | | | |
| | | | | 16QAM | 1 | 0 | 1 | 22.96 | 23.53 | 0.225 | | |
| | | | | | 1 | 49 | 1 | 22.82 | 23.39 | 0.218 | | |
| | | | | | 1 | 99 | 1 | 22.76 | 23.33 | 0.215 | | |
| | | | | | 50 | 0 | 2 | 21.85 | 22.42 | 0.175 | | |
| | | 50 | 24 | | 2 | 21.66 | 22.23 | 0.167 | | | | |
| | | 50 | 49 | | 2 | 21.56 | 22.13 | 0.163 | | | | |
| | | 26590 | 1905.0 | QPSK | 1905.0 | QPSK | 100 | 0 | 2 | 21.75 | 22.32 | 0.171 |
| | | | | | | | 1 | 0 | 0 | 23.85 | 24.42 | 0.277 |
| | | | | | | | 1 | 49 | 0 | 23.73 | 24.30 | 0.269 |
| 1 | 99 | | | | | | 0 | 23.68 | 24.25 | 0.266 | | |
| 50 | 0 | | | | | | 1 | 22.94 | 23.51 | 0.224 | | |
| 50 | 24 | | | | | | 1 | 22.78 | 23.35 | 0.216 | | |
| 50 | 49 | | | 1 | 22.75 | 23.32 | 0.215 | | | | | |
| 100 | 0 | | | 1 | 22.89 | 23.46 | 0.222 | | | | | |
| 16QAM | 1 | | | 0 | 1 | 22.92 | 23.49 | 0.223 | | | | |
| | 1 | | | 49 | 1 | 22.81 | 23.38 | 0.218 | | | | |
| | 1 | | | 99 | 1 | 22.78 | 23.35 | 0.216 | | | | |
| | 50 | | | 0 | 2 | 21.78 | 22.35 | 0.172 | | | | |
| | 50 | 24 | 2 | 21.63 | 22.20 | 0.166 | | | | | | |
| | 50 | 49 | 2 | 21.78 | 22.35 | 0.172 | | | | | | |
| 100 | 0 | 2 | 21.73 | 22.30 | 0.170 | | | | | | | |

NOTE:

- (1) EIRP = Average power + Antenna gain.
- (2) ERP = EIRP - 2.15.
- (3) P(W) = $1 \text{ W} \cdot 10^{(P(\text{dBm}) / 10) / 1000}$

Radiated ERIP Power:

| | | | |
|--------------|---------------|--------------|----------|
| Test Mode | WCDMA Band II | Test Date | 2022/3/3 |
| Test Channel | CH9262 | Polarization | Vertical |
| Temp | 21°C | Hum. | 64% |

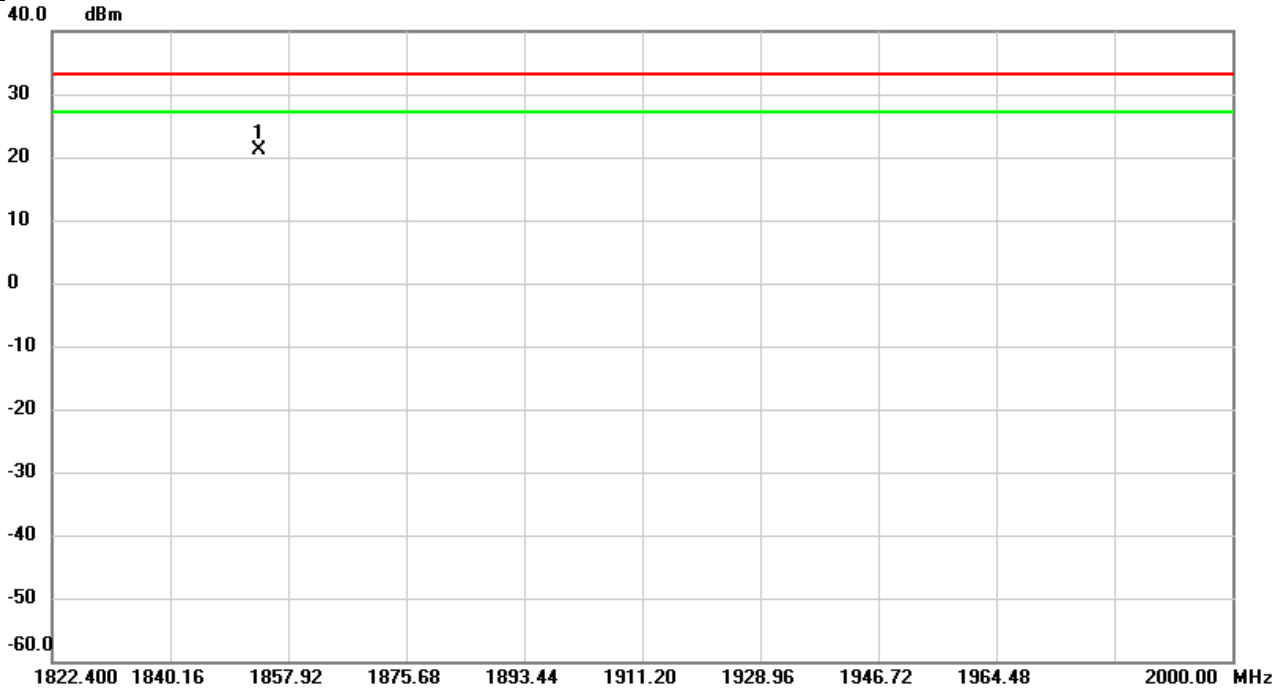

| No. | Mk. | Freq. MHz | Reading Level dBm | Correct Factor dB | Measure- ment dBm | Limit dBm | Over dB | Detector | Comment |
|-----|-----|--------------|-------------------------|-------------------------|-------------------------|--------------|------------|----------|---------|
| 1 | * | 1853.598 | -18.48 | 39.68 | 21.20 | 33.01 | -11.81 | peak | |

REMARKS:

- (1) Measurement Value = Reading Level + Correct Factor.
- (2) Margin Level = Measurement Value - Limit Value.

| | | | |
|--------------|---------------|--------------|------------|
| Test Mode | WCDMA Band II | Test Date | 2022/3/3 |
| Test Channel | CH9262 | Polarization | Horizontal |
| Temp | 21°C | Hum. | 64% |

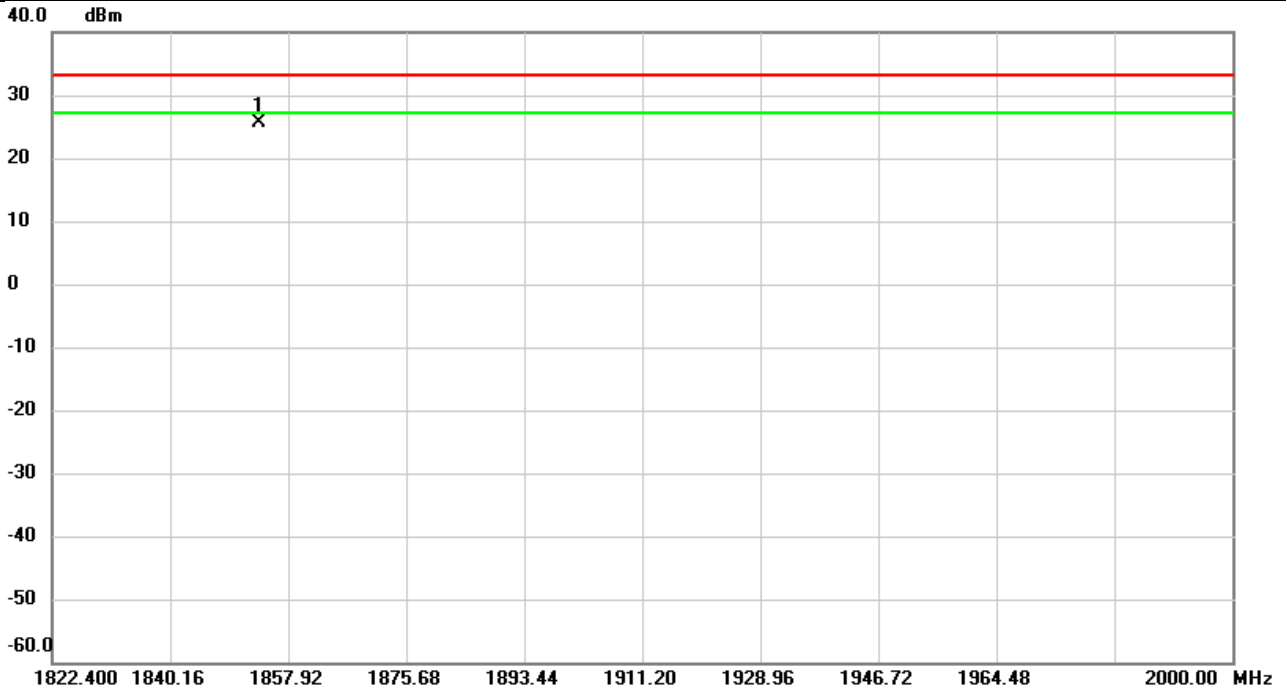

| No. | Mk. | Freq. MHz | Reading Level dBm | Correct Factor dB | Measure- ment dBm | Limit dBm | Over dB | Detector | Comment |
|-----|-----|--------------|-------------------------|-------------------------|-------------------------|--------------|------------|----------|---------|
| 1 | * | 1853.640 | -15.01 | 40.60 | 25.59 | 33.01 | -7.42 | peak | |

REMARKS:

- (1) Measurement Value = Reading Level + Correct Factor.
- (2) Margin Level = Measurement Value - Limit Value.

| | | | |
|--------------|---------------|--------------|----------|
| Test Mode | WCDMA Band II | Test Date | 2022/3/3 |
| Test Channel | CH9400 | Polarization | Vertical |
| Temp | 21°C | Hum. | 64% |

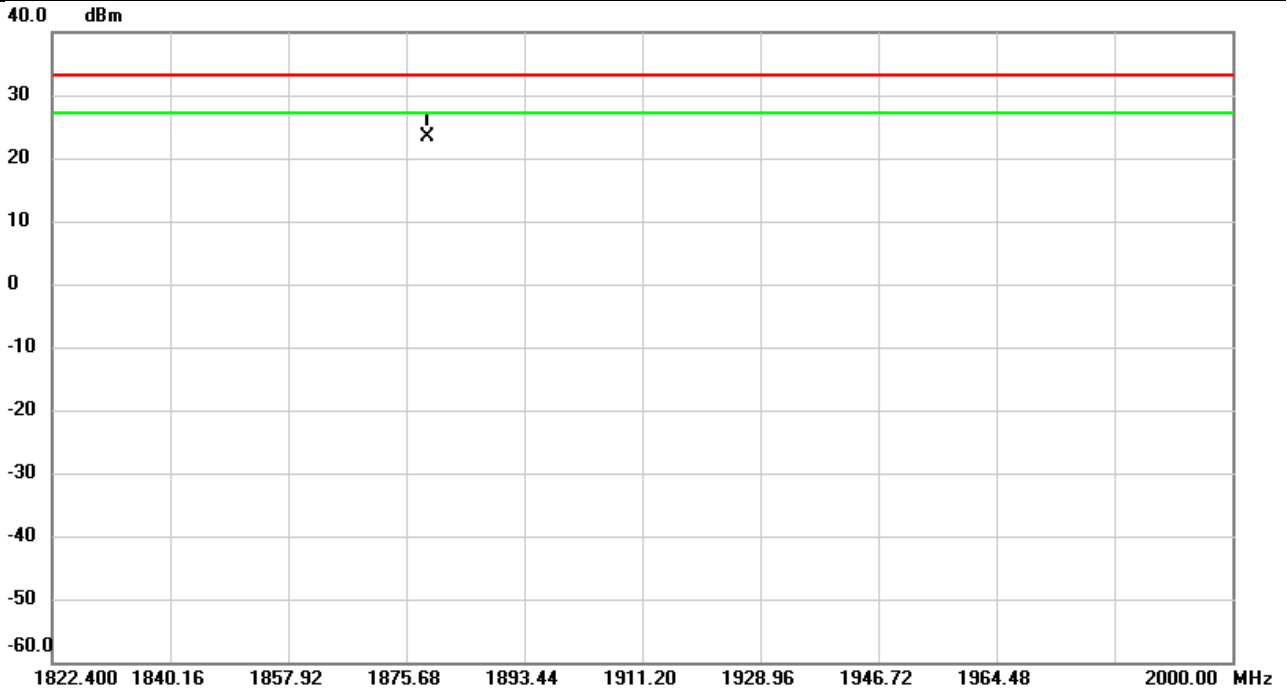

| No. | Mk. | Freq. MHz | Reading Level dBm | Correct Factor dB | Measure- ment dBm | Limit dBm | Over dB | Detector | Comment |
|-----|-----|--------------|-------------------------|-------------------------|-------------------------|--------------|------------|----------|---------|
| 1 | * | 1878.794 | -16.43 | 39.78 | 23.35 | 33.01 | -9.66 | peak | |

REMARKS:

- (1) Measurement Value = Reading Level + Correct Factor.
- (2) Margin Level = Measurement Value - Limit Value.

| | | | |
|--------------|---------------|--------------|------------|
| Test Mode | WCDMA Band II | Test Date | 2022/3/3 |
| Test Channel | CH9400 | Polarization | Horizontal |
| Temp | 21°C | Hum. | 64% |

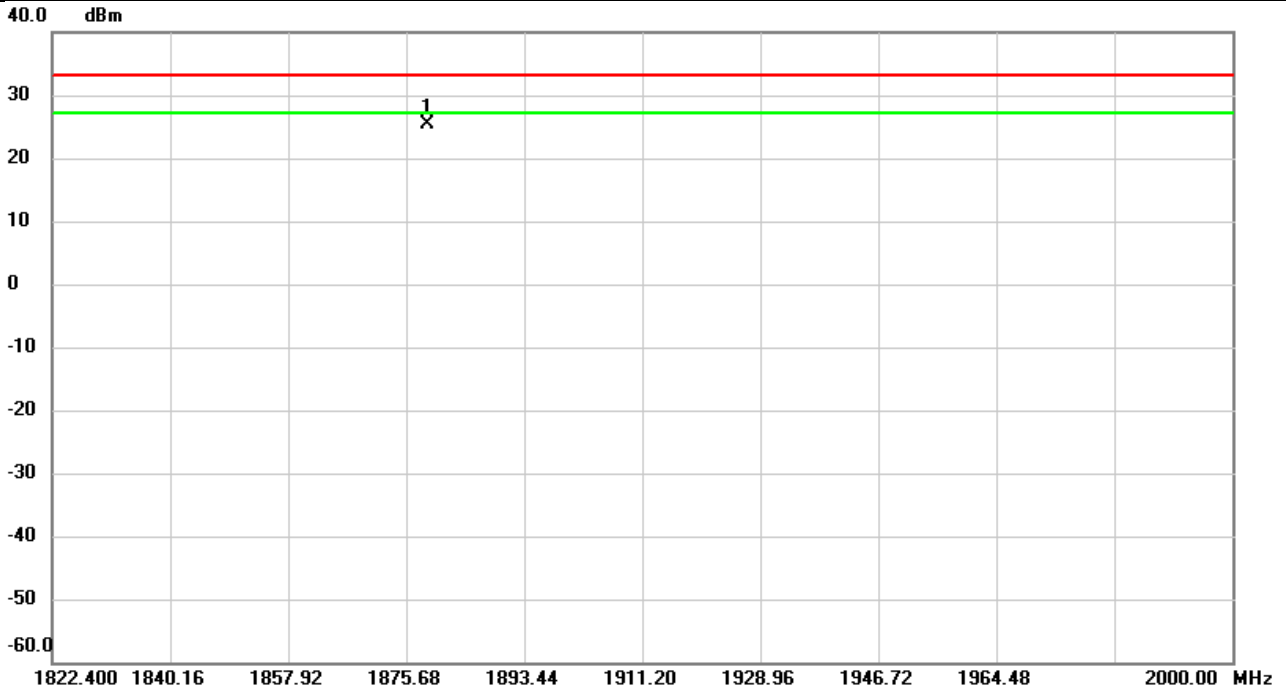

| No. | Mk. | Freq. MHz | Reading Level dBm | Correct Factor dB | Measure- ment dBm | Limit dBm | Over dB | Detector | Comment |
|-----|-----|--------------|-------------------------|-------------------------|-------------------------|--------------|------------|----------|---------|
| 1 | * | 1878.841 | -15.27 | 40.73 | 25.46 | 33.01 | -7.55 | peak | |

REMARKS:

- (1) Measurement Value = Reading Level + Correct Factor.
- (2) Margin Level = Measurement Value - Limit Value.

| | | | |
|--------------|---------------|--------------|----------|
| Test Mode | WCDMA Band II | Test Date | 2022/3/3 |
| Test Channel | CH9538 | Polarization | Vertical |
| Temp | 21°C | Hum. | 64% |

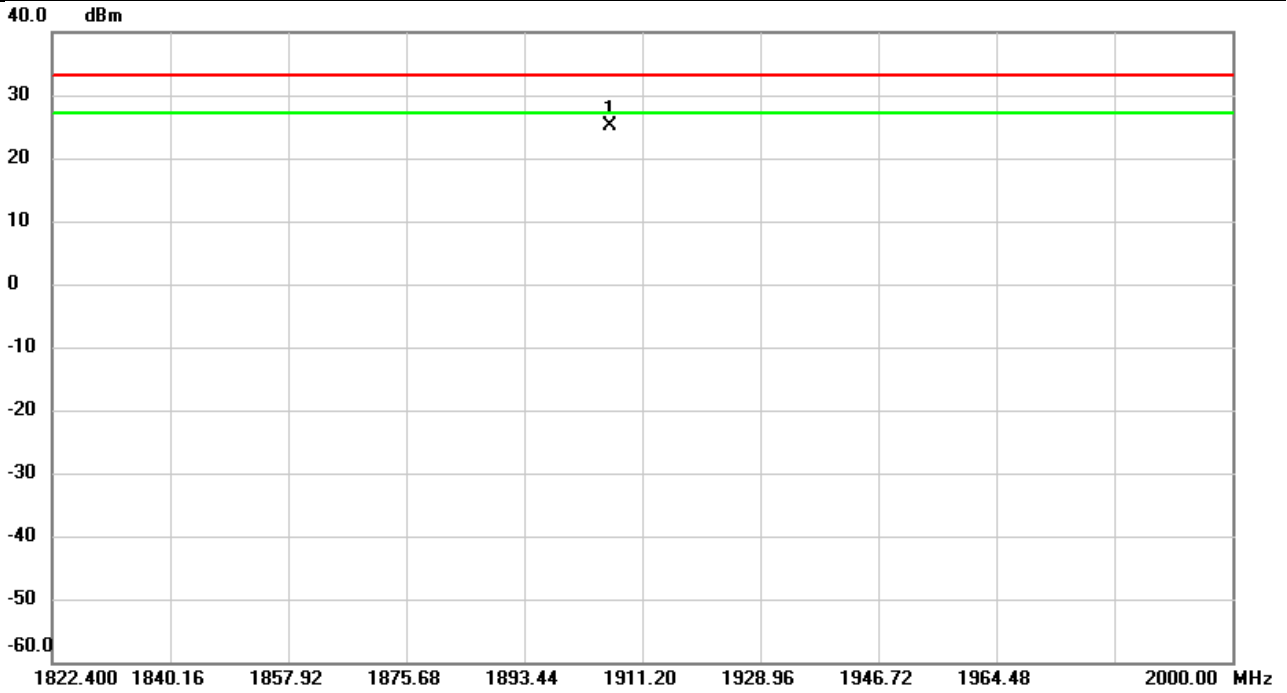

| No. | Mk. | Freq. | Reading Level | Correct Factor | Measurement | Limit | Over | Detector | Comment |
|-----|-----|----------|---------------|----------------|-------------|-------|-------|----------|---------|
| | | MHz | dBm | dB | dBm | dBm | dB | | |
| 1 | * | 1906.346 | -14.71 | 39.88 | 25.17 | 33.01 | -7.84 | peak | |

REMARKS:

- (1) Measurement Value = Reading Level + Correct Factor.
- (2) Margin Level = Measurement Value - Limit Value.

| | | | |
|--------------|---------------|--------------|------------|
| Test Mode | WCDMA Band II | Test Date | 2022/3/3 |
| Test Channel | CH9538 | Polarization | Horizontal |
| Temp | 21°C | Hum. | 64% |

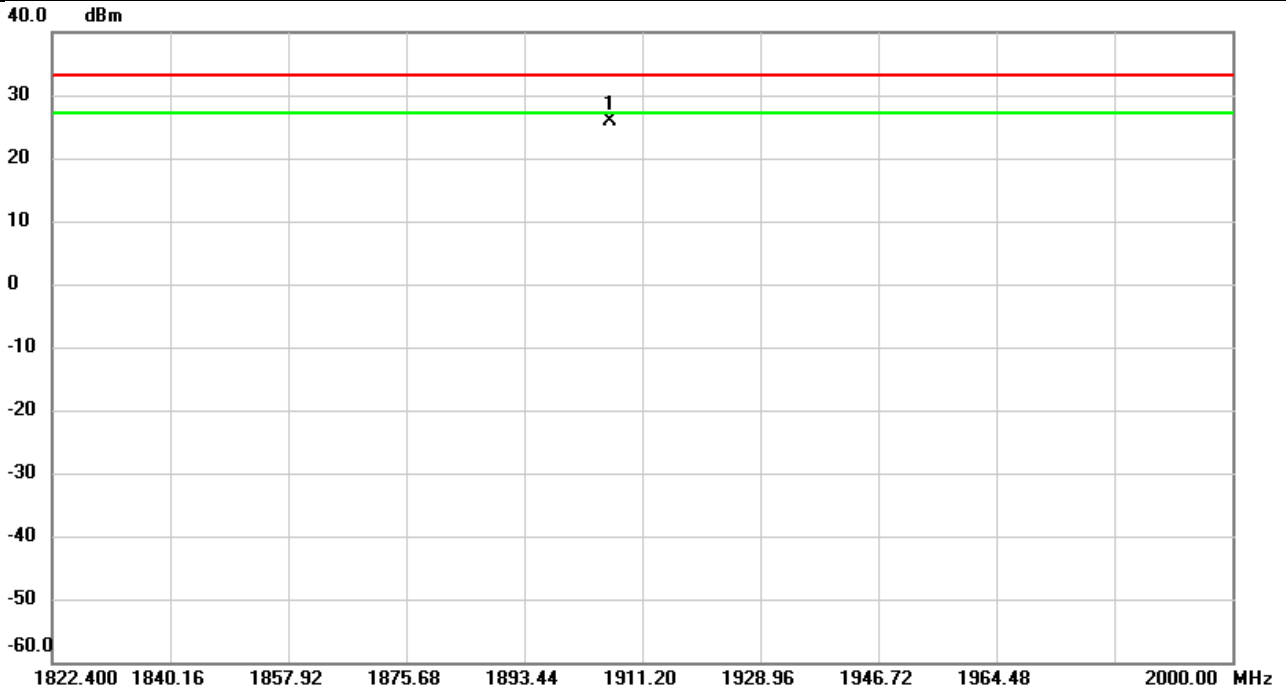

| No. | Mk. | Freq. MHz | Reading Level dBm | Correct Factor dB | Measure- ment dBm | Limit dBm | Over dB | Detector | Comment |
|-----|-----|--------------|-------------------------|-------------------------|-------------------------|--------------|------------|----------|---------|
| 1 | * | 1906.393 | -15.04 | 40.87 | 25.83 | 33.01 | -7.18 | peak | |

REMARKS:

- (1) Measurement Value = Reading Level + Correct Factor.
- (2) Margin Level = Measurement Value - Limit Value.

| | | | |
|--------------|------------|--------------|-----------|
| Test Mode | LTE Band 2 | Test Date | 2022/2/21 |
| Test Channel | CH18700 | Polarization | Vertical |
| Temp | 20°C | Hum. | 62% |

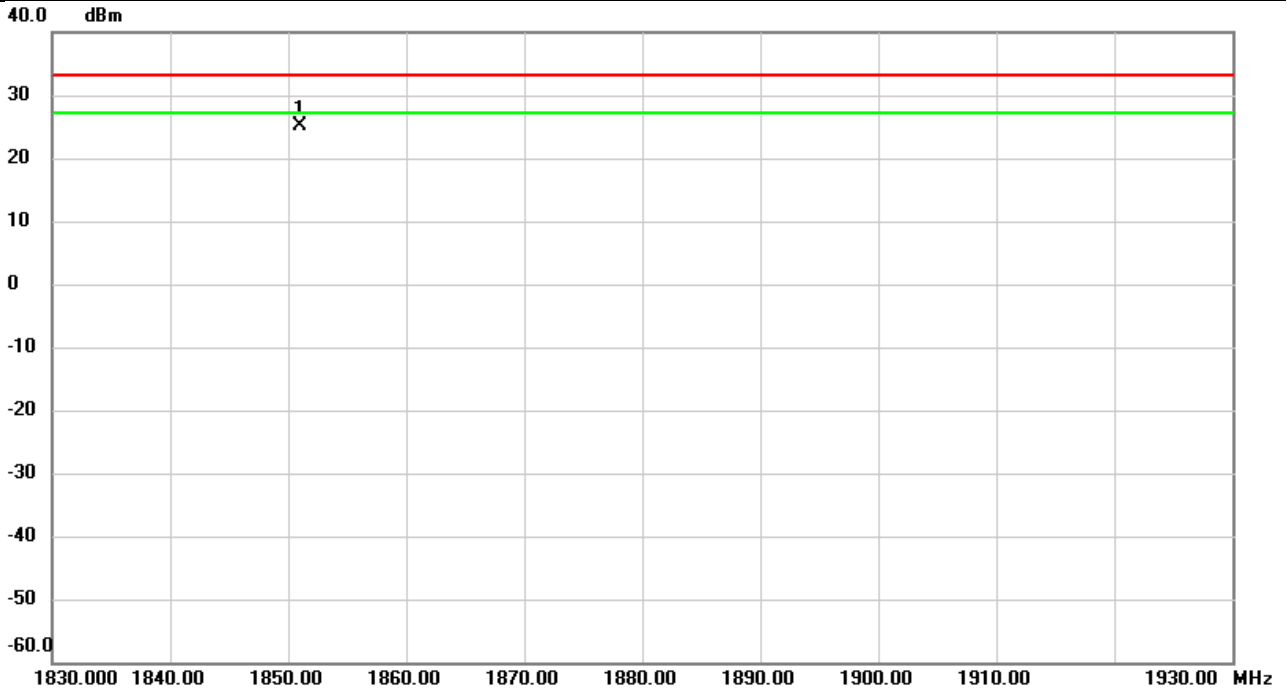

| No. | Mk. | Freq. | Reading Level | Correct Factor | Measurement | Limit | Over | Detector | Comment |
|-----|-----|----------|---------------|----------------|-------------|-------|-------|----------|---------|
| | | MHz | dBm | dB | dBm | dBm | dB | | |
| 1 | * | 1851.037 | -14.45 | 39.67 | 25.22 | 33.01 | -7.79 | peak | |

REMARKS:

- (1) Measurement Value = Reading Level + Correct Factor.
- (2) Margin Level = Measurement Value - Limit Value.

| | | | |
|--------------|------------|--------------|------------|
| Test Mode | LTE Band 2 | Test Date | 2022/2/21 |
| Test Channel | CH18700 | Polarization | Horizontal |
| Temp | 20°C | Hum. | 62% |

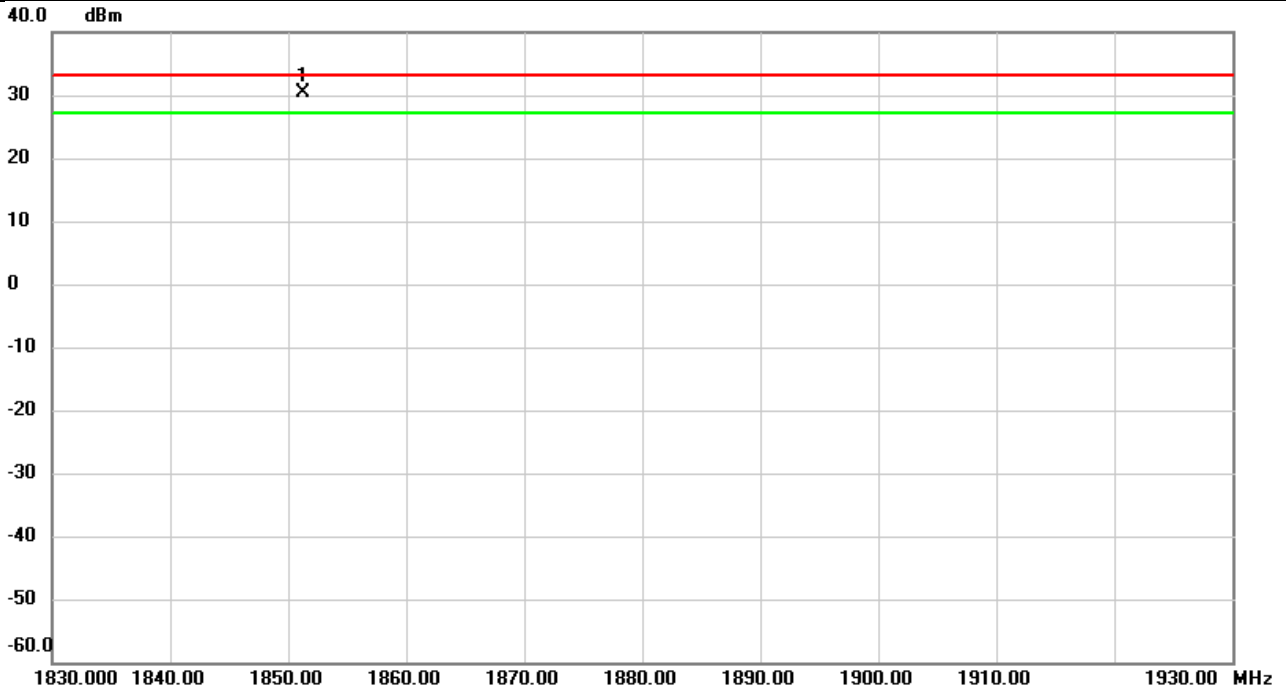

| No. | Mk. | Freq. | Reading Level | Correct Factor | Measurement | Limit | Over | Detector | Comment |
|-----|-----|----------|---------------|----------------|-------------|-------|-------|----------|---------|
| | | MHz | dBm | dB | dBm | dBm | dB | | |
| 1 | * | 1851.210 | -10.19 | 40.59 | 30.40 | 33.01 | -2.61 | peak | |

REMARKS:

- (1) Measurement Value = Reading Level + Correct Factor.
- (2) Margin Level = Measurement Value - Limit Value.

| | | | |
|--------------|------------|--------------|-----------|
| Test Mode | LTE Band 2 | Test Date | 2022/2/21 |
| Test Channel | CH18900 | Polarization | Vertical |
| Temp | 20°C | Hum. | 62% |

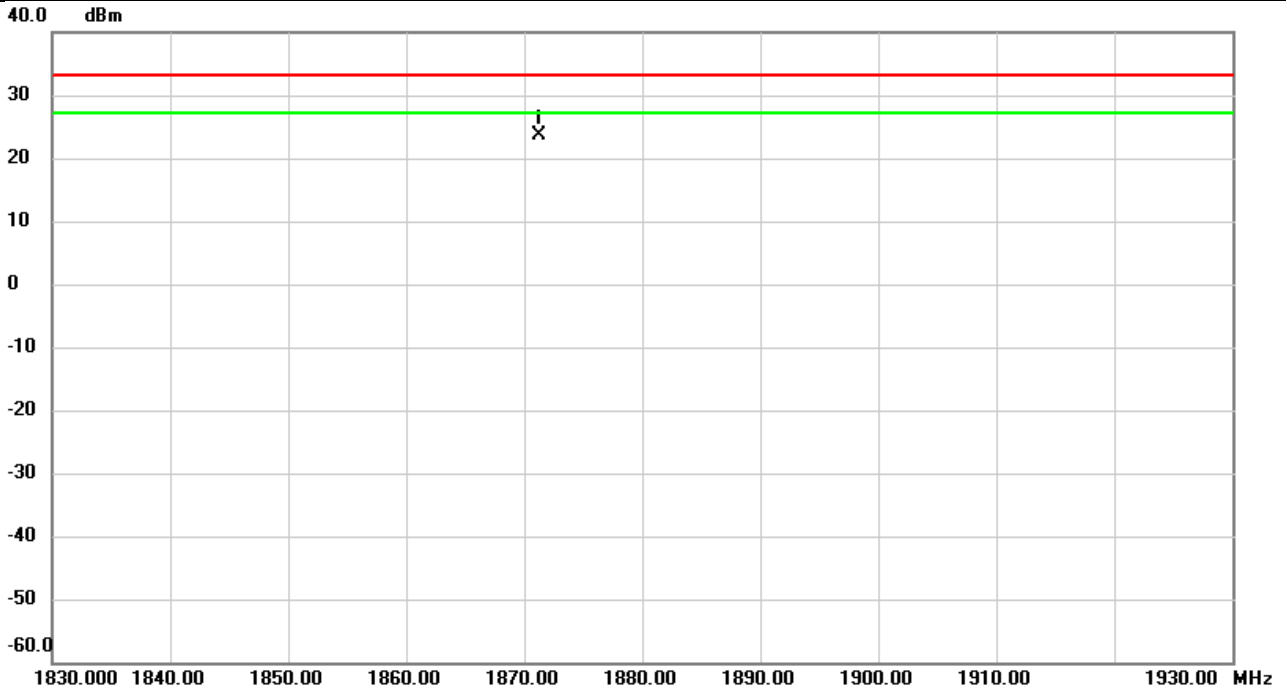

| No. | Mk. | Freq. | Reading Level | Correct Factor | Measurement | Limit | Over | Detector | Comment |
|-----|-----|----------|---------------|----------------|-------------|-------|-------|----------|---------|
| | | MHz | dBm | dB | dBm | dBm | dB | | |
| 1 | * | 1871.290 | -16.03 | 39.75 | 23.72 | 33.01 | -9.29 | peak | |

REMARKS:

- (1) Measurement Value = Reading Level + Correct Factor.
- (2) Margin Level = Measurement Value - Limit Value.

| | | | |
|--------------|------------|--------------|------------|
| Test Mode | LTE Band 2 | Test Date | 2022/2/21 |
| Test Channel | CH18900 | Polarization | Horizontal |
| Temp | 20°C | Hum. | 62% |

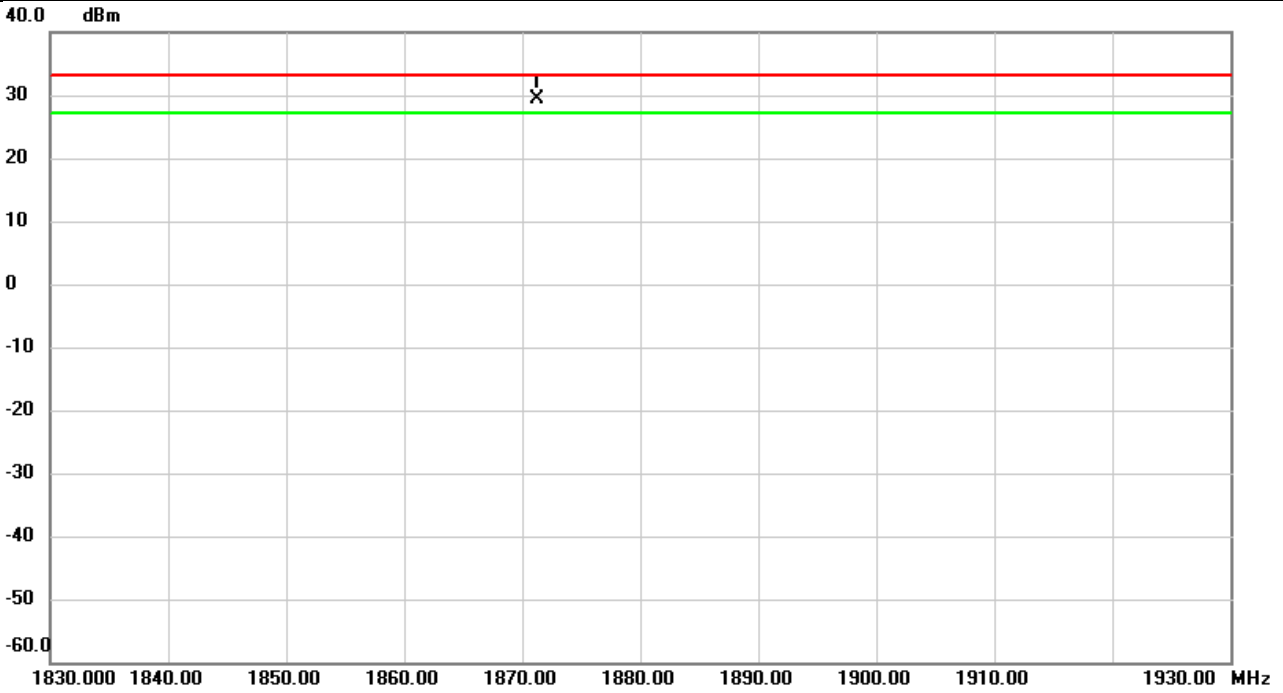

| No. | Mk. | Freq. MHz | Reading Level dBm | Correct Factor dB | Measure- ment dBm | Limit dBm | Over dB | Detector | Comment |
|-----|-----|--------------|-------------------------|-------------------------|-------------------------|--------------|------------|----------|---------|
| 1 | * | 1871.250 | -11.41 | 40.69 | 29.28 | 33.01 | -3.73 | peak | |

REMARKS:

- (1) Measurement Value = Reading Level + Correct Factor.
- (2) Margin Level = Measurement Value - Limit Value.

| | | | |
|--------------|------------|--------------|-----------|
| Test Mode | LTE Band 2 | Test Date | 2022/2/21 |
| Test Channel | CH19100 | Polarization | Vertical |
| Temp | 20°C | Hum. | 62% |

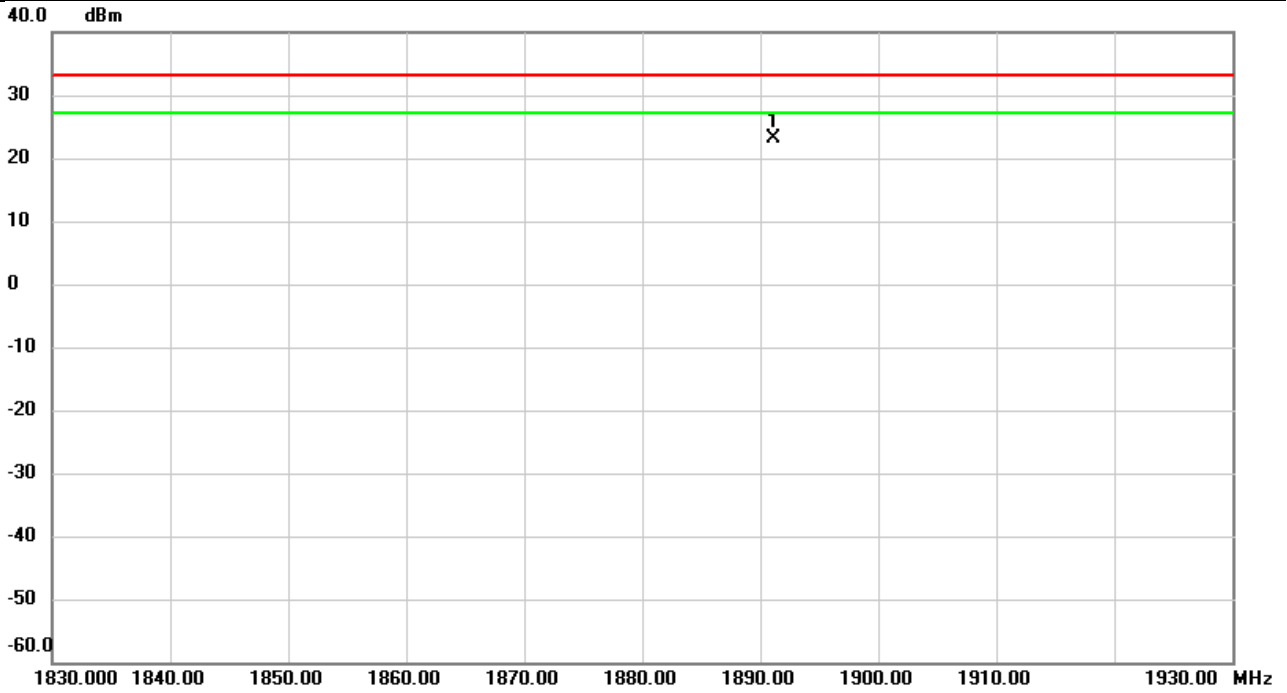

| No. | Mk. | Freq. | Reading Level | Correct Factor | Measurement | Limit | Over | Detector | Comment |
|-----|-----|----------|---------------|----------------|-------------|-------|-------|----------|---------|
| | | MHz | dBm | dB | dBm | dBm | dB | | |
| 1 | * | 1891.080 | -16.60 | 39.83 | 23.23 | 33.01 | -9.78 | peak | |

REMARKS:

- (1) Measurement Value = Reading Level + Correct Factor.
- (2) Margin Level = Measurement Value - Limit Value.

| | | | |
|--------------|------------|--------------|------------|
| Test Mode | LTE Band 2 | Test Date | 2022/2/21 |
| Test Channel | CH19100 | Polarization | Horizontal |
| Temp | 20°C | Hum. | 62% |

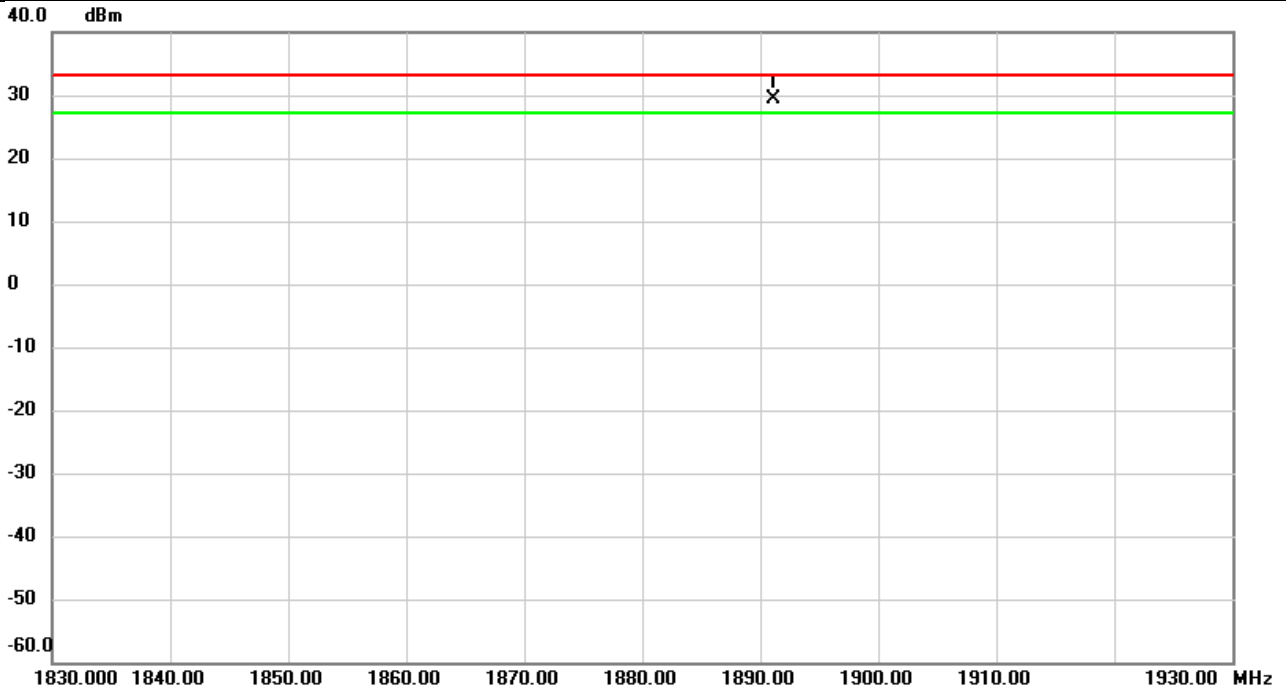

| No. | Mk. | Freq. | Reading Level | Correct Factor | Measurement | Limit | Over | Detector | Comment |
|-----|-----|----------|---------------|----------------|-------------|-------|-------|----------|---------|
| | | MHz | dBm | dB | dBm | dBm | dB | | |
| 1 | * | 1891.140 | -11.48 | 40.79 | 29.31 | 33.01 | -3.70 | peak | |

REMARKS:

- (1) Measurement Value = Reading Level + Correct Factor.
- (2) Margin Level = Measurement Value - Limit Value.

| | | | |
|--------------|-------------|--------------|----------|
| Test Mode | LTE Band 25 | Test Date | 2022/3/3 |
| Test Channel | CH26140 | Polarization | Vertical |
| Temp | 21°C | Hum. | 64% |

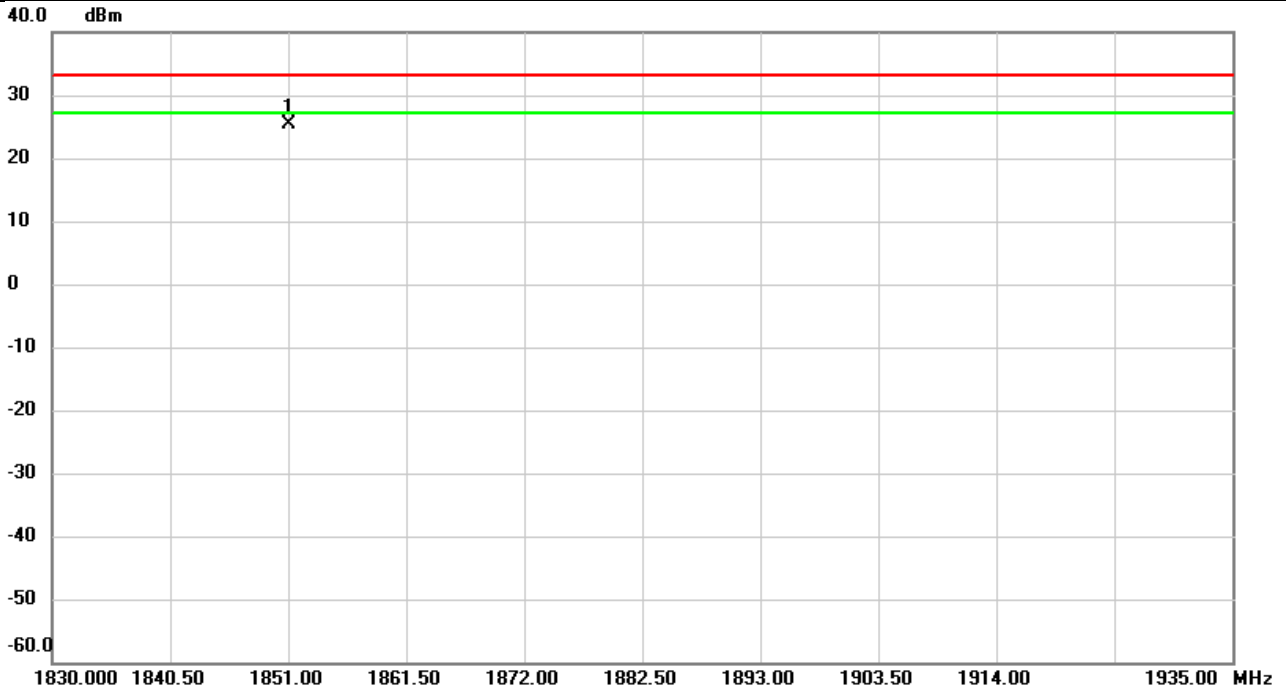

| No. | Mk. | Freq. | Reading Level | Correct Factor | Measurement | Limit | Over | Detector | Comment |
|-----|-----|----------|---------------|----------------|-------------|-------|-------|----------|---------|
| | | MHz | dBm | dB | dBm | dBm | dB | | |
| 1 | * | 1851.126 | -14.23 | 39.67 | 25.44 | 33.01 | -7.57 | peak | |

REMARKS:

- (1) Measurement Value = Reading Level + Correct Factor.
- (2) Margin Level = Measurement Value - Limit Value.

| | | | |
|--------------|-------------|--------------|------------|
| Test Mode | LTE Band 25 | Test Date | 2022/3/3 |
| Test Channel | CH26140 | Polarization | Horizontal |
| Temp | 21°C | Hum. | 64% |

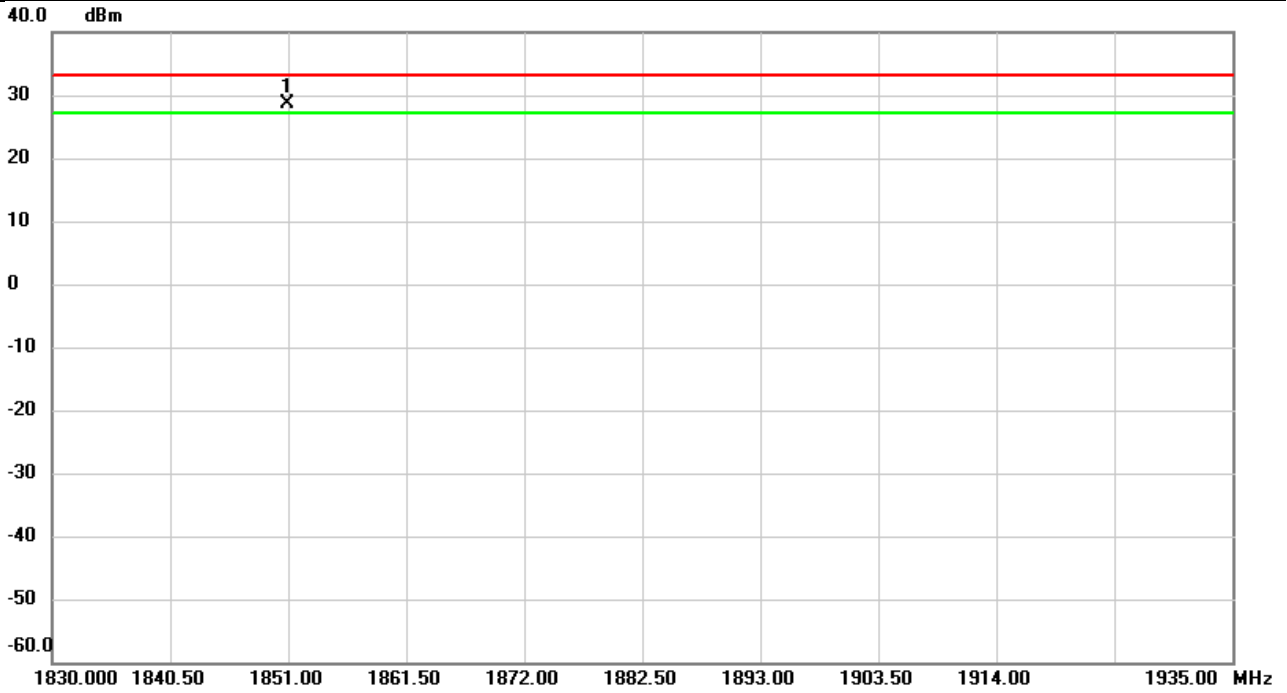

| No. | Mk. | Freq. MHz | Reading Level dBm | Correct Factor dB | Measure- ment dBm | Limit dBm | Over dB | Detector | Comment |
|-----|-----|--------------|-------------------------|-------------------------|-------------------------|--------------|------------|----------|---------|
| 1 | * | 1850.986 | -11.91 | 40.59 | 28.68 | 33.01 | -4.33 | peak | |

REMARKS:

- (1) Measurement Value = Reading Level + Correct Factor.
- (2) Margin Level = Measurement Value - Limit Value.

| | | | |
|--------------|-------------|--------------|----------|
| Test Mode | LTE Band 25 | Test Date | 2022/3/3 |
| Test Channel | CH26365 | Polarization | Vertical |
| Temp | 21°C | Hum. | 64% |

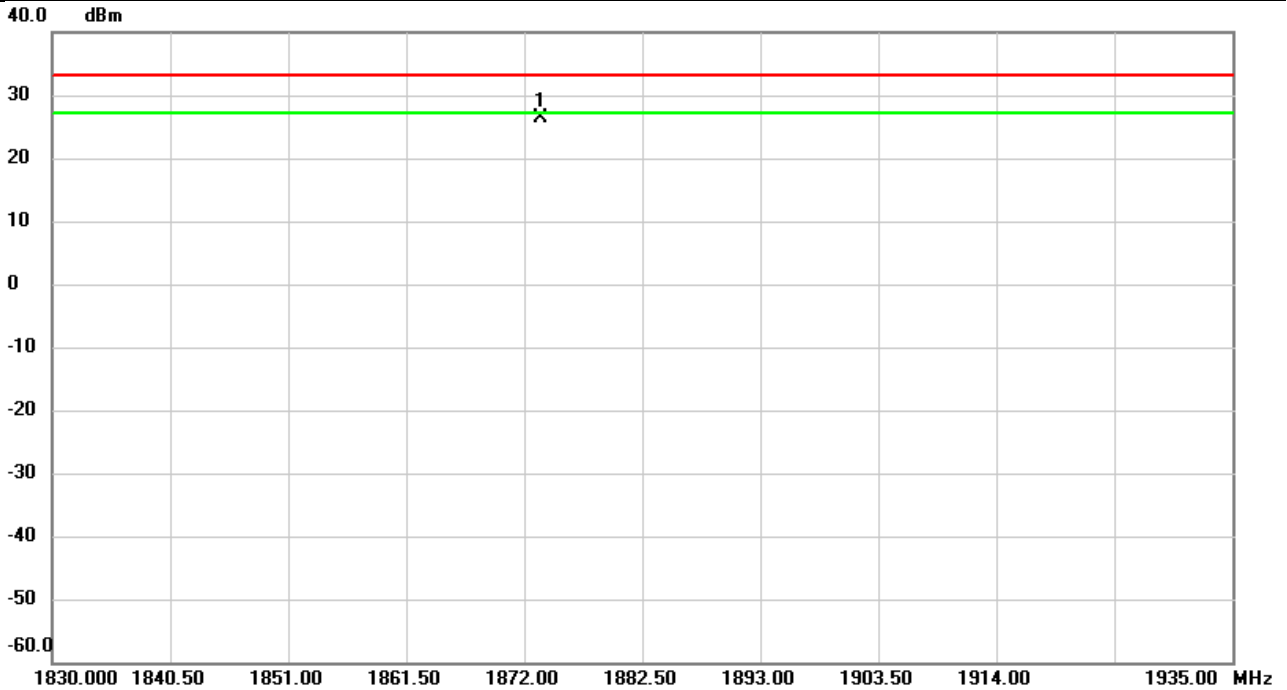

| No. | Mk. | Freq. | Reading Level | Correct Factor | Measurement | Limit | Over | Detector | Comment |
|-----|-----|----------|---------------|----------------|-------------|-------|-------|----------|---------|
| | | MHz | dBm | dB | dBm | dBm | dB | | |
| 1 | * | 1873.502 | -13.40 | 39.76 | 26.36 | 33.01 | -6.65 | peak | |

REMARKS:

- (1) Measurement Value = Reading Level + Correct Factor.
- (2) Margin Level = Measurement Value - Limit Value.

| | | | |
|--------------|-------------|--------------|------------|
| Test Mode | LTE Band 25 | Test Date | 2022/3/4 |
| Test Channel | CH26365 | Polarization | Horizontal |
| Temp | 21°C | Hum. | 64% |

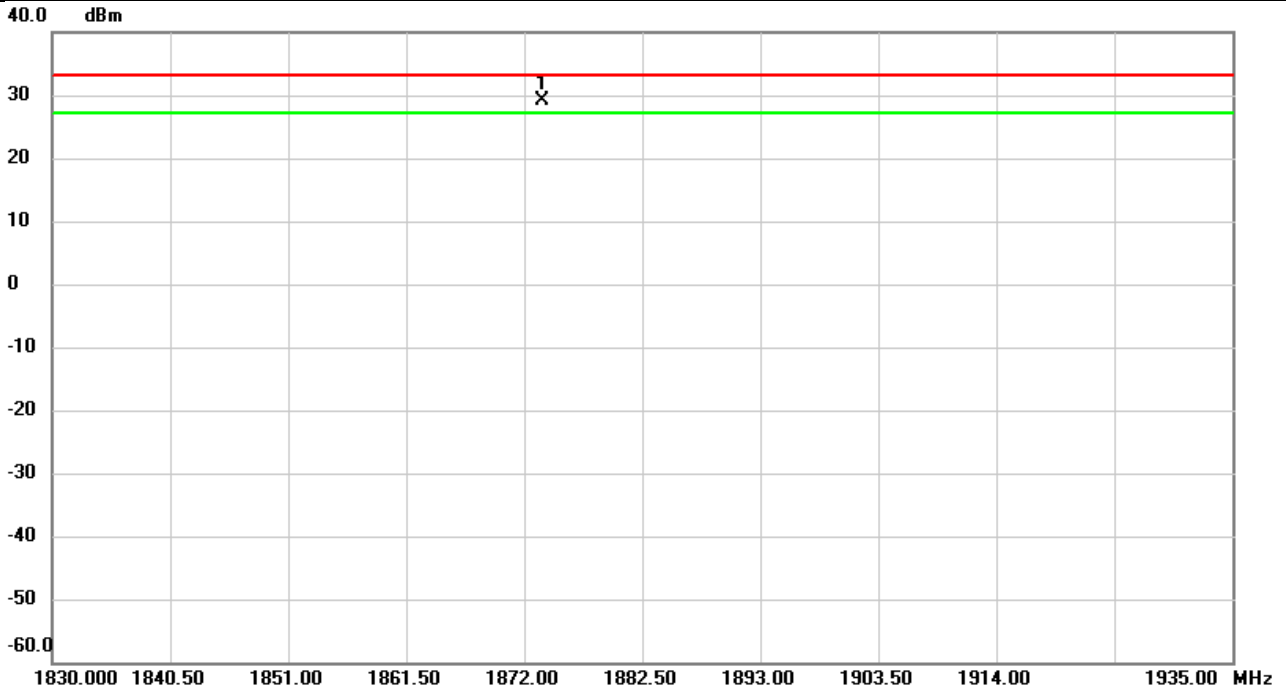

| No. | Mk. | Freq. | Reading Level | Correct Factor | Measurement | Limit | Over | Detector | Comment |
|-----|-----|----------|---------------|----------------|-------------|-------|-------|----------|---------|
| | | MHz | dBm | dB | dBm | dBm | dB | | |
| 1 | * | 1873.568 | -11.57 | 40.70 | 29.13 | 33.01 | -3.88 | peak | |

REMARKS:

- (1) Measurement Value = Reading Level + Correct Factor.
- (2) Margin Level = Measurement Value - Limit Value.

| | | | |
|--------------|-------------|--------------|----------|
| Test Mode | LTE Band 25 | Test Date | 2022/3/4 |
| Test Channel | CH26590 | Polarization | Vertical |
| Temp | 21°C | Hum. | 64% |

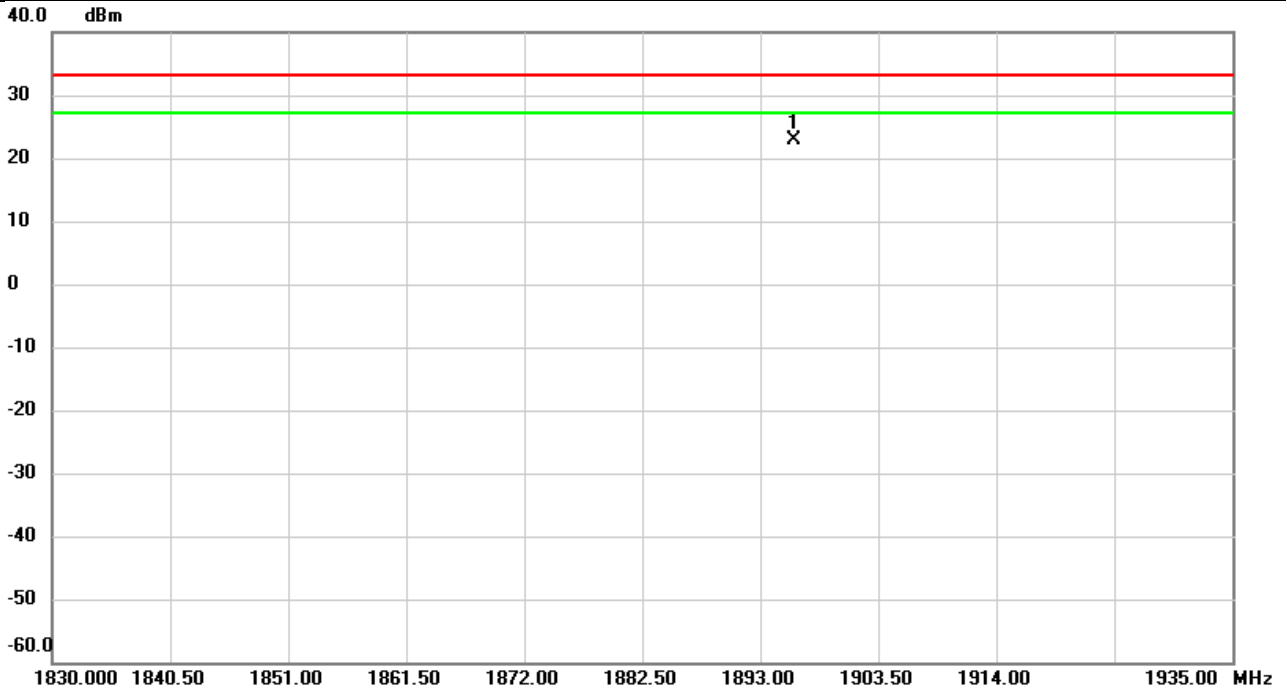

| No. | Mk. | Freq. MHz | Reading Level dBm | Correct Factor dB | Measure- ment dBm | Limit dBm | Over dB | Detector | Comment |
|-----|-----|--------------|-------------------------|-------------------------|-------------------------|--------------|------------|----------|---------|
| 1 | * | 1896.014 | -17.00 | 39.84 | 22.84 | 33.01 | -10.17 | peak | |

REMARKS:

- (1) Measurement Value = Reading Level + Correct Factor.
- (2) Margin Level = Measurement Value - Limit Value.

| | | | |
|--------------|-------------|--------------|------------|
| Test Mode | LTE Band 25 | Test Date | 2022/3/4 |
| Test Channel | CH26590 | Polarization | Horizontal |
| Temp | 21°C | Hum. | 64% |

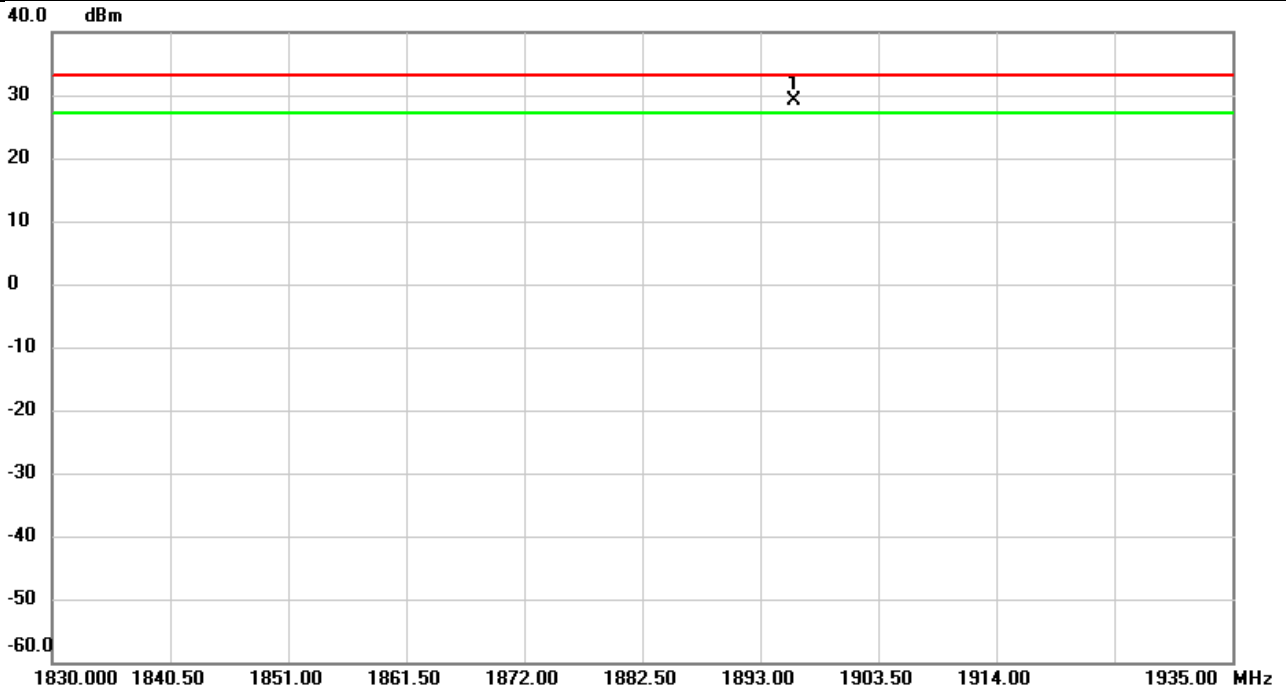

| No. | Mk. | Freq. | Reading Level | Correct Factor | Measurement | Limit | Over | Detector | Comment |
|-----|-----|----------|---------------|----------------|-------------|-------|-------|----------|---------|
| | | MHz | dBm | dB | dBm | dBm | dB | | |
| 1 | * | 1896.024 | -11.72 | 40.82 | 29.10 | 33.01 | -3.91 | peak | |

REMARKS:

- (1) Measurement Value = Reading Level + Correct Factor.
- (2) Margin Level = Measurement Value - Limit Value.

APPENDIX C RADIATED SPURIOUS EMISSIONS

| | | | |
|--------------|---------------|--------------|----------|
| Test Mode | WCDMA Band II | Test Date | 2022/3/3 |
| Test Channel | CH9400 | Polarization | Vertical |
| Temp | 21°C | Hum. | 64% |

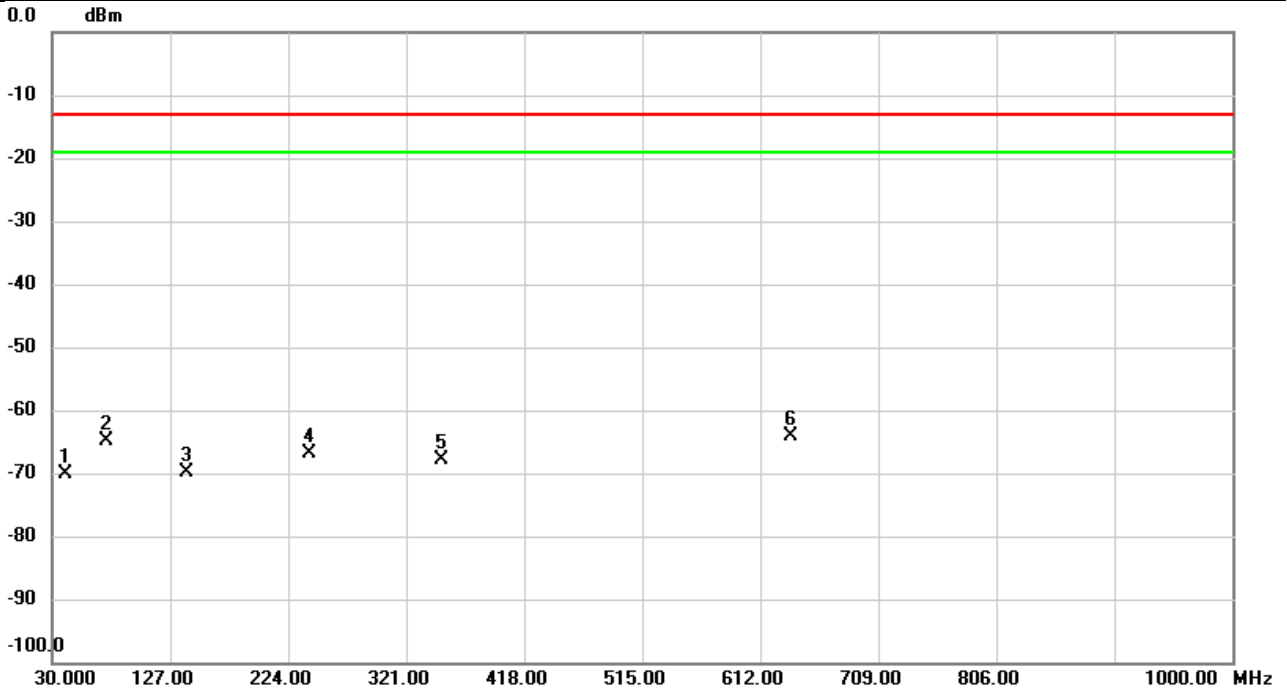

| No. | Mk. | Freq. MHz | Reading Level dBm | Correct Factor dB | Measure- ment dBm | Limit dBm | Over dB | Detector | Comment |
|-----|-----|--------------|-------------------------|-------------------------|-------------------------|--------------|------------|----------|---------|
| 1 | | 40.7670 | -69.19 | -0.91 | -70.10 | -13.00 | -57.10 | peak | |
| 2 | | 75.1696 | -62.55 | -2.27 | -64.82 | -13.00 | -51.82 | peak | |
| 3 | | 140.1597 | -72.91 | 3.11 | -69.80 | -13.00 | -56.80 | peak | |
| 4 | | 241.2660 | -74.62 | 7.73 | -66.89 | -13.00 | -53.89 | peak | |
| 5 | | 350.2293 | -74.90 | 7.03 | -67.87 | -13.00 | -54.87 | peak | |
| 6 | * | 636.9937 | -77.17 | 13.12 | -64.05 | -13.00 | -51.05 | peak | |

REMARKS:

- (1) Measurement Value = Reading Level + Correct Factor.
- (2) Margin Level = Measurement Value - Limit Value.

| | | | |
|--------------|---------------|--------------|------------|
| Test Mode | WCDMA Band II | Test Date | 2022/3/3 |
| Test Channel | CH9400 | Polarization | Horizontal |
| Temp | 21°C | Hum. | 64% |

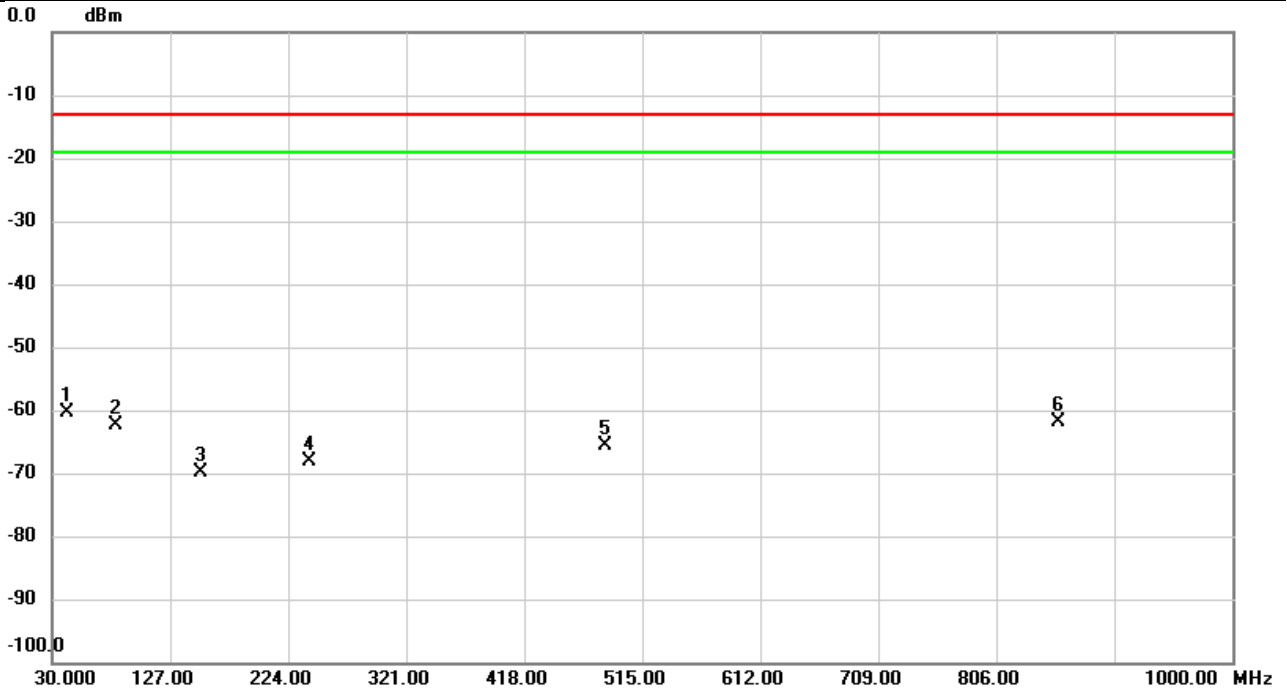

| No. | Mk. | Freq. MHz | Reading Level dBm | Correct Factor dB | Measure- ment dBm | Limit dBm | Over dB | Detector | Comment |
|-----|-----|--------------|-------------------------|-------------------------|-------------------------|--------------|------------|----------|---------|
| 1 | * | 42.0927 | -76.80 | 16.55 | -60.25 | -13.00 | -47.25 | peak | |
| 2 | | 82.9297 | -67.48 | 5.14 | -62.34 | -13.00 | -49.34 | peak | |
| 3 | | 151.6380 | -72.71 | 2.86 | -69.85 | -13.00 | -56.85 | peak | |
| 4 | | 241.0073 | -67.57 | -0.49 | -68.06 | -13.00 | -55.06 | peak | |
| 5 | | 484.8330 | -77.16 | 11.50 | -65.66 | -13.00 | -52.66 | peak | |
| 6 | | 856.5047 | -78.17 | 16.33 | -61.84 | -13.00 | -48.84 | peak | |

REMARKS:

- (1) Measurement Value = Reading Level + Correct Factor.
- (2) Margin Level = Measurement Value - Limit Value.

| | | | |
|--------------|------------|--------------|----------|
| Test Mode | LTE Band 2 | Test Date | 2022/3/3 |
| Test Channel | CH18900 | Polarization | Vertical |
| Temp | 21°C | Hum. | 64% |

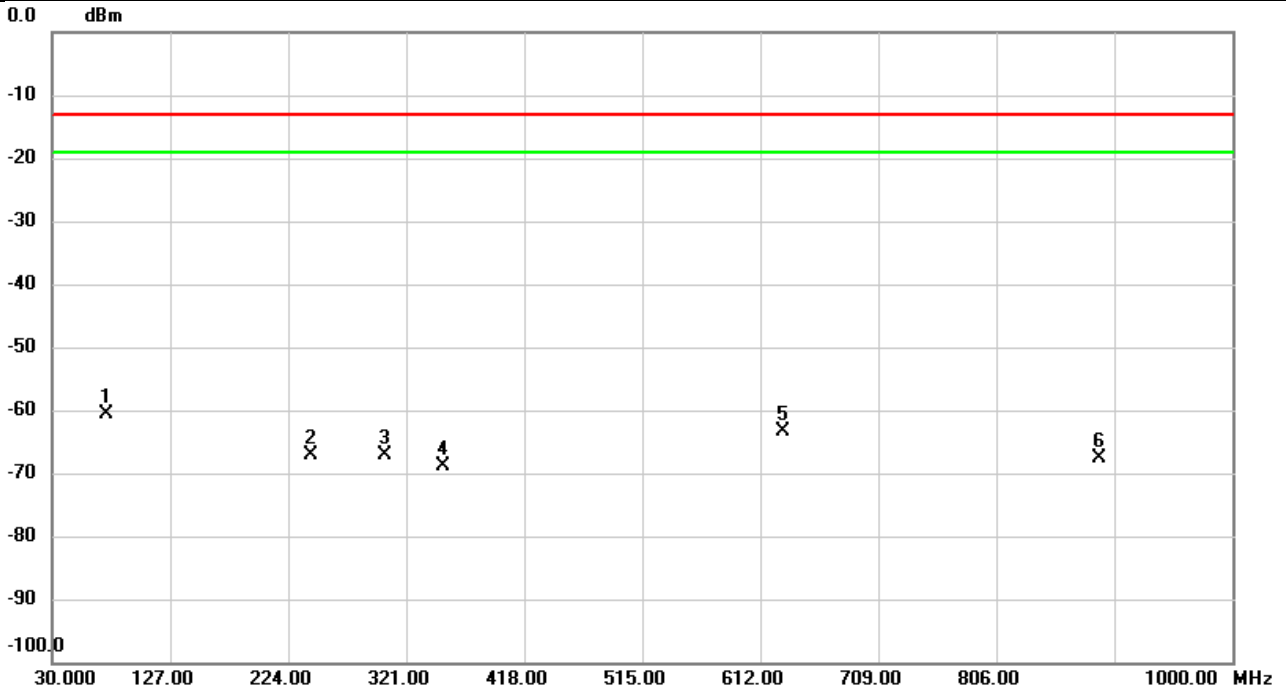

| No. | Mk. | Freq. | Reading Level | Correct Factor | Measurement | Limit | Over | Detector | Comment |
|-----|-----|----------|---------------|----------------|-------------|--------|--------|----------|---------|
| | | MHz | dBm | dB | dBm | dBm | dB | | |
| 1 | * | 75.1373 | -58.37 | -2.27 | -60.64 | -13.00 | -47.64 | peak | |
| 2 | | 242.6887 | -74.78 | 7.72 | -67.06 | -13.00 | -54.06 | peak | |
| 3 | | 303.6370 | -74.76 | 7.62 | -67.14 | -13.00 | -54.14 | peak | |
| 4 | | 351.6843 | -75.83 | 6.91 | -68.92 | -13.00 | -55.92 | peak | |
| 5 | | 630.5917 | -76.35 | 13.05 | -63.30 | -13.00 | -50.30 | peak | |
| 6 | | 890.2607 | -78.26 | 10.72 | -67.54 | -13.00 | -54.54 | peak | |

REMARKS:

- (1) Measurement Value = Reading Level + Correct Factor.
- (2) Margin Level = Measurement Value - Limit Value.

| | | | |
|--------------|------------|--------------|------------|
| Test Mode | LTE Band 2 | Test Date | 2022/3/3 |
| Test Channel | CH18900 | Polarization | Horizontal |
| Temp | 21°C | Hum. | 64% |

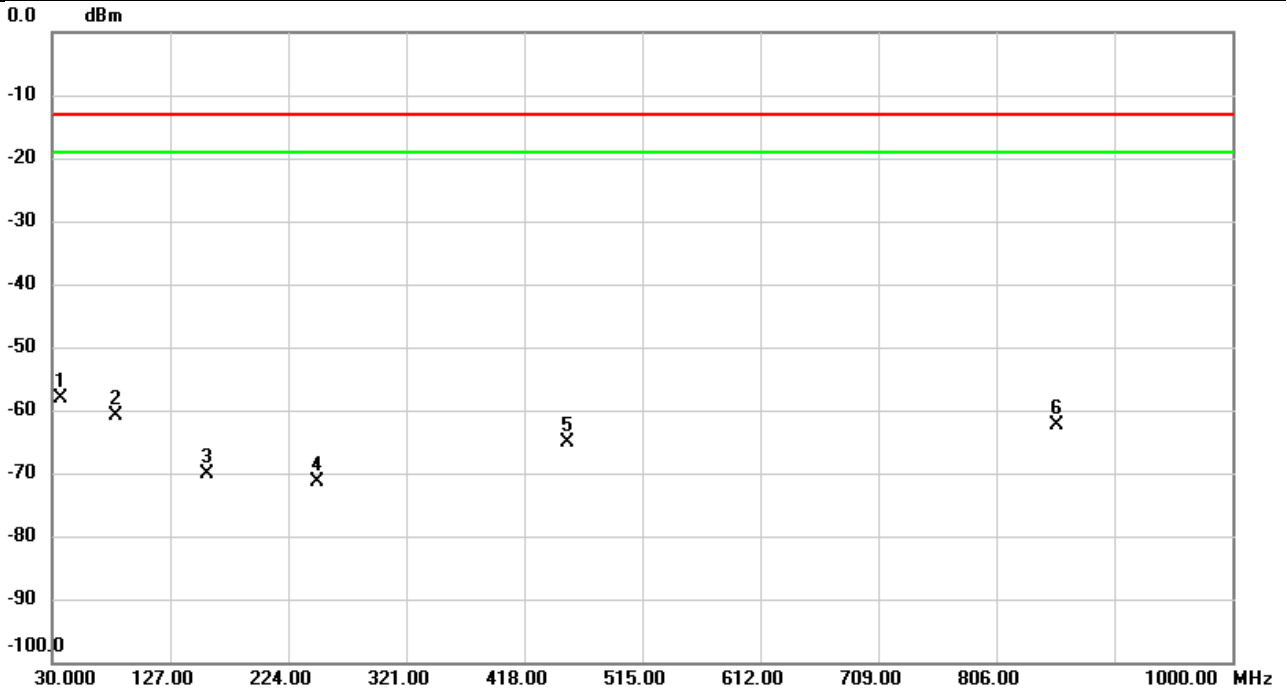

| No. | Mk. | Freq. MHz | Reading Level dBm | Correct Factor dB | Measure- ment dBm | Limit dBm | Over dB | Detector | Comment |
|-----|-----|--------------|-------------------------|-------------------------|-------------------------|--------------|------------|----------|---------|
| 1 | * | 37.4367 | -74.06 | 15.95 | -58.11 | -13.00 | -45.11 | peak | |
| 2 | | 82.9943 | -65.97 | 5.12 | -60.85 | -13.00 | -47.85 | peak | |
| 3 | | 157.8460 | -72.73 | 2.70 | -70.03 | -13.00 | -57.03 | peak | |
| 4 | | 247.6033 | -70.73 | -0.64 | -71.37 | -13.00 | -58.37 | peak | |
| 5 | | 453.8900 | -77.57 | 12.38 | -65.19 | -13.00 | -52.19 | peak | |
| 6 | | 856.1813 | -78.68 | 16.33 | -62.35 | -13.00 | -49.35 | peak | |

REMARKS:

- (1) Measurement Value = Reading Level + Correct Factor.
- (2) Margin Level = Measurement Value - Limit Value.

| | | | |
|--------------|-------------|--------------|----------|
| Test Mode | LTE Band 25 | Test Date | 2022/3/3 |
| Test Channel | CH26365 | Polarization | Vertical |
| Temp | 21°C | Hum. | 64% |

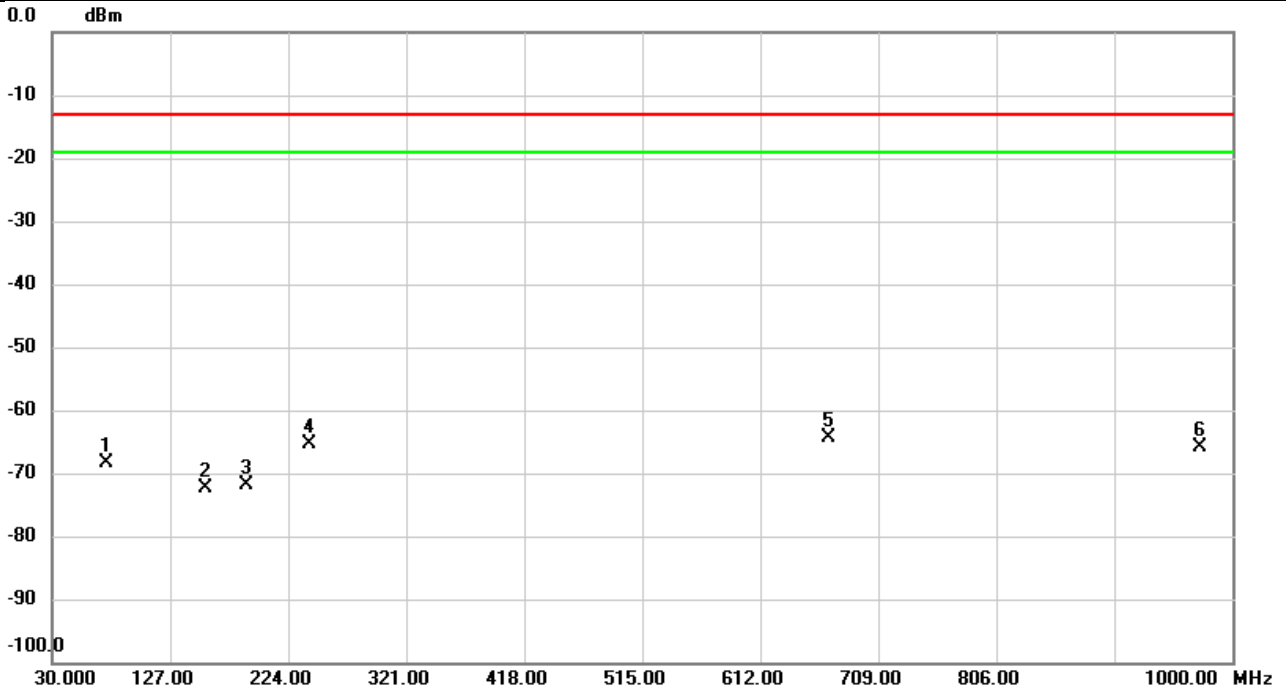

| No. | Mk. | Freq. MHz | Reading Level dBm | Correct Factor dB | Measure- ment dBm | Limit dBm | Over dB | Detector | Comment |
|-----|-----|--------------|-------------------------|-------------------------|-------------------------|--------------|------------|----------|---------|
| 1 | | 74.7170 | -66.17 | -2.29 | -68.46 | -13.00 | -55.46 | peak | |
| 2 | | 156.1970 | -76.10 | 3.70 | -72.40 | -13.00 | -59.40 | peak | |
| 3 | | 189.4680 | -76.08 | 4.27 | -71.81 | -13.00 | -58.81 | peak | |
| 4 | | 241.9773 | -73.21 | 7.73 | -65.48 | -13.00 | -52.48 | peak | |
| 5 | * | 667.8397 | -77.52 | 13.19 | -64.33 | -13.00 | -51.33 | peak | |
| 6 | | 973.2280 | -79.48 | 13.73 | -65.75 | -13.00 | -52.75 | peak | |

REMARKS:

- (1) Measurement Value = Reading Level + Correct Factor.
- (2) Margin Level = Measurement Value - Limit Value.

| | | | |
|--------------|-------------|--------------|------------|
| Test Mode | LTE Band 25 | Test Date | 2022/3/3 |
| Test Channel | CH26365 | Polarization | Horizontal |
| Temp | 21°C | Hum. | 64% |

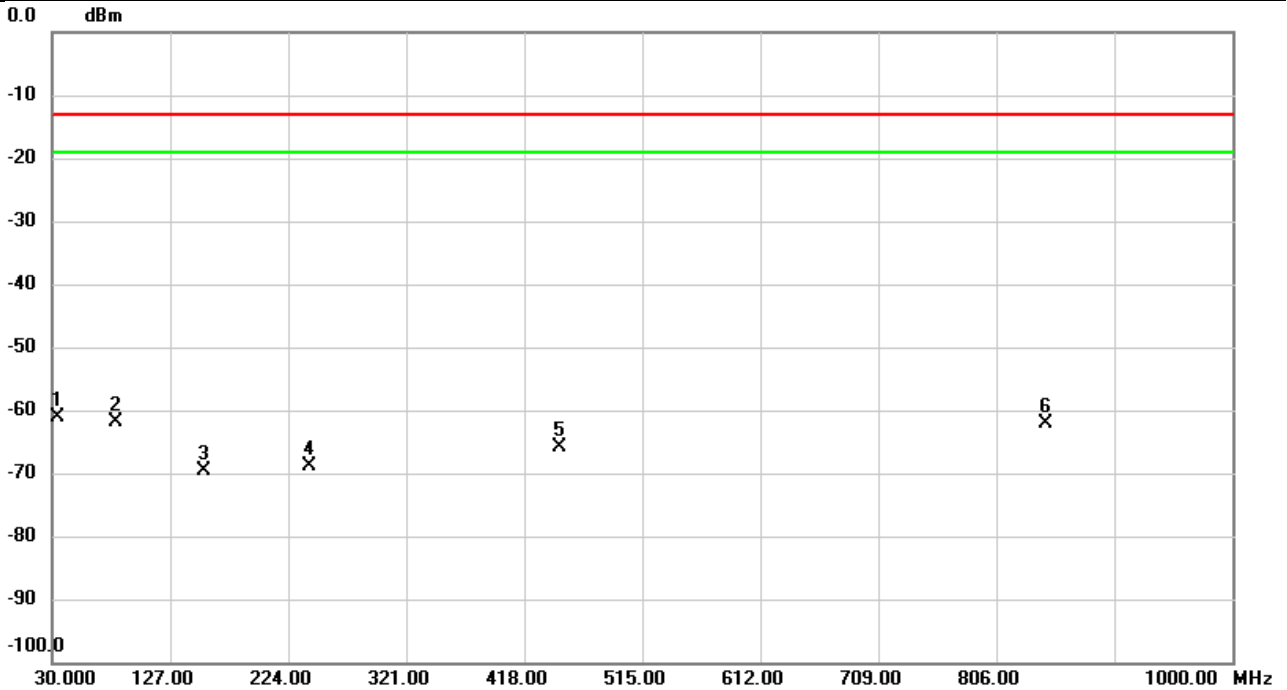

| No. | Mk. | Freq. | Reading Level | Correct Factor | Measurement | Limit | Over | Detector | Comment |
|-----|-----|----------|---------------|----------------|-------------|--------|--------|----------|---------|
| | | MHz | dBm | dB | dBm | dBm | dB | | |
| 1 | * | 34.6237 | -76.06 | 14.86 | -61.20 | -13.00 | -48.20 | peak | |
| 2 | | 82.0567 | -67.18 | 5.32 | -61.86 | -13.00 | -48.86 | peak | |
| 3 | | 154.7420 | -72.45 | 2.78 | -69.67 | -13.00 | -56.67 | peak | |
| 4 | | 241.7510 | -68.30 | -0.51 | -68.81 | -13.00 | -55.81 | peak | |
| 5 | | 446.7443 | -77.92 | 11.95 | -65.97 | -13.00 | -52.97 | peak | |
| 6 | | 846.8370 | -78.45 | 16.34 | -62.11 | -13.00 | -49.11 | peak | |

REMARKS:

- (1) Measurement Value = Reading Level + Correct Factor.
- (2) Margin Level = Measurement Value - Limit Value.

| | | | |
|--------------|---------------|--------------|----------|
| Test Mode | WCDMA Band II | Test Date | 2022/3/3 |
| Test Channel | CH9400 | Polarization | Vertical |
| Temp | 21°C | Hum. | 64% |

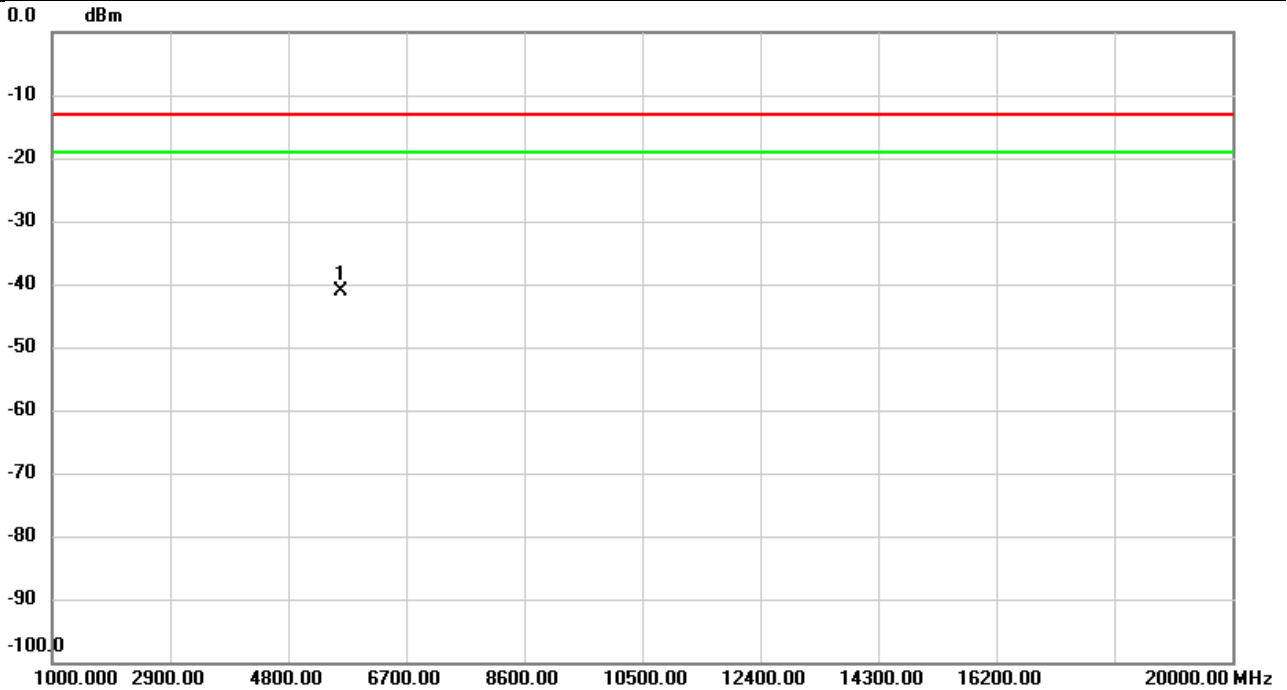

| No. | Mk. | Freq. | Reading Level | Correct Factor | Measurement | Limit | Over | Detector | Comment |
|-----|-----|----------|---------------|----------------|-------------|--------|--------|----------|---------|
| | | MHz | dBm | dB | dBm | dBm | dB | | |
| 1 | * | 5637.267 | -43.72 | 2.50 | -41.22 | -13.00 | -28.22 | peak | |

REMARKS:

- (1) Measurement Value = Reading Level + Correct Factor.
- (2) Margin Level = Measurement Value - Limit Value.

| | | | |
|--------------|---------------|--------------|------------|
| Test Mode | WCDMA Band II | Test Date | 2022/3/3 |
| Test Channel | CH9400 | Polarization | Horizontal |
| Temp | 21°C | Hum. | 64% |

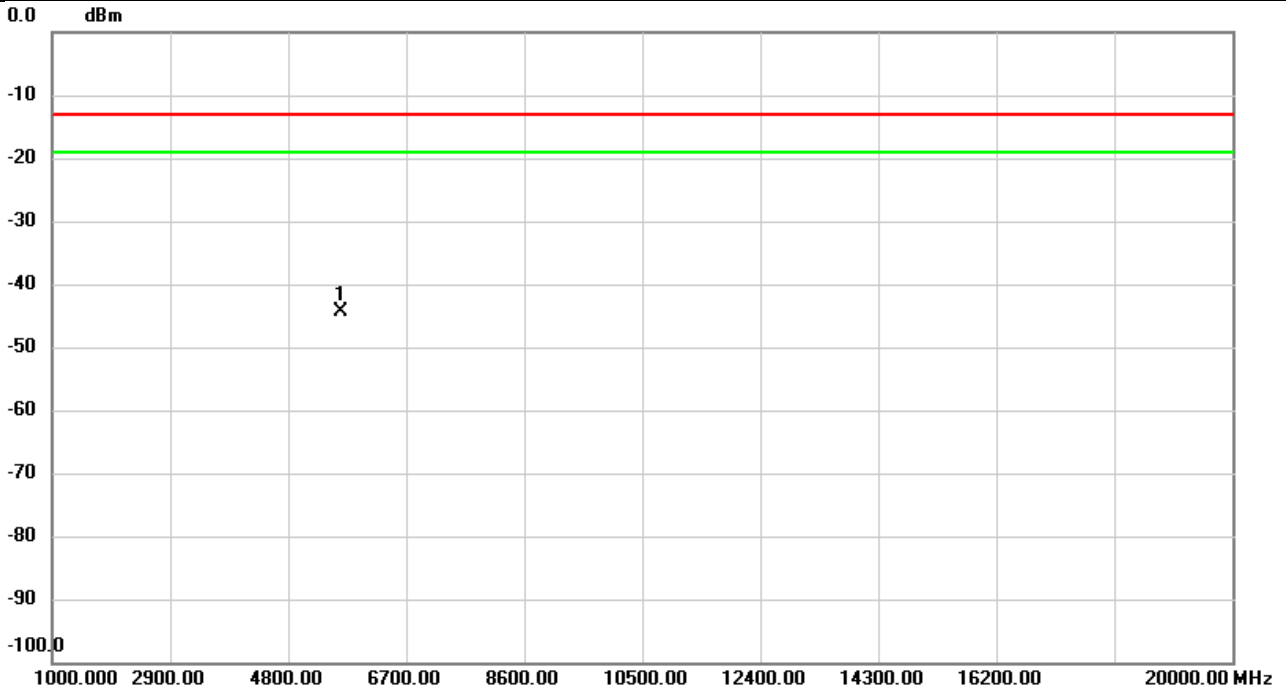

| No. | Mk. | Freq. | Reading Level | Correct Factor | Measurement | Limit | Over | Detector | Comment |
|-----|-----|----------|---------------|----------------|-------------|--------|--------|----------|---------|
| | | MHz | dBm | dB | dBm | dBm | dB | | |
| 1 | * | 5642.333 | -47.34 | 2.94 | -44.40 | -13.00 | -31.40 | peak | |

REMARKS:

- (1) Measurement Value = Reading Level + Correct Factor.
- (2) Margin Level = Measurement Value - Limit Value.

| | | | |
|--------------|------------|--------------|----------|
| Test Mode | LTE Band 2 | Test Date | 2022/3/4 |
| Test Channel | CH18900 | Polarization | Vertical |
| Temp | 21°C | Hum. | 64% |

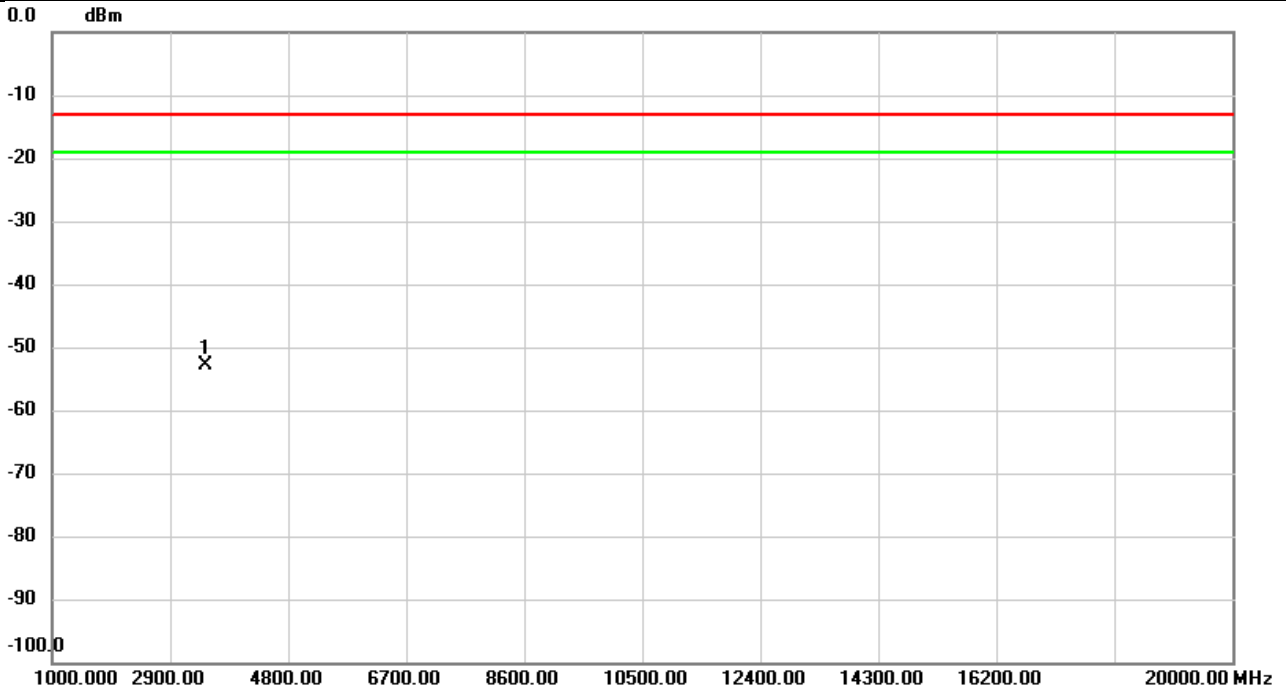

| No. | Mk. | Freq. | Reading Level | Correct Factor | Measurement | Limit | Over | Detector | Comment |
|-----|-----|----------|---------------|----------------|-------------|--------|--------|----------|---------|
| | | MHz | dBm | dB | dBm | dBm | dB | | |
| 1 | * | 3472.533 | -50.93 | -1.99 | -52.92 | -13.00 | -39.92 | peak | |

REMARKS:

- (1) Measurement Value = Reading Level + Correct Factor.
- (2) Margin Level = Measurement Value - Limit Value.

| | | | |
|--------------|------------|--------------|------------|
| Test Mode | LTE Band 2 | Test Date | 2022/3/4 |
| Test Channel | CH18900 | Polarization | Horizontal |
| Temp | 21°C | Hum. | 64% |

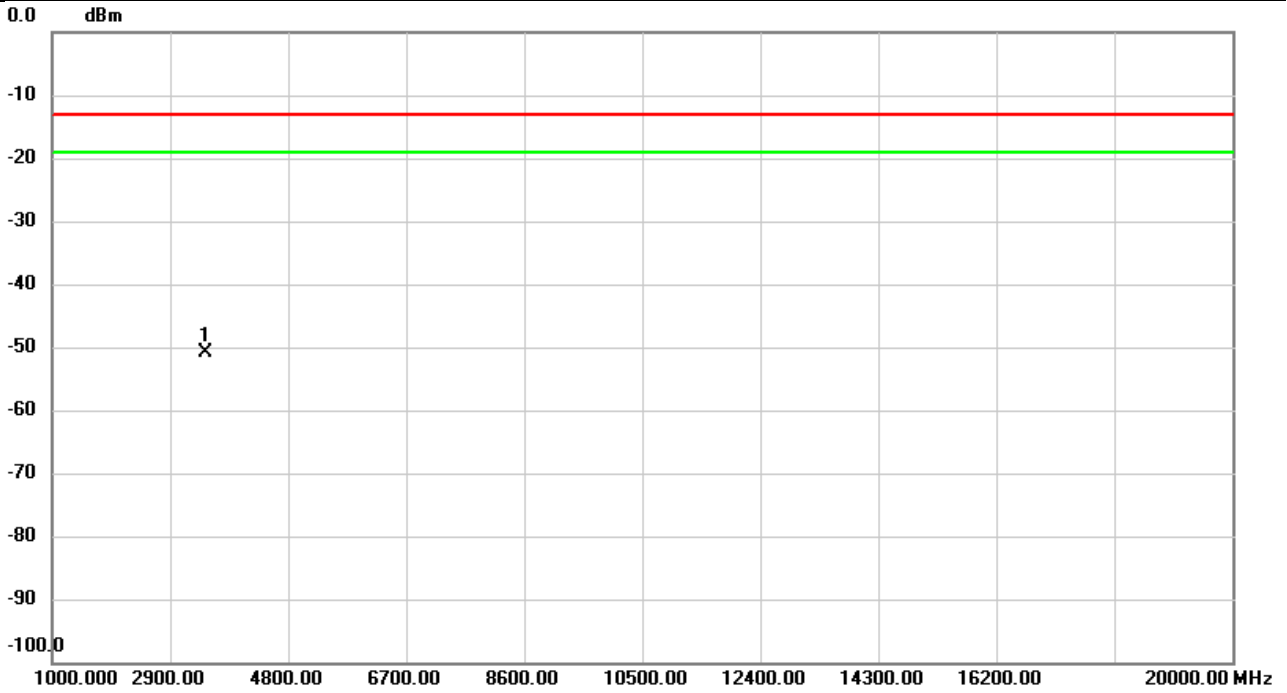

| No. | Mk. | Freq. | Reading Level | Correct Factor | Measurement | Limit | Over | Detector | Comment |
|-----|-----|----------|---------------|----------------|-------------|--------|--------|----------|---------|
| | | MHz | dBm | dB | dBm | dBm | dB | | |
| 1 | * | 3472.533 | -49.11 | -1.85 | -50.96 | -13.00 | -37.96 | peak | |

REMARKS:

- (1) Measurement Value = Reading Level + Correct Factor.
- (2) Margin Level = Measurement Value - Limit Value.

| | | | |
|--------------|-------------|--------------|----------|
| Test Mode | LTE Band 25 | Test Date | 2022/3/4 |
| Test Channel | CH26365 | Polarization | Vertical |
| Temp | 21°C | Hum. | 64% |

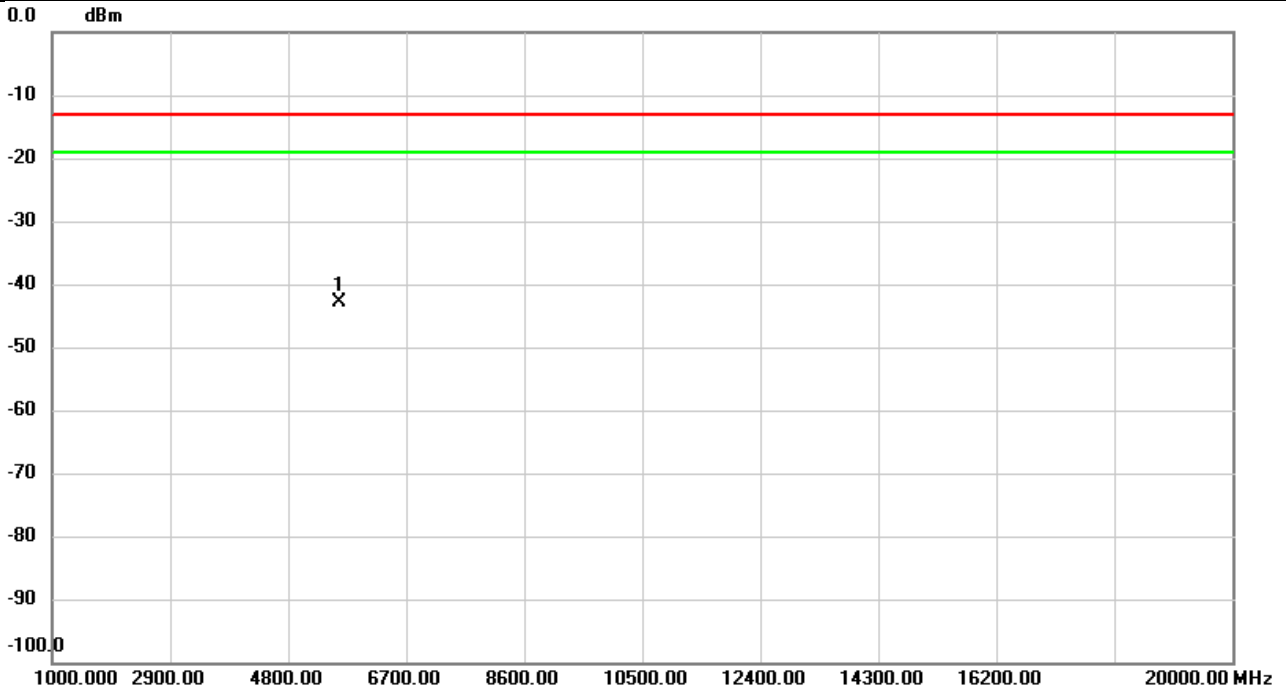

| No. | Mk. | Freq. MHz | Reading Level dBm | Correct Factor dB | Measure- ment dBm | Limit dBm | Over dB | Detector | Comment |
|-----|-----|--------------|-------------------------|-------------------------|-------------------------|--------------|------------|----------|---------|
| 1 | * | 5620.800 | -45.15 | 2.25 | -42.90 | -13.00 | -29.90 | peak | |

REMARKS:

- (1) Measurement Value = Reading Level + Correct Factor.
- (2) Margin Level = Measurement Value - Limit Value.

| | | | |
|--------------|-------------|--------------|------------|
| Test Mode | LTE Band 25 | Test Date | 2022/3/4 |
| Test Channel | CH26365 | Polarization | Horizontal |
| Temp | 21°C | Hum. | 64% |

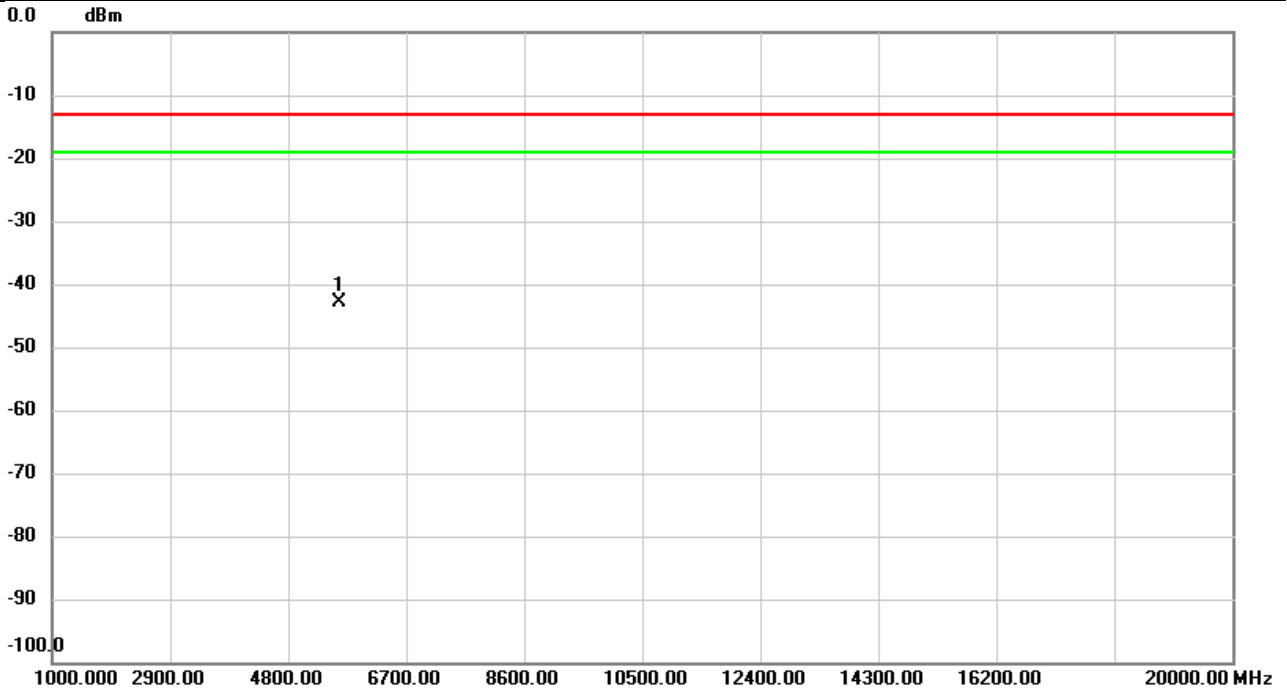

| No. | Mk. | Freq. | Reading Level | Correct Factor | Measurement | Limit | Over | Detector | Comment |
|-----|-----|----------|---------------|----------------|-------------|--------|--------|----------|---------|
| | | MHz | dBm | dB | dBm | dBm | dB | | |
| 1 | * | 5620.800 | -46.11 | 3.15 | -42.96 | -13.00 | -29.96 | peak | |

REMARKS:

- (1) Measurement Value = Reading Level + Correct Factor.
- (2) Margin Level = Measurement Value - Limit Value.

End of Test Report