

FCC RF Test Report

APPLICANT : Fibocom Wireless Inc.
EQUIPMENT : 5G Module
BRAND NAME : Fibocom
MODEL NAME : FM350-GL
FCC ID : ZMOFM350GL
STANDARD : 47 CFR Part 2, 27
CLASSIFICATION : PCS Licensed Transmitter (PCB)

The product was received on May 18, 2020 and completely tested on Feb. 10, 2021. We, Sporton International (Shenzhen) Inc., would like to declare that the tested sample has been evaluated in accordance with the procedures given in ANSI C63.26-2015 and shown compliance with the applicable technical standards.

The test results in this report apply exclusively to the tested model / sample. Without written approval of Sporton International (Shenzhen) Inc., the test report shall not be reproduced except in full.



Reviewed by: Derreck Chen / Supervisor



Approved by: Eric Shih / Manager



Sporton International (ShenZhen) Inc.

1/F, 2/F, Bldg 5, Shiling Industrial Zone, Xinwei Village, Xili, Nanshan, Shenzhen, 518055

People's Republic of China



TABLE OF CONTENTS

REVISION HISTORY..... 3
SUMMARY OF TEST RESULT 4
1 GENERAL DESCRIPTION 5
1.1 Applicant 5
1.2 Manufacturer 5
1.3 Product Feature of Equipment Under Test 5
1.4 Product Specification of Equipment Under Test 5
1.5 Modification of EUT 6
1.6 Maximum Conducted Power, Frequency Tolerance and Emission Designator 6
1.7 Testing Site 6
1.8 Test Software 7
1.9 Applied Standards 7
2 TEST CONFIGURATION OF EQUIPMENT UNDER TEST 8
2.1 Test Mode 8
2.2 Connection Diagram of Test System 9
2.3 Support Unit used in test configuration and system 9
2.4 Measurement Results Explanation Example 9
2.5 Frequency List of Low/Middle/High Channels 10
3 CONDUCTED TEST ITEMS 11
3.1 Measuring Instruments 11
3.2 Test Setup 11
3.3 Test Result of Conducted Test 11
3.4 Conducted Output Power Measurement 12
3.5 Peak-to-Average Ratio 13
3.6 EIRP 14
3.7 Occupied Bandwidth 15
3.8 Conducted Band Edge Measurement 16
3.9 Conducted Spurious Emission Measurement 17
3.10 Frequency Stability Measurement 18
4 RADIATED TEST ITEMS 19
4.1 Measuring Instruments 19
4.2 Test Setup 19
4.3 Test Result of Radiated Test 19
4.4 Radiated Spurious Emission Measurement 20
5 LIST OF MEASURING EQUIPMENT 21
6 UNCERTAINTY OF EVALUATION 22
APPENDIX A. TEST RESULTS OF CONDUCTED TEST
APPENDIX B. TEST RESULTS OF RADIATED TEST
APPENDIX C. TEST SETUP PHOTOGRAPHS



SUMMARY OF TEST RESULT

Report Section	FCC Rule	Description	Limit	Result	Remark
3.4	§2.1046	Conducted Output Power	Reporting Only	PASS	-
3.5	-	Peak-to-Average Ratio	<13dB	N/A	Reporting only
3.6	§27.50 (a)(3)	EIRP	EIRP < 250mW/5MHz	PASS	-
3.7	§2.1049	Occupied Bandwidth	Reporting Only	PASS	-
3.8	§2.1051 §27.53 (a)(4)	Conducted Band Edge Measurement	Refer standard	PASS	-
3.9	§2.1051 §27.53 (a)(4)	Conducted Spurious Emission	< 70+10log ₁₀ (P[Watts])	PASS	-
3.10	§2.1055 §27.54	Frequency Stability Temperature & Voltage	Within the band	PASS	-
4.4	§2.1053 §27.53 (a)(4)	Radiated Spurious Emission	< 70+10log ₁₀ (P[Watts])	PASS	Under limit 14.43 dB at 9223.200 MHz

Declaration of Conformity:

The test results with all measurement uncertainty excluded are presented in accordance with the regulation limits or requirements declared by manufacturers.

Comments and Explanations:

The declared of product specification for EUT presented in the report are provided by the manufacturer, and the manufacturer takes all the responsibilities for the accuracy of product specification.



1 General Description

1.1 Applicant

Fibocom Wireless Inc.

1101, Tower A, Building 6, Shenzhen International Innovation Valley, Dashi 1st Rd, Nanshan, Shenzhen, China

1.2 Manufacturer

Fibocom Wireless Inc.

1101, Tower A, Building 6, Shenzhen International Innovation Valley, Dashi 1st Rd, Nanshan, Shenzhen, China

1.3 Product Feature of Equipment Under Test

Product Feature	
Equipment	5G Module
Brand Name	Fibocom
Model Name	FM350-GL
FCC ID	ZMOFM350GL
EUT supports Radios application	WCDMA/LTE/5G NR GNSS
IMEI Code	Conducted: 862146050001310 Radiation: 882146050002276
HW Version	V1.0.6
SW Version	81600.0000.00.09.03.03
EUT Stage	Identical Prototype

1.4 Product Specification of Equipment Under Test

Product Feature	
Tx Frequency	5G NR n30 : 2305 MHz ~ 2315 MHz
Rx Frequency	5G NR n30 : 2350 MHz ~ 2360 MHz
Bandwidth	5MHz / 10MHz
SCS	15KHz/30KHz
NR Mode	SA
Antenna Gain	1.0 dBi
Type of Modulation	CP-OFDM: QPSK / 16QAM / 64QAM / 256QAM DFT-s-OFDM: PI/2 BPSK / QPSK / 16QAM / 64QAM / 256QAM

1.5 Modification of EUT

No modifications are made to the EUT during all test items.

1.6 Maximum Conducted Power, Frequency Tolerance and Emission Designator

5G NR n30 (SCS 15)		PI/2 BPSK / QPSK		16QAM / 64QAM / 256QAM	
BW (MHz)	Frequency Range (MHz)	Emission Designator (99%OBW)	Maximum Conducted power (W)	Emission Designator (99%OBW)	Maximum Conducted power (W)
5	2307.5 ~ 2312.5	4M46G7D	0.1791	4M50W7D	0.1774
10	2310.0	9M27G7D	0.1742	9M31W7D	0.1337
Frequency Tolerance (ppm)			0.0021		

1.7 Testing Site

Sporton International (Shenzhen) Inc. is accredited to ISO/IEC 17025:2017 by American Association for Laboratory Accreditation with Certificate Number 5145.01.

Test Firm	Sporton International (Shenzhen) Inc.		
Test Site Location	1/F, 2/F, Bldg 5, Shiling Industrial Zone, Xinwei Village, Xili, Nanshan, Shenzhen, 518055 People's Republic of China TEL: +86-755-86379589 FAX: +86-755-86379595		
Test Site No.	Sporton Site No.	FCC Designation No.	FCC Test Firm Registration No.
	TH01-SZ	CN1256	421272

Test Firm	Sporton International (Shenzhen) Inc.		
Test Site Location	101, 1st Floor, Block B, Building 1, No. 2, Tengfeng 4th Road, Fenghuang Community, Fuyong Street, Baoan District, Shenzhen City Guangdong Province China 518103 TEL: +86-755-33202398		
Test Site No.	Sporton Site No.	FCC Designation No.	FCC Test Firm Registration No.
	03CH03-SZ	CN1256	421272

1.8 Test Software

Item	Site	Manufacturer	Name	Version
1.	03CH03-SZ	AUDIX	E3	6.2009-8-24

1.9 Applied Standards

According to the specifications of the manufacturer, the EUT must comply with the requirements of the following standards:

- ♦ 47 CFR Part 2, Part 27(D)
- ♦ ANSI C63.26-2015
- ♦ FCC KDB 971168 Power Meas License Digital Systems D01 v03r01
- ♦ FCC KDB 412172 D01 Determining ERP and EIRP v01r01
- ♦

Remark:

1. All test items were verified and recorded according to the standards and without any deviation during the test.
2. This EUT has also been tested and complied with the requirements of FCC Part 15, Subpart B, recorded in a separate test report.



2 Test Configuration of Equipment Under Test

2.1 Test Mode

Antenna port conducted and radiated test items listed below are performed according to KDB 971168 D01 Power Meas. License Digital Systems v03r01 with maximum output power.

Radiated measurements are performed by rotating the EUT in three different orthogonal test planes to find the maximum emission.

Conducted Test Cases	Band	Bandwidth (MHz)						Modulation					RB #		Test Channel			
		1.4	3	5	10	15	20	PI/2 BPSK	QPSK	16QAM	64QAM	256QAM	1	Full	L	M	H	
Max. Output Power	n30	-	-	V		-	-	V	V	V	V	V	V	V	V	V	V	V
		-	-		V	-	-	V	V	V	V	V	V	V		V		
Peak-to-Average Ratio	n30	-	-	V		-	-	V	V				V	V	V	V	V	
E.I.R.P	n30	-	-	V		-	-	V	V	V	V	V	V		V	V	V	
		-	-		V	-	-	V	V	V	V	V	V			V		
26dB and 99% Bandwidth	n30	-	-	V		-	-		V	V	V	V		V		V		
		-	-		V	-	-		V	V	V	V		V		V		
Conducted Band Edge	n30	-	-	V		-	-	V	V	V	V	V	V	V	V		V	
		-	-		V	-	-	V	V	V	V	V	V	V	V		V	
Conducted Spurious Emission	n30	-	-	V		-	-	V	V				V		V	V	V	
		-	-		V	-	-	V	V				V			V		
Frequency Stability	n30	-	-		V	-	-		V					V		V		
Radiated Spurious Emission	n30	Worst Case														V		
Note	<ol style="list-style-type: none"> The mark "v " means that this configuration is chosen for testing The mark "- " means that this bandwidth is not supported. The device is investigated from 30MHz to 10 times of fundamental signal for radiated spurious emission test under different RB size/offset and modulations in exploratory test. Subsequently, only the worst case emissions are reported. 5G NR supports SCS 15KHz and 30KHz, according to engineering evaluation, only choose the SCS 15KHz (the highest conducted power) perform for all tests. Based on engineering evaluation, only the worst modulation test results are shown in the report. 																	

2.2 Connection Diagram of Test System

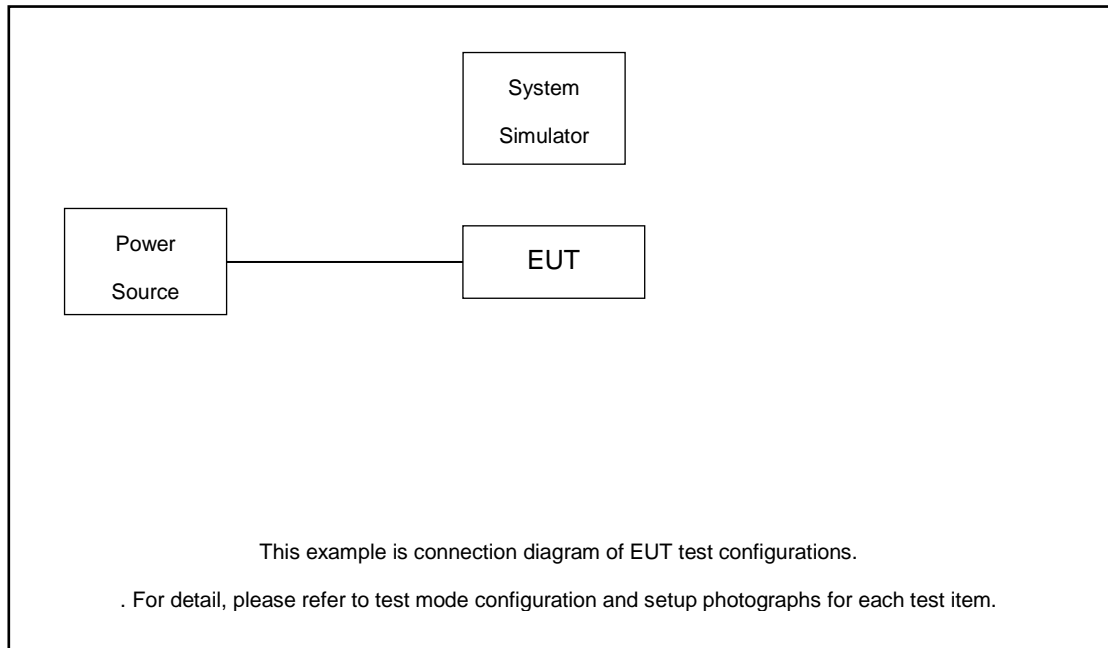

2.3 Support Unit used in test configuration and system

Item	Equipment	Trade Name	Model No.	FCC ID	Data Cable	Power Cord
1.	Power Supply	GWINSTEK	PSS-2002	N/A	N/A	Unshielded, 1.8 m
2.	Base Station	Keysight	UXM E7515B	N/A	N/A	Unshielded, 1.5 m
3.	Test jig	N/A	N/A	N/A	N/A	N/A

2.4 Measurement Results Explanation Example

For all conducted test items:

The offset level is set in the spectrum analyzer to compensate the RF cable loss between EUT conducted output port and spectrum analyzer. With the offset compensation, the spectrum analyzer reading level is exactly the EUT RF output level.

The spectrum analyzer offset is derived from RF cable loss.

Offset = RF cable loss.

Following shows an offset computation example with cable loss 4.4 dB.

Example :

$$\begin{aligned} \text{Offset(dB)} &= \text{RF cable loss(dB)}. \\ &= 4.4 \text{ (dB)} \end{aligned}$$



2.5 Frequency List of Low/Middle/High Channels

5G NR n30 Channel and Frequency List				
BW [MHz]	Channel/Frequency(MHz)	Lowest	Middle	Highest
10	Channel	-	462000	-
	Frequency	-	2310	-
5	Channel	461500	462000	462500
	Frequency	2307.5	2310	2312.5

3 Conducted Test Items

3.1 Measuring Instruments

See list of measuring instruments of this test report.

3.2 Test Setup

3.2.1 Conducted Output Power

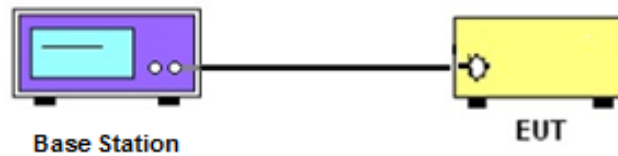

3.2.2 Peak-to-Average Ratio, Occupied / 26dB Bandwidth ,Band-Edge and Conducted Spurious Emission

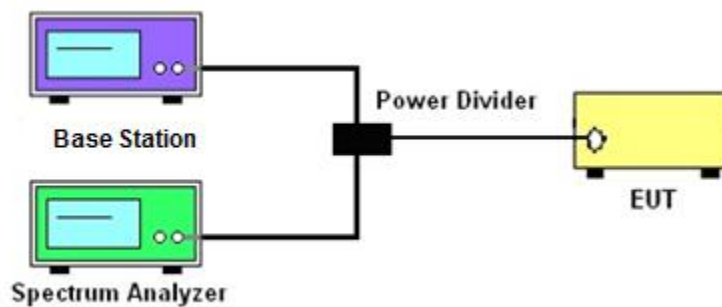

3.2.3 Frequency Stability

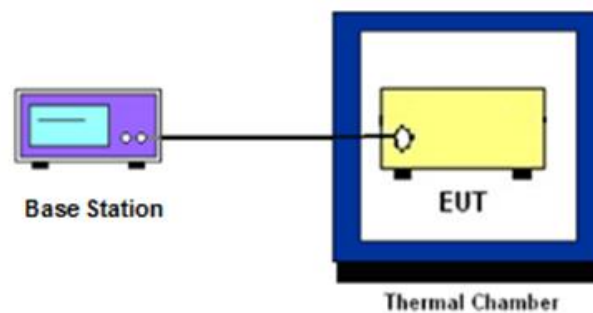

3.3 Test Result of Conducted Test

Please refer to Appendix A.



3.4 Conducted Output Power Measurement

3.4.1 Description of the Conducted Output Power Measurement

A base station simulator was used to establish communication with the EUT. Its parameters were set to transmit the maximum power on the EUT. The measured power in the radio frequency on the transmitter output terminals shall be reported.

3.4.2 Test Procedures

1. The testing follows ANSI C63.26 Section 5.2
2. The transmitter output port was connected to the system simulator.
3. Set EUT at maximum power through the system simulator.
4. Select lowest, middle, and highest channels for each band and different modulation.
5. Measure and record the power level from the system simulator.

3.5 Peak-to-Average Ratio

3.5.1 Description of the PAR Measurement

Power Complementary Cumulative Distribution Function (CCDF) curves provide a means for characterizing the power peaks of a digitally modulated signal on a statistical basis. A CCDF curve depicts the probability of the peak signal amplitude exceeding the average power level. Most contemporary measurement instrumentation include the capability to produce CCDF curves for an input signal provided that the instrument's resolution bandwidth can be set wide enough to accommodate the entire input signal bandwidth. In measuring transmissions in this band using an average power technique, the peak-to-average ratio (PAR) of the transmission may not exceed 13 dB.

3.5.2 Test Procedures

1. The testing follows ANSI C63.26 Section 5.2.3.4 (CCDF).
2. The EUT was connected to spectrum and system simulator via a power divider.
3. Set the CCDF (Complementary Cumulative Distribution Function) option in spectrum analyzer.
4. The highest RF powers were measured and recorded the maximum PAPR level associated with a probability of 0.1 %.
5. Record the deviation as Peak to Average Ratio.

3.6 EIRP

3.6.1 Description of EIRP

For mobile and portable stations transmitting in the 2305-2315 MHz band or the 2350-2360 MHz band, the average EIRP must not exceed 50 milliwatts within any 1 megahertz of authorized bandwidth, *except that* for mobile and portable stations compliant with 3GPP LTE standards or another advanced mobile broadband protocol that avoids concentrating energy at the edge of the operating band the average EIRP must not exceed 250 milliwatts within any 5 megahertz of authorized bandwidth but may exceed 50 milliwatts within any 1 megahertz of authorized bandwidth. For mobile and portable stations using time division duplexing (TDD) technology, the duty cycle must not exceed 38 percent in the 2305-2315 MHz and 2350-2360 MHz bands. Mobile and portable stations using FDD technology are restricted to transmitting in the 2305-2315 MHz band. Power averaging shall not include intervals in which the transmitter is off.

3.6.2 Test Procedures

1. According to KDB 412172 D01 Power Approach,
2. $EIRP = P_T + G_T - L_C$, $ERP = EIRP - 2.15$, where

P_T = transmitter output power in dBm

G_T = gain of the transmitting antenna in dBi

L_C = signal attenuation in the connecting cable between the transmitter and antenna in dB

3.7 Occupied Bandwidth

3.7.1 Description of Occupied Bandwidth Measurement

The occupied bandwidth is the width of a frequency band such that, below the lower and above the upper frequency limits, the mean powers emitted are each equal to a specified percentage 0.5% of the total mean transmitted power.

The 26 dB emission bandwidth is defined as the frequency range between two points, one above and one below the carrier frequency, at which the spectral density of the emission is attenuated 26 dB below the maximum in-band spectral density of the modulated signal. Spectral density (power per unit bandwidth) is to be measured with a detector of resolution bandwidth equal to approximately 1.0% of the emission bandwidth.

3.7.2 Test Procedures

1. The testing follows ANSI C63.26 Section 5.4
2. The EUT was connected to spectrum analyzer and system simulator via a power divider.
3. The spectrum analyzer center frequency is set to the nominal EUT channel center frequency. The span range for the spectrum analyzer shall be between two and five times the anticipated OBW.
4. The nominal resolution bandwidth (RBW) shall be in the range of 1 to 5 % of the anticipated OBW, and the VBW shall be at least 3 times the RBW.
5. Set the detection mode to peak, and the trace mode to max hold.
6. Determine the reference value: Set the EUT to transmit a modulated signal. Allow the trace to stabilize. Set the spectrum analyzer marker to the highest level of the displayed trace.
(this is the reference value)
7. Determine the “-26 dB down amplitude” as equal to (Reference Value – X).
8. Place two markers, one at the lowest and the other at the highest frequency of the envelope of the spectral display such that each marker is at or slightly below the “-X dB down amplitude” determined in step 6. If a marker is below this “-X dB down amplitude” value it shall be placed as close as possible to this value. The OBW is the positive frequency difference between the two markers.
9. Use the 99 % power bandwidth function of the spectrum analyzer and report the measured bandwidth.

3.8 Conducted Band Edge Measurement

3.8.1 Description of Conducted Band Edge Measurement

27.53 (a)(4)

For mobile and portable stations operating in the 2305-2315 MHz and 2350-2360 MHz bands:

- (i) By a factor of not less than: $43 + 10 \log (P)$ dB on all frequencies between 2305 and 2320 MHz and on all frequencies between 2345 and 2360 MHz that are outside the licensed band(s) of operation, not less than $55 + 10 \log (P)$ dB on all frequencies between 2320 and 2324 MHz and on all frequencies between 2341 and 2345 MHz, not less than $61 + 10 \log (P)$ dB on all frequencies between 2324 and 2328 MHz and on all frequencies between 2337 and 2341 MHz, and not less than $67 + 10 \log (P)$ dB on all frequencies between 2328 and 2337 MHz;
- (ii) By a factor of not less than $43 + 10 \log (P)$ dB on all frequencies between 2300 and 2305 MHz, $55 + 10 \log (P)$ dB on all frequencies between 2296 and 2300 MHz, $61 + 10 \log (P)$ dB on all frequencies between 2292 and 2296 MHz, $67 + 10 \log (P)$ dB on all frequencies between 2288 and 2292 MHz, and $70 + 10 \log (P)$ dB below 2288 MHz;
- (iii) By a factor of not less than $43 + 10 \log (P)$ dB on all frequencies between 2360 and 2365 MHz, and not less than $70 + 10 \log (P)$ dB above 2365 MHz.

3.8.2 Test Procedures

1. The testing follows ANSI C63.26 section 5.7
2. The EUT was connected to spectrum analyzer and system simulator via a power divider.
3. The band edges of low and high channels for the highest RF powers were measured.
4. Set RBW \geq 1% EBW in the 1MHz band immediately outside and adjacent to the band edge.
5. Beyond the 1 MHz band from the band edge, RBW=1MHz was used.
6. Set spectrum analyzer with RMS detector.
7. The RF fundamental frequency should be excluded against the limit line in the operating frequency band.
8. Checked that all the results comply with the emission limit line.

Example:

The limit line is derived from $43 + 10\log(P)$ dB below the transmitter power P(Watts)

$$= P(W) - [43 + 10\log(P)] \text{ (dB)}$$

$$= [30 + 10\log(P)] \text{ (dBm)} - [43 + 10\log(P)] \text{ (dB)} = -13\text{dBm.}$$

3.9 Conducted Spurious Emission Measurement

3.9.1 Description of Conducted Spurious Emission Measurement

The power of any emission outside of the authorized operating frequency ranges must be lower than the transmitter power (P) by a factor of at least $70 + 10 \log (P)$ dB.

It is measured by means of a calibrated spectrum analyzer and scanned from 9 kHz up to a frequency including its 10th harmonic.

3.9.2 Test Procedures

1. The testing follows ANSI C63.26 section 5.7
2. The EUT was connected to spectrum analyzer and system simulator via a power divider.
3. The RF output of EUT was connected to the spectrum analyzer by RF cable and attenuator. The path loss was compensated to the results for each measurement.
4. The middle channel for the highest RF power within the transmitting frequency was measured.
5. The conducted spurious emission for the whole frequency range was taken.
6. Make the measurement with the spectrum analyzer's RBW = 1MHz, VBW = 3MHz.
7. Set spectrum analyzer with RMS detector.
8. Taking the record of maximum spurious emission.
9. The RF fundamental frequency should be excluded against the limit line in the operating frequency band.
10. The limit line is derived from $70 + 10\log(P)$ dB below the transmitter power P(Watts)
= $P(W) - [70 + 10\log(P)]$ (dB)
= $[30 + 10\log(P)]$ (dBm) - $[70 + 10\log(P)]$ (dB)
= -40dBm

3.10 Frequency Stability Measurement

3.10.1 Description of Frequency Stability Measurement

The frequency stability shall be measured by variation of ambient temperature and variation of primary supply voltage to ensure that the fundamental emission stays within the authorized frequency block. The frequency stability of the transmitter shall be maintained within $\pm 0.00025\%$ ($\pm 2.5\text{ppm}$) of the center frequency.

3.10.2 Test Procedures for Temperature Variation

1. The testing follows ANSI C63.26 section 5.6.4
2. The EUT was set up in the thermal chamber and connected with the system simulator.
3. With power OFF, the temperature was decreased to -30°C and the EUT was stabilized before testing. Power was applied and the maximum change in frequency was recorded within one minute.
4. With power OFF, the temperature was raised in 10°C step up to 50°C . The EUT was stabilized at each step for at least half an hour. Power was applied and the maximum frequency change was recorded within one minute.

3.10.3 Test Procedures for Voltage Variation

1. The testing follows ANSI C63.26 section 5.6.5.
2. The EUT was placed in a temperature chamber at $20\pm 5^{\circ}\text{C}$ and connected with the system simulator.
3. The power supply voltage to the EUT was varied from 85% to 115% of the nominal value for other than hand carried battery equipment.
4. For hand carried, battery powered equipment, reduce the primary ac or dc supply voltage to the battery operating end point, which shall be specified by the manufacturer.
5. The variation in frequency was measured for the worst case.

4 Radiated Test Items

4.1 Measuring Instruments

See list of measuring instruments of this test report.

4.2 Test Setup

4.2.1 For radiated test from 30MHz to 1GHz

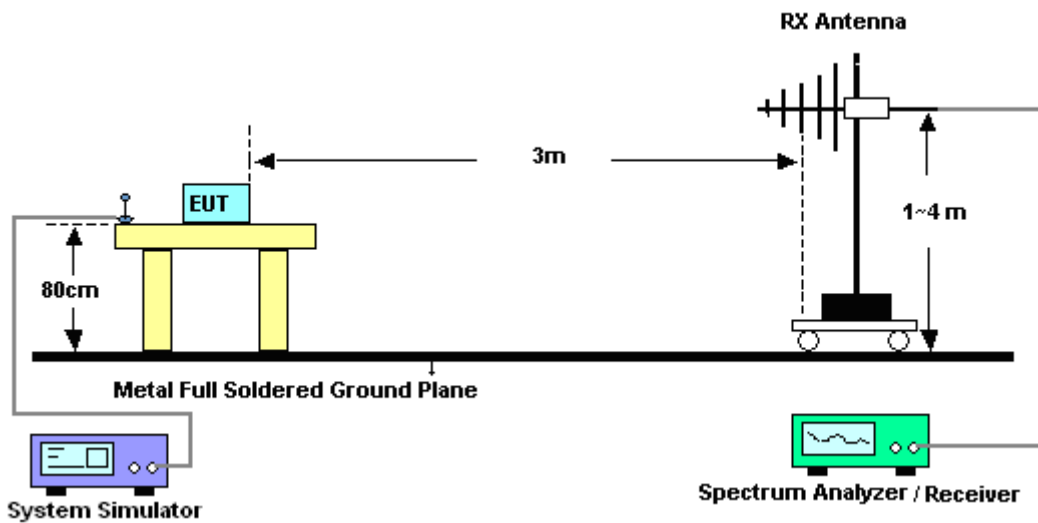

4.2.2 For radiated test above 1GHz

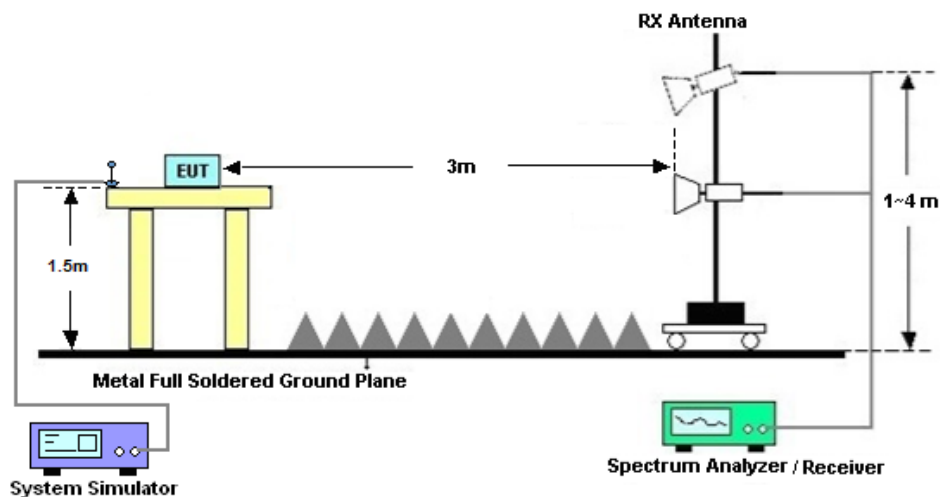

4.3 Test Result of Radiated Test

Please refer to Appendix B.



4.4 Radiated Spurious Emission Measurement

4.4.1 Description of Radiated Spurious Emission

The radiated spurious emission was measured by substitution method according to ANSI/TIA-603-E. The power of any emission outside of the authorized operating frequency ranges must be attenuated below the transmitter power (P) by a factor of at least $70 + 10 \log(P)$ dB.

The spectrum is scanned from 30 MHz up to a frequency including its 10th harmonic.

4.4.2 Test Procedures

1. The testing follows ANSI C63.26 Section 5.5
2. The EUT was placed on a turntable with 0.8 meter height for frequency below 1GHz and 1.5 meter height for frequency above 1GHz respectively above ground.
3. The EUT was set 3 meters from the receiving antenna mounted on the antenna tower.
4. The table was rotated 360 degrees to determine the position of the highest spurious emission.
5. The height of the receiving antenna is varied between 1m to 4m to search the maximum spurious emission for both horizontal and vertical polarizations.
6. During the measurement, the system simulator parameters were set to force the EUT transmitting at maximum output power.
7. Make the measurement with the spectrum analyzer's RBW = 1MHz, VBW = 3MHz, taking the record of maximum spurious emission.
8. A horn antenna was substituted in place of the EUT and was driven by a signal generator.
9. Tune the output power of signal generator to the same emission level with EUT maximum spurious emission.

$$\text{EIRP (dBm)} = \text{S.G. Power} - \text{Tx Cable Loss} + \text{Tx Antenna Gain}$$

$$\text{ERP (dBm)} = \text{EIRP} - 2.15$$

10. The RF fundamental frequency should be excluded against the limit line in the operating frequency band.

The limit line is derived from $70 + 10\log(P)$ dB below the transmitter power P(Watts)

$$= P(W) - [70 + 10\log(P)] \text{ (dB)}$$

$$= [30 + 10\log(P)] \text{ (dBm)} - [70 + 10\log(P)] \text{ (dB)}$$

$$= -40\text{dBm.}$$



5 List of Measuring Equipment

Instrument	Manufacturer	Model No.	Serial No.	Characteristics	Calibration Date	Test Date	Due Date	Remark
Spectrum Analyzer	R&S	FSV40	101078	10Hz~40GHz	Apr. 17, 2020	Jan. 13, 2021~ Feb. 10, 2021	Apr. 16, 2021	Conducted (TH01-SZ)
Thermal Chamber	Ten Billion Hongzhangroup	LP-150U	H201408180 3	-40~+150°C	Jul. 22, 2020	Jan. 13, 2021~ Feb. 10, 2021	Jul. 21, 2021	Conducted (TH01-SZ)
EMI Test Receiver&SA	KEYSIGHT	N9038A	MY5445008 3	20Hz~8.4GHz	Apr. 17, 2020	Jan. 27, 2021	Apr. 16, 2021	Radiation (03CH03-SZ)
EXA Spectrum Analyzer	KEYSIGHT	N9010A	MY5515024 6	10Hz~44GHz;	Apr. 17, 2020	Jan. 27, 2021	Apr. 16, 2021	Radiation (03CH03-SZ)
Bilog Antenna	TeseQ	CBL6112D	35408	30MHz~2GHz	Jun. 22, 2020	Jan. 27, 2021	Jun. 21, 2021	Radiation (03CH03-SZ)
Double Ridge Horn Antenna	SCHWARZBECK	BBHA9120 D	9120D-1355	1GHz~18GHz	Apr. 30, 2020	Jan. 27, 2021	Apr. 29, 2021	Radiation (03CH03-SZ)
Amplifier	Burgeon	BPA-530	102210	0.01Hz ~3000MHz	Oct. 17, 2020	Jan. 27, 2021	Oct. 16, 2021	Radiation (03CH03-SZ)
HF Amplifier	MITEQ	TTA1840-35 -HG	1871923	18GHz~40GHz	Jul. 21, 2020	Jan. 27, 2021	Jul. 20, 2021	Radiation (03CH03-SZ)
SHF-EHF Horn	com-power	AH-840	101071	18Ghz-40GHz	Apr. 23, 2020	Jan. 27, 2021	Apr. 22, 2021	Radiation (03CH03-SZ)
Amplifier	Agilent Technologies	83017A	MY3950130 2	500MHz~26.5G Hz	Dec. 25, 2020	Jan. 27, 2021	Dec. 24, 2021	Radiation (03CH03-SZ)
AC Power Source	Chroma	61601	6160100019 85	N/A	NCR	Jan. 27, 2021	NCR	Radiation (03CH03-SZ)
Turn Table	EM	EM1000	N/A	0~360 degree	NCR	Jan. 27, 2021	NCR	Radiation (03CH03-SZ)
Antenna Mast	EM	EM1000	N/A	1 m~4 m	NCR	Jan. 27, 2021	NCR	Radiation (03CH03-SZ)

NCR: No Calibration Required

6 Uncertainty of Evaluation

The measurement uncertainties shown below were calculated in accordance with the requirements of ANSI 63.26-2015. All the measurement uncertainty value were shown with a coverage $K=2$ to indicate 95% level of confidence. The measurement data show herein meets or exceeds the CISPR measurement uncertainty values specified in CISPR 16-4-2 and can be compared directly to specified limit to determine compliance.

Uncertainty of Radiated Emission Measurement (30 MHz ~ 1000 MHz)

Measuring Uncertainty for a Level of Confidence of 95% ($U = 2Uc(y)$)	3.0dB
-------------------------------------------------------------------------	-------

Uncertainty of Radiated Emission Measurement (1 GHz ~ 18 GHz)

Measuring Uncertainty for a Level of Confidence of 95% ($U = 2Uc(y)$)	3.6dB
-------------------------------------------------------------------------	-------

Uncertainty of Radiated Emission Measurement (18 GHz ~ 40 GHz)

Measuring Uncertainty for a Level of Confidence of 95% ($U = 2Uc(y)$)	3.8dB
-------------------------------------------------------------------------	-------

Appendix A. Test Results of Conducted Test

Conducted Output Power(Average power) and EIRP

SCS 15							
SA n30 (ANT M) 10MHz (GT - LC = 1 dB)							
Channel	Mode	NR		Conducted		EIRP	
		RB		Power (dBm/5MHz)	Power (W/5MHz)	EIRP (dBm/5MHz)	EIRP (W/5MHz)
		Size	Offset				
Middle	PI/2 BPSK DFT-s-OFDM	1	1	22.10	0.1622	23.10	0.2042
		1	50	22.41	0.1742	23.41	0.2193
		25	12	22.24	0.1675	23.24	0.2109
	QPSK DFT-s-OFDM	1	1	21.94	0.1563	22.94	0.1968
		1	50	22.26	0.1683	23.26	0.2118
		25	12	22.27	0.1687	23.27	0.2123
	16QAM DFT-s-OFDM	1	1	21.16	0.1306	22.16	0.1644
		1	50	21.22	0.1324	22.22	0.1667
		25	12	21.26	0.1337	22.26	0.1683
	64QAM DFT-s-OFDM	1	1	20.12	0.1028	21.12	0.1294
		1	50	20.16	0.1038	21.16	0.1306
		25	12	20.23	0.1054	21.23	0.1327
	256QAM DFT-s-OFDM	1	1	17.36	0.0545	18.36	0.0685
		1	50	17.41	0.0551	18.41	0.0693
		25	12	17.39	0.0548	18.39	0.069

SCS 15								
SA n30 (ANT) 5MHz (GT - LC = 1 dB)								
Channel	Mode	NR		Conducted		EIRP		
		RB		Power (dBm/5MHz)	Power (W/5MHz)	EIRP (dBm/5MHz)	EIRP (W/5MHz)	
		Size	Offset					
Lowest	PI/2 BPSK DFT-s-OFDM	1	1	22.24	0.1675	23.24	0.2109	
		1	23	22.53	0.1791	23.53	0.2254	
		12	6	22.32	0.1706	23.32	0.2148	
	QPSK DFT-s-OFDM	1	1	22.20	0.166	23.20	0.2089	
		1	23	22.37	0.1726	23.37	0.2173	
		12	6	22.31	0.1702	23.31	0.2143	
	16QAM DFT-s-OFDM	1	1	21.38	0.1374	22.38	0.173	
		1	23	21.43	0.139	22.43	0.175	
		12	6	21.42	0.1387	22.42	0.1746	
	64QAM DFT-s-OFDM	1	1	20.15	0.1035	21.15	0.1303	
		1	23	20.21	0.105	21.21	0.1321	
		12	6	20.26	0.1062	21.26	0.1337	
	256QAM DFT-s-OFDM	1	1	17.65	0.0582	18.65	0.0733	
		1	23	17.61	0.0577	18.61	0.0726	
		12	6	17.66	0.0583	18.66	0.0735	
	Middle		1	1	22.27	0.1687	23.27	0.2123



	PI/2 BPSK DFT-s-OFDM	1	23	22.45	0.1758	23.45	0.2213	
		12	6	22.43	0.175	23.43	0.2203	
	QPSK DFT-s-OFDM	1	1	22.23	0.1671	23.23	0.2104	
		1	23	22.37	0.1726	23.37	0.2173	
		16QAM DFT-s-OFDM	12	6	22.41	0.1742	23.41	0.2193
			1	1	21.41	0.1384	22.41	0.1742
		16QAM DFT-s-OFDM	1	23	21.40	0.138	22.40	0.1738
			12	6	21.52	0.1419	22.52	0.1786
		64QAM DFT-s-OFDM	1	1	20.22	0.1052	21.22	0.1324
			1	23	20.02	0.1005	21.02	0.1265
		64QAM DFT-s-OFDM	12	6	20.05	0.1012	21.05	0.1274
			1	1	17.88	0.0614	18.88	0.0773
		256QAM DFT-s-OFDM	1	23	17.92	0.0619	18.92	0.078
			12	6	17.76	0.0597	18.76	0.0752
		QPSK CP-s-OFDM	1	1	21.03	0.1268	22.03	0.1596
			1	23	21.13	0.1297	22.13	0.1633
			13	6	21.22	0.1324	22.22	0.1667
	Highest	PI/2 BPSK DFT-s-OFDM	1	1	22.52	0.1786	23.52	0.2249
			1	23	22.53	0.1791	23.53	0.2254
			12	6	22.41	0.1742	23.41	0.2193
		QPSK DFT-s-OFDM	1	1	22.39	0.1734	23.39	0.2183
			1	23	22.36	0.1722	23.36	0.2168
			12	6	22.49	0.1774	23.49	0.2234
16QAM DFT-s-OFDM		1	1	21.35	0.1365	22.35	0.1718	
		1	23	21.23	0.1327	22.23	0.1671	
		12	6	21.41	0.1384	22.41	0.1742	
64QAM DFT-s-OFDM		1	1	20.21	0.105	21.21	0.1321	
		1	23	20.13	0.103	21.13	0.1297	
		12	6	20.09	0.1021	21.09	0.1285	
256QAM DFT-s-OFDM		1	1	18.06	0.064	19.06	0.0805	
		1	23	17.63	0.0579	18.63	0.0729	
		12	6	17.71	0.059	18.71	0.0743	

EIRP Limit	EIRP Result
< 250mW/5MHz	PASS



FR1 n30

Peak-to-Average Ratio

Mode	FR1 n30 / 5MHz / DFT-S OFDM				
Mod.	PI/2 BPSK	PI/2 BPSK	QPSK	QPSK	Limit: 13dB
RB Size	1RB	Full RB	1RB	Full RB	Result
Lowest CH	3.86	3.80	5.25	5.45	PASS
Middle CH	3.77	3.86	5.45	5.25	
Highest CH	3.77	3.88	5.39	5.33	



FR1 n30 / 5MHz / DFT-S OFDM

PI/2 BPSK

QPSK

Lowest Channel / 1 RB

Lowest Channel / 1 RB

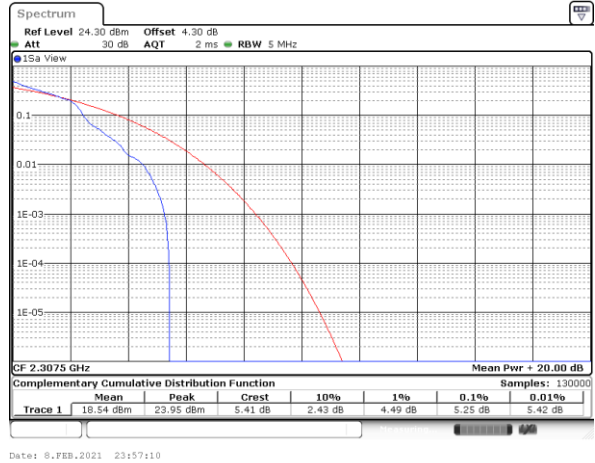
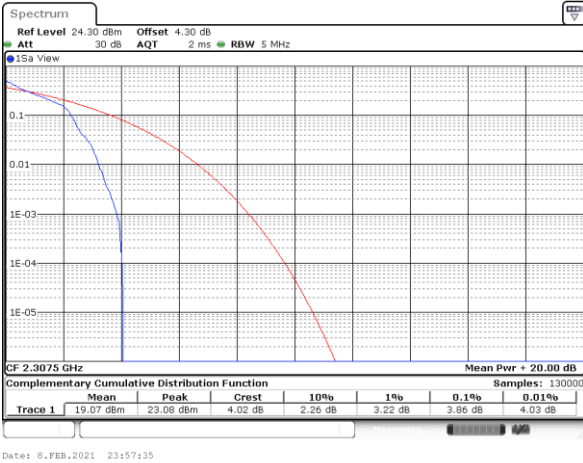

Date: 8.FEB.2021 23:57:35

Date: 8.FEB.2021 23:57:10

Middle Channel / 1 RB

Middle Channel / 1 RB

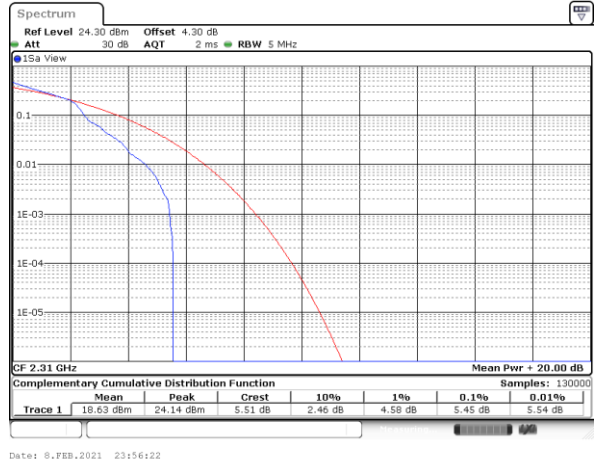
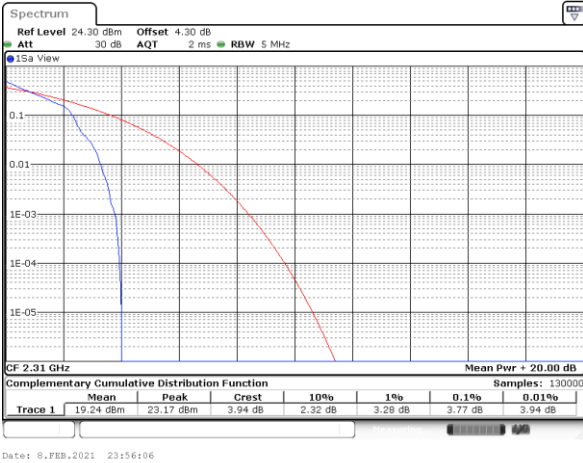

Date: 8.FEB.2021 23:56:06

Date: 8.FEB.2021 23:56:22

Highest Channel / 1 RB

Highest Channel / 1 RB

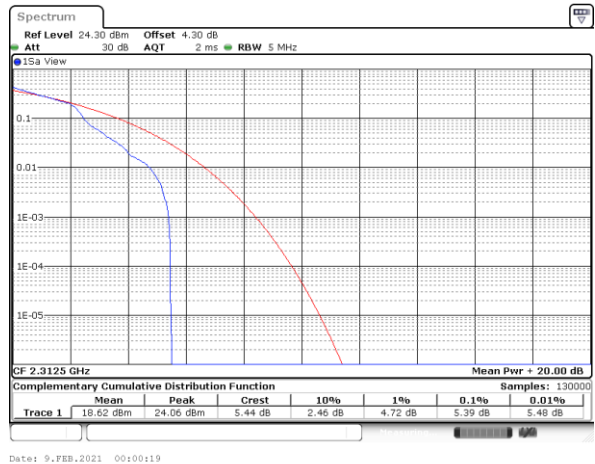
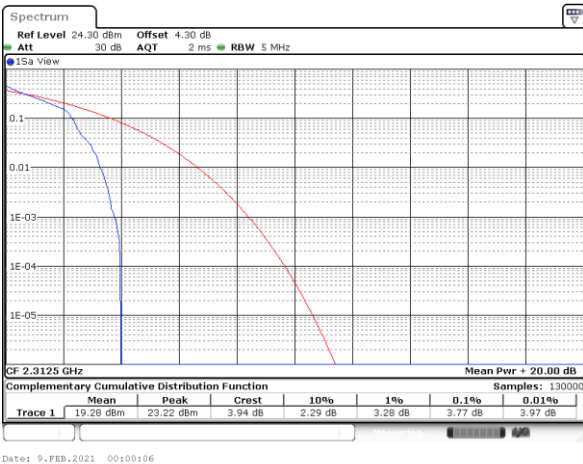

Date: 9.FEB.2021 00:00:06

Date: 9.FEB.2021 00:00:19

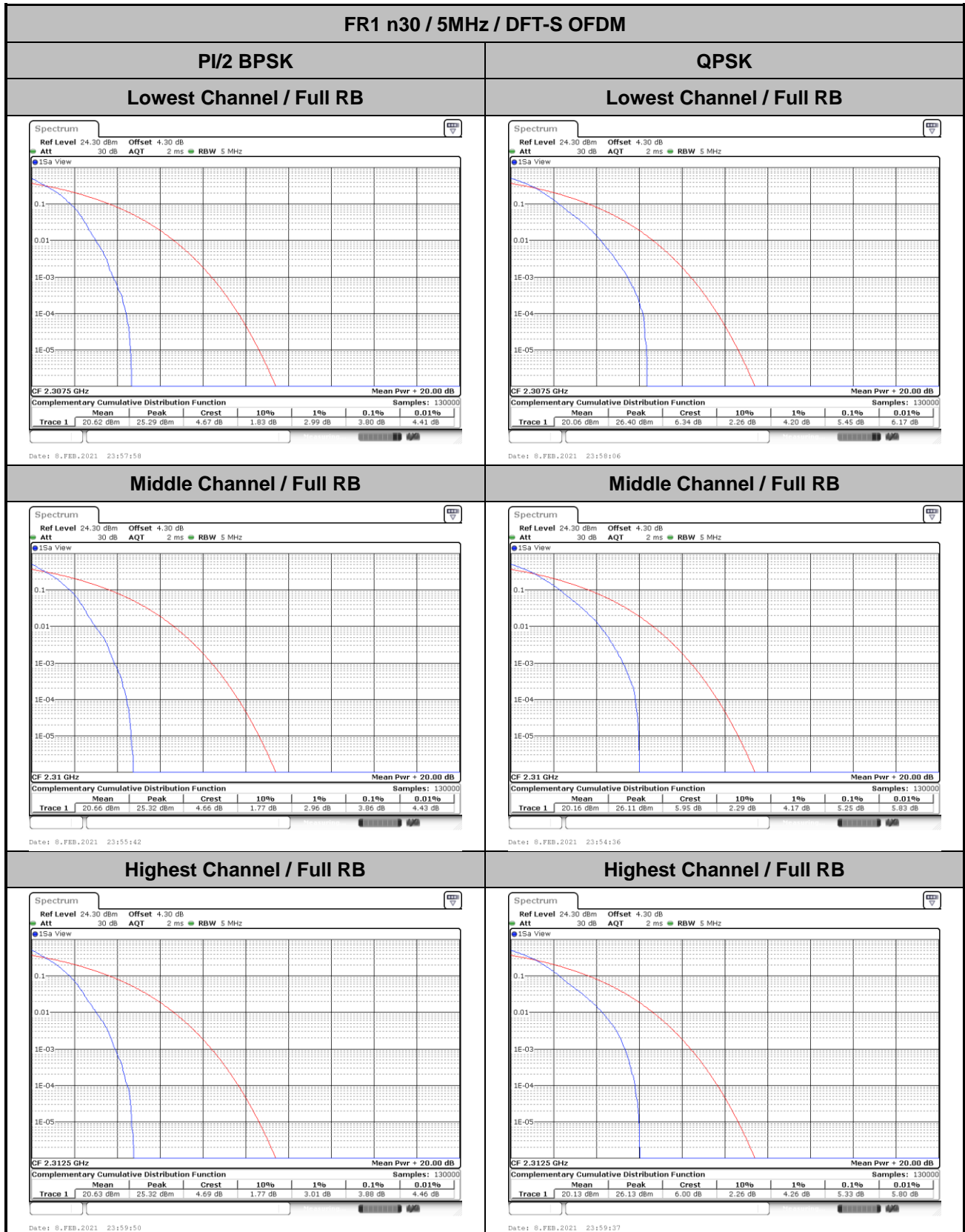



26dB Bandwidth

Mode	FR1 n30 : 26dB BW(MHz) / CP-OFDM							
BW	5MHz	5MHz	5MHz	5MHz				
Mod.	QPSK	16QAM	64QAM	256QAM				
Middle CH	4.93	5.00	4.88	4.87				

Mode	FR1 n30 : 26dB BW(MHz) / CP-OFDM							
BW	10MHz	10MHz	10MHz	10MHz				
Mod.	QPSK	16QAM	64QAM	256QAM				
Middle CH	9.83	9.75	9.79	9.77				

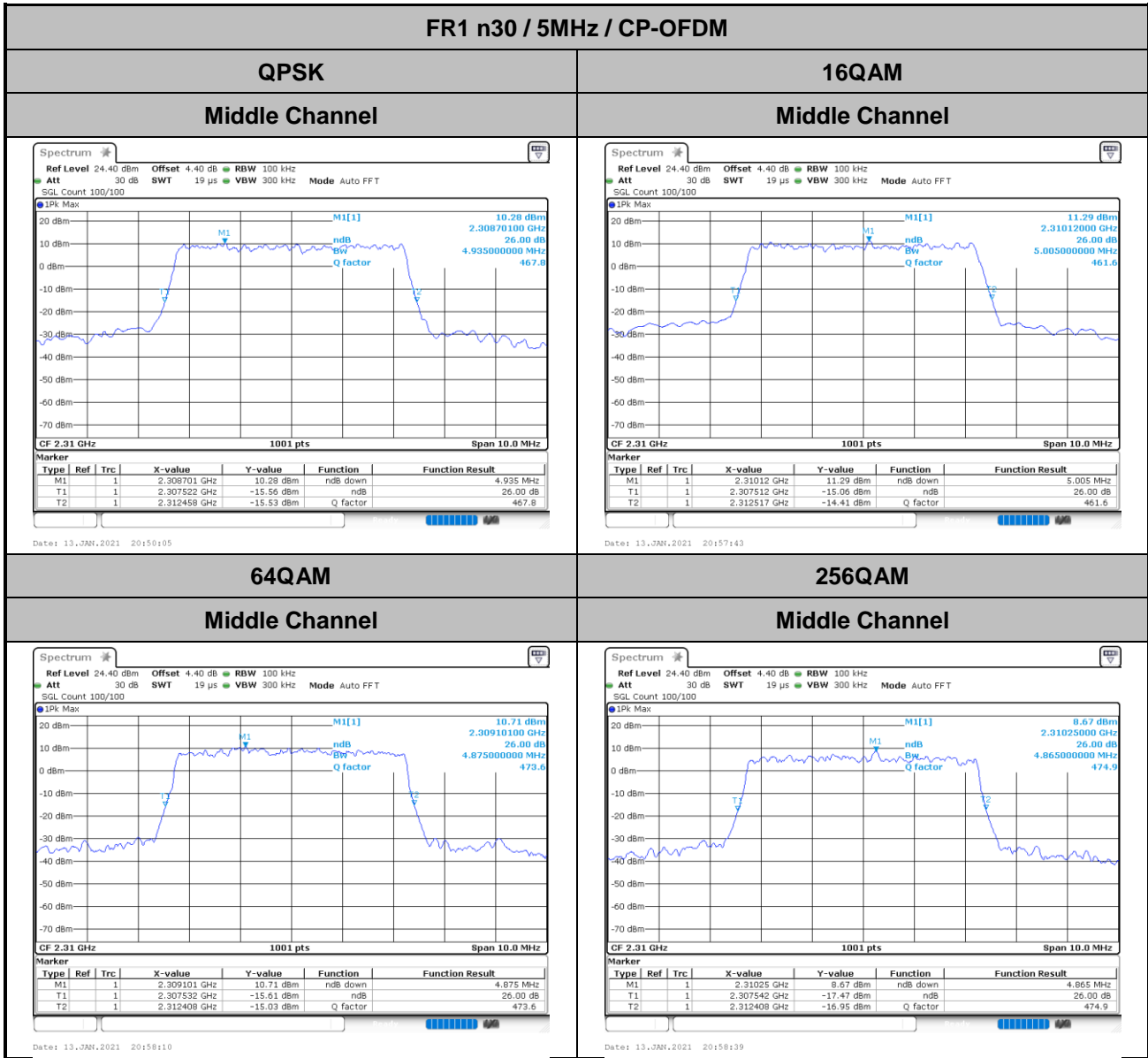

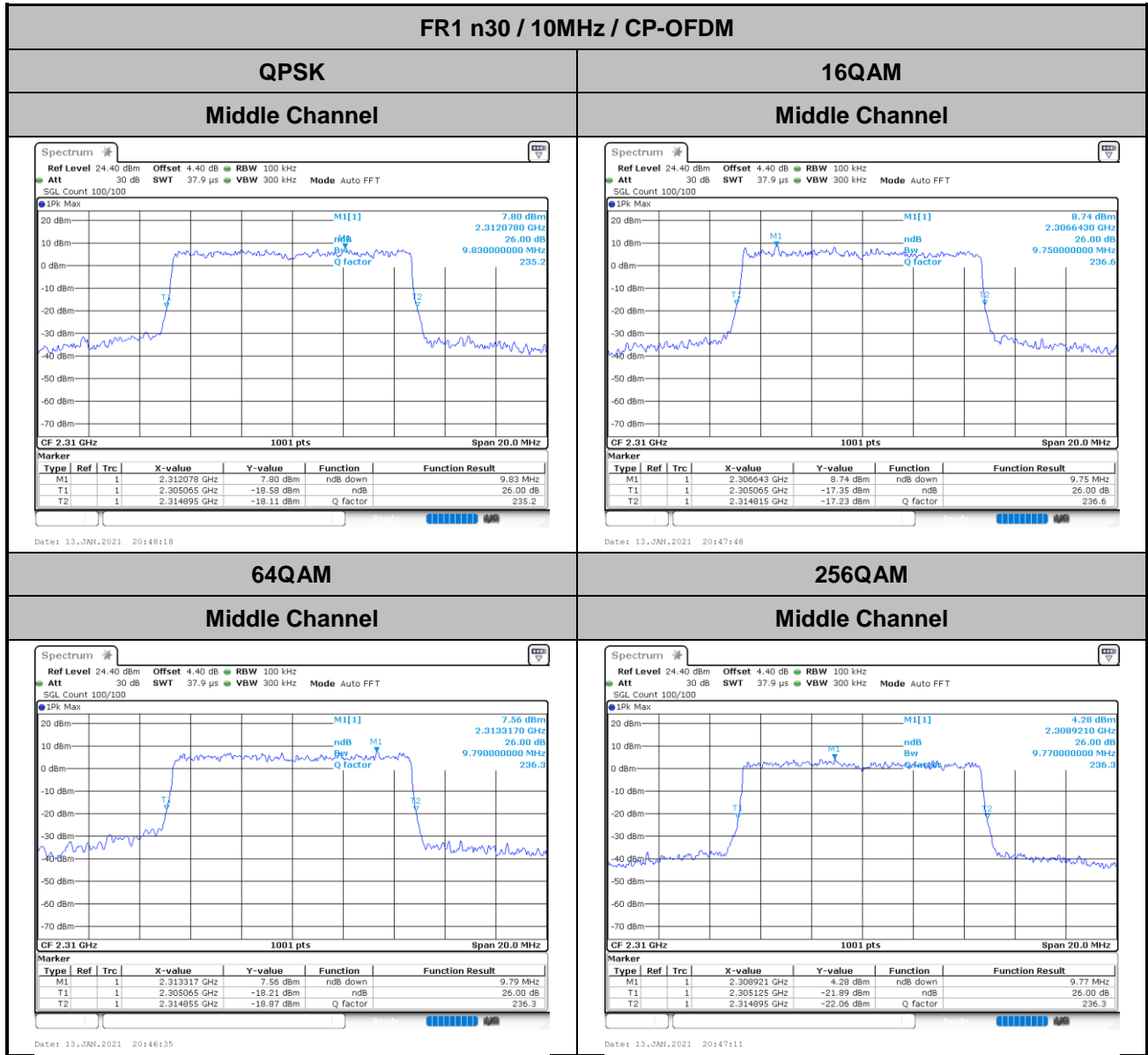



Occupied Bandwidth

Mode	FR1 n30 : OBW(MHz) / CP-OFDM							
BW	5MHz	5MHz	5MHz	5MHz				
Mod.	QPSK	16QAM	64QAM	256QAM				
Middle CH	4.46	4.49	4.49	4.50				

Mode	FR1 n30 : OBW(MHz) / CP-OFDM							
BW	10MHz	10MHz	10MHz	10MHz				
Mod.	QPSK	16QAM	64QAM	256QAM				
Middle CH	9.27	9.31	9.29	9.29				

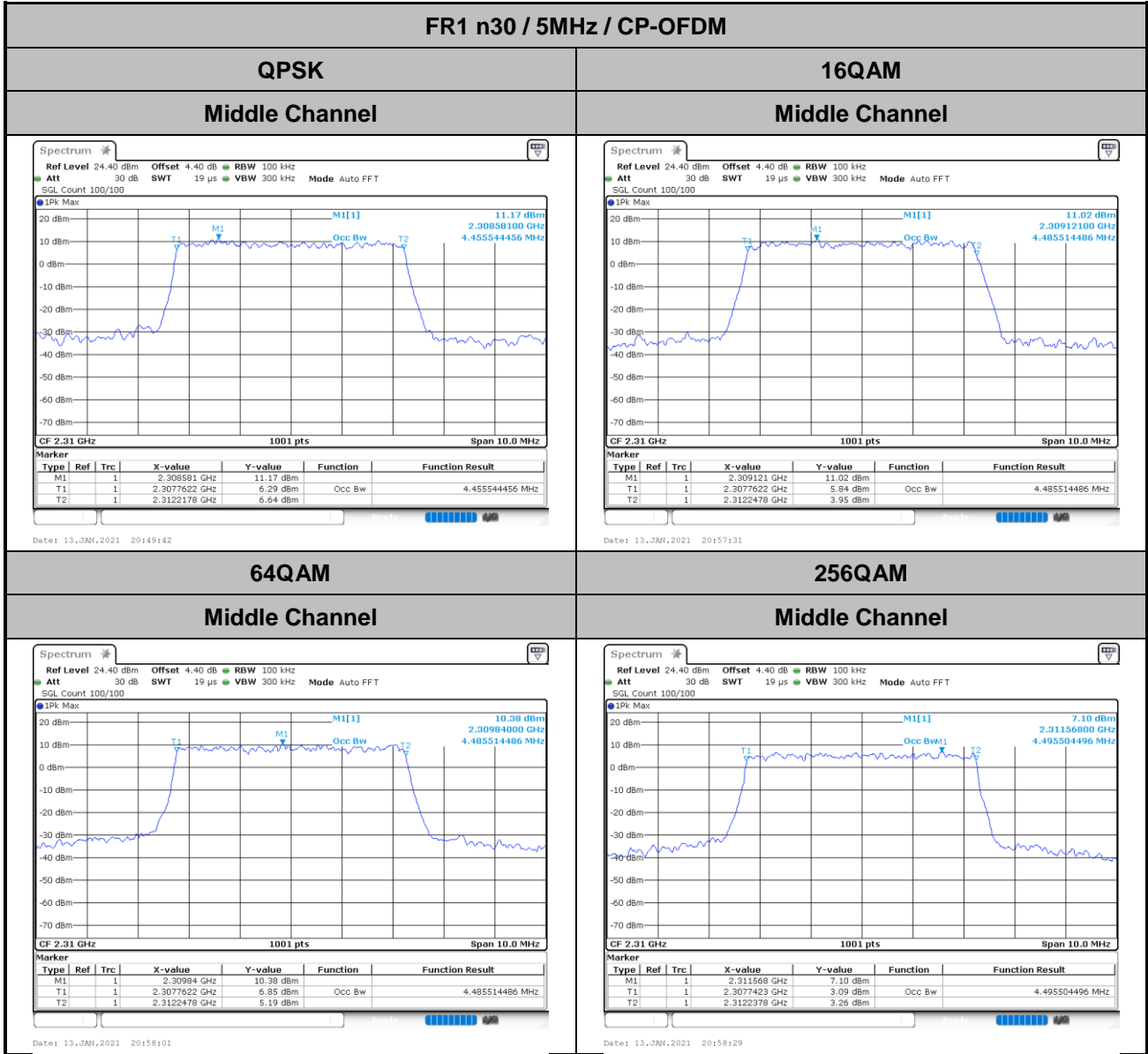

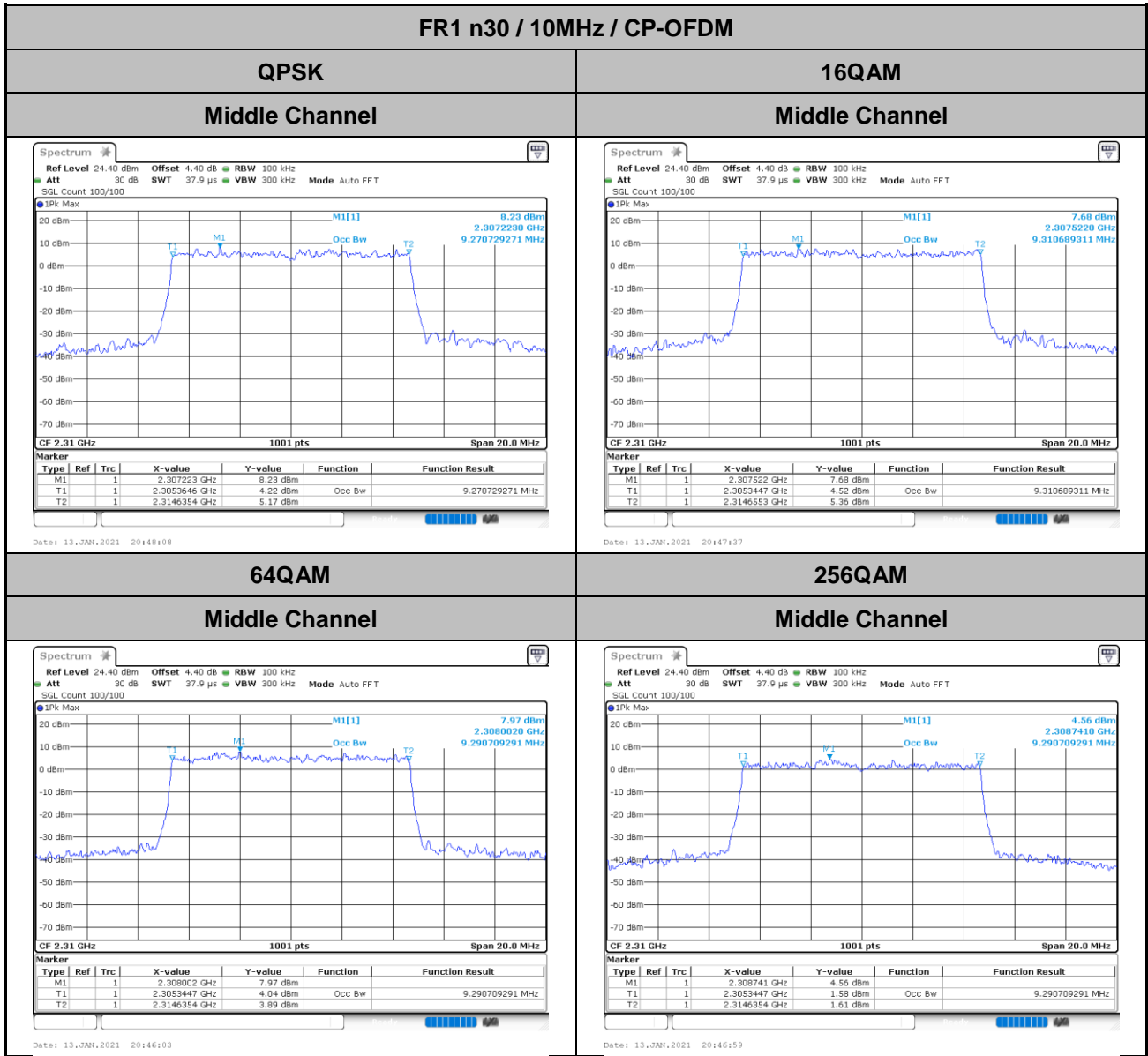



Conducted Band Edge

FR1 n30 / 5MHz / DFT-S OFDM BPSK

Lowest Band Edge / 1 RB

Channel Power < -13dBm Pass

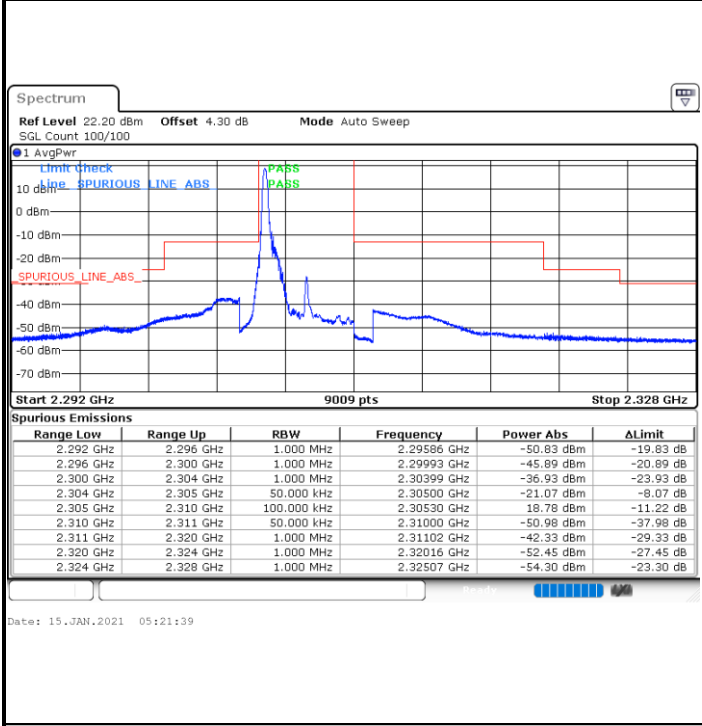

Lowest Band Edge / Full RB

Channel Power < -13dBm Pass

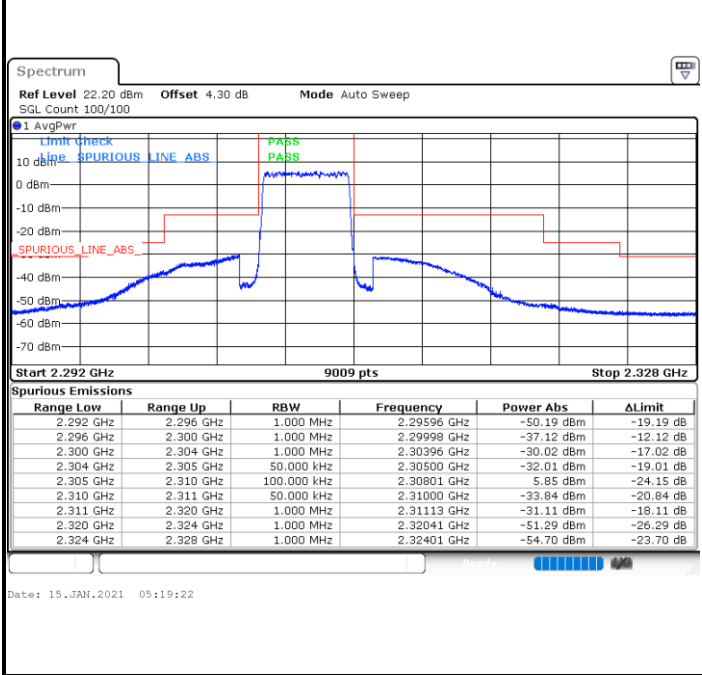



FR1 n30 / 5MHz / DFT-S OFDM BPSK

Highest Band Edge / 1 RB

Channel Power < -13dBm Pass

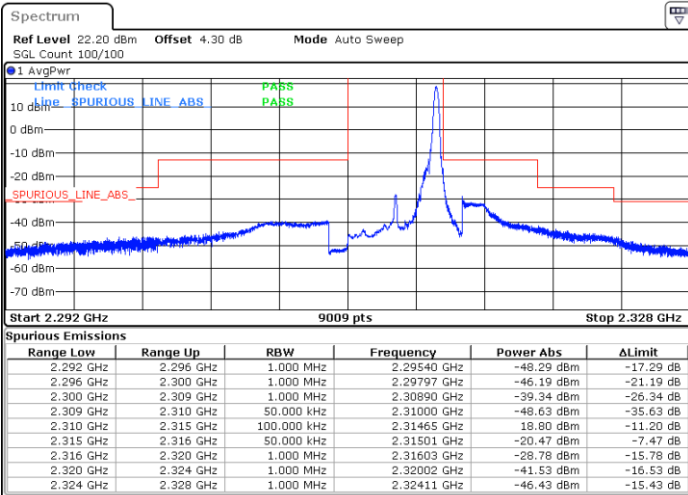

Date: 15. JAN. 2021 05:46:06

Highest Band Edge / Full RB

Channel Power < -13dBm Pass

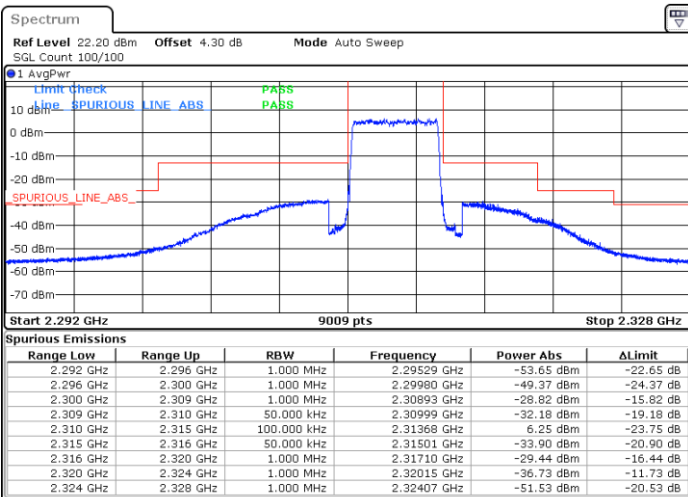

Date: 15. JAN. 2021 06:32:29



FR1 n30 / 5MHz / DFT-S OFDM QPSK

Lowest Band Edge / 1 RB

Channel Power < -13dBm Pass

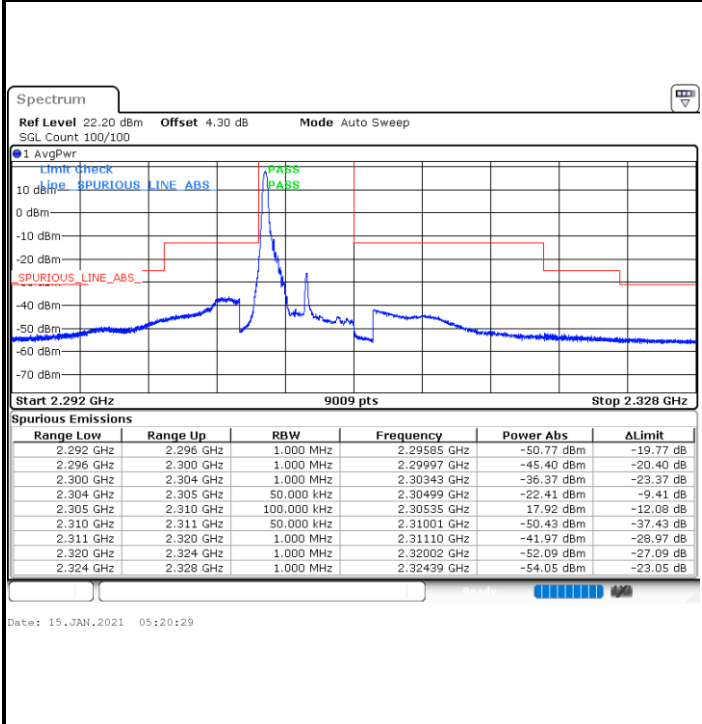

/

Lowest Band Edge / Full RB

Channel Power < -13dBm Pass

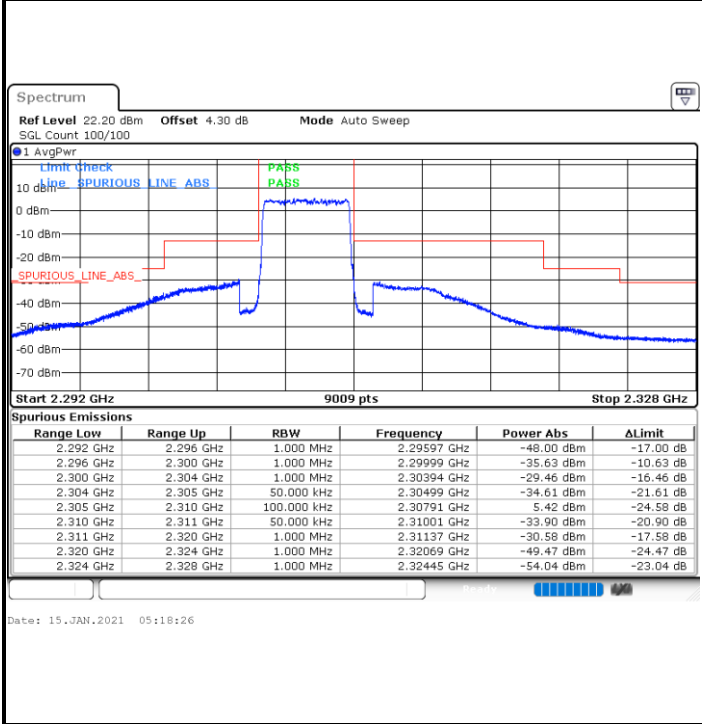

/



FR1 n30 / 5MHz / DFT-S OFDM QPSK

Highest Band Edge / 1 RB

Channel Power < -13dBm Pass

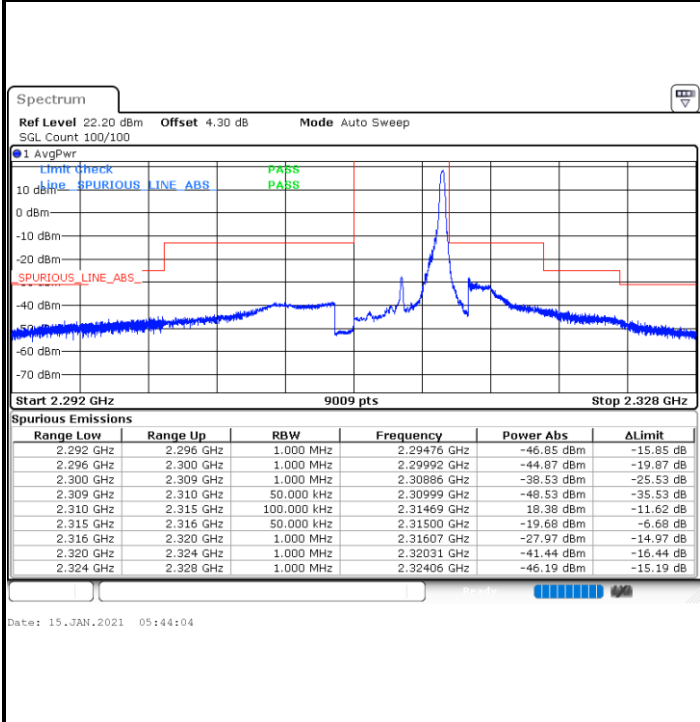

/

Highest Band Edge / Full RB

Channel Power < -13dBm Pass

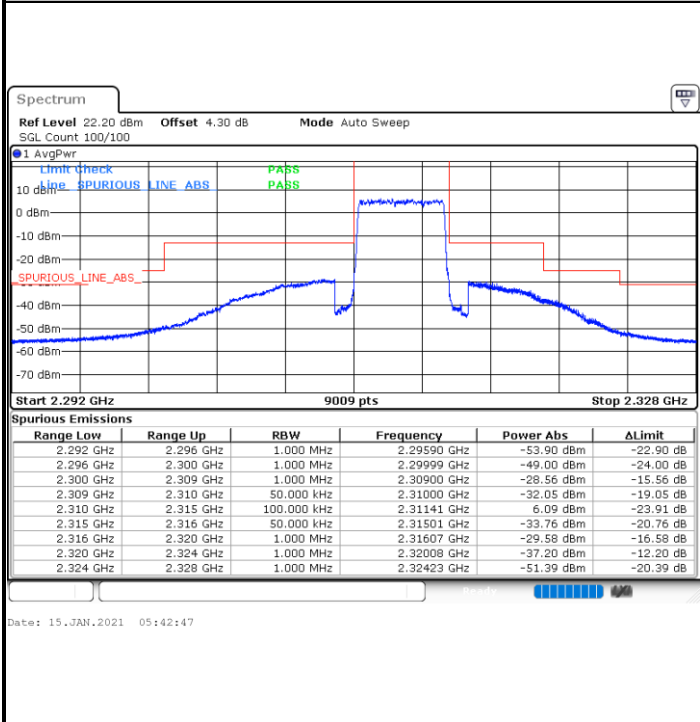

/



FR1 n30 / 10MHz / DFT-S OFDM BPSK

Lowest Band Edge / 1 RB

Highest Band Edge / 1 RB

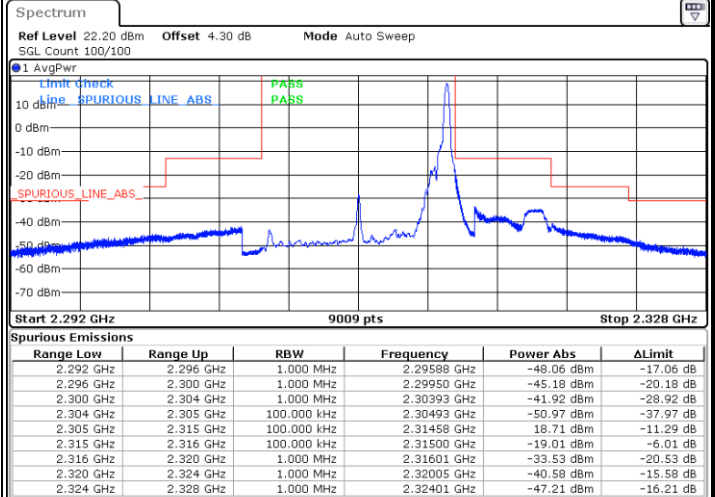
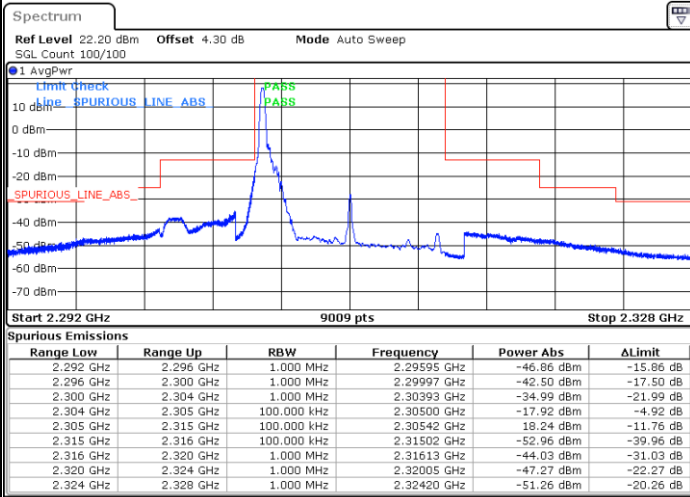

Date: 15.JAN.2021 06:09:05

Date: 15.JAN.2021 06:11:31

Band Edge / Full RB

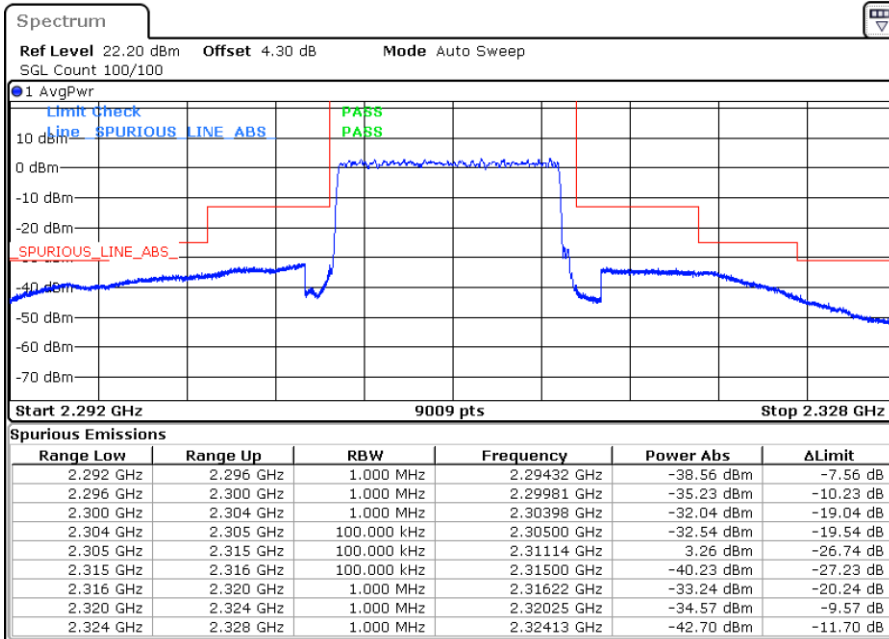

Date: 15.JAN.2021 06:04:58



FR1 n30 / 10MHz / DFT-S OFDM QPSK

Lowest Band Edge / 1 RB

Highest Band Edge / 1 RB

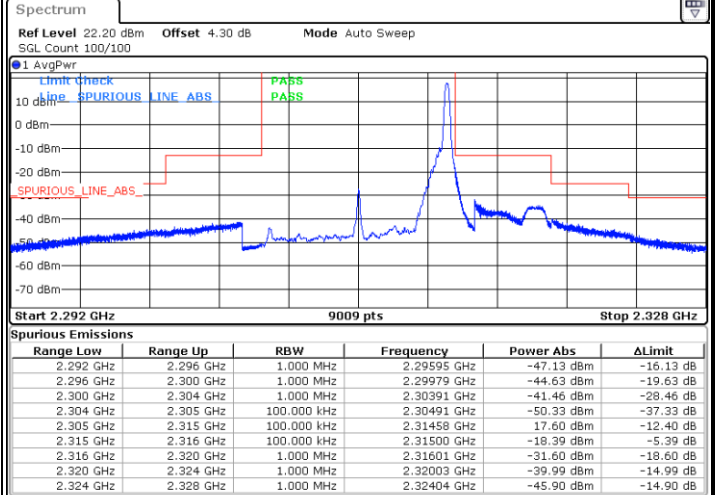
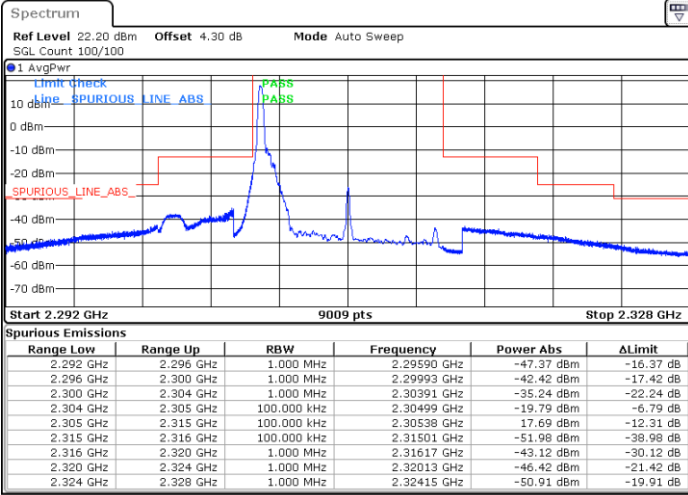

Date: 15.JAN.2021 06:06:46

Date: 15.JAN.2021 06:14:32

Band Edge / Full RB

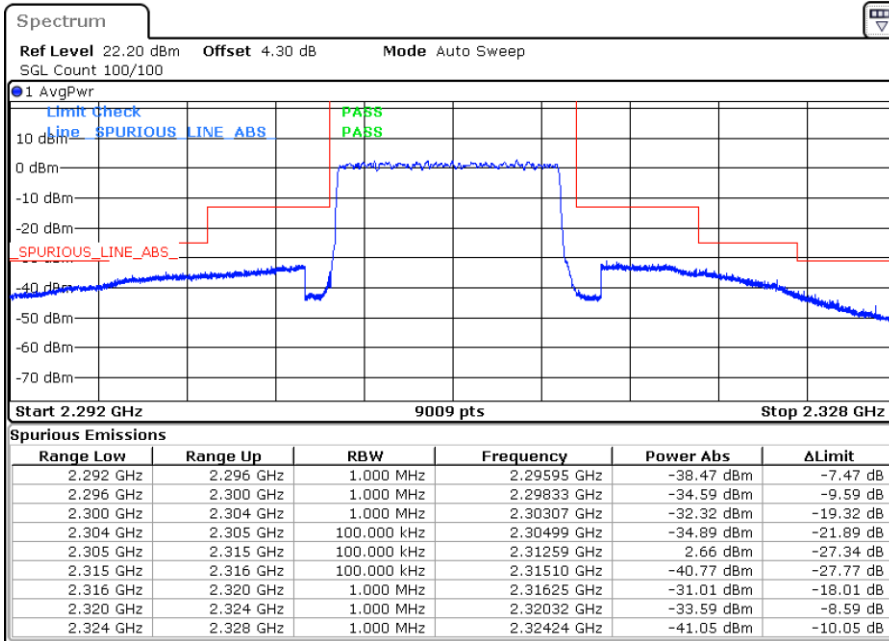

Date: 15.JAN.2021 06:06:22



Conducted Spurious Emission

FR1 n30 / 5MHz / DFT-S OFDM / BPSK

Lowest Channel / 1RB

Middle Channel / 1RB

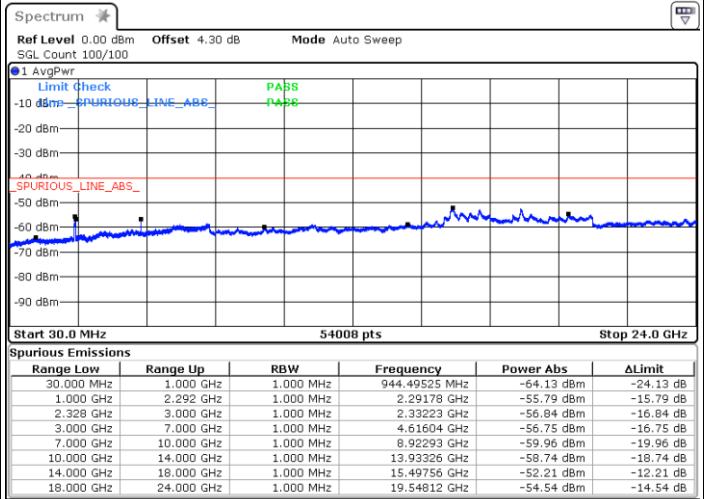
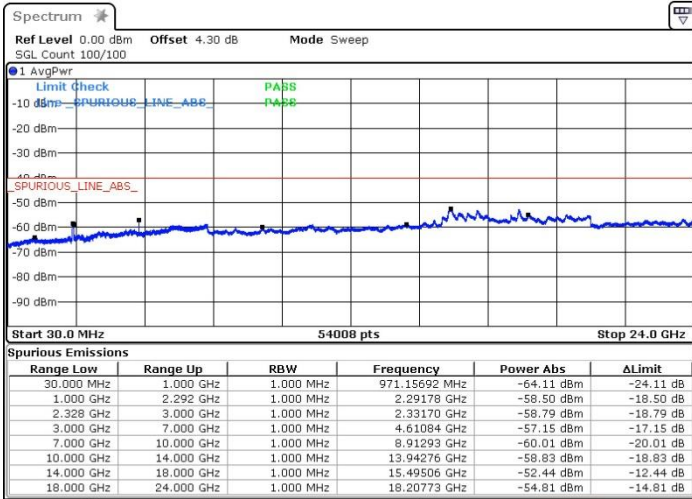

Date: 10.FEB.2021 23:04:16

Date: 10.FEB.2021 23:02:41

Highest Channel / 1RB

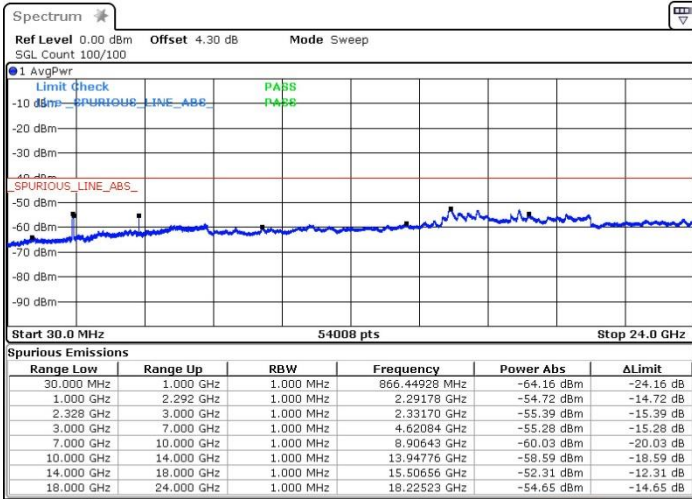

Date: 10.FEB.2021 23:09:47



FR1 n30 / 5MHz / DFT-S OFDM / QPSK

Lowest Channel / 1RB

Middle Channel / 1RB

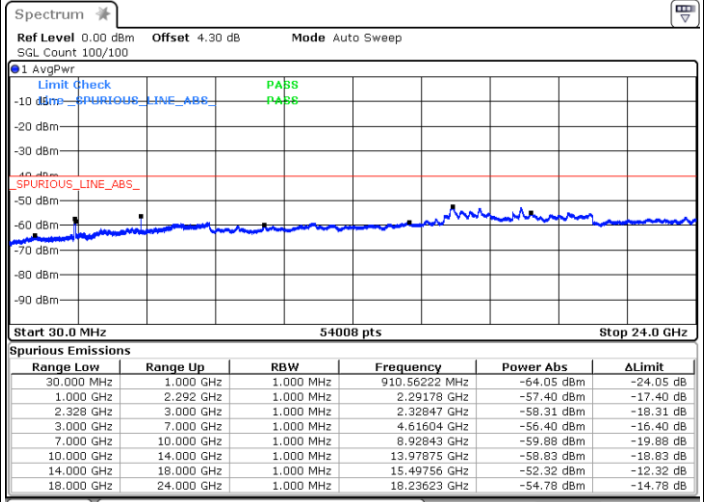
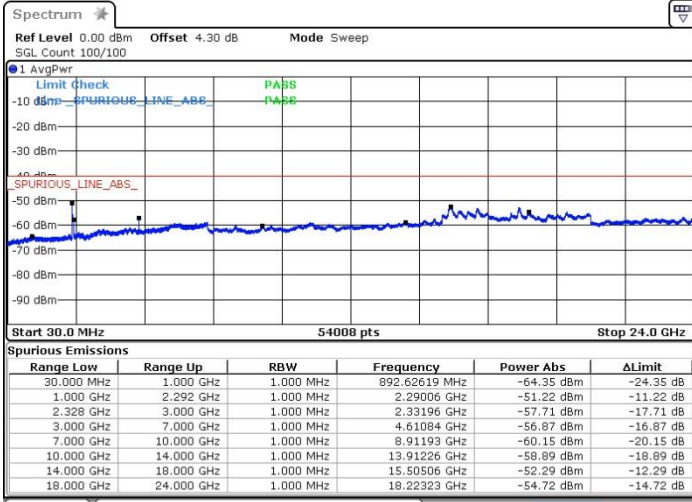

Date: 10.FEB.2021 23:06:57

Date: 10.FEB.2021 23:00:34

Highest Channel / 1RB

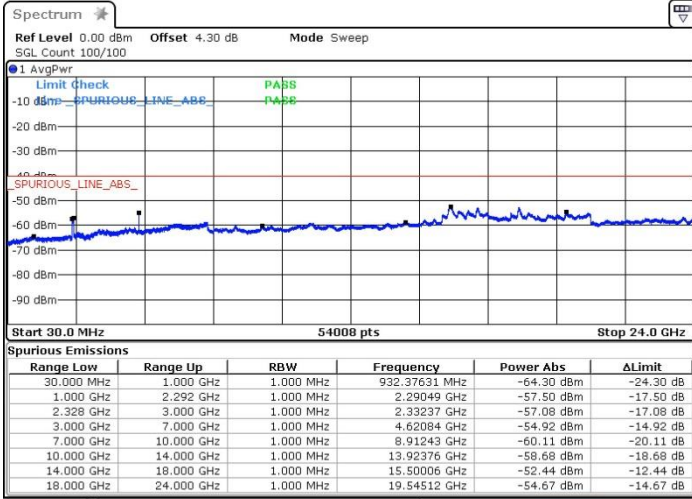

Date: 10.FEB.2021 23:08:43



FR1 n30 / 10MHz / DFT-S OFDM / BPSK

Middle Channel / 1RB

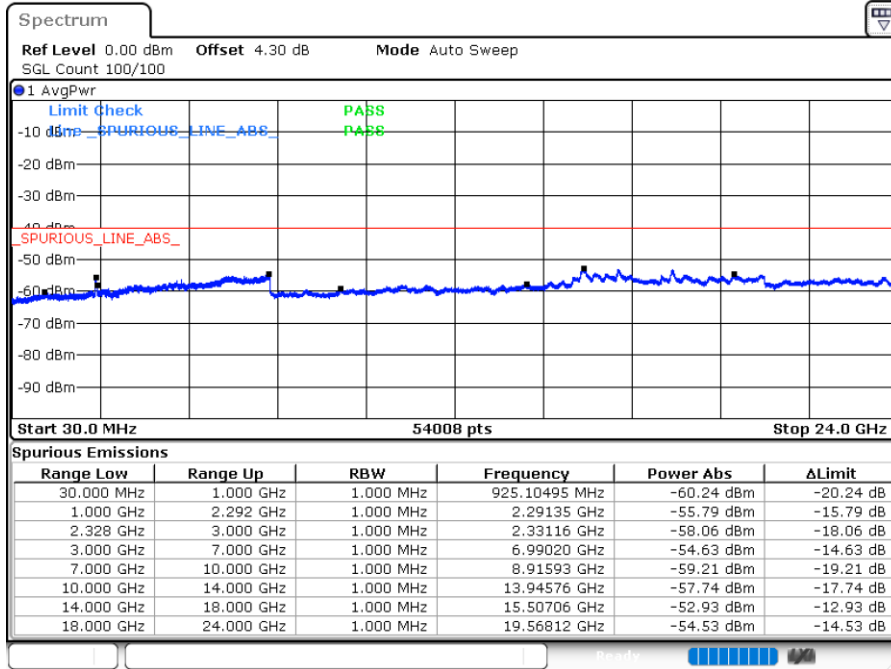

Date: 15 JAN 2021 06:21:06



FR1 n30 / 10MHz / DFT-S OFDM / QPSK

Middle Channel / 1RB

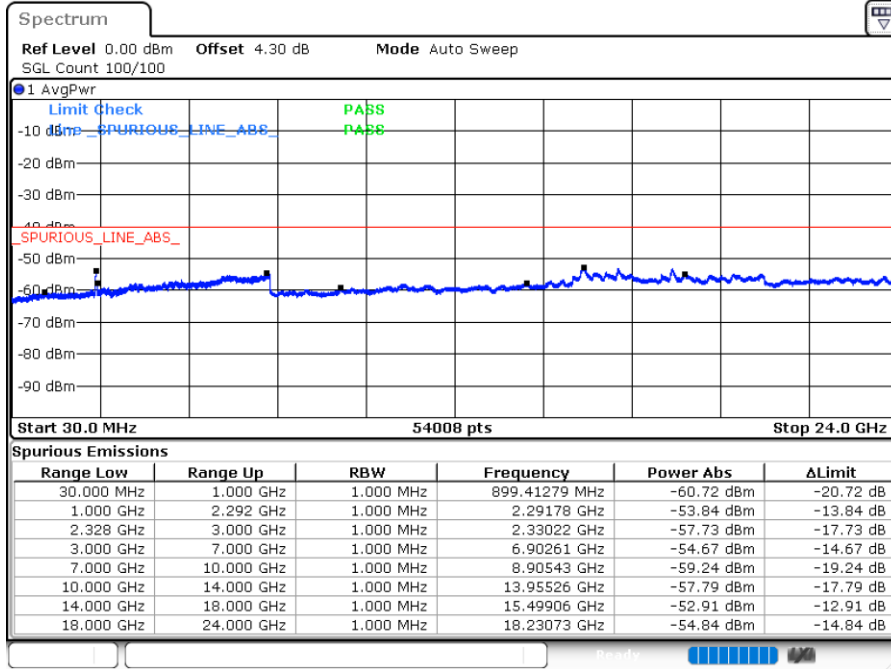

Date: 15 JAN 2021 06:19:17

Frequency Stability

Test Conditions		NR n30 (BPSK) / Middle Channel	Limit
Temperature (°C)	Voltage (Volt)	BW 10MHz	Within Band
		Deviation (ppm)	Result
50	Normal Voltage	0.0014	PASS
40	Normal Voltage	0.0017	
30	Normal Voltage	0.0012	
20(Ref.)	Normal Voltage	0.0013	
10	Normal Voltage	0.0013	
0	Normal Voltage	0.0012	
-10	Normal Voltage	0.0019	
-20	Normal Voltage	0.0015	
-30	Normal Voltage	0.0017	
20	Maximum Voltage	0.0019	
20	Normal Voltage	0.0013	
20	Battery End Point	0.0021	

Note:

1. Normal Voltage =3.3 V. ; Battery End Point (BEP) =3.14 V. ; Maximum Voltage =4.4 V.
2. Note: The frequency fundamental emissions stay within the authorized frequency block.

Appendix B. Test Results of Radiated Test

Radiated Spurious Emission

LTE Band 30 / 10MHz / QPSK / RB Size 1 Offset 0									
Channel	Frequency (MHz)	EIRP (dBm)	Limit (dBm)	Over Limit (dB)	SPA Reading (dBm)	S.G. Power (dBm)	TX Cable loss (dB)	TX Antenna Gain (dBi)	Polarization (H/V)
Middle	4611.60	-62.32	-40	-22.32	-55.11	-68.57	6.45	12.70	H
	6917.40	-59.53	-40	-19.53	-54.92	-62.93	8.40	11.80	H
	9223.20	-54.43	-40	-14.43	-55.51	-56.78	9.65	12.00	H
	4611.60	-62.59	-40	-22.59	-55.23	-68.84	6.45	12.70	V
	6917.40	-59.74	-40	-19.74	-55.1	-63.14	8.40	11.80	V
	9223.20	-54.85	-40	-14.85	-55.51	-57.20	9.65	12.00	V

Remark: Spurious emissions within 30-1000MHz were found more than 20dB below limit line.