

FCC Test Report (ENDC: n12+Band 2/66)

Report No.: RF200109E02B-11

FCC ID: 2AQ68T99W175

Test Model: T99W175

Received Date: Jan. 10, 2020

Test Date: Feb. 26 ~ May 18, 2020

Issued Date: May 26, 2020

Applicant: Hon Lin Technology Co., Ltd.

Address: 11F, No. 32, Jihu Rd., Neihu Dist., Taipei City 114, Taiwan R.O.C.

Issued By: Bureau Veritas Consumer Products Services (H.K.) Ltd., Taoyuan Branch
Lin Kou Laboratories

Lab Address: No. 47-2, 14th Ling, Chia Pau Vil., Lin Kou Dist., New Taipei City, Taiwan

Test Location: No.19, Hwa Ya 2nd Rd., Wen Hwa Vil., Kwei Shan Dist., Taoyuan City
33383, Taiwan

FCC Registration / 788550 / TW0003

Designation Number:



This report is for your exclusive use. Any copying or replication of this report to or for any other person or entity, or use of our name or trademark, is permitted only with our prior written permission. This report sets forth our findings solely with respect to the test samples identified herein. The results set forth in this report are not indicative or representative of the quality or characteristics of the lot from which a test sample was taken or any similar or identical product specifically and expressly noted. Our report includes all of the tests requested by you and the results thereof based upon the information that you provided to us. You have 60 days from date of issuance of this report to notify us of any material error or omission caused by our negligence, provided, however, that such notice shall be in writing and shall specifically address the issue you wish to raise. A failure to raise such issue within the prescribed time shall constitute your unqualified acceptance of the completeness of this report, the tests conducted and the correctness of the report contents. Unless specific mention, the uncertainty of measurement has been explicitly taken into account to declare the compliance or non-compliance to the specification. The report must not be used by the client to claim product certification, approval, or endorsement by TAF or any government agencies

Table of Contents

Release Control Record	4
1 Certificate of Conformity	5
2 Summary of Test Results	6
2.1 Measurement Uncertainty.....	7
2.2 Test Site and Instruments.....	8
3 General Information	9
3.1 General Description of EUT.....	9
3.2 Configuration of System under Test.....	14
3.2.1 Description of Support Units.....	14
3.3 Test Mode Applicability and Tested Channel Detail.....	15
3.4 EUT Operating Conditions.....	23
3.5 General Description of Applied Standards and References.....	23
4 Test Types and Results	24
4.1 Output Power Measurement.....	24
4.1.1 Limits of Output Power Measurement.....	24
4.1.2 Test Procedures.....	24
4.1.3 Test Setup.....	24
4.1.4 Test Results.....	25
4.2 Modulation Characteristics Measurement.....	39
4.2.1 Limits of Modulation Characteristics.....	39
4.2.2 Test Procedure.....	39
4.2.3 Test Setup.....	39
4.2.4 Test Results.....	40
4.3 Frequency Stability Measurement.....	41
4.3.1 Limits of Frequency Stability Measurement.....	41
4.3.2 Test Procedure.....	41
4.3.3 Test Setup.....	41
4.3.4 Test Results.....	42
4.4 Occupied Bandwidth Measurement.....	57
4.4.1 Test Procedure.....	57
4.4.2 Test Setup.....	57
4.4.3 Test Result.....	58
4.5 Band Edge Measurement.....	74
4.5.1 Limits of Band Edge Measurement.....	74
4.5.2 Test Setup.....	74
4.5.3 Test Procedures.....	74
4.5.4 Test Results.....	75
4.6 Peak to Average Ratio.....	90
4.6.1 Limits of Peak to Average Ratio Measurement.....	90
4.6.2 Test Setup.....	90
4.6.3 Test Procedures.....	90
4.6.4 Test Results.....	91
4.7 Conducted Spurious Emissions.....	99
4.7.1 Limits of Conducted Spurious Emissions Measurement.....	99
4.7.2 Test Setup.....	99
4.7.3 Test Procedure.....	99
4.7.4 Test Results.....	100
4.8 Radiated Emission Measurement.....	115
4.8.1 Limits of Radiated Emission Measurement.....	115
4.8.2 Test Procedure.....	115
4.8.3 Deviation from Test Standard.....	115
4.8.4 Test Setup.....	116
4.8.5 Test Results.....	117

5	Pictures of Test Arrangements.....	132
	Appendix – Information of the Testing Laboratories	133



Release Control Record

Issue No.	Description	Date Issued
RF200109E02B-11	Original release	May 26, 2020

1 Certificate of Conformity

Product: 5G WWAN Module

Brand: Foxconn

Test Model: T99W175

Sample Status: Engineering Sample

Applicant: Hon Lin Technology Co., Ltd.

Test Date: Feb. 26 ~ May 18, 2020

Standards: FCC Part 24, Subpart E
FCC Part 27, Subpart H, L

The above equipment has been tested by **Bureau Veritas Consumer Products Services (H.K.) Ltd., Taoyuan Branch**, and found compliance with the requirement of the above standards. The test record, data evaluation & Equipment Under Test (EUT) configurations represented herein are true and accurate accounts of the measurements of the sample's RF characteristics under the conditions specified in this report.

Prepared by : Pettie Chen , **Date:** May 26, 2020
Pettie Chen / Senior Specialist

Approved by : Bruce Chen , **Date:** May 26, 2020
Bruce Chen / Senior Project Engineer

2 Summary of Test Results

Applied Standard: FCC Part 24 & Part 2			
FCC Clause	Test Item	Result	Remarks
2.1046 24.232	Effective radiated power	Pass	Meet the requirement of limit.
2.1046 24.232(d)	Peak To Average Ratio	Pass	Meet the requirement of limit.
2.1055 24.235	Frequency Stability	Pass	Meet the requirement of limit.
2.1049 24.238(b)	Occupied Bandwidth	Pass	Meet the requirement of limit.
24.238(b)	Band Edge Measurements	Pass	Meet the requirement of limit.
2.1051 24.238	Conducted Spurious Emissions	Pass	Meet the requirement of limit.
2.1053 24.238	Radiated Spurious Emissions	Pass	Meet the requirement of limit. Minimum passing margin is -30.9dB at 168.71MHz.

Note: Determining compliance based on the results of the compliance measurement, not taking into account measurement instrumentation uncertainty.

Applied Standard: FCC Part 27 & Part 2				
FCC Clause		Test Item	Result	Remarks
n12	LTE Band 66			
2.1046 27.50 (d)(4)	2.1046 27.50 (d)(4)	Equivalent Isotropically Radiated Power / Equivalent Radiated Power	Pass	Meet the requirement of limit.
2.1047	-	Modulation Characteristics	Pass	Meet the requirement of limit.
27.50 (d)(5)	27.50 (d)(5)	Peak To Average Ratio	Pass	Meet the requirement of limit.
2.1055 27.54	2.1055 27.54	Frequency Stability Stay with the authorized bands of operation	Pass	Meet the requirement of limit.
2.1049	2.1049	Occupied Bandwidth	Pass	Meet the requirement of limit.
2.1051 27.53(h)	2.1051 27.53(h)	Band Edge Measurements	Pass	Meet the requirement of limit.
2.1051 27.53(h)	2.1051 27.53(h)	Conducted Spurious Emissions	Pass	Meet the requirement of limit.
2.1053 27.53(h)	2.1053 27.53(h)	Radiated Spurious Emissions	Pass	Meet the requirement of limit. Minimum passing margin is -28.0dB at 1415.00MHz.

Note: Determining compliance based on the results of the compliance measurement, not taking into account measurement instrumentation uncertainty.

2.1 Measurement Uncertainty

Where relevant, the following measurement uncertainty levels have been estimated for tests performed on the EUT as specified in CISPR 16-4-2:

Measurement	Frequency	Expanded Uncertainty (k=2) (\pm)
Radiated Emissions up to 1 GHz	9kHz ~ 30MHz	3.04 dB
	30MHz ~ 200MHz	3.63 dB
	200MHz ~ 1000MHz	3.64 dB
Radiated Emissions above 1 GHz	1GHz ~ 18GHz	2.29 dB
	18GHz ~ 40GHz	2.29 dB

2.2 Test Site and Instruments

Description & Manufacturer	Model No.	Serial No.	Cal. Date	Cal. Due
Test Receiver ROHDE & SCHWARZ	ESCI	100424	Dec. 31, 2019	Dec. 30, 2020
Spectrum Analyzer ROHDE & SCHWARZ	FSP40	100040	Sep. 23, 2019	Sep. 22, 2020
Spectrum Analyzer KEYSIGHT	N9030B	MY57140953	Jul. 03, 2019	Jul. 02, 2020
Radio Communication Analyzer Anritsu	MT8000A	6262012865	Dec. 12, 2019	Dec. 11, 2020
MXG Vector signal generator Agilent	N5182B	MY53050162	Jan. 14, 2020	Jan. 13, 2021
BILOG Antenna SCHWARZBECK	VULB9168	9168-158	Nov. 08, 2019	Nov. 07, 2020
BILOG Antenna SCHWARZBECK	VULB9168	9168-155	Nov. 11, 2019	Nov. 10, 2020
HORN Antenna SCHWARZBECK	BBHA 9120D	9120D-1170	Nov. 24, 2019	Nov. 23, 2020
HORN Antenna SCHWARZBECK	BBHA 9170	BBHA9170241	Nov. 24, 2019	Nov. 23, 2020
Loop Antenna TESEQ	HLA 6121	45745	Jul. 01, 2019	Jun. 30, 2020
Preamplifier Agilent (Below 1GHz)	8447D	2944A10631	Jul. 11, 2019	Jul. 10, 2020
Preamplifier KEYSIGHT (Above 1GHz)	83017A	MY53270295	Jun. 11, 2019	Jun. 10, 2020
RF Coaxial Cable WOKEN With 5dB PAD	8D-FB	Cable-CH4-01	Aug. 20, 2019	Aug. 19, 2020
RF Coaxial Cable EMCI	EMC102-KM-KM-3000	150929	Aug. 20, 2019	Aug. 19, 2020
RF Coaxial Cable EMCI	EMC102-KM-KM-600	150928	Aug. 20, 2019	Aug. 19, 2020
RF signal cable HUBER+SUHNER	SUCOFLEX 104	MY 13380+295012/04	Jul. 11, 2019	Jul. 10, 2020
RF signal cable HUBER+SUHNER	SUCOFLEX 104	Cable-CH4-03 (250724)	Jul. 11, 2019	Jul. 10, 2020
Software BV ADT	ADT_Radiated_V7.6.15.9.5	NA	NA	NA
Antenna Tower inn-co GmbH	MA 4000	010303	NA	NA
Antenna Tower Controller BV ADT	AT100	AT93021703	NA	NA
Boresight Antenna Fixture	FBA-01	FBA-SIP01	NA	NA
Standard Temperature And Humidity Chamber	MHU-225AU	920842	May 31, 2019	May 30, 2020
JFW 20dB attenuation	50HF-020-SMA	NA	NA	NA
True RMS Clamp Meter Fluke	325	31130711WS	May 21, 2019	May 20, 2020
DC power supply	U8002A	MY56330015	NA	NA

Note: 1. The calibration interval of the above test instruments is 12 months and the calibrations are traceable to NML/ROC and NIST/USA.

2. The test was performed in HwaYa Chamber 4.

3 General Information

3.1 General Description of EUT

Product	5G WWAN Module
Brand	Foxconn
Test Model	T99W175
Sample Status	Engineering Sample
Power Supply Rating	5 Vdc (Host equipment) 3.135Vdc~3.63Vdc (Module)

n12

Modulation Type	$\pi/2$ BPSK, QPSK, 16QAM, 64QAM, 256QAM					
Waveform Type	CP-OFDM, DFT-s-OFDM					
Operating Frequency	n12 (Channel Bandwidth 5MHz)	701.5MHz ~ 713.5MHz				
	n12 (Channel Bandwidth 10MHz)	704.0MHz ~ 711.0MHz				
	n12 (Channel Bandwidth 15MHz)	706.5MHz ~ 708.5MHz				
Max. ERP Power		$\pi/2$ BPSK	QPSK	16QAM	64QAM	256QAM
	n12 (Channel Bandwidth 5MHz)	359.749mW (25.56dBm)	342.768mW (25.35dBm)	331.894mW (25.21dBm)	313.329mW (24.96dBm)	178.238mW (22.51dBm)
	n12 (Channel Bandwidth 10MHz)	353.183mW (25.48dBm)	342.768mW (25.35dBm)	335.738mW (25.26dBm)	309.030mW (24.90dBm)	180.302mW (22.56dBm)
	n12 (Channel Bandwidth 15MHz)	349.140mW (25.43dBm)	343.558mW (25.36dBm)	334.965mW (25.25dBm)	309.742mW (24.91dBm)	174.582mW (22.42dBm)
Emission Designator		$\pi/2$ BPSK	QPSK	16QAM	64QAM	256QAM
	n12 (Channel Bandwidth 5MHz)	4M49G7D	4M49G7D	4M49D7W	4M49D7W	4M49D7W
	n12 (Channel Bandwidth 10MHz)	8M96G7D	8M96G7D	8M96D7W	8M95D7W	8M96D7W
	n12 (Channel Bandwidth 15MHz)	13M5G7D	13M5G7D	13M4D7W	13M4D7W	13M4D7W

LTE Band

Modulation Type	QPSK, 16QAM, 64QAM, 256QAM					
Operating Frequency	LTE Band 2	Channel Bandwidth 1.4MHz	1850.7MHz ~1909.3MHz			
		Channel Bandwidth 3MHz	1851.5MHz ~1908.5MHz			
		Channel Bandwidth 5MHz	1852.5MHz ~1907.5MHz			
		Channel Bandwidth 10MHz	1855.0MHz ~1905.0MHz			
		Channel Bandwidth 15MHz	1857.5MHz ~1902.5MHz			
		Channel Bandwidth 20MHz	1860.0MHz ~1900.0MHz			
	LTE Band 66	Channel Bandwidth 1.4MHz	1710.7MHz ~ 1779.3MHz			
		Channel Bandwidth 3MHz	1711.5MHz ~ 1778.5MHz			
		Channel Bandwidth 5MHz	1712.5MHz ~ 1777.5MHz			
		Channel Bandwidth 10MHz	1715.0MHz ~ 1775.0MHz			
		Channel Bandwidth 15MHz	1717.5MHz ~ 1772.5MHz			
		Channel Bandwidth 20MHz	1720.0MHz ~ 1770.0MHz			
Max. EIRP Power	LTE Band 2		QPSK	16QAM	64QAM	256QAM
		Channel Bandwidth 1.4MHz	583.445mW (27.66dBm)	464.515mW (26.67dBm)	366.438mW (25.64dBm)	282.488mW (24.51dBm)
		Channel Bandwidth 3MHz	580.764mW (27.64dBm)	464.515mW (26.67dBm)	366.438mW (25.64dBm)	281.190mW (24.49dBm)
		Channel Bandwidth 5MHz	570.164mW (27.56dBm)	448.745mW (26.52dBm)	368.978mW (25.67dBm)	283.139mW (24.52dBm)
		Channel Bandwidth 10MHz	583.445mW (27.66dBm)	456.037mW (26.59dBm)	365.595mW (25.63dBm)	295.801mW (24.71dBm)
		Channel Bandwidth 15MHz	575.440mW (27.60dBm)	463.447mW (26.66dBm)	365.595mW (25.63dBm)	297.167mW (24.73dBm)
		Channel Bandwidth 20MHz	582.103mW (27.65dBm)	462.381mW (26.65dBm)	367.282mW (25.65dBm)	297.852mW (24.74dBm)
	LTE Band 66	Channel Bandwidth 1.4MHz	547.016mW (27.38dBm)	438.531mW (26.42dBm)	351.560mW (25.46dBm)	274.789mW (24.39dBm)
		Channel Bandwidth 3MHz	558.470mW (27.47dBm)	472.063mW (26.74dBm)	352.371mW (25.47dBm)	279.898mW (24.47dBm)
		Channel Bandwidth 5MHz	543.250mW (27.35dBm)	441.570mW (26.45dBm)	350.752mW (25.45dBm)	283.792mW (24.53dBm)
		Channel Bandwidth 10MHz	545.758mW (27.37dBm)	442.588mW (26.46dBm)	350.752mW (25.45dBm)	275.423mW (24.40dBm)
		Channel Bandwidth 15MHz	557.186mW (27.46dBm)	442.588mW (26.46dBm)	349.945mW (25.44dBm)	278.612mW (24.45dBm)
		Channel Bandwidth 20MHz	555.904mW (27.45dBm)	443.609mW (26.47dBm)	345.144mW (25.38dBm)	279.254mW (24.46dBm)
			QPSK	16QAM	64QAM	256QAM
Emission Designator	LTE Band 2	Channel Bandwidth 1.4MHz	1M09G7D	1M09D7W	1M09D7W	1M09D7W
		Channel Bandwidth 3MHz	2M70G7D	2M70D7W	2M70D7W	2M70D7W
		Channel Bandwidth 5MHz	4M49G7D	4M49D7W	4M50D7W	4M49D7W
		Channel Bandwidth 10MHz	8M96G7D	8M97D7W	8M97D7W	8M96D7W
		Channel Bandwidth 15MHz	13M5G7D	13M5D7W	13M5D7W	13M5D7W
		Channel Bandwidth 20MHz	18M0G7D	18M0D7W	18M0D7W	18M0D7W
	LTE Band 66	Channel Bandwidth 1.4MHz	1M09G7D	1M09D7W	1M09D7W	1M09D7W
		Channel Bandwidth 3MHz	2M70G7D	2M70D7W	2M70D7W	2M70D7W
		Channel Bandwidth 5MHz	4M49G7D	4M49D7W	4M50D7W	4M49D7W
		Channel Bandwidth 10MHz	8M96G7D	8M97D7W	8M97D7W	8M97D7W
		Channel Bandwidth 15MHz	13M5G7D	13M5D7W	13M5D7W	13M5D7W
		Channel Bandwidth 20MHz	18M0G7D	18M0D7W	18M0D7W	18M0D7W

Antenna Type	Refer to Note as below
Antenna Connector	Refer to Note as below
Accessory Device	NA
Cable Supplied	NA

Output Power / Emission Designator	n12+LTE Band 2		MAX EIRP / ERP	Sum Bandwidth
		n12 (ERP)	359.749mW (25.56dBm)	22M4D7W
LTE Band 2 (EIRP)	297.852mW (24.74dBm)			
		EIRP / ERP	MAX Sum Bandwidth	
n12 (ERP)	332.660mW (25.22dBm)	31M4D7W		
LTE Band 2 (EIRP)	283.792mW (24.53dBm)			
		MAX EIRP / ERP	Sum Bandwidth	
n12 (ERP)	359.749mW (25.56dBm)	4M48D7W		
LTE Band 66 (EIRP)	283.792mW (24.53dBm)			
		EIRP / ERP	MAX Sum Bandwidth	
n12 (ERP)	332.660mW (25.22dBm)	31M4D7W		
LTE Band 66 (EIRP)	261.818mW (24.18dBm)			

Note:

1. This report is prepared for FCC class II permissive change. This report is issued as a supplementary report of BV CPS report no.: RF200109E02-12. Difference compared with the original report is adding Modulation Type 256QAM by software. In this software changed, will not impact the 5G NR characteristic, therefore all test results are keeping as original report stated. Therefore, the EUT was tested all tests for 256QAM and presented in the test report.
2. There are four Difference HW of T99W175.

Brand	Model	HW
Foxconn	T99W175	1. 3G+LTE+Sub6+eSIM
		2. 3G+LTE+Sub6 only w/o eSIM
		3. 3G+LTE+Sub6+eSIM+GNSS connector
		4. 3G+LTE+Sub6 only+w/o eSIM+GNSS connector

*After pre-testing, "HW: 1. 3G+LTE+Sub6+eSIM" is the worst for the final tests.

3. After pre-testing, "DFT-s-OFDM" is the worst for the final tests.

4. The following antennas were provided to the EUT.

Antenna No.	RF Chain No.	Brand	Model	Antenna Net Gain(dBi)	Frequency range (MHz)	Antenna Type	Connector Type
1		WHA YU	C107-511720-A	4.41	660~803	PCB	I-PEX
2		WHA YU	C107-511721-A	3.81 4.03	791~960 1447.9~1606	PCB	I-PEX
3		WHA YU	C107-511722-A	4.27 5.31	1710~2170 2500~2690	PCB	I-PEX
4		WHA YU	C107-511723-A	2.99 0.92	2300~2400 3500~3700	PCB	I-PEX
5		WHA YU	C107-511724-A	6.45	5150~5925	PCB	I-PEX
6		WHA YU	C107-511725-A	4.89	3400~3700	PCB	I-PEX
7		AVX	5000106-R1-X01	2.91	699~803	Monopole	I-PEX
8		AVX	5000107-R1-X01	2.59	791~960	Monopole	I-PEX
9		AVX	5000108-R1-X01	2.85	1427~1610	Monopole	I-PEX
10		AVX	5000109-R1-X01	2.23 2.94	1710~2200 5150~5925	Monopole	I-PEX
11		AVX	5000110-R1-X01	0.9	2300~2690	Monopole	I-PEX
12		AVX	5000111-R1-X01	0.87	3300~5000	Monopole	I-PEX
13	Tx1/ Rx1	Ethertronics	5003806	0.4 -1.61 0.39 2.95 1.98 0.38 0.83 2.31	698-821 824-960 1425-1515 1710-2200 2300-2690 3300-4200 4400-5000 5150-5925	PIFA	I-PEX
	Rx2	Ethertronics	5003807	-2.24 -4.52 2.87 2.99 2.93 2.91 2.23 -0.85 -3.04	716-821 824-960 1425-1515 1557-1610 1805-2200 2300-2690 3300-4200 4400-5000 5150-5925	PIFA	I-PEX
	Tx2/ Rx3	Ethertronics	5003806	2.21 2.25 -0.45 2.6	1710-2200 2300-2690 3300-4200 4400-5000	PIFA	I-PEX
	Rx4	Ethertronics	5003700	1.38 2.87 0.6 -2.09	1805-2200 2300-2690 3300-4200 4400-5000	PIFA	I-PEX

Antenna No.	RF Chain No.	Brand	Model	Antenna Net Gain(dBi)	Frequency range (MHz)	Antenna Type	Connector Type
14	Ant. 0 (TX/RX)	Master Wave	NA	2.4 2.2 2.9 2.9 2.9 NA	880~960 1020~2170 2545~2595 3565~3600 3900~4000 GPS	PCB	I-PEX
	Ant. 2 (TX/RX)	Master Wave	NA	NA 2.2 2.8 2.9 2.8 NA	880~960 1020~2170 2545~2595 3565~3600 3900~4000 GPS	PCB	I-PEX
	Ant. 1 (RX)	Master Wave	NA	NA 5.3 5.1 4.3 4.5 NA	880~960 1020~2170 2545~2595 3565~3600 3900~4000 GPS	PCB	I-PEX
	Ant. 3 (RX)	Master Wave	NA	1.3 6.8 3.7 6.4 6.2 3.7	880~960 1020~2170 2545~2595 3565~3600 3900~4000 GPS	PCB	I-PEX

*The antenna for the final tests as following table.

	Band	Antenna
5G NR	12 (15kHz) /5/10/15	Antenna 1

	Band	Antenna
LTE	2	Antenna 3
	66	Antenna 3

5. The EUT supports the following ENDC configuration.

5G NR	FCC 5G FR1			ENDC
	Band	SCS	Bandwidth (MHz)	
	n2	15kHz	5/10/15/20	Band 5/12/13/30/48/66
	n5	15kHz	5/10/15/20	Band 2/7/12/48/66
	n7	15kHz	5/10/15/20	Band 5/12
	n12	15kHz	5/10/15	Band 2/66
	n41	30kHz	20/40/50/60/80/90/100	Band 2/25/26/66/41
	n66	15kHz	5/10/15/20	Band 5/12/13/30/48/71
	n71	15kHz	5/10/15/20	Band 2/7/66

3.2 Configuration of System under Test

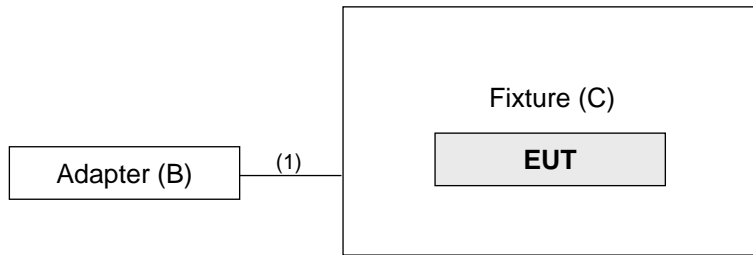

3.2.1 Description of Support Units

The EUT has been tested as an independent unit together with other necessary accessories or support units. The following support units or accessories were used to form a representative test configuration during the tests.

ID	Product	Brand	Model No.	Serial No.	FCC ID	Remarks
A.	Radio Communication Analyzer	Anritsu	MT8821C	6261806803	NA	-
B.	Adapter	LITEON	PA-1050-39	NA	NA	-
C.	Fixture	NA	NA	NA	NA	Provided by client.

Note:

1. All power cords of the above support units are non-shielded (1.8m).
2. Item A acted as a communication partner to transfer data.

ID	Descriptions	Qty.	Length (m)	Shielding (Yes/No)	Cores (Qty.)	Remarks
1.	USB cable	1	1.5	Y	0	-

3.3 Test Mode Applicability and Tested Channel Detail

Pre-Scan has been conducted to determine the worst-case mode from all possible combinations between available modulations, data rates, XYZ axis and antenna ports. The worst case was found when positioned on Z-plane. Following channel(s) was (were) selected for the final test as listed below.

n12

EUT Configure Mode	Test item	Available channel	Tested channel	Channel Bandwidth	Modulation	Mode
-	ERP	140300 to 142700	140300(701.5MHz), 141500(707.5MHz), 142700(713.5MHz)	5MHz	$\pi/2$ BPSK / QPSK / 16QAM / 64QAM / 256QAM	1 RB / 0 RB Offset 1 RB / 12 RB Offset 1 RB / 24 RB Offset 12 RB / 0 RB Offset 12 RB / 6 RB Offset 12 RB / 13 RB Offset 25 RB / 0 RB Offset
		140800 to 142200	140800(704.0MHz), 141500(707.5MHz), 142200(711.0MHz)	10MHz	$\pi/2$ BPSK / QPSK / 16QAM / 64QAM / 256QAM	1 RB / 0 RB Offset 1 RB / 24 RB Offset 1 RB / 49 RB Offset 25 RB / 0 RB Offset 25 RB / 12 RB Offset 25 RB / 25 RB Offset 50 RB / 0 RB Offset
		141300 to 141700	141300(706.5MHz), 141500(707.5MHz), 141700(708.5MHz)	15MHz	$\pi/2$ BPSK / QPSK / 16QAM / 64QAM / 256QAM	1 RB / 0 RB Offset 1 RB / 37 RB Offset 1 RB / 74 RB Offset 36 RB / 0 RB Offset 36 RB / 19 RB Offset 36 RB / 39 RB Offset 75 RB / 0 RB Offset
-	Modulation Characteristics	141300 to 141700	141500(707.5MHz)	15MHz	$\pi/2$ BPSK / QPSK / 16QAM / 64QAM / 256QAM	79 RB / 0 RB Offset
-	Frequency Stability	140300 to 142700	140300(701.5MHz), 142700(713.5MHz)	5MHz	$\pi/2$ BPSK	25 RB / 0 RB Offset
		140800 to 142200	140800(704.0MHz), 142200(711.0MHz)	10MHz	$\pi/2$ BPSK	52 RB / 0 RB Offset
		141300 to 141700	141300(706.5MHz), 141700(708.5MHz)	15MHz	$\pi/2$ BPSK	79 RB / 0 RB Offset
-	Emission Bandwidth	140300 to 142700	140300(701.5MHz), 141500(707.5MHz), 142700(713.5MHz)	5MHz	$\pi/2$ BPSK / QPSK / 16QAM / 64QAM / 256QAM	25 RB / 0 RB Offset
		140800 to 142200	140800(704.0MHz), 141500(707.5MHz), 142200(711.0MHz)	10MHz	$\pi/2$ BPSK / QPSK / 16QAM / 64QAM / 256QAM	52 RB / 0 RB Offset
		141300 to 141700	141300(706.5MHz), 141500(707.5MHz), 141700(708.5MHz)	15MHz	$\pi/2$ BPSK / QPSK / 16QAM / 64QAM / 256QAM	79 RB / 0 RB Offset
-	Band Edge	140300 to 142700	140300(701.5MHz), 142700(713.5MHz)	5MHz	$\pi/2$ BPSK	1 RB / 0 RB Offset 1 RB / 24 RB Offset 25 RB / 0 RB Offset
		140800 to 142200	140800(704.0MHz), 142200(711.0MHz)	10MHz	$\pi/2$ BPSK	1 RB / 0 RB Offset 1 RB / 51 RB Offset 52 RB / 0 RB Offset
		141300 to 141700	141300(706.5MHz), 141700(708.5MHz)	15MHz	$\pi/2$ BPSK	1 RB / 0 RB Offset 1 RB / 78 RB Offset 79 RB / 0 RB Offset

EUT Configure Mode	Test item	Available channel	Tested channel	Channel Bandwidth	Modulation	Mode
-	Peak to Average Ratio	140300 to 142700	140300(701.5MHz), 141500(707.5MHz), 142700(713.5MHz)	5MHz	$\pi/2$ BPSK / QPSK / 16QAM / 64QAM / 256QAM	1 RB / 0 RB Offset
		140800 to 142200	140800(704.0MHz), 141500(707.5MHz), 142200(711.0MHz)	10MHz	$\pi/2$ BPSK / QPSK / 16QAM / 64QAM / 256QAM	1 RB / 0 RB Offset
		141300 to 141700	141300(706.5MHz), 141500(707.5MHz), 141700(708.5MHz)	15MHz	$\pi/2$ BPSK / QPSK / 16QAM / 64QAM / 256QAM	1 RB / 0 RB Offset
-	Conducted Emission	140300 to 142700	140300(701.5MHz), 141500(707.5MHz), 142700(713.5MHz)	5MHz	$\pi/2$ BPSK	1 RB / 0 RB Offset
		140800 to 142200	140800(704.0MHz), 141500(707.5MHz), 142200(711.0MHz)	10MHz	$\pi/2$ BPSK	1 RB / 0 RB Offset
		141300 to 141700	141300(706.5MHz), 141500(707.5MHz), 141700(708.5MHz)	15MHz	$\pi/2$ BPSK	1 RB / 0 RB Offset
-	Radiated Emission Below 1GHz	140300 to 142700	142700(713.5MHz)	5MHz	$\pi/2$ BPSK	1 RB / 0 RB Offset
-	Radiated Emission Above 1GHz	140300 to 142700	140300(701.5MHz), 141500(707.5MHz), 142700(713.5MHz)	5MHz	$\pi/2$ BPSK	1 RB / 0 RB Offset
		140800 to 142200	140800(704.0MHz), 141500(707.5MHz), 142200(711.0MHz)	10MHz	$\pi/2$ BPSK	1 RB / 0 RB Offset
		141300 to 141700	141300(706.5MHz), 141500(707.5MHz), 141700(708.5MHz)	15MHz	$\pi/2$ BPSK	1 RB / 0 RB Offset

Note: The conducted output power for $\pi/2$ BPSK, QPSK, 16QAM, 64QAM and 256QAM, measured value of $\pi/2$ BPSK is higher than QPSK, 16QAM, 64QAM and 256QAM mode. Therefore, only ERP, Modulation characteristics, occupied bandwidth and Peak to average ratio items had been tested under $\pi/2$ BPSK, QPSK, 16QAM, 64QAM and 256QAM modes, the other test items were performed under $\pi/2$ BPSK mode only.

LTE Band 2

EUT Configure Mode	Test item	Available channel	Tested Channel	Channel Bandwidth	Modulation	Mode
-	EIRP	18607 to 19193	18607 (1850.70MHz), 18900 (1880.00MHz), 19193 (1909.30MHz)	1.4MHz	256QAM	1 RB / 0 RB Offset 1 RB / 2 RB Offset 1 RB / 5 RB Offset 3 RB / 0 RB Offset 3 RB / 1 RB Offset 3 RB / 3 RB Offset 6 RB / 0 RB Offset
		18615 to 19185	18615 (1851.50MHz), 18900 (1880.00MHz), 19185 (1908.50MHz)	3MHz	256QAM	1 RB / 0 RB Offset 1 RB / 7 RB Offset 1 RB / 14 RB Offset 8 RB / 0 RB Offset 8 RB / 3 RB Offset 8 RB / 7 RB Offset 15 RB / 0 RB Offset
		18625 to 19175	18625 (1852.50MHz), 18900 (1880.00MHz), 19175 (1907.50MHz)	5MHz	256QAM	1 RB / 0 RB Offset 1 RB / 12 RB Offset 1 RB / 24 RB Offset 12 RB / 0 RB Offset 12 RB / 6 RB Offset 12 RB / 13 RB Offset 25 RB / 0 RB Offset
		18650 to 19150	18650 (1855.00MHz), 18900 (1880.00MHz), 19150 (1905.00MHz)	10MHz	256QAM	1 RB / 0 RB Offset 1 RB / 24 RB Offset 1 RB / 49 RB Offset 25 RB / 0 RB Offset 25 RB / 12 RB Offset 25 RB / 25 RB Offset 50 RB / 0 RB Offset
		18675 to 19125	18675 (1857.50MHz), 18900 (1880.00MHz), 19125 (1902.50MHz)	15MHz	256QAM	1 RB / 0 RB Offset 1 RB / 37 RB Offset 1 RB / 74 RB Offset 36 RB / 0 RB Offset 36 RB / 19 RB Offset 36 RB / 39 RB Offset 75 RB / 0 RB Offset
		18700 to 19100	18700 (1860.00MHz), 18900 (1880.00MHz), 19100 (1900.00MHz)	20MHz	256QAM	1 RB / 0 RB Offset 1 RB / 50 RB Offset 1 RB / 99 RB Offset 50 RB / 0 RB Offset 50 RB / 25 RB Offset 50 RB / 50 RB Offset 100 RB / 0 RB Offset
-	Frequency Stability	18607 to 19193	18607 (1850.70MHz), 19193 (1909.30MHz)	1.4MHz	256QAM	5 RB / 0 RB Offset
		18615 to 19185	18615 (1851.50MHz), 19185 (1908.50MHz)	3MHz	256QAM	15 RB / 0 RB Offset
		18625 to 19175	18625 (1852.50MHz), 19175 (1907.50MHz)	5MHz	256QAM	25 RB / 0 RB Offset
		18650 to 19150	18650 (1855.00MHz), 19150 (1905.00MHz)	10MHz	256QAM	50 RB / 0 RB Offset
		18675 to 19125	18675 (1857.50MHz), 19125 (1902.50MHz)	15MHz	256QAM	75 RB / 0 RB Offset
		18700 to 19100	18700 (1860.00MHz), 19100 (1900.00MHz)	20MHz	256QAM	100 RB / 0 RB Offset

EUT Configure Mode	Test item	Available channel	Tested Channel	Channel Bandwidth	Modulation	Mode
-	Occupied Bandwidth	18607 to 19193	18607 (1850.70MHz), 18900 (1880.00MHz), 19193 (1909.30MHz)	1.4MHz	256QAM	5 RB / 0 RB Offset
		18615 to 19185	18615 (1851.50MHz), 18900 (1880.00MHz), 19185 (1908.50MHz)	3MHz	256QAM	15 RB / 0 RB Offset
		18625 to 19175	18625 (1852.50MHz), 18900 (1880.00MHz), 19175 (1907.50MHz)	5MHz	256QAM	25 RB / 0 RB Offset
		18650 to 19150	18650 (1855.00MHz), 18900 (1880.00MHz), 19150 (1905.00MHz)	10MHz	256QAM	50 RB / 0 RB Offset
		18675 to 19125	18675 (1857.50MHz), 18900 (1880.00MHz), 19125 (1902.50MHz)	15MHz	256QAM	75 RB / 0 RB Offset
		18700 to 19100	18700 (1860.00MHz), 18900 (1880.00MHz), 19100 (1900.00MHz)	20MHz	256QAM	100 RB / 0 RB Offset
-	Band Edge	18607 to 19193	18607 (1850.70MHz), 19193 (1909.30MHz)	1.4MHz	256QAM	1 RB / 0 RB Offset 1 RB / 5 RB Offset 6 RB / 0 RB Offset
		18615 to 19185	18615 (1851.50MHz), 19185 (1908.50MHz)	3MHz	256QAM	1 RB / 0 RB Offset 1 RB / 14 RB Offset 15 RB / 0 RB Offset
		18625 to 19175	18625 (1852.50MHz), 19175 (1907.50MHz)	5MHz	256QAM	1 RB / 0 RB Offset 1 RB / 24 RB Offset 25 RB / 0 RB Offset
		18650 to 19150	18650 (1855.00MHz), 19150 (1905.00MHz)	10MHz	256QAM	1 RB / 0 RB Offset 1 RB / 49 RB Offset 50 RB / 0 RB Offset
		18675 to 19125	18675 (1857.50MHz), 19125 (1902.50MHz)	15MHz	256QAM	1 RB / 0 RB Offset 1 RB / 74 RB Offset 75 RB / 0 RB Offset
		18700 to 19100	18700 (1860.00MHz), 19100 (1900.00MHz)	20MHz	256QAM	1 RB / 0 RB Offset 1 RB / 99 RB Offset 100 RB / 0 RB Offset
-	Peak to Average Ratio	18607 to 19193	18607 (1850.70MHz), 18900 (1880.00MHz), 19193 (1909.30MHz)	1.4MHz	256QAM	1 RB / 0 RB Offset
		18615 to 19185	18615 (1851.50MHz), 18900 (1880.00MHz), 19185 (1908.50MHz)	3MHz	256QAM	1 RB / 0 RB Offset
		18625 to 19175	18625 (1852.50MHz), 18900 (1880.00MHz), 19175 (1907.50MHz)	5MHz	256QAM	1 RB / 0 RB Offset
		18650 to 19150	18650 (1855.00MHz), 18900 (1880.00MHz), 19150 (1905.00MHz)	10MHz	256QAM	1 RB / 0 RB Offset
		18675 to 19125	18675 (1857.50MHz), 18900 (1880.00MHz), 19125 (1902.50MHz)	15MHz	256QAM	1 RB / 0 RB Offset
		18700 to 19100	18700 (1860.00MHz), 18900 (1880.00MHz), 19100 (1900.00MHz)	20MHz	256QAM	1 RB / 0 RB Offset

EUT Configure Mode	Test item	Available channel	Tested Channel	Channel Bandwidth	Modulation	Mode
-	Conducted Emission	18607 to 19193	18607 (1850.70MHz), 18900 (1880.00MHz), 19193 (1909.30MHz)	1.4MHz	256QAM	1 RB / 0 RB Offset
		18615 to 19185	18615 (1851.50MHz), 18900 (1880.00MHz), 19185 (1908.50MHz)	3MHz	256QAM	1 RB / 0 RB Offset
		18625 to 19175	18625 (1852.50MHz), 18900 (1880.00MHz), 19175 (1907.50MHz)	5MHz	256QAM	1 RB / 0 RB Offset
		18650 to 19150	18650 (1855.00MHz), 18900 (1880.00MHz), 19150 (1905.00MHz)	10MHz	256QAM	1 RB / 0 RB Offset
		18675 to 19125	18675 (1857.50MHz), 18900 (1880.00MHz), 19125 (1902.50MHz)	15MHz	256QAM	1 RB / 0 RB Offset
		18700 to 19100	18700 (1860.00MHz), 18900 (1880.00MHz), 19100 (1900.00MHz)	20MHz	256QAM	1 RB / 0 RB Offset
-	Radiated Emission Below 1GHz	18700 to 19100	18900 (1880.00MHz)	20MHz	256QAM	1 RB / 0 RB Offset
-	Radiated Emission Above 1GHz	18607 to 19193	18607 (1850.70MHz), 18900 (1880.00MHz), 19193 (1909.30MHz)	1.4MHz	256QAM	1 RB / 0 RB Offset
		18625 to 19175	18625 (1852.50MHz), 18900 (1880.00MHz), 19175 (1907.50MHz)	5MHz	256QAM	1 RB / 0 RB Offset
		18700 to 19100	18700 (1860.00MHz), 18900 (1880.00MHz), 19100 (1900.00MHz)	20MHz	256QAM	1 RB / 0 RB Offset

Note: For radiated emission above 1GHz, according to 3GPP 36.521 Section 6.6.3.1.4, choose the lowest, 5MHz & highest channel bandwidth for final test.

LTE Band 66

EUT Configure Mode	Test Item	Available Channel	Tested Channel	Channel Bandwidth	Modulation	Mode
-	EIRP	131979 to 132665	131979 (1710.7MHz), 132322 (1745.0MHz), 132665 (1779.3MHz)	1.4MHz	256QAM	1 RB / 0 RB Offset 1 RB / 2 RB Offset 1 RB / 5 RB Offset 3 RB / 0 RB Offset 3 RB / 1 RB Offset 3 RB / 3 RB Offset 6 RB / 0 RB Offset
		131987 to 132657	131987 (1711.5MHz), 132322 (1745.0MHz), 132657 (1778.5MHz)	3MHz	256QAM	1 RB / 0 RB Offset 1 RB / 7 RB Offset 1 RB / 14 RB Offset 8 RB / 0 RB Offset 8 RB / 3 RB Offset 8 RB / 7 RB Offset 15 RB / 0 RB Offset
		131997 to 132647	131997 (1712.5MHz), 132322 (1745.0MHz), 132647 (1777.5MHz)	5MHz	256QAM	1 RB / 0 RB Offset 1 RB / 12 RB Offset 1 RB / 24 RB Offset 12 RB / 0 RB Offset 12 RB / 6 RB Offset 12 RB / 13 RB Offset 25 RB / 0 RB Offset
		132022 to 132622	132022 (1715.0MHz), 132322 (1745.0MHz), 132622 (1775.0MHz)	10MHz	256QAM	1 RB / 0 RB Offset 1 RB / 24 RB Offset 1 RB / 49 RB Offset 25 RB / 0 RB Offset 25 RB / 12 RB Offset 25 RB / 25 RB Offset 50 RB / 0 RB Offset
		132047 to 132597	132047 (1717.5MHz), 132322 (1745.0MHz), 132597 (1772.5MHz)	15MHz	256QAM	1 RB / 0 RB Offset 1 RB / 37 RB Offset 1 RB / 74 RB Offset 36 RB / 0 RB Offset 36 RB / 19 RB Offset 36 RB / 39 RB Offset 75 RB / 0 RB Offset
		132072 to 132572	132072 (1720.0MHz), 132322 (1745.0MHz), 132572 (1770.0MHz)	20MHz	256QAM	1 RB / 0 RB Offset 1 RB / 50 RB Offset 1 RB / 99 RB Offset 50 RB / 0 RB Offset 50 RB / 25 RB Offset 50 RB / 50 RB Offset 100 RB / 0 RB Offset
-	Frequency Stability	131979 to 132665	131979 (1710.7MHz), 132665 (1779.3MHz)	1.4MHz	256QAM	6 RB / 0 RB Offset
		131987 to 132657	131987 (1711.5MHz), 132657 (1778.5MHz)	3MHz	256QAM	15 RB / 0 RB Offset
		131997 to 132647	131997 (1712.5MHz), 132647 (1777.5MHz)	5MHz	256QAM	25 RB / 0 RB Offset
		132022 to 132622	132022 (1715.0MHz), 132622 (1775.0MHz)	10MHz	256QAM	50 RB / 0 RB Offset
		132047 to 132597	132047 (1717.5MHz), 132597 (1772.5MHz)	15MHz	256QAM	75 RB / 0 RB Offset
		132072 to 132572	132072 (1720.0MHz), 132572 (1770.0MHz)	20MHz	256QAM	100 RB / 0 RB Offset

EUT Configure Mode	Test Item	Available Channel	Tested Channel	Channel Bandwidth	Modulation	Mode
-	Emission Bandwidth	131979 to 132665	131979 (1710.7MHz), 132322 (1745.0MHz), 132665 (1779.3MHz)	1.4MHz	256QAM	6 RB / 0 RB Offset
		131987 to 132657	131987 (1711.5MHz), 132322 (1745.0MHz), 132657 (1778.5MHz)	3MHz	256QAM	15 RB / 0 RB Offset
		131997 to 132647	131997 (1712.5MHz), 132322 (1745.0MHz), 132647 (1777.5MHz)	5MHz	256QAM	25 RB / 0 RB Offset
		132022 to 132622	132022 (1715.0MHz), 132322 (1745.0MHz), 132622 (1775.0MHz)	10MHz	256QAM	50 RB / 0 RB Offset
		132047 to 132597	132047 (1717.5MHz), 132322 (1745.0MHz), 132597 (1772.5MHz)	15MHz	256QAM	75 RB / 0 RB Offset
		132072 to 132572	132072 (1720.0MHz), 132322 (1745.0MHz), 132572 (1770.0MHz)	20MHz	256QAM	100 RB / 0 RB Offset
-	Band Edge	131979 to 132665	131979 (1710.7MHz), 132665 (1779.3MHz)	1.4MHz	256QAM	1 RB / 0 RB Offset 1 RB / 5 RB Offset 6 RB / 0 RB Offset
		131987 to 132657	131987 (1711.5MHz), 132657 (1778.5MHz)	3MHz	256QAM	1 RB / 0 RB Offset 1 RB / 14 RB Offset 15 RB / 0 RB Offset
		131997 to 132647	131997 (1712.5MHz), 132647 (1777.5MHz)	5MHz	256QAM	1 RB / 0 RB Offset 1 RB / 24 RB Offset 25 RB / 0 RB Offset
		132022 to 132622	132022 (1715.0MHz), 132622 (1775.0MHz)	10MHz	256QAM	1 RB / 0 RB Offset 1 RB / 49 RB Offset 50 RB / 0 RB Offset
		132047 to 132597	132047 (1717.5MHz), 132597 (1772.5MHz)	15MHz	256QAM	1 RB / 0 RB Offset 1 RB / 74 RB Offset 75 RB / 0 RB Offset
		132072 to 132572	132072 (1720.0MHz), 132572 (1770.0MHz)	20MHz	256QAM	1 RB / 0 RB Offset 1 RB / 99 RB Offset 100 RB / 0 RB Offset
-	Peak to Average Ratio	131979 to 132665	131979 (1710.7MHz), 132322 (1745.0MHz), 132665 (1779.3MHz)	1.4MHz	256QAM	1 RB / 0 RB Offset
		131987 to 132657	131987 (1711.5MHz), 132322 (1745.0MHz), 132657 (1778.5MHz)	3MHz	256QAM	1 RB / 0 RB Offset
		131997 to 132647	131997 (1712.5MHz), 132322 (1745.0MHz), 132647 (1777.5MHz)	5MHz	256QAM	1 RB / 0 RB Offset
		132022 to 132622	132022 (1715.0MHz), 132322 (1745.0MHz), 132622 (1775.0MHz)	10MHz	256QAM	1 RB / 0 RB Offset
		132047 to 132597	132047 (1717.5MHz), 132322 (1745.0MHz), 132597 (1772.5MHz)	15MHz	256QAM	1 RB / 0 RB Offset
		132072 to 132572	132072 (1720.0MHz), 132322 (1745.0MHz), 132572 (1770.0MHz)	20MHz	256QAM	1 RB / 0 RB Offset

EUT Configure Mode	Test Item	Available Channel	Tested Channel	Channel Bandwidth	Modulation	Mode
-	Conducted Emission	131979 to 132665	131979 (1710.7MHz), 132322 (1745.0MHz), 132665 (1779.3MHz)	1.4MHz	256QAM	1 RB / 0 RB Offset
		131987 to 132657	131987 (1711.5MHz), 132322 (1745.0MHz), 132657 (1778.5MHz)	3MHz	256QAM	1 RB / 0 RB Offset
		131997 to 132647	131997 (1712.5MHz), 132322 (1745.0MHz), 132647 (1777.5MHz)	5MHz	256QAM	1 RB / 0 RB Offset
		132022 to 132622	132022 (1715.0MHz), 132322 (1745.0MHz), 132622 (1775.0MHz)	10MHz	256QAM	1 RB / 0 RB Offset
		132047 to 132597	132047 (1717.5MHz), 132322 (1745.0MHz), 132597 (1772.5MHz)	15MHz	256QAM	1 RB / 0 RB Offset
		132072 to 132572	132072 (1720.0MHz), 132322 (1745.0MHz), 132572 (1770.0MHz)	20MHz	256QAM	1 RB / 0 RB Offset
-	Radiated Emission Below 1GHz	131997 to 132647	131997 (1712.5MHz)	5MHz	256QAM	1 RB / 0 RB Offset
-	Radiated Emission Above 1GHz	131979 to 132665	131979 (1710.7MHz), 132322 (1745.0MHz), 132665 (1779.3MHz)	1.4MHz	256QAM	1 RB / 0 RB Offset
		131997 to 132647	131997 (1712.5MHz), 132322 (1745.0MHz), 132647 (1777.5MHz)	5MHz	256QAM	1 RB / 0 RB Offset
		132072 to 132572	132072 (1720.0MHz), 132322 (1745.0MHz), 132572 (1770.0MHz)	20MHz	256QAM	1 RB / 0 RB Offset

Test Condition:

Test Item	Environmental Conditions	Input Power (system)	Tested By
ERP	25deg. C, 70%RH	5Vdc	James Yang
Frequency Stability	24deg. C, 64%RH	5Vdc	James Yang
Occupied Bandwidth	24deg. C, 64%RH	5Vdc	James Yang
Band Edge	24deg. C, 64%RH	5Vdc	James Yang
Peak To Average Ratio	24deg. C, 64%RH	5Vdc	James Yang
Conducted Emission	24deg. C, 64%RH	5Vdc	James Yang
Radiated Emission	22deg. C, 68%RH 24deg. C, 64%RH	120Vac, 60Hz	Greg Lin Match Tsui

3.4 EUT Operating Conditions

The EUT makes a call to the communication simulator. The communication simulator station system controlled a EUT to export maximum output power under transmission mode and specific channel frequency

3.5 General Description of Applied Standards and References

The EUT is a RF Product. According to the specifications of the manufacturer, it must comply with the requirements of the following standards and References:

Test Standard:

FCC 47 CFR Part 2

FCC 47 CFR Part 24

FCC 47 CFR Part 27

ANSI/TIA/EIA-603-D-2010

ANSI/TIA/EIA-603-E 2016

ANSI 63.26-2015

All test items have been performed and recorded as per the above standards.

References Test Guidance:

KDB 971168 D01 Power Meas License Digital Systems v03r01

KDB 971168 D02 Misc Rev Approv License Devices v02r01

All test items have been performed as a reference to the above KDB test guidance.

4 Test Types and Results

4.1 Output Power Measurement

4.1.1 Limits of Output Power Measurement

For n12:

Control and mobile stations in the 698-746 MHz, 746-757 MHz, 787-788 MHz and 805-806 MHz band are limited to 30 watts ERP.

Portable stations (hand-held devices) in the 600 MHz uplink band and the 698-746 MHz band, and fixed and mobile stations in the 600 MHz uplink, 746-757 MHz, 787-788 MHz and 805-806 MHz band are limited to 3 watts ERP.

For LTE Band 2:

Mobile / Portable station are limited to 2 watts e.r.p.

For LTE Band 66:

Mobile / Portable station are limited to 1 watts e.i.r.p.

4.1.2 Test Procedures

Conducted Power Measurement:

The EUT was set up for the maximum power with 5GNR link data modulation and link up with simulator.

Set the EUT to transmit under low, middle and high channel and record the power level shown on simulator.

Maximum EIRP

The relevant equation for determining the maximum ERP or EIRP from the measured RF output power is given in Equation as follows:

$$ERP \text{ or } EIRP = P_{Meas} + G_T$$

where

ERP or EIRP effective radiated power or equivalent isotropically radiated power, respectively (expressed in the same units as P_{Meas} , e.g., dBm or dBW)

P_{Meas} measured transmitter output power or PSD, in dBm or dBW

G_T gain of the transmitting antenna, in dBd (ERP) or dBi (EIRP)

4.1.3 Test Setup

Conducted Power Measurement:



For the actual test configuration, please refer to the attached file (Test Setup Photo).

4.1.4 Test Results

Conducted Output Power (dBm)

		n12				
BW	MCS Index	Channel		140300	141500	142700
		Frequency (MHz)		701.5	707.5	713.5
5M	$\pi/2$ BPSK	1	0	22.97	22.90	23.13
		1	12	22.96	22.96	23.30
		1	24	22.81	23.19	23.23
		12	0	22.66	23.01	22.62
		12	6	22.83	22.74	22.97
		12	13	22.75	22.70	22.93
		25	0	22.90	22.72	22.66
	QPSK	1	0	23.09	23.04	22.99
		1	12	22.93	22.88	22.98
		1	24	23.07	22.84	22.93
		12	0	22.84	22.80	22.72
		12	6	22.84	22.72	22.80
		12	13	22.78	22.87	22.71
		25	0	22.86	22.72	22.73
	16QAM	1	0	22.83	22.60	22.95
		1	12	22.68	22.80	22.94
		1	24	22.81	22.71	22.69
		12	0	22.76	22.73	22.53
		12	6	22.61	22.44	22.70
		12	13	22.43	22.76	22.69
		25	0	22.44	22.60	22.60
	64QAM	1	0	22.36	22.20	22.29
		1	12	22.57	22.24	22.45
		1	24	22.55	22.41	22.70
		12	0	22.04	22.10	22.21
		12	6	22.34	22.06	22.13
		12	13	22.48	22.50	22.20
		25	0	22.26	22.01	22.38
	256QAM	1	0	19.93	20.17	20.14
		1	12	20.09	20.20	20.25
		1	24	19.99	20.13	19.93
		12	0	19.63	19.21	20.00
		12	6	19.64	19.89	19.25
		12	13	19.23	19.27	19.43
		25	0	19.90	19.58	19.72

n12						
BW	MCS Index	Channel		140800	141500	142200
		Frequency (MHz)		704	707.5	711
10M	$\pi/2$ BPSK	1	0	23.11	23.13	22.87
		1	26	23.14	23.10	22.97
		1	51	23.05	22.85	23.22
		26	0	22.74	22.99	22.85
		26	13	23.08	22.65	22.94
		26	26	22.80	22.66	22.72
		52	0	22.96	22.85	22.98
	QPSK	1	0	22.89	22.98	22.90
		1	26	22.80	23.07	23.05
		1	51	23.09	22.85	22.81
		26	0	22.61	22.76	22.81
		26	13	22.62	22.68	22.77
		26	26	22.84	22.68	22.85
		52	0	22.76	22.77	22.79
	16QAM	1	0	22.61	22.62	22.60
		1	26	23.00	22.69	22.91
		1	51	22.71	22.93	22.90
		26	0	22.40	22.53	22.79
		26	13	22.61	22.49	22.47
		26	26	22.62	22.57	22.62
		52	0	22.79	22.56	22.44
	64QAM	1	0	22.32	22.63	22.64
		1	26	22.63	22.44	22.59
		1	51	22.59	22.62	22.54
		26	0	22.44	22.49	22.35
		26	13	22.44	22.04	22.01
		26	26	22.38	22.50	22.48
		52	0	22.07	22.29	22.47
	256QAM	1	0	20.23	19.70	19.78
		1	26	19.98	19.75	20.24
		1	51	20.30	19.77	20.14
		26	0	19.59	19.22	19.77
		26	13	19.14	19.21	19.81
		26	26	19.54	19.45	19.90
		52	0	19.25	19.69	19.40

n12						
BW	MCS Index	Channel		141300	141500	141700
		Frequency (MHz)		706.5	707.5	708.5
15M	$\pi/2$ BPSK	1	0	22.96	23.04	23.08
		1	39	23.07	23.07	22.83
		1	78	22.84	23.17	22.90
		39	0	22.96	22.90	22.67
		39	19	23.00	22.74	22.60
		39	40	22.88	22.74	22.83
		79	0	22.62	22.93	22.96
	QPSK	1	0	23.10	22.86	22.87
		1	39	22.83	23.05	22.84
		1	78	22.88	22.89	22.83
		39	0	22.77	22.90	22.87
		39	19	22.62	22.74	22.77
		39	40	22.73	22.76	22.76
		79	0	22.56	22.66	22.61
	16QAM	1	0	22.74	22.92	22.83
		1	39	22.72	22.85	22.99
		1	78	22.65	22.65	22.82
		39	0	22.44	22.77	22.68
		39	19	22.69	22.70	22.45
		39	40	22.68	22.47	22.57
		79	0	22.48	22.51	22.75
	64QAM	1	0	22.32	22.59	22.61
		1	39	22.30	22.65	22.26
		1	78	22.44	22.37	22.42
		39	0	22.00	22.03	22.10
		39	19	22.15	22.43	22.37
		39	40	22.34	22.48	22.17
		79	0	22.43	22.18	22.42
	256QAM	1	0	19.81	20.12	20.16
		1	39	19.72	19.67	19.67
		1	78	19.68	19.75	19.60
		39	0	19.49	19.79	19.80
		39	19	19.22	19.71	19.13
		39	40	19.17	19.85	19.91
		79	0	19.15	19.93	19.35

LTE Band 2						
BW	MCS Index	RB Size	RB Offset	Low	Mid	High
		Channel		18607	18900	19193
		Frequency (MHz)		1850.7	1880	1909.3
1.4M	256QAM	1	0	20.17	20.17	19.75
		1	2	20.10	19.99	19.84
		1	5	20.17	20.20	19.71
		3	0	19.78	19.72	19.79
		3	1	20.01	20.24	20.11
		3	3	19.91	19.87	19.76
		6	0	19.96	20.13	19.81
BW	MCS Index	Channel		18615	18900	19185
		Frequency (MHz)		1851.5	1880	1908.5
3M	256QAM	1	0	19.66	20.05	19.92
		1	7	19.69	20.00	20.02
		1	14	20.22	19.85	19.82
		8	0	19.91	20.15	19.82
		8	3	20.05	19.95	19.97
		8	7	19.78	19.88	20.02
		15	0	19.97	19.88	20.07
BW	MCS Index	Channel		18625	18900	19175
		Frequency (MHz)		1852.5	1880	1907.5
5M	256QAM	1	0	19.62	19.74	19.97
		1	12	20.25	19.72	20.00
		1	24	20.00	19.78	19.94
		12	0	20.21	20.14	20.07
		12	6	19.90	20.10	19.99
		12	13	19.84	20.03	19.84
		25	0	20.04	19.86	20.10
BW	MCS Index	Channel		18650	18900	19150
		Frequency (MHz)		1855	1880	1905
10M	256QAM	1	0	20.31	20.28	19.75
		1	24	20.44	20.26	19.86
		1	49	19.90	20.25	19.75
		25	0	20.19	19.86	20.18
		25	12	20.20	20.11	19.82
		25	25	19.70	20.31	19.69
		50	0	20.39	19.91	19.98

LTE Band 2						
BW	MCS Index	Channel		18675	18900	19125
		Frequency (MHz)		1857.5	1880	1902.5
15M	256QAM	1	0	20.16	19.76	19.87
		1	37	19.59	20.20	20.22
		1	74	20.27	19.98	20.06
		36	0	20.37	20.15	19.73
		36	19	20.46	20.40	20.31
		36	39	20.44	20.40	19.70
		75	0	19.81	20.25	19.66
BW	MCS Index	Channel		18700	18900	19100
		Frequency (MHz)		1860	1880	1900
20M	256QAM	1	0	19.58	20.34	20.17
		1	50	19.64	19.72	20.07
		1	99	20.21	20.37	20.30
		50	0	19.91	20.18	20.03
		50	25	19.64	19.71	20.06
		50	50	20.20	19.90	20.05
		100	0	20.47	19.94	20.26

LTE Band 66						
BW	MCS Index	Channel		131979	132322	132665
		Frequency (MHz)		1710.7	1745	1779.3
1.4M	256QAM	1	0	19.60	20.02	20.04
		1	2	20.07	19.73	19.96
		1	5	19.63	19.93	19.91
		3	0	20.05	19.85	20.07
		3	1	19.61	19.63	20.12
		3	3	19.74	19.87	20.01
		6	0	19.71	19.85	19.63
BW	MCS Index	Channel		131987	132322	132657
		Frequency (MHz)		1711.5	1745	1778.5
3M	256QAM	1	0	20.08	20.20	20.08
		1	7	20.05	19.61	20.14
		1	14	20.19	19.94	20.04
		8	0	20.02	20.06	20.17
		8	3	20.17	19.66	19.89
		8	7	19.70	19.80	19.91
		15	0	19.68	19.49	19.98
BW	MCS Index	Channel		131997	132322	132647
		Frequency (MHz)		1712.5	1745	1777.5
5M	256QAM	1	0	19.87	20.26	19.94
		1	12	19.92	20.08	19.82
		1	24	19.60	19.57	19.78
		12	0	20.22	19.92	19.78
		12	6	19.86	19.54	19.75
		12	13	19.78	19.49	19.76
		25	0	19.67	19.58	20.10
BW	MCS Index	Channel		132022	132322	132622
		Frequency (MHz)		1715	1745	1775
10M	256QAM	1	0	19.54	19.71	19.91
		1	24	19.66	19.81	19.99
		1	49	19.86	19.51	19.92
		25	0	19.61	19.55	19.98
		25	12	20.10	20.13	19.76
		25	25	19.89	19.49	20.08
		50	0	19.64	19.88	20.13

LTE Band 66						
BW	MCS Index	Channel		132047	132322	132597
		Frequency (MHz)		1717.5	1745	1772.5
15M	256QAM	1	0	20.16	19.48	20.06
		1	37	19.67	20.00	19.80
		1	74	20.07	19.64	20.01
		36	0	20.11	19.48	20.16
		36	19	20.17	19.79	20.18
		36	39	19.77	19.87	19.80
		75	0	20.18	19.92	20.18
BW	MCS Index	Channel		132072	132322	132575
		Frequency (MHz)		1720	1745	1770
20M	256QAM	1	0	19.81	20.19	20.09
		1	50	19.66	19.72	19.81
		1	99	19.76	20.01	19.79
		50	0	19.53	19.48	19.87
		50	25	20.16	19.99	19.76
		50	50	19.97	19.73	20.08
		100	0	19.90	20.06	19.91

ERP Power (dBm)

		n12				
BW	MCS Index	Channel		140300	141500	142700
		Frequency (MHz)		701.5	707.5	713.5
5M	$\pi/2$ BPSK	1	0	25.23	25.16	25.39
		1	12	25.22	25.22	25.56
		1	24	25.07	25.45	25.49
		12	0	24.92	25.27	24.88
		12	6	25.09	25.00	25.23
		12	13	25.01	24.96	25.19
		25	0	25.16	24.98	24.92
	QPSK	1	0	25.35	25.30	25.25
		1	12	25.19	25.14	25.24
		1	24	25.33	25.10	25.19
		12	0	25.10	25.06	24.98
		12	6	25.10	24.98	25.06
		12	13	25.04	25.13	24.97
		25	0	25.12	24.98	24.99
	16QAM	1	0	25.09	24.86	25.21
		1	12	24.94	25.06	25.20
		1	24	25.07	24.97	24.95
		12	0	25.02	24.99	24.79
		12	6	24.87	24.70	24.96
		12	13	24.69	25.02	24.95
		25	0	24.70	24.86	24.86
	64QAM	1	0	24.62	24.46	24.55
		1	12	24.83	24.50	24.71
		1	24	24.81	24.67	24.96
		12	0	24.30	24.36	24.47
		12	6	24.60	24.32	24.39
		12	13	24.74	24.76	24.46
		25	0	24.52	24.27	24.64
	256QAM	1	0	22.19	22.43	22.40
		1	12	22.35	22.46	22.51
		1	24	22.25	22.39	22.19
		12	0	21.89	21.47	22.26
		12	6	21.90	22.15	21.51
		12	13	21.49	21.53	21.69
		25	0	22.16	21.84	21.98

*ERP = Conducted + antenna gain (4.41dBi)-2.15

n12						
BW	MCS Index	Channel		140800	141500	142200
		Frequency (MHz)		704	707.5	711
10M	$\pi/2$ BPSK	1	0	25.37	25.39	25.13
		1	26	25.40	25.36	25.23
		1	51	25.31	25.11	25.48
		26	0	25.00	25.25	25.11
		26	13	25.34	24.91	25.20
		26	26	25.06	24.92	24.98
		52	0	25.22	25.11	25.24
	QPSK	1	0	25.15	25.24	25.16
		1	26	25.06	25.33	25.31
		1	51	25.35	25.11	25.07
		26	0	24.87	25.02	25.07
		26	13	24.88	24.94	25.03
		26	26	25.10	24.94	25.11
		52	0	25.02	25.03	25.05
	16QAM	1	0	24.87	24.88	24.86
		1	26	25.26	24.95	25.17
		1	51	24.97	25.19	25.16
		26	0	24.66	24.79	25.05
		26	13	24.87	24.75	24.73
		26	26	24.88	24.83	24.88
		52	0	25.05	24.82	24.70
	64QAM	1	0	24.58	24.89	24.90
		1	26	24.89	24.70	24.85
		1	51	24.85	24.88	24.80
		26	0	24.70	24.75	24.61
		26	13	24.70	24.30	24.27
		26	26	24.64	24.76	24.74
		52	0	24.33	24.55	24.73
	256QAM	1	0	22.49	21.96	22.04
		1	26	22.24	22.01	22.50
		1	51	22.56	22.03	22.40
		26	0	21.85	21.48	22.03
		26	13	21.40	21.47	22.07
		26	26	21.80	21.71	22.16
		52	0	21.51	21.95	21.66

*ERP = Conducted + antenna gain (4.41dBi)-2.15

n12						
BW	MCS Index	Channel		141300	141500	141700
		Frequency (MHz)		706.5	707.5	708.5
15M	$\pi/2$ BPSK	1	0	25.22	25.30	25.34
		1	39	25.33	25.33	25.09
		1	78	25.10	25.43	25.16
		39	0	25.22	25.16	24.93
		39	19	25.26	25.00	24.86
		39	40	25.14	25.00	25.09
		79	0	24.88	25.19	25.22
	QPSK	1	0	25.36	25.12	25.13
		1	39	25.09	25.31	25.10
		1	78	25.14	25.15	25.09
		39	0	25.03	25.16	25.13
		39	19	24.88	25.00	25.03
		39	40	24.99	25.02	25.02
		79	0	24.82	24.92	24.87
	16QAM	1	0	25.00	25.18	25.09
		1	39	24.98	25.11	25.25
		1	78	24.91	24.91	25.08
		39	0	24.70	25.03	24.94
		39	19	24.95	24.96	24.71
		39	40	24.94	24.73	24.83
		79	0	24.74	24.77	25.01
	64QAM	1	0	24.58	24.85	24.87
		1	39	24.56	24.91	24.52
		1	78	24.70	24.63	24.68
		39	0	24.26	24.29	24.36
		39	19	24.41	24.69	24.63
		39	40	24.60	24.74	24.43
		79	0	24.69	24.44	24.68
	256QAM	1	0	22.07	22.38	22.42
		1	39	21.98	21.93	21.93
		1	78	21.94	22.01	21.86
		39	0	21.75	22.05	22.06
		39	19	21.48	21.97	21.39
		39	40	21.43	22.11	22.17
		79	0	21.41	22.19	21.61

*ERP = Conducted + antenna gain (4.41dBi)-2.15

EIRP

LTE Band 2						
BW	MCS Index	RB Size	RB Offset	Low	Mid	High
		Channel		18607	18900	19193
		Frequency (MHz)		1850.7	1880	1909.3
1.4M	256QAM	1	0	24.44	24.44	24.02
		1	2	24.37	24.26	24.11
		1	5	24.44	24.47	23.98
		3	0	24.05	23.99	24.06
		3	1	24.28	24.51	24.38
		3	3	24.18	24.14	24.03
		6	0	24.23	24.40	24.08
BW	MCS Index	Channel		18615	18900	19185
		Frequency (MHz)		1851.5	1880	1908.5
3M	256QAM	1	0	23.93	24.32	24.19
		1	7	23.96	24.27	24.29
		1	14	24.49	24.12	24.09
		8	0	24.18	24.42	24.09
		8	3	24.32	24.22	24.24
		8	7	24.05	24.15	24.29
		15	0	24.24	24.15	24.34
BW	MCS Index	Channel		18625	18900	19175
		Frequency (MHz)		1852.5	1880	1907.5
5M	256QAM	1	0	23.89	24.01	24.24
		1	12	24.52	23.99	24.27
		1	24	24.27	24.05	24.21
		12	0	24.48	24.41	24.34
		12	6	24.17	24.37	24.26
		12	13	24.11	24.30	24.11
		25	0	24.31	24.13	24.37
BW	MCS Index	Channel		18650	18900	19150
		Frequency (MHz)		1855	1880	1905
10M	256QAM	1	0	24.58	24.55	24.02
		1	24	24.71	24.53	24.13
		1	49	24.17	24.52	24.02
		25	0	24.46	24.13	24.45
		25	12	24.47	24.38	24.09
		25	25	23.97	24.58	23.96
		50	0	24.66	24.18	24.25

*EIRP = Conducted + antenna gain (4.27dBi)

LTE Band 2						
BW	MCS Index	Channel		18675	18900	19125
		Frequency (MHz)		1857.5	1880	1902.5
15M	256QAM	1	0	24.43	24.03	24.14
		1	37	23.86	24.47	24.49
		1	74	24.54	24.25	24.33
		36	0	24.64	24.42	24.00
		36	19	24.73	24.67	24.58
		36	39	24.71	24.67	23.97
		75	0	24.08	24.52	23.93
BW	MCS Index	Channel		18700	18900	19100
		Frequency (MHz)		1860	1880	1900
20M	256QAM	1	0	23.85	24.61	24.44
		1	50	23.91	23.99	24.34
		1	99	24.48	24.64	24.57
		50	0	24.18	24.45	24.30
		50	25	23.91	23.98	24.33
		50	50	24.47	24.17	24.32
		100	0	24.74	24.21	24.53

*EIRP = Conducted + antenna gain (4.27dBi)

LTE Band 66						
BW	MCS Index	Channel		131979	132322	132665
		Frequency (MHz)		1710.7	1745	1779.3
1.4M	256QAM	1	0	23.87	24.29	24.31
		1	2	24.34	24.00	24.23
		1	5	23.90	24.20	24.18
		3	0	24.32	24.12	24.34
		3	1	23.88	23.90	24.39
		3	3	24.01	24.14	24.28
		6	0	23.98	24.12	23.90
BW	MCS Index	Channel		131987	132322	132657
		Frequency (MHz)		1711.5	1745	1778.5
3M	256QAM	1	0	24.35	24.47	24.35
		1	7	24.32	23.88	24.41
		1	14	24.46	24.21	24.31
		8	0	24.29	24.33	24.44
		8	3	24.44	23.93	24.16
		8	7	23.97	24.07	24.18
		15	0	23.95	23.76	24.25
BW	MCS Index	Channel		131997	132322	132647
		Frequency (MHz)		1712.5	1745	1777.5
5M	256QAM	1	0	24.14	24.53	24.21
		1	12	24.19	24.35	24.09
		1	24	23.87	23.84	24.05
		12	0	24.49	24.19	24.05
		12	6	24.13	23.81	24.02
		12	13	24.05	23.76	24.03
		25	0	23.94	23.85	24.37
BW	MCS Index	Channel		132022	132322	132622
		Frequency (MHz)		1715	1745	1775
10M	256QAM	1	0	23.81	23.98	24.18
		1	24	23.93	24.08	24.26
		1	49	24.13	23.78	24.19
		25	0	23.88	23.82	24.25
		25	12	24.37	24.40	24.03
		25	25	24.16	23.76	24.35
		50	0	23.91	24.15	24.40

*EIRP = Conducted + antenna gain (4.27dBi)

LTE Band 66						
BW	MCS Index	Channel		132047	132322	132597
		Frequency (MHz)		1717.5	1745	1772.5
15M	256QAM	1	0	24.43	23.75	24.33
		1	37	23.94	24.27	24.07
		1	74	24.34	23.91	24.28
		36	0	24.38	23.75	24.43
		36	19	24.44	24.06	24.45
		36	39	24.04	24.14	24.07
		75	0	24.45	24.19	24.45
BW	MCS Index	Channel		132072	132322	132575
		Frequency (MHz)		1720	1745	1770
20M	256QAM	1	0	24.08	24.46	24.36
		1	50	23.93	23.99	24.08
		1	99	24.03	24.28	24.06
		50	0	23.80	23.75	24.14
		50	25	24.43	24.26	24.03
		50	50	24.24	24.00	24.35
		100	0	24.17	24.33	24.18

*EIRP = Conducted + antenna gain (4.27dBi)

4.2 Modulation Characteristics Measurement

4.2.1 Limits of Modulation Characteristics

N/A

4.2.2 Test Procedure

Connect the EUT to Communication Simulator via the antenna connector, The frequency band is set as EUT supported Modulation and Channels, the EUT output is matched with 50 ohm load, the waveform quality and constellation of the EUT was tested.

4.2.3 Test Setup



4.2.4 Test Results



4.3 Frequency Stability Measurement

4.3.1 Limits of Frequency Stability Measurement

1.5 ppm is for base and fixed station. 2.5 ppm is for mobile station.

4.3.2 Test Procedure

- Device is placed at the oven room. The oven room could control the temperatures and humidity. Power warm up is at least 15 min and power applied should perform before recording frequency error.
- EUT is connected the external power supply to control the DC input power. The test voltage range is from minimum to maximum working voltage. Each step shall be record the frequency error rate.
- The temperature range step is 10 degrees in this test items. All temperature levels shall be hold the ± 0.5 °C during the measurement testing. The each temperature step shall be at least 0.5 hours, consider the EUT could be test under the stability condition.

Note: The frequency error was recorded frequency error from the communication simulator.

4.3.3 Test Setup

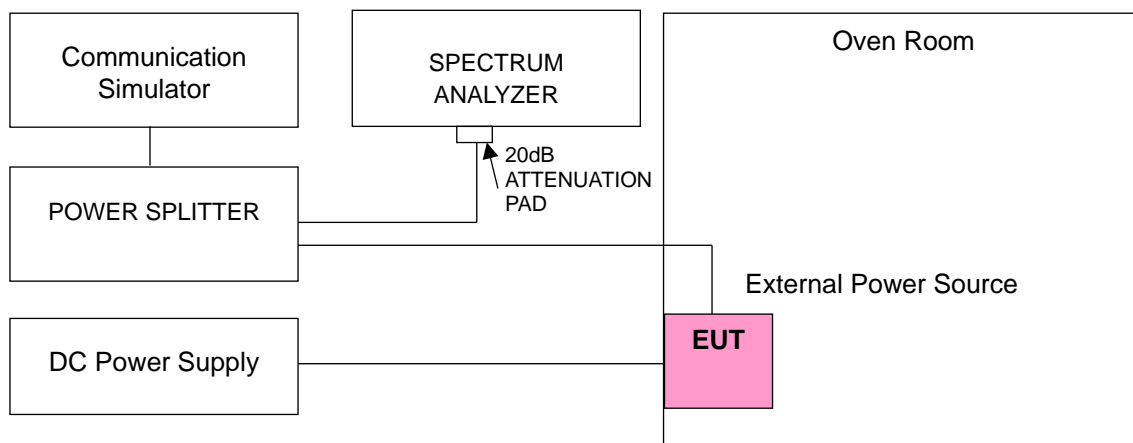

4.3.4 Test Results

Frequency Error vs. Voltage

Voltage (Volts)	n12			
	Channel Bandwidth: 5 MHz			
	Low Channel		High Channel	
	Frequency (MHz)	Frequency Error (ppm)	Frequency (MHz)	Frequency Error (ppm)
4.25	701.500004	0.006	713.500002	0.003
5	701.500001	0.002	713.500004	0.005
5.75	701.500004	0.005	713.500003	0.005

Note: The applicant defined the normal working voltage is from 4.25Vdc to 5.75Vdc.

Frequency Error vs. Temperature

Temp. (°C)	n12			
	Channel Bandwidth: 5 MHz			
	Low Channel		High Channel	
	Frequency (MHz)	Frequency Error (ppm)	Frequency (MHz)	Frequency Error (ppm)
-30	701.500002	0.003	713.500002	0.003
-20	701.500003	0.004	713.500003	0.004
-10	701.500001	0.001	713.500002	0.002
0	701.500004	0.006	713.500002	0.003
10	701.500004	0.005	713.500003	0.004
20	701.499999	-0.001	713.499999	-0.002
30	701.499999	-0.001	713.499997	-0.004
40	701.499996	-0.005	713.499996	-0.006
50	701.499998	-0.003	713.499997	-0.004

Frequency Error vs. Voltage

Voltage (Volts)	n12			
	Channel Bandwidth: 10 MHz			
	Low Channel		High Channel	
	Frequency (MHz)	Frequency Error (ppm)	Frequency (MHz)	Frequency Error (ppm)
4.25	704.000003	0.004	711.000004	0.005
5	704.000002	0.003	711.000002	0.003
5.75	704.000002	0.003	711.000004	0.006

Note: The applicant defined the normal working voltage is from 4.25Vdc to 5.75Vdc.

Frequency Error vs. Temperature

Temp. (°C)	n12			
	Channel Bandwidth: 10 MHz			
	Low Channel		High Channel	
	Frequency (MHz)	Frequency Error (ppm)	Frequency (MHz)	Frequency Error (ppm)
-30	704.000002	0.002	711.000001	0.002
-20	704.000001	0.002	711.000001	0.001
-10	704.000004	0.005	711.000004	0.005
0	704.000002	0.003	711.000004	0.005
10	704.000004	0.005	711.000003	0.004
20	703.999998	-0.003	710.999998	-0.003
30	703.999997	-0.004	710.999998	-0.003
40	703.999997	-0.004	710.999998	-0.004
50	703.999997	-0.004	710.999996	-0.005

Frequency Error vs. Voltage

Voltage (Volts)	n12			
	Channel Bandwidth: 15 MHz			
	Low Channel		High Channel	
	Frequency (MHz)	Frequency Error (ppm)	Frequency (MHz)	Frequency Error (ppm)
4.25	706.500001	0.002	708.500002	0.002
5	706.500004	0.005	708.500001	0.002
5.75	706.500003	0.005	708.500002	0.003

Note: The applicant defined the normal working voltage is from 4.25Vdc to 5.75Vdc.

Frequency Error vs. Temperature

Temp. (°C)	n12			
	Channel Bandwidth: 15 MHz			
	Low Channel		High Channel	
	Frequency (MHz)	Frequency Error (ppm)	Frequency (MHz)	Frequency Error (ppm)
-30	706.500001	0.002	708.500004	0.005
-20	706.500002	0.003	708.500002	0.003
-10	706.500002	0.003	708.500003	0.004
0	706.500002	0.003	708.500001	0.001
10	706.500003	0.004	708.500002	0.002
20	706.499997	-0.005	708.499997	-0.004
30	706.499997	-0.004	708.499997	-0.005
40	706.499999	-0.002	708.499999	-0.002
50	706.499998	-0.003	708.499998	-0.003

Frequency Error vs. Voltage

Voltage (Volts)	LTE Band 2			
	Channel Bandwidth: 1.4 MHz			
	Low Channel		High Channel	
	Frequency (MHz)	Frequency Error (ppm)	Frequency (MHz)	Frequency Error (ppm)
4.25	1850.700002	0.001	1909.300000	0.002
5	1850.700002	0.001	1909.300002	0.001
5.75	1850.700003	0.002	1909.300002	0.001

Note: The applicant defined the normal working voltage is from 4.25Vdc to 5.75Vdc.

Frequency Error vs. Temperature

Temp. (°C)	LTE Band 2			
	Channel Bandwidth: 1.4 MHz			
	Low Channel		High Channel	
	Frequency (MHz)	Frequency Error (ppm)	Frequency (MHz)	Frequency Error (ppm)
-30	1850.700003	0.002	1909.300003	0.002
-20	1850.700001	0.001	1909.300004	0.002
-10	1850.700002	0.001	1909.300004	0.002
0	1850.700003	0.002	1909.300003	0.001
10	1850.700003	0.002	1909.300002	0.001
20	1850.699996	-0.002	1909.299998	-0.001
30	1850.699997	-0.002	1909.299997	-0.001
40	1850.699999	-0.001	1909.299999	-0.001
50	1850.699998	-0.001	1909.299998	-0.001

Frequency Error vs. Voltage

Voltage (Volts)	LTE Band 2			
	Channel Bandwidth: 3 MHz			
	Low Channel		High Channel	
	Frequency (MHz)	Frequency Error (ppm)	Frequency (MHz)	Frequency Error (ppm)
4.25	1851.500004	0.002	1908.500004	0.002
5	1851.500003	0.002	1908.500004	0.002
5.75	1851.500001	0.001	1908.500002	0.001

Note: The applicant defined the normal working voltage is from 4.25Vdc to 5.75Vdc.

Frequency Error vs. Temperature

Temp. (°C)	LTE Band 2			
	Channel Bandwidth: 3 MHz			
	Low Channel		High Channel	
	Frequency (MHz)	Frequency Error (ppm)	Frequency (MHz)	Frequency Error (ppm)
-30	1851.500002	0.001	1908.500001	0.001
-20	1851.500002	0.001	1908.500004	0.002
-10	1851.500002	0.001	1908.500004	0.002
0	1851.500002	0.001	1908.500002	0.001
10	1851.500003	0.002	1908.500001	0.001
20	1851.499996	-0.002	1908.499996	-0.002
30	1851.499997	-0.002	1908.499997	-0.002
40	1851.499996	-0.002	1908.499998	-0.001
50	1851.499998	-0.001	1908.499998	-0.001

Frequency Error vs. Voltage

Voltage (Volts)	LTE Band 2			
	Channel Bandwidth: 5 MHz			
	Low Channel		High Channel	
	Frequency (MHz)	Frequency Error (ppm)	Frequency (MHz)	Frequency Error (ppm)
4.25	1852.500002	0.001	1907.500003	0.002
5	1852.500001	0.001	1907.500001	0.001
5.75	1852.500001	0.001	1907.500003	0.002

Note: The applicant defined the normal working voltage is from 4.25Vdc to 5.75Vdc.

Frequency Error vs. Temperature

Temp. (°C)	LTE Band 2			
	Channel Bandwidth: 5 MHz			
	Low Channel		High Channel	
	Frequency (MHz)	Frequency Error (ppm)	Frequency (MHz)	Frequency Error (ppm)
-30	1852.500002	0.001	1907.500002	0.001
-20	1852.500003	0.002	1907.500002	0.001
-10	1852.500002	0.001	1907.500003	0.002
0	1852.500002	0.001	1907.500004	0.002
10	1852.500001	0.001	1907.500004	0.002
20	1852.499996	-0.002	1907.499997	-0.002
30	1852.499997	-0.001	1907.499996	-0.002
40	1852.499999	-0.001	1907.499997	-0.002
50	1852.499999	-0.001	1907.499999	-0.001

Frequency Error vs. Voltage

Voltage (Volts)	LTE Band 2			
	Channel Bandwidth: 10 MHz			
	Low Channel		High Channel	
	Frequency (MHz)	Frequency Error (ppm)	Frequency (MHz)	Frequency Error (ppm)
4.25	1855.000003	0.002	1905.000003	0.002
5	1855.000001	0.001	1905.000003	0.002
5.75	1855.000004	0.002	1905.000003	0.002

Note: The applicant defined the normal working voltage is from 4.25Vdc to 5.75Vdc.

Frequency Error vs. Temperature

Temp. (°C)	LTE Band 2			
	Channel Bandwidth: 10 MHz			
	Low Channel		High Channel	
	Frequency (MHz)	Frequency Error (ppm)	Frequency (MHz)	Frequency Error (ppm)
-30	1855.000003	0.002	1905.000002	0.001
-20	1855.000003	0.001	1905.000002	0.001
-10	1855.000004	0.002	1905.000003	0.002
0	1855.000003	0.002	1905.000003	0.001
10	1855.000003	0.002	1905.000003	0.001
20	1854.999997	-0.002	1904.999998	-0.001
30	1854.999998	-0.001	1904.999999	-0.001
40	1854.999998	-0.001	1904.999998	-0.001
50	1854.999998	-0.001	1904.999998	-0.001

Frequency Error vs. Voltage

Voltage (Volts)	LTE Band 2			
	Channel Bandwidth: 15 MHz			
	Low Channel		High Channel	
	Frequency (MHz)	Frequency Error (ppm)	Frequency (MHz)	Frequency Error (ppm)
4.25	1857.500002	0.001	1902.500002	0.001
5	1857.500004	0.002	1902.500002	0.001
5.75	1857.500001	0.001	1902.500004	0.002

Note: The applicant defined the normal working voltage is from 4.25Vdc to 5.75Vdc.

Frequency Error vs. Temperature

Temp. (°C)	LTE Band 2			
	Channel Bandwidth: 15 MHz			
	Low Channel		High Channel	
	Frequency (MHz)	Frequency Error (ppm)	Frequency (MHz)	Frequency Error (ppm)
-30	1857.500003	0.001	1902.500002	0.001
-20	1857.500002	0.001	1902.500001	0.001
-10	1857.500004	0.002	1902.500002	0.001
0	1857.500002	0.001	1902.500002	0.001
10	1857.500003	0.002	1902.500003	0.002
20	1857.499998	-0.001	1902.499998	-0.001
30	1857.499996	-0.002	1902.499998	-0.001
40	1857.499996	-0.002	1902.499998	-0.001
50	1857.499998	-0.001	1902.499998	-0.001

Frequency Error vs. Voltage

Voltage (Volts)	LTE Band 2			
	Channel Bandwidth: 20 MHz			
	Low Channel		High Channel	
	Frequency (MHz)	Frequency Error (ppm)	Frequency (MHz)	Frequency Error (ppm)
4.25	1860.000002	0.001	1900.000003	0.002
5	1860.000002	0.001	1900.000001	0.001
5.75	1860.000003	0.002	1900.000004	0.002

Note: The applicant defined the normal working voltage is from 4.25Vdc to 5.75Vdc.

Frequency Error vs. Temperature

Temp. (°C)	LTE Band 2			
	Channel Bandwidth: 20 MHz			
	Low Channel		High Channel	
	Frequency (MHz)	Frequency Error (ppm)	Frequency (MHz)	Frequency Error (ppm)
-30	1860.000001	0.001	1900.000003	0.002
-20	1860.000003	0.002	1900.000002	0.001
-10	1860.000002	0.001	1900.000002	0.001
0	1860.000003	0.001	1900.000003	0.002
10	1860.000001	0.001	1900.000002	0.001
20	1859.999999	-0.001	1899.999999	-0.001
30	1859.999997	-0.002	1899.999997	-0.002
40	1859.999999	-0.001	1899.999996	-0.002
50	1859.999996	-0.002	1899.999998	-0.001

Frequency Error vs. Voltage

Voltage (Volts)	LTE Band 66			
	Channel Bandwidth: 1.4 MHz			
	Low Channel		High Channel	
	Frequency (MHz)	Frequency Error (ppm)	Frequency (MHz)	Frequency Error (ppm)
4.25	1710.700003	0.002	1779.300002	0.001
5	1710.700002	0.001	1779.300003	0.002
5.75	1710.700002	0.001	1779.300003	0.002

Note: The applicant defined the normal working voltage is from 4.25Vdc to 5.75Vdc.

Frequency Error vs. Temperature

Temp. (°C)	LTE Band 66			
	Channel Bandwidth: 1.4 MHz			
	Low Channel		High Channel	
	Frequency (MHz)	Frequency Error (ppm)	Frequency (MHz)	Frequency Error (ppm)
-30	1710.700002	0.001	1779.300001	0.001
-20	1710.700003	0.002	1779.300002	0.001
-10	1710.700004	0.002	1779.300002	0.001
0	1710.700002	0.001	1779.300002	0.001
10	1710.700002	0.001	1779.300001	0.001
20	1710.699997	-0.002	1779.299998	-0.001
30	1710.699997	-0.002	1779.299999	-0.001
40	1710.699998	-0.001	1779.299997	-0.002
50	1710.699999	-0.001	1779.299997	-0.002

Frequency Error vs. Voltage

Voltage (Volts)	LTE Band 66			
	Channel Bandwidth: 3 MHz			
	Low Channel		High Channel	
	Frequency (MHz)	Frequency Error (ppm)	Frequency (MHz)	Frequency Error (ppm)
4.25	1711.500004	0.002	1778.500001	0.001
5	1711.500004	0.002	1778.500001	0.001
5.75	1711.500002	0.001	1778.500004	0.002

Note: The applicant defined the normal working voltage is from 4.25Vdc to 5.75Vdc.

Frequency Error vs. Temperature

Temp. (°C)	LTE Band 66			
	Channel Bandwidth: 3 MHz			
	Low Channel		High Channel	
	Frequency (MHz)	Frequency Error (ppm)	Frequency (MHz)	Frequency Error (ppm)
-30	1711.500002	0.001	1778.500001	0.001
-20	1711.500002	0.001	1778.500001	0.001
-10	1711.500002	0.001	1778.500003	0.002
0	1711.500004	0.002	1778.500004	0.002
10	1711.500002	0.001	1778.500004	0.002
20	1711.499998	-0.001	1778.499998	-0.001
30	1711.499997	-0.002	1778.499998	-0.001
40	1711.499997	-0.002	1778.499998	-0.001
50	1711.499999	-0.001	1778.499999	-0.001

Frequency Error vs. Voltage

Voltage (Volts)	LTE Band 66			
	Channel Bandwidth: 5 MHz			
	Low Channel		High Channel	
	Frequency (MHz)	Frequency Error (ppm)	Frequency (MHz)	Frequency Error (ppm)
4.25	1712.500003	0.002	1777.500003	0.002
5	1712.500003	0.002	1777.500004	0.002
5.75	1712.500003	0.002	1777.500002	0.001

Note: The applicant defined the normal working voltage is from 4.25Vdc to 5.75Vdc.

Frequency Error vs. Temperature

Temp. (°C)	LTE Band 66			
	Channel Bandwidth: 5 MHz			
	Low Channel		High Channel	
	Frequency (MHz)	Frequency Error (ppm)	Frequency (MHz)	Frequency Error (ppm)
-30	1712.500004	0.002	1777.500003	0.002
-20	1712.500002	0.001	1777.500002	0.001
-10	1712.500001	0.001	1777.500001	0.001
0	1712.500001	0.001	1777.500004	0.002
10	1712.500001	0.001	1777.500003	0.001
20	1712.499998	-0.001	1777.499999	-0.001
30	1712.499996	-0.002	1777.499998	-0.001
40	1712.499996	-0.002	1777.499996	-0.002
50	1712.499997	-0.002	1777.499997	-0.002

Frequency Error vs. Voltage

Voltage (Volts)	LTE Band 66			
	Channel Bandwidth: 10 MHz			
	Low Channel		High Channel	
	Frequency (MHz)	Frequency Error (ppm)	Frequency (MHz)	Frequency Error (ppm)
4.25	1715.000002	0.001	1775.000003	0.002
5	1715.000003	0.002	1775.000001	0.001
5.75	1715.000004	0.002	1775.000004	0.002

Note: The applicant defined the normal working voltage is from 4.25Vdc to 5.75Vdc.

Frequency Error vs. Temperature

Temp. (°C)	LTE Band 66			
	Channel Bandwidth: 10 MHz			
	Low Channel		High Channel	
	Frequency (MHz)	Frequency Error (ppm)	Frequency (MHz)	Frequency Error (ppm)
-30	1715.000002	0.001	1775.000002	0.001
-20	1715.000001	0.001	1775.000001	0.001
-10	1715.000004	0.002	1775.000001	0.001
0	1715.000003	0.002	1775.000003	0.002
10	1715.000003	0.002	1775.000003	0.001
20	1714.999998	-0.001	1774.999996	-0.002
30	1714.999998	-0.001	1774.999998	-0.001
40	1714.999998	-0.001	1774.999998	-0.001
50	1714.999997	-0.002	1774.999996	-0.002

Frequency Error vs. Voltage

Voltage (Volts)	LTE Band 66			
	Channel Bandwidth: 15 MHz			
	Low Channel		High Channel	
	Frequency (MHz)	Frequency Error (ppm)	Frequency (MHz)	Frequency Error (ppm)
4.25	1717.500001	0.001	1772.500004	0.002
5	1717.500004	0.002	1772.500003	0.002
5.75	1717.500001	0.001	1772.500002	0.001

Note: The applicant defined the normal working voltage is from 4.25Vdc to 5.75Vdc.

Frequency Error vs. Temperature

Temp. (°C)	LTE Band 66			
	Channel Bandwidth: 15 MHz			
	Low Channel		High Channel	
	Frequency (MHz)	Frequency Error (ppm)	Frequency (MHz)	Frequency Error (ppm)
-30	1717.500003	0.002	1772.500004	0.002
-20	1717.500002	0.001	1772.500004	0.002
-10	1717.500003	0.002	1772.500002	0.001
0	1717.500001	0.001	1772.500003	0.002
10	1717.500004	0.002	1772.500003	0.002
20	1717.499998	-0.001	1772.499997	-0.002
30	1717.499998	-0.001	1772.499997	-0.002
40	1717.499999	-0.001	1772.499997	-0.002
50	1717.499997	-0.002	1772.499999	-0.001

Frequency Error vs. Voltage

Voltage (Volts)	LTE Band 66			
	Channel Bandwidth: 20 MHz			
	Low Channel		High Channel	
	Frequency (MHz)	Frequency Error (ppm)	Frequency (MHz)	Frequency Error (ppm)
4.25	1720.000003	0.002	1770.000003	0.002
5	1720.000002	0.001	1770.000003	0.001
5.75	1720.000004	0.002	1770.000001	0.001

Note: The applicant defined the normal working voltage is from 4.25Vdc to 5.75Vdc.

Frequency Error vs. Temperature

Temp. (°C)	LTE Band 66			
	Channel Bandwidth: 20 MHz			
	Low Channel		High Channel	
	Frequency (MHz)	Frequency Error (ppm)	Frequency (MHz)	Frequency Error (ppm)
-30	1720.000003	0.002	1770.000002	0.001
-20	1720.000004	0.002	1770.000004	0.002
-10	1720.000002	0.001	1770.000003	0.001
0	1720.000002	0.001	1770.000003	0.002
10	1720.000001	0.001	1770.000001	0.001
20	1719.999996	-0.002	1769.999999	-0.001
30	1719.999998	-0.001	1769.999998	-0.001
40	1719.999998	-0.001	1769.999996	-0.002
50	1719.999997	-0.002	1769.999998	-0.001

4.4 Occupied Bandwidth Measurement

4.4.1 Test Procedure

For n12:

The occupied bandwidth (OBW), that is the frequency bandwidth such that, below its lower and above its upper frequency limits, the mean powers radiated are each equal to 0.5 % of the total mean power radiated by a given emission.

For LTB Band 2:

The EUT makes a call to the communication simulator. All measurements were done at low, middle and high operational frequency range. The communication simulator station system controlled a EUT to export maximum output power under transmission mode and specific channel frequency. Use OBW measurement function of Spectrum analyzer to measure 99 % occupied bandwidth.

For LTB Band 66:

The occupied bandwidth (OBW), that is the frequency bandwidth such that, below its lower and above its upper frequency limits, the mean powers radiated are each equal to 0.5 % of the total mean power radiated by a given emission.

4.4.2 Test Setup

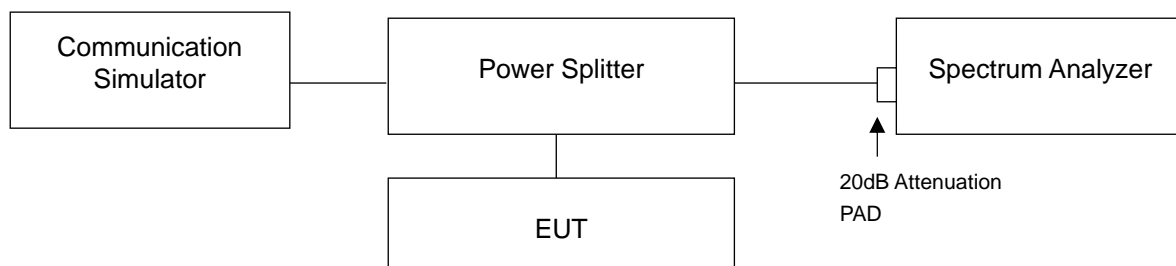

4.4.3 Test Result

Occupied Bandwidth

n12

n12, Channel Bandwidth 5MHz						
Channel	Frequency (MHz)	99% Occupied Bandwidth (MHz)				
		$\pi/2$ BPSK	QPSK	16QAM	64QAM	256QAM
140300	701.5	4.4857	4.4859	4.4893	4.4896	4.4845
141500	707.5	4.4858	4.4833	4.4847	4.4864	4.4868
142700	713.5	4.4841	4.4873	4.4880	4.4873	4.4842
n12, Channel Bandwidth 10MHz						
Channel	Frequency (MHz)	99% Occupied Bandwidth (MHz)				
		$\pi/2$ BPSK	QPSK	16QAM	64QAM	256QAM
140800	704.0	8.9589	8.9572	8.9609	8.9535	8.9613
141500	707.5	8.9477	8.9492	8.9570	8.9475	8.9564
142200	711.0	8.9480	8.9492	8.9508	8.9424	8.9492
n12, Channel Bandwidth 15MHz						
Channel	Frequency (MHz)	99% Occupied Bandwidth (MHz)				
		$\pi/2$ BPSK	QPSK	16QAM	64QAM	256QAM
141300	706.5	13.445	13.444	13.435	13.428	13.435
141500	707.5	13.449	13.451	13.437	13.433	13.442
141700	708.5	13.455	13.447	13.442	13.437	13.446

Spectrum Plot of Worst Value

5MHz / 64QAM



10MHz / 256QAM



15MHz / $\pi/2$ BPSK

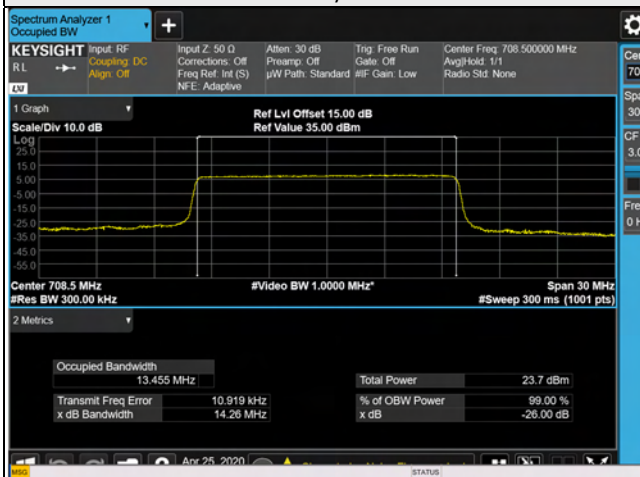

LTE Band 2

LTE Band 2, Channel Bandwidth 1.4MHz		
Channel	Frequency (MHz)	99% Occupied Bandwidth (MHz)
		256QAM
18607	1850.7	1.09
18900	1880.0	1.09
19193	1909.3	1.09
LTE Band 2, Channel Bandwidth 3MHz		
Channel	Frequency (MHz)	99% Occupied Bandwidth (MHz)
		256QAM
18615	1851.5	2.70
18900	1880.0	2.70
19185	1908.5	2.70
LTE Band 2, Channel Bandwidth 5MHz		
Channel	Frequency (MHz)	99% Occupied Bandwidth (MHz)
		256QAM
18625	1852.5	4.48
18900	1880.0	4.48
19175	1907.5	4.49
LTE Band 2, Channel Bandwidth 10MHz		
Channel	Frequency (MHz)	99% Occupied Bandwidth (MHz)
		256QAM
18650	1855.0	8.95
18900	1880.0	8.96
19150	1905.0	8.96
LTE Band 2, Channel Bandwidth 15MHz		
Channel	Frequency (MHz)	99% Occupied Bandwidth (MHz)
		256QAM
18675	1857.5	13.43
18900	1880.0	13.44
19125	1902.5	13.47

LTE Band 2, Channel Bandwidth 20MHz

Channel	Frequency (MHz)	99% Occupied Bandwidth (MHz)
		256QAM
18700	1860.0	17.92
18900	1880.0	17.93
19100	1900.0	17.99

Spectrum Plot of Worst Value

1.4MHz / 256QAM



3MHz / 256QAM



5MHz / 256QAM



10MHz / 256QAM



15MHz / 256QAM



20MHz / 256QAM



LTE Band 66

LTE Band 66, Channel Bandwidth 1.4MHz		
Channel	Frequency (MHz)	99% Occupied Bandwidth (MHz)
		256QAM
131979	1710.7	1.09
132322	1745.0	1.09
132665	1779.3	1.09
LTE Band 66, Channel Bandwidth 3MHz		
Channel	Frequency (MHz)	99% Occupied Bandwidth (MHz)
		256QAM
131987	1711.5	2.70
132322	1745.0	2.70
132657	1778.5	2.70
LTE Band 66, Channel Bandwidth 5MHz		
Channel	Frequency (MHz)	99% Occupied Bandwidth (MHz)
		256QAM
131997	1712.5	4.49
132322	1745.0	4.49
132647	1777.5	4.48
LTE Band 66, Channel Bandwidth 10MHz		
Channel	Frequency (MHz)	99% Occupied Bandwidth (MHz)
		256QAM
132022	1715.0	8.96
132322	1745.0	8.96
132622	1775.0	8.97
LTE Band 66, Channel Bandwidth 15MHz		
Channel	Frequency (MHz)	99% Occupied Bandwidth (MHz)
		256QAM
132047	1717.5	13.45
132322	1745.0	13.47
132597	1772.5	13.49

LTE Band 66, Channel Bandwidth 20MHz

Channel	Frequency (MHz)	99% Occupied Bandwidth (MHz)
		256QAM
132072	1720.0	17.92
132322	1745.0	17.99
132572	1770.0	18.00

Spectrum Plot of Worst Value

1.4MHz / 256QAM



3MHz / 256QAM



5MHz / 256QAM



10MHz / 256QAM

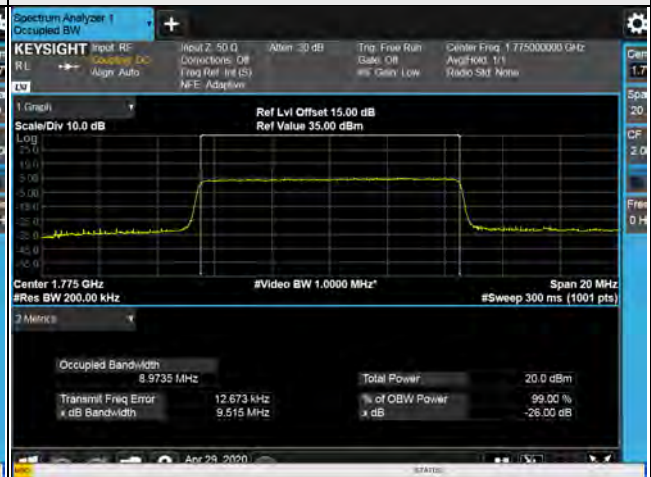

15MHz / 256QAM



20MHz / 256QAM

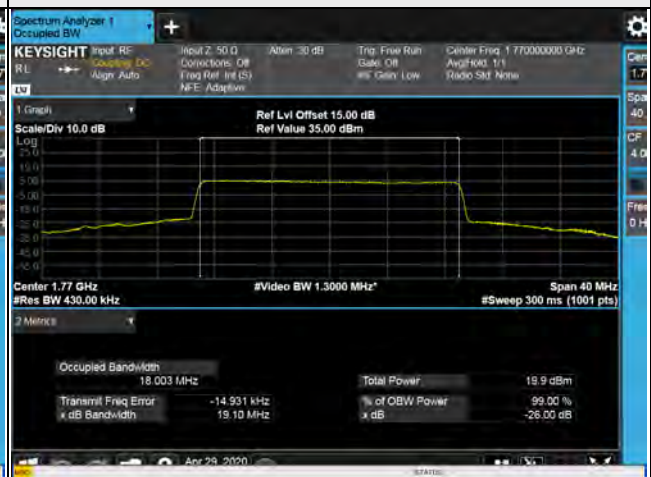

26dB Bandwidth

n12

n12, Channel Bandwidth 5MHz						
Channel	Frequency (MHz)	26dB Bandwidth (MHz)				
		$\pi/2$ BPSK	QPSK	16QAM	64QAM	256QAM
140300	701.5	4.785	4.805	4.794	4.801	4.795
141500	707.5	4.795	4.782	4.807	4.795	4.787
142700	713.5	4.783	4.804	4.802	4.795	4.802
n12, Channel Bandwidth 10MHz						
Channel	Frequency (MHz)	26dB Bandwidth (MHz)				
		$\pi/2$ BPSK	QPSK	16QAM	64QAM	256QAM
140800	704.0	9.506	9.515	9.515	9.496	9.517
141500	707.5	9.499	9.499	9.503	9.495	9.504
142200	711.0	9.501	9.499	9.496	9.514	9.506
n12, Channel Bandwidth 15MHz						
Channel	Frequency (MHz)	26dB Bandwidth (MHz)				
		$\pi/2$ BPSK	QPSK	16QAM	64QAM	256QAM
141300	706.5	14.26	14.23	14.23	14.23	14.24
141500	707.5	14.24	14.25	14.24	14.24	14.25
141700	708.5	14.26	14.26	14.26	14.23	14.26

Spectrum Plot of Worst Value

5MHz / 16QAM



10MHz / 256QAM



15MHz / $\pi/2$ BPSK

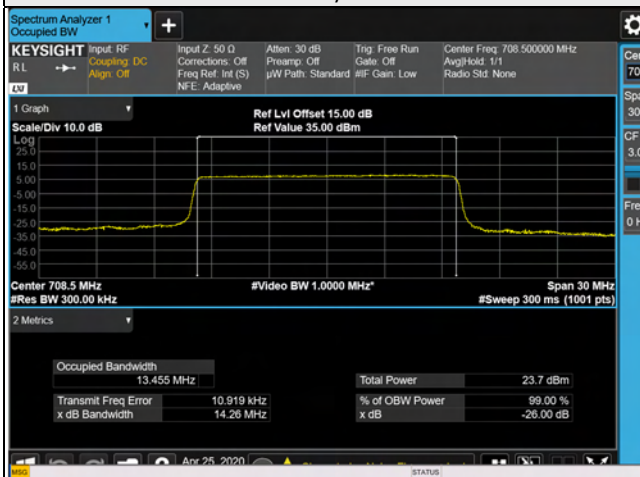

LTE Band 2

LTE Band 2, Channel Bandwidth 1.4MHz		
Channel	Frequency (MHz)	26dBc Bandwidth (MHz)
		256QAM
18607	1850.7	1.21
18900	1880.0	1.21
19193	1909.3	1.21
LTE Band 2, Channel Bandwidth 3MHz		
Channel	Frequency (MHz)	26dBc Bandwidth (MHz)
		256QAM
18615	1851.5	2.91
18900	1880.0	2.92
19185	1908.5	2.91
LTE Band 2, Channel Bandwidth 5MHz		
Channel	Frequency (MHz)	26dBc Bandwidth (MHz)
		256QAM
18625	1852.5	4.80
18900	1880.0	4.80
19175	1907.5	4.81
LTE Band 2, Channel Bandwidth 10MHz		
Channel	Frequency (MHz)	26dBc Bandwidth (MHz)
		256QAM
18650	1855.0	9.50
18900	1880.0	9.50
19150	1905.0	9.51
LTE Band 2, Channel Bandwidth 15MHz		
Channel	Frequency (MHz)	26dBc Bandwidth (MHz)
		256QAM
18675	1857.5	14.22
18900	1880.0	14.21
19125	1902.5	14.26

LTE Band 2, Channel Bandwidth 20MHz

Channel	Frequency (MHz)	26dBc Bandwidth (MHz)
		256QAM
18700	1860.0	19.02
18900	1880.0	19.01
19100	1900.0	19.08

Spectrum Plot of Worst Value

1.4MHz / 256QAM

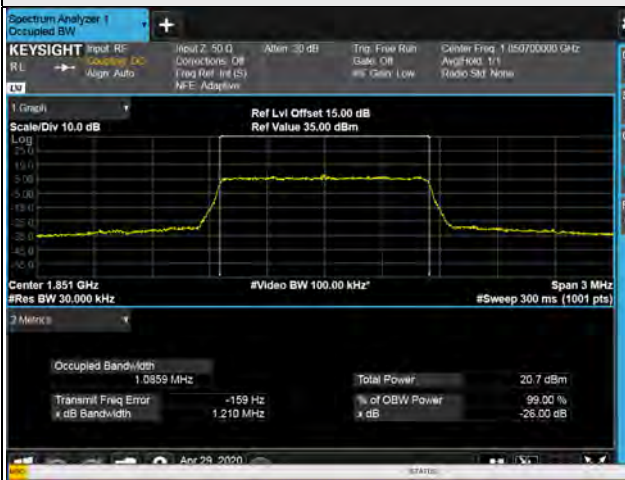

3MHz / 256QAM



5MHz / 256QAM



10MHz / 256QAM



15MHz / 256QAM



20MHz / 256QAM



LTE Band 66

LTE Band 66, Channel Bandwidth 1.4MHz		
Channel	Frequency (MHz)	26dB Bandwidth (MHz)
		256QAM
131979	1710.7	1.21
132322	1745.0	1.22
132665	1779.3	1.21
LTE Band 66, Channel Bandwidth 3MHz		
Channel	Frequency (MHz)	26dB Bandwidth (MHz)
		256QAM
131987	1711.5	2.92
132322	1745.0	2.90
132657	1778.5	2.91
LTE Band 66, Channel Bandwidth 5MHz		
Channel	Frequency (MHz)	26dB Bandwidth (MHz)
		256QAM
131997	1712.5	4.82
132322	1745.0	4.81
132647	1777.5	4.81
LTE Band 66, Channel Bandwidth 10MHz		
Channel	Frequency (MHz)	26dB Bandwidth (MHz)
		256QAM
132022	1715.0	9.51
132322	1745.0	9.51
132622	1775.0	9.52
LTE Band 66, Channel Bandwidth 15MHz		
Channel	Frequency (MHz)	26dB Bandwidth (MHz)
		256QAM
132047	1717.5	14.24
132322	1745.0	14.25
132597	1772.5	14.29

LTE Band 66, Channel Bandwidth 20MHz

Channel	Frequency (MHz)	26dB Bandwidth (MHz)
		256QAM
132072	1720.0	18.99
132322	1745.0	19.06
132572	1770.0	19.10

Spectrum Plot of Worst Value

1.4MHz / 256QAM



3MHz / 256QAM



5MHz / 256QAM

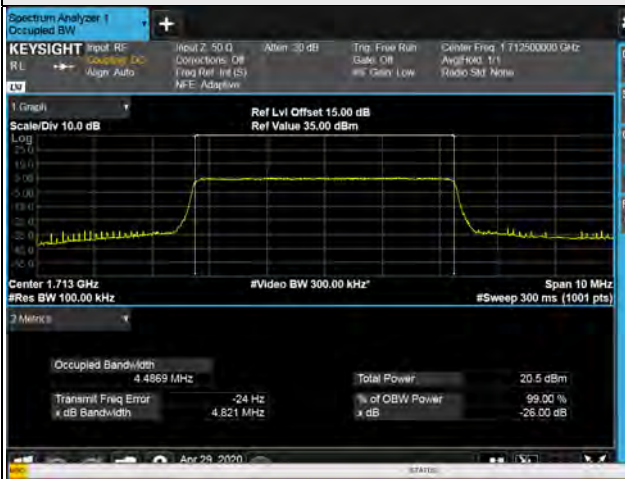

10MHz / 256QAM



15MHz / 256QAM



20MHz / 256QAM



4.5 Band Edge Measurement

4.5.1 Limits of Band Edge Measurement

For n12

According to FCC 27.53(g) for operations in the 600 MHz band and the 698-746 MHz band, the power of any emission outside a licensee's frequency band(s) of operation shall be attenuated below the transmitter power (P) within the licensed band(s) of operation, measured in watts, by at least $43 + 10 \log(P)$ dB. Compliance with this provision is based on the use of measurement instrumentation employing a resolution bandwidth of 100 kilohertz or greater.

For LTE Band 2

Power of any emission outside of the authorized operating frequency ranges must be attenuated below the transmitting power (P) by a factor of at least $43 + 10 \log(P)$ dB. In the 1 MHz bands immediately outside and adjacent to the frequency block a resolution bandwidth of at least one percent of the emission bandwidth of the fundamental emission of the transmitter may be employed.

For LTE Band 66

According to FCC 27.53(h) for operations in the 1695-1710 MHz, 1710-1755 MHz, 1755-1780 MHz, 1915-1920 MHz, 1995-2000 MHz, 2000-2020 MHz, 2110-2155 MHz, 2155-2180 MHz, and 2180-2200 bands, the power of any emission outside a licensee's frequency block shall be attenuated below the transmitter power (P) in watts by at least $43 + 10 \log(P)$ dB.

4.5.2 Test Setup

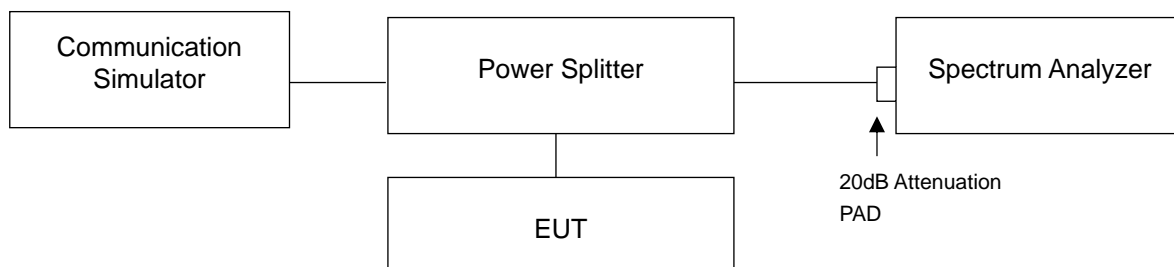

4.5.3 Test Procedures

- All measurements were done at low and high operational frequency range.
- The center frequency of spectrum is the band edge frequency and span is 1MHz. RB of the spectrum is 15kHz and VB of the spectrum is 51kHz (LTE Channel Bandwidth 1.4MHz).
- The center frequency of spectrum is the band edge frequency and span is 1MHz. RB of the spectrum is 30kHz and VB of the spectrum is 100kHz (LTE Channel Bandwidth 3MHz).
- The center frequency of spectrum is the band edge frequency and span is 1MHz. RB of the spectrum is 51kHz and VB of the spectrum is 160kHz (Channel Bandwidth 5MHz).
- The center frequency of spectrum is the band edge frequency and span is 1MHz. RB of the spectrum is 100kHz and VB of the spectrum is 300kHz (Channel Bandwidth 10MHz).
- The center frequency of spectrum is the band edge frequency and span is 1MHz. RB of the spectrum is 150kHz and VB of the spectrum is 470kHz (Channel Bandwidth 15MHz).
- The center frequency of spectrum is the band edge frequency and span is 1MHz. RB of the spectrum is 200kHz and VB of the spectrum is 1MHz (Channel Bandwidth 20MHz).
- Record the max trace plot into the test report.

4.5.4 Test Results

n12

Band edge:

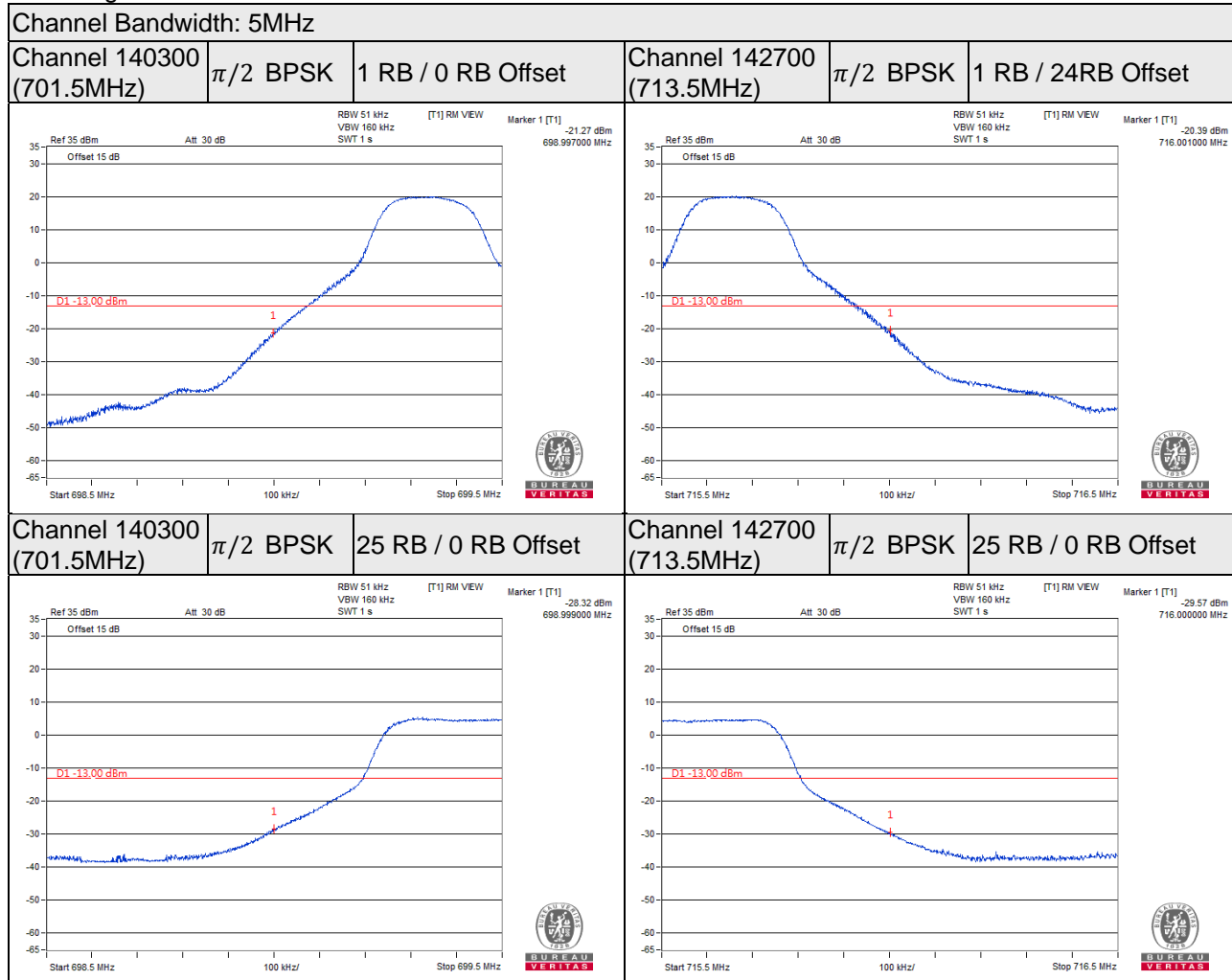

Channel Bandwidth: 10MHz

Channel 140800
(704MHz)

$\pi/2$ BPSK

1 RB / 0 RB Offset

Channel 142200
(711MHz)

$\pi/2$ BPSK

1 RB / 51RB Offset

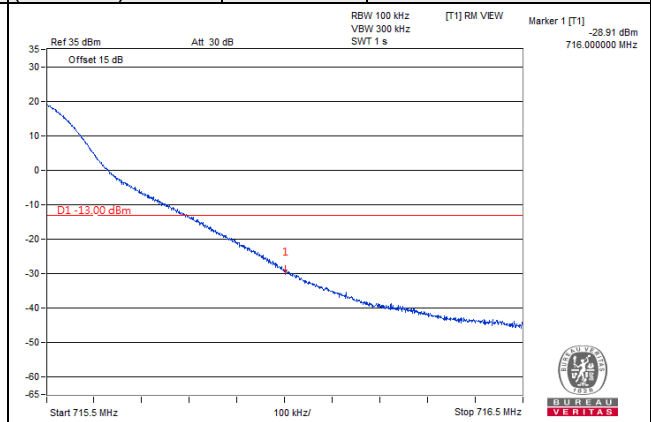
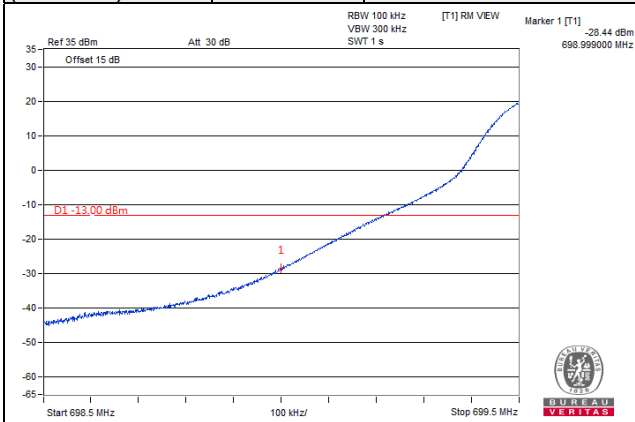

Channel 140800
(704MHz)

$\pi/2$ BPSK

52 RB / 0 RB Offset

Channel 142200
(711MHz)

$\pi/2$ BPSK

52 RB / 0 RB Offset

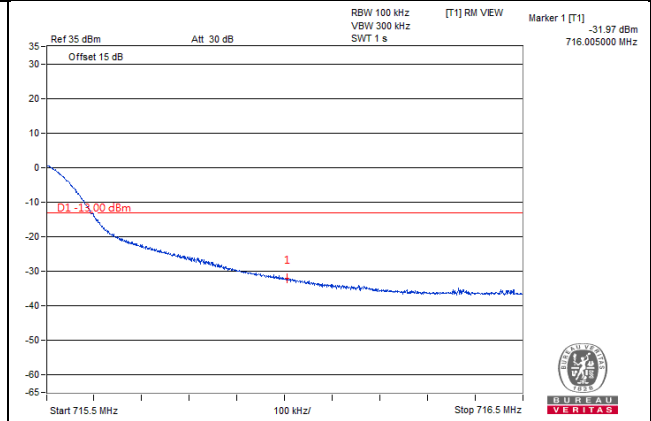
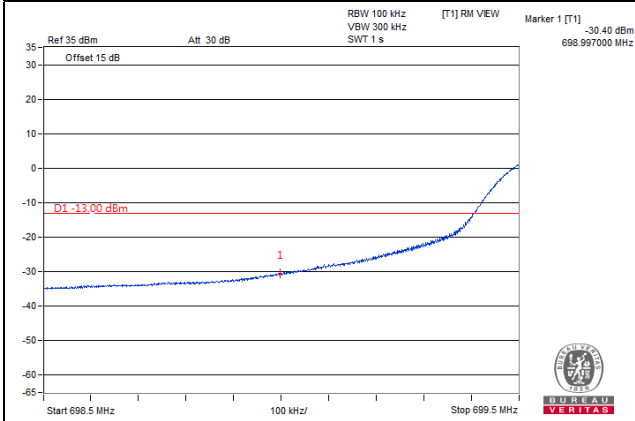

Channel Bandwidth: 15MHz

Channel 141300
(706.5MHz)

$\pi/2$ BPSK

1 RB / 0 RB Offset

Channel 141700
(708.5MHz)

$\pi/2$ BPSK

1 RB / 78 RB Offset

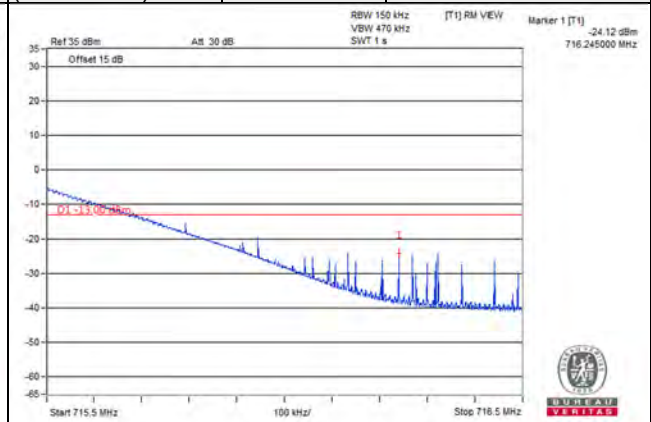
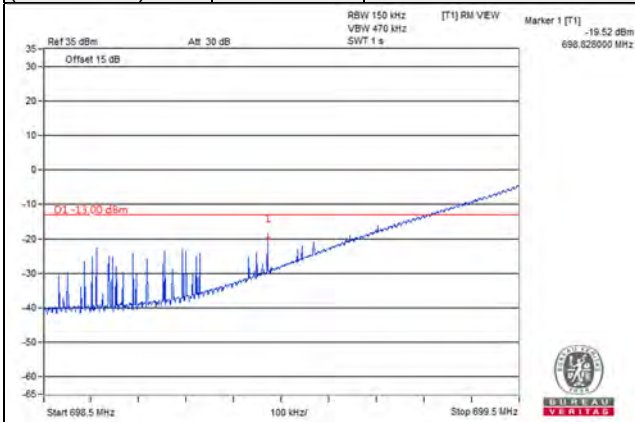

Channel 141300
(706.5MHz)

$\pi/2$ BPSK

79 RB / 0 RB Offset

Channel 141700
(708.5MHz)

$\pi/2$ BPSK

79 RB / 0 RB Offset

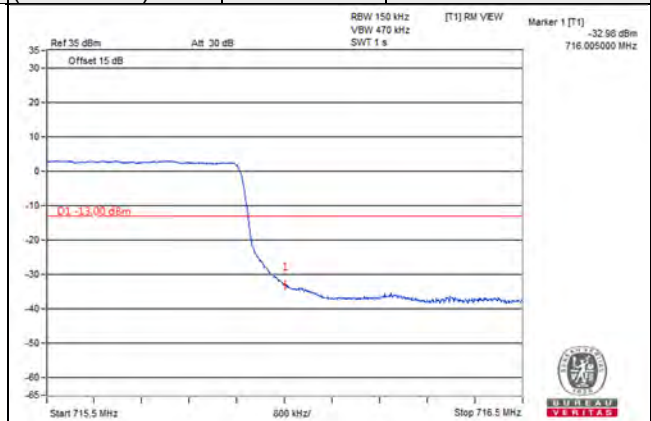
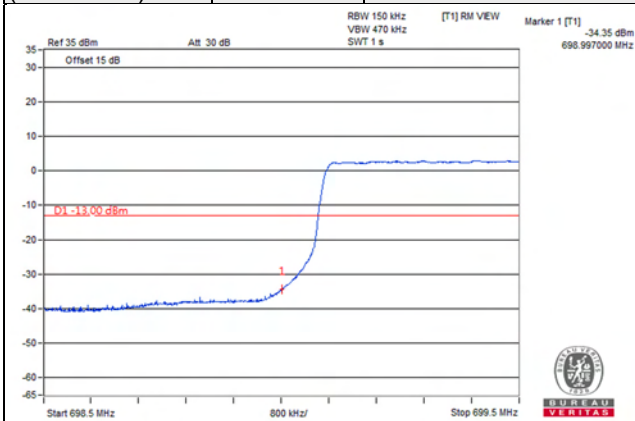

LTE Band 2

Channel Bandwidth 1.4MHz

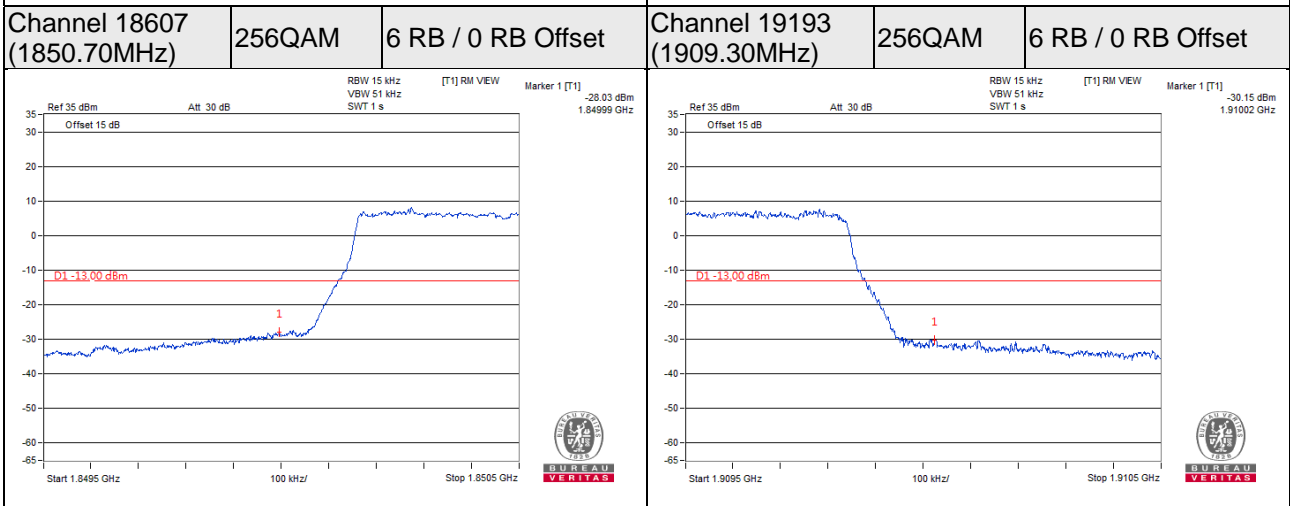
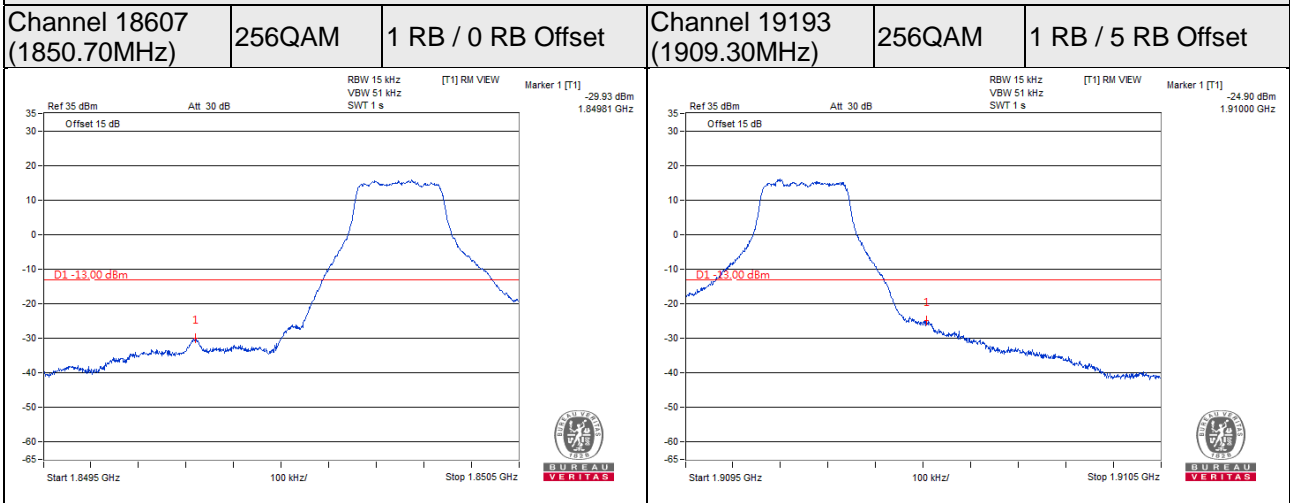

Channel Bandwidth 3MHz

**Channel 18615
(1851.50MHz)**

256QAM

1 RB / 0 RB Offset

**Channel 19185
(1908.50MHz)**

256QAM

1 RB / 14 RB Offset

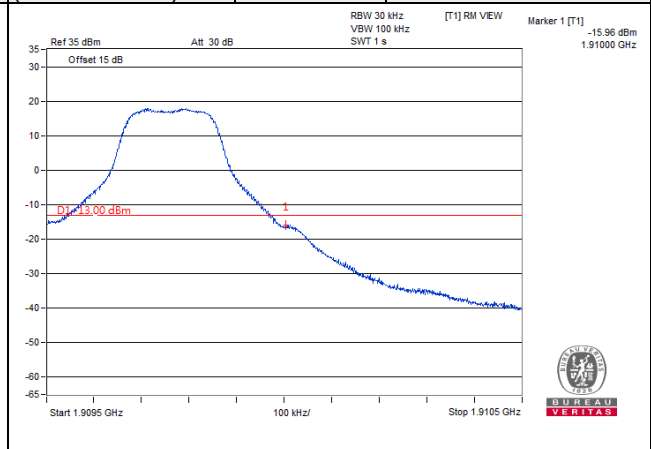
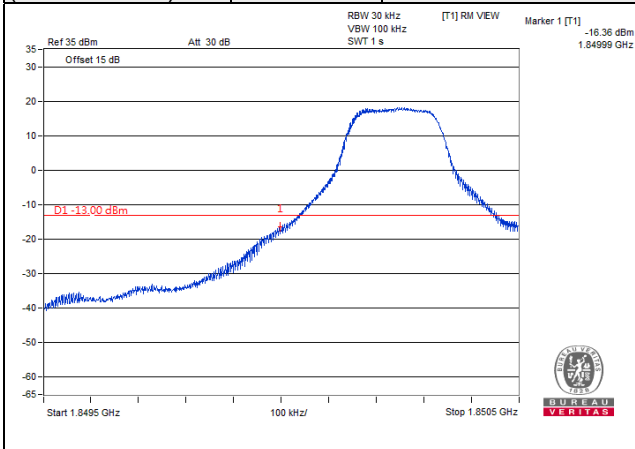

**Channel 18615
(1851.50MHz)**

256QAM

15 RB / 0 RB Offset

**Channel 19185
(1908.50MHz)**

256QAM

15 RB / 0 RB Offset

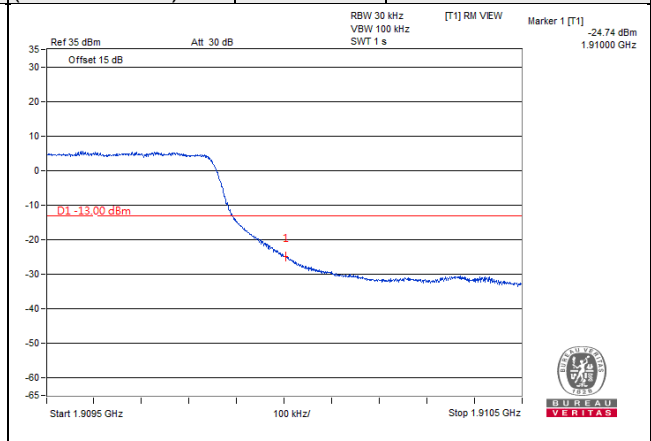
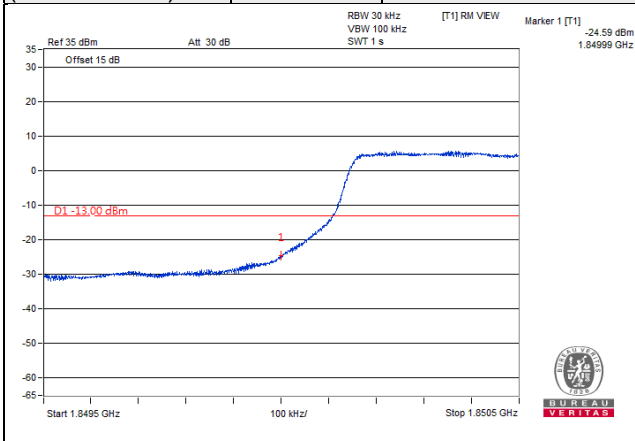

Channel Bandwidth 5MHz

**Channel 18625
(1852.50MHz)**

256QAM

1 RB / 0 RB Offset

**Channel 19175
(1907.50MHz)**

256QAM

1 RB / 24 RB Offset

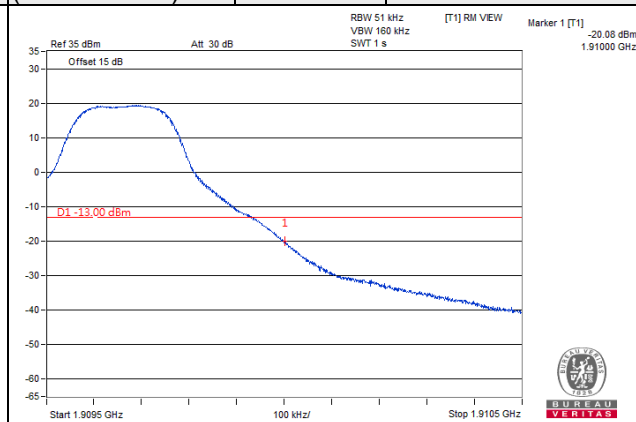
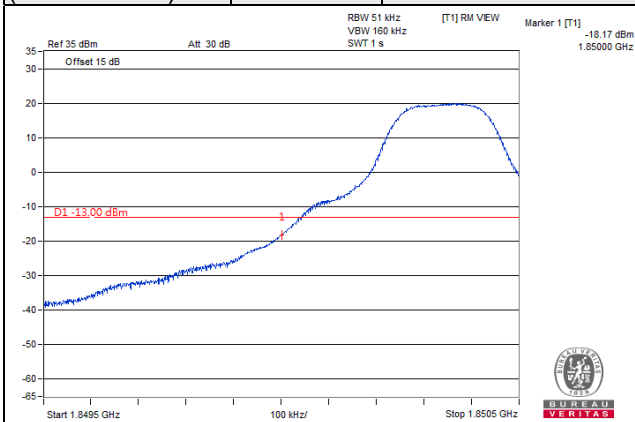

**Channel 18625
(1852.50MHz)**

256QAM

25 RB / 0 RB Offset

**Channel 19175
(1907.50MHz)**

256QAM

25 RB / 0 RB Offset

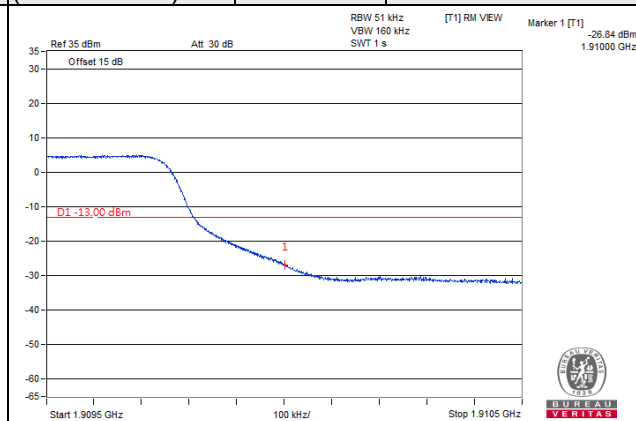
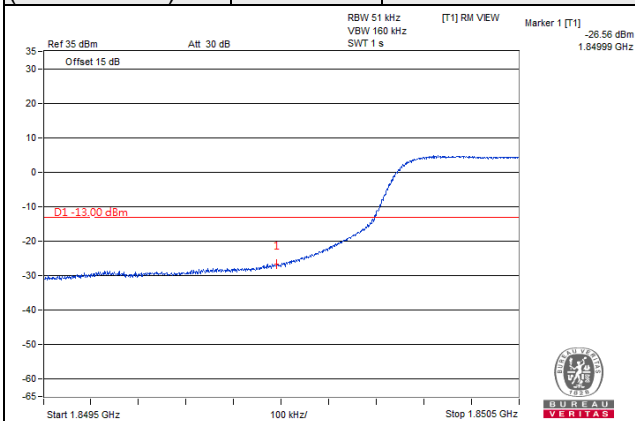

Channel Bandwidth 10MHz

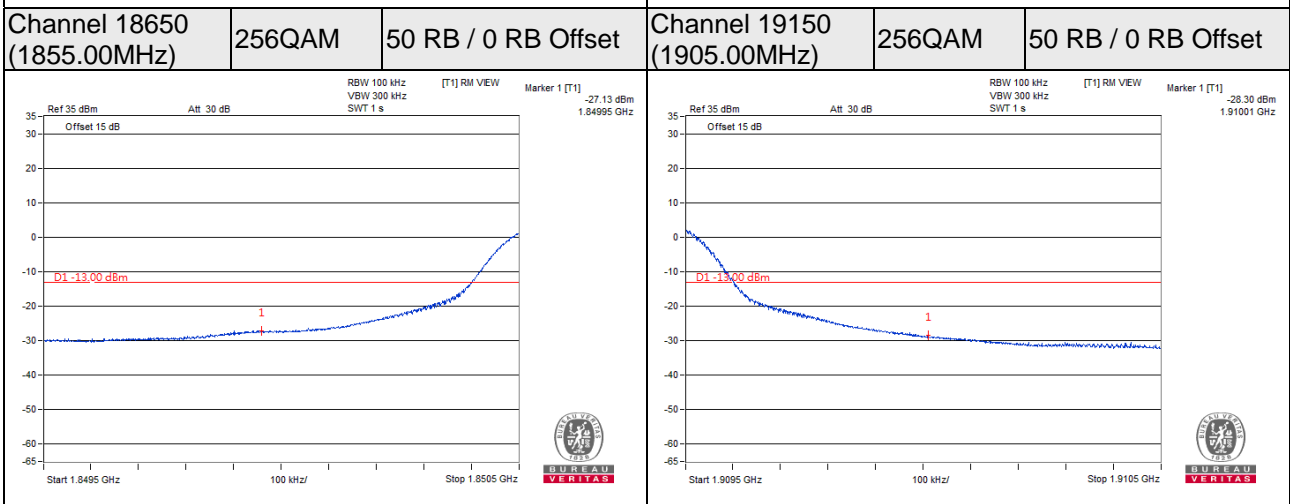
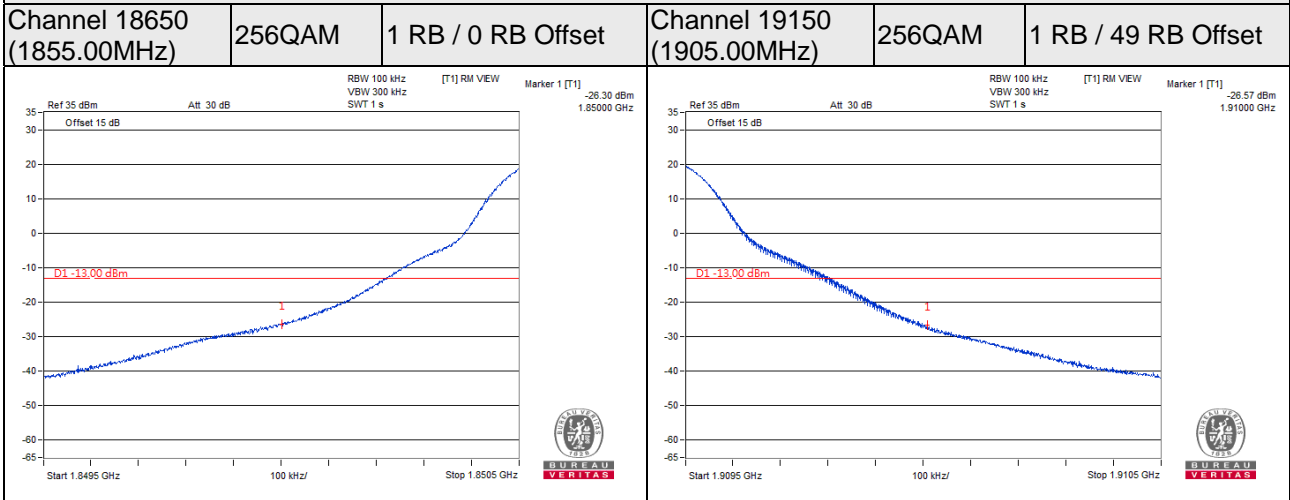

Channel Bandwidth 15MHz

**Channel 18675
(1857.50MHz)**

256QAM

1 RB / 0 RB Offset

**Channel 19125
(1902.50MHz)**

256QAM

1 RB / 74 RB Offset

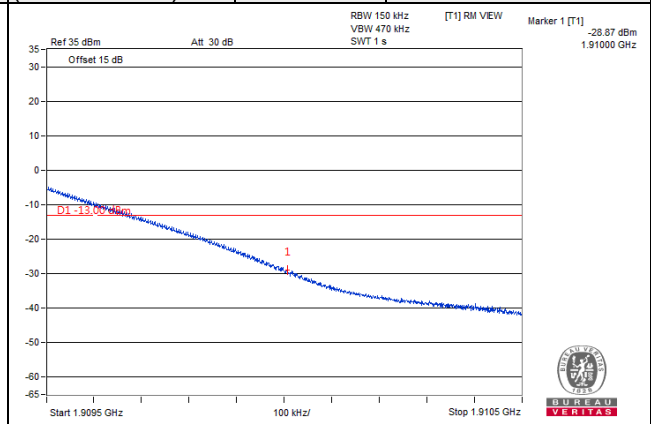
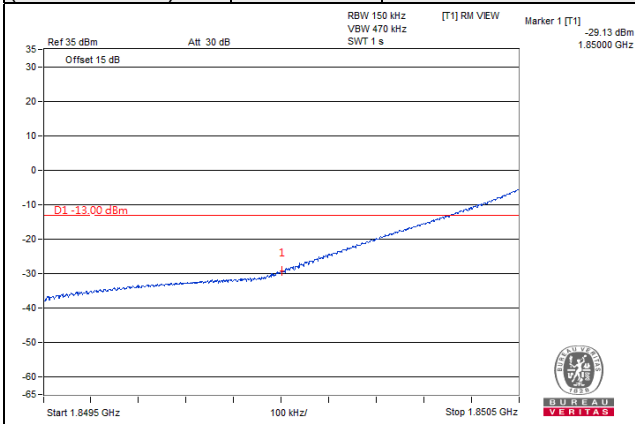

**Channel 18675
(1857.50MHz)**

256QAM

75 RB / 0 RB Offset

**Channel 19125
(1902.50MHz)**

256QAM

75 RB / 0 RB Offset

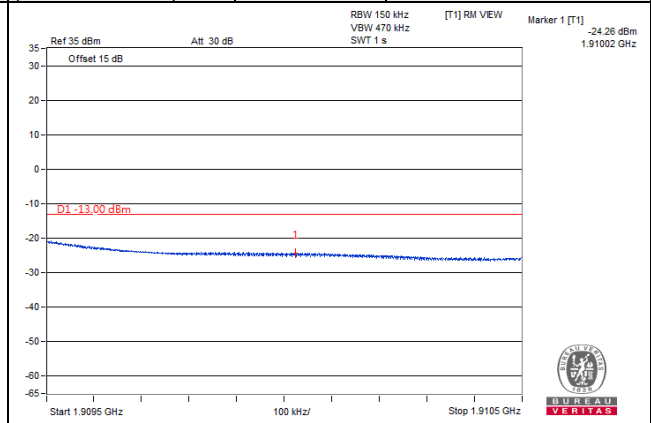
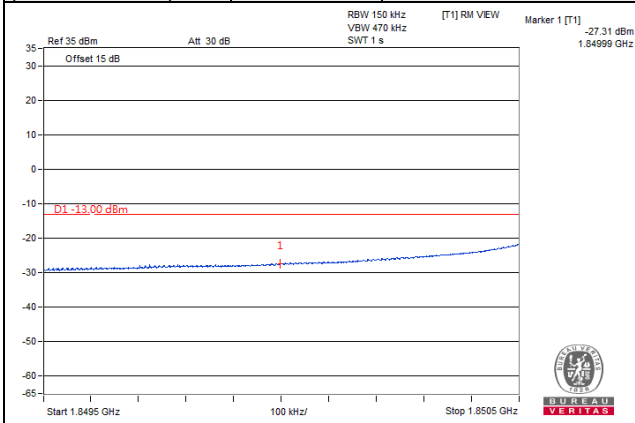

Channel Bandwidth 20MHz

**Channel 18700
(1860.00MHz)**

256QAM

1 RB / 0 RB Offset

**Channel 19100
(1900.00 MHz)**

256QAM

1 RB / 99 RB Offset

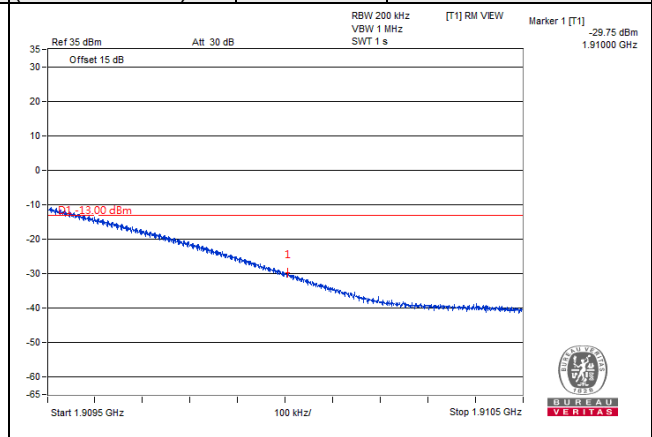
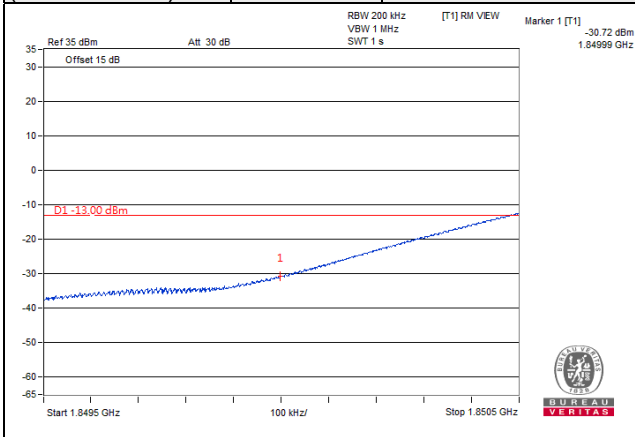

**Channel 18700
(1860.00MHz)**

256QAM

100 RB / 0 RB Offset

**Channel 19100
(1900.00 MHz)**

256QAM

100 RB / 0 RB Offset

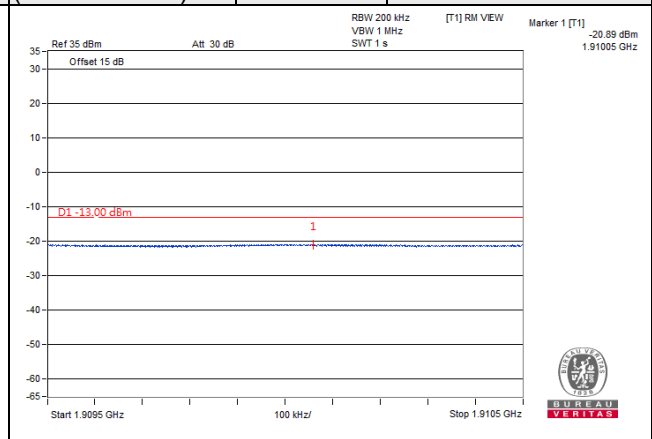
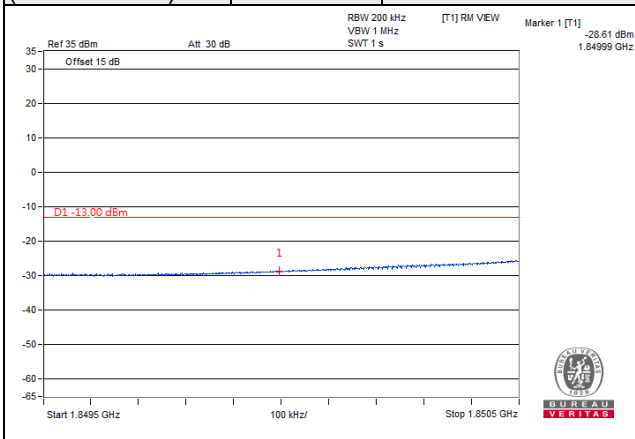

LTE Band 66

Channel Bandwidth: 1.4MHz

Channel 131979 (1710.7MHz)	256QAM	1 RB / 0 RB Offset	Channel 132665 (1779.3MHz)	256QAM	1 RB / 5 RB Offset
-------------------------------	--------	--------------------	-------------------------------	--------	--------------------

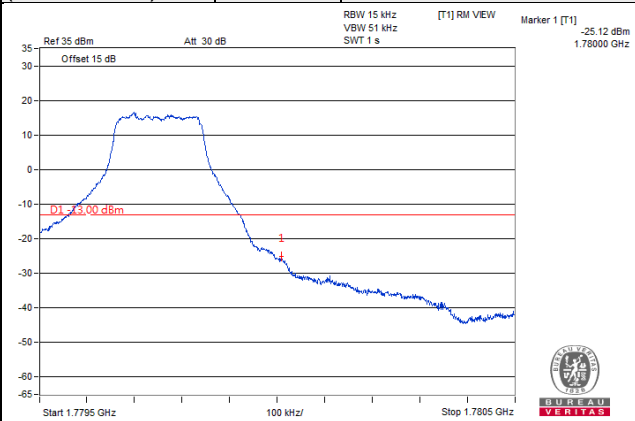
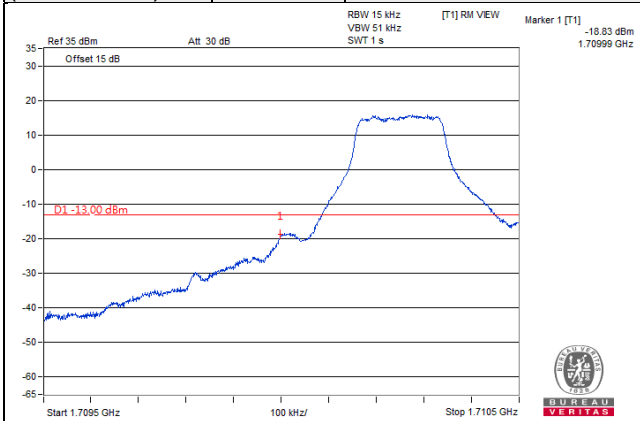

Channel 131979 (1710.7MHz)	256QAM	6 RB / 0 RB Offset	Channel 132665 (1779.3MHz)	256QAM	6 RB / 0 RB Offset
-------------------------------	--------	--------------------	-------------------------------	--------	--------------------

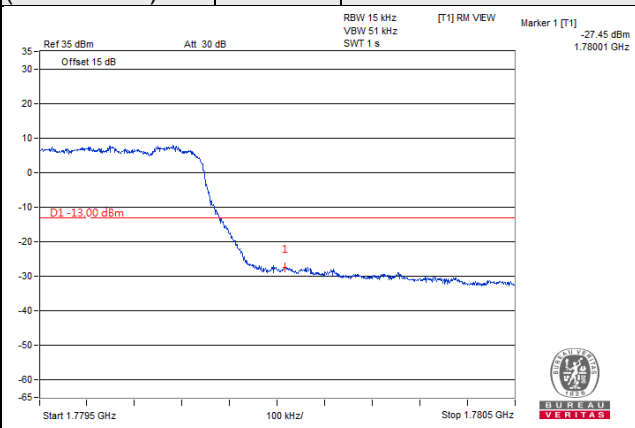
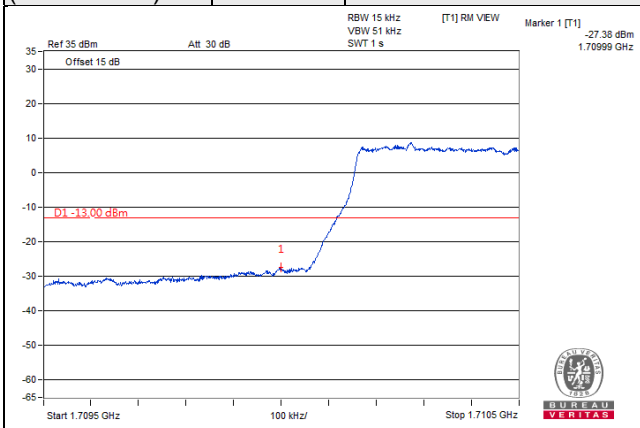

Channel Bandwidth: 3MHz

Channel 131987 (1711.5MHz)	256QAM	1 RB / 0 RB Offset	Channel 132657 (1778.5MHz)	256QAM	1 RB / 14 RB Offset
---------------------------------------	---------------	---------------------------	---------------------------------------	---------------	----------------------------

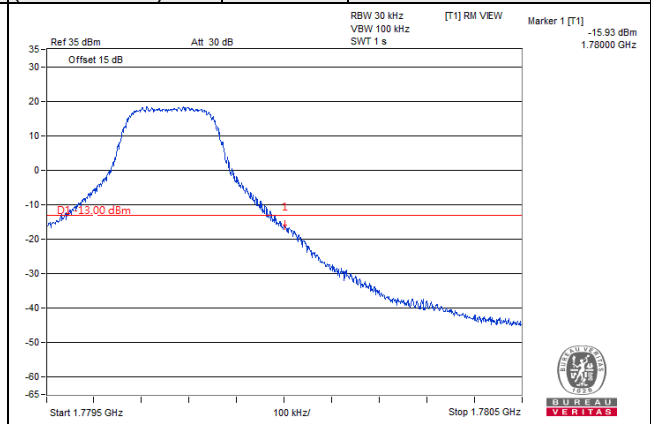
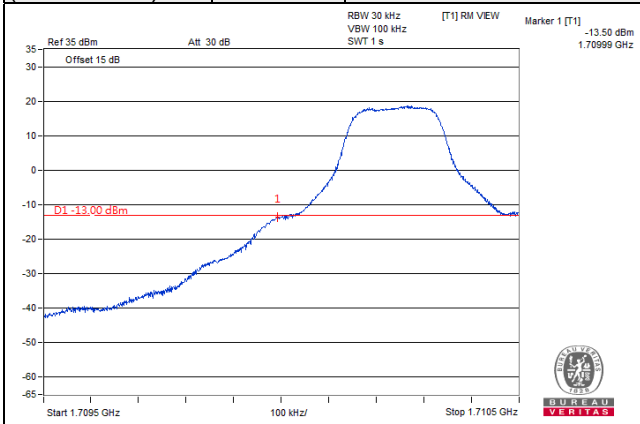

Channel 131987 (1711.5MHz)	256QAM	15 RB / 0 RB Offset	Channel 132657 (1778.5MHz)	256QAM	15 RB / 0 RB Offset
---------------------------------------	---------------	----------------------------	---------------------------------------	---------------	----------------------------

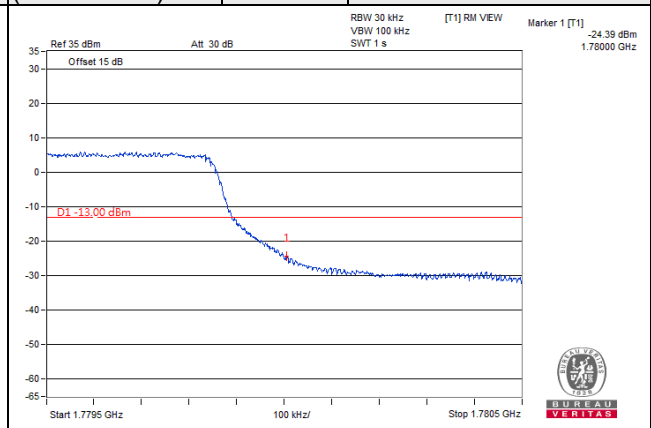
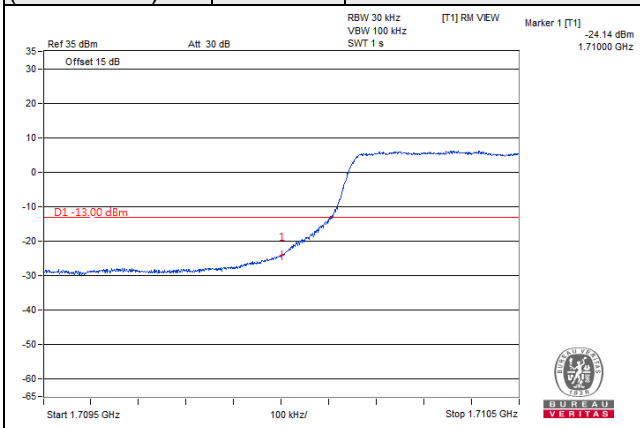

Channel Bandwidth: 5MHz

**Channel 131997
(1712.5MHz)**

256QAM 1 RB / 0 RB Offset

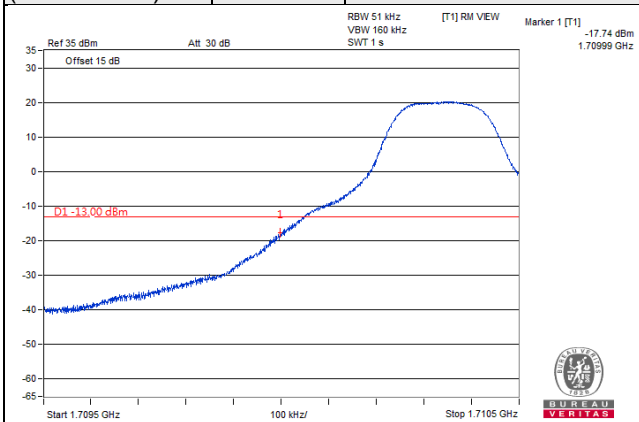

**Channel 132647
(1777.5MHz)**

256QAM 1 RB / 24 RB Offset

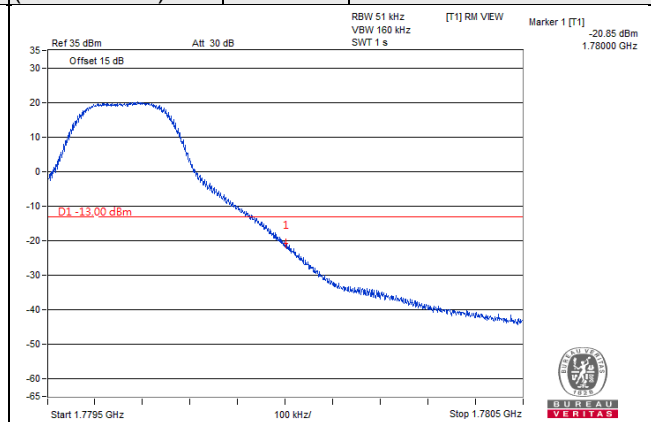

**Channel 131997
(1712.5MHz)**

256QAM 25 RB / 0 RB Offset

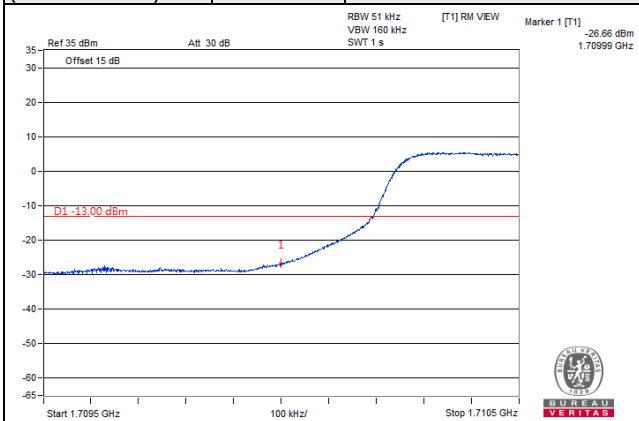

**Channel 132647
(1777.5MHz)**

256QAM 25 RB / 0 RB Offset

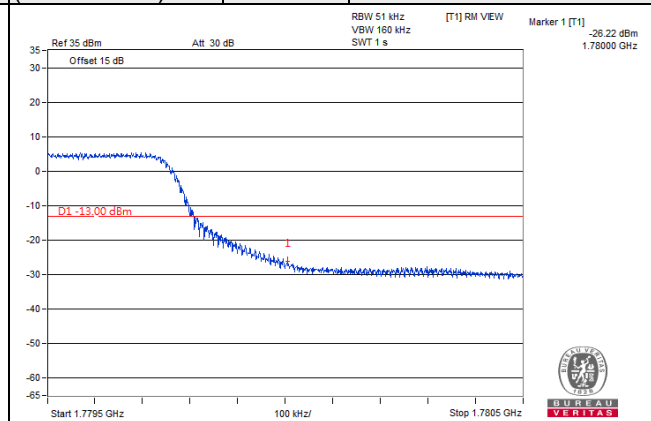

Channel Bandwidth: 10MHz

**Channel 132022
(1715.0MHz)**

256QAM

1 RB / 0 RB Offset

**Channel 132622
(1775.0MHz)**

256QAM

1 RB / 49 RB Offset

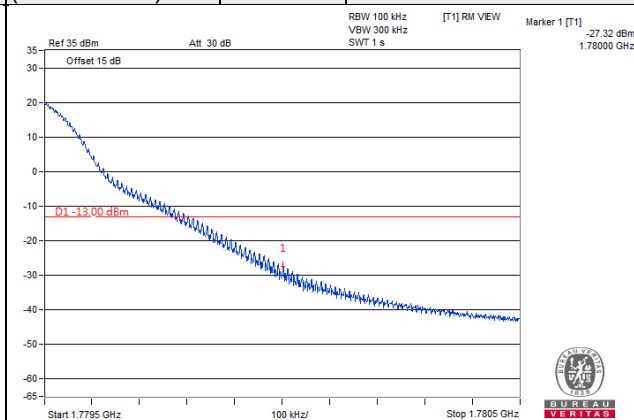
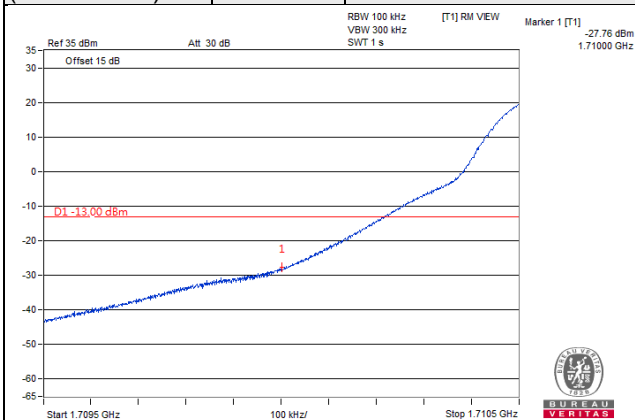

**Channel 132022
(1715.0MHz)**

256QAM

50 RB / 0 RB Offset

**Channel 132622
(1775.0MHz)**

256QAM

50 RB / 0 RB Offset

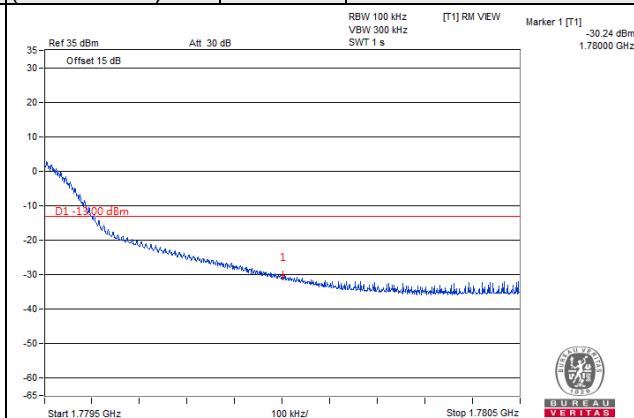
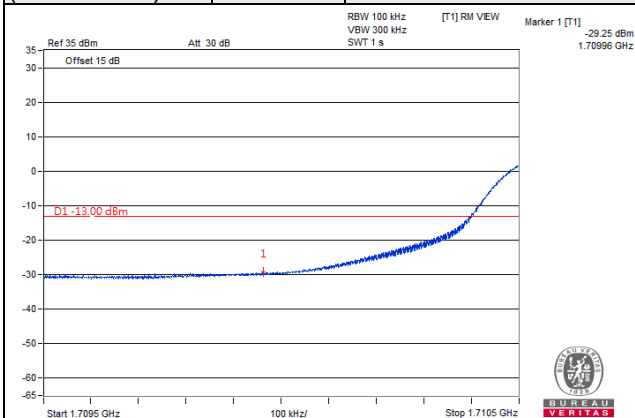

Channel Bandwidth: 15MHz

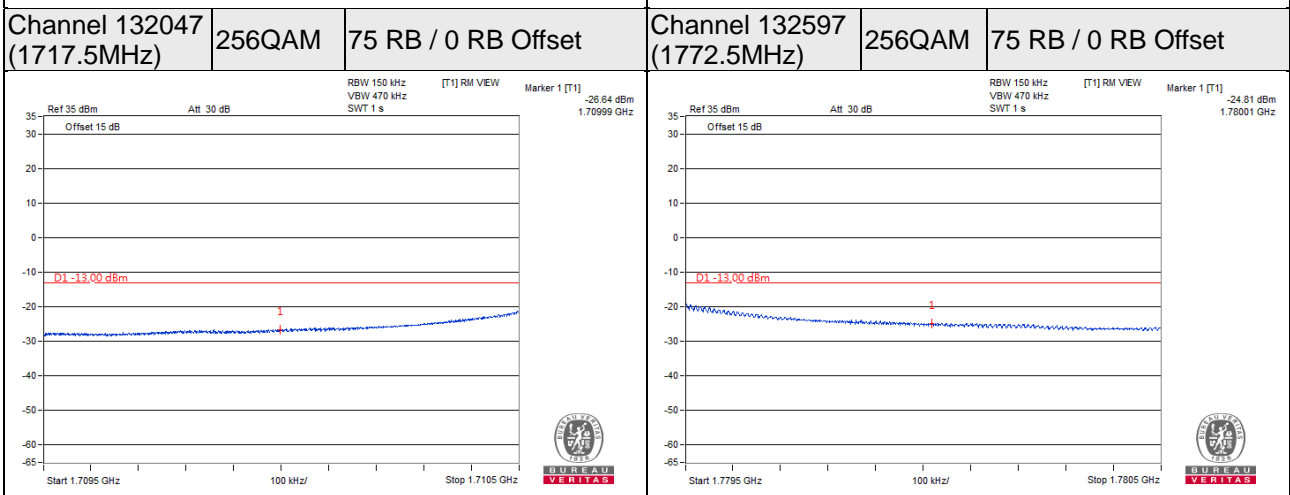
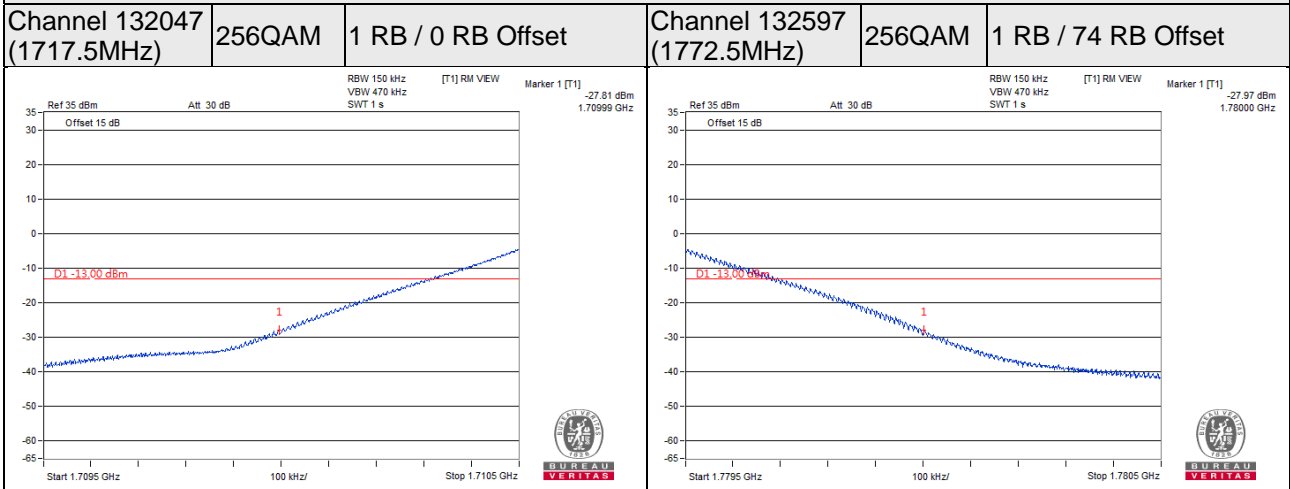

Channel Bandwidth: 20MHz

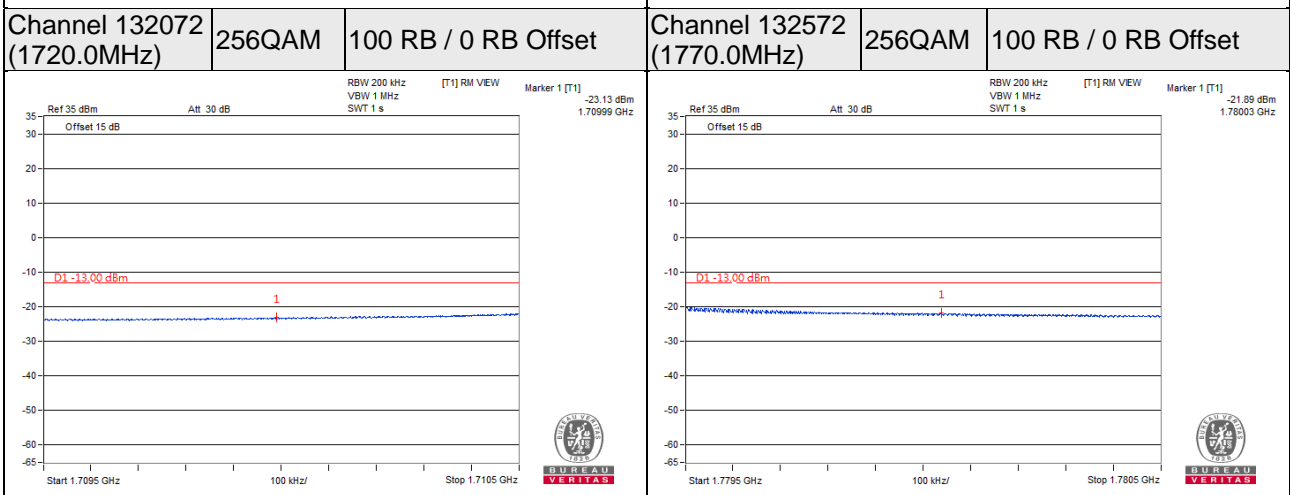
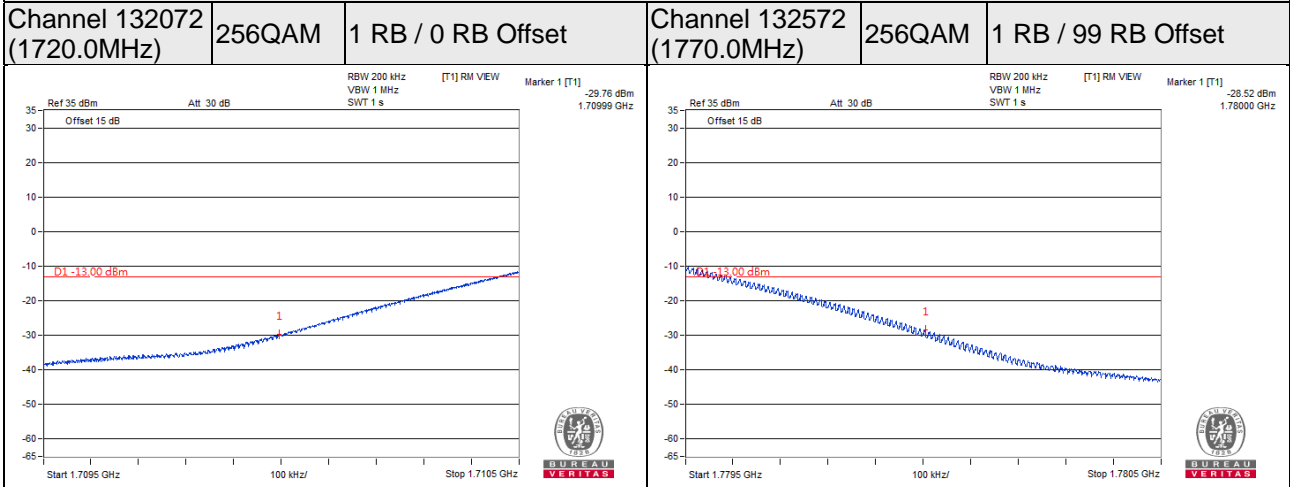

4.6 Peak to Average Ratio

4.6.1 Limits of Peak to Average Ratio Measurement

In measuring transmissions in this band using an average power technique, the peak to-average ratio (PAR) of the transmission may not exceed 13 dB

4.6.2 Test Setup

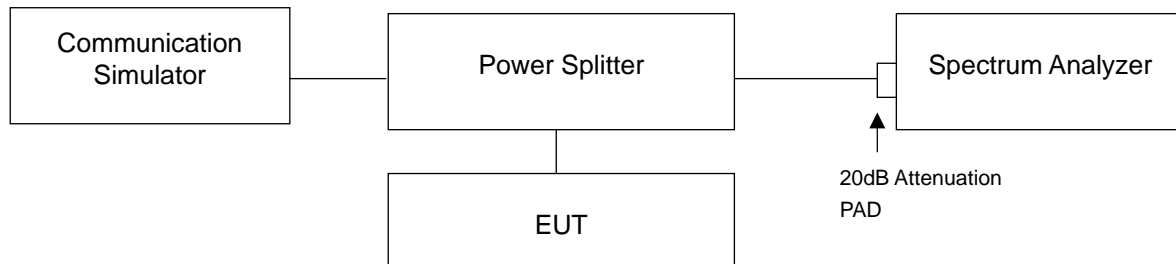

4.6.3 Test Procedures

- Set resolution/measurement bandwidth \geq signal's occupied bandwidth;
- Set the number of counts to a value that stabilizes the measured CCDF curve;
- Record the maximum PAPR level associated with a probability of 0.1%.

4.6.4 Test Results

n12

n12, Channel Bandwidth 5MHz						
Channel	Frequency (MHz)	Peak To Average Ratio (dB)				
		$\pi/2$ BPSK	QPSK	16QAM	64QAM	256QAM
140300	701.5	3.48	3.49	4.22	4.24	4.32
141500	707.5	3.43	3.43	4.97	5.06	5.01
142700	713.5	3.50	3.49	4.93	5.01	4.91
n12, Channel Bandwidth 10MHz						
Channel	Frequency (MHz)	Peak To Average Ratio (dB)				
		$\pi/2$ BPSK	QPSK	16QAM	64QAM	256QAM
140800	704.0	3.30	3.31	4.56	4.51	4.72
141500	707.5	3.30	3.19	4.69	4.75	4.78
142200	711.0	3.59	3.62	5.20	5.16	5.15
n12, Channel Bandwidth 15MHz						
Channel	Frequency (MHz)	Peak To Average Ratio (dB)				
		$\pi/2$ BPSK	QPSK	16QAM	64QAM	256QAM
141300	706.5	3.53	3.59	4.72	4.80	5.12
141500	707.5	3.44	3.44	4.92	5.04	4.99
141700	708.5	3.33	3.32	4.05	4.12	4.03

Spectrum Plot of Worst Value

5MHz / 64QAM

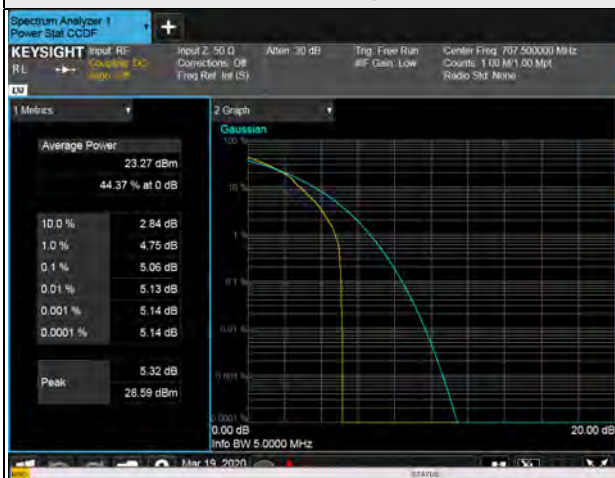

10MHz / 16QAM

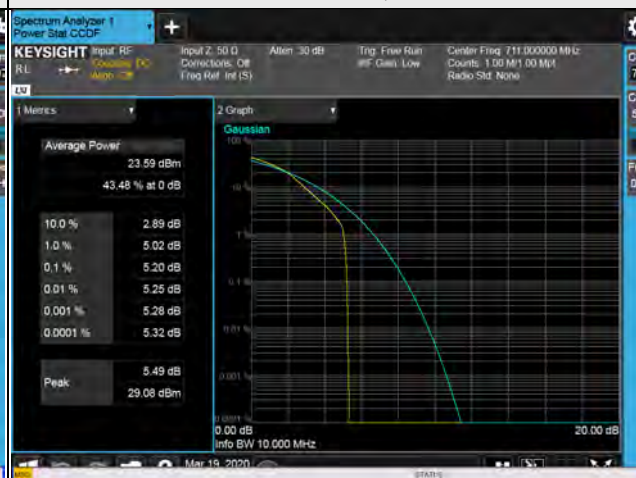

15MHz / 256QAM



LTE Band 2

LTE Band 2, Channel Bandwidth 1.4MHz		
Channel	Frequency (MHz)	Peak To Average Ratio (dB)
		256QAM
18607	1850.7	7.00
18900	1880.0	7.59
19193	1909.3	7.06
LTE Band 2, Channel Bandwidth 3MHz		
Channel	Frequency (MHz)	Peak To Average Ratio (dB)
		256QAM
18615	1851.5	8.20
18900	1880.0	7.84
19185	1908.5	7.44
LTE Band 2, Channel Bandwidth 5MHz		
Channel	Frequency (MHz)	Peak To Average Ratio (dB)
		256QAM
18625	1852.5	8.03
18900	1880.0	8.23
19175	1907.5	7.53
LTE Band 2, Channel Bandwidth 10MHz		
Channel	Frequency (MHz)	Peak To Average Ratio (dB)
		256QAM
18650	1855.0	8.76
18900	1880.0	8.42
19150	1905.0	7.58
LTE Band 2, Channel Bandwidth 15MHz		
Channel	Frequency (MHz)	Peak To Average Ratio (dB)
		256QAM
18675	1857.5	8.75
18900	1880.0	7.60
19125	1902.5	6.94

LTE Band 2, Channel Bandwidth 20MHz

Channel	Frequency (MHz)	Peak To Average Ratio (dB)
		256QAM
18700	1860.0	8.61
18900	1880.0	7.94
19100	1900.0	7.41

Spectrum Plot of Worst Value

1.4MHz / 256QAM

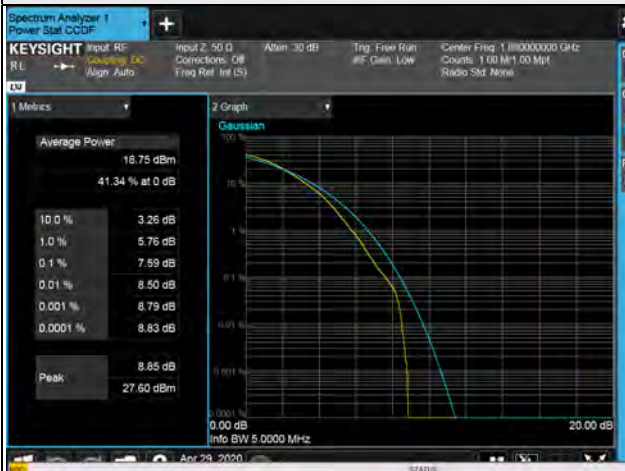

3MHz / 256QAM



5MHz / 256QAM

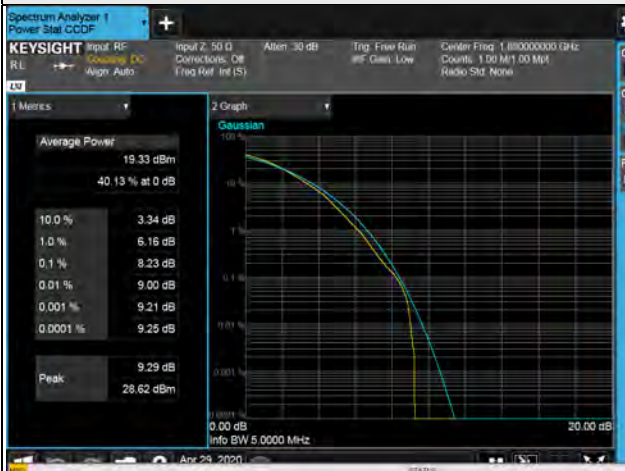

10MHz / 256QAM



15MHz / 256QAM

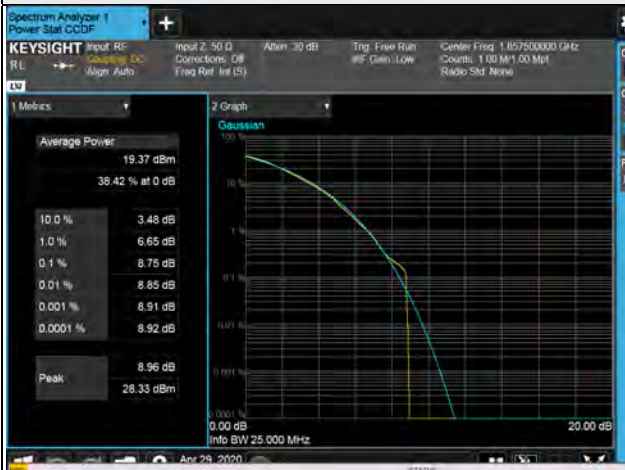

20MHz / 256QAM



LTE Band 66

LTE Band 66, Channel Bandwidth 1.4MHz		
Channel	Frequency (MHz)	Peak To Average Ratio (dB)
		256QAM
131979	1710.7	7.53
132322	1745.0	7.45
132665	1779.3	7.17
LTE Band 66, Channel Bandwidth 3MHz		
Channel	Frequency (MHz)	Peak To Average Ratio (dB)
		256QAM
131987	1711.5	7.45
132322	1745.0	7.65
132657	1778.5	7.41
LTE Band 66, Channel Bandwidth 5MHz		
Channel	Frequency (MHz)	Peak To Average Ratio (dB)
		256QAM
131997	1712.5	7.57
132322	1745.0	7.62
132647	1777.5	7.49
LTE Band 66, Channel Bandwidth 10MHz		
Channel	Frequency (MHz)	Peak To Average Ratio (dB)
		256QAM
132022	1715.0	7.75
132322	1745.0	7.86
132622	1775.0	7.68
LTE Band 66, Channel Bandwidth 15MHz		
Channel	Frequency (MHz)	Peak To Average Ratio (dB)
		256QAM
132047	1717.5	7.80
132322	1745.0	7.69
132597	1772.5	7.49

LTE Band 66, Channel Bandwidth 20MHz

Channel	Frequency (MHz)	Peak To Average Ratio (dB)
		256QAM
132072	1720.0	7.89
132322	1745.0	7.77
132572	1770.0	7.35

Spectrum Plot of Worst Value

1.4MHz / 256QAM

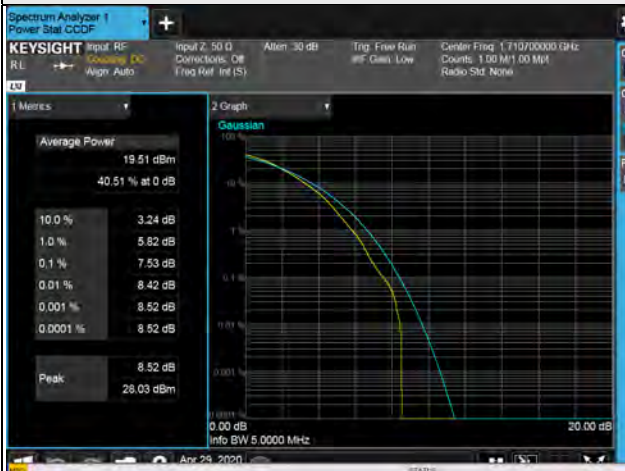

3MHz / 256QAM



5MHz / 256QAM

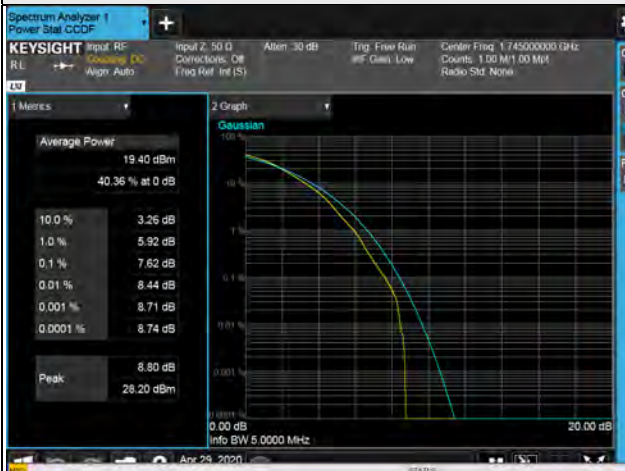

10MHz / 256QAM



15MHz / 256QAM

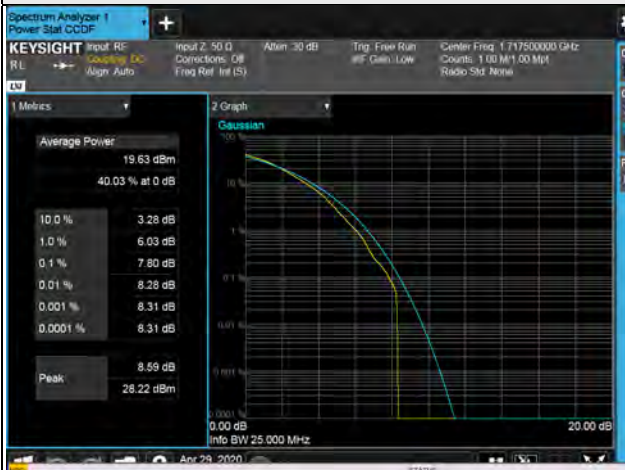

20MHz / 256QAM



4.7 Conducted Spurious Emissions

4.7.1 Limits of Conducted Spurious Emissions Measurement

For n12

According to FCC 27.53(g) for operations in the 600 MHz band and the 698-746 MHz band, the power of any emission outside a licensee's frequency band(s) of operation shall be attenuated below the transmitter power (P) within the licensed band(s) of operation, measured in watts, by at least $43 + 10 \log(P)$ dB. Compliance with this provision is based on the use of measurement instrumentation employing a resolution bandwidth of 100 kilohertz or greater.

For LTE Band 2

The power of any emission outside of the authorized operating frequency ranges must be attenuated below the transmitting power (P) by a factor of at least $43 + 10 \log(P)$ dB. The emission limit equal to -13dBm .

For LTE Band 66

In the FCC 27.53(h), On any frequency outside a licensee's frequency block, The power of any emission shall be attenuated below the transmitter power (P) by at least $43 + 10 \log(P)$ dB. The emission limit equal to -13dBm .

4.7.2 Test Setup

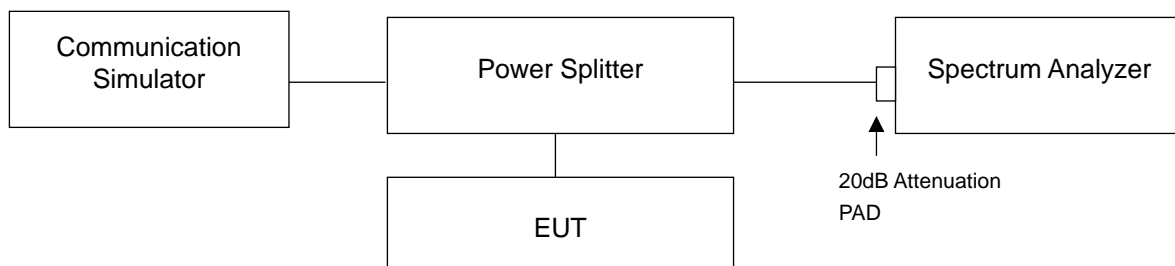

4.7.3 Test Procedure

- The EUT makes a phone call to the communication simulator. All measurements were done at low, middle and high operational frequency range.
- Measuring frequency range is from 9kHz to 9GHz. 20dB attenuation pad is connected with spectrum. RBW=1MHz and VBW=3MHz is used for conducted emission measurement.

4.7.4 Test Results

n12

Channel Band width: 5MHz

Channel 140300 (701.5MHz)

Frequency Range : 9kHz~1GHz

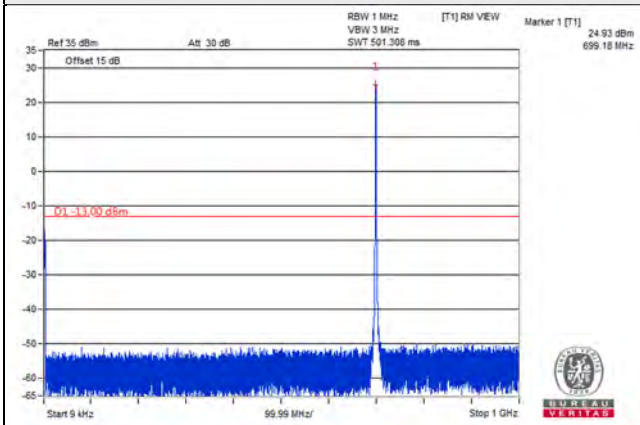

Frequency Range : 1GHz~8GHz

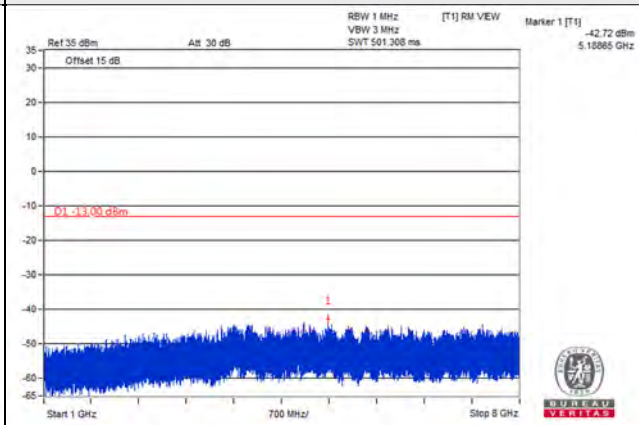

Channel 141500 (707.5MHz)

Frequency Range : 9kHz~1GHz

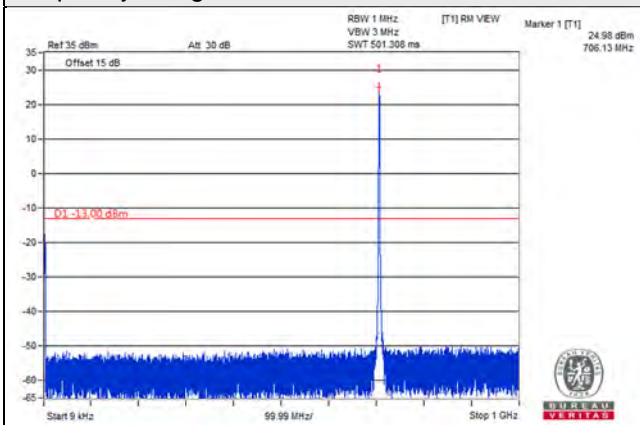

Frequency Range : 1GHz~8GHz

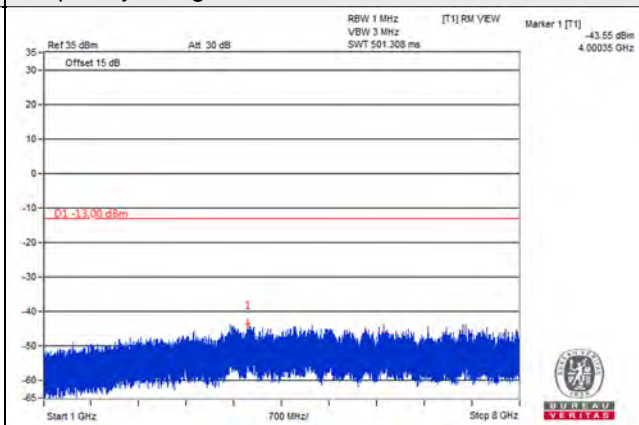

Channel 142700 (713.5MHz)

Frequency Range : 9kHz~1GHz

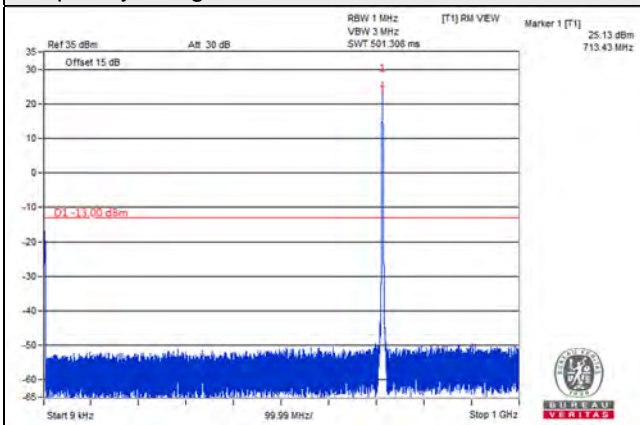

Frequency Range : 1GHz~8GHz

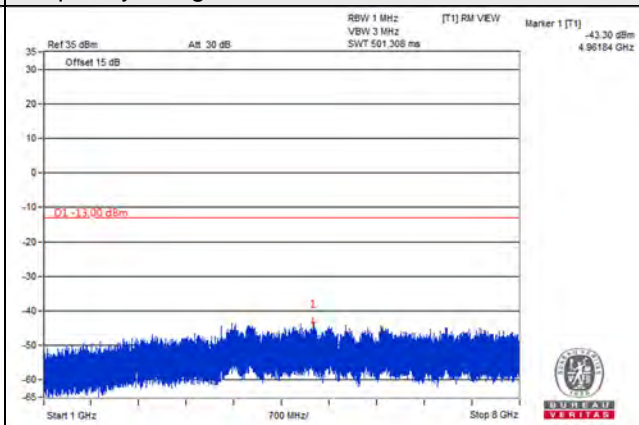

Channel Band width: 10MHz

Channel 140800 (704MHz)

Frequency Range : 9kHz~1GHz

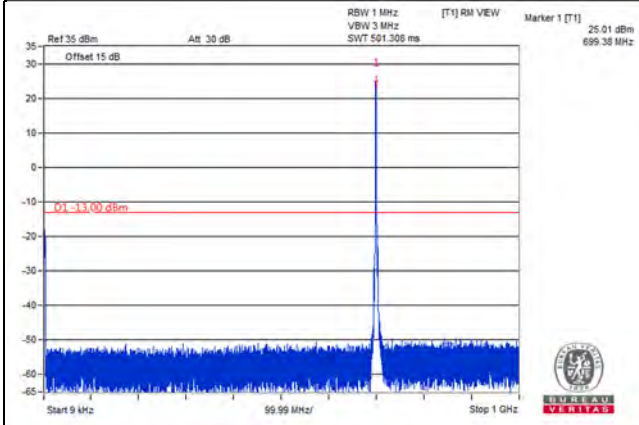

Frequency Range : 1GHz~8GHz

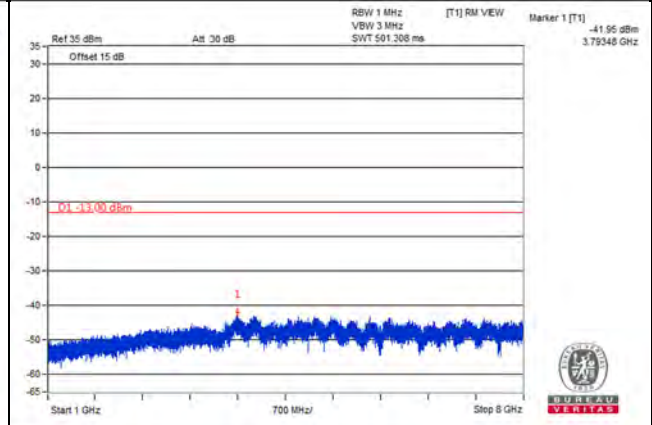

Channel 141500 (707.5MHz)

Frequency Range : 9kHz~1GHz

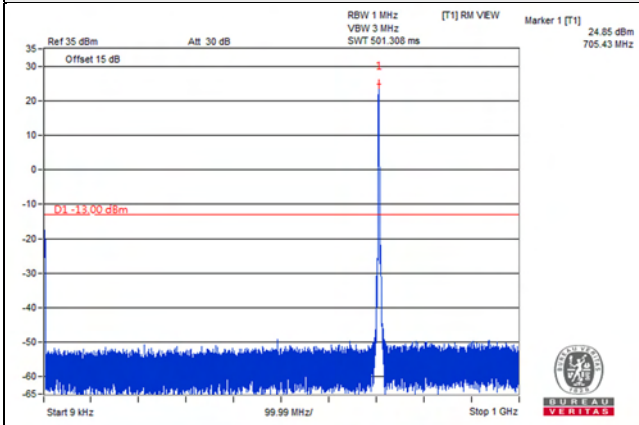

Frequency Range : 1GHz~8GHz

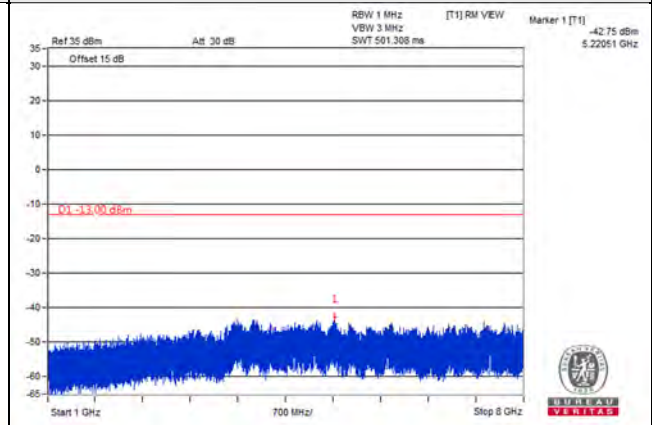

Channel 142200 (711MHz)

Frequency Range : 9kHz~1GHz

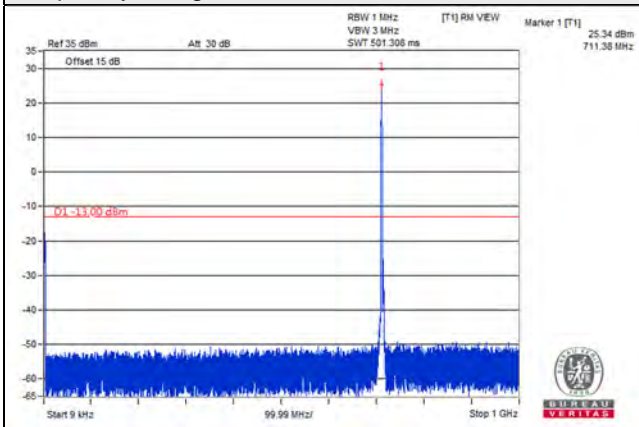

Frequency Range : 1GHz~8GHz

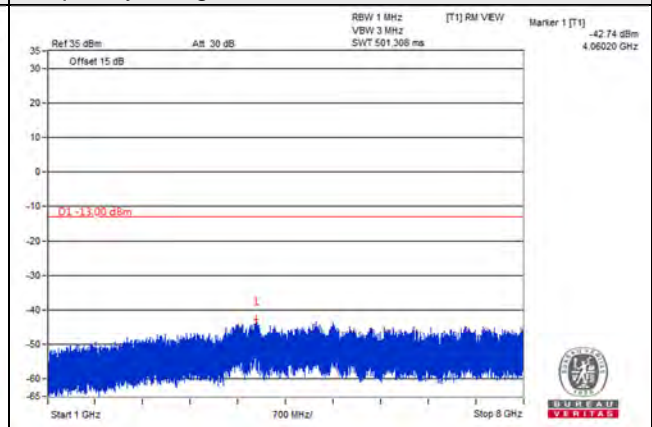

Channel Band width: 15MHz

Channel 141300 (706.5MHz)

Frequency Range : 9kHz~1GHz

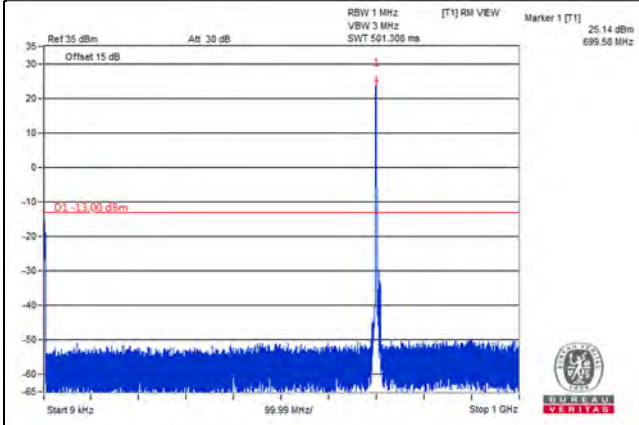

Frequency Range : 1GHz~8GHz

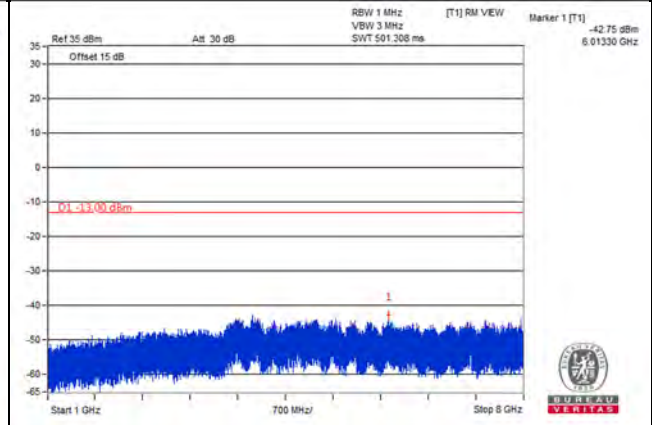

Channel 141500 (707.5MHz)

Frequency Range : 9kHz~1GHz

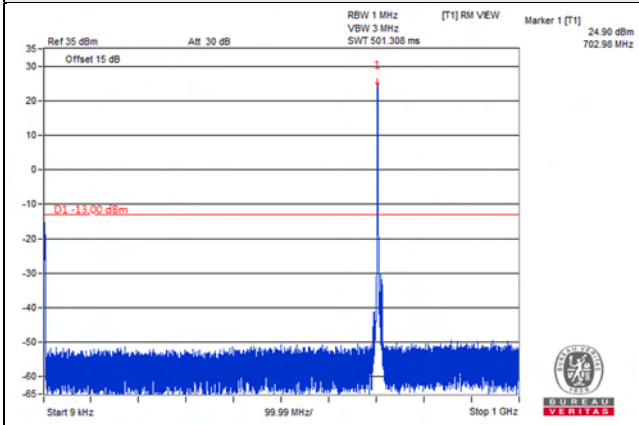

Frequency Range : 1GHz~8GHz

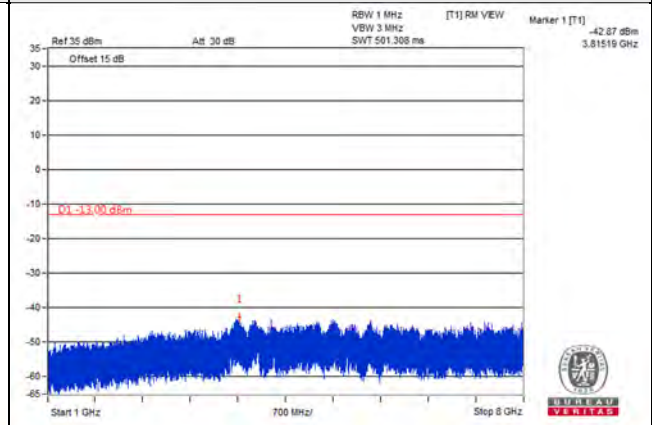

Channel 141700 (708.5MHz)

Frequency Range : 9kHz~1GHz

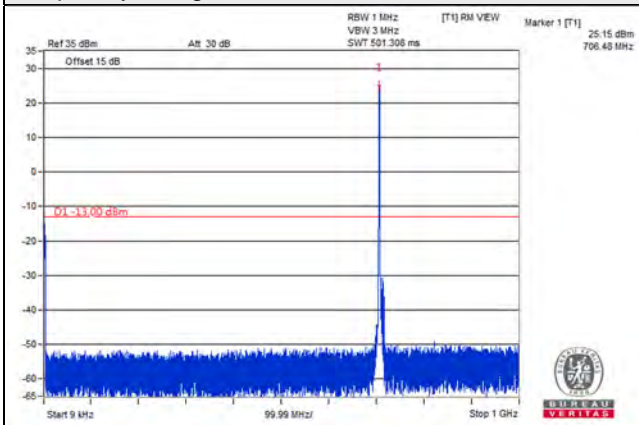

Frequency Range : 1GHz~8GHz

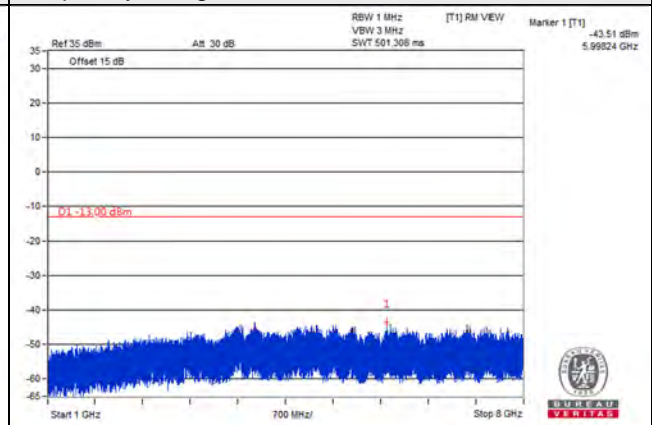

LTE Band 2

Channel Bandwidth 1.4MHz

Channel 18607 (1850.70MHz)

Frequency Range : 9kHz~1GHz

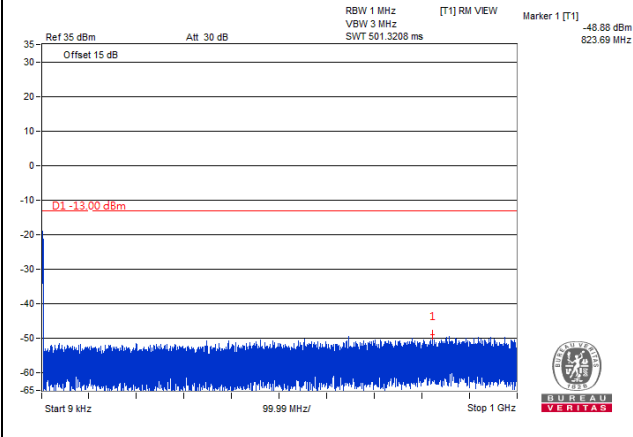

Frequency Range : 1GHz~20GHz

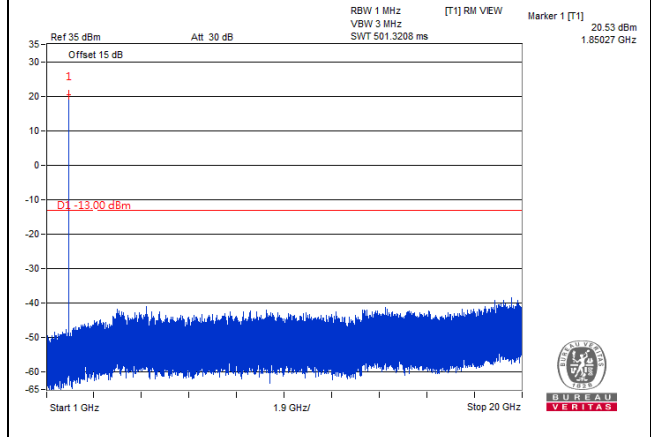

Channel 18900 (1880.00MHz)

Frequency Range : 9kHz~1GHz

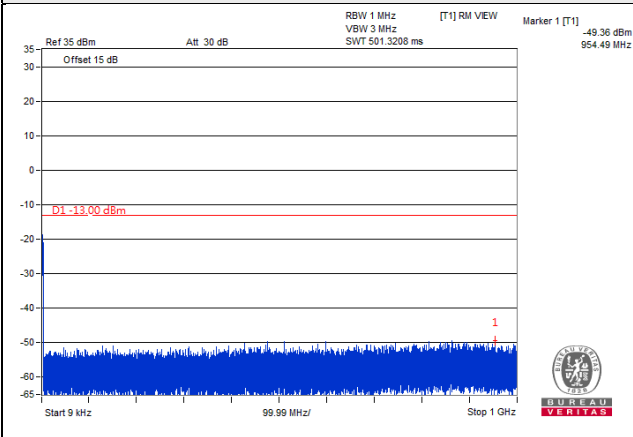

Frequency Range : 1GHz~20GHz

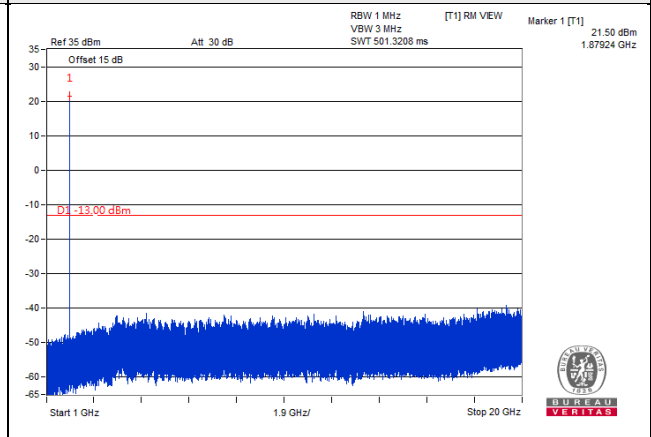

Channel 19193 (1909.30MHz)

Frequency Range : 9kHz~1GHz

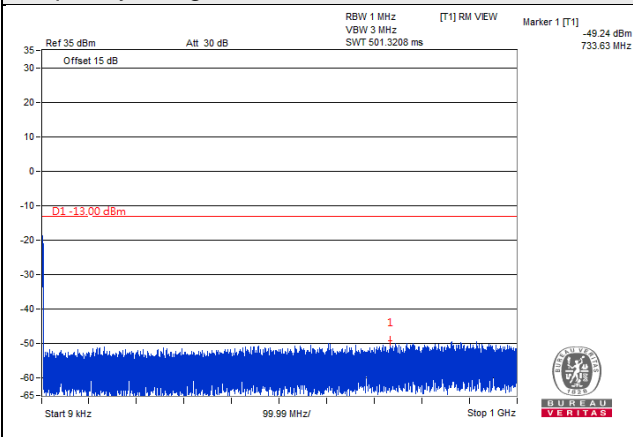

Frequency Range : 1GHz~20GHz

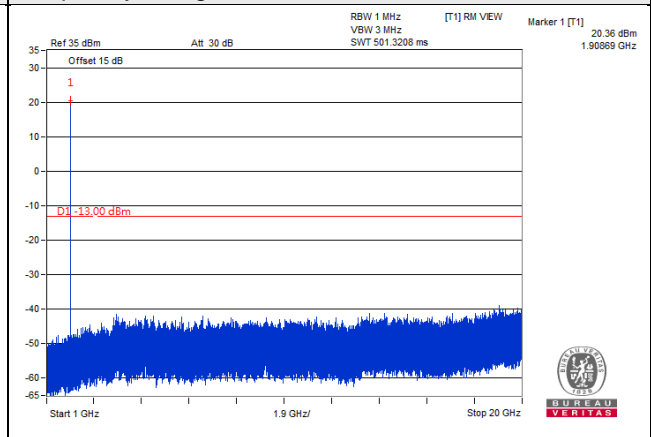

Channel Bandwidth 3MHz

Channel 18615 (1851.50MHz)

Frequency Range : 9kHz~1GHz

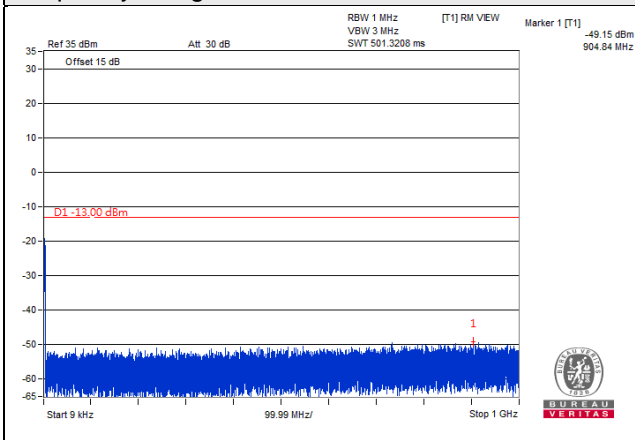

Frequency Range : 1GHz~20GHz

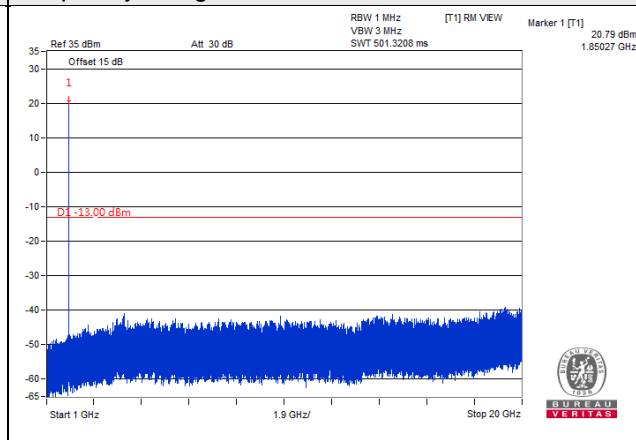

Channel 18900 (1880.00MHz)

Frequency Range : 9kHz~1GHz

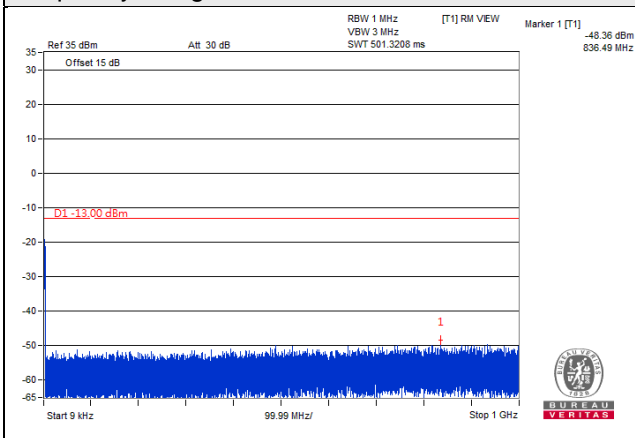

Frequency Range : 1GHz~20GHz

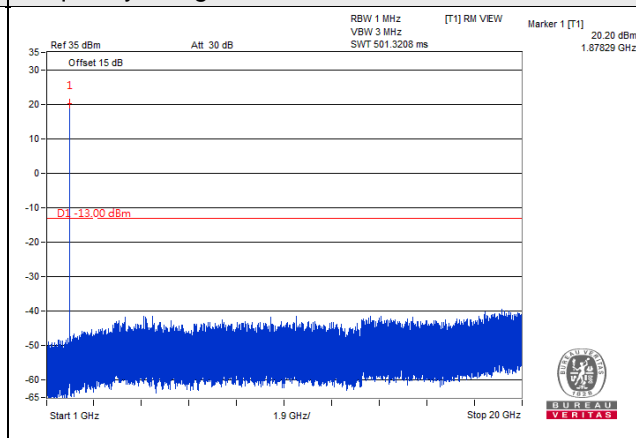

Channel 19185 (1908.50MHz)

Frequency Range : 9kHz~1GHz

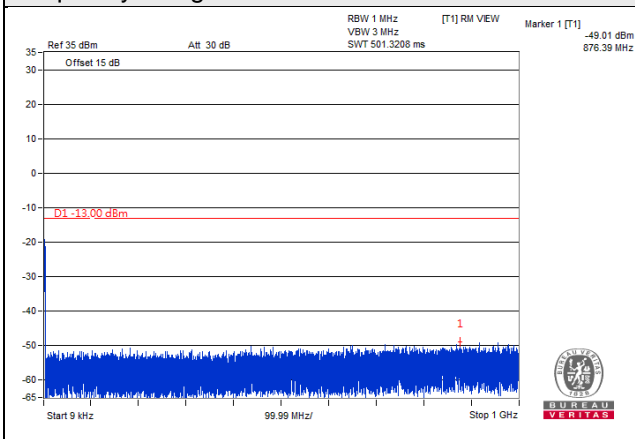

Frequency Range : 1GHz~20GHz

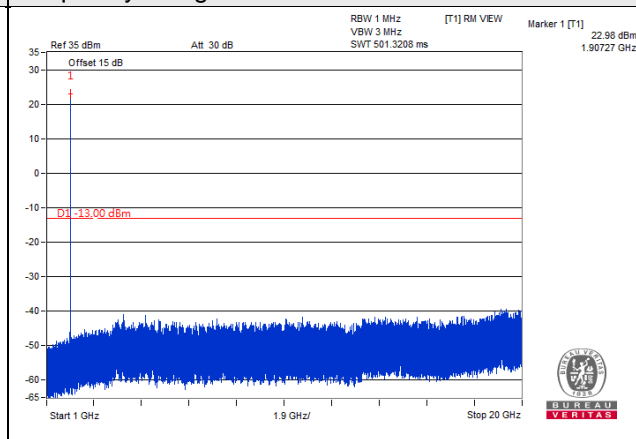

Channel Bandwidth 5MHz

Channel 18625 (1852.50MHz)

Frequency Range : 9kHz~1GHz

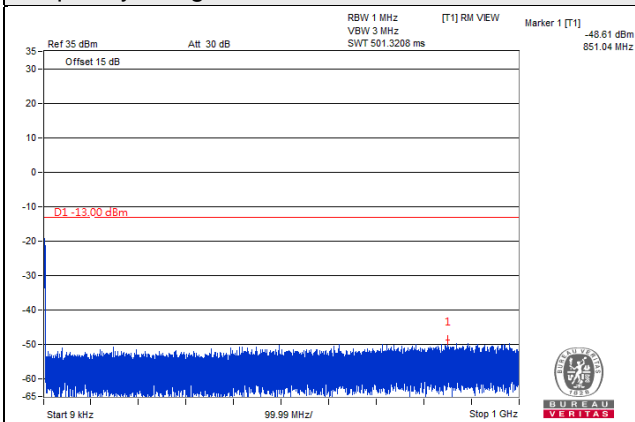

Frequency Range : 1GHz~20GHz

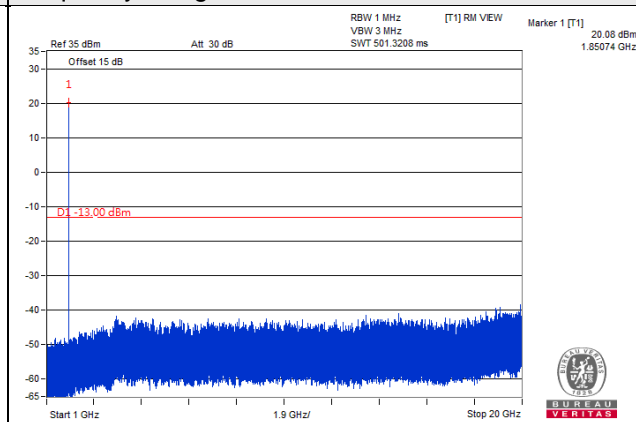

Channel 18900 (1880.00MHz)

Frequency Range : 9kHz~1GHz

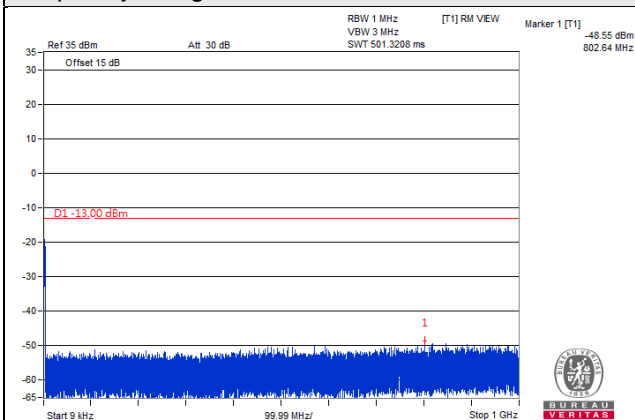

Frequency Range : 1GHz~20GHz

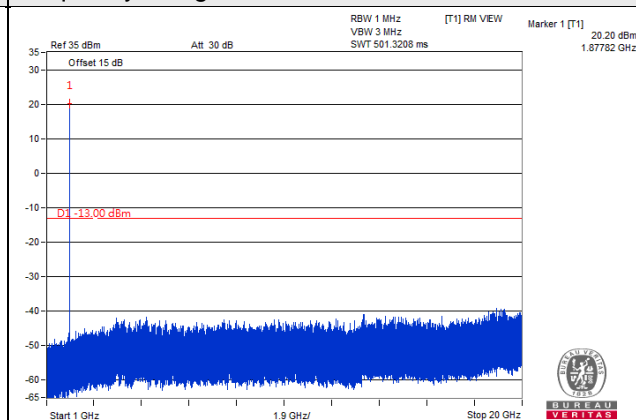

Channel 19175 (1907.50MHz)

Frequency Range : 9kHz~1GHz

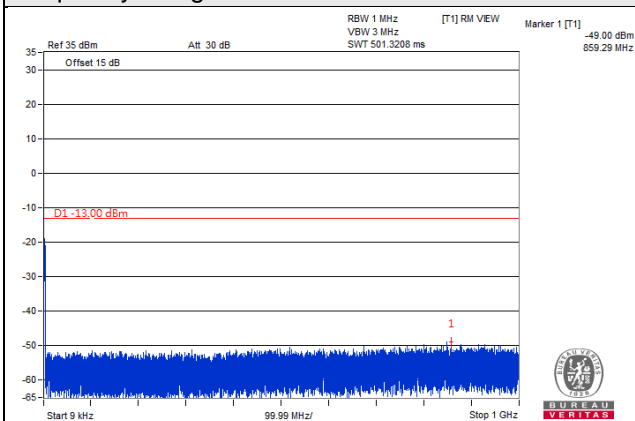

Frequency Range : 1GHz~20GHz

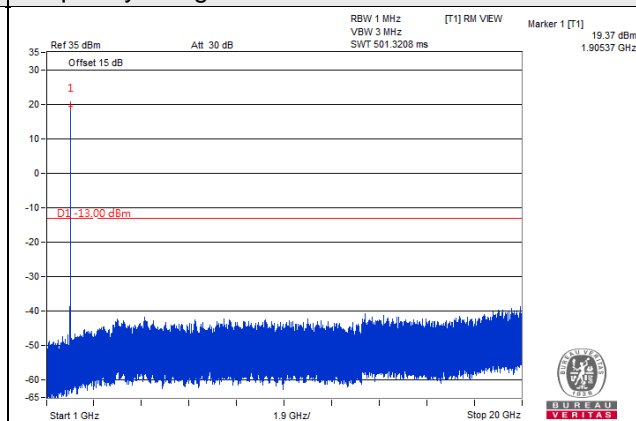

Channel Bandwidth 10MHz

Channel 18650 (1855.00MHz)

Frequency Range : 9kHz~1GHz

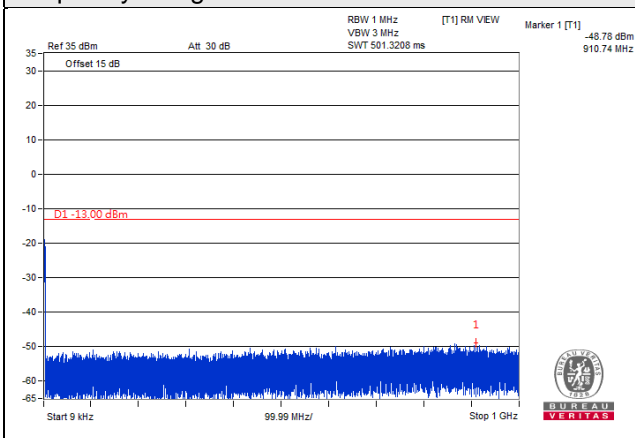

Frequency Range : 1GHz~20GHz

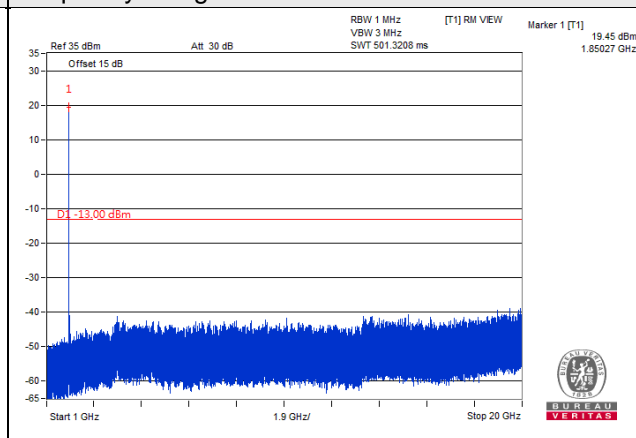

Channel 18900 (1880.00MHz)

Frequency Range : 9kHz~1GHz

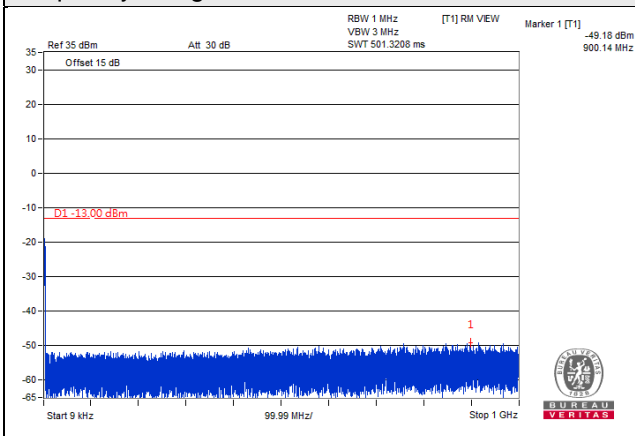

Frequency Range : 1GHz~20GHz

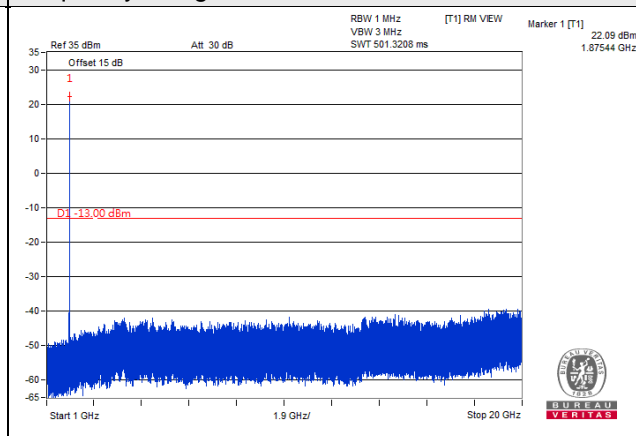

Channel 19150 (1905.00MHz)

Frequency Range : 9kHz~1GHz

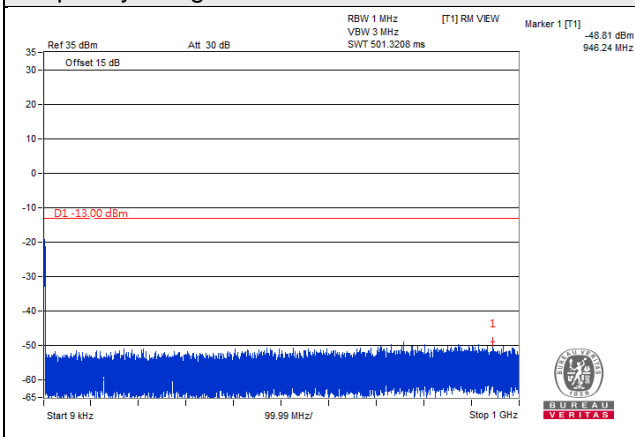

Frequency Range : 1GHz~20GHz

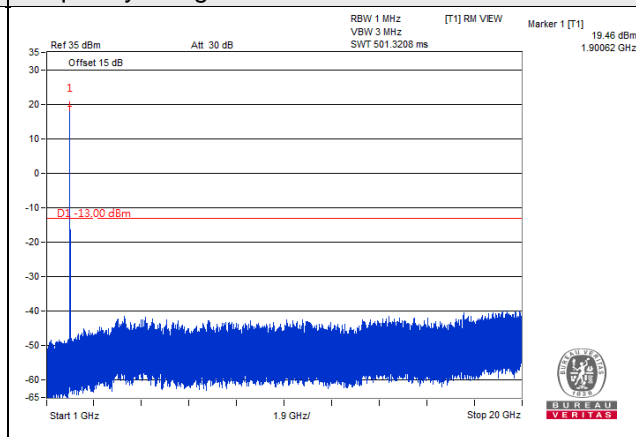

Channel Bandwidth 15MHz

Channel 18675 (1857.50MHz)

Frequency Range : 9kHz~1GHz

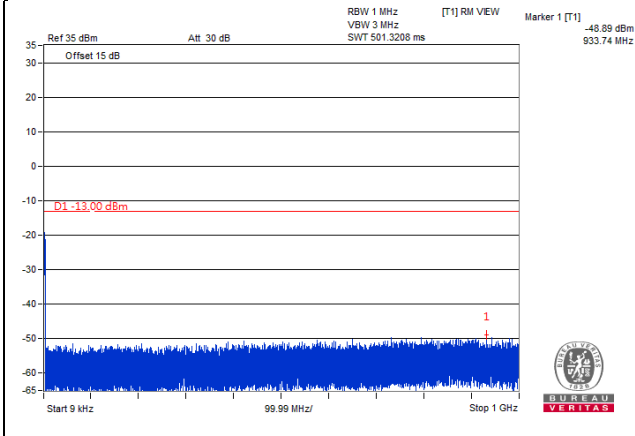

Frequency Range : 1GHz~20GHz

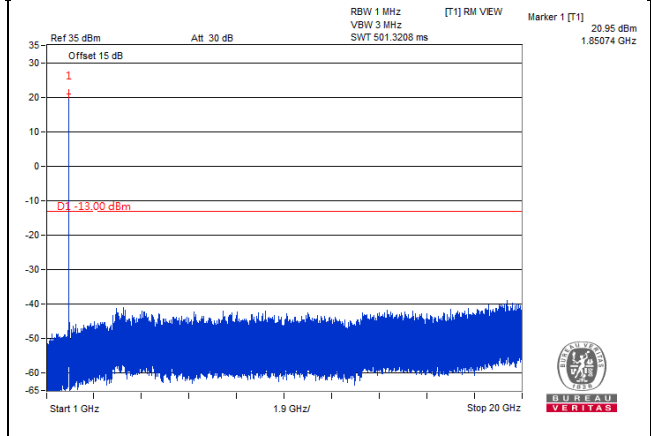

Channel 18900 (1880.00MHz)

Frequency Range : 9kHz~1GHz

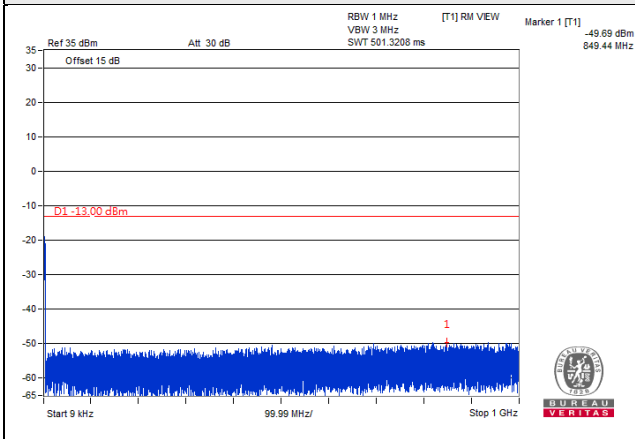

Frequency Range : 1GHz~20GHz

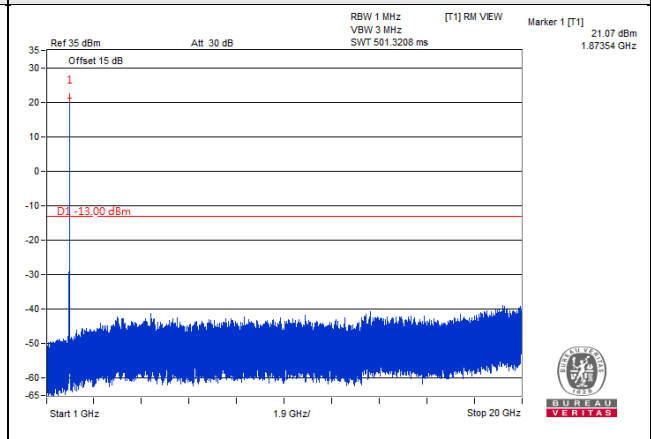

Channel 19125 (1902.50MHz)

Frequency Range : 9kHz~1GHz

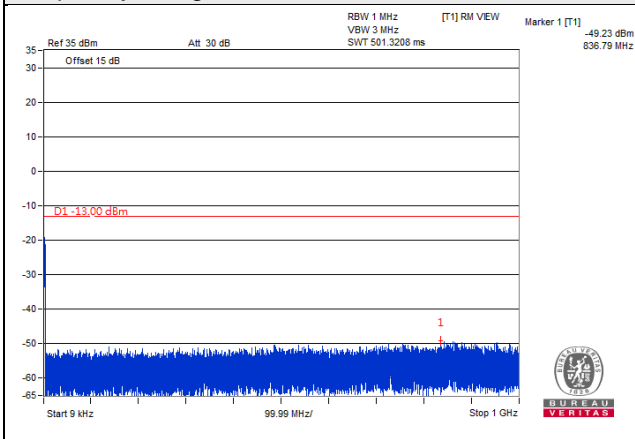

Frequency Range : 1GHz~20GHz

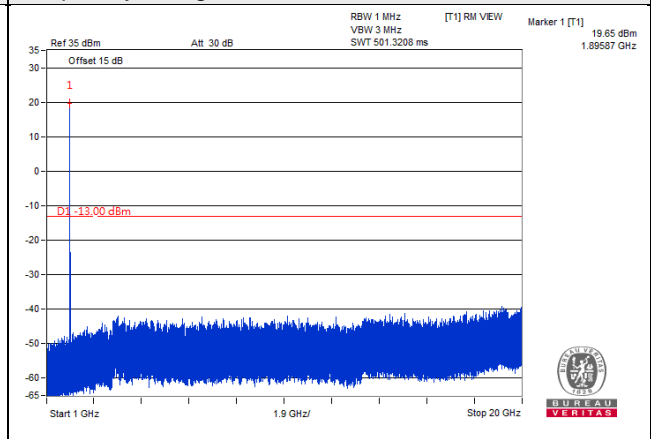

Channel Bandwidth 20MHz

Channel 18700 (1860.00MHz)

Frequency Range : 9kHz~1GHz

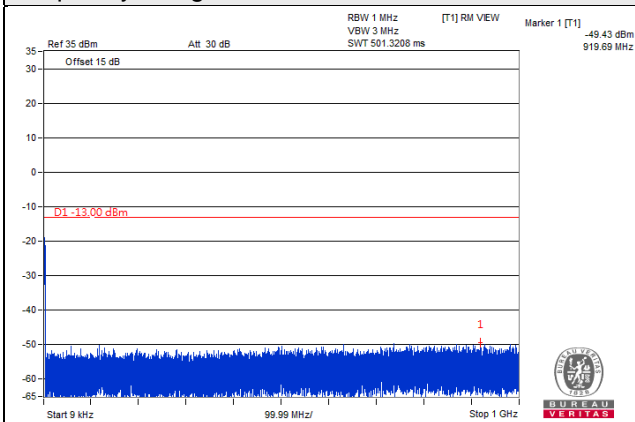

Frequency Range : 1GHz~20GHz

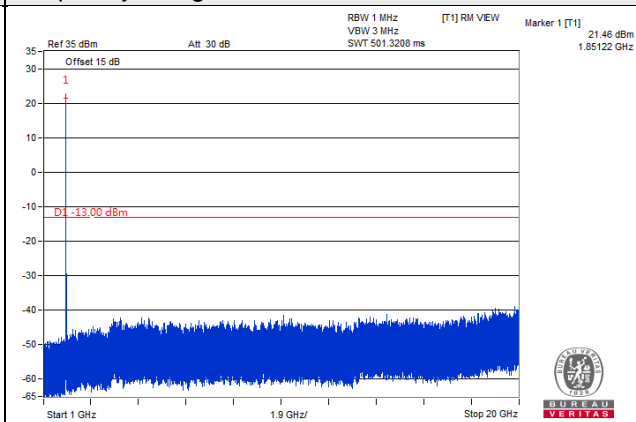

Channel 18900 (1880.00MHz)

Frequency Range : 9kHz~1GHz

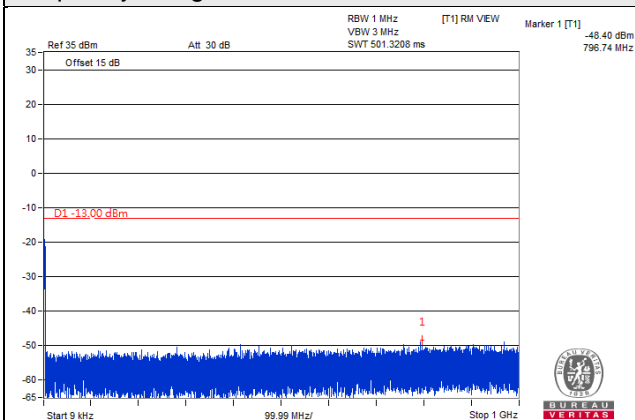

Frequency Range : 1GHz~20GHz

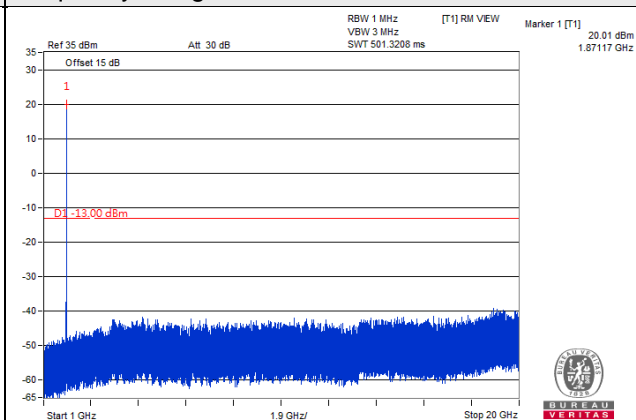

Channel 19100 (1900.00MHz)

Frequency Range : 9kHz~1GHz

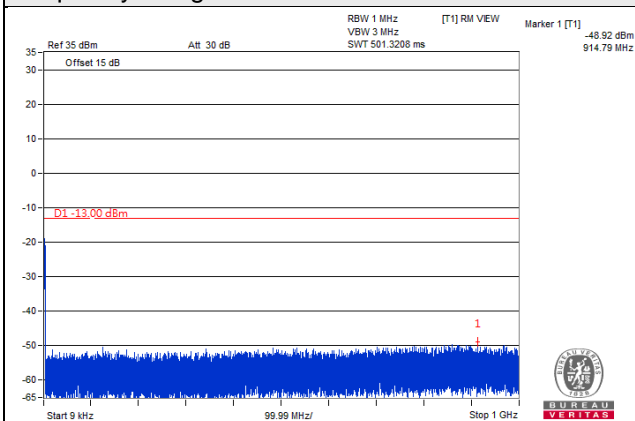

Frequency Range : 1GHz~20GHz

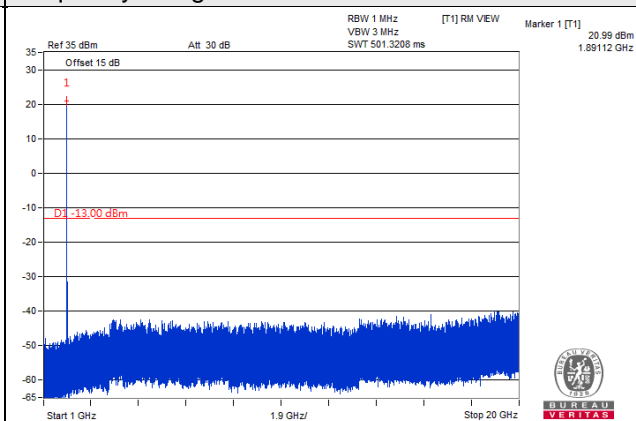

LTE Band 66

Channel Bandwidth: 1.4MHz

Channel 131979 (1710.7MHz)

Frequency Range : 9kHz~1GHz

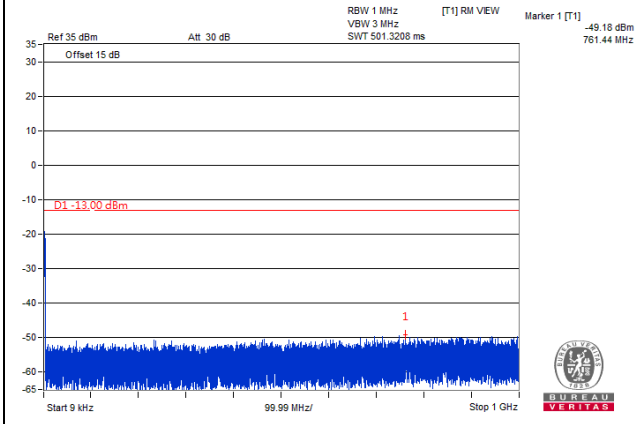

Frequency Range : 1GHz~18GHz

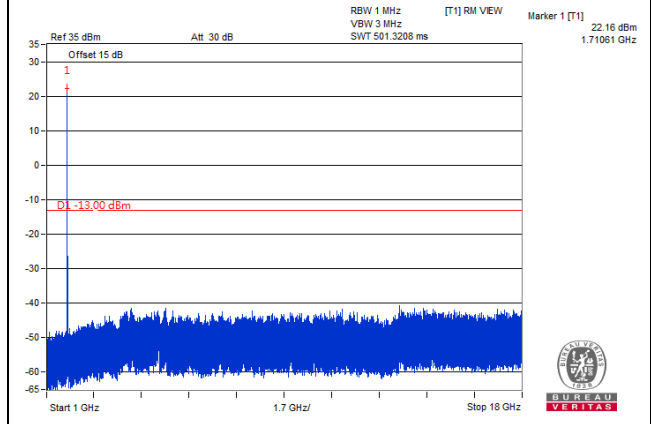

Channel 132322 (1745.0MHz)

Frequency Range : 9kHz~1GHz

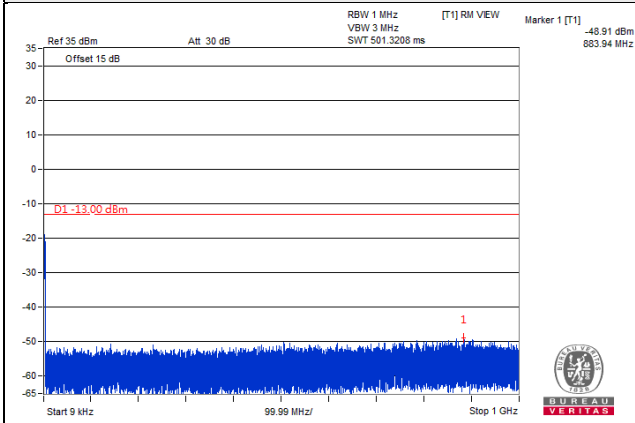

Frequency Range : 1GHz~18GHz

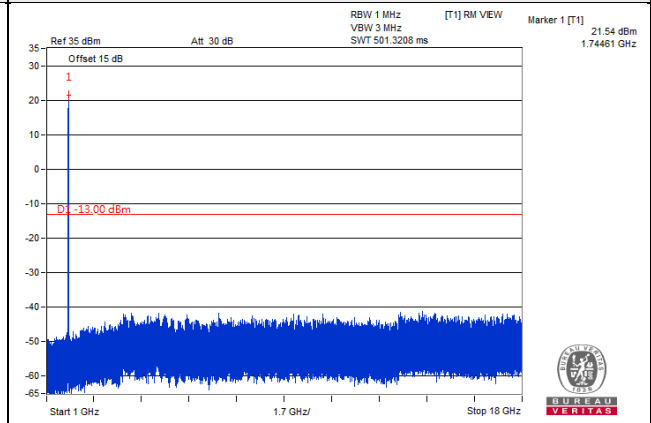

Channel 132665 (1779.3MHz)

Frequency Range : 9kHz~1GHz

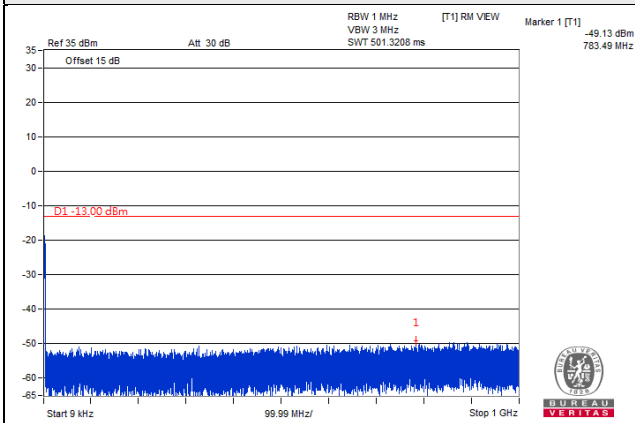

Frequency Range : 1GHz~18GHz

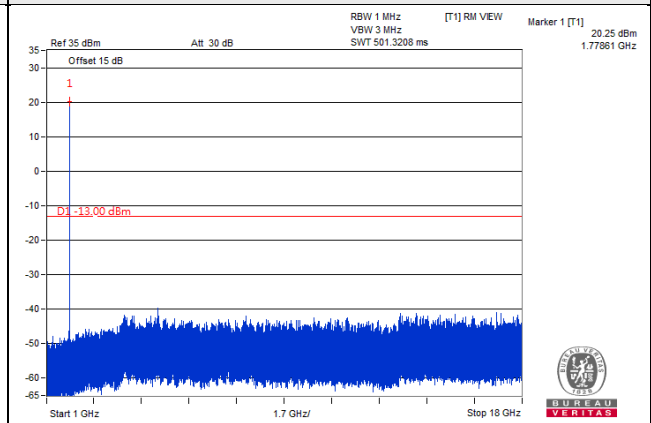

Channel Bandwidth: 3MHz

Channel 131987 (1711.5MHz)

Frequency Range : 9kHz~1GHz

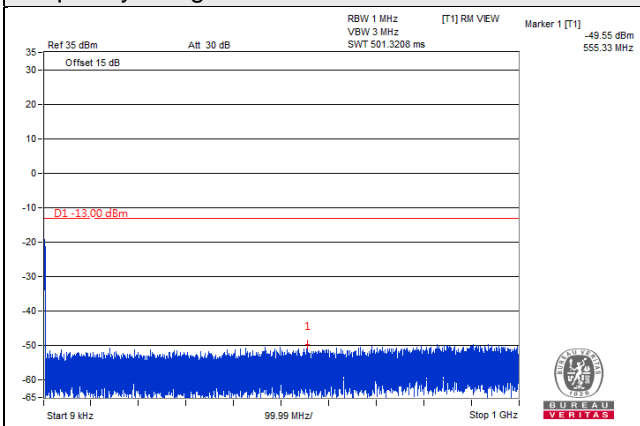

Frequency Range : 1GHz~18GHz

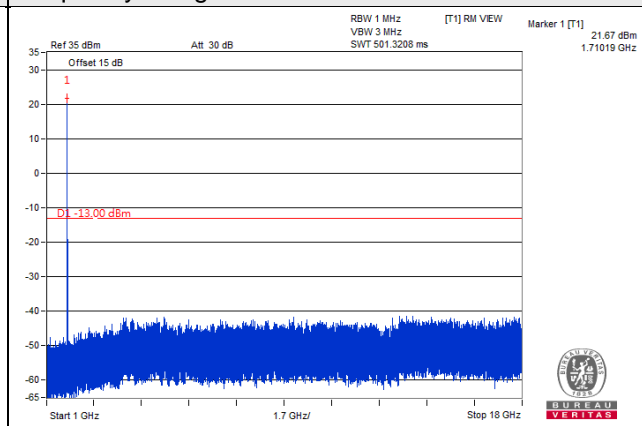

Channel 132322 (1745.0MHz)

Frequency Range : 9kHz~1GHz

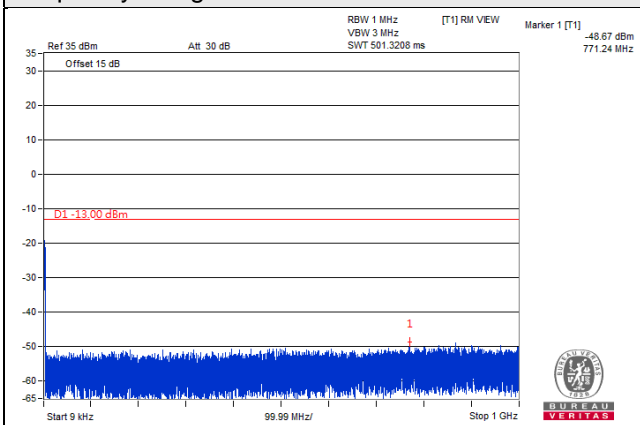

Frequency Range : 1GHz~18GHz

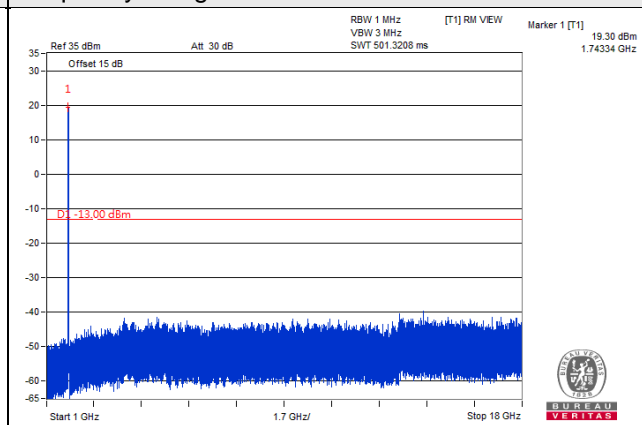

Channel 132657 (1778.5MHz)

Frequency Range : 9kHz~1GHz

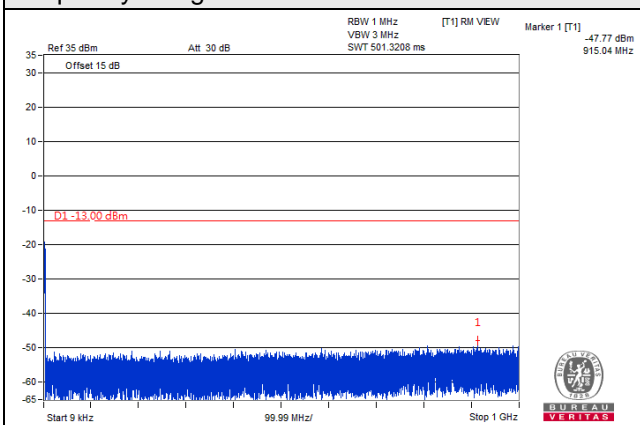

Frequency Range : 1GHz~18GHz

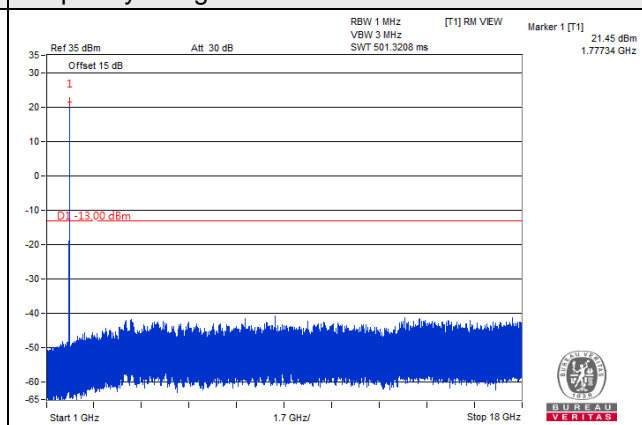

Channel Bandwidth: 5MHz

Channel 131997 (1712.5MHz)

Frequency Range : 9kHz~1GHz

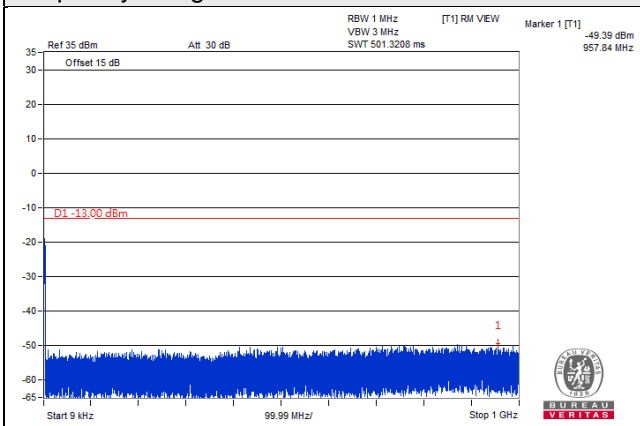

Frequency Range : 1GHz~18GHz

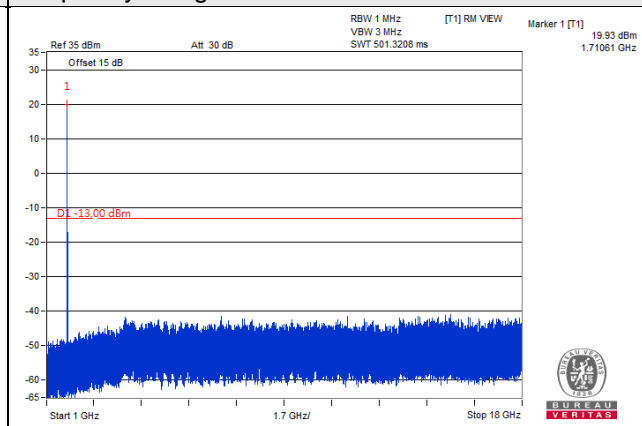

Channel 132322 (1745.0MHz)

Frequency Range : 9kHz~1GHz

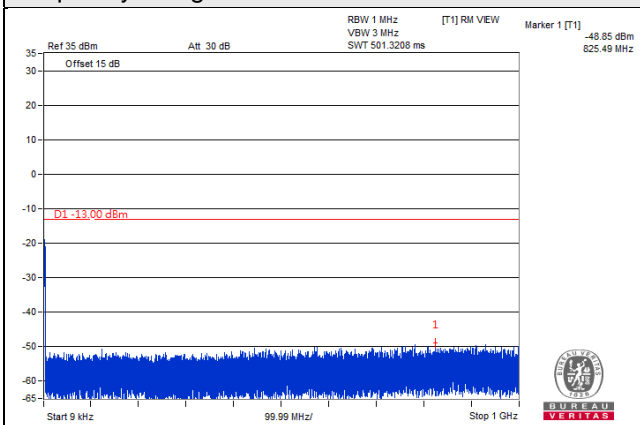

Frequency Range : 1GHz~18GHz

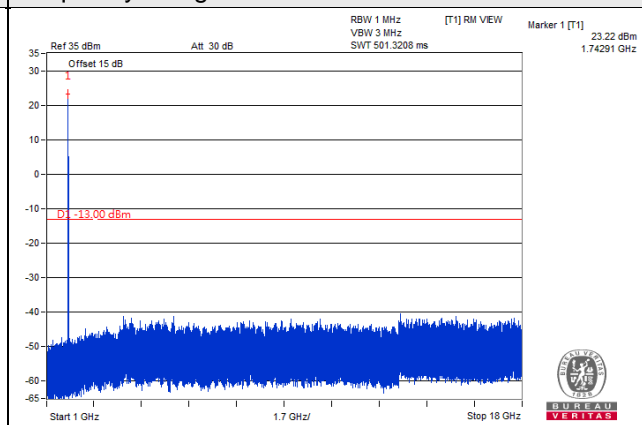

Channel 132647 (1777.5MHz)

Frequency Range : 9kHz~1GHz

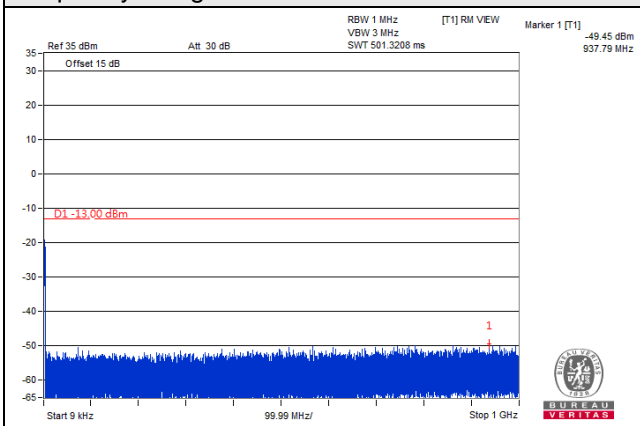

Frequency Range : 1GHz~18GHz

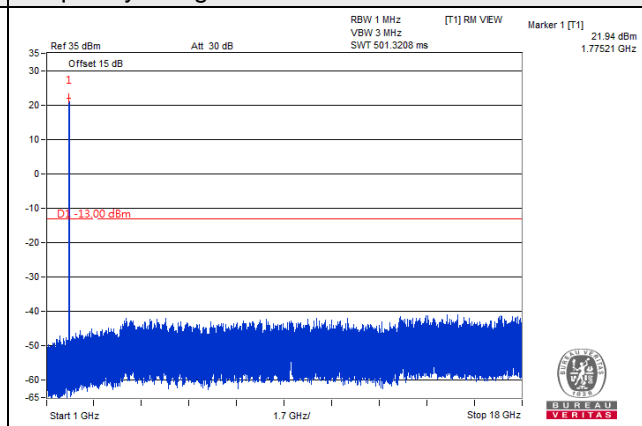

Channel Bandwidth: 10MHz

Channel 132022 (1715.0MHz)

Frequency Range : 9kHz~1GHz

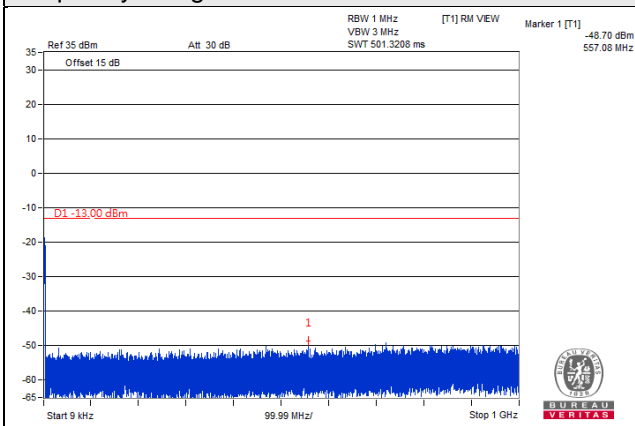

Frequency Range : 1GHz~18GHz

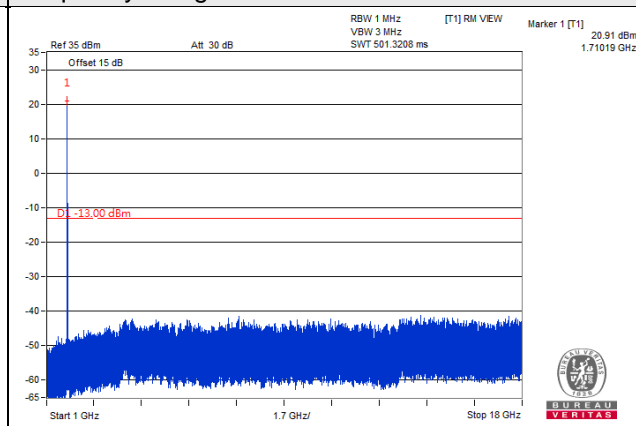

Channel 132322 (1745.0MHz)

Frequency Range : 9kHz~1GHz

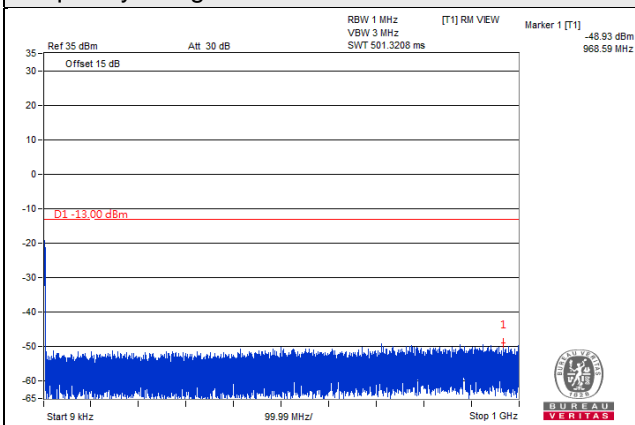

Frequency Range : 1GHz~18GHz

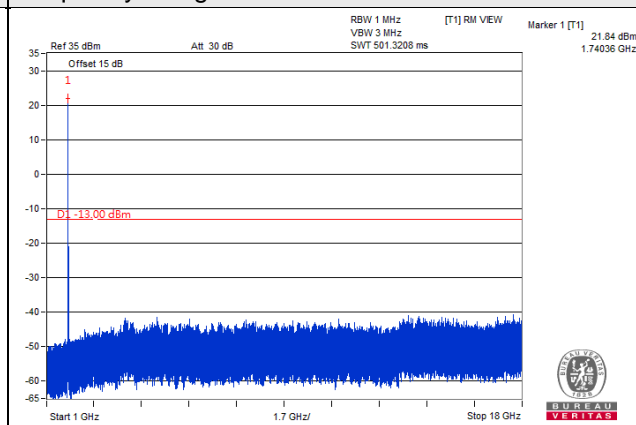

Channel 132622 (1775.0MHz)

Frequency Range : 9kHz~1GHz

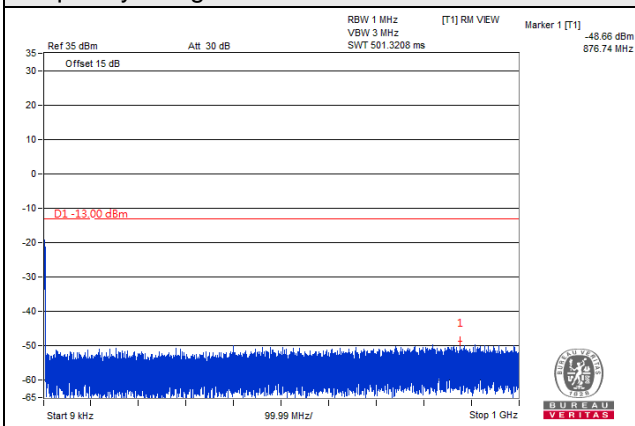

Frequency Range : 1GHz~18GHz

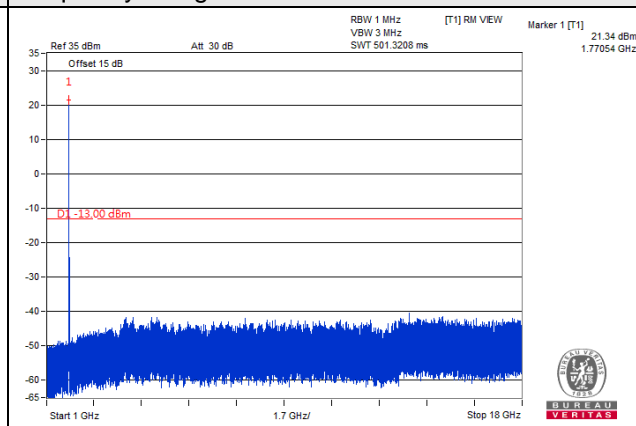

Channel Bandwidth: 15MHz

Channel 132047 (1717.5MHz)

Frequency Range : 9kHz~1GHz

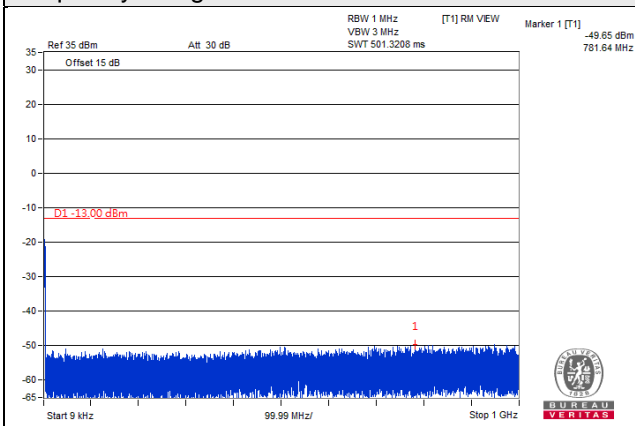

Frequency Range : 1GHz~18GHz

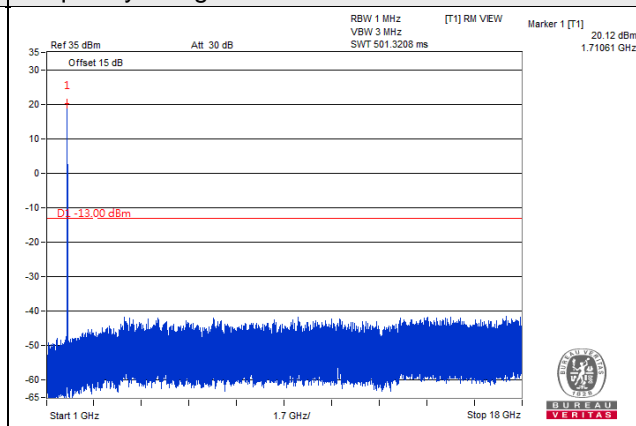

Channel 132322 (1745.0MHz)

Frequency Range : 9kHz~1GHz

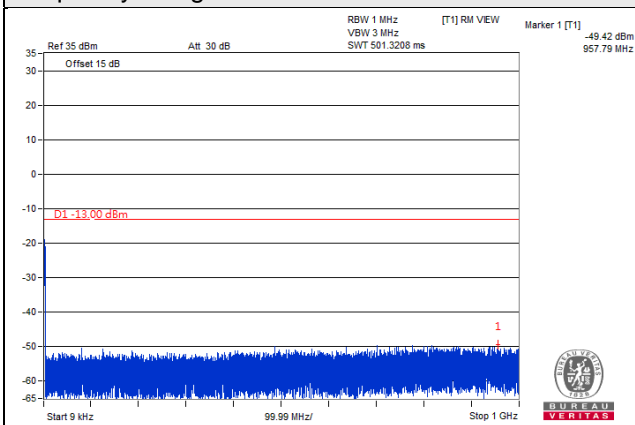

Frequency Range : 1GHz~18GHz

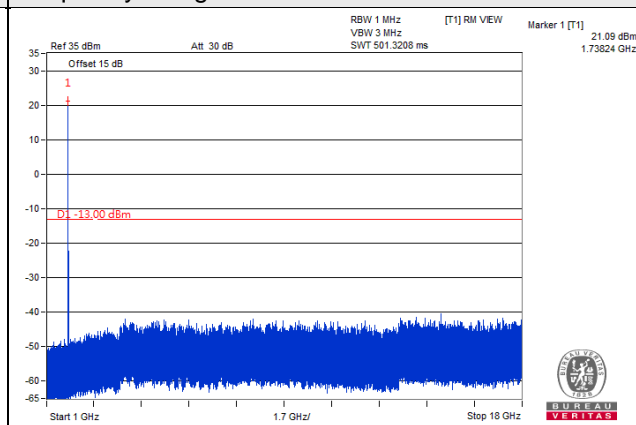

Channel 132597 (1772.5MHz)

Frequency Range : 9kHz~1GHz

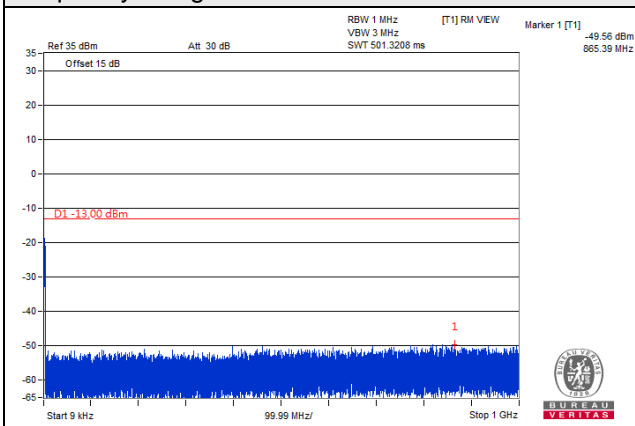

Frequency Range : 1GHz~18GHz

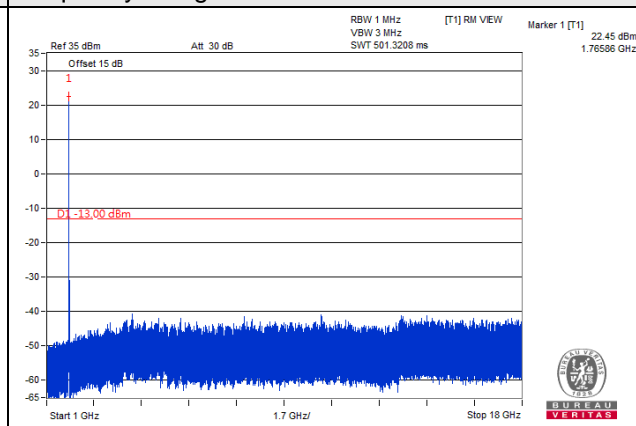

Channel Bandwidth: 20MHz

Channel 132072 (1720.0MHz)

Frequency Range : 9kHz~1GHz

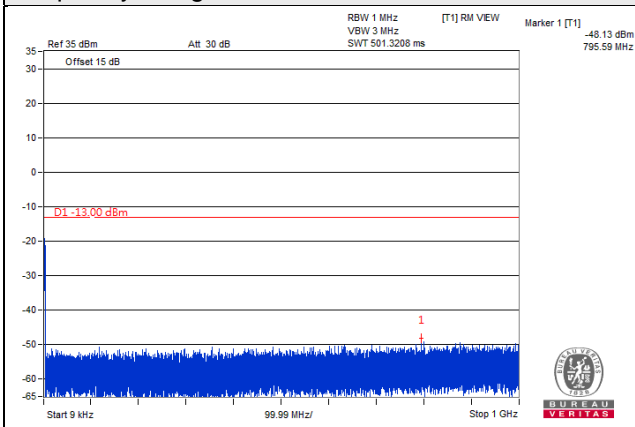

Frequency Range : 1GHz~18GHz

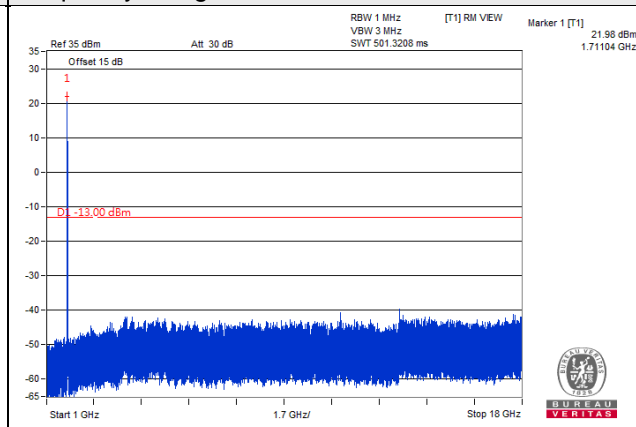

Channel 132322 (1745.0MHz)

Frequency Range : 9kHz~1GHz

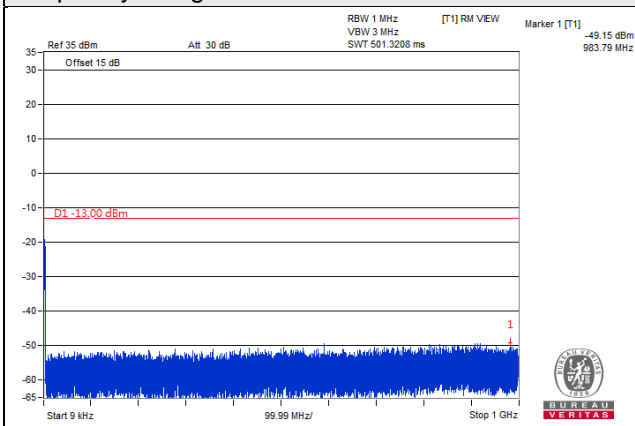

Frequency Range : 1GHz~18GHz

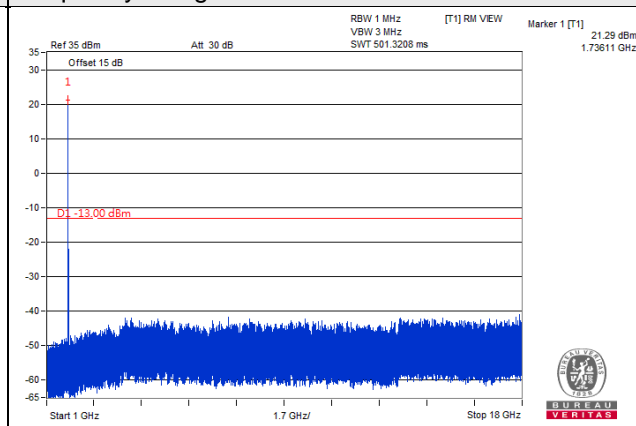

Channel 132572 (1770.0MHz)

Frequency Range : 9kHz~1GHz

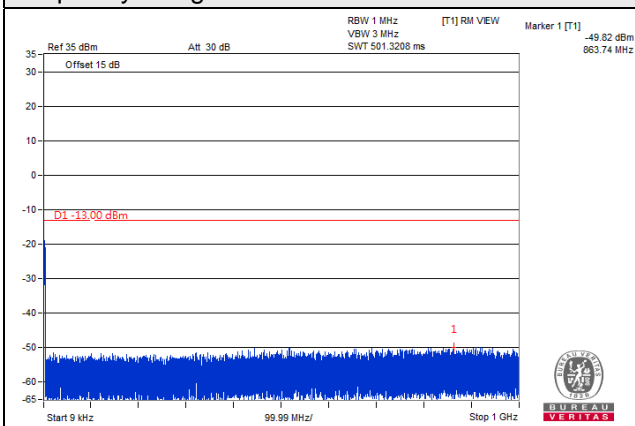

Frequency Range : 1GHz~18GHz

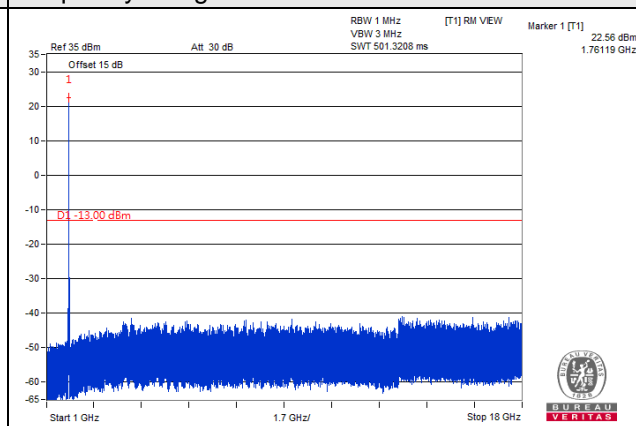

4.8 Radiated Emission Measurement

4.8.1 Limits of Radiated Emission Measurement

For n12

According to FCC 27.53(g) for operations in the 600 MHz band and the 698-746 MHz band, the power of any emission outside a licensee's frequency band(s) of operation shall be attenuated below the transmitter power (P) within the licensed band(s) of operation, measured in watts, by at least $43 + 10 \log(P)$ dB. Compliance with this provision is based on the use of measurement instrumentation employing a resolution bandwidth of 100 kilohertz or greater.

For LTE Band 2:

The power of any emission outside of the authorized operating frequency ranges must be attenuated below the transmitting power (P) by a factor of at least $43 + 10 \log(P)$ dB. The emission limit equal to -13dBm .

For LTE Band 66:

According to FCC 27.53(h) for operations in the 1695-1710 MHz, 1710-1755 MHz, 1755-1780 MHz, 1915-1920 MHz, 1995-2000 MHz, 2000-2020 MHz, 2110-2155 MHz, 2155-2180 MHz, and 2180-2200 bands, the power of any emission outside a licensee's frequency block shall be attenuated below the transmitter power (P) in watts by at least $43 + 10 \log(P)$ dB.

4.8.2 Test Procedure

- a. Substitution method is used for E.I.R.P measurement. In the semi-anechoic chamber, EUT placed on the 0.8m (below or equal 1 GHz) and/or 1.5 m (above 1 GHz) height of Turn Table, rotated the table around 360 degrees to search the maximum radiation power and receiver antenna shall be rotated vertical and horizontal polarization and moved height from 1m to 4m to find the maximum polar radiated power. The "Read Value" is the spectrum reading the maximum power value.
- b. The substitution horn antenna is substituted for EUT at the same position and signals generator export the CW signal to the substitution antenna via a TX cable. Rotated the Turn Table and moved receiving antenna to find the maximum radiation power. Adjust output power level of S.G to get a Value of spectrum reading equal to "Read Value" of step a. Record the power level of S.G
- c. $\text{EIRP} = \text{Output power level of S.G} - \text{TX cable loss} + \text{Antenna gain of substitution horn}$.
- d. E.R.P power can be calculated form E.I.R.P power by subtracting the gain of dipole, $\text{E.R.P power} = \text{E.I.R.P power} - 2.15\text{dBi}$.

NOTE: The resolution bandwidth and video bandwidth of test receiver/spectrum analyzer is 1MHz/3MHz.

4.8.3 Deviation from Test Standard

No deviation.

4.8.4 Test Setup

For radiated emission 30MHz to 1GHz

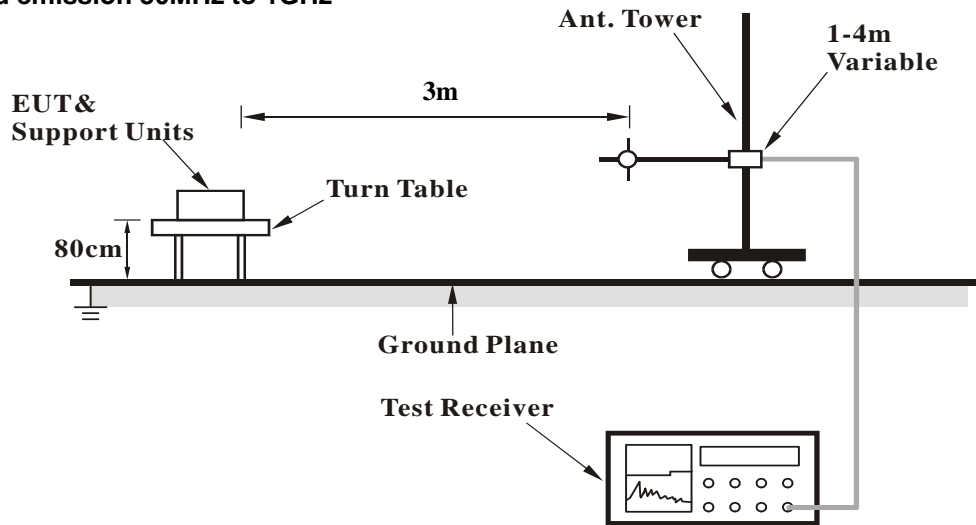

For radiated emission above 1GHz

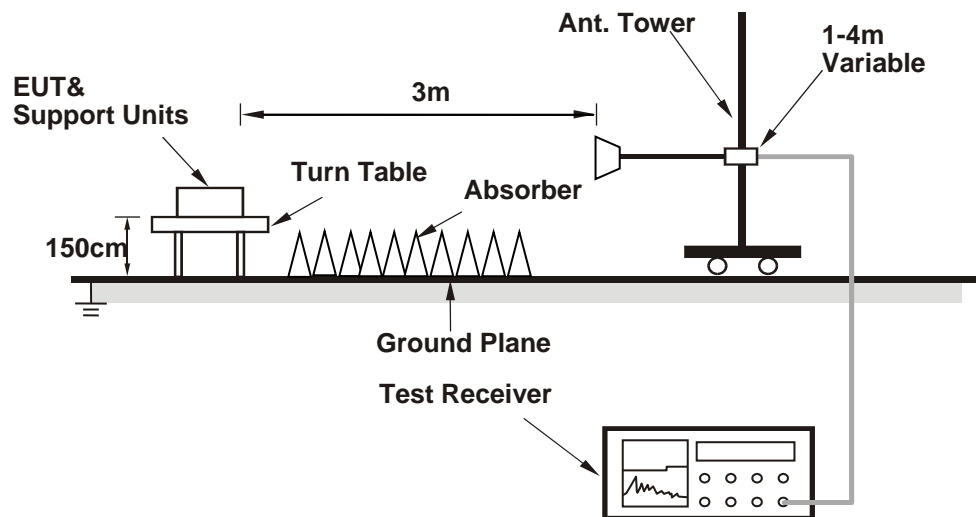

For the actual test configuration, please refer to the attached file (Test Setup Photo).

4.8.5 Test Results

Below 1GHz

n12, Channel Bandwidth: 5MHz

Mode	TX channel 142700 (713.5MHz)	Frequency Range	Below 1000 MHz
Environmental Conditions	22deg. C, 68%RH	Input Power	120Vac, 60Hz
Tested By	Greg Lin		

Antenna Polarity & Test Distance: Horizontal at 3 M

No.	Freq. (MHz)	Reading (dBm)	S.G Power Value (dBm)	Correction Factor (dB)	ERP (dBm)	Limit (dBm)	Margin (dB)
1	32.91	-42.7	-24.0	-17.7	-41.7	-13.0	-28.7
2	87.23	-39.0	-48.3	-0.1	-48.4	-13.0	-35.4
3	166.77	-53.4	-59.3	-2.9	-62.2	-13.0	-49.2
4	282.20	-53.9	-58.6	-1.7	-60.3	-13.0	-47.3
5	632.37	-61.0	-64.6	3.6	-61.0	-13.0	-48.0
6	895.24	-66.2	-64.4	3.5	-60.9	-13.0	-47.9

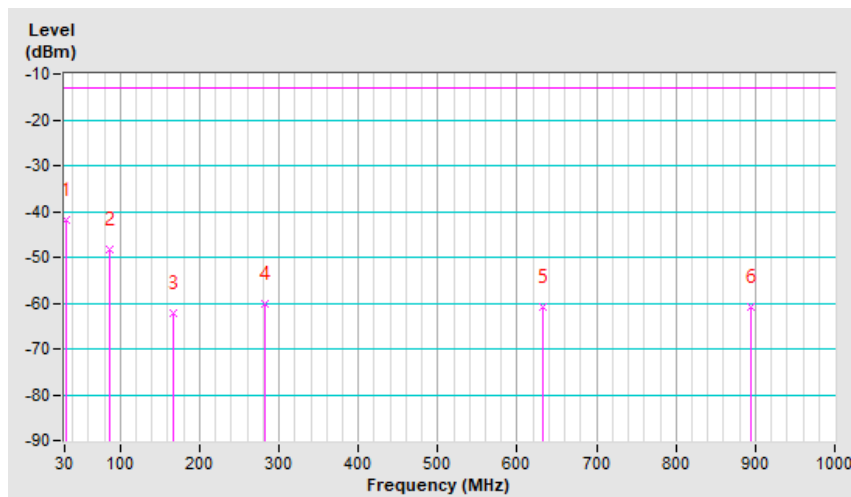

Mode	TX channel 142700 (713.5MHz)	Frequency Range	Below 1000 MHz
Environmental Conditions	22deg. C, 68%RH	Input Power	120Vac, 60Hz
Tested By	Greg Lin		

Antenna Polarity & Test Distance: Vertical at 3 M							
No.	Freq. (MHz)	Reading (dBm)	S.G Power Value (dBm)	Correction Factor (dB)	ERP (dBm)	Limit (dBm)	Margin (dB)
1	54.25	-32.8	-36.1	-5.7	-41.8	-13.0	-28.8
2	87.23	-39.6	-47.9	-0.1	-48.0	-13.0	-35.0
3	168.71	-57.8	-60.3	-2.8	-63.1	-13.0	-50.1
4	261.83	-51.9	-51.3	-1.6	-52.9	-13.0	-39.9
5	454.86	-62.4	-68.3	3.5	-64.8	-13.0	-51.8
6	985.45	-70.8	-67.0	3.5	-63.5	-13.0	-50.5

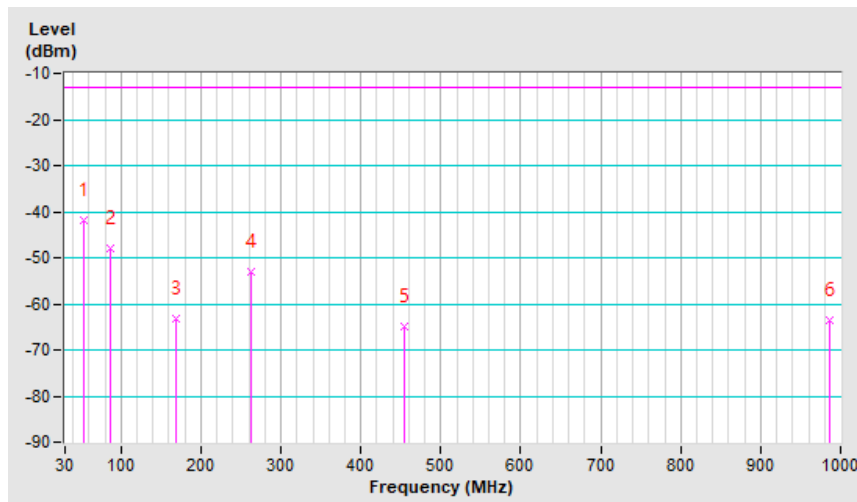

LTE Band 2, Channel Bandwidth: 20MHz

Mode	TX channel 18900 (1880.00MHz)	Frequency Range	Below 1000 MHz
Environmental Conditions	24deg. C, 64%RH	Input Power	120Vac, 60Hz
Tested By	Match Tsui		

Antenna Polarity & Test Distance: Horizontal at 3 M

No.	Freq. (MHz)	Reading (dBm)	S.G Power Value (dBm)	Correction Factor (dB)	EIRP (dBm)	Limit (dBm)	Margin (dB)
1	34.85	-54.7	-50.7	-0.9	-51.6	-13.0	-38.6
2	82.38	-40.3	-44.2	-1.5	-45.7	-13.0	-32.7
3	153.19	-44.1	-46.5	-1.8	-48.3	-13.0	-35.3
4	177.44	-41.4	-47.3	-2.0	-49.3	-13.0	-36.3
5	226.91	-42.2	-48.0	-2.1	-50.1	-13.0	-37.1
6	239.52	-41.6	-46.4	-2.1	-48.5	-13.0	-35.5

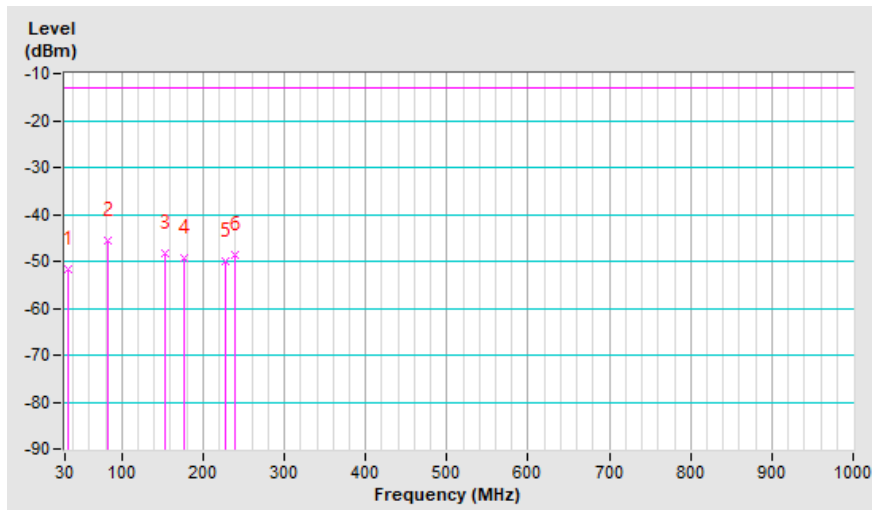

Mode	TX channel 18900 (1880.00MHz)	Frequency Range	Below 1000 MHz
Environmental Conditions	24deg. C, 64%RH	Input Power	120Vac, 60Hz
Tested By	Match Tsui		

Antenna Polarity & Test Distance: Vertical at 3 M							
No.	Freq. (MHz)	Reading (dBm)	S.G Power Value (dBm)	Correction Factor (dB)	EIRP (dBm)	Limit (dBm)	Margin (dB)
1	52.31	-46.5	-52.4	-1.1	-53.5	-13.0	-40.5
2	77.53	-43.0	-47.1	-1.4	-48.5	-13.0	-35.5
3	159.98	-41.6	-42.7	-1.9	-44.6	-13.0	-31.6
4	168.71	-40.7	-41.9	-2.0	-43.9	-13.0	-30.9
5	250.19	-50.4	-48.2	-2.2	-50.4	-13.0	-37.4
6	262.80	-52.0	-48.8	-2.2	-51.0	-13.0	-38.0

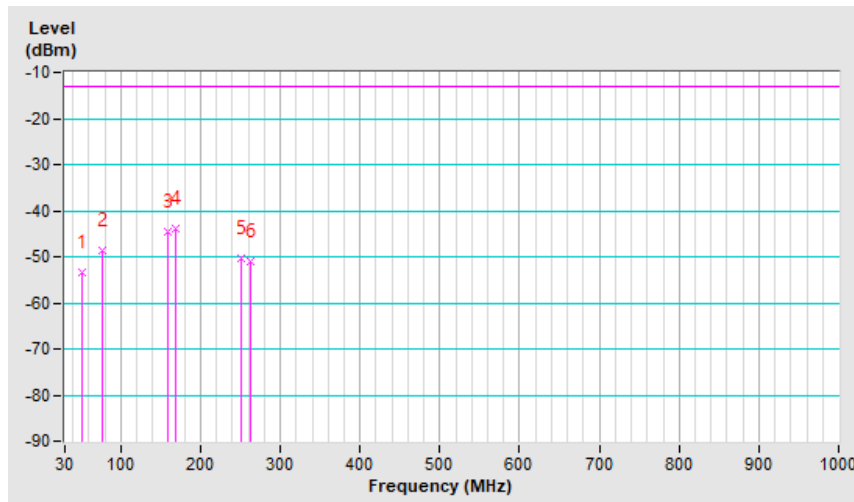

LTE Band 66, Channel Bandwidth: 5MHz

Mode	TX channel 131997 (1712.5MHz)	Frequency Range	Below 1000 MHz
Environmental Conditions	24deg. C, 64%RH	Input Power	120Vac, 60Hz
Tested By	Match Tsui		

Antenna Polarity & Test Distance: Horizontal at 3 M

No.	Freq. (MHz)	Reading (dBm)	S.G Power Value (dBm)	Correction Factor (dB)	EIRP (dBm)	Limit (dBm)	Margin (dB)
1	34.85	-53.2	-49.2	-0.9	-50.1	-13.0	-37.1
2	78.50	-45.0	-48.7	-1.4	-50.1	-13.0	-37.1
3	153.19	-45.5	-47.9	-1.8	-49.7	-13.0	-36.7
4	180.35	-40.0	-46.0	-2.0	-48.0	-13.0	-35.0
5	223.03	-42.1	-48.1	-2.1	-50.2	-13.0	-37.2
6	239.52	-43.1	-47.9	-2.1	-50.0	-13.0	-37.0

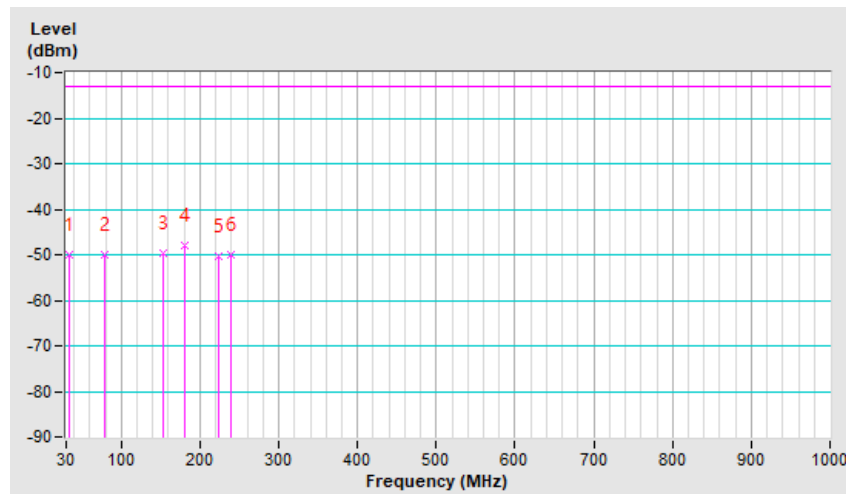

Mode	TX channel 131997 (1712.5MHz)	Frequency Range	Below 1000 MHz
Environmental Conditions	24deg. C, 64%RH	Input Power	120Vac, 60Hz
Tested By	Match Tsui		

Antenna Polarity & Test Distance: Vertical at 3 M

No.	Freq. (MHz)	Reading (dBm)	S.G Power Value (dBm)	Correction Factor (dB)	EIRP (dBm)	Limit (dBm)	Margin (dB)
1	34.85	-42.2	-51.5	-0.9	-52.4	-13.0	-39.4
2	79.47	-46.3	-49.8	-1.4	-51.2	-13.0	-38.2
3	160.95	-44.8	-45.9	-1.9	-47.8	-13.0	-34.8
4	170.65	-43.7	-45.0	-2.0	-47.0	-13.0	-34.0
5	250.19	-50.3	-48.1	-2.2	-50.3	-13.0	-37.3
6	260.86	-53.1	-49.9	-2.2	-52.1	-13.0	-39.1

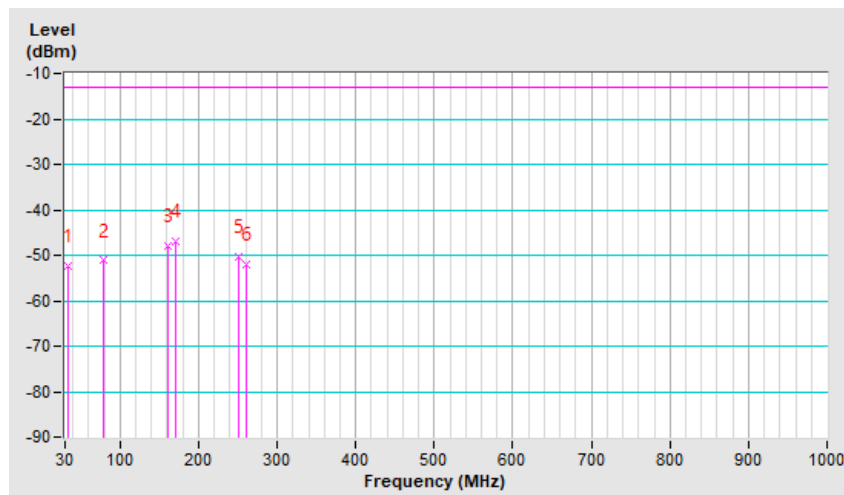

Above 1GHz
n12, Channel Bandwidth: 5MHz

Mode	TX channel 140300 (701.5MHz)	Frequency Range	1GHz ~ 18GHz
Environmental Conditions	22deg. C, 68%RH	Input Power	120Vac, 60Hz
Tested By	Greg Lin		

Antenna Polarity & Test Distance: Horizontal at 3 M

No.	Freq. (MHz)	Reading (dBm)	S.G Power Value (dBm)	Correction Factor (dB)	ERP (dBm)	Limit (dBm)	Margin (dB)
1	1403.00	-62.5	-56.2	0.9	-55.3	-13.0	-42.3

Antenna Polarity & Test Distance: Vertical at 3 M

No.	Freq. (MHz)	Reading (dBm)	S.G Power Value (dBm)	Correction Factor (dB)	ERP (dBm)	Limit (dBm)	Margin (dB)
1	1403.00	-59.9	-54.8	0.9	-53.9	-13.0	-40.9

Mode	TX channel 141500 (707.5MHz)	Frequency Range	1GHz ~ 18GHz
Environmental Conditions	22deg. C, 68%RH	Input Power	120Vac, 60Hz
Tested By	Greg Lin		

Antenna Polarity & Test Distance: Horizontal at 3 M

No.	Freq. (MHz)	Reading (dBm)	S.G Power Value (dBm)	Correction Factor (dB)	ERP (dBm)	Limit (dBm)	Margin (dB)
1	1415.00	-63.0	-56.5	0.9	-55.6	-13.0	-42.6

Antenna Polarity & Test Distance: Vertical at 3 M

No.	Freq. (MHz)	Reading (dBm)	S.G Power Value (dBm)	Correction Factor (dB)	ERP (dBm)	Limit (dBm)	Margin (dB)
1	1415.00	-59.8	-54.4	0.9	-53.5	-13.0	-40.5

Mode	TX channel 142700 (713.5MHz)	Frequency Range	1GHz ~ 18GHz
Environmental Conditions	22deg. C, 68%RH	Input Power	120Vac, 60Hz
Tested By	Greg Lin		

Antenna Polarity & Test Distance: Horizontal at 3 M

No.	Freq. (MHz)	Reading (dBm)	S.G Power Value (dBm)	Correction Factor (dB)	ERP (dBm)	Limit (dBm)	Margin (dB)
1	1427.00	-62.9	-56.2	1.0	-55.2	-13.0	-42.2

Antenna Polarity & Test Distance: Vertical at 3 M

No.	Freq. (MHz)	Reading (dBm)	S.G Power Value (dBm)	Correction Factor (dB)	ERP (dBm)	Limit (dBm)	Margin (dB)
1	1427.00	-59.8	-54.2	1.0	-53.2	-13.0	-40.2

n12, Channel Bandwidth: 10MHz

Mode	TX channel 140800 (704.0MHz)	Frequency Range	1GHz ~ 18GHz
Environmental Conditions	22deg. C, 68%RH	Input Power	120Vac, 60Hz
Tested By	Greg Lin		

Antenna Polarity & Test Distance: Horizontal at 3 M

No.	Freq. (MHz)	Reading (dBm)	S.G Power Value (dBm)	Correction Factor (dB)	ERP (dBm)	Limit (dBm)	Margin (dB)
1	1408.00	-62.5	-56.0	0.9	-55.1	-25.0	-30.1

Antenna Polarity & Test Distance: Vertical at 3 M

No.	Freq. (MHz)	Reading (dBm)	S.G Power Value (dBm)	Correction Factor (dB)	ERP (dBm)	Limit (dBm)	Margin (dB)
1	1408.00	-59.5	-54.3	0.9	-53.4	-25.0	-28.4

Mode	TX channel 141500 (707.5MHz)	Frequency Range	1GHz ~ 18GHz
Environmental Conditions	22deg. C, 68%RH	Input Power	120Vac, 60Hz
Tested By	Greg Lin		

Antenna Polarity & Test Distance: Horizontal at 3 M

No.	Freq. (MHz)	Reading (dBm)	S.G Power Value (dBm)	Correction Factor (dB)	ERP (dBm)	Limit (dBm)	Margin (dB)
1	1415.00	-62.8	-56.2	0.9	-55.3	-25.0	-30.3

Antenna Polarity & Test Distance: Vertical at 3 M

No.	Freq. (MHz)	Reading (dBm)	S.G Power Value (dBm)	Correction Factor (dB)	ERP (dBm)	Limit (dBm)	Margin (dB)
1	1415.00	-59.2	-53.9	0.9	-53.0	-25.0	-28.0

Mode	TX channel 142200 (711.0MHz)	Frequency Range	1GHz ~ 18GHz
Environmental Conditions	22deg. C, 68%RH	Input Power	120Vac, 60Hz
Tested By	Greg Lin		

Antenna Polarity & Test Distance: Horizontal at 3 M

No.	Freq. (MHz)	Reading (dBm)	S.G Power Value (dBm)	Correction Factor (dB)	ERP (dBm)	Limit (dBm)	Margin (dB)
1	1422.00	-62.9	-56.4	1.0	-55.4	-25.0	-30.4

Antenna Polarity & Test Distance: Vertical at 3 M

No.	Freq. (MHz)	Reading (dBm)	S.G Power Value (dBm)	Correction Factor (dB)	ERP (dBm)	Limit (dBm)	Margin (dB)
1	1422.00	-59.7	-54.2	1.0	-53.2	-25.0	-28.2

n12, Channel Bandwidth: 15MHz

Mode	TX channel 141300 (706.5MHz)	Frequency Range	1GHz ~ 18GHz
Environmental Conditions	22deg. C, 68%RH	Input Power	120Vac, 60Hz
Tested By	Greg Lin		

Antenna Polarity & Test Distance: Horizontal at 3 M

No.	Freq. (MHz)	Reading (dBm)	S.G Power Value (dBm)	Correction Factor (dB)	ERP (dBm)	Limit (dBm)	Margin (dB)
1	1413.00	-63.0	-56.5	0.9	-55.6	-13.0	-42.6

Antenna Polarity & Test Distance: Vertical at 3 M

No.	Freq. (MHz)	Reading (dBm)	S.G Power Value (dBm)	Correction Factor (dB)	ERP (dBm)	Limit (dBm)	Margin (dB)
1	1413.00	-59.8	-54.4	0.9	-53.5	-13.0	-40.5

Mode	TX channel 141500 (707.5MHz)	Frequency Range	1GHz ~ 18GHz
Environmental Conditions	22deg. C, 68%RH	Input Power	120Vac, 60Hz
Tested By	Greg Lin		

Antenna Polarity & Test Distance: Horizontal at 3 M

No.	Freq. (MHz)	Reading (dBm)	S.G Power Value (dBm)	Correction Factor (dB)	ERP (dBm)	Limit (dBm)	Margin (dB)
1	1415.00	-62.8	-56.2	0.9	-55.3	-13.0	-42.3

Antenna Polarity & Test Distance: Vertical at 3 M

No.	Freq. (MHz)	Reading (dBm)	S.G Power Value (dBm)	Correction Factor (dB)	ERP (dBm)	Limit (dBm)	Margin (dB)
1	1415.00	-59.9	-54.5	0.9	-53.6	-13.0	-40.6

Mode	TX channel 141700 (708.5MHz)	Frequency Range	1GHz ~ 18GHz
Environmental Conditions	22deg. C, 68%RH	Input Power	120Vac, 60Hz
Tested By	Greg Lin		

Antenna Polarity & Test Distance: Horizontal at 3 M

No.	Freq. (MHz)	Reading (dBm)	S.G Power Value (dBm)	Correction Factor (dB)	ERP (dBm)	Limit (dBm)	Margin (dB)
1	1417.00	-62.3	-55.8	0.9	-54.9	-13.0	-41.9

Antenna Polarity & Test Distance: Vertical at 3 M

No.	Freq. (MHz)	Reading (dBm)	S.G Power Value (dBm)	Correction Factor (dB)	ERP (dBm)	Limit (dBm)	Margin (dB)
1	1417.00	-59.5	-54.0	0.9	-53.1	-13.0	-40.1

LTE Band 2, Channel Bandwidth: 1.4MHz

Mode	TX channel 18607 (1850.70MHz)	Frequency Range	1GHz ~ 20GHz
Environmental Conditions	22deg. C, 68%RH	Input Power	120Vac, 60Hz
Tested By	Greg Lin		

Antenna Polarity & Test Distance: Horizontal at 3 M

No.	Freq. (MHz)	Reading (dBm)	S.G Power Value (dBm)	Correction Factor (dB)	EIRP (dBm)	Limit (dBm)	Margin (dB)
1	3701.40	-62.6	-54.1	1.4	-52.7	-13.0	-39.7

Antenna Polarity & Test Distance: Vertical at 3 M

No.	Freq. (MHz)	Reading (dBm)	S.G Power Value (dBm)	Correction Factor (dB)	EIRP (dBm)	Limit (dBm)	Margin (dB)
1	3701.40	-60.3	-52.1	1.4	-50.7	-13.0	-37.7

Mode	TX channel 18900 (1880.00MHz)	Frequency Range	1GHz ~ 20GHz
Environmental Conditions	22deg. C, 68%RH	Input Power	120Vac, 60Hz
Tested By	Greg Lin		

Antenna Polarity & Test Distance: Horizontal at 3 M

No.	Freq. (MHz)	Reading (dBm)	S.G Power Value (dBm)	Correction Factor (dB)	EIRP (dBm)	Limit (dBm)	Margin (dB)
1	3760.00	-62.3	-53.8	1.3	-52.5	-13.0	-39.5

Antenna Polarity & Test Distance: Vertical at 3 M

No.	Freq. (MHz)	Reading (dBm)	S.G Power Value (dBm)	Correction Factor (dB)	EIRP (dBm)	Limit (dBm)	Margin (dB)
1	3760.00	-60.4	-52.1	1.3	-50.8	-13.0	-37.8

Mode	TX channel 19193 (1909.30MHz)	Frequency Range	1GHz ~ 20GHz
Environmental Conditions	22deg. C, 68%RH	Input Power	120Vac, 60Hz
Tested By	Greg Lin		

Antenna Polarity & Test Distance: Horizontal at 3 M

No.	Freq. (MHz)	Reading (dBm)	S.G Power Value (dBm)	Correction Factor (dB)	EIRP (dBm)	Limit (dBm)	Margin (dB)
1	3818.60	-61.8	-53.5	1.4	-52.1	-13.0	-39.1

Antenna Polarity & Test Distance: Vertical at 3 M

No.	Freq. (MHz)	Reading (dBm)	S.G Power Value (dBm)	Correction Factor (dB)	EIRP (dBm)	Limit (dBm)	Margin (dB)
1	3818.60	-60.9	-52.7	1.4	-51.3	-13.0	-38.3

LTE Band 2, Channel Bandwidth 5MHz

Mode	TX channel 18625 (1852.50MHz)	Frequency Range	1GHz ~ 20GHz
Environmental Conditions	22deg. C, 68%RH	Input Power	120Vac, 60Hz
Tested By	Greg Lin		

Antenna Polarity & Test Distance: Horizontal at 3 M							
No.	Freq. (MHz)	Reading (dBm)	S.G Power Value (dBm)	Correction Factor (dB)	EIRP (dBm)	Limit (dBm)	Margin (dB)
1	3705.00	-62.4	-53.9	1.4	-52.5	-13.0	-39.5
Antenna Polarity & Test Distance: Vertical at 3 M							
No.	Freq. (MHz)	Reading (dBm)	S.G Power Value (dBm)	Correction Factor (dB)	EIRP (dBm)	Limit (dBm)	Margin (dB)
1	3705.00	-60.5	-52.3	1.4	-50.9	-13.0	-37.9

Mode	TX channel 18900 (1880.00MHz)	Frequency Range	1GHz ~ 20GHz
Environmental Conditions	22deg. C, 68%RH	Input Power	120Vac, 60Hz
Tested By	Greg Lin		

Antenna Polarity & Test Distance: Horizontal at 3 M							
No.	Freq. (MHz)	Reading (dBm)	S.G Power Value (dBm)	Correction Factor (dB)	EIRP (dBm)	Limit (dBm)	Margin (dB)
1	3760.00	-61.8	-53.3	1.3	-52.0	-13.0	-39.0
Antenna Polarity & Test Distance: Vertical at 3 M							
No.	Freq. (MHz)	Reading (dBm)	S.G Power Value (dBm)	Correction Factor (dB)	EIRP (dBm)	Limit (dBm)	Margin (dB)
1	3760.00	-60.1	-51.8	1.3	-50.5	-13.0	-37.5

Mode	TX channel 19175 (1907.50MHz)	Frequency Range	1GHz ~ 20GHz
Environmental Conditions	22deg. C, 68%RH	Input Power	120Vac, 60Hz
Tested By	Greg Lin		

Antenna Polarity & Test Distance: Horizontal at 3 M							
No.	Freq. (MHz)	Reading (dBm)	S.G Power Value (dBm)	Correction Factor (dB)	EIRP (dBm)	Limit (dBm)	Margin (dB)
1	3815.00	-62.7	-54.4	1.4	-53.0	-13.0	-40.0
Antenna Polarity & Test Distance: Vertical at 3 M							
No.	Freq. (MHz)	Reading (dBm)	S.G Power Value (dBm)	Correction Factor (dB)	EIRP (dBm)	Limit (dBm)	Margin (dB)
1	3815.00	-60.2	-52.0	1.4	-50.6	-13.0	-37.6

LTE Band 2, Channel Bandwidth 20MHz

Mode	TX channel 18700 (1860.00MHz)	Frequency Range	1GHz ~ 20GHz
Environmental Conditions	22deg. C, 68%RH	Input Power	120Vac, 60Hz
Tested By	Greg Lin		

Antenna Polarity & Test Distance: Horizontal at 3 M							
No.	Freq. (MHz)	Reading (dBm)	S.G Power Value (dBm)	Correction Factor (dB)	EIRP (dBm)	Limit (dBm)	Margin (dB)
1	3720.00	-62.5	-54.0	1.4	-52.6	-13.0	-39.6
Antenna Polarity & Test Distance: Vertical at 3 M							
No.	Freq. (MHz)	Reading (dBm)	S.G Power Value (dBm)	Correction Factor (dB)	EIRP (dBm)	Limit (dBm)	Margin (dB)
1	3720.00	-60.6	-52.4	1.4	-51.0	-13.0	-38.0

Mode	TX channel 18900 (1880.00MHz)	Frequency Range	1GHz ~ 20GHz
Environmental Conditions	22deg. C, 68%RH	Input Power	120Vac, 60Hz
Tested By	Greg Lin		

Antenna Polarity & Test Distance: Horizontal at 3 M							
No.	Freq. (MHz)	Reading (dBm)	S.G Power Value (dBm)	Correction Factor (dB)	EIRP (dBm)	Limit (dBm)	Margin (dB)
1	3760.00	-61.9	-53.4	1.3	-52.1	-13.0	-39.1
Antenna Polarity & Test Distance: Vertical at 3 m							
No.	Freq. (MHz)	Reading (dBm)	S.G Power Value (dBm)	Correction Factor (dB)	EIRP (dBm)	Limit (dBm)	Margin (dB)
1	3760.00	-59.9	-51.6	1.3	-50.3	-13.0	-37.3

Mode	TX channel 19100 (1900.00MHz)	Frequency Range	1GHz ~ 20GHz
Environmental Conditions	22deg. C, 68%RH	Input Power	120Vac, 60Hz
Tested By	Greg Lin		

Antenna Polarity & Test Distance: Horizontal at 3 M							
No.	Freq. (MHz)	Reading (dBm)	S.G Power Value (dBm)	Correction Factor (dB)	EIRP (dBm)	Limit (dBm)	Margin (dB)
1	3800.00	-62.2	-53.8	1.3	-52.5	-13.0	-39.5
Antenna Polarity & Test Distance: Vertical at 3 M							
No.	Freq. (MHz)	Reading (dBm)	S.G Power Value (dBm)	Correction Factor (dB)	EIRP (dBm)	Limit (dBm)	Margin (dB)
1	3800.00	-60.3	-52.1	1.3	-50.8	-13.0	-37.8

LTE Band 66, Channel Bandwidth: 1.4MHz

Mode	TX channel 131979 (1710.7MHz)	Frequency Range	1GHz ~ 18GHz
Environmental Conditions	22deg. C, 68%RH	Input Power	120Vac, 60Hz
Tested By	Greg Lin		

Antenna Polarity & Test Distance: Horizontal at 3 M

No.	Freq. (MHz)	Reading (dBm)	S.G Power Value (dBm)	Correction Factor (dB)	EIRP (dBm)	Limit (dBm)	Margin (dB)
1	3421.40	-63.9	-55.3	1.3	-54.0	-13.0	-41.0

Antenna Polarity & Test Distance: Vertical at 3 M

No.	Freq. (MHz)	Reading (dBm)	S.G Power Value (dBm)	Correction Factor (dB)	EIRP (dBm)	Limit (dBm)	Margin (dB)
1	3421.40	-61.6	-53.5	1.3	-52.2	-13.0	-39.2

Mode	TX channel 132322 (1745.0MHz)	Frequency Range	1GHz ~ 18GHz
Environmental Conditions	22deg. C, 68%RH	Input Power	120Vac, 60Hz
Tested By	Greg Lin		

Antenna Polarity & Test Distance: Horizontal at 3 M

No.	Freq. (MHz)	Reading (dBm)	S.G Power Value (dBm)	Correction Factor (dB)	EIRP (dBm)	Limit (dBm)	Margin (dB)
1	3490.00	-63.5	-55.3	1.5	-53.8	-13.0	-40.8

Antenna Polarity & Test Distance: Vertical at 3 M

No.	Freq. (MHz)	Reading (dBm)	S.G Power Value (dBm)	Correction Factor (dB)	EIRP (dBm)	Limit (dBm)	Margin (dB)
1	3490.00	-61.4	-53.8	1.5	-52.3	-13.0	-39.3

Mode	TX channel 132665 (1779.3MHz)	Frequency Range	1GHz ~ 18GHz
Environmental Conditions	22deg. C, 68%RH	Input Power	120Vac, 60Hz
Tested By	Greg Lin		

Antenna Polarity & Test Distance: Horizontal at 3 M

No.	Freq. (MHz)	Reading (dBm)	S.G Power Value (dBm)	Correction Factor (dB)	EIRP (dBm)	Limit (dBm)	Margin (dB)
1	3558.60	-64.0	-55.5	1.4	-54.1	-13.0	-41.1

Antenna Polarity & Test Distance: Vertical at 3 M

No.	Freq. (MHz)	Reading (dBm)	S.G Power Value (dBm)	Correction Factor (dB)	EIRP (dBm)	Limit (dBm)	Margin (dB)
1	3558.60	-61.5	-53.7	1.4	-52.3	-13.0	-39.3

LTE Band 66, Channel Bandwidth: 5MHz

Mode	TX channel 131997 (1712.5MHz)	Frequency Range	1GHz ~ 18GHz
Environmental Conditions	22deg. C, 68%RH	Input Power	120Vac, 60Hz
Tested By	Greg Lin		

Antenna Polarity & Test Distance: Horizontal at 3 M

No.	Freq. (MHz)	Reading (dBm)	S.G Power Value (dBm)	Correction Factor (dB)	EIRP (dBm)	Limit (dBm)	Margin (dB)
1	3425.00	-63.8	-55.2	1.3	-53.9	-13.0	-40.9

Antenna Polarity & Test Distance: Vertical at 3 M

No.	Freq. (MHz)	Reading (dBm)	S.G Power Value (dBm)	Correction Factor (dB)	EIRP (dBm)	Limit (dBm)	Margin (dB)
1	3425.00	-61.1	-53.0	1.3	-51.7	-13.0	-38.7

Mode	TX channel 132322 (1745.0MHz)	Frequency Range	1GHz ~ 18GHz
Environmental Conditions	22deg. C, 68%RH	Input Power	120Vac, 60Hz
Tested By	Greg Lin		

Antenna Polarity & Test Distance: Horizontal at 3 M

No.	Freq. (MHz)	Reading (dBm)	S.G Power Value (dBm)	Correction Factor (dB)	EIRP (dBm)	Limit (dBm)	Margin (dB)
1	3490.00	-63.9	-55.7	1.5	-54.2	-13.0	-41.2

Antenna Polarity & Test Distance: Vertical at 3 M

No.	Freq. (MHz)	Reading (dBm)	S.G Power Value (dBm)	Correction Factor (dB)	EIRP (dBm)	Limit (dBm)	Margin (dB)
1	3490.00	-61.5	-53.9	1.5	-52.4	-13.0	-39.4

Mode	TX channel 132647 (1777.5MHz)	Frequency Range	1GHz ~ 18GHz
Environmental Conditions	22deg. C, 68%RH	Input Power	120Vac, 60Hz
Tested By	Greg Lin		

Antenna Polarity & Test Distance: Horizontal at 3 M

No.	Freq. (MHz)	Reading (dBm)	S.G Power Value (dBm)	Correction Factor (dB)	EIRP (dBm)	Limit (dBm)	Margin (dB)
1	3555.00	-63.7	-55.3	1.4	-53.9	-13.0	-40.9

Antenna Polarity & Test Distance: Vertical at 3 M

No.	Freq. (MHz)	Reading (dBm)	S.G Power Value (dBm)	Correction Factor (dB)	EIRP (dBm)	Limit (dBm)	Margin (dB)
1	3555.00	-62.0	-54.2	1.4	-52.8	-13.0	-39.8

LTE Band 66, Channel Bandwidth: 20MHz

Mode	TX channel 132072 (1720.0MHz)	Frequency Range	1GHz ~ 18GHz
Environmental Conditions	22deg. C, 68%RH	Input Power	120Vac, 60Hz
Tested By	Greg Lin		

Antenna Polarity & Test Distance: Horizontal at 3 M							
No.	Freq. (MHz)	Reading (dBm)	S.G Power Value (dBm)	Correction Factor (dB)	EIRP (dBm)	Limit (dBm)	Margin (dB)
1	3440.00	-63.2	-54.7	1.3	-53.4	-13.0	-40.4
Antenna Polarity & Test Distance: Vertical at 3 M							
No.	Freq. (MHz)	Reading (dBm)	S.G Power Value (dBm)	Correction Factor (dB)	EIRP (dBm)	Limit (dBm)	Margin (dB)
1	3440.00	-61.4	-53.4	1.3	-52.1	-13.0	-39.1

Mode	TX channel 132322 (1745.0MHz)	Frequency Range	1GHz ~ 18GHz
Environmental Conditions	22deg. C, 68%RH	Input Power	120Vac, 60Hz
Tested By	Greg Lin		

Antenna Polarity & Test Distance: Horizontal at 3 M							
No.	Freq. (MHz)	Reading (dBm)	S.G Power Value (dBm)	Correction Factor (dB)	EIRP (dBm)	Limit (dBm)	Margin (dB)
1	3490.00	-63.4	-55.2	1.5	-53.7	-13.0	-40.7
Antenna Polarity & Test Distance: Vertical at 3 M							
No.	Freq. (MHz)	Reading (dBm)	S.G Power Value (dBm)	Correction Factor (dB)	EIRP (dBm)	Limit (dBm)	Margin (dB)
1	3490.00	-61.6	-54.0	1.5	-52.5	-13.0	-39.5

Mode	TX channel 132572 (1770.0MHz)	Frequency Range	1GHz ~ 18GHz
Environmental Conditions	22deg. C, 68%RH	Input Power	120Vac, 60Hz
Tested By	Greg Lin		

Antenna Polarity & Test Distance: Horizontal at 3 M							
No.	Freq. (MHz)	Reading (dBm)	S.G Power Value (dBm)	Correction Factor (dB)	EIRP (dBm)	Limit (dBm)	Margin (dB)
1	3540.00	-63.2	-54.8	1.4	-53.4	-13.0	-40.4
Antenna Polarity & Test Distance: Vertical at 3 M							
No.	Freq. (MHz)	Reading (dBm)	S.G Power Value (dBm)	Correction Factor (dB)	EIRP (dBm)	Limit (dBm)	Margin (dB)
1	3540.00	-61.5	-53.7	1.4	-52.3	-13.0	-39.3

5 Pictures of Test Arrangements

Please refer to the attached file (Test Setup Photo).

Appendix – Information of the Testing Laboratories

We, Bureau Veritas Consumer Products Services (H.K.) Ltd., Taoyuan Branch, were founded in 1988 to provide our best service in EMC, Radio, Telecom and Safety consultation. Our laboratories are FCC recognized accredited test firms and accredited and approved according to ISO/IEC 17025.

If you have any comments, please feel free to contact us at the following:

Lin Kou EMC/RF Lab

Tel: 886-2-26052180

Fax: 886-2-26051924

Hsin Chu EMC/RF/Telecom Lab

Tel: 886-3-6668565

Fax: 886-3-6668323

Hwa Ya EMC/RF/Safety Lab

Tel: 886-3-3183232

Fax: 886-3-3270892

Email: service.adt@tw.bureauveritas.com

Web Site: www.bureauveritas-adt.com

The address and road map of all our labs can be found in our web site also.

--- END ---