

FCC RF Test Report

APPLICANT : Fibocom Wireless Inc.
EQUIPMENT : LTE Module
BRAND NAME : Fibocom
MODEL NAME : L860-GL-16
FCC ID : ZMOL860GL16
STANDARD : 47 CFR Part 2, 90(R)
CLASSIFICATION : PCS Licensed Transmitter (PCB)

The product was received on Oct. 30, 2020 and completely tested on Jan. 23, 2021. We, Sporton International (Kunshan) Inc., would like to declare that the tested sample has been evaluated in accordance with the procedures given in ANSI C63.26 and shown compliance with the applicable technical standards.

The test results in this report apply exclusively to the tested model / sample. Without written approval of Sporton International (Kunshan) Inc., the test report shall not be reproduced except in full.

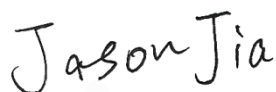

Reviewed by: Jason Jia / Supervisor



Approved by: James Huang / Manager



Sporton International (Kunshan) Inc.

**No. 1098, Pengxi North Road, Kunshan Economic Development Zone Jiangsu Province 215300
People's Republic of China**



TABLE OF CONTENTS

REVISION HISTORY..... 3
SUMMARY OF TEST RESULT 4
1 GENERAL DESCRIPTION 5
1.1 Applicant 5
1.2 Manufacturer 5
1.3 Feature of Equipment Under Test 5
1.4 Maximum ERP Power, Frequency Tolerance, and Emission Designator 5
1.5 Testing Site 6
1.6 Test Software 6
1.7 Applied Standards 6
2 TEST CONFIGURATION OF EQUIPMENT UNDER TEST 7
2.1 Test Mode 7
2.2 Connection Diagram of Test System 8
2.3 Support Unit used in test configuration and system 8
2.4 Measurement Results Explanation Example 9
3 CONDUCTED TEST ITEMS 10
3.1 Measuring Instruments 10
3.2 Conducted Output Power and ERP 11
3.3 Peak-to-Average Ratio 12
3.4 Occupied Bandwidth 13
3.5 Conducted Band Edge Measurement 14
3.6 Emission Mask 15
3.7 Conducted Spurious Emission Measurement 16
3.8 Frequency Stability Measurement 17
4 RADIATED TEST ITEMS 18
4.1 Measuring Instruments 18
4.2 Test Setup 18
4.3 Test Result of Radiated Test 18
4.4 Radiated Spurious Emission Measurement 19
5 LIST OF MEASURING EQUIPMENT 20
6 UNCERTAINTY OF EVALUATION 21
APPENDIX A. TEST RESULTS OF CONDUCTED TEST
APPENDIX B. TEST RESULTS OF RADIATED TEST
APPENDIX C. TEST SETUP PHOTOGRAPHS



REVISION HISTORY

REPORT NO.	VERSION	DESCRIPTION	ISSUED DATE
FG003022D	Rev. 01	Initial issue of report	Feb. 07, 2021



SUMMARY OF TEST RESULT

Report Section	FCC Rule	Description	Limit	Result	Remark
3.2	§2.1046	Conducted Output Power	Reporting only	PASS	-
	§90.542 (a)(7)	Effective Radiated Power	ERP < 3Watt	PASS	-
3.3	-	Peak-to-Average Ratio	Reporting only	-	-
3.4	§2.1049	Occupied Bandwidth	Reporting only	PASS	-
3.5	§2.1053	Conducted Band Edge Measurement	Refer standard	PASS	-
	§90.543 (e)(2)(3)				
3.6	§2.1051	Emission Mask	Mask B	PASS	-
	§90.210(n)				
3.7	§2.1053	Conducted Spurious Emission	< 43+10log ₁₀ (P[Watts])	PASS	-
	§90.543 (e)(3)				
3.8	§2.1055	Frequency Stability Temperature & Voltage	< ±1.25 ppm	PASS	-
	§90.539 (e)				
4.4	§2.1053	Radiated Spurious Emission	< 43+10log ₁₀ (P[Watts])	PASS	Under limit 24.63 dB at 1576.000 MHz
	§90.543 (e)(3)				
	§90.543 (f)				

Declaration of Conformity:

The test results with all measurement uncertainty excluded are presented in accordance with the regulation limits or requirements declared by manufacturers.

Comments and Explanations:

The declared of product specification for EUT presented in the report are provided by the manufacturer, and the manufacturer takes all the responsibilities for the accuracy of product specification.



1 General Description

1.1 Applicant

Fibocom Wireless Inc.

1101, Tower A, Building 6, Shenzhen International Innovation Valley, Dashi 1st Rd, Nanshan, Shenzhen, China

1.2 Manufacturer

Fibocom Wireless Inc.

1101, Tower A, Building 6, Shenzhen International Innovation Valley, Dashi 1st Rd, Nanshan, Shenzhen, China

1.3 Feature of Equipment Under Test

Product Feature	
Equipment	LTE Module
Brand Name	Fibocom
Model Name	L860-GL-16
FCC ID	ZMOL860GL16
Tx Frequency	LTE Band 14: 788 MHz ~ 798 MHz
Rx Frequency	LTE Band 14: 758 MHz ~ 768 MHz
Maximum Output Power to Antenna	23.35 dBm
Antenna Gain	3.0 dBi
Type of Modulation	QPSK / 16QAM / 64QAM
HW Version	V1.3
SW Version	18601.5001.00.01.01.01
EUT Stage	Identical Prototype

Remark: The above EUT's information was declared by manufacturer. Please refer to the specifications or user's manual for more detailed description.

1.4 Maximum Conducted Power, Frequency Tolerance, and Emission Designator

LTE Band 14		QPSK			16QAM		
BW (MHz)	Frequency Range (MHz)	Emission Designator (99%OBW)	Frequency Tolerance (ppm)	Maximum Conducted power (W)	Emission Designator (99%OBW)	Frequency Tolerance (ppm)	Maximum Conducted power (W)
5	790.5~795.5	4M51G7D	-	0.2148	4M51W7D	-	0.1901
10	793	9M03G7D	0.0044	0.2163	9M05W7D	-	0.1905

1.5 Testing Site

Sporton International (Kunshan) Inc. is accredited to ISO/IEC 17025:2017 by American Association for Laboratory Accreditation with Certificate Number 5145.02.

Test Firm	Sporton International (Kunshan) Inc.		
Test Site Location	No. 1098, Pengxi North Road, Kunshan Economic Development Zone Jiangsu Province 215300 People's Republic of China TEL : +86-512-57900158 FAX : +86-512-57900958		
Test Site No.	Sporton Site No.	FCC Designation No.	FCC Test Firm Registration No.
	03CH06-KS TH01-KS	CN1257	314309

1.6 Test Software

Item	Site	Manufacturer	Name	Version
1.	03CH06-KS	AUDIX	E3	6.2009-8-24al

1.7 Applied Standards

According to the specifications of the manufacturer, the EUT must comply with the requirements of the following standards:

- ♦ 47 CFR Part 2, Part 90(R)
- ♦ ANSI C63.26
- ♦ KDB 971168 D01 Power Meas License Digital Systems v03r01
- ♦ KDB 412172 D01 Determining ERP and EIRP v01r01

Remark:

1. All test items were verified and recorded according to the standards and without any deviation during the test.
2. This EUT has also been tested and complied with the requirements of FCC Part 15, Subpart B, recorded in a separate test report.



2 Test Configuration of Equipment Under Test

2.1 Test Mode

Antenna port conducted and radiated test items listed below are performed according to KDB 971168 D01 Power Meas License Digital Systems v03r01 with maximum output power.

Radiated measurements are performed by rotating the EUT in three different orthogonal test planes to find the maximum emission.

Conducted Test Cases	Band	Bandwidth (MHz)						Modulation			RB #			Test Channel		
		1.4	3	5	10	15	20	QPSK	16QAM	64QAM	1	Half	Full	L	M	H
Max. Output Power	14	-	-	V	-	-	-	V	V	V	V	V	V	V	V	V
Peak-to-Average Ratio	14	-	-		V	-	-	V	V				V		V	
26dB and 99% Bandwidth	14	-	-	V		-	-	V	V				V	V	V	V
	14	-	-		V	-	-	V	V				V		V	
Conducted Band Edge	14	-	-	V		-	-	V	V		V		V	V		V
	14	-	-		V	-	-	V	V		V		V		V	
Emission Mask	14	-	-	V		-	-	V	V		V		V	V	V	V
	14	-	-		V	-	-	V	V		V		V		V	
Conducted Spurious Emission	14	-	-	V		-	-	V			V			V	V	V
	14	-	-		V	-	-	V			V				V	
Frequency Stability	14	-	-		V	-	-	V			V					V
E.R.P	14	-	-	V		-	-	V	V		V			V	V	V
	14	-	-		V	-	-	V	V		V				V	
Radiated Spurious Emission	14	-	-	V	V	-	-	V			V					V

Note

1. The mark "v " means that this configuration is chosen for testing
2. The mark "- " means that this bandwidth is not supported.
3. The device is investigated from 30MHz to 10 times of fundamental signal for radiated spurious emission test under different RB size/offset and modulations in exploratory test. Subsequently, only the worst case emissions are reported.
4. Based on engineering evaluation, only the maximum bandwidth and the worst modulation test

results are shown in the report.

2.2 Connection Diagram of Test System

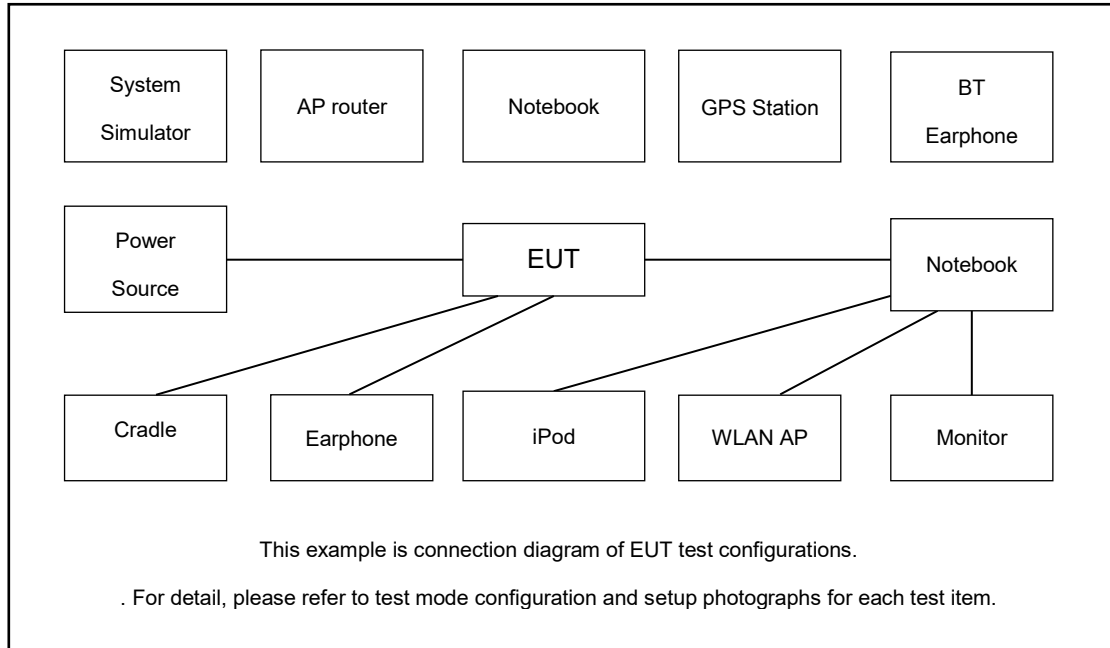

2.3 Support Unit used in test configuration and system

Item	Equipment	Trade Name	Model No.	FCC ID	Data Cable	Power Cord
1.	System Simulator	Anritsu	MT8820C	N/A	N/A	Unshielded, 1.8 m
2.	DC Power Supply	GW INSTEK	GPS-3030D	N/A	N/A	Unshielded, 1.8 m
3.	Test jig	N/A	N/A	N/A	N/A	N/A

2.4 Measurement Results Explanation Example

For all conducted test items:

The offset level is set in the spectrum analyzer to compensate the RF cable loss between EUT conducted output port and spectrum analyzer. With the offset compensation, the spectrum analyzer reading level is exactly the EUT RF output level.

The spectrum analyzer offset is derived from RF cable loss.

Offset = RF cable loss.

Following shows an offset computation example with cable loss 5.5 dB.

Example :

$$\begin{aligned} \text{Offset(dB)} &= \text{RF cable loss(dB)}. \\ &= 5.5 \text{ (dB)} \end{aligned}$$

3 Conducted Test Items

3.1 Measuring Instruments

See list of measuring instruments of this test report.

3.1.1 Test Setup

3.1.2 Conducted Output Power

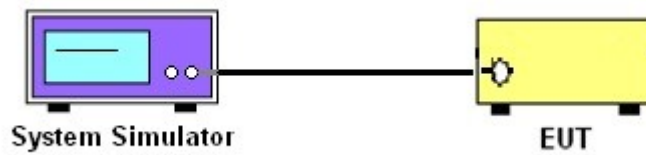

3.1.3 Peak-to-Average Ratio, Occupied Bandwidth, Conducted Band-Edge, Emission Mask, and Conducted Spurious Emission

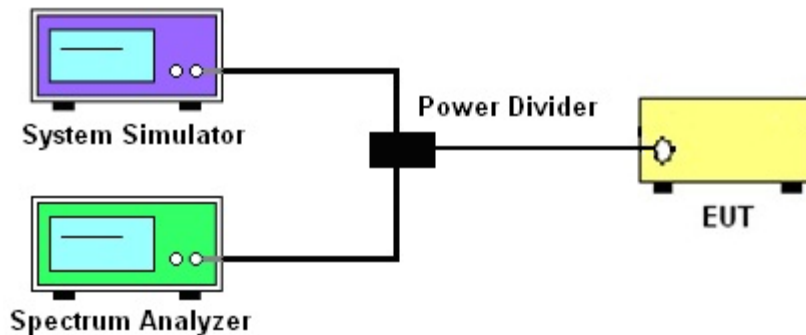

3.1.4 Frequency Stability

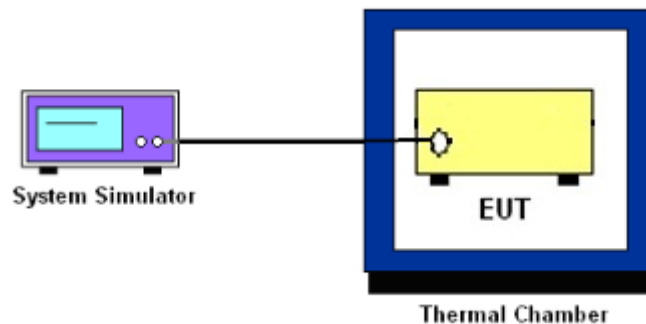

3.1.5 Test Result of Conducted Test

Please refer to Appendix A.

3.2 Conducted Output Power and ERP

3.2.1 Description of the Conducted Output Power Measurement and ERP

A base station simulator was used to establish communication with the EUT. Its parameters were set to transmit the maximum power on the EUT. The measured power in the radio frequency on the transmitter output terminals shall be reported.

According to KDB 412172 D01 Power Approach,

$EIRP = P_T + G_T - L_C$, $ERP = EIRP - 2.15$, where

P_T = transmitter output power in dBm

G_T = gain of the transmitting antenna in dBi

L_C = signal attenuation in the connecting cable between the transmitter and antenna in dB

3.2.2 Test Procedures

1. The testing follows ANSI C63.26 Section 5.2
2. The transmitter output port was connected to the system simulator.
3. Set EUT at maximum power through the system simulator.
4. Select lowest, middle, and highest channels for each band and different modulation.
5. Measure and record the power level from the system simulator.

3.3 Peak-to-Average Ratio

3.3.1 Description of the PAR Measurement

Power Complementary Cumulative Distribution Function (CCDF) curves provide a means for characterizing the power peaks of a digitally modulated signal on a statistical basis. A CCDF curve depicts the probability of the peak signal amplitude exceeding the average power level. Most contemporary measurement instrumentation include the capability to produce CCDF curves for an input signal provided that the instrument's resolution bandwidth can be set wide enough to accommodate the entire input signal bandwidth. In measuring transmissions in this band using an average power technique, the peak-to-average ratio (PAR) of the transmission may not exceed 13 dB.

3.3.2 Test Procedures

1. The EUT was connected to spectrum and system simulator via a power divider.
2. Set the CCDF (Complementary Cumulative Distribution Function) option in spectrum analyzer.
3. The highest RF powers were measured and recorded the maximum PAPR level associated with a probability of 0.1 %.
4. Record the deviation as Peak to Average Ratio.

3.4 Occupied Bandwidth

3.4.1 Description of Occupied Bandwidth Measurement

The occupied bandwidth is the width of a frequency band such that, below the lower and above the upper frequency limits, the mean powers emitted are each equal to a specified percentage 0.5% of the total mean transmitted power.

The 26 dB emission bandwidth is defined as the frequency range between two points, one above and one below the carrier frequency, at which the spectral density of the emission is attenuated 26 dB below the maximum in-band spectral density of the modulated signal. Spectral density (power per unit bandwidth) is to be measured with a detector of resolution bandwidth equal to approximately 1.0% of the emission bandwidth.

3.4.2 Test Procedures

1. The testing follows ANSI C63.26 Section 5.4
2. The EUT was connected to spectrum analyzer and system simulator via a power divider.
3. The spectrum analyzer center frequency is set to the nominal EUT channel center frequency. The span range for the spectrum analyzer shall be between two and five times the anticipated OBW.
4. The nominal resolution bandwidth (RBW) shall be in the range of 1 to 5 % of the anticipated OBW, and the VBW shall be at least 3 times the RBW.
5. Set the detection mode to peak, and the trace mode to max hold.
6. Determine the reference value: Set the EUT to transmit a modulated signal. Allow the trace to stabilize. Set the spectrum analyzer marker to the highest level of the displayed trace.
(this is the reference value)
7. Determine the “-26 dB down amplitude” as equal to (Reference Value – X).
8. Place two markers, one at the lowest and the other at the highest frequency of the envelope of the spectral display such that each marker is at or slightly below the “-X dB down amplitude” determined in step 6. If a marker is below this “-X dB down amplitude” value it shall be placed as close as possible to this value. The OBW is the positive frequency difference between the two markers.
9. Use the 99 % power bandwidth function of the spectrum analyzer and report the measured bandwidth.

3.5 Conducted Band Edge Measurement

3.5.1 Description of Conducted Band Edge Measurement

For operations in the 758-768 MHz and the 788-798 MHz bands

(1) On all frequencies between 769-775 MHz and 799-805 MHz, by a factor not less than $76 + 10 \log (P)$ dB in a 6.25 kHz band segment, for base and fixed stations.

(2) On all frequencies between 769-775 MHz and 799-805 MHz, by a factor not less than $65 + 10 \log (P)$ dB in a 6.25 kHz band segment, for mobile and portable stations.

(3) On any frequency between 775-788 MHz, above 805 MHz, and below 758 MHz, by at least $43 + 10 \log (P)$ dB.

3.5.2 Test Procedures

1. The testing follows ANSI C63.26 section 5.7
2. The EUT was connected to spectrum analyzer and system simulator via a power divider.
3. The band edges of low and high channels for the highest RF powers were measured.
4. Set spectrum analyzer with RMS detector.
5. The RF fundamental frequency should be excluded against the limit line in the operating frequency band.
6. Checked that all the results comply with the emission limit line.

Example:

The limit line is derived from $43 + 10 \log(P)$ dB below the transmitter power P(Watts)

= $P(W) - [43 + 10 \log(P)]$ (dB)

= $[30 + 10 \log(P)]$ (dBm) - $[43 + 10 \log(P)]$ (dB) = -13dBm.

3.6 Emission Mask

3.6.1 Description of Emission Mask

<Emission Mask B>.

For transmitters that are equipped with an audio low-pass filter, the power of any emission must be attenuated below the unmodulated carrier power (P) as follows:

- (1) On any frequency removed from the assigned frequency by more than 50 percent, but not more than 100 percent of the authorized bandwidth: At least 25 dB.
- (2) On any frequency removed from the assigned frequency by more than 100 percent, but not more than 250 percent of the authorized bandwidth: At least 35 dB.
- (3) On any frequency removed from the assigned frequency by more than 250 percent of the authorized bandwidth: At least $43 + 10 \log (P)$ dB.

3.6.2 Test Procedures

1. The testing follows ANSI C63.26 section 5.7
2. The EUT was connected to spectrum analyzer and system simulator via a power divider.
3. The RF output of EUT was connected to the spectrum analyzer by RF cable and attenuator. The path loss was compensated to the results for each measurement.
4. Make the measurement with the spectrum analyzer's RBW = 1MHz, VBW = 3MHz.
5. Set spectrum analyzer with RMS detector.
6. Taking the record of maximum spurious emission.
7. The RF fundamental frequency should be excluded against the limit line in the operating frequency band.
8. The limit line is derived from $43 + 10\log(P)$ dB below the transmitter power P(Watts)
= $P(W) - [43 + 10\log(P)]$ (dB)
= $[30 + 10\log(P)]$ (dBm) - $[43 + 10\log(P)]$ (dB)
= -13dBm.

3.7 Conducted Spurious Emission Measurement

3.7.1 Description of Conducted Spurious Emission Measurement

The power of any emission outside of the authorized operating frequency ranges must be lower than the transmitter power (P) by a factor of at least $43 + 10 \log (P)$ dB.

It is measured by means of a calibrated spectrum analyzer and scanned from 30MHz up to a frequency including its 10th harmonic.

3.7.2 Test Procedures

1. The testing follows ANSI C63.26 section 5.7
2. The EUT was connected to spectrum analyzer and base station via power divider.
3. The RF output of EUT was connected to the spectrum analyzer by RF cable and attenuator. The path loss was compensated to the results for each measurement.
4. The middle channel for the highest RF power within the transmitting frequency was measured.
5. The conducted spurious emission for the whole frequency range was taken.
6. Make the measurement with the spectrum analyzer's, for under 1GHz RBW = 100kHz, VBW = 300kHz and for above 1GHz RBW = 1MHz, VBW = 3MHz, taking the record of maximum spurious emission.
7. Set spectrum analyzer with RMS detector.
8. The RF fundamental frequency should be excluded against the limit line in the operating frequency band.
9. The limit line is derived from $43 + 10\log(P)$ dB below the transmitter power P(Watts)
= P(W)- [43 + 10log(P)] (dB)
= [30 + 10log(P)] (dBm) - [43 + 10log(P)] (dB)
= -13dBm.

3.8 Frequency Stability Measurement

3.8.1 Description of Frequency Stability Measurement

The frequency stability shall be measured by variation of ambient temperature and variation of primary supply voltage to ensure that the fundamental emission stays within the authorized frequency block. The frequency stability of the transmitter shall be maintained within ± 1.25 ppm of the center frequency.

3.8.2 Test Procedures for Temperature Variation

1. The testing follows ANSI C63.26 section 5.6.4
2. The EUT was set up in the thermal chamber and connected with the system simulator.
3. With power OFF, the temperature was decreased to -30°C and the EUT was stabilized before testing. Power was applied and the maximum change in frequency was recorded within one minute.
4. With power OFF, the temperature was raised in 10°C step up to 50°C . The EUT was stabilized at each step for at least half an hour. Power was applied and the maximum frequency change was recorded within one minute.

3.8.3 Test Procedures for Voltage Variation

1. The testing follows ANSI C63.26 section 5.6.5.
2. The EUT was placed in a temperature chamber at $20\pm 5^{\circ}\text{C}$ and connected with the system simulator.
3. The power supply voltage to the EUT was varied from 85% to 115% of the nominal value for other than hand carried battery equipment.
4. For hand carried, battery powered equipment, reduce the primary ac or dc supply voltage to the battery operating end point, which shall be specified by the manufacturer.
5. The variation in frequency was measured for the worst case.

4 Radiated Test Items

4.1 Measuring Instruments

See list of measuring instruments of this test report.

4.2 Test Setup

4.2.1 For radiated test from 30MHz to 1GHz

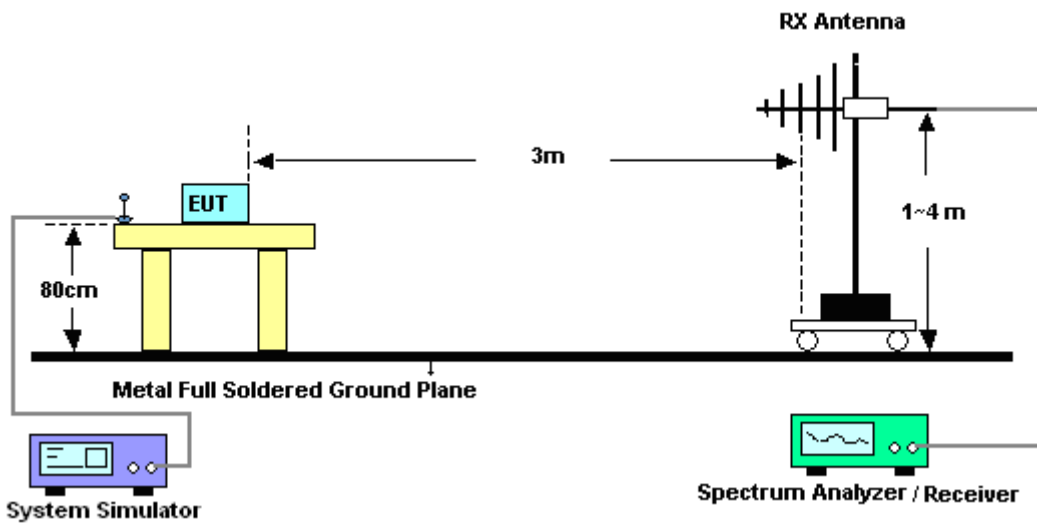

4.2.2 For radiated test above 1GHz

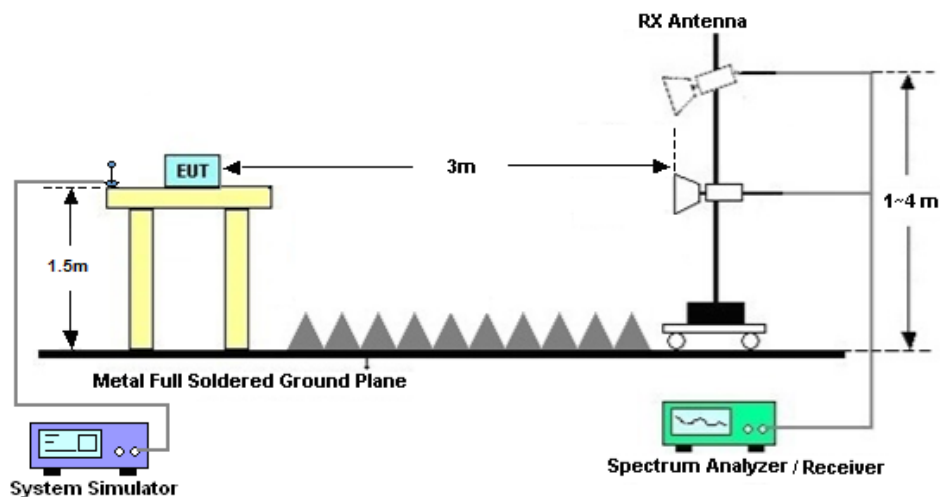

4.3 Test Result of Radiated Test

Please refer to Appendix B.

4.4 Radiated Spurious Emission Measurement

4.4.1 Description of Radiated Spurious Emission

The radiated spurious emission was measured by substitution method according to ANSI C63.26.

The power of any emission outside of the authorized operating frequency ranges must be attenuated below the transmitter power (P) by a factor of at least $43 + 10 \log (P)$ dB.

For operations in the 758-775 MHz and 788-805 MHz bands, all emissions including harmonics in the band 1559–1610 MHz shall be limited to -70 dBW/MHz equivalent isotropically radiated power (EIRP) for wideband signals, and -80 dBW EIRP for discrete emissions of less than 700 Hz bandwidth. For the purpose of equipment authorization, a transmitter shall be tested with an antenna that is representative of the type that will be used with the equipment in normal operation.

4.4.2 Test Procedures

1. The testing follows ANSI C63.26 Section 5.5
2. The EUT was placed on a turntable with 0.8 meter height for frequency below 1GHz and 1.5 meter height for frequency above 1GHz respectively above ground.
3. The EUT was set 3 meters from the receiving antenna mounted on the antenna tower.
4. The table was rotated 360 degrees to determine the position of the highest spurious emission.
5. The height of the receiving antenna is varied between 1m to 4m to search the maximum spurious emission for both horizontal and vertical polarizations.
6. During the measurement, the system simulator parameters were set to force the EUT transmitting at maximum output power.
7. Make the measurement with the spectrum analyzer's RBW = 1MHz, VBW = 3MHz, taking the record of maximum spurious emission.
8. A horn antenna was substituted in place of the EUT and was driven by a signal generator.
9. Tune the output power of signal generator to the same emission level with EUT maximum spurious emission.
10. $EIRP \text{ (dBm)} = S.G. \text{ Power} - Tx \text{ Cable Loss} + Tx \text{ Antenna Gain}$
11. $ERP \text{ (dBm)} = EIRP - 2.15$
12. The RF fundamental frequency should be excluded against the limit line in the operating frequency band.

The limit line is derived from $43 + 10\log(P)$ dB below the transmitter power P(Watts)
= $P(W) - [43 + 10\log(P)] \text{ (dB)}$
= $[30 + 10\log(P)] \text{ (dBm)} - [43 + 10\log(P)] \text{ (dB)}$
= -13dBm.

5 List of Measuring Equipment

Instrument	Manufacturer	Model No.	Serial No.	Characteristics	Calibration Date	Test Date	Due Date	Remark
Spectrum Analyzer	R&S	FSV40	101040	10Hz~40GHz	Nov. 01, 2020	Nov. 30, 2020~ Jan. 23 2021	Oct. 31, 2021	Conducted (TH01-KS)
Temperature & humidity chamber	Hongzhan	LP-150U	H2014011440	-40~+150°C 20%~95%RH	Jul. 03, 2020	Nov. 30, 2020~ Jan. 23 2021	Jul. 02, 2021	Conducted (TH01-KS)
EXA Spectrum Analyzer	Keysight	N9010A	MY55150208	10Hz~44GHz	Apr. 14, 2020	Jan. 10, 2021	Apr.13, 2021	Radiation (03CH06-KS)
Bilog Antenna	TeseQ	CBL6111D	49921	30MHz~1GHz	May. 29, 2020	Jan. 10, 2021	May. 28, 2021	Radiation (03CH06-KS)
Double Ridge Horn Antenna	ETS-Lindgren	3117	00218652	1GHz~18GHz	Apr. 27, 2020	Jan. 10, 2021	Apr. 26, 2021	Radiation (03CH06-KS)
SHF-EHF Horn	Com-power	AH-840	101115	18GHz~40GHz	Jun. 05, 2020	Jan. 10, 2021	Jun. 04, 2021	Radiation (03CH06-KS)
Amplifier	SONOMA	310N	187289	9KHz ~1GHZ	Apr. 14, 2020	Jan. 10, 2021	Apr. 13, 2021	Radiation (03CH06-KS)
Amplifier	MITEQ	EM18G40G GA	060728	18~40GHz	Jan. 07, 2021	Jan. 10, 2021	Jan. 06, 2022	Radiation (03CH06-KS)
high gain Amplifier	MITEQ	AMF-7D-00 101800-30-1 0P	2025788	1Ghz-18Ghz	Jan. 07, 2021	Jan. 10, 2021	Jan. 06, 2022	Radiation (03CH06-KS)
Amplifier	Keysight	83017A	MY53270203	500MHz~26.5GHz	Apr. 15, 2020	Jan. 10, 2021	Apr. 14. 2021	Radiation (03CH06-KS)
AC Power Source	Chroma	61601	F104090004	N/A	NCR	Jan. 10, 2021	NCR	Radiation (03CH06-KS)
Turn Table	ChamPro	EM 1000-T	060762-T	0~360 degree	NCR	Jan. 10, 2021	NCR	Radiation (03CH06-KS)
Antenna Mast	ChamPro	EM 1000-A	060762-A	1 m~4 m	NCR	Jan. 10, 2021	NCR	Radiation (03CH06-KS)

NCR: No Calibration Required

6 Uncertainty of Evaluation

The measurement uncertainties shown below were calculated in accordance with the requirements of ANSI 63.26-2015. All the measurement uncertainty value were shown with a coverage $K=2$ to indicate 95% level of confidence. The measurement data show herein meets or exceeds the CISPR measurement uncertainty values specified in CISPR 16-4-2 and can be compared directly to specified limit to determine compliance.

Uncertainty of Radiated Emission Measurement (30 MHz ~ 1000 MHz)

Measuring Uncertainty for a Level of Confidence of 95% ($U = 2Uc(y)$)	2.5dB
---	-------

Uncertainty of Radiated Emission Measurement (1 GHz ~ 18 GHz)

Measuring Uncertainty for a Level of Confidence of 95% ($U = 2Uc(y)$)	2.1dB
---	-------

Uncertainty of Radiated Emission Measurement (18 GHz ~ 40 GHz)

Measuring Uncertainty for a Level of Confidence of 95% ($U = 2Uc(y)$)	2.1dB
---	-------

Appendix A. Test Results of Conducted Test

Conducted Output Power(Average power)

LTE Band 14						
BW [MHz]	Modulation	RB Size	RB Offset	Power Low Ch. / Freq.	Power Middle Ch. / Freq.	Power High Ch. / Freq.
Channel				23330		
Frequency (MHz)				793		
10	QPSK	1	0		23.35	
10	QPSK	1	49		23.09	
10	QPSK	50	0		22.11	
10	16QAM	1	0		22.80	
10	64QAM	1	0		22.59	
Channel				23305	23330	23355
Frequency (MHz)				790.5	793	795.5
5	QPSK	1	0	23.21	23.32	23.14
5	16QAM	1	0	22.62	22.79	22.55
5	64QAM	1	0	21.64	22.48	21.98

ERP

LTE Band 14 ($G_T - L_C = 3.0$ dBi) QPSK						
Bandwidth	5M			10M		
Channel	23305	23330	23355		23330	
	(Low)	(Mid)	(High)		(Mid)	
Frequency	790.5	793	795.5		793	
(MHz)						
Conducted Power (dBm)	23.21	23.32	23.14		23.35	
Conducted Power (Watts)	0.2094	0.2148	0.2061		0.2163	
ERP(dBm)	24.06	24.17	23.99		24.20	
ERP(Watts)	0.2547	0.2612	0.2506		0.2630	

LTE Band 14 ($G_T - L_C = 3.0$ dBi) 16QAM						
Bandwidth	5M			10M		
Channel	23305	23330	23355		23330	
	(Low)	(Mid)	(High)		(Mid)	
Frequency	790.5	793	795.5		793	
(MHz)						
Conducted Power (dBm)	22.62	22.79	22.55		22.80	
Conducted Power (Watts)	0.1828	0.1901	0.1799		0.1905	
ERP(dBm)	23.47	23.64	23.40		23.65	
ERP(Watts)	0.2223	0.2312	0.2188		0.2317	



Peak-to-Average Ratio

Mode	LTE Band 14 / 10MHz				
Mod.	QPSK		16QAM		Limit: 13dB
RB Size	1RB	Full RB	1RB	Full RB	Result
Lowest CH					PASS
Middle CH	4.61	4.84	5.36	5.68	
Highest CH					

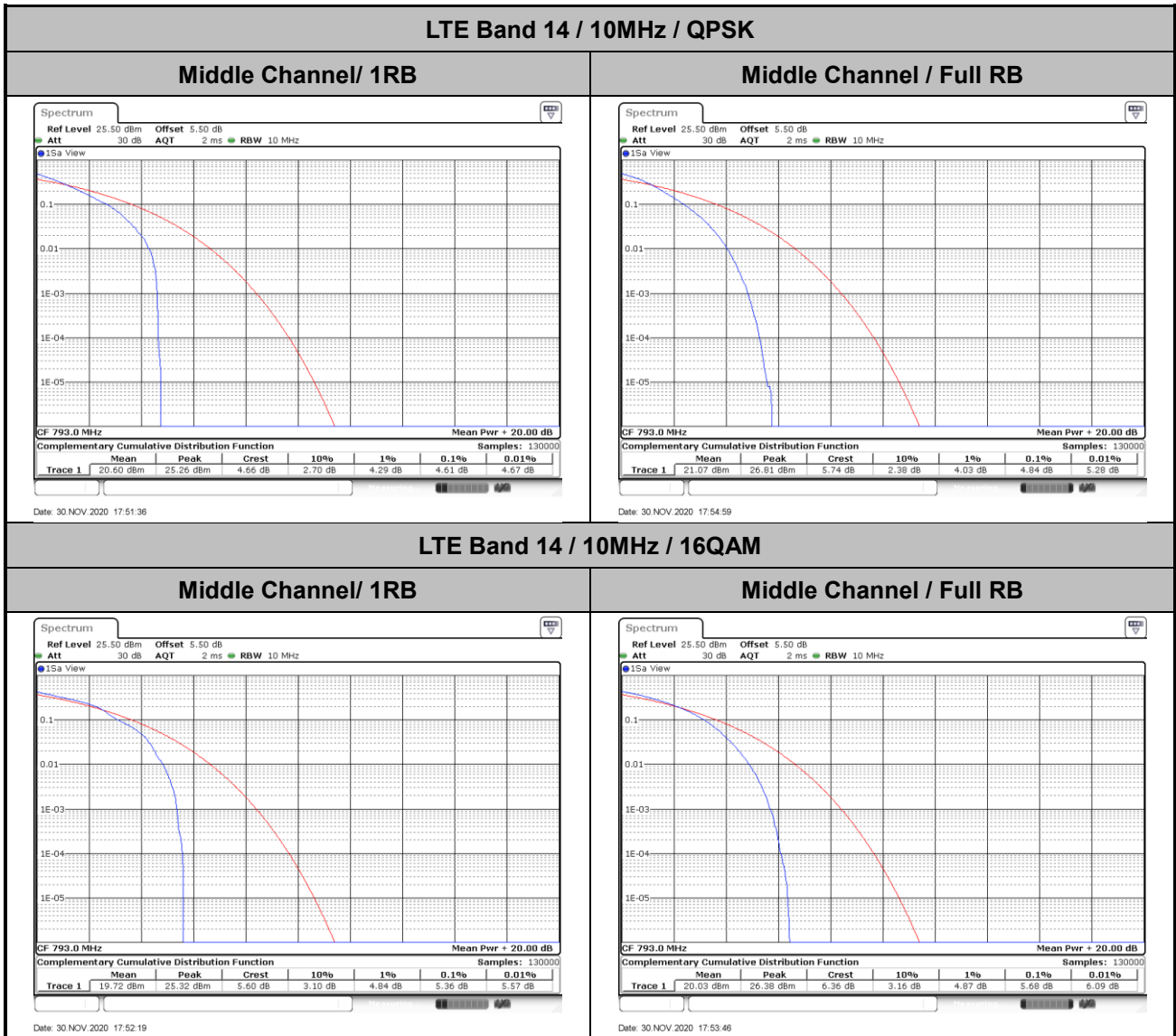



26dB Bandwidth

Mode	LTE Band 14 : 26dB BW(MHz)			
	5MHz		10MHz	
BW				
Mod.	QPSK	16QAM	QPSK	16QAM
Lowest CH	4.90	4.84		
Middle CH	4.91	4.91	10.15	9.91
Highest CH	4.89	4.92		



LTE Band 14

Lowest Channel / 5MHz / QPSK

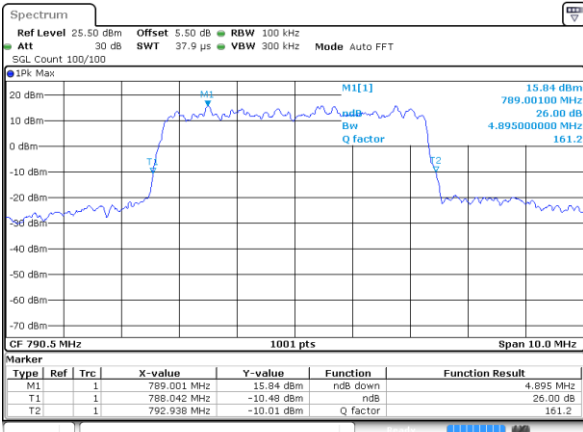

Date: 30 NOV 2020 10:31:12

Lowest Channel / 5MHz / 16QAM

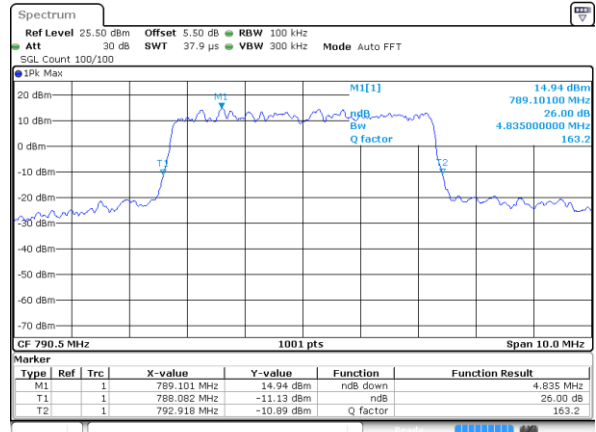

Date: 30 NOV 2020 10:30:16

Middle Channel / 5MHz / QPSK

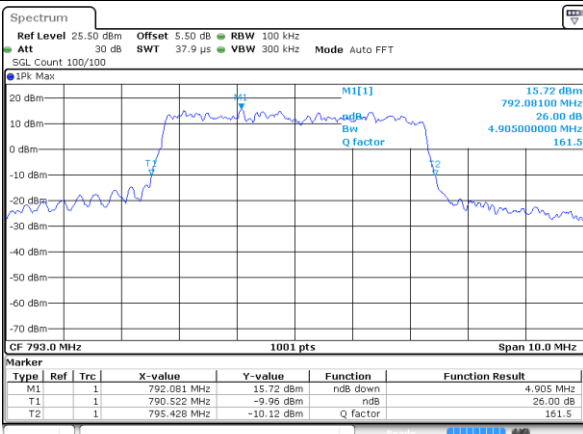

Date: 30 NOV 2020 10:32:53

Middle Channel / 5MHz / 16QAM

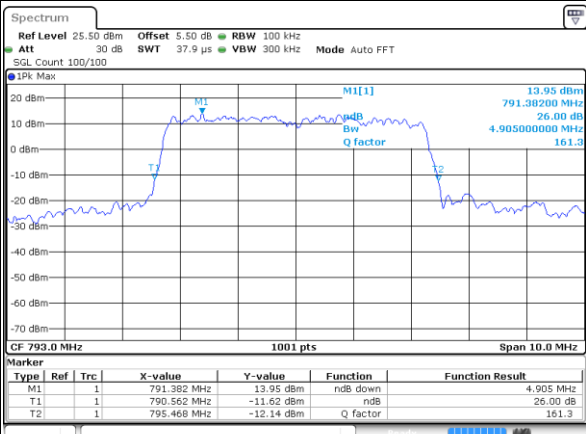

Date: 30 NOV 2020 10:33:41

Highest Channel / 5MHz / QPSK

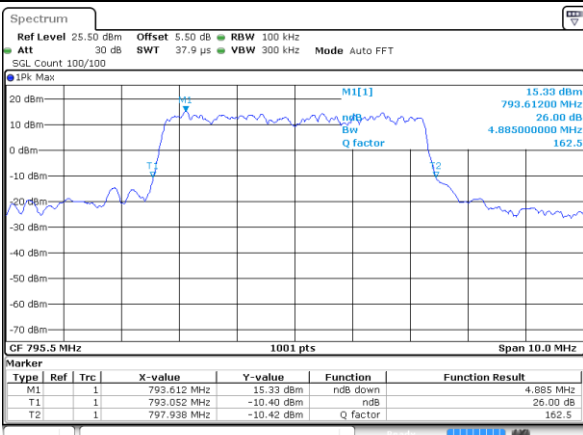

Date: 30 NOV 2020 10:35:39

Highest Channel / 5MHz / 16QAM

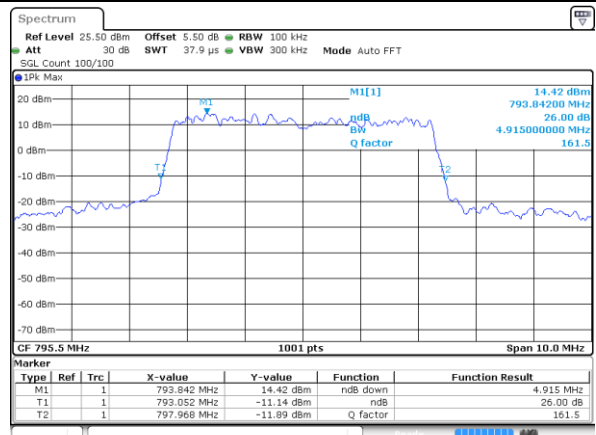

Date: 30 NOV 2020 10:35:10



LTE Band 14

Middle Channel / 10MHz / QPSK

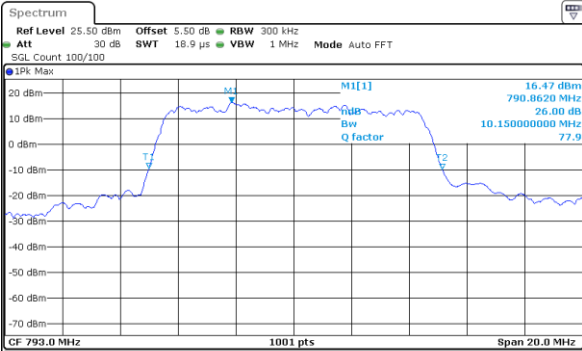

Type	Ref	Trc	X-value	Y-value	Function	Function Result
M1	1		790.862 MHz	16.47 dBm	ndB down	10.15 MHz
T1	1		787.985 MHz	-9.22 dBm	ndB	26.00 dB
T2	1		798.135 MHz	-9.74 dBm	Q factor	77.9

Date: 30 NOV 2020 17:22:37

Middle Channel / 10MHz / 16QAM

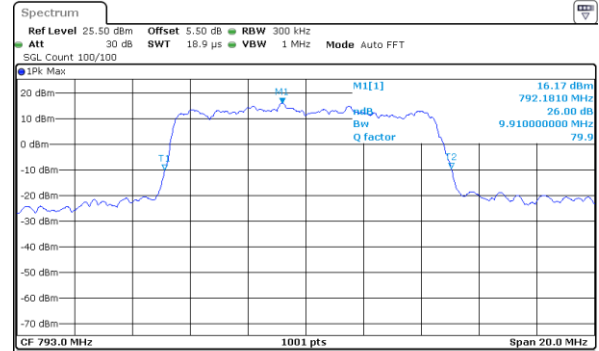

Type	Ref	Trc	X-value	Y-value	Function	Function Result
M1	1		792.181 MHz	16.17 dBm	ndB down	9.91 MHz
T1	1		788.125 MHz	-10.01 dBm	ndB	26.00 dB
T2	1		796.035 MHz	-9.45 dBm	Q factor	79.9

Date: 30 NOV 2020 17:24:03



Occupied Bandwidth

Mode	LTE Band 14 : 99%OBW(MHz)			
	5MHz		10MHz	
BW				
Mod.	QPSK	16QAM	QPSK	16QAM
Lowest CH	4.48	4.47		
Middle CH	4.51	4.47	9.03	9.05
Highest CH	4.50	4.51		



LTE Band 14

Lowest Channel / 5MHz / QPSK

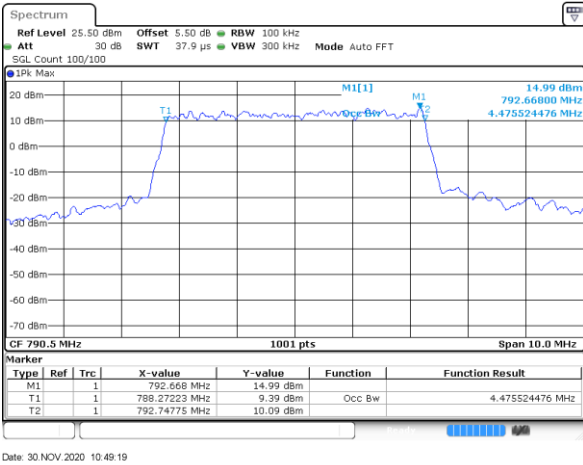

Date: 30 NOV 2020 10:49:19

Lowest Channel / 5MHz / 16QAM

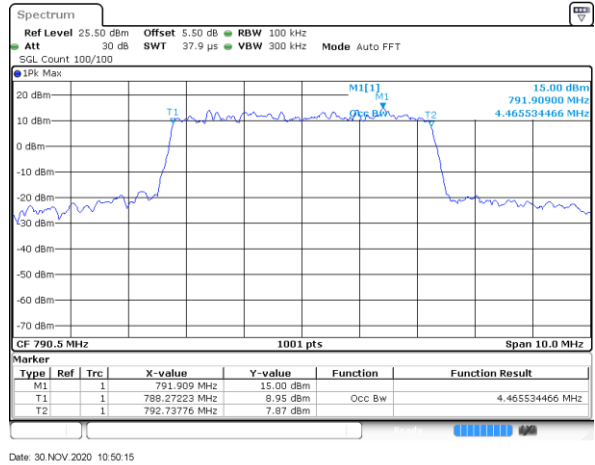

Date: 30 NOV 2020 10:50:15

Middle Channel / 5MHz / QPSK

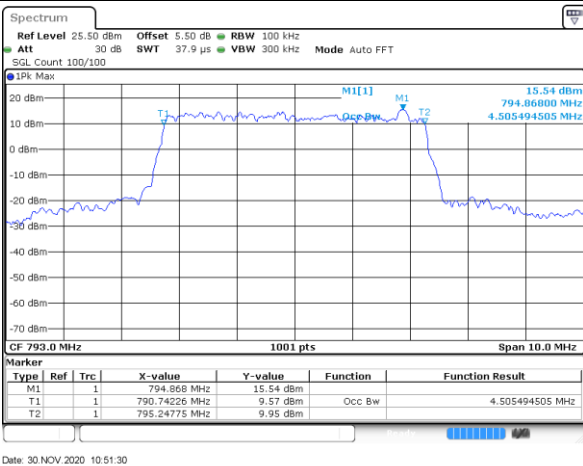

Date: 30 NOV 2020 10:51:30

Middle Channel / 5MHz / 16QAM

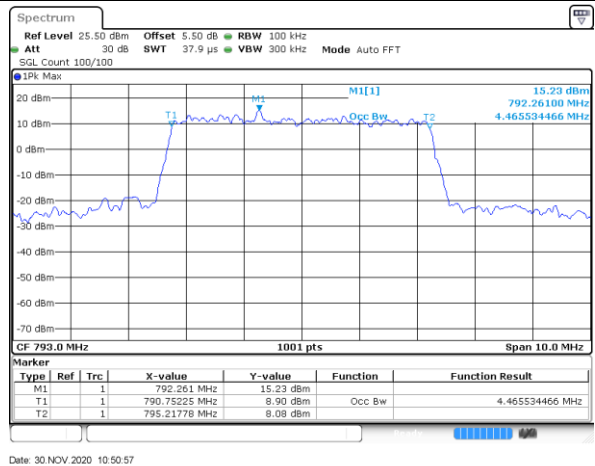

Date: 30 NOV 2020 10:50:57

Highest Channel / 5MHz / QPSK

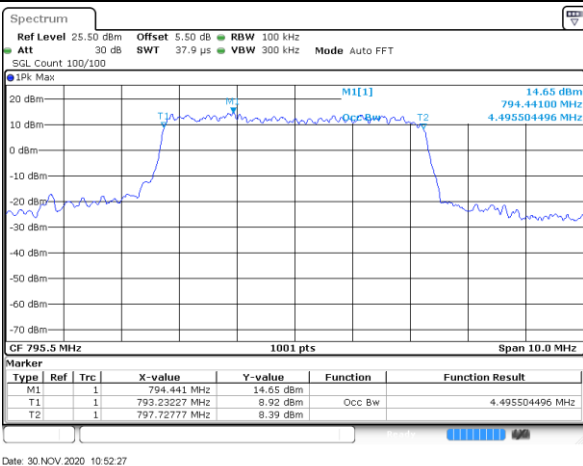

Date: 30 NOV 2020 10:52:27

Highest Channel / 5MHz / 16QAM

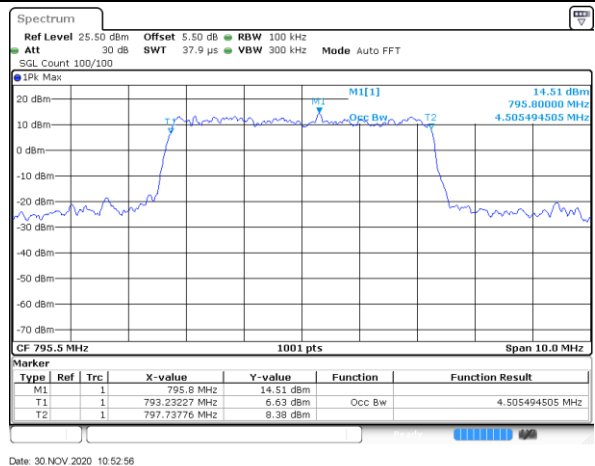

Date: 30 NOV 2020 10:52:56



LTE Band 14

Middle Channel / 10MHz / QPSK

Middle Channel / 10MHz / 16QAM

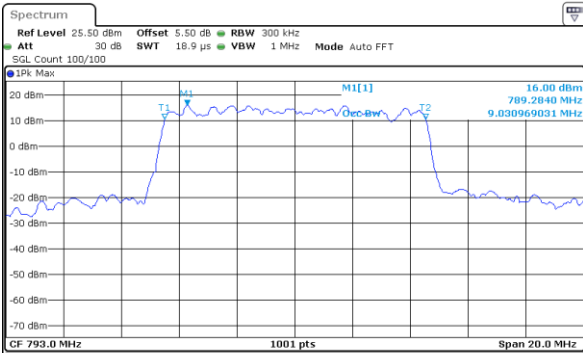

Type	Ref	Trc	X-value	Y-value	Function	Function Result
M1	1		789.284 MHz	16.00 dBm		
T1	1		788.5045 MHz	10.55 dBm	Occ Bw	9.030969031 MHz
T2	1		797.5355 MHz	10.53 dBm		

Date: 30 NOV 2020 17:24:52

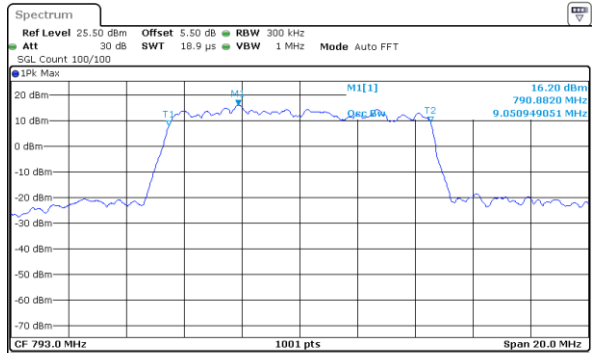

Type	Ref	Trc	X-value	Y-value	Function	Function Result
M1	1		790.882 MHz	16.20 dBm		
T1	1		788.4645 MHz	8.09 dBm	Occ Bw	9.050949051 MHz
T2	1		797.5155 MHz	9.40 dBm		

Date: 30 NOV 2020 17:24:27



Conducted Band Edge

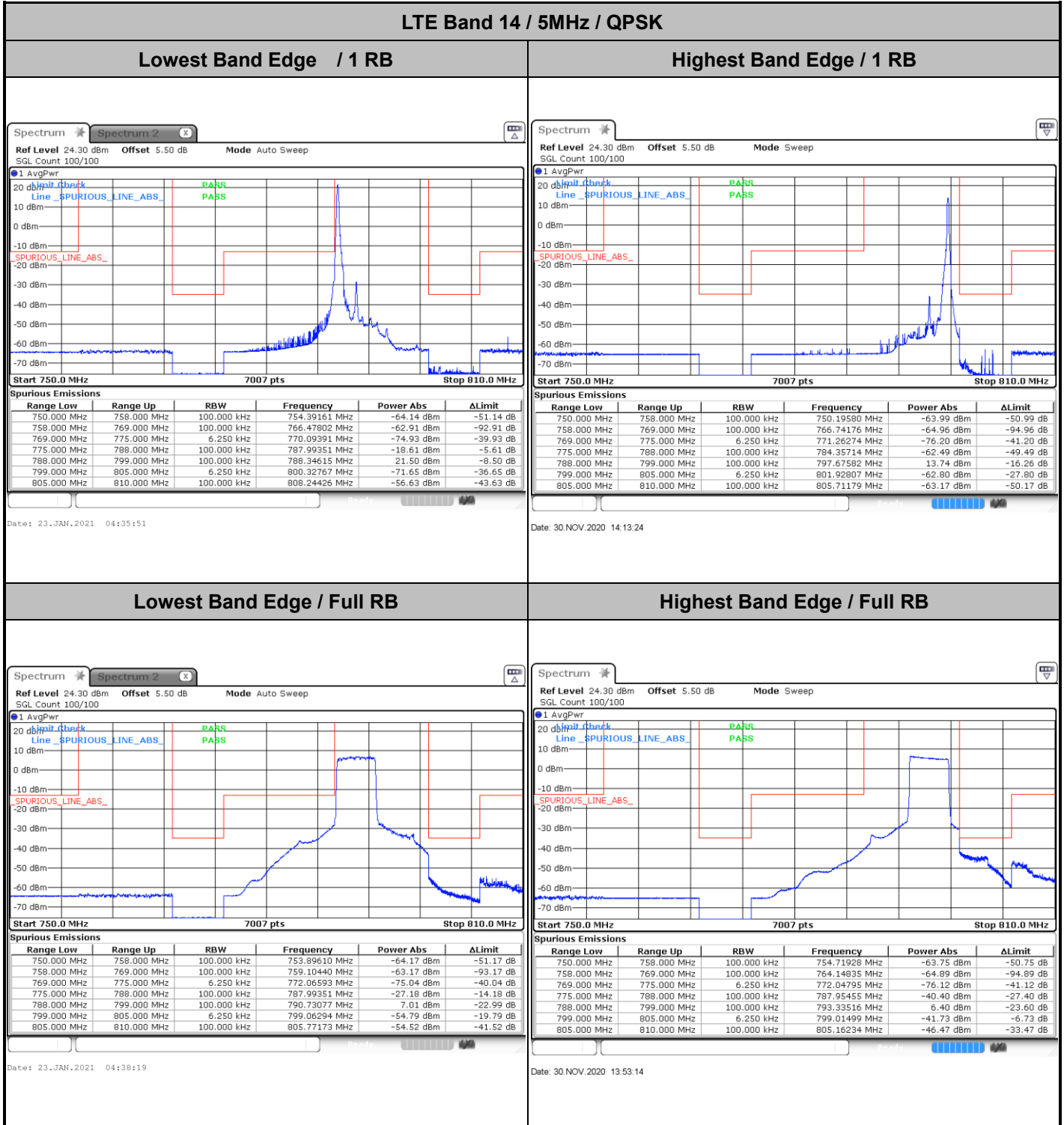



LTE Band 14 / 5MHz / 16QAM

Lowest Band Edge / 1 RB

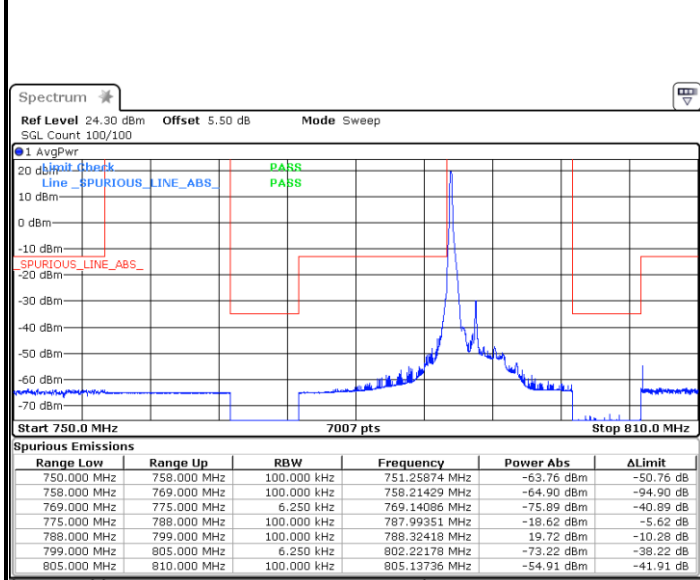

Date: 30 NOV 2020 13:45:30

Highest Band Edge / 1 RB

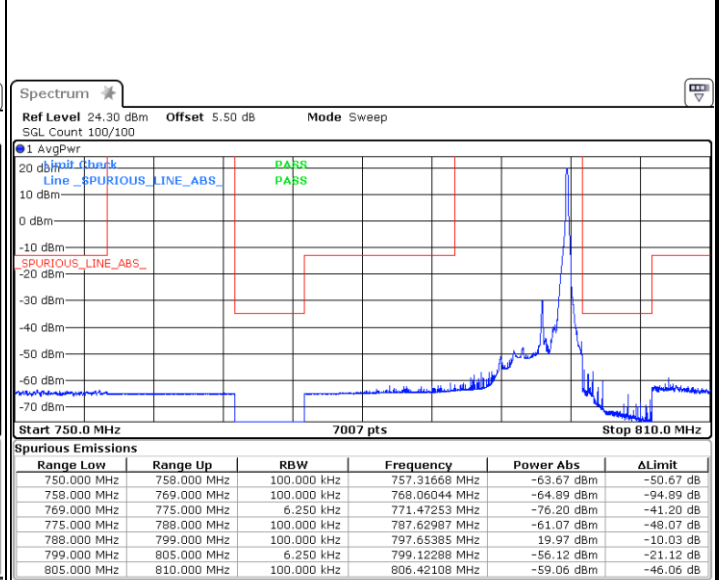

Date: 30 NOV 2020 14:06:48

Lowest Band Edge / Full RB

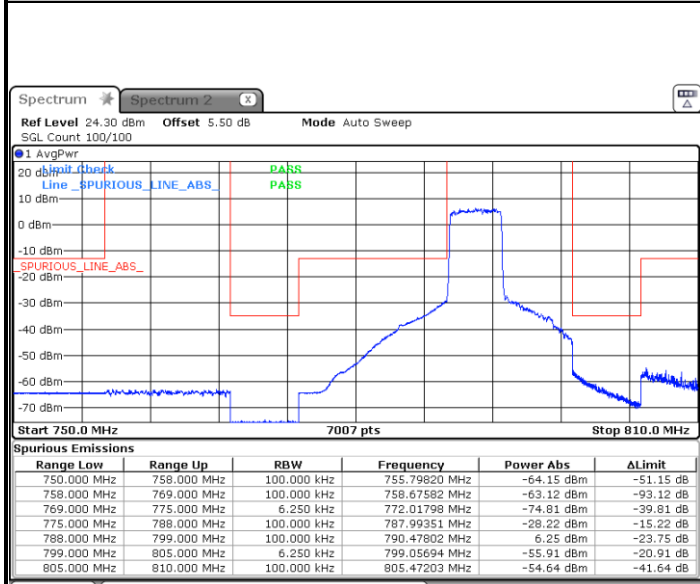

Date: 23 JAN 2021 04:39:48

Highest Band Edge / Full RB

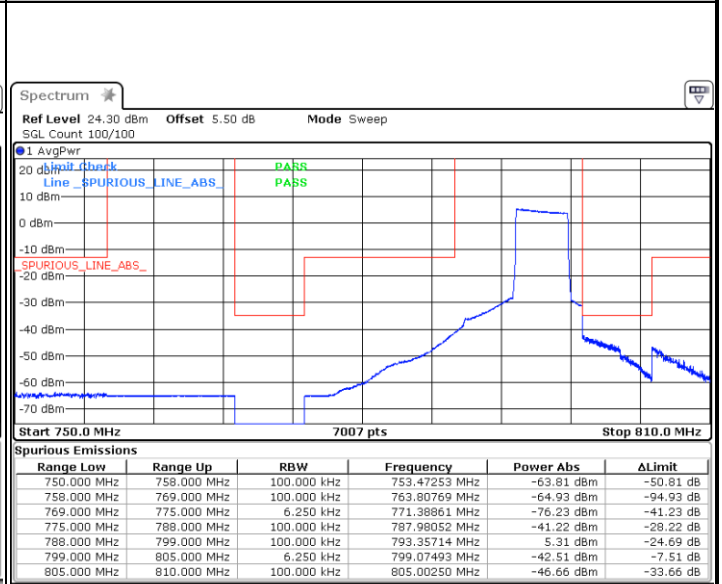

Date: 30 NOV 2020 13:59:21



LTE Band 14 / 10MHz / QPSK

Lowest Band Edge / 1 RB

Highest Band Edge / 1 RB

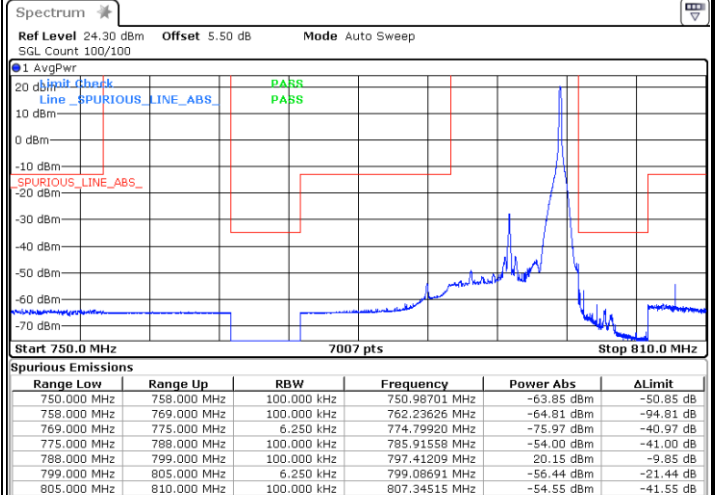
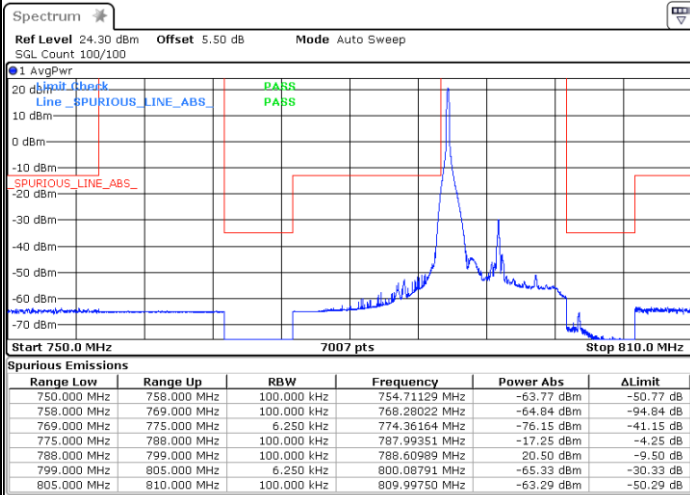

Date: 30.NOV.2020 18:19:24

Date: 30.NOV.2020 18:00:53

Band Edge / Full RB

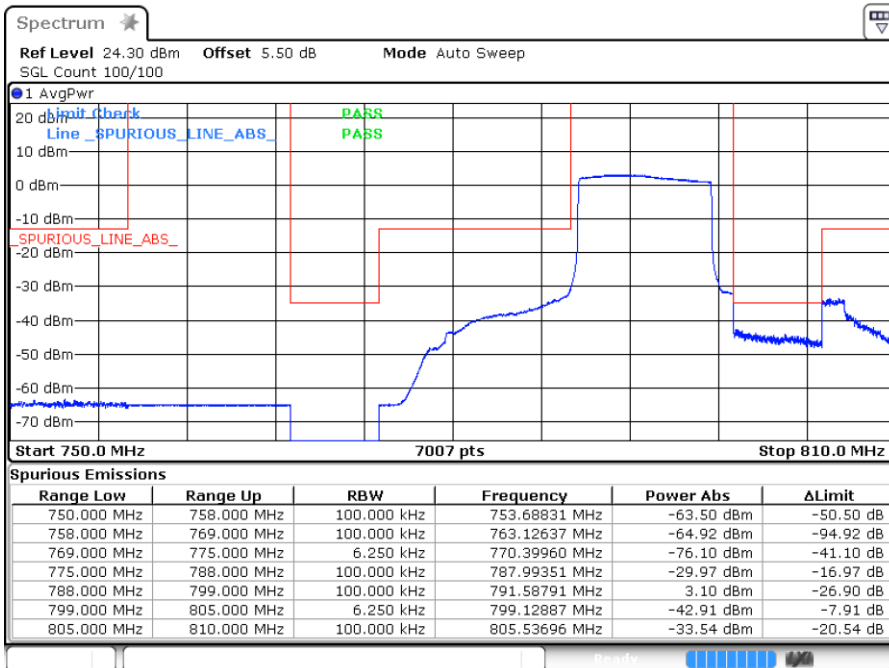

Date: 30.NOV.2020 18:15:17



LTE Band 14 / 10MHz / 16QAM

Lowest Band Edge / 1 RB

Highest Band Edge / 1 RB

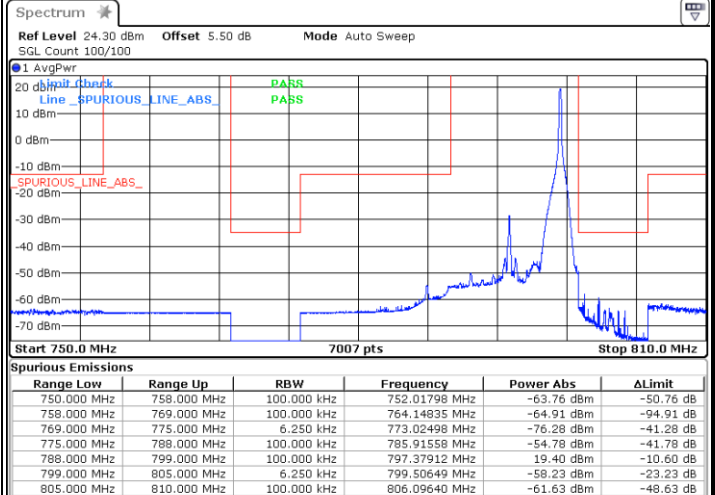
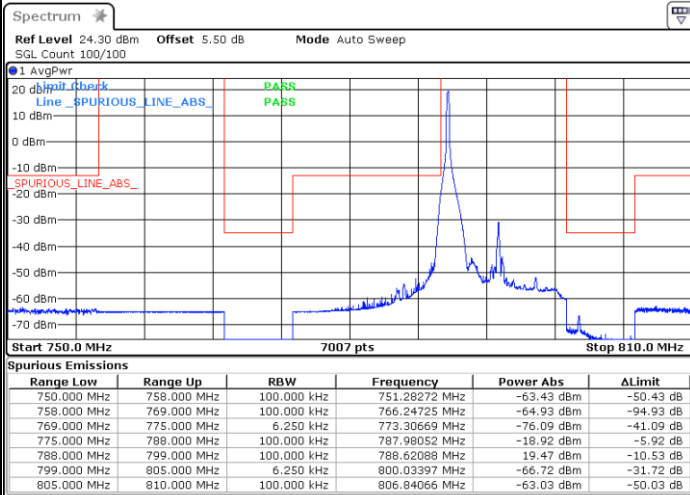

Date: 30.NOV.2020 18:22:48

Date: 30.NOV.2020 18:06:54

Band Edge / Full RB

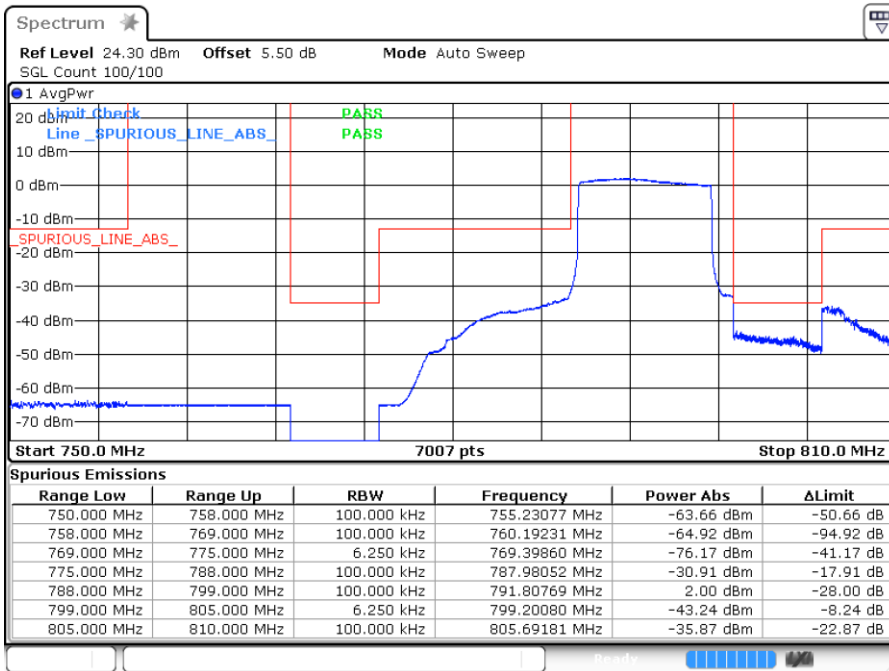

Date: 30.NOV.2020 18:11:31



Conducted Spurious Emission

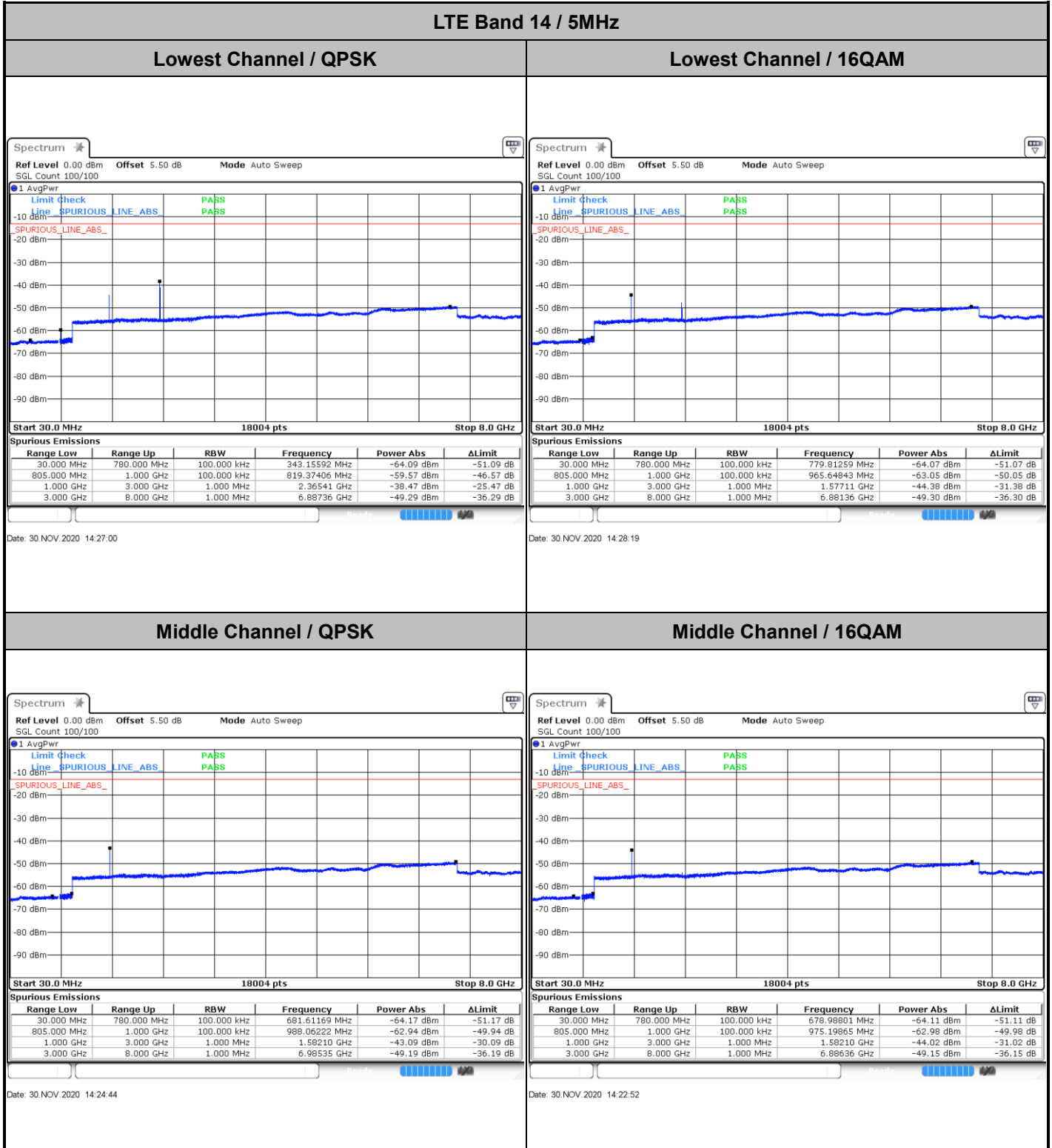



LTE Band 14 / 5MHz

Highest Channel / QPSK

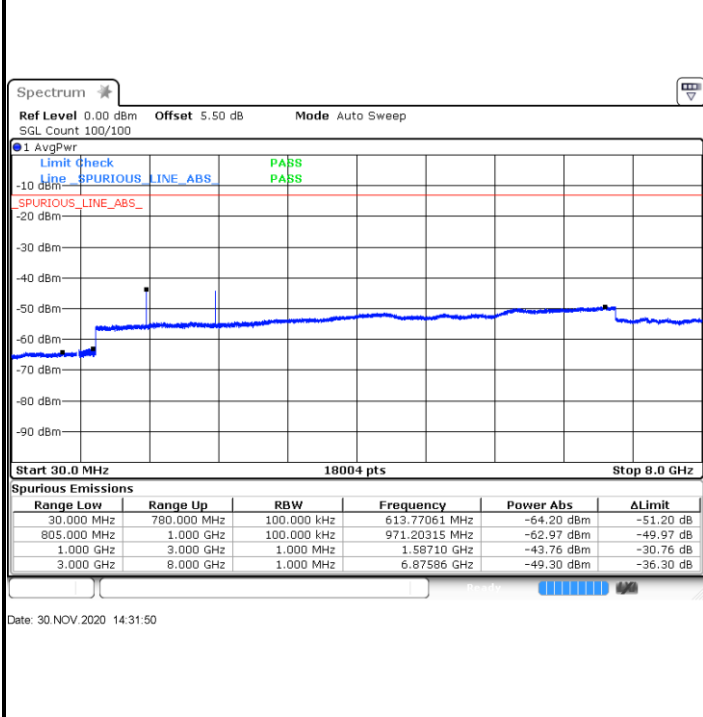

Highest Channel / 16QAM

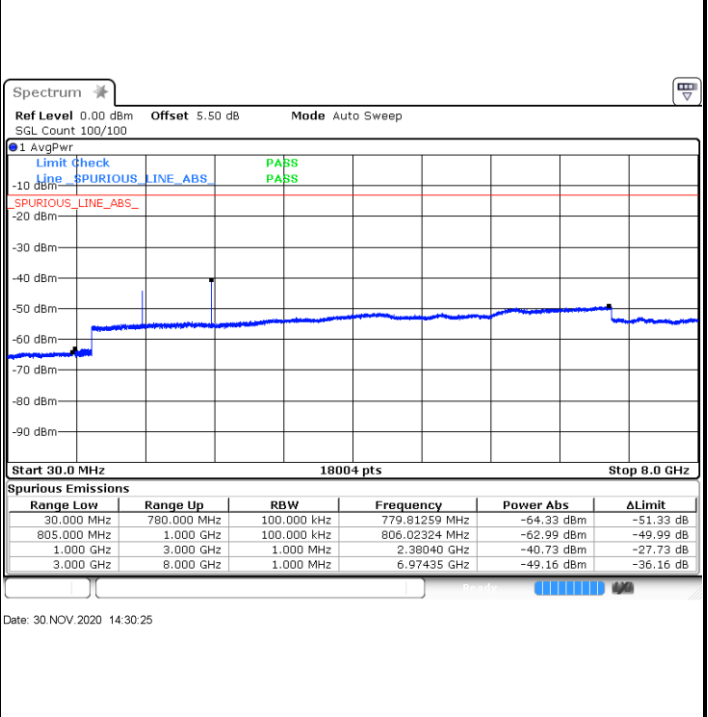

LTE Band 14 / 10MHz

Middle Channel / QPSK

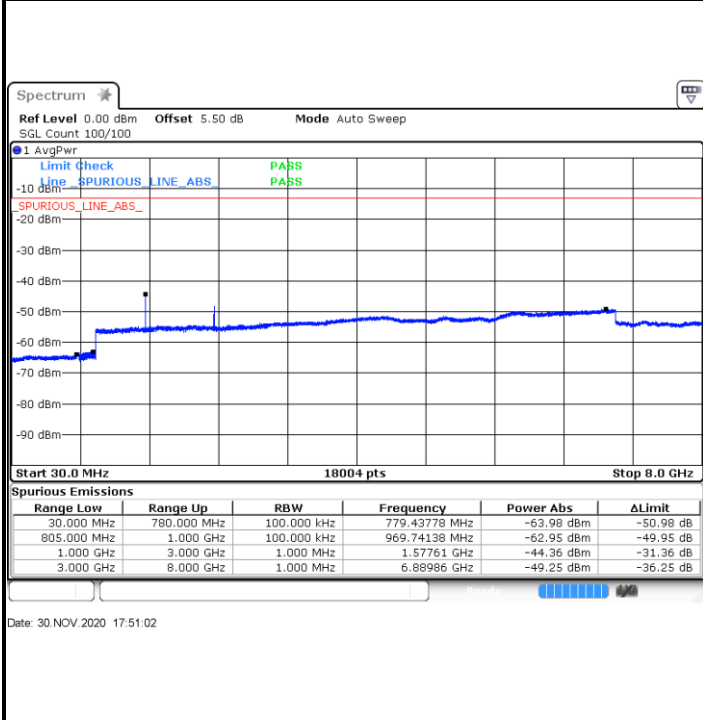

Middle Channel / 16QAM

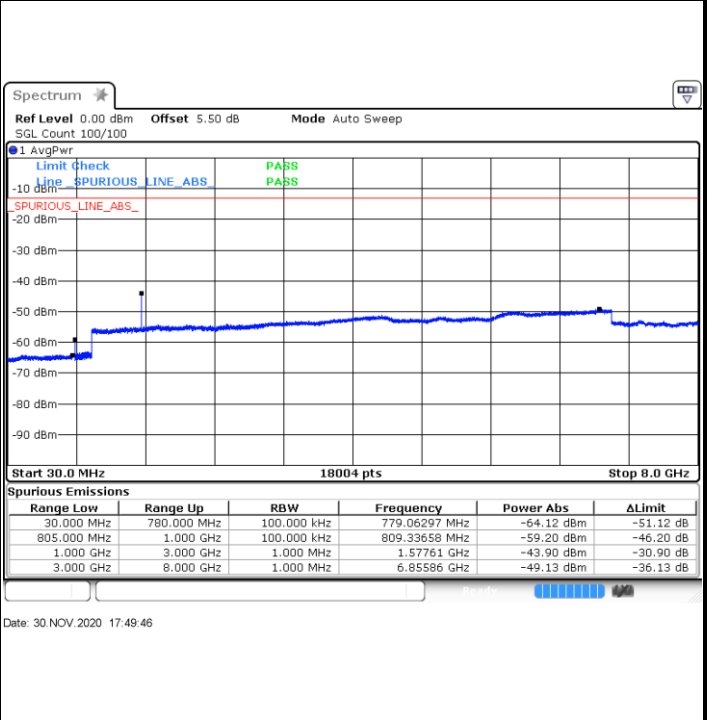

Emission Mask

LTE Band 14/ 5M(1RB0)

Lowest Channel / 5MHz / QPSK

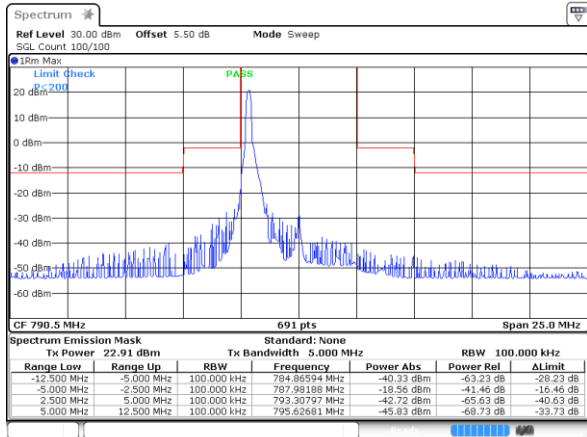

Date: 30 NOV 2020 14:54:22

Lowest Channel / 5MHz / 16QAM

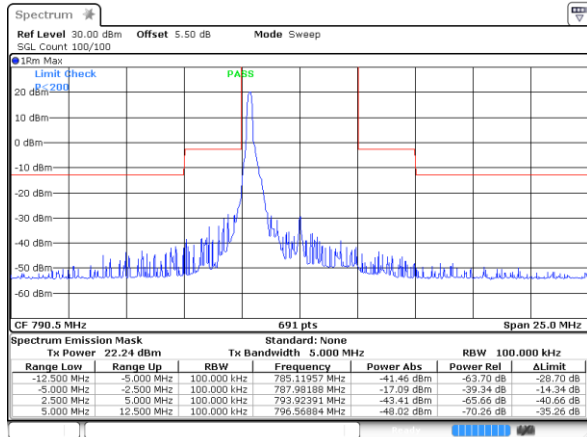

Date: 30 NOV 2020 14:57:02

Middle Channel / 5MHz / QPSK

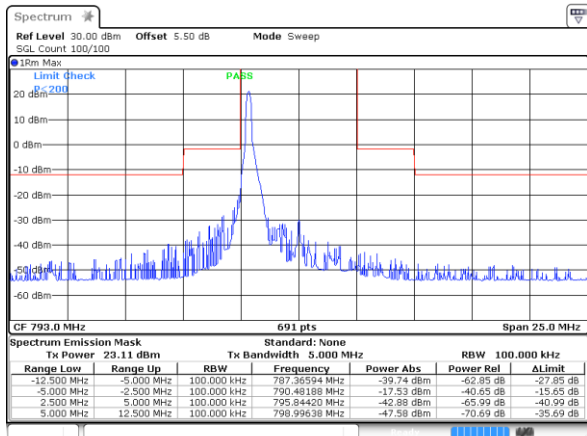

Date: 30 NOV 2020 15:05:17

Middle Channel / 5MHz / 16QAM

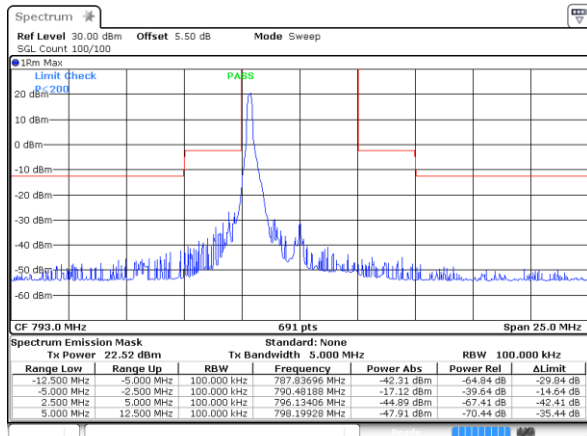

Date: 30 NOV 2020 15:02:08

Highest Channel / 5MHz / QPSK

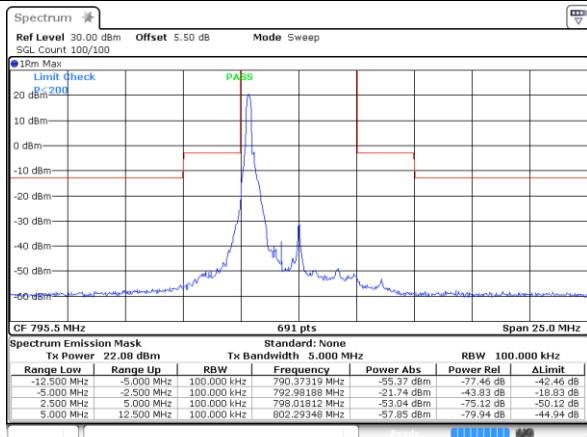

Date: 30 NOV 2020 14:44:21

Highest Channel / 5MHz / 16QAM

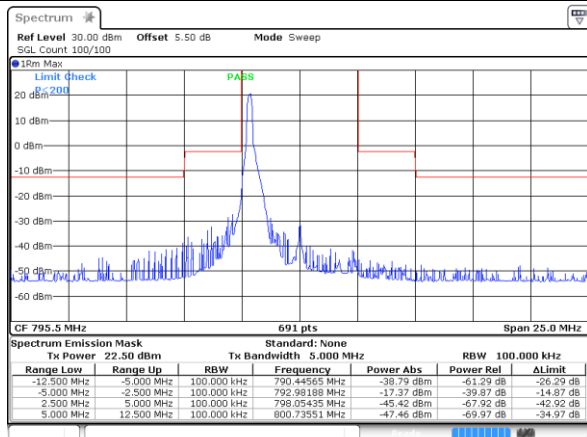

Date: 30 NOV 2020 14:48:23

LTE Band 14/ 5M(1RBmax)

Lowest Channel / 5MHz / QPSK

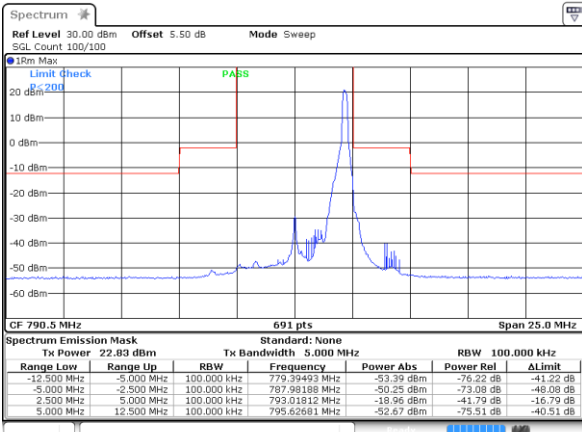

Date: 30 NOV 2020 15:09:31

Lowest Channel / 5MHz / 16QAM

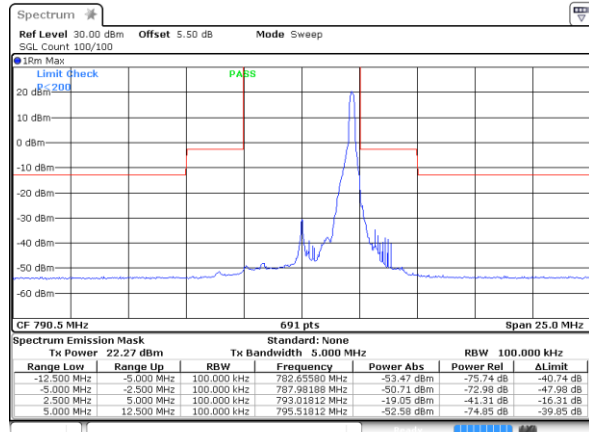

Date: 30 NOV 2020 15:12:13

Middle Channel / 5MHz / QPSK

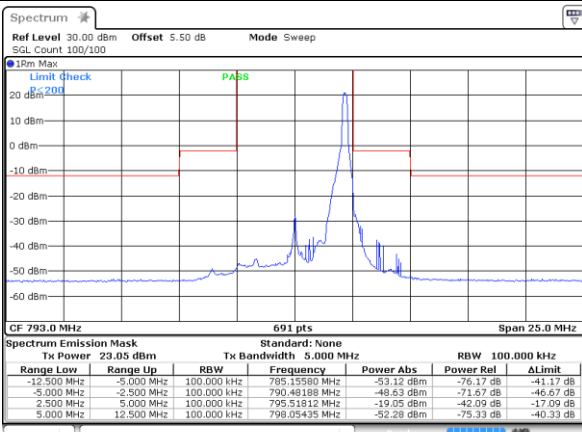

Date: 30 NOV 2020 15:17:39

Middle Channel / 5MHz / 16QAM

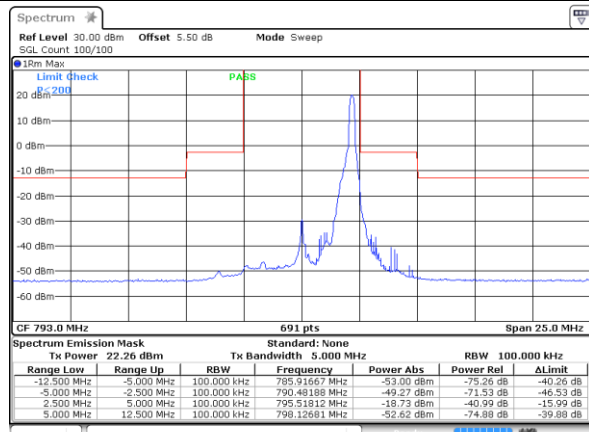

Date: 30 NOV 2020 15:14:52

Highest Channel / 5MHz / QPSK

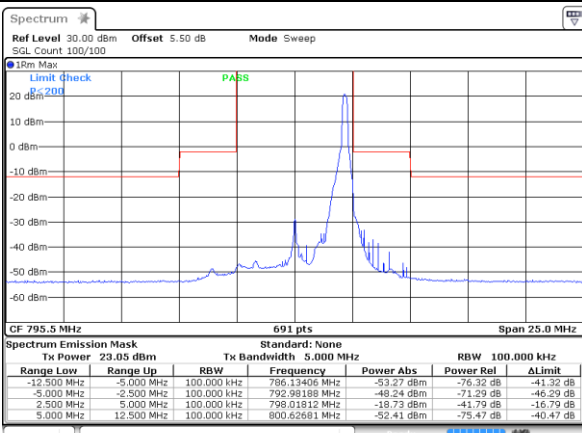

Date: 30 NOV 2020 15:21:00

Highest Channel / 5MHz / 16QAM

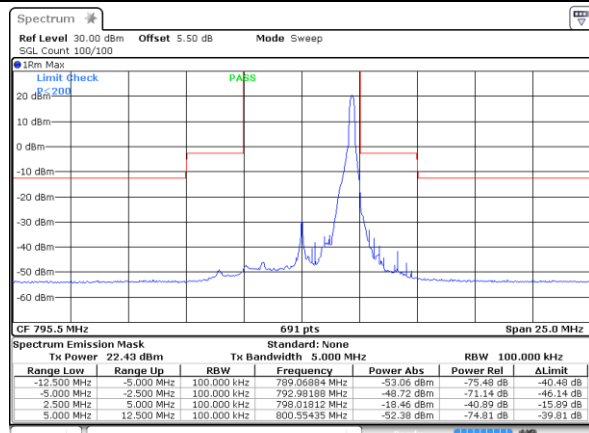

Date: 30 NOV 2020 15:23:08

LTE Band 14/ 5M(fullIRB0)

Lowest Channel / 5MHz / QPSK

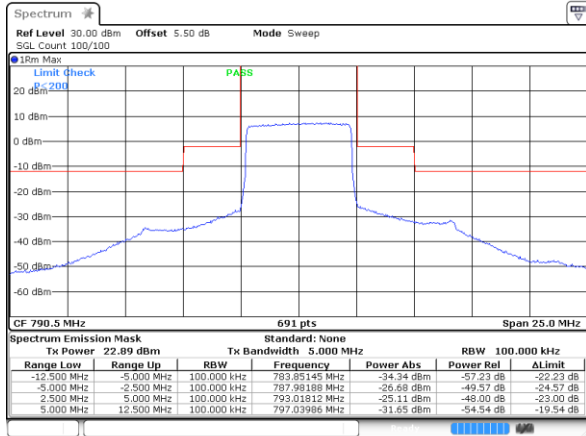

Date: 30 NOV 2020 15:37:38

Lowest Channel / 5MHz / 16QAM

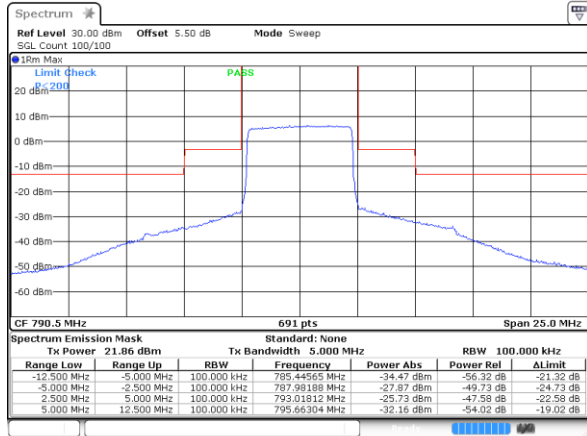

Date: 30 NOV 2020 15:35:32

Middle Channel / 5MHz / QPSK

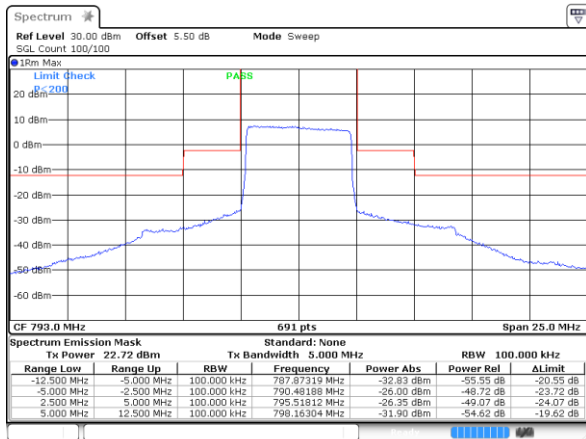

Date: 30 NOV 2020 15:30:41

Middle Channel / 5MHz / 16QAM

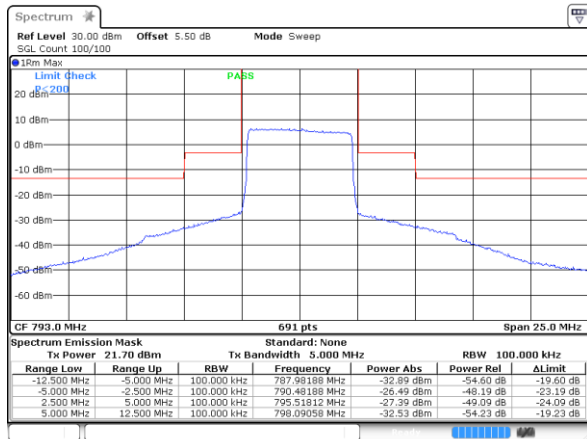

Date: 30 NOV 2020 15:32:52

Highest Channel / 5MHz / QPSK

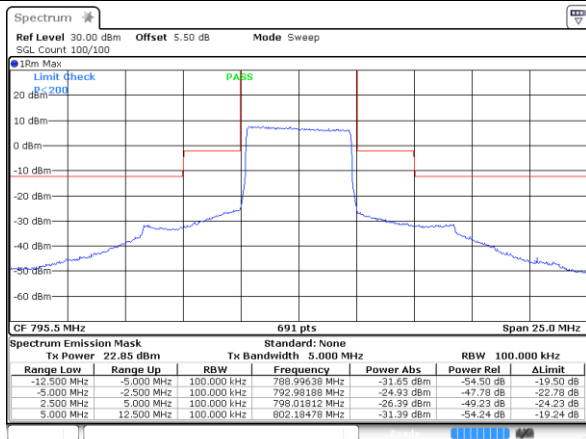

Date: 30 NOV 2020 15:28:26

Highest Channel / 5MHz / 16QAM

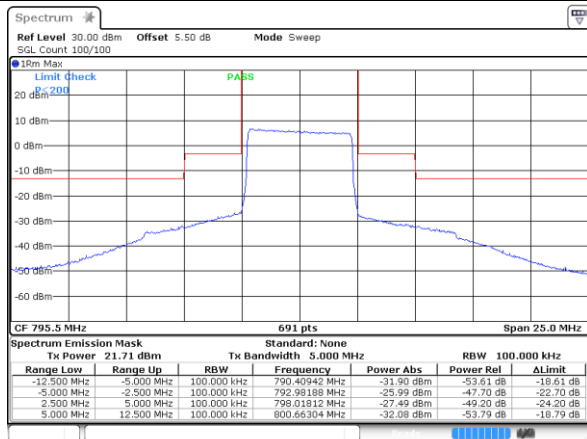

Date: 30 NOV 2020 15:26:09



LTE Band 14/ 10MHz

Middle Channel / 1RB0 / QPSK

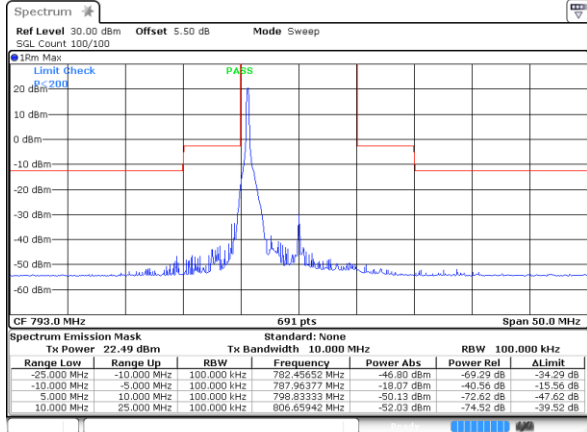

Date: 30 NOV 2020 17:29:26

Middle Channel / 1RB0 / 16QAM

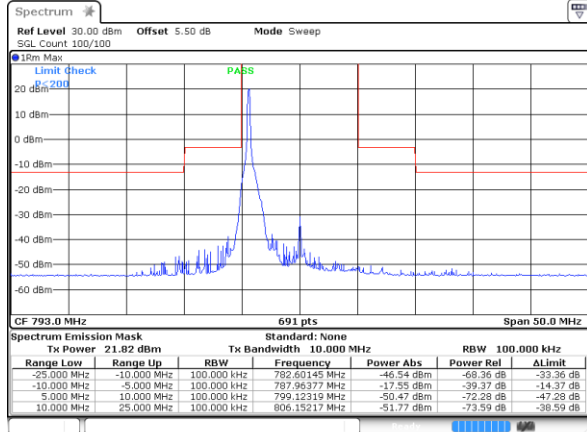

Date: 30 NOV 2020 17:33:57

Middle Channel / 1RBmax / QPSK

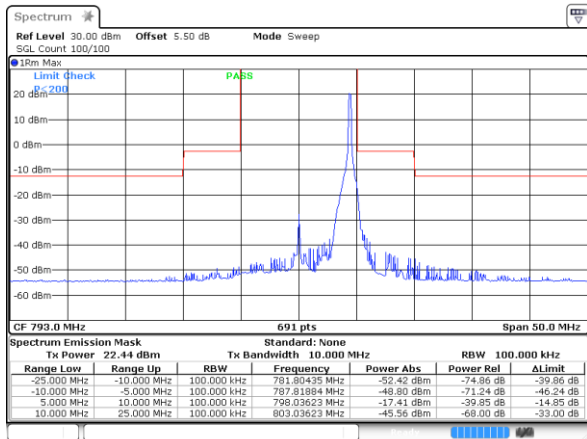

Date: 30 NOV 2020 17:41:06

Middle Channel / 1RBmax / 16QAM

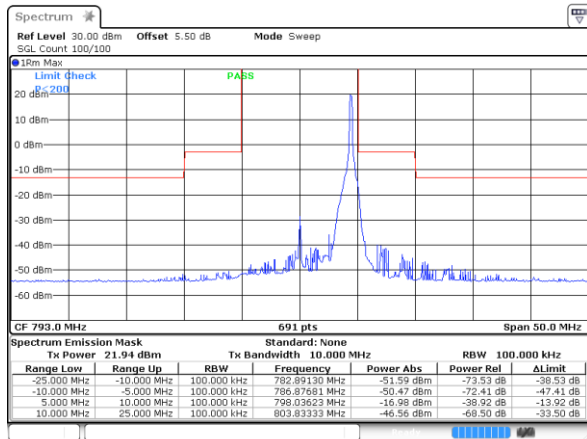

Date: 30 NOV 2020 17:38:04

Middle Channel / full1RB0 / QPSK

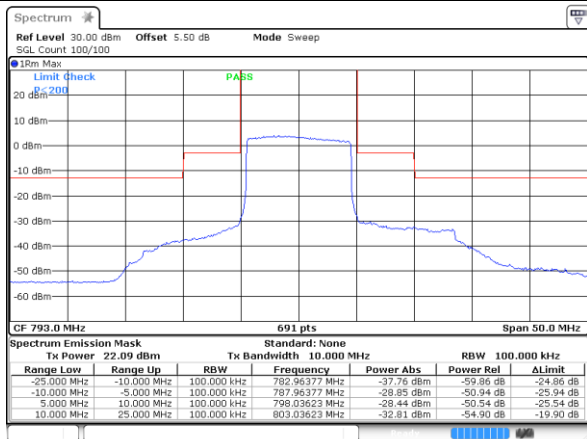

Date: 30 NOV 2020 17:44:48

Middle Channel / full1RB0 / 16QAM

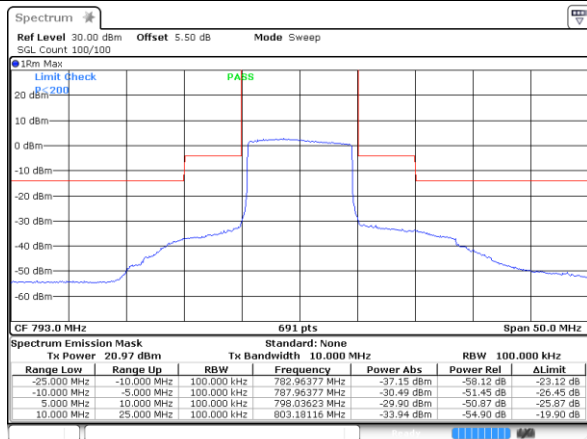

Date: 30 NOV 2020 17:47:41

Frequency Stability

Test Conditions		LTE Band 14 (QPSK) / Middle Channel	Limit
Temperature (°C)	Voltage (Volt)	BW 10MHz	Note 2.
		Deviation (ppm)	Result
50	Normal Voltage	0.0044	PASS
40	Normal Voltage	0.0035	
30	Normal Voltage	0.0005	
20(Ref.)	Normal Voltage	0.0000	
10	Normal Voltage	0.0026	
0	Normal Voltage	0.0040	
-10	Normal Voltage	0.0011	
-20	Normal Voltage	0.0044	
-30	Normal Voltage	0.0006	
20	Maximum Voltage	0.0037	
20	Normal Voltage	0.0006	
20	Battery End Point	0.0026	

Note:

1. Normal Voltage =3.3 V. ; Battery End Point (BEP) =3.135 V. ; Maximum Voltage =4.4 V.
2. Note: The frequency fundamental emissions stay within the authorized frequency block.

Appendix B. Test Results of Radiated Test

Field Strength of Spurious Radiated

LTE Band 14 / 5MHz / QPSK / RB Size 1 Offset 0								
Bandwidth	Frequency (MHz)	ERP (dBm)	Limit (dBm)	Over Limit (dB)	S.G. Power (dBm)	TX Cable loss (dB)	TX Antenna Gain (dBi)	Polarization (H/V)
Lowest	1576	-64.65	-40	-24.65	-67.28	1.09	5.87	H
	2364	-60.12	-13	-47.12	-62.52	1.37	5.92	H
	3156	-58.57	-13	-45.57	-62.46	1.64	7.68	H
	3942	-55.52	-13	-42.52	-59.40	1.65	7.68	H
	1576	-64.80	-40	-24.80	-67.43	1.09	5.87	V
	2364	-59.19	-13	-46.19	-61.59	1.37	5.92	V
	3156	-57.61	-13	-44.61	-61.50	1.64	7.68	V
	3942	-55.67	-13	-42.67	-59.57	1.63	7.68	V
Middle	1582	-65.16	-40	-25.16	-67.79	1.09	5.87	H
	2372	-60.71	-13	-47.71	-63.11	1.37	5.92	H
	3162	-58.66	-13	-45.66	-62.55	1.64	7.68	H
	3954	-55.82	-13	-42.82	-59.72	1.64	7.69	H
	1582	-64.85	-40	-24.85	-67.48	1.09	5.87	V
	2372	-59.49	-13	-46.49	-61.89	1.37	5.92	V
	3162	-58.26	-13	-45.26	-62.15	1.64	7.68	V
	3954	-55.73	-13	-42.73	-59.59	1.64	7.65	V
Highest	1586	-65.22	-40	-25.22	-67.85	1.09	5.87	H
	2380	-60.81	-13	-47.81	-63.21	1.37	5.92	H
	3174	-58.57	-13	-45.57	-62.45	1.65	7.68	H
	3966	-55.96	-13	-42.96	-59.85	1.64	7.68	H
	1586	-65.10	-40	-25.10	-67.73	1.09	5.87	V
	2380	-59.54	-13	-46.54	-61.94	1.37	5.92	V
	3174	-58.05	-13	-45.05	-61.95	1.63	7.68	V
	3966	-55.90	-13	-42.90	-59.79	1.64	7.68	V
Remark: Spurious emissions within 30-1000MHz were found more than 20dB below limit line.								
Test Result					PASS			



LTE Band 14 / 10MHz / QPSK / RB Size 1 Offset 0								
Bandwidth	Frequency (MHz)	ERP (dBm)	Limit (dBm)	Over Limit (dB)	S.G. Power (dBm)	TX Cable loss (dB)	TX Antenna Gain (dBi)	Polarization (H/V)
Middle	1576	-64.76	-40	-24.76	-67.39	1.09	5.87	H
	2366	-60.32	-13	-47.32	-62.72	1.37	5.92	H
	3156	-58.66	-13	-45.66	-62.55	1.64	7.68	H
	1576	-64.63	-40	-24.63	-67.26	1.09	5.87	V
	2366	-59.08	-13	-46.08	-61.48	1.37	5.92	V
	3156	-58.14	-13	-45.14	-62.03	1.64	7.68	V
Remark: Spurious emissions within 30-1000MHz were found more than 20dB below limit line.								
Test Result					PASS			