

FCC RF Test Report

APPLICANT : Fibocom Wireless Inc.
EQUIPMENT : 5G Module
BRAND NAME : Fibocom
MODEL NAME : FM350-GL
FCC ID : ZMOFM350GL
STANDARD : 47 CFR Part 2, Part 27 Subpart Q
CLASSIFICATION : PCS Licensed Transmitter (PCB)
TEST DATE(S) : Aug. 29, 2021 ~ Sep. 27, 2021

We, Sporton International (ShenZhen) Inc., would like to declare that the tested sample has been evaluated in accordance with the procedures given in ANSI C63.26-2015 and shown compliance with the applicable technical standards.

The test results in this report apply exclusively to the tested model / sample. Without written approval of Sporton International (ShenZhen) Inc., the test report shall not be reproduced except in full.



Reviewed by: Derreck Chen / Supervisor



Approved by: Eric Shih / Manager



Sporton International (ShenZhen) Inc.

1/F, 2/F, Bldg 5, Shiling Industrial Zone, Xinwei Village, Xili, Nanshan, Shenzhen, 518055

People's Republic of China



TABLE OF CONTENTS

REVISION HISTORY... 3
SUMMARY OF TEST RESULT ... 4
1 GENERAL DESCRIPTION ... 5
1.1 Applicant ... 5
1.2 Manufacturer ... 5
1.3 Product Feature of Equipment Under Test ... 5
1.4 Product Specification of Equipment Under Test ... 5
1.5 Modification of EUT ... 6
1.6 Maximum Conducted Power and Emission Designator ... 6
1.7 Testing Site ... 8
1.8 Test Software ... 8
1.9 Applied Standards ... 8
2 TEST CONFIGURATION OF EQUIPMENT UNDER TEST ... 9
2.1 Test Mode ... 9
2.2 Connection Diagram of Test System ... 10
2.3 Support Unit used in test configuration and system ... 10
2.4 Measurement Results Explanation Example ... 10
2.5 Frequency List of Low/Middle/High Channels ... 11
3 CONDUCTED TEST ITEMS ... 12
3.1 Measuring Instruments ... 12
3.2 Test Setup ... 12
3.3 Test Result of Conducted Test ... 12
3.4 Conducted Output Power Measurement ... 13
3.5 Peak-to-Average Ratio ... 14
3.6 EIRP ... 15
3.7 Occupied Bandwidth ... 16
3.8 Conducted Band Edge Measurement ... 17
3.9 Conducted Spurious Emission Measurement ... 18
3.10 Frequency Stability Measurement ... 19
4 RADIATED TEST ITEMS ... 20
4.1 Measuring Instruments ... 20
4.2 Test Setup ... 20
4.3 Test Result of Radiated Test ... 21
4.4 Radiated Spurious Emission Measurement ... 22
5 LIST OF MEASURING EQUIPMENT ... 23
6 UNCERTAINTY OF EVALUATION ... 24
APPENDIX A. TEST RESULTS OF CONDUCTED TEST
APPENDIX B. TEST RESULTS OF RADIATED TEST
APPENDIX C. TEST SETUP PHOTOGRAPHS



REVISION HISTORY

REPORT NO.	VERSION	DESCRIPTION	ISSUED DATE
FG051802-04D	Rev. 01	Initial issue of report	Oct. 09, 2021



SUMMARY OF TEST RESULT

Report Section	FCC Rule	Description	Limit	Result	Remark
3.4	§2.1046	Conducted Output Power	-	Report Only	-
3.5	§27.50 (k)(4)	Peak-to-Average Ratio	<13dB	PASS	-
3.6	§27.50 (k)(3)	EIRP	EIRP < 1W (30dBm)	PASS	-
3.7	§2.1049	Occupied Bandwidth	-	Report Only	-
3.8	§2.1051 §27.53 (n)(2)	Conducted Band Edge Measurement	-13dBm/MHz	PASS	-
3.9	§2.1051 §27.53 (n)(2)	Conducted Spurious Emission	-13dBm/MHz	PASS	-
3.10	§2.1055 §27.54	Frequency Stability Temperature & Voltage	Within the band	PASS	-
4.4	§2.1053 §27.53 (n)(2)	Radiated Spurious Emission	-13dBm/MHz	PASS	Under limit 31.96 dB at 14142.960 MHz

Declaration of Conformity:
The test results with all measurement uncertainty excluded are presented in accordance with the regulation limits or requirements declared by manufacturers.

Comments and Explanations:
The declared of product specification for EUT presented in the report are provided by the manufacturer, and the manufacturer takes all the responsibilities for the accuracy of product specification.



1 General Description

1.1 Applicant

Fibocom Wireless Inc.

1101, Tower A, Building 6, Shenzhen International Innovation Valley, Dashi 1st Rd, Nanshan, Shenzhen, China

1.2 Manufacturer

Fibocom Wireless Inc.

1101, Tower A, Building 6, Shenzhen International Innovation Valley, Dashi 1st Rd, Nanshan, Shenzhen, China

1.3 Product Feature of Equipment Under Test

Product Feature	
Equipment	5G Module
Brand Name	Fibocom
Model Name	FM350-GL
FCC ID	ZMOFM350GL
IMEI Code	Conducted: 354174400007998 Radiation: 862146050150950 for NSA n77 354174400007998 for SA n77_UL MIMO/SA/NSA n78
HW Version	V1.0.6
SW Version	81600.0000.00.19.16.97
EUT Stage	Identical Prototype

1.4 Product Specification of Equipment Under Test

Product Feature	
Tx/Rx Frequency	5G NR n77/n78: 3450 MHz ~ 3550 MHz
Bandwidth	5G NR n77/n78 : SCS 15KHz: 10MHz / 15MHz / 20MHz SCS 30KHz: 10MHz / 15MHz / 20MHz / 40MHz / 50MHz / 60MHz / 80MHz / 100MHz
SCS	15kHz, 30kHz
Maximum Output Power to Antenna	MIMO: SCS: 15kHz 5G NR n77 : 24.85 dBm 5G NR n78 : 24.82 dBm SCS: 30kHz 5G NR n77 : 24.43 dBm 5G NR n78 : 24.34 dBm

	SISO: SCS: 15kHz 5G NR n77 : 26.16 dBm for NSA 5G NR n78 : 26.71 dBm for SA SCS: 30kHz 5G NR n77 : 25.89 dBm for NSA 5G NR n78 : 26.84 dBm for SA
Antenna Gain	5G NR n77 : 3.0 dBi 5G NR n78 : 3.0 dBi
Type of Modulation	CP-OFDM: QPSK / 16QAM / 64QAM / 256QAM DFT-s-OFDM: PI/2 BPSK / QPSK / 16QAM / 64QAM / 256QAM

Note:

1. 5G NR n77/n78 support HPUE mode.
2. 5G NR n77/n78 supports SA / NSA mode and UL MIMO mode. Pre-scanned for conducted power, 5G NR n77 covers n78 for MIMO mode, 5G NR n78 covers n77 for SISO mode. Only the maximum Power of SA/NSA/UL MIMO are shown in the report.
3. For NSA mode of all 5G NR, we only show the combination of the maximum power among all NSA combinations in the report.
4. For SISO mode, only the port 2 is transmit mode. The port 1 is for UL MIMO mode only.
5. The EN-DC mode combination could be referred to the product spec.

1.5 Modification of EUT

No modifications are made to the EUT during all test items.

1.6 Maximum Conducted Power and Emission Designator

5G NR n77_UL MIMO (15 kHz)		QPSK		16QAM / 64QAM / 256QAM	
BW (MHz)	Frequency Range (MHz)	Maximum Conducted power (W)	Emission Designator (99%OBW)	Maximum Conducted power (W)	Emission Designator (99%OBW)
10	3455.01 ~ 3544.995	0.2805	9M29G7D	0.2576	9M33W7D
15	3457.5 ~ 3542.49	0.3055	14M2G7D	0.2727	14M2W7D
20	3460.005 ~ 3540	0.2928	18M9G7D	0.2720	19M0W7D

5G NR n77_UL MIMO (30 kHz)		QPSK		16QAM / 64QAM / 256QAM	
BW (MHz)	Frequency Range (MHz)	Maximum Conducted power (W)	Emission Designator (99%OBW)	Maximum Conducted power (W)	Emission Designator (99%OBW)
10	3455.01 ~ 3544.98	0.2770	8M57G7D	0.2464	8M59W7D
15	3457.5 ~ 3542.49	0.2745	13M6G7D	0.2452	13M6W7D
20	3460.02 ~ 3540	0.2733	18M3G7D	0.2424	18M3W7D
40	3470.01 ~ 3529.98	0.2677	38M0G7D	0.2394	38M4W7D
50	3475.02 ~ 3525	0.2696	47M7G7D	0.2396	47M9W7D
60	3480 ~ 3519.99	0.2716	58M0G7D	0.2452	58M4W7D
80	3490.02 ~ 3510	0.2682	77M5G7D	0.2402	77M7W7D
100	3500.01	0.2655	97M1G7D	0.2377	97M5W7D

5G NR n78 (15 kHz)		PI/2 BPSK / QPSK		16QAM / 64QAM / 256QAM	
BW (MHz)	Frequency Range (MHz)	Maximum Conducted power (W)	Emission Designator (99%OBW)	Maximum Conducted power (W)	Emission Designator (99%OBW)
10	3455.01 ~ 3544.995	0.4508	9M35G7D	0.3532	9M39W7D
15	3457.5 ~ 3542.49	0.4688	14M1G7D	0.3784	14M3W7D
20	3460.005 ~ 3540	0.4645	19M1G7D	0.3673	19M1W7D

5G NR n78 (30 kHz)		PI/2 BPSK / QPSK		16QAM / 64QAM / 256QAM	
BW (MHz)	Frequency Range (MHz)	Maximum Conducted power (W)	Emission Designator (99%OBW)	Maximum Conducted power (W)	Emission Designator (99%OBW)
10	3455.01 ~ 3544.98	0.4831	8M61G7D	0.3767	8M58W7D
15	3457.5 ~ 3542.49	0.4819	13M6G7D	0.3846	13M6W7D
20	3460.02 ~ 3540	0.4819	18M2G7D	0.3855	18M2W7D
40	3470.01 ~ 3529.98	0.4764	37M8G7D	0.3758	37M8W7D
50	3475.02 ~ 3525	0.4831	47M5G7D	0.3776	47M5W7D
60	3480 ~ 3519.99	0.4764	57M9G7D	0.3776	57M8W7D
80	3490.02 ~ 3510	0.4539	77M6G7D	0.3622	77M6W7D
100	3500.01	0.4519	97M4G7D	0.3581	97M5W7D

Note: All modulations have been evaluation, only the worst test results of PSK & QAM are shown in the report.

1.7 Testing Site

Sporton International (Shenzhen) Inc. is accredited to ISO/IEC 17025:2017 by American Association for Laboratory Accreditation with Certificate Number 5145.01.

Test Firm	Sporton International (Shenzhen) Inc.		
Test Site Location	1/F, 2/F, Bldg 5, Shiling Industrial Zone, Xinwei Village, Xili, Nanshan, Shenzhen, 518055 People's Republic of China TEL: +86-755-86379589 FAX: +86-755-86379595		
Test Site No.	Sporton Site No.	FCC Designation No.	FCC Test Firm Registration No.
	TH01-SZ	CN1256	421272

Test Firm	Sporton International (Shenzhen) Inc.		
Test Site Location	101, 1st Floor, Block B, Building 1, No. 2, Tengfeng 4th Road, Fenghuang Community, Fuyong Street, Baoan District, Shenzhen City Guangdong Province China 518103 TEL: +86-755-33202398		
Test Site No.	Sporton Site No.	FCC Designation No.	FCC Test Firm Registration No.
	03CH03-SZ	CN1256	421272

1.8 Test Software

Item	Site	Manufacturer	Name	Version
1.	03CH03-SZ	AUDIX	E3	6.2009-8-24

1.9 Applied Standards

According to the specifications of the manufacturer, the EUT must comply with the requirements of the following standards:

- 47 CFR Part 2, Part 27 Subpart Q
- ANSI C63.26-2015
- FCC KDB 971168 Power Meas License Digital Systems D01 v03r01
- FCC KDB 412172 D01 Determining ERP and EIRP v01r01

Remark:

1. All test items were verified and recorded according to the standards and without any deviation during the test.
2. This EUT has also been tested and complied with the requirements of FCC Part 15, Subpart B, recorded in a separate test report.

2 Test Configuration of Equipment Under Test

2.1 Test Mode

Antenna port conducted and radiated test items listed below are performed according to KDB 971168 D01 Power Meas. License Digital Systems v03r01 with maximum output power.

Radiated measurements are performed by rotating the EUT in three different orthogonal test planes to find the maximum emission.

Test Cases	Band	Bandwidth (MHz)	Modulation	RB #	Test Channel
		eg. 5M, 10M, 15M, 20M...	eg. BPSK, QPSK, 16QAM, 64QAM, 256QAM	1RB, Partial RB, Full RB	L/M/H
Max. Output Power	5G n77/n78	All BWs	All Modulations	1RB, Partial RB, Full RB	L, M, H
Peak-to-Average Ratio	5G n77	20M(SCS15kHz), 10M(SCS30kHz)	QPSK	1RB, Full RB	L, M, H
	5G n78	20M	BPSK, QPSK	1RB, Full RB	L, M, H
E.I.R.P	5G n77/n78	All BWs	All Modulations	1RB, Partial RB, Full RB	L, M, H
26dB and 99% Bandwidth	5G n77	All BWs	QPSK, 16QAM, 64QAM, 256QAM	Full RB	M
	5G n78	All BWs	BPSK, QPSK, 16QAM, 64QAM, 256QAM	Full RB	M
Conducted Band Edge	5G n77	L, M, H BWs	QPSK	1RB, Full RB	L, H
	5G n78	L, M, H BWs	BPSK, QPSK	1RB, Full RB	L, H
Conducted Spurious Emission	5G n77	L, M, H BWs	QPSK	1RB	L, M, H
	5G n78	L, M, H BWs	BPSK, QPSK	1RB	L, M, H
Frequency Stability	5G n77/n78	20M	QPSK	Full RB	M
Radiated Spurious Emission	5G n77/n78	Worst case from maximum power			M

Note:

1. The device is investigated from 30MHz to 10 times of fundamental signal for radiated spurious emission test under different RB size/offset and modulations in exploratory test. Subsequently, only the worst case emissions are reported.
2. Based on engineering evaluation, only the worst modulations test results are shown in the report.
3. For modulation of CP-OFDM and DFT-s-OFDM, the 5G NR n78 maximum power for DFT-s-OFDM modulation and the 5G NR n77 maximum power for CP-OFDM modulation therefore, we chose modulation of higher power to perform all tests and show in the report.

2.2 Connection Diagram of Test System

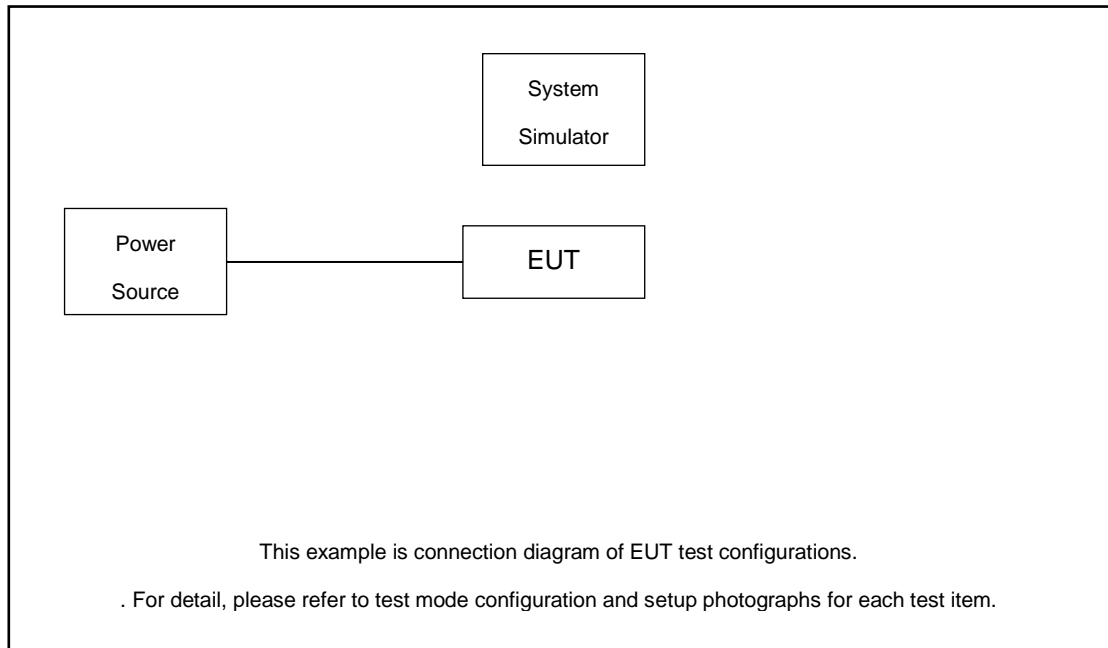

2.3 Support Unit used in test configuration and system

Item	Equipment	Trade Name	Model No.	FCC ID	Data Cable	Power Cord
1.	DC Power Supply	GW	GPS-3030D	N/A	N/A	Unshielded, 1.8 m
2.	LTE Base Station	Anritsu	MT8821C	N/A	N/A	Unshielded, 1.8 m
3.	NR Base Station	Anritsu	MT8000A	N/A	N/A	Unshielded, 1.8 m
4.	Test Jig	N/A	N/A	N/A	N/A	N/A
5.	Adapter	N/A	N/A	N/A	N/A	N/A

2.4 Measurement Results Explanation Example

For all conducted test items:

The offset level is set in the spectrum analyzer to compensate the RF cable loss and between EUT conducted output port and spectrum analyzer. With the offset compensation, the spectrum analyzer reading level is exactly the EUT RF output level.

The spectrum analyzer offset is derived from RF cable loss.

Offset = RF cable loss.

Following shows an offset computation example with cable loss 8.0 dB.

Example :

$$\begin{aligned} \text{Offset(dB)} &= \text{RF cable loss(dB)}. \\ &= 8.0 \text{ (dB)} \end{aligned}$$

2.5 Frequency List of Low/Middle/High Channels

5G n77/n78 Channel and Frequency List for SCS 15kHz				
BW [MHz]	Channel/Frequency(MHz)	Lowest	Middle	Highest
20	Channel	630667	633334	636000
	Frequency	3460.005	3500.01	3540
15	Channel	630500	633334	636166
	Frequency	3457.5	3500.01	3542.49
10	Channel	630334	633334	636333
	Frequency	3455.01	3500.01	3544.995

5G n77/n78 Channel and Frequency List for SCS 30kHz				
BW [MHz]	Channel/Frequency(MHz)	Lowest	Middle	Highest
100	Channel	-	633334	-
	Frequency	-	3500.01	-
80	Channel	632668	633334	634000
	Frequency	3490.02	3500.01	3510
60	Channel	632000	633334	634666
	Frequency	3480	3500.01	3519.99
50	Channel	631668	633334	635000
	Frequency	3475.02	3500.01	3525
40	Channel	631334	633334	635332
	Frequency	3470.01	3500.01	3529.98
20	Channel	630668	633334	636000
	Frequency	3460.02	3500.01	3540
15	Channel	630500	633334	636166
	Frequency	3457.5	3500.01	3542.49
10	Channel	630334	633334	636332
	Frequency	3455.01	3500.01	3544.98

3 Conducted Test Items

3.1 Measuring Instruments

See list of measuring instruments of this test report.

3.2 Test Setup

3.2.1 Conducted Output Power

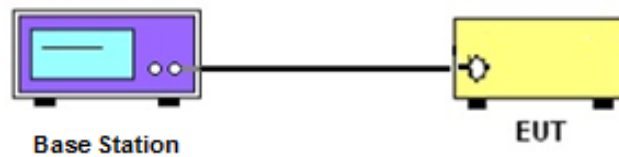

3.2.2 Peak-to-Average Ratio, Occupied / 26dB Bandwidth ,Band-Edge and Conducted Spurious Emission

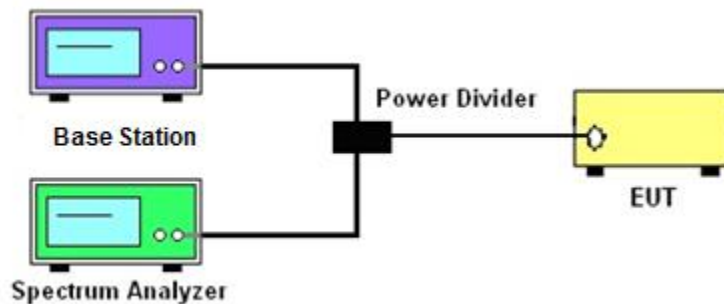

3.2.3 Frequency Stability

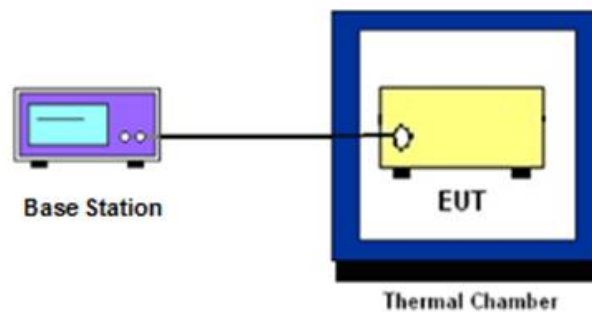

3.3 Test Result of Conducted Test

Please refer to Appendix A.



3.4 Conducted Output Power Measurement

3.4.1 Description of the Conducted Output Power Measurement

A base station simulator was used to establish communication with the EUT. Its parameters were set to transmit the maximum power on the EUT. The measured power in the radio frequency on the transmitter output terminals shall be reported.

3.4.2 Test Procedures

1. The testing follows ANSI C63.26 Section 5.2
2. The transmitter output port was connected to the system simulator.
3. Set EUT at maximum power through the system simulator.
4. Select lowest, middle, and highest channels for each band and different modulation.
5. Measure and record the power level from the system simulator.

3.5 Peak-to-Average Ratio

3.5.1 Description of the PAR Measurement

Power Complementary Cumulative Distribution Function (CCDF) curves provide a means for characterizing the power peaks of a digitally modulated signal on a statistical basis. A CCDF curve depicts the probability of the peak signal amplitude exceeding the average power level. Most contemporary measurement instrumentation include the capability to produce CCDF curves for an input signal provided that the instrument's resolution bandwidth can be set wide enough to accommodate the entire input signal bandwidth. In measuring transmissions in this band using an average power technique, the peak-to-average ratio (PAR) of the transmission may not exceed 13 dB.

3.5.2 Test Procedures

1. The testing follows ANSI C63.26 Section 5.2.3.4 (CCDF).
2. The EUT was connected to spectrum and system simulator via a power divider.
3. Set the CCDF (Complementary Cumulative Distribution Function) option in spectrum analyzer.
4. The highest RF powers were measured and recorded the maximum PAPR level associated with a probability of 0.1 %.
5. Record the deviation as Peak to Average Ratio.

3.6 EIRP

3.6.1 Description of EIRP Limit

§ 27.50 (k)(3)

Mobile devices are limited to 1Watt (30 dBm) EIRP. Mobile devices operating in these bands must employ a means for limiting power to the minimum necessary for successful communications

3.6.2 Test Procedures

1. According to KDB 412172 D01 Power Approach,
2. $EIRP = P_T + G_T - L_C$, $ERP = EIRP - 2.15$, where
 P_T = transmitter output power in dBm
 G_T = gain of the transmitting antenna in dBi
 L_C = signal attenuation in the connecting cable between the transmitter and antenna in dB

3.7 Occupied Bandwidth

3.7.1 Description of Occupied Bandwidth Measurement

The occupied bandwidth is the width of a frequency band such that, below the lower and above the upper frequency limits, the mean powers emitted are each equal to a specified percentage 0.5% of the total mean transmitted power.

The 26 dB emission bandwidth is defined as the frequency range between two points, one above and one below the carrier frequency, at which the spectral density of the emission is attenuated 26 dB below the maximum in-band spectral density of the modulated signal. Spectral density (power per unit bandwidth) is to be measured with a detector of resolution bandwidth equal to approximately 1.0% of the emission bandwidth.

3.7.2 Test Procedures

1. The testing follows ANSI C63.26 Section 5.4
2. The EUT was connected to spectrum analyzer and system simulator via a power divider.
3. The spectrum analyzer center frequency is set to the nominal EUT channel center frequency. The span range for the spectrum analyzer shall be between two and five times the anticipated OBW.
4. The nominal resolution bandwidth (RBW) shall be in the range of 1 to 5 % of the anticipated OBW, and the VBW shall be at least 3 times the RBW.
5. Set the detection mode to peak, and the trace mode to max hold.
6. Determine the reference value: Set the EUT to transmit a modulated signal. Allow the trace to stabilize. Set the spectrum analyzer marker to the highest level of the displayed trace.
(this is the reference value)
7. Determine the “-26 dB down amplitude” as equal to (Reference Value – X).
8. Place two markers, one at the lowest and the other at the highest frequency of the envelope of the spectral display such that each marker is at or slightly below the “-X dB down amplitude” determined in step 6. If a marker is below this “-X dB down amplitude” value it shall be placed as close as possible to this value. The OBW is the positive frequency difference between the two markers.
9. Use the 99 % power bandwidth function of the spectrum analyzer and report the measured bandwidth.

3.8 Conducted Band Edge Measurement

3.8.1 Description of Conducted Band Edge Measurement

§ 27.53 (n)(2)

For mobile operations in the 3450-3550 MHz band, the conducted power of any emission outside the licensee's authorized bandwidth shall not exceed -13 dBm/MHz.

Compliance with this paragraph is based on the use of measurement instrumentation employing a resolution bandwidth of 1 megahertz or greater. However, in the 1 megahertz bands immediately outside and adjacent to the licensee's frequency block, a resolution bandwidth of at least one percent of the emission bandwidth of the fundamental emission of the transmitter may be employed, but limited to a maximum of 200 kHz. In the bands between 1 and 5 MHz removed from the licensee's frequency block, the minimum resolution bandwidth for the measurement shall be 500 kHz.

3.8.2 Test Procedures

1. The testing follows ANSI C63.26 section 5.7
2. The EUT was connected to spectrum analyzer and system simulator via a power divider.
3. The band edges of low and high channels for the highest RF powers were measured.
4. Set RBW $\geq 1\%$ EBW but limited to a maximum of 200 kHz in the 1MHz band immediately outside and adjacent to the band edge.
5. Beyond the 1 MHz and 5 MHz removed from the band edge, set RBW ≥ 500 KHz.
6. Beyond the 5 MHz removed from the band edge, set RBW = 1MHz.
7. Set spectrum analyzer with RMS detector.
8. The RF fundamental frequency should be excluded against the limit line in the operating frequency band.
9. Checked that all the results comply with the emission limit line.
10. When using the integration method, the starting frequency of the integration shall be centered at one-half of the RBW away from the band edge.

3.9 Conducted Spurious Emission Measurement

3.9.1 Description of Conducted Spurious Emission Measurement

The power of any emission outside of the authorized operating frequency ranges shall not exceed -13 dBm/MHz.

It is measured by means of a calibrated spectrum analyzer and scanned from 30MHz up to a frequency including its 10th harmonic.

3.9.2 Test Procedures

1. The testing follows ANSI C63.26 section 5.7
2. The EUT was connected to spectrum analyzer and system simulator via a power divider.
3. The RF output of EUT was connected to the spectrum analyzer by RF cable and attenuator. The path loss was compensated to the results for each measurement.
4. The middle channel for the highest RF power within the transmitting frequency was measured.
5. The conducted spurious emission for the whole frequency range was taken.
6. Make the measurement with the spectrum analyzer's RBW = 1MHz, VBW = 3MHz.
7. Set spectrum analyzer with RMS detector.
8. Taking the record of maximum spurious emission.
9. The RF fundamental frequency should be excluded against the limit line in the operating frequency band.
10. Checked that all the results comply with the emission limit line.

3.10 Frequency Stability Measurement

3.10.1 Description of Frequency Stability Measurement

The frequency stability shall be measured by variation of ambient temperature and variation of primary supply voltage to ensure that the fundamental emission stays within the authorized frequency block.

3.10.2 Test Procedures for Temperature Variation

1. The testing follows ANSI C63.26 section 5.6.4
2. The EUT was set up in the thermal chamber and connected with the system simulator.
3. With power OFF, the temperature was decreased to -30°C and the EUT was stabilized before testing. Power was applied and the maximum change in frequency was recorded within one minute.
4. With power OFF, the temperature was raised in 10°C step up to 50°C . The EUT was stabilized at each step for at least half an hour. Power was applied and the maximum frequency change was recorded within one minute.

3.10.3 Test Procedures for Voltage Variation

1. The testing follows ANSI C63.26 section 5.6.5.
2. The EUT was placed in a temperature chamber at $20\pm 5^{\circ}\text{C}$ and connected with the system simulator.
3. The power supply voltage to the EUT was varied from 85% to 115% of the nominal value for other than hand carried battery equipment.
4. For hand carried, battery powered equipment, reduce the primary ac or dc supply voltage to the battery operating end point, which shall be specified by the manufacturer.
5. The variation in frequency was measured for the worst case.

4 Radiated Test Items

4.1 Measuring Instruments

See list of measuring instruments of this test report.

4.2 Test Setup

4.2.1 For radiated test below 30MHz



4.2.2 For radiated test from 30MHz to 1GHz

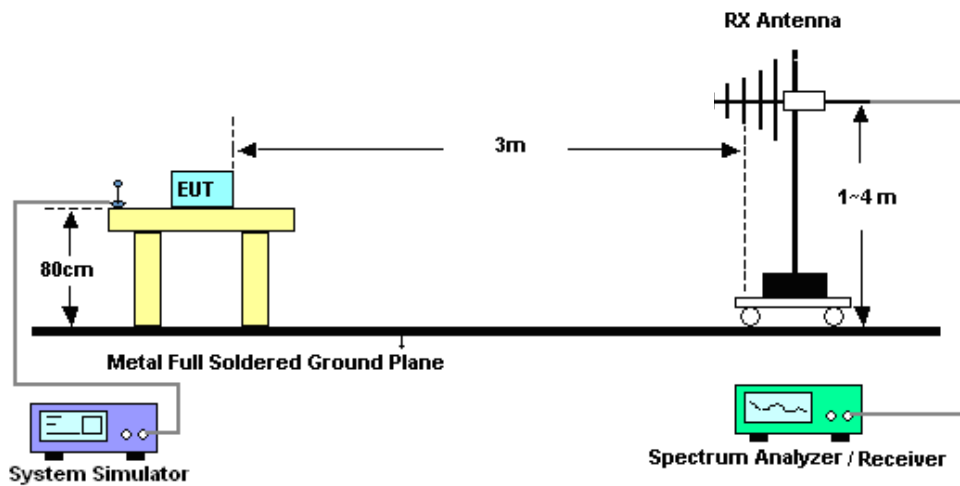

4.2.3 For radiated test above 1GHz



4.3 Test Result of Radiated Test

The low frequency, which started from 9 kHz to 30MHz, was pre-scanned and the result which was 20dB lower than the limit line was not reported.

Please refer to Appendix B.

4.4 Radiated Spurious Emission Measurement

4.4.1 Description of Radiated Spurious Emission

The radiated spurious emission was measured by substitution method according to ANSI C63.26. The power of any emission outside of the authorized operating frequency ranges shall not exceed -13 dBm/MHz.

The spectrum is scanned from 30 MHz up to a frequency including its 10th harmonic.

4.4.2 Test Procedures

1. The testing follows ANSI C63.26 Section 5.5
2. The EUT was placed on a turntable with 0.8 meter height for frequency below 1GHz and 1.5 meter height for frequency above 1GHz respectively above ground.
3. The EUT was set 3 meters from the receiving antenna mounted on the antenna tower.
4. The table was rotated 360 degrees to determine the position of the highest spurious emission.
5. The height of the receiving antenna is varied between 1m to 4m to search the maximum spurious emission for both horizontal and vertical polarizations.
6. During the measurement, the system simulator parameters were set to force the EUT transmitting at maximum output power.
7. Make the measurement with the spectrum analyzer's RBW = 1MHz, VBW = 3MHz, taking the record of maximum spurious emission.
8. A horn antenna was substituted in place of the EUT and was driven by a signal generator.
9. Tune the output power of signal generator to the same emission level with EUT maximum spurious emission.
$$\text{EIRP (dBm)} = \text{S.G. Power} - \text{Tx Cable Loss} + \text{Tx Antenna Gain}$$
$$\text{ERP (dBm)} = \text{EIRP} - 2.15$$
10. The RF fundamental frequency should be excluded against the limit line in the operating frequency band.



5 List of Measuring Equipment

Instrument	Manufacturer	Model No.	Serial No.	Characteristics	Calibration Date	Test Date	Due Date	Remark
Spectrum Analyzer	R&S	FSV40	101078	10Hz~40GHz	Apr. 08, 2021	Aug. 29, 2021~ Sep. 27, 2021	Apr. 07, 2022	Conducted (TH01-SZ)
EXA Signal Analyzer	KEYSIGHT	N9010B	MY60240803	10Hz~44GHz	Apr. 03, 2021	Aug. 29, 2021~ Sep. 27, 2021	Apr. 02, 2022	Conducted (TH01-SZ)
Power Divider	TOJOIN	PS-2SM-04265	60.06.020.0077	0.4GHz~26.5GHz	Dec. 26, 2020	Aug. 29, 2021~ Sep. 27, 2021	Dec. 25, 2021	Conducted (TH01-SZ)
Thermal Chamber	Ten Billion Hongzhangroup	LP-150U	H2014081803	-40~+150°C	Jul. 14, 2021	Aug. 29, 2021~ Sep. 27, 2021	Jul. 13, 2022	Conducted (TH01-SZ)
EMI Test Receiver&SA	KEYSIGHT	N9038A	MY54450083	20Hz~8.4GHz	Apr. 07, 2021	Sep. 27, 2021	Apr. 06, 2022	Radiation (03CH03-SZ)
Loop Antenna	R&S	HFH2-Z2	100354	9kHz~30MHz	Jun. 22, 2020	Sep. 27, 2021	Jun. 21, 2022	Radiation (03CH03-SZ)
EXA Spectrum Analyzer	KEYSIGHT	N9010A	MY55150246	10Hz~44GHz;	Apr. 07, 2021	Sep. 27, 2021	Apr. 06, 2022	Radiation (03CH03-SZ)
Bilog Antenna	TeseQ	CBL6112D	35408	30MHz~2GHz	Jun. 22, 2021	Sep. 27, 2021	Jun. 21, 2022	Radiation (03CH03-SZ)
Double Ridge Horn Antenna	SCHWARZBECK	BBHA9120D	9120D-1355	1GHz~18GHz	Apr. 25, 2021	Sep. 27, 2021	Apr. 24, 2022	Radiation (03CH03-SZ)
Amplifier	Burgeon	BPA-530	102211	0.01Hz~3000MHz	Oct. 16, 2020	Sep. 27, 2021	Oct. 15, 2021	Radiation (03CH03-SZ)
HF Amplifier	MITEQ	TTA1840-35-HG	1871923	18GHz~40GHz	Jun. 22, 2020	Sep. 27, 2021	Jun. 21, 2022	Radiation (03CH03-SZ)
SHF-EHF Horn	com-power	AH-840	101071	18GHz~40GHz	Apr. 11, 2021	Sep. 27, 2021	Apr. 10, 2022	Radiation (03CH03-SZ)
Amplifier	Agilent Technologies	83017A	MY39501302	500MHz~26.5GHz	Dec. 30, 2020	Sep. 27, 2021	Dec. 29, 2021	Radiation (03CH03-SZ)
AC Power Source	Chroma	61601	616010001985	N/A	NCR	Sep. 27, 2021	NCR	Radiation (03CH03-SZ)
Turn Table	EM	EM1000	N/A	0~360 degree	NCR	Sep. 27, 2021	NCR	Radiation (03CH03-SZ)
Antenna Mast	EM	EM1000	N/A	1 m~4 m	NCR	Sep. 27, 2021	NCR	Radiation (03CH03-SZ)

NCR: No Calibration Required

6 Uncertainty of Evaluation

The measurement uncertainties shown below were calculated in accordance with the requirements of ANSI 63.26-2015. All the measurement uncertainty value were shown with a coverage $K=2$ to indicate 95% level of confidence. The measurement data show herein meets or exceeds the CISPR measurement uncertainty values specified in CISPR 16-4-2 and can be compared directly to specified limit to determine compliance.

Uncertainty of Radiated Emission Measurement (30 MHz ~ 1000 MHz)

Measuring Uncertainty for a Level of Confidence of 95% ($U = 2Uc(y)$)	3.0dB
---	-------

Uncertainty of Radiated Emission Measurement (1 GHz ~ 18 GHz)

Measuring Uncertainty for a Level of Confidence of 95% ($U = 2Uc(y)$)	3.6dB
---	-------

Uncertainty of Radiated Emission Measurement (18 GHz ~ 40 GHz)

Measuring Uncertainty for a Level of Confidence of 95% ($U = 2Uc(y)$)	3.8dB
---	-------

----- THE END -----



Appendix A. Test Results of Conducted Test

Conducted Output Power(Average power) and EIRP

FR1 N77

LTE Band: 2, LTE BW: 10M, LTE ARFCN: Mid

Transmitter Conducted Output Power And ERP/EIRP, ($G_T - L_C$)=3.0dB

NR Band	SCS (kHz)	Bandwidth (MHz)	Arfcn	Freq (MHz)	Modulation	RB	Conducted Power(dBm)	EIRP (dBm)	EIRP (W)
77	15	10	630334	3455.01	DFT-s-OFDM PI/2 BPSK	25@12	25.64	28.64	0.7311
77	15	10	630334	3455.01	DFT-s-OFDM PI/2 BPSK	1@1	25.64	28.64	0.7311
77	15	10	630334	3455.01	DFT-s-OFDM PI/2 BPSK	1@50	25.7	28.7	0.7413
77	15	10	630334	3455.01	DFT-s-OFDM QPSK	25@12	25.69	28.69	0.7396
77	15	10	630334	3455.01	DFT-s-OFDM QPSK	1@1	25.61	28.61	0.7261
77	15	10	630334	3455.01	DFT-s-OFDM QPSK	1@50	25.68	28.68	0.7379
77	15	10	630334	3455.01	DFT-s-OFDM 16 QAM	25@12	24.64	27.64	0.5808
77	15	10	630334	3455.01	DFT-s-OFDM 16 QAM	1@1	24.91	27.91	0.6180
77	15	10	630334	3455.01	DFT-s-OFDM 16 QAM	1@50	24.98	27.98	0.6281
77	15	10	630334	3455.01	DFT-s-OFDM 64 QAM	25@12	23.13	26.13	0.4102
77	15	10	630334	3455.01	DFT-s-OFDM 64 QAM	1@1	23.1	26.1	0.4074
77	15	10	630334	3455.01	DFT-s-OFDM 64 QAM	1@50	23.17	26.17	0.4140
77	15	10	630334	3455.01	DFT-s-OFDM 256 QAM	25@12	21.11	24.11	0.2576
77	15	10	630334	3455.01	DFT-s-OFDM 256 QAM	1@1	20.68	23.68	0.2333
77	15	10	630334	3455.01	DFT-s-OFDM 256 QAM	1@50	21.44	24.44	0.2780
77	15	10	630334	3455.01	CP-OFDM QPSK	26@13	24.07	27.07	0.5093
77	15	10	630334	3455.01	CP-OFDM QPSK	1@1	24.06	27.06	0.5082
77	15	10	630334	3455.01	CP-OFDM QPSK	1@50	24.11	27.11	0.5140
77	15	10	633334	3500.01	DFT-s-OFDM PI/2 BPSK	25@12	25.77	28.77	0.7534
77	15	10	633334	3500.01	DFT-s-OFDM PI/2 BPSK	1@1	25.7	28.7	0.7413
77	15	10	633334	3500.01	DFT-s-OFDM PI/2 BPSK	1@50	25.83	28.83	0.7638
77	15	10	633334	3500.01	DFT-s-OFDM QPSK	25@12	25.8	28.8	0.7586
77	15	10	633334	3500.01	DFT-s-OFDM QPSK	1@1	25.7	28.7	0.7413
77	15	10	633334	3500.01	DFT-s-OFDM QPSK	1@50	25.8	28.8	0.7586
77	15	10	633334	3500.01	DFT-s-OFDM 16 QAM	25@12	24.86	27.86	0.6109
77	15	10	633334	3500.01	DFT-s-OFDM 16 QAM	1@1	24.99	27.99	0.6295

77	15	10	633334	3500.01	DFT-s-OFDM 16 QAM	1@50	25.09	28.09	0.6442
77	15	10	633334	3500.01	DFT-s-OFDM 64 QAM	25@12	23.22	26.22	0.4188
77	15	10	633334	3500.01	DFT-s-OFDM 64 QAM	1@1	23	26	0.3981
77	15	10	633334	3500.01	DFT-s-OFDM 64 QAM	1@50	23.09	26.09	0.4064
77	15	10	633334	3500.01	DFT-s-OFDM 256 QAM	25@12	21.24	24.24	0.2655
77	15	10	633334	3500.01	DFT-s-OFDM 256 QAM	1@1	20.77	23.77	0.2382
77	15	10	633334	3500.01	DFT-s-OFDM 256 QAM	1@50	21.54	24.54	0.2844
77	15	10	633334	3500.01	CP-OFDM QPSK	26@13	24.23	27.23	0.5284
77	15	10	633334	3500.01	CP-OFDM QPSK	1@1	24.14	27.14	0.5176
77	15	10	633334	3500.01	CP-OFDM QPSK	1@50	24.2	27.2	0.5248
77	15	10	636333	3544.995	DFT-s-OFDM PI/2 BPSK	25@12	25.95	28.95	0.7852
77	15	10	636333	3544.995	DFT-s-OFDM PI/2 BPSK	1@1	25.94	28.94	0.7834
77	15	10	636333	3544.995	DFT-s-OFDM PI/2 BPSK	1@50	26.01	29.01	0.7962
77	15	10	636333	3544.995	DFT-s-OFDM QPSK	25@12	25.91	28.91	0.7780
77	15	10	636333	3544.995	DFT-s-OFDM QPSK	1@1	25.9	28.9	0.7762
77	15	10	636333	3544.995	DFT-s-OFDM QPSK	1@50	26	29	0.7943
77	15	10	636333	3544.995	DFT-s-OFDM 16 QAM	25@12	24.97	27.97	0.6266
77	15	10	636333	3544.995	DFT-s-OFDM 16 QAM	1@1	25.19	28.19	0.6592
77	15	10	636333	3544.995	DFT-s-OFDM 16 QAM	1@50	25.29	28.29	0.6745
77	15	10	636333	3544.995	DFT-s-OFDM 64 QAM	25@12	23.4	26.4	0.4365
77	15	10	636333	3544.995	DFT-s-OFDM 64 QAM	1@1	23.22	26.22	0.4188
77	15	10	636333	3544.995	DFT-s-OFDM 64 QAM	1@50	23.29	26.29	0.4256
77	15	10	636333	3544.995	DFT-s-OFDM 256 QAM	25@12	21.44	24.44	0.2780
77	15	10	636333	3544.995	DFT-s-OFDM 256 QAM	1@1	20.99	23.99	0.2506
77	15	10	636333	3544.995	DFT-s-OFDM 256 QAM	1@50	21.09	24.09	0.2564
77	15	10	636333	3544.995	CP-OFDM QPSK	26@13	24.41	27.41	0.5508
77	15	10	636333	3544.995	CP-OFDM QPSK	1@1	24.36	27.36	0.5445
77	15	10	636333	3544.995	CP-OFDM QPSK	1@50	24.38	27.38	0.5470
77	15	15	630500	3457.5	DFT-s-OFDM PI/2 BPSK	36@18	25.84	28.84	0.7656
77	15	15	630500	3457.5	DFT-s-OFDM PI/2 BPSK	1@1	25.77	28.77	0.7534
77	15	15	630500	3457.5	DFT-s-OFDM PI/2 BPSK	1@77	25.86	28.86	0.7691
77	15	15	630500	3457.5	DFT-s-OFDM QPSK	36@18	25.86	28.86	0.7691
77	15	15	630500	3457.5	DFT-s-OFDM QPSK	1@1	25.75	28.75	0.7499
77	15	15	630500	3457.5	DFT-s-OFDM QPSK	1@77	25.85	28.85	0.7674
77	15	15	630500	3457.5	DFT-s-OFDM 16 QAM	36@18	24.8	27.8	0.6026
77	15	15	630500	3457.5	DFT-s-OFDM 16 QAM	1@1	25.09	28.09	0.6442

77	15	15	630500	3457.5	DFT-s-OFDM 16 QAM	1@77	24.65	27.65	0.5821
77	15	15	630500	3457.5	DFT-s-OFDM 64 QAM	36@18	23.28	26.28	0.4246
77	15	15	630500	3457.5	DFT-s-OFDM 64 QAM	1@1	23.09	26.09	0.4064
77	15	15	630500	3457.5	DFT-s-OFDM 64 QAM	1@77	23.18	26.18	0.4150
77	15	15	630500	3457.5	DFT-s-OFDM 256 QAM	36@18	21.3	24.3	0.2692
77	15	15	630500	3457.5	DFT-s-OFDM 256 QAM	1@1	20.84	23.84	0.2421
77	15	15	630500	3457.5	DFT-s-OFDM 256 QAM	1@77	20.95	23.95	0.2483
77	15	15	630500	3457.5	CP-OFDM QPSK	39@19	24.34	27.34	0.5420
77	15	15	630500	3457.5	CP-OFDM QPSK	1@1	24.2	27.2	0.5248
77	15	15	630500	3457.5	CP-OFDM QPSK	1@77	24.34	27.34	0.5420
77	15	15	633334	3500.01	DFT-s-OFDM PI/2 BPSK	36@18	25.94	28.94	0.7834
77	15	15	633334	3500.01	DFT-s-OFDM PI/2 BPSK	1@1	25.82	28.82	0.7621
77	15	15	633334	3500.01	DFT-s-OFDM PI/2 BPSK	1@77	25.92	28.92	0.7798
77	15	15	633334	3500.01	DFT-s-OFDM QPSK	36@18	25.98	28.98	0.7907
77	15	15	633334	3500.01	DFT-s-OFDM QPSK	1@1	25.82	28.82	0.7621
77	15	15	633334	3500.01	DFT-s-OFDM QPSK	1@77	25.92	28.92	0.7798
77	15	15	633334	3500.01	DFT-s-OFDM 16 QAM	36@18	24.94	27.94	0.6223
77	15	15	633334	3500.01	DFT-s-OFDM 16 QAM	1@1	24.93	27.93	0.6209
77	15	15	633334	3500.01	DFT-s-OFDM 16 QAM	1@77	25.18	28.18	0.6577
77	15	15	633334	3500.01	DFT-s-OFDM 64 QAM	36@18	23.43	26.43	0.4395
77	15	15	633334	3500.01	DFT-s-OFDM 64 QAM	1@1	23.15	26.15	0.4121
77	15	15	633334	3500.01	DFT-s-OFDM 64 QAM	1@77	23.2	26.2	0.4169
77	15	15	633334	3500.01	DFT-s-OFDM 256 QAM	36@18	21.43	24.43	0.2773
77	15	15	633334	3500.01	DFT-s-OFDM 256 QAM	1@1	20.89	23.89	0.2449
77	15	15	633334	3500.01	DFT-s-OFDM 256 QAM	1@77	21.01	24.01	0.2518
77	15	15	633334	3500.01	CP-OFDM QPSK	39@19	24.42	27.42	0.5521
77	15	15	633334	3500.01	CP-OFDM QPSK	1@1	24.27	27.27	0.5333
77	15	15	633334	3500.01	CP-OFDM QPSK	1@77	24.41	27.41	0.5508
77	15	15	636166	3542.49	DFT-s-OFDM PI/2 BPSK	36@18	26.11	29.11	0.8147
77	15	15	636166	3542.49	DFT-s-OFDM PI/2 BPSK	1@1	26.07	29.07	0.8072
77	15	15	636166	3542.49	DFT-s-OFDM PI/2 BPSK	1@77	26.11	29.11	0.8147
77	15	15	636166	3542.49	DFT-s-OFDM QPSK	36@18	26.16	29.16	0.8241
77	15	15	636166	3542.49	DFT-s-OFDM QPSK	1@1	26.04	29.04	0.8017
77	15	15	636166	3542.49	DFT-s-OFDM QPSK	1@77	26.09	29.09	0.8110
77	15	15	636166	3542.49	DFT-s-OFDM 16 QAM	36@18	25.14	28.14	0.6516
77	15	15	636166	3542.49	DFT-s-OFDM 16 QAM	1@1	25.33	28.33	0.6808

77	15	15	636166	3542.49	DFT-s-OFDM 16 QAM	1@77	25.39	28.39	0.6902
77	15	15	636166	3542.49	DFT-s-OFDM 64 QAM	36@18	23.57	26.57	0.4539
77	15	15	636166	3542.49	DFT-s-OFDM 64 QAM	1@1	23.37	26.37	0.4335
77	15	15	636166	3542.49	DFT-s-OFDM 64 QAM	1@77	23.4	26.4	0.4365
77	15	15	636166	3542.49	DFT-s-OFDM 256 QAM	36@18	21.59	24.59	0.2877
77	15	15	636166	3542.49	DFT-s-OFDM 256 QAM	1@1	21.13	24.13	0.2588
77	15	15	636166	3542.49	DFT-s-OFDM 256 QAM	1@77	21.2	24.2	0.2630
77	15	15	636166	3542.49	CP-OFDM QPSK	39@19	24.62	27.62	0.5781
77	15	15	636166	3542.49	CP-OFDM QPSK	1@1	24.53	27.53	0.5662
77	15	15	636166	3542.49	CP-OFDM QPSK	1@77	24.57	27.57	0.5715
77	15	20	630667	3460.005	DFT-s-OFDM PI/2 BPSK	50@25	25.9	28.9	0.7762
77	15	20	630667	3460.005	DFT-s-OFDM PI/2 BPSK	1@1	25.76	28.76	0.7516
77	15	20	630667	3460.005	DFT-s-OFDM PI/2 BPSK	1@104	25.82	28.82	0.7621
77	15	20	630667	3460.005	DFT-s-OFDM QPSK	50@25	25.89	28.89	0.7745
77	15	20	630667	3460.005	DFT-s-OFDM QPSK	1@1	25.75	28.75	0.7499
77	15	20	630667	3460.005	DFT-s-OFDM QPSK	1@104	25.8	28.8	0.7586
77	15	20	630667	3460.005	DFT-s-OFDM 16 QAM	50@25	24.93	27.93	0.6209
77	15	20	630667	3460.005	DFT-s-OFDM 16 QAM	1@1	24.6	27.6	0.5754
77	15	20	630667	3460.005	DFT-s-OFDM 16 QAM	1@104	24.66	27.66	0.5834
77	15	20	630667	3460.005	DFT-s-OFDM 64 QAM	50@25	23.4	26.4	0.4365
77	15	20	630667	3460.005	DFT-s-OFDM 64 QAM	1@1	23.05	26.05	0.4027
77	15	20	630667	3460.005	DFT-s-OFDM 64 QAM	1@104	23.27	26.27	0.4236
77	15	20	630667	3460.005	DFT-s-OFDM 256 QAM	50@25	21.28	24.28	0.2679
77	15	20	630667	3460.005	DFT-s-OFDM 256 QAM	1@1	20.84	23.84	0.2421
77	15	20	630667	3460.005	DFT-s-OFDM 256 QAM	1@104	20.88	23.88	0.2443
77	15	20	630667	3460.005	CP-OFDM QPSK	53@26	24.39	27.39	0.5483
77	15	20	630667	3460.005	CP-OFDM QPSK	1@1	24.18	27.18	0.5224
77	15	20	630667	3460.005	CP-OFDM QPSK	1@104	24.21	27.21	0.5260
77	15	20	633334	3500.01	DFT-s-OFDM PI/2 BPSK	50@25	25.95	28.95	0.7852
77	15	20	633334	3500.01	DFT-s-OFDM PI/2 BPSK	1@1	25.78	28.78	0.7551
77	15	20	633334	3500.01	DFT-s-OFDM PI/2 BPSK	1@104	25.86	28.86	0.7691
77	15	20	633334	3500.01	DFT-s-OFDM QPSK	50@25	25.95	28.95	0.7852
77	15	20	633334	3500.01	DFT-s-OFDM QPSK	1@1	25.76	28.76	0.7516
77	15	20	633334	3500.01	DFT-s-OFDM QPSK	1@104	25.86	28.86	0.7691
77	15	20	633334	3500.01	DFT-s-OFDM 16 QAM	50@25	24.98	27.98	0.6281
77	15	20	633334	3500.01	DFT-s-OFDM 16 QAM	1@1	24.53	27.53	0.5662

77	15	20	633334	3500.01	DFT-s-OFDM 16 QAM	1@104	25.16	28.16	0.6546
77	15	20	633334	3500.01	DFT-s-OFDM 64 QAM	50@25	23.48	26.48	0.4446
77	15	20	633334	3500.01	DFT-s-OFDM 64 QAM	1@1	23.09	26.09	0.4064
77	15	20	633334	3500.01	DFT-s-OFDM 64 QAM	1@104	23.14	26.14	0.4111
77	15	20	633334	3500.01	DFT-s-OFDM 256 QAM	50@25	21.38	24.38	0.2742
77	15	20	633334	3500.01	DFT-s-OFDM 256 QAM	1@1	20.86	23.86	0.2432
77	15	20	633334	3500.01	DFT-s-OFDM 256 QAM	1@104	20.93	23.93	0.2472
77	15	20	633334	3500.01	CP-OFDM QPSK	53@26	24.42	27.42	0.5521
77	15	20	633334	3500.01	CP-OFDM QPSK	1@1	24.22	27.22	0.5272
77	15	20	633334	3500.01	CP-OFDM QPSK	1@104	24.26	27.26	0.5321
77	15	20	636000	3540	DFT-s-OFDM PI/2 BPSK	50@25	26.13	29.13	0.8185
77	15	20	636000	3540	DFT-s-OFDM PI/2 BPSK	1@1	26	29	0.7943
77	15	20	636000	3540	DFT-s-OFDM PI/2 BPSK	1@104	26.04	29.04	0.8017
77	15	20	636000	3540	DFT-s-OFDM QPSK	50@25	26.14	29.14	0.8204
77	15	20	636000	3540	DFT-s-OFDM QPSK	1@1	25.97	28.97	0.7889
77	15	20	636000	3540	DFT-s-OFDM QPSK	1@104	26.02	29.02	0.7980
77	15	20	636000	3540	DFT-s-OFDM 16 QAM	50@25	25.15	28.15	0.6531
77	15	20	636000	3540	DFT-s-OFDM 16 QAM	1@1	25.27	28.27	0.6714
77	15	20	636000	3540	DFT-s-OFDM 16 QAM	1@104	25.3	28.3	0.6761
77	15	20	636000	3540	DFT-s-OFDM 64 QAM	50@25	23.63	26.63	0.4603
77	15	20	636000	3540	DFT-s-OFDM 64 QAM	1@1	23.29	26.29	0.4256
77	15	20	636000	3540	DFT-s-OFDM 64 QAM	1@104	23.31	26.31	0.4276
77	15	20	636000	3540	DFT-s-OFDM 256 QAM	50@25	21.51	24.51	0.2825
77	15	20	636000	3540	DFT-s-OFDM 256 QAM	1@1	21.06	24.06	0.2547
77	15	20	636000	3540	DFT-s-OFDM 256 QAM	1@104	21.12	24.12	0.2582
77	15	20	636000	3540	CP-OFDM QPSK	53@26	24.63	27.63	0.5794
77	15	20	636000	3540	CP-OFDM QPSK	1@1	24.43	27.43	0.5534
77	15	20	636000	3540	CP-OFDM QPSK	1@104	24.42	27.42	0.5521

NR Band	SCS (kHz)	Bandwidth (MHz)	Arfcn	Freq (MHz)	Modulation	RB	Conducted Power(dBm)	EIRP (dBm)	EIRP (W)
77	30	10	630334	3455.01	DFT-s-OFDM PI/2 BPSK	12@6	25.63	28.63	0.7295
77	30	10	630334	3455.01	DFT-s-OFDM PI/2 BPSK	1@1	25.5	28.5	0.7079
77	30	10	630334	3455.01	DFT-s-OFDM PI/2 BPSK	1@22	25.49	28.49	0.7063
77	30	10	630334	3455.01	DFT-s-OFDM QPSK	12@6	25.62	28.62	0.7278
77	30	10	630334	3455.01	DFT-s-OFDM QPSK	1@1	25.61	28.61	0.7261
77	30	10	630334	3455.01	DFT-s-OFDM QPSK	1@22	25.6	28.6	0.7244
77	30	10	630334	3455.01	DFT-s-OFDM 16 QAM	12@6	24.65	27.65	0.5821
77	30	10	630334	3455.01	DFT-s-OFDM 16 QAM	1@1	24.42	27.42	0.5521
77	30	10	630334	3455.01	DFT-s-OFDM 16 QAM	1@22	24.4	27.4	0.5495
77	30	10	630334	3455.01	DFT-s-OFDM 64 QAM	12@6	23.06	26.06	0.4036
77	30	10	630334	3455.01	DFT-s-OFDM 64 QAM	1@1	23.03	26.03	0.4009
77	30	10	630334	3455.01	DFT-s-OFDM 64 QAM	1@22	23.01	26.01	0.3990
77	30	10	630334	3455.01	DFT-s-OFDM 256 QAM	12@6	21.15	24.15	0.2600
77	30	10	630334	3455.01	DFT-s-OFDM 256 QAM	1@1	21.01	24.01	0.2518
77	30	10	630334	3455.01	DFT-s-OFDM 256 QAM	1@22	20.96	23.96	0.2489
77	30	10	630334	3455.01	CP-OFDM QPSK	12@6	24.08	27.08	0.5105
77	30	10	630334	3455.01	CP-OFDM QPSK	1@1	24.14	27.14	0.5176
77	30	10	630334	3455.01	CP-OFDM QPSK	1@22	24.1	27.1	0.5129
77	30	10	633334	3500.01	DFT-s-OFDM PI/2 BPSK	12@6	25.71	28.71	0.7430
77	30	10	633334	3500.01	DFT-s-OFDM PI/2 BPSK	1@1	25.57	28.57	0.7194
77	30	10	633334	3500.01	DFT-s-OFDM PI/2 BPSK	1@22	25.6	28.6	0.7244
77	30	10	633334	3500.01	DFT-s-OFDM QPSK	12@6	25.73	28.73	0.7464
77	30	10	633334	3500.01	DFT-s-OFDM QPSK	1@1	25.64	28.64	0.7311
77	30	10	633334	3500.01	DFT-s-OFDM QPSK	1@22	25.65	28.65	0.7328
77	30	10	633334	3500.01	DFT-s-OFDM 16 QAM	12@6	24.74	27.74	0.5943
77	30	10	633334	3500.01	DFT-s-OFDM 16 QAM	1@1	24.55	27.55	0.5689
77	30	10	633334	3500.01	DFT-s-OFDM 16 QAM	1@22	24.57	27.57	0.5715
77	30	10	633334	3500.01	DFT-s-OFDM 64 QAM	12@6	23.16	26.16	0.4130
77	30	10	633334	3500.01	DFT-s-OFDM 64 QAM	1@1	23.12	26.12	0.4093
77	30	10	633334	3500.01	DFT-s-OFDM 64 QAM	1@22	23.14	26.14	0.4111
77	30	10	633334	3500.01	DFT-s-OFDM 256 QAM	12@6	21.23	24.23	0.2649
77	30	10	633334	3500.01	DFT-s-OFDM 256 QAM	1@1	21.03	24.03	0.2529
77	30	10	633334	3500.01	DFT-s-OFDM 256 QAM	1@22	21.06	24.06	0.2547
77	30	10	633334	3500.01	CP-OFDM QPSK	12@6	24.2	27.2	0.5248

77	30	10	633334	3500.01	CP-OFDM QPSK	1@1	24.2	27.2	0.5248
77	30	10	633334	3500.01	CP-OFDM QPSK	1@22	24.2	27.2	0.5248
77	30	10	636332	3544.98	DFT-s-OFDM PI/2 BPSK	12@6	25.87	28.87	0.7709
77	30	10	636332	3544.98	DFT-s-OFDM PI/2 BPSK	1@1	25.78	28.78	0.7551
77	30	10	636332	3544.98	DFT-s-OFDM PI/2 BPSK	1@22	25.77	28.77	0.7534
77	30	10	636332	3544.98	DFT-s-OFDM QPSK	12@6	25.88	28.88	0.7727
77	30	10	636332	3544.98	DFT-s-OFDM QPSK	1@1	25.86	28.86	0.7691
77	30	10	636332	3544.98	DFT-s-OFDM QPSK	1@22	25.86	28.86	0.7691
77	30	10	636332	3544.98	DFT-s-OFDM 16 QAM	12@6	24.87	27.87	0.6124
77	30	10	636332	3544.98	DFT-s-OFDM 16 QAM	1@1	24.76	27.76	0.5970
77	30	10	636332	3544.98	DFT-s-OFDM 16 QAM	1@22	24.65	27.65	0.5821
77	30	10	636332	3544.98	DFT-s-OFDM 64 QAM	12@6	23.31	26.31	0.4276
77	30	10	636332	3544.98	DFT-s-OFDM 64 QAM	1@1	23.31	26.31	0.4276
77	30	10	636332	3544.98	DFT-s-OFDM 64 QAM	1@22	23.3	26.3	0.4266
77	30	10	636332	3544.98	DFT-s-OFDM 256 QAM	12@6	21.41	24.41	0.2761
77	30	10	636332	3544.98	DFT-s-OFDM 256 QAM	1@1	21.29	24.29	0.2685
77	30	10	636332	3544.98	DFT-s-OFDM 256 QAM	1@22	21.29	24.29	0.2685
77	30	10	636332	3544.98	CP-OFDM QPSK	12@6	24.38	27.38	0.5470
77	30	10	636332	3544.98	CP-OFDM QPSK	1@1	24.39	27.39	0.5483
77	30	10	636332	3544.98	CP-OFDM QPSK	1@22	24.41	27.41	0.5508
77	30	15	630500	3457.5	DFT-s-OFDM PI/2 BPSK	18@9	25.62	28.62	0.7278
77	30	15	630500	3457.5	DFT-s-OFDM PI/2 BPSK	1@1	25.54	28.54	0.7145
77	30	15	630500	3457.5	DFT-s-OFDM PI/2 BPSK	1@36	25.52	28.52	0.7112
77	30	15	630500	3457.5	DFT-s-OFDM QPSK	18@9	25.64	28.64	0.7311
77	30	15	630500	3457.5	DFT-s-OFDM QPSK	1@1	25.62	28.62	0.7278
77	30	15	630500	3457.5	DFT-s-OFDM QPSK	1@36	25.61	28.61	0.7261
77	30	15	630500	3457.5	DFT-s-OFDM 16 QAM	18@9	24.67	27.67	0.5848
77	30	15	630500	3457.5	DFT-s-OFDM 16 QAM	1@1	24.43	27.43	0.5534
77	30	15	630500	3457.5	DFT-s-OFDM 16 QAM	1@36	24.5	27.5	0.5623
77	30	15	630500	3457.5	DFT-s-OFDM 64 QAM	18@9	23.18	26.18	0.4150
77	30	15	630500	3457.5	DFT-s-OFDM 64 QAM	1@1	23.04	26.04	0.4018
77	30	15	630500	3457.5	DFT-s-OFDM 64 QAM	1@36	23.07	26.07	0.4046
77	30	15	630500	3457.5	DFT-s-OFDM 256 QAM	18@9	21.11	24.11	0.2576
77	30	15	630500	3457.5	DFT-s-OFDM 256 QAM	1@1	21.01	24.01	0.2518
77	30	15	630500	3457.5	DFT-s-OFDM 256 QAM	1@36	21.01	24.01	0.2518
77	30	15	630500	3457.5	CP-OFDM QPSK	19@9	24.19	27.19	0.5236

77	30	15	630500	3457.5	CP-OFDM QPSK	1@1	24.2	27.2	0.5248
77	30	15	630500	3457.5	CP-OFDM QPSK	1@36	24.21	27.21	0.5260
77	30	15	633334	3500.01	DFT-s-OFDM PI/2 BPSK	18@9	25.69	28.69	0.7396
77	30	15	633334	3500.01	DFT-s-OFDM PI/2 BPSK	1@1	25.51	28.51	0.7096
77	30	15	633334	3500.01	DFT-s-OFDM PI/2 BPSK	1@36	25.54	28.54	0.7145
77	30	15	633334	3500.01	DFT-s-OFDM QPSK	18@9	25.72	28.72	0.7447
77	30	15	633334	3500.01	DFT-s-OFDM QPSK	1@1	25.59	28.59	0.7228
77	30	15	633334	3500.01	DFT-s-OFDM QPSK	1@36	25.67	28.67	0.7362
77	30	15	633334	3500.01	DFT-s-OFDM 16 QAM	18@9	24.76	27.76	0.5970
77	30	15	633334	3500.01	DFT-s-OFDM 16 QAM	1@1	24.46	27.46	0.5572
77	30	15	633334	3500.01	DFT-s-OFDM 16 QAM	1@36	24.48	27.48	0.5598
77	30	15	633334	3500.01	DFT-s-OFDM 64 QAM	18@9	23.28	26.28	0.4246
77	30	15	633334	3500.01	DFT-s-OFDM 64 QAM	1@1	23.09	26.09	0.4064
77	30	15	633334	3500.01	DFT-s-OFDM 64 QAM	1@36	23.11	26.11	0.4083
77	30	15	633334	3500.01	DFT-s-OFDM 256 QAM	18@9	21.21	24.21	0.2636
77	30	15	633334	3500.01	DFT-s-OFDM 256 QAM	1@1	21.05	24.05	0.2541
77	30	15	633334	3500.01	DFT-s-OFDM 256 QAM	1@36	21.08	24.08	0.2559
77	30	15	633334	3500.01	CP-OFDM QPSK	19@9	24.24	27.24	0.5297
77	30	15	633334	3500.01	CP-OFDM QPSK	1@1	24.23	27.23	0.5284
77	30	15	633334	3500.01	CP-OFDM QPSK	1@36	24.23	27.23	0.5284
77	30	15	636166	3542.49	DFT-s-OFDM PI/2 BPSK	18@9	25.86	28.86	0.7691
77	30	15	636166	3542.49	DFT-s-OFDM PI/2 BPSK	1@1	25.76	28.76	0.7516
77	30	15	636166	3542.49	DFT-s-OFDM PI/2 BPSK	1@36	25.75	28.75	0.7499
77	30	15	636166	3542.49	DFT-s-OFDM QPSK	18@9	25.88	28.88	0.7727
77	30	15	636166	3542.49	DFT-s-OFDM QPSK	1@1	25.87	28.87	0.7709
77	30	15	636166	3542.49	DFT-s-OFDM QPSK	1@36	25.84	28.84	0.7656
77	30	15	636166	3542.49	DFT-s-OFDM 16 QAM	18@9	24.91	27.91	0.6180
77	30	15	636166	3542.49	DFT-s-OFDM 16 QAM	1@1	24.7	27.7	0.5888
77	30	15	636166	3542.49	DFT-s-OFDM 16 QAM	1@36	24.67	27.67	0.5848
77	30	15	636166	3542.49	DFT-s-OFDM 64 QAM	18@9	23.42	26.42	0.4385
77	30	15	636166	3542.49	DFT-s-OFDM 64 QAM	1@1	23.31	26.31	0.4276
77	30	15	636166	3542.49	DFT-s-OFDM 64 QAM	1@36	23.28	26.28	0.4246
77	30	15	636166	3542.49	DFT-s-OFDM 256 QAM	18@9	21.37	24.37	0.2735
77	30	15	636166	3542.49	DFT-s-OFDM 256 QAM	1@1	21.28	24.28	0.2679
77	30	15	636166	3542.49	DFT-s-OFDM 256 QAM	1@36	21.29	24.29	0.2685
77	30	15	636166	3542.49	CP-OFDM QPSK	19@9	24.4	27.4	0.5495

77	30	15	636166	3542.49	CP-OFDM QPSK	1@1	24.36	27.36	0.5445
77	30	15	636166	3542.49	CP-OFDM QPSK	1@36	24.3	27.3	0.5370
77	30	20	630668	3460.02	DFT-s-OFDM PI/2 BPSK	25@12	25.66	28.66	0.7345
77	30	20	630668	3460.02	DFT-s-OFDM PI/2 BPSK	1@1	25.47	28.47	0.7031
77	30	20	630668	3460.02	DFT-s-OFDM PI/2 BPSK	1@49	25.47	28.47	0.7031
77	30	20	630668	3460.02	DFT-s-OFDM QPSK	25@12	25.68	28.68	0.7379
77	30	20	630668	3460.02	DFT-s-OFDM QPSK	1@1	25.5	28.5	0.7079
77	30	20	630668	3460.02	DFT-s-OFDM QPSK	1@49	25.49	28.49	0.7063
77	30	20	630668	3460.02	DFT-s-OFDM 16 QAM	25@12	24.67	27.67	0.5848
77	30	20	630668	3460.02	DFT-s-OFDM 16 QAM	1@1	24.55	27.55	0.5689
77	30	20	630668	3460.02	DFT-s-OFDM 16 QAM	1@49	24.42	27.42	0.5521
77	30	20	630668	3460.02	DFT-s-OFDM 64 QAM	25@12	23.16	26.16	0.4130
77	30	20	630668	3460.02	DFT-s-OFDM 64 QAM	1@1	23.12	26.12	0.4093
77	30	20	630668	3460.02	DFT-s-OFDM 64 QAM	1@49	23.1	26.1	0.4074
77	30	20	630668	3460.02	DFT-s-OFDM 256 QAM	25@12	21.12	24.12	0.2582
77	30	20	630668	3460.02	DFT-s-OFDM 256 QAM	1@1	20.88	23.88	0.2443
77	30	20	630668	3460.02	DFT-s-OFDM 256 QAM	1@49	20.9	23.9	0.2455
77	30	20	630668	3460.02	CP-OFDM QPSK	25@12	24.17	27.17	0.5212
77	30	20	630668	3460.02	CP-OFDM QPSK	1@1	24.16	27.16	0.5200
77	30	20	630668	3460.02	CP-OFDM QPSK	1@49	24.19	27.19	0.5236
77	30	20	633334	3500.01	DFT-s-OFDM PI/2 BPSK	25@12	25.7	28.7	0.7413
77	30	20	633334	3500.01	DFT-s-OFDM PI/2 BPSK	1@1	25.49	28.49	0.7063
77	30	20	633334	3500.01	DFT-s-OFDM PI/2 BPSK	1@49	25.51	28.51	0.7096
77	30	20	633334	3500.01	DFT-s-OFDM QPSK	25@12	25.72	28.72	0.7447
77	30	20	633334	3500.01	DFT-s-OFDM QPSK	1@1	25.55	28.55	0.7161
77	30	20	633334	3500.01	DFT-s-OFDM QPSK	1@49	25.58	28.58	0.7211
77	30	20	633334	3500.01	DFT-s-OFDM 16 QAM	25@12	24.68	27.68	0.5861
77	30	20	633334	3500.01	DFT-s-OFDM 16 QAM	1@1	24.48	27.48	0.5598
77	30	20	633334	3500.01	DFT-s-OFDM 16 QAM	1@49	24.4	27.4	0.5495
77	30	20	633334	3500.01	DFT-s-OFDM 64 QAM	25@12	23.24	26.24	0.4207
77	30	20	633334	3500.01	DFT-s-OFDM 64 QAM	1@1	22.99	25.99	0.3972
77	30	20	633334	3500.01	DFT-s-OFDM 64 QAM	1@49	23.04	26.04	0.4018
77	30	20	633334	3500.01	DFT-s-OFDM 256 QAM	25@12	21.15	24.15	0.2600
77	30	20	633334	3500.01	DFT-s-OFDM 256 QAM	1@1	20.98	23.98	0.2500
77	30	20	633334	3500.01	DFT-s-OFDM 256 QAM	1@49	21.01	24.01	0.2518
77	30	20	633334	3500.01	CP-OFDM QPSK	25@12	24.19	27.19	0.5236

77	30	20	633334	3500.01	CP-OFDM QPSK	1@1	24.19	27.19	0.5236
77	30	20	633334	3500.01	CP-OFDM QPSK	1@49	24.23	27.23	0.5284
77	30	20	636000	3540	DFT-s-OFDM PI/2 BPSK	25@12	25.85	28.85	0.7674
77	30	20	636000	3540	DFT-s-OFDM PI/2 BPSK	1@1	25.69	28.69	0.7396
77	30	20	636000	3540	DFT-s-OFDM PI/2 BPSK	1@49	25.68	28.68	0.7379
77	30	20	636000	3540	DFT-s-OFDM QPSK	25@12	25.89	28.89	0.7745
77	30	20	636000	3540	DFT-s-OFDM QPSK	1@1	25.74	28.74	0.7482
77	30	20	636000	3540	DFT-s-OFDM QPSK	1@49	25.73	28.73	0.7464
77	30	20	636000	3540	DFT-s-OFDM 16 QAM	25@12	24.85	27.85	0.6095
77	30	20	636000	3540	DFT-s-OFDM 16 QAM	1@1	24.69	27.69	0.5875
77	30	20	636000	3540	DFT-s-OFDM 16 QAM	1@49	24.54	27.54	0.5675
77	30	20	636000	3540	DFT-s-OFDM 64 QAM	25@12	23.39	26.39	0.4355
77	30	20	636000	3540	DFT-s-OFDM 64 QAM	1@1	23.23	26.23	0.4198
77	30	20	636000	3540	DFT-s-OFDM 64 QAM	1@49	23.18	26.18	0.4150
77	30	20	636000	3540	DFT-s-OFDM 256 QAM	25@12	21.34	24.34	0.2716
77	30	20	636000	3540	DFT-s-OFDM 256 QAM	1@1	21.18	24.18	0.2618
77	30	20	636000	3540	DFT-s-OFDM 256 QAM	1@49	21.21	24.21	0.2636
77	30	20	636000	3540	CP-OFDM QPSK	25@12	24.35	27.35	0.5433
77	30	20	636000	3540	CP-OFDM QPSK	1@1	24.39	27.39	0.5483
77	30	20	636000	3540	CP-OFDM QPSK	1@49	24.38	27.38	0.5470
77	30	40	631334	3470.01	DFT-s-OFDM PI/2 BPSK	50@25	25.51	28.51	0.7096
77	30	40	631334	3470.01	DFT-s-OFDM PI/2 BPSK	1@1	25.07	28.07	0.6412
77	30	40	631334	3470.01	DFT-s-OFDM PI/2 BPSK	1@104	25.08	28.08	0.6427
77	30	40	631334	3470.01	DFT-s-OFDM QPSK	50@25	25.55	28.55	0.7161
77	30	40	631334	3470.01	DFT-s-OFDM QPSK	1@1	25.12	28.12	0.6486
77	30	40	631334	3470.01	DFT-s-OFDM QPSK	1@104	25.13	28.13	0.6501
77	30	40	631334	3470.01	DFT-s-OFDM 16 QAM	50@25	24.54	27.54	0.5675
77	30	40	631334	3470.01	DFT-s-OFDM 16 QAM	1@1	23.94	26.94	0.4943
77	30	40	631334	3470.01	DFT-s-OFDM 16 QAM	1@104	24.08	27.08	0.5105
77	30	40	631334	3470.01	DFT-s-OFDM 64 QAM	50@25	23.03	26.03	0.4009
77	30	40	631334	3470.01	DFT-s-OFDM 64 QAM	1@1	22.6	25.6	0.3631
77	30	40	631334	3470.01	DFT-s-OFDM 64 QAM	1@104	22.63	25.63	0.3656
77	30	40	631334	3470.01	DFT-s-OFDM 256 QAM	50@25	21.03	24.03	0.2529
77	30	40	631334	3470.01	DFT-s-OFDM 256 QAM	1@1	20.55	23.55	0.2265
77	30	40	631334	3470.01	DFT-s-OFDM 256 QAM	1@104	20.56	23.56	0.2270
77	30	40	631334	3470.01	CP-OFDM QPSK	53@26	24.03	27.03	0.5047

77	30	40	631334	3470.01	CP-OFDM QPSK	1@1	23.74	26.74	0.4721
77	30	40	631334	3470.01	CP-OFDM QPSK	1@104	23.76	26.76	0.4742
77	30	40	633334	3500.01	DFT-s-OFDM PI/2 BPSK	50@25	25.63	28.63	0.7295
77	30	40	633334	3500.01	DFT-s-OFDM PI/2 BPSK	1@1	25.11	28.11	0.6471
77	30	40	633334	3500.01	DFT-s-OFDM PI/2 BPSK	1@104	25.23	28.23	0.6653
77	30	40	633334	3500.01	DFT-s-OFDM QPSK	50@25	25.63	28.63	0.7295
77	30	40	633334	3500.01	DFT-s-OFDM QPSK	1@1	25.16	28.16	0.6546
77	30	40	633334	3500.01	DFT-s-OFDM QPSK	1@104	25.31	28.31	0.6776
77	30	40	633334	3500.01	DFT-s-OFDM 16 QAM	50@25	24.66	27.66	0.5834
77	30	40	633334	3500.01	DFT-s-OFDM 16 QAM	1@1	23.97	26.97	0.4977
77	30	40	633334	3500.01	DFT-s-OFDM 16 QAM	1@104	24.24	27.24	0.5297
77	30	40	633334	3500.01	DFT-s-OFDM 64 QAM	50@25	23.12	26.12	0.4093
77	30	40	633334	3500.01	DFT-s-OFDM 64 QAM	1@1	22.62	25.62	0.3648
77	30	40	633334	3500.01	DFT-s-OFDM 64 QAM	1@104	22.76	25.76	0.3767
77	30	40	633334	3500.01	DFT-s-OFDM 256 QAM	50@25	21.12	24.12	0.2582
77	30	40	633334	3500.01	DFT-s-OFDM 256 QAM	1@1	20.59	23.59	0.2286
77	30	40	633334	3500.01	DFT-s-OFDM 256 QAM	1@104	20.72	23.72	0.2355
77	30	40	633334	3500.01	CP-OFDM QPSK	53@26	24.13	27.13	0.5164
77	30	40	633334	3500.01	CP-OFDM QPSK	1@1	23.8	26.8	0.4786
77	30	40	633334	3500.01	CP-OFDM QPSK	1@104	23.89	26.89	0.4887
77	30	40	635332	3529.98	DFT-s-OFDM PI/2 BPSK	50@25	25.76	28.76	0.7516
77	30	40	635332	3529.98	DFT-s-OFDM PI/2 BPSK	1@1	25.24	28.24	0.6668
77	30	40	635332	3529.98	DFT-s-OFDM PI/2 BPSK	1@104	25.33	28.33	0.6808
77	30	40	635332	3529.98	DFT-s-OFDM QPSK	50@25	25.78	28.78	0.7551
77	30	40	635332	3529.98	DFT-s-OFDM QPSK	1@1	25.28	28.28	0.6730
77	30	40	635332	3529.98	DFT-s-OFDM QPSK	1@104	25.38	28.38	0.6887
77	30	40	635332	3529.98	DFT-s-OFDM 16 QAM	50@25	24.82	27.82	0.6053
77	30	40	635332	3529.98	DFT-s-OFDM 16 QAM	1@1	24.24	27.24	0.5297
77	30	40	635332	3529.98	DFT-s-OFDM 16 QAM	1@104	24.31	27.31	0.5383
77	30	40	635332	3529.98	DFT-s-OFDM 64 QAM	50@25	23.28	26.28	0.4246
77	30	40	635332	3529.98	DFT-s-OFDM 64 QAM	1@1	22.78	25.78	0.3784
77	30	40	635332	3529.98	DFT-s-OFDM 64 QAM	1@104	22.84	25.84	0.3837
77	30	40	635332	3529.98	DFT-s-OFDM 256 QAM	50@25	21.28	24.28	0.2679
77	30	40	635332	3529.98	DFT-s-OFDM 256 QAM	1@1	20.73	23.73	0.2360
77	30	40	635332	3529.98	DFT-s-OFDM 256 QAM	1@104	20.8	23.8	0.2399
77	30	40	635332	3529.98	CP-OFDM QPSK	53@26	24.26	27.26	0.5321

77	30	40	635332	3529.98	CP-OFDM QPSK	1@1	23.91	26.91	0.4909
77	30	40	635332	3529.98	CP-OFDM QPSK	1@104	24.01	27.01	0.5023
77	30	50	631668	3475.02	DFT-s-OFDM PI/2 BPSK	64@32	25.55	28.55	0.7161
77	30	50	631668	3475.02	DFT-s-OFDM PI/2 BPSK	1@1	25.34	28.34	0.6823
77	30	50	631668	3475.02	DFT-s-OFDM PI/2 BPSK	1@131	25.37	28.37	0.6871
77	30	50	631668	3475.02	DFT-s-OFDM QPSK	64@32	25.57	28.57	0.7194
77	30	50	631668	3475.02	DFT-s-OFDM QPSK	1@1	25.44	28.44	0.6982
77	30	50	631668	3475.02	DFT-s-OFDM QPSK	1@131	25.43	28.43	0.6966
77	30	50	631668	3475.02	DFT-s-OFDM 16 QAM	64@32	24.57	27.57	0.5715
77	30	50	631668	3475.02	DFT-s-OFDM 16 QAM	1@1	24.27	27.27	0.5333
77	30	50	631668	3475.02	DFT-s-OFDM 16 QAM	1@131	24.24	27.24	0.5297
77	30	50	631668	3475.02	DFT-s-OFDM 64 QAM	64@32	23.06	26.06	0.4036
77	30	50	631668	3475.02	DFT-s-OFDM 64 QAM	1@1	22.94	25.94	0.3926
77	30	50	631668	3475.02	DFT-s-OFDM 64 QAM	1@131	23.02	26.02	0.3999
77	30	50	631668	3475.02	DFT-s-OFDM 256 QAM	64@32	21.07	24.07	0.2553
77	30	50	631668	3475.02	DFT-s-OFDM 256 QAM	1@1	20.77	23.77	0.2382
77	30	50	631668	3475.02	DFT-s-OFDM 256 QAM	1@131	20.78	23.78	0.2388
77	30	50	631668	3475.02	CP-OFDM QPSK	67@33	24.06	27.06	0.5082
77	30	50	631668	3475.02	CP-OFDM QPSK	1@1	23.97	26.97	0.4977
77	30	50	631668	3475.02	CP-OFDM QPSK	1@131	23.97	26.97	0.4977
77	30	50	633334	3500.01	DFT-s-OFDM PI/2 BPSK	64@32	25.66	28.66	0.7345
77	30	50	633334	3500.01	DFT-s-OFDM PI/2 BPSK	1@1	25.37	28.37	0.6871
77	30	50	633334	3500.01	DFT-s-OFDM PI/2 BPSK	1@131	25.5	28.5	0.7079
77	30	50	633334	3500.01	DFT-s-OFDM QPSK	64@32	25.65	28.65	0.7328
77	30	50	633334	3500.01	DFT-s-OFDM QPSK	1@1	25.4	28.4	0.6918
77	30	50	633334	3500.01	DFT-s-OFDM QPSK	1@131	25.6	28.6	0.7244
77	30	50	633334	3500.01	DFT-s-OFDM 16 QAM	64@32	24.69	27.69	0.5875
77	30	50	633334	3500.01	DFT-s-OFDM 16 QAM	1@1	24.29	27.29	0.5358
77	30	50	633334	3500.01	DFT-s-OFDM 16 QAM	1@131	24.39	27.39	0.5483
77	30	50	633334	3500.01	DFT-s-OFDM 64 QAM	64@32	23.16	26.16	0.4130
77	30	50	633334	3500.01	DFT-s-OFDM 64 QAM	1@1	22.92	25.92	0.3908
77	30	50	633334	3500.01	DFT-s-OFDM 64 QAM	1@131	23.03	26.03	0.4009
77	30	50	633334	3500.01	DFT-s-OFDM 256 QAM	64@32	21.17	24.17	0.2612
77	30	50	633334	3500.01	DFT-s-OFDM 256 QAM	1@1	20.93	23.93	0.2472
77	30	50	633334	3500.01	DFT-s-OFDM 256 QAM	1@131	21.02	24.02	0.2523
77	30	50	633334	3500.01	CP-OFDM QPSK	67@33	24.18	27.18	0.5224

77	30	50	633334	3500.01	CP-OFDM QPSK	1@1	24.1	27.1	0.5129
77	30	50	633334	3500.01	CP-OFDM QPSK	1@131	24.14	27.14	0.5176
77	30	50	635000	3525	DFT-s-OFDM PI/2 BPSK	64@32	25.81	28.81	0.7603
77	30	50	635000	3525	DFT-s-OFDM PI/2 BPSK	1@1	25.51	28.51	0.7096
77	30	50	635000	3525	DFT-s-OFDM PI/2 BPSK	1@131	25.56	28.56	0.7178
77	30	50	635000	3525	DFT-s-OFDM QPSK	64@32	25.8	28.8	0.7586
77	30	50	635000	3525	DFT-s-OFDM QPSK	1@1	25.58	28.58	0.7211
77	30	50	635000	3525	DFT-s-OFDM QPSK	1@131	25.61	28.61	0.7261
77	30	50	635000	3525	DFT-s-OFDM 16 QAM	64@32	24.82	27.82	0.6053
77	30	50	635000	3525	DFT-s-OFDM 16 QAM	1@1	24.49	27.49	0.5610
77	30	50	635000	3525	DFT-s-OFDM 16 QAM	1@131	24.55	27.55	0.5689
77	30	50	635000	3525	DFT-s-OFDM 64 QAM	64@32	23.29	26.29	0.4256
77	30	50	635000	3525	DFT-s-OFDM 64 QAM	1@1	23.05	26.05	0.4027
77	30	50	635000	3525	DFT-s-OFDM 64 QAM	1@131	23.11	26.11	0.4083
77	30	50	635000	3525	DFT-s-OFDM 256 QAM	64@32	21.3	24.3	0.2692
77	30	50	635000	3525	DFT-s-OFDM 256 QAM	1@1	21.03	24.03	0.2529
77	30	50	635000	3525	DFT-s-OFDM 256 QAM	1@131	21.09	24.09	0.2564
77	30	50	635000	3525	CP-OFDM QPSK	67@33	24.29	27.29	0.5358
77	30	50	635000	3525	CP-OFDM QPSK	1@1	24.21	27.21	0.5260
77	30	50	635000	3525	CP-OFDM QPSK	1@131	24.28	27.28	0.5346
77	30	60	632000	3480	DFT-s-OFDM PI/2 BPSK	81@40	25.6	28.6	0.7244
77	30	60	632000	3480	DFT-s-OFDM PI/2 BPSK	1@1	25.36	28.36	0.6855
77	30	60	632000	3480	DFT-s-OFDM PI/2 BPSK	1@160	25.48	28.48	0.7047
77	30	60	632000	3480	DFT-s-OFDM QPSK	81@40	25.61	28.61	0.7261
77	30	60	632000	3480	DFT-s-OFDM QPSK	1@1	25.47	28.47	0.7031
77	30	60	632000	3480	DFT-s-OFDM QPSK	1@160	25.55	28.55	0.7161
77	30	60	632000	3480	DFT-s-OFDM 16 QAM	81@40	24.63	27.63	0.5794
77	30	60	632000	3480	DFT-s-OFDM 16 QAM	1@1	24.31	27.31	0.5383
77	30	60	632000	3480	DFT-s-OFDM 16 QAM	1@160	24.55	27.55	0.5689
77	30	60	632000	3480	DFT-s-OFDM 64 QAM	81@40	23.1	26.1	0.4074
77	30	60	632000	3480	DFT-s-OFDM 64 QAM	1@1	22.97	25.97	0.3954
77	30	60	632000	3480	DFT-s-OFDM 64 QAM	1@160	23.11	26.11	0.4083
77	30	60	632000	3480	DFT-s-OFDM 256 QAM	81@40	21.08	24.08	0.2559
77	30	60	632000	3480	DFT-s-OFDM 256 QAM	1@1	20.91	23.91	0.2460
77	30	60	632000	3480	DFT-s-OFDM 256 QAM	1@160	21.03	24.03	0.2529
77	30	60	632000	3480	CP-OFDM QPSK	81@40	24.11	27.11	0.5140

77	30	60	632000	3480	CP-OFDM QPSK	1@1	24.01	27.01	0.5023
77	30	60	632000	3480	CP-OFDM QPSK	1@160	24.11	27.11	0.5140
77	30	60	633334	3500.01	DFT-s-OFDM PI/2 BPSK	81@40	25.66	28.66	0.7345
77	30	60	633334	3500.01	DFT-s-OFDM PI/2 BPSK	1@1	25.41	28.41	0.6934
77	30	60	633334	3500.01	DFT-s-OFDM PI/2 BPSK	1@160	25.57	28.57	0.7194
77	30	60	633334	3500.01	DFT-s-OFDM QPSK	81@40	25.67	28.67	0.7362
77	30	60	633334	3500.01	DFT-s-OFDM QPSK	1@1	25.53	28.53	0.7129
77	30	60	633334	3500.01	DFT-s-OFDM QPSK	1@160	25.65	28.65	0.7328
77	30	60	633334	3500.01	DFT-s-OFDM 16 QAM	81@40	24.66	27.66	0.5834
77	30	60	633334	3500.01	DFT-s-OFDM 16 QAM	1@1	24.36	27.36	0.5445
77	30	60	633334	3500.01	DFT-s-OFDM 16 QAM	1@160	24.62	27.62	0.5781
77	30	60	633334	3500.01	DFT-s-OFDM 64 QAM	81@40	23.15	26.15	0.4121
77	30	60	633334	3500.01	DFT-s-OFDM 64 QAM	1@1	22.88	25.88	0.3873
77	30	60	633334	3500.01	DFT-s-OFDM 64 QAM	1@160	23.19	26.19	0.4159
77	30	60	633334	3500.01	DFT-s-OFDM 256 QAM	81@40	21.16	24.16	0.2606
77	30	60	633334	3500.01	DFT-s-OFDM 256 QAM	1@1	20.85	23.85	0.2427
77	30	60	633334	3500.01	DFT-s-OFDM 256 QAM	1@160	21.09	24.09	0.2564
77	30	60	633334	3500.01	CP-OFDM QPSK	81@40	24.16	27.16	0.5200
77	30	60	633334	3500.01	CP-OFDM QPSK	1@1	24.05	27.05	0.5070
77	30	60	633334	3500.01	CP-OFDM QPSK	1@160	24.22	27.22	0.5272
77	30	60	634666	3519.99	DFT-s-OFDM PI/2 BPSK	81@40	25.78	28.78	0.7551
77	30	60	634666	3519.99	DFT-s-OFDM PI/2 BPSK	1@1	25.45	28.45	0.6998
77	30	60	634666	3519.99	DFT-s-OFDM PI/2 BPSK	1@160	25.6	28.6	0.7244
77	30	60	634666	3519.99	DFT-s-OFDM QPSK	81@40	25.77	28.77	0.7534
77	30	60	634666	3519.99	DFT-s-OFDM QPSK	1@1	25.55	28.55	0.7161
77	30	60	634666	3519.99	DFT-s-OFDM QPSK	1@160	25.68	28.68	0.7379
77	30	60	634666	3519.99	DFT-s-OFDM 16 QAM	81@40	24.82	27.82	0.6053
77	30	60	634666	3519.99	DFT-s-OFDM 16 QAM	1@1	24.39	27.39	0.5483
77	30	60	634666	3519.99	DFT-s-OFDM 16 QAM	1@160	24.68	27.68	0.5861
77	30	60	634666	3519.99	DFT-s-OFDM 64 QAM	81@40	23.27	26.27	0.4236
77	30	60	634666	3519.99	DFT-s-OFDM 64 QAM	1@1	23.08	26.08	0.4055
77	30	60	634666	3519.99	DFT-s-OFDM 64 QAM	1@160	23.18	26.18	0.4150
77	30	60	634666	3519.99	DFT-s-OFDM 256 QAM	81@40	21.26	24.26	0.2667
77	30	60	634666	3519.99	DFT-s-OFDM 256 QAM	1@1	20.83	23.83	0.2415
77	30	60	634666	3519.99	DFT-s-OFDM 256 QAM	1@160	21.09	24.09	0.2564
77	30	60	634666	3519.99	CP-OFDM QPSK	81@40	24.28	27.28	0.5346

77	30	60	634666	3519.99	CP-OFDM QPSK	1@1	24.1	27.1	0.5129
77	30	60	634666	3519.99	CP-OFDM QPSK	1@160	24.29	27.29	0.5358
77	30	80	632668	3490.02	DFT-s-OFDM PI/2 BPSK	108@54	25.5	28.5	0.7079
77	30	80	632668	3490.02	DFT-s-OFDM PI/2 BPSK	1@1	24.91	27.91	0.6180
77	30	80	632668	3490.02	DFT-s-OFDM PI/2 BPSK	1@215	25.03	28.03	0.6353
77	30	80	632668	3490.02	DFT-s-OFDM QPSK	108@54	25.5	28.5	0.7079
77	30	80	632668	3490.02	DFT-s-OFDM QPSK	1@1	25.05	28.05	0.6383
77	30	80	632668	3490.02	DFT-s-OFDM QPSK	1@215	25.21	28.21	0.6622
77	30	80	632668	3490.02	DFT-s-OFDM 16 QAM	108@54	24.49	27.49	0.5610
77	30	80	632668	3490.02	DFT-s-OFDM 16 QAM	1@1	23.95	26.95	0.4955
77	30	80	632668	3490.02	DFT-s-OFDM 16 QAM	1@215	23.98	26.98	0.4989
77	30	80	632668	3490.02	DFT-s-OFDM 64 QAM	108@54	22.98	25.98	0.3963
77	30	80	632668	3490.02	DFT-s-OFDM 64 QAM	1@1	22.36	25.36	0.3436
77	30	80	632668	3490.02	DFT-s-OFDM 64 QAM	1@215	22.49	25.49	0.3540
77	30	80	632668	3490.02	DFT-s-OFDM 256 QAM	108@54	21.08	24.08	0.2559
77	30	80	632668	3490.02	DFT-s-OFDM 256 QAM	1@1	20.66	23.66	0.2323
77	30	80	632668	3490.02	DFT-s-OFDM 256 QAM	1@215	20.78	23.78	0.2388
77	30	80	632668	3490.02	CP-OFDM QPSK	109@54	23.93	26.93	0.4932
77	30	80	632668	3490.02	CP-OFDM QPSK	1@1	23.48	26.48	0.4446
77	30	80	632668	3490.02	CP-OFDM QPSK	1@215	23.68	26.68	0.4656
77	30	80	633334	3500.01	DFT-s-OFDM PI/2 BPSK	108@54	25.54	28.54	0.7145
77	30	80	633334	3500.01	DFT-s-OFDM PI/2 BPSK	1@1	24.95	27.95	0.6237
77	30	80	633334	3500.01	DFT-s-OFDM PI/2 BPSK	1@215	25.07	28.07	0.6412
77	30	80	633334	3500.01	DFT-s-OFDM QPSK	108@54	25.55	28.55	0.7161
77	30	80	633334	3500.01	DFT-s-OFDM QPSK	1@1	25.08	28.08	0.6427
77	30	80	633334	3500.01	DFT-s-OFDM QPSK	1@215	25.21	28.21	0.6622
77	30	80	633334	3500.01	DFT-s-OFDM 16 QAM	108@54	24.54	27.54	0.5675
77	30	80	633334	3500.01	DFT-s-OFDM 16 QAM	1@1	23.89	26.89	0.4887
77	30	80	633334	3500.01	DFT-s-OFDM 16 QAM	1@215	23.99	26.99	0.5000
77	30	80	633334	3500.01	DFT-s-OFDM 64 QAM	108@54	23.05	26.05	0.4027
77	30	80	633334	3500.01	DFT-s-OFDM 64 QAM	1@1	22.36	25.36	0.3436
77	30	80	633334	3500.01	DFT-s-OFDM 64 QAM	1@215	22.52	25.52	0.3565
77	30	80	633334	3500.01	DFT-s-OFDM 256 QAM	108@54	21.14	24.14	0.2594
77	30	80	633334	3500.01	DFT-s-OFDM 256 QAM	1@1	20.7	23.7	0.2344
77	30	80	633334	3500.01	DFT-s-OFDM 256 QAM	1@215	20.84	23.84	0.2421
77	30	80	633334	3500.01	CP-OFDM QPSK	109@54	23.99	26.99	0.5000

77	30	80	633334	3500.01	CP-OFDM QPSK	1@1	23.59	26.59	0.4560
77	30	80	633334	3500.01	CP-OFDM QPSK	1@215	23.63	26.63	0.4603
77	30	80	634000	3510	DFT-s-OFDM PI/2 BPSK	108@54	25.58	28.58	0.7211
77	30	80	634000	3510	DFT-s-OFDM PI/2 BPSK	1@1	25	28	0.6310
77	30	80	634000	3510	DFT-s-OFDM PI/2 BPSK	1@215	25.06	28.06	0.6397
77	30	80	634000	3510	DFT-s-OFDM QPSK	108@54	25.62	28.62	0.7278
77	30	80	634000	3510	DFT-s-OFDM QPSK	1@1	25.12	28.12	0.6486
77	30	80	634000	3510	DFT-s-OFDM QPSK	1@215	25.22	28.22	0.6637
77	30	80	634000	3510	DFT-s-OFDM 16 QAM	108@54	24.59	27.59	0.5741
77	30	80	634000	3510	DFT-s-OFDM 16 QAM	1@1	24.03	27.03	0.5047
77	30	80	634000	3510	DFT-s-OFDM 16 QAM	1@215	24	27	0.5012
77	30	80	634000	3510	DFT-s-OFDM 64 QAM	108@54	23.08	26.08	0.4055
77	30	80	634000	3510	DFT-s-OFDM 64 QAM	1@1	22.45	25.45	0.3508
77	30	80	634000	3510	DFT-s-OFDM 64 QAM	1@215	22.5	25.5	0.3548
77	30	80	634000	3510	DFT-s-OFDM 256 QAM	108@54	21.22	24.22	0.2642
77	30	80	634000	3510	DFT-s-OFDM 256 QAM	1@1	20.74	23.74	0.2366
77	30	80	634000	3510	DFT-s-OFDM 256 QAM	1@215	20.85	23.85	0.2427
77	30	80	634000	3510	CP-OFDM QPSK	109@54	24.06	27.06	0.5082
77	30	80	634000	3510	CP-OFDM QPSK	1@1	23.56	26.56	0.4529
77	30	80	634000	3510	CP-OFDM QPSK	1@215	23.71	26.71	0.4688
77	30	100	633334	3500.01	DFT-s-OFDM PI/2 BPSK	135@67	25.5	28.5	0.7079
77	30	100	633334	3500.01	DFT-s-OFDM PI/2 BPSK	1@1	24.67	27.67	0.5848
77	30	100	633334	3500.01	DFT-s-OFDM PI/2 BPSK	1@271	24.79	27.79	0.6012
77	30	100	633334	3500.01	DFT-s-OFDM QPSK	135@67	25.5	28.5	0.7079
77	30	100	633334	3500.01	DFT-s-OFDM QPSK	1@1	24.79	27.79	0.6012
77	30	100	633334	3500.01	DFT-s-OFDM QPSK	1@271	24.92	27.92	0.6194
77	30	100	633334	3500.01	DFT-s-OFDM 16 QAM	135@67	24.5	27.5	0.5623
77	30	100	633334	3500.01	DFT-s-OFDM 16 QAM	1@1	23.76	26.76	0.4742
77	30	100	633334	3500.01	DFT-s-OFDM 16 QAM	1@271	23.89	26.89	0.4887
77	30	100	633334	3500.01	DFT-s-OFDM 64 QAM	135@67	22.99	25.99	0.3972
77	30	100	633334	3500.01	DFT-s-OFDM 64 QAM	1@1	22.32	25.32	0.3404
77	30	100	633334	3500.01	DFT-s-OFDM 64 QAM	1@271	22.46	25.46	0.3516
77	30	100	633334	3500.01	DFT-s-OFDM 256 QAM	135@67	21.13	24.13	0.2588
77	30	100	633334	3500.01	DFT-s-OFDM 256 QAM	1@1	20.46	23.46	0.2218
77	30	100	633334	3500.01	DFT-s-OFDM 256 QAM	1@271	20.61	23.61	0.2296
77	30	100	633334	3500.01	CP-OFDM QPSK	137@68	23.99	26.99	0.5000

77	30	100	633334	3500.01	CP-OFDM QPSK	1@1	23.28	26.28	0.4246
77	30	100	633334	3500.01	CP-OFDM QPSK	1@271	23.39	26.39	0.4355

FR1 N77_UL MIMO

Transmitter Conducted Output Power And EIRP, (G_T - L_C)=3dBi

NR Band	SCS (kHz)	Bandwidth (MHz)	Arfcn	Freq (MHz)	Modulation	RB	ANT1 Power(dBm)	ANT2 Power(dBm)	Conducted Power(dBm)	EIRP (dBm)	EIRP (W)
77	15	10	630334	3455.01	CP-OFDM QPSK	26@13	21.12	21.17	24.16	27.16	0.5194
77	15	10	630334	3455.01	CP-OFDM QPSK	1@1	21.16	21.24	24.21	27.21	0.5261
77	15	10	630334	3455.01	CP-OFDM QPSK	1@50	21.23	21.23	24.24	27.24	0.5297
77	15	10	630334	3455.01	CP-OFDM 16 QAM	26@13	20.65	20.68	23.68	26.68	0.4651
77	15	10	630334	3455.01	CP-OFDM 16 QAM	1@1	20.61	21.08	23.86	26.86	0.4855
77	15	10	630334	3455.01	CP-OFDM 16 QAM	1@50	20.68	21.07	23.89	26.89	0.4886
77	15	10	630334	3455.01	CP-OFDM 64 QAM	26@13	19.08	19.13	22.12	25.12	0.3247
77	15	10	630334	3455.01	CP-OFDM 64 QAM	1@1	19.23	19.15	22.20	25.20	0.3312
77	15	10	630334	3455.01	CP-OFDM 64 QAM	1@50	19.46	19.36	22.42	25.42	0.3484
77	15	10	630334	3455.01	CP-OFDM 256 QAM	26@13	15.96	16.09	19.04	22.04	0.1598
77	15	10	630334	3455.01	CP-OFDM 256 QAM	1@1	16.29	15.91	19.11	22.11	0.1627
77	15	10	630334	3455.01	CP-OFDM 256 QAM	1@50	16.31	16.05	19.19	22.19	0.1657
77	15	10	633334	3500.01	CP-OFDM QPSK	26@13	21.17	21.23	24.21	27.21	0.5261
77	15	10	633334	3500.01	CP-OFDM QPSK	1@1	21.24	21.21	24.24	27.24	0.5291
77	15	10	633334	3500.01	CP-OFDM QPSK	1@50	21.29	21.31	24.31	27.31	0.5383
77	15	10	633334	3500.01	CP-OFDM 16 QAM	26@13	20.72	20.75	23.75	26.75	0.4726
77	15	10	633334	3500.01	CP-OFDM 16 QAM	1@1	20.67	21.06	23.88	26.88	0.4875
77	15	10	633334	3500.01	CP-OFDM 16 QAM	1@50	20.8	21.14	23.98	26.98	0.4993
77	15	10	633334	3500.01	CP-OFDM 64 QAM	26@13	19.18	19.16	22.18	25.18	0.3296
77	15	10	633334	3500.01	CP-OFDM 64 QAM	1@1	19.16	19.19	22.19	25.19	0.3300
77	15	10	633334	3500.01	CP-OFDM 64 QAM	1@50	19.42	19.4	22.42	25.42	0.3484
77	15	10	633334	3500.01	CP-OFDM 256 QAM	26@13	16.38	16.12	19.26	22.26	0.1684
77	15	10	633334	3500.01	CP-OFDM 256 QAM	1@1	16.35	16.01	19.19	22.19	0.1657
77	15	10	633334	3500.01	CP-OFDM 256 QAM	1@50	16.41	15.86	19.15	22.15	0.1642
77	15	10	636333	3544.995	CP-OFDM QPSK	26@13	21.48	21.28	24.39	27.39	0.5485
77	15	10	636333	3544.995	CP-OFDM QPSK	1@1	21.54	21.39	24.48	27.48	0.5592
77	15	10	636333	3544.995	CP-OFDM QPSK	1@50	21.54	21.37	24.47	27.47	0.5580
77	15	10	636333	3544.995	CP-OFDM	26@13	21	20.85	23.94	26.94	0.4938

					16 QAM							
77	15	10	636333	3544.995	CP-OFDM 16 QAM	1@1	20.99	21.09	24.05	27.05	0.5071	
77	15	10	636333	3544.995	CP-OFDM 16 QAM	1@50	21.06	21.13	24.11	27.11	0.5135	
77	15	10	636333	3544.995	CP-OFDM 64 QAM	26@13	19.44	19.32	22.39	25.39	0.3460	
77	15	10	636333	3544.995	CP-OFDM 64 QAM	1@1	19.59	19.44	22.53	25.53	0.3569	
77	15	10	636333	3544.995	CP-OFDM 64 QAM	1@50	19.55	19.4	22.49	25.49	0.3537	
77	15	10	636333	3544.995	CP-OFDM 256 QAM	26@13	16.32	16.2	19.27	22.27	0.1687	
77	15	10	636333	3544.995	CP-OFDM 256 QAM	1@1	16.63	16.27	19.46	22.46	0.1764	
77	15	10	636333	3544.995	CP-OFDM 256 QAM	1@50	16.69	16.21	19.47	22.47	0.1765	
77	15	15	630500	3457.5	CP-OFDM QPSK	39@19	21.4	21.41	24.42	27.42	0.5515	
77	15	15	630500	3457.5	CP-OFDM QPSK	1@1	21.45	21.4	24.44	27.44	0.5540	
77	15	15	630500	3457.5	CP-OFDM QPSK	1@77	21.5	21.3	24.41	27.41	0.5510	
77	15	15	630500	3457.5	CP-OFDM 16 QAM	39@19	20.94	20.88	23.92	26.92	0.4921	
77	15	15	630500	3457.5	CP-OFDM 16 QAM	1@1	20.84	21.27	24.07	27.07	0.5094	
77	15	15	630500	3457.5	CP-OFDM 16 QAM	1@77	20.89	21.17	24.04	27.04	0.5061	
77	15	15	630500	3457.5	CP-OFDM 64 QAM	39@19	19.46	19.37	22.43	25.43	0.3488	
77	15	15	630500	3457.5	CP-OFDM 64 QAM	1@1	19.44	19.39	22.43	25.43	0.3488	
77	15	15	630500	3457.5	CP-OFDM 64 QAM	1@77	19.47	19.5	22.50	25.50	0.3544	
77	15	15	630500	3457.5	CP-OFDM 256 QAM	39@19	16.49	16.51	19.51	22.51	0.1783	
77	15	15	630500	3457.5	CP-OFDM 256 QAM	1@1	16.73	16.65	19.70	22.70	0.1862	
77	15	15	630500	3457.5	CP-OFDM 256 QAM	1@77	16.51	16.5	19.52	22.52	0.1785	
77	15	15	633334	3500.01	CP-OFDM QPSK	39@19	21.55	21.49	24.53	27.53	0.5663	
77	15	15	633334	3500.01	CP-OFDM QPSK	1@1	21.59	21.43	24.52	27.52	0.5651	
77	15	15	633334	3500.01	CP-OFDM QPSK	1@77	21.67	21.45	24.57	27.57	0.5717	
77	15	15	633334	3500.01	CP-OFDM 16 QAM	39@19	21.09	20.95	24.03	27.03	0.5048	
77	15	15	633334	3500.01	CP-OFDM 16 QAM	1@1	20.97	21.22	24.11	27.11	0.5137	
77	15	15	633334	3500.01	CP-OFDM 16 QAM	1@77	21.1	21.22	24.17	27.17	0.5213	
77	15	15	633334	3500.01	CP-OFDM 64 QAM	39@19	19.59	19.42	22.52	25.52	0.3561	
77	15	15	633334	3500.01	CP-OFDM 64 QAM	1@1	19.79	19.41	22.61	25.61	0.3643	
77	15	15	633334	3500.01	CP-OFDM 64 QAM	1@77	19.75	19.46	22.62	25.62	0.3646	
77	15	15	633334	3500.01	CP-OFDM 256 QAM	39@19	16.41	16.32	19.38	22.38	0.1728	
77	15	15	633334	3500.01	CP-OFDM 256 QAM	1@1	16.61	16.05	19.35	22.35	0.1718	
77	15	15	633334	3500.01	CP-OFDM 256 QAM	1@77	16.68	16.33	19.52	22.52	0.1786	
77	15	15	636166	3542.49	CP-OFDM QPSK	39@19	21.74	21.59	24.68	27.68	0.5856	

77	15	15	636166	3542.49	CP-OFDM QPSK	1@1	21.93	21.74	24.85	27.85	0.6090
77	15	15	636166	3542.49	CP-OFDM QPSK	1@77	21.82	21.5	24.67	27.67	0.5852
77	15	15	636166	3542.49	CP-OFDM 16 QAM	39@19	21.19	21.13	24.17	27.17	0.5212
77	15	15	636166	3542.49	CP-OFDM 16 QAM	1@1	21.24	21.45	24.36	27.36	0.5441
77	15	15	636166	3542.49	CP-OFDM 16 QAM	1@77	21.24	21.34	24.30	27.30	0.5371
77	15	15	636166	3542.49	CP-OFDM 64 QAM	39@19	19.77	19.54	22.67	25.67	0.3687
77	15	15	636166	3542.49	CP-OFDM 64 QAM	1@1	19.85	19.57	22.72	25.72	0.3735
77	15	15	636166	3542.49	CP-OFDM 64 QAM	1@77	19.89	19.46	22.69	25.69	0.3707
77	15	15	636166	3542.49	CP-OFDM 256 QAM	39@19	16.59	16.46	19.54	22.54	0.1793
77	15	15	636166	3542.49	CP-OFDM 256 QAM	1@1	16.84	16.53	19.70	22.70	0.1861
77	15	15	636166	3542.49	CP-OFDM 256 QAM	1@77	16.84	16.48	19.67	22.67	0.1851
77	15	20	630667	3460.005	CP-OFDM QPSK	53@26	21.52	21.44	24.49	27.49	0.5611
77	15	20	630667	3460.005	CP-OFDM QPSK	1@1	21.5	21.46	24.49	27.49	0.5611
77	15	20	630667	3460.005	CP-OFDM QPSK	1@104	21.52	21.36	24.45	27.45	0.5560
77	15	20	630667	3460.005	CP-OFDM 16 QAM	53@26	21.06	20.94	24.01	27.01	0.5024
77	15	20	630667	3460.005	CP-OFDM 16 QAM	1@1	21.14	21.19	24.18	27.18	0.5218
77	15	20	630667	3460.005	CP-OFDM 16 QAM	1@104	21.27	21.1	24.20	27.20	0.5243
77	15	20	630667	3460.005	CP-OFDM 64 QAM	53@26	19.55	19.45	22.51	25.51	0.3557
77	15	20	630667	3460.005	CP-OFDM 64 QAM	1@1	19.62	19.38	22.51	25.51	0.3558
77	15	20	630667	3460.005	CP-OFDM 64 QAM	1@104	19.53	19.28	22.42	25.42	0.3481
77	15	20	630667	3460.005	CP-OFDM 256 QAM	53@26	16.34	16.34	19.35	22.35	0.1718
77	15	20	630667	3460.005	CP-OFDM 256 QAM	1@1	16.57	16.18	19.39	22.39	0.1734
77	15	20	630667	3460.005	CP-OFDM 256 QAM	1@104	16.56	16.05	19.32	22.32	0.1707
77	15	20	633334	3500.01	CP-OFDM QPSK	53@26	21.57	21.41	24.50	27.50	0.5625
77	15	20	633334	3500.01	CP-OFDM QPSK	1@1	21.52	21.36	24.45	27.45	0.5560
77	15	20	633334	3500.01	CP-OFDM QPSK	1@104	21.53	21.46	24.51	27.51	0.5630
77	15	20	633334	3500.01	CP-OFDM 16 QAM	53@26	21.04	20.96	24.01	27.01	0.5024
77	15	20	633334	3500.01	CP-OFDM 16 QAM	1@1	21.06	20.97	24.03	27.03	0.5041
77	15	20	633334	3500.01	CP-OFDM 16 QAM	1@104	21.15	21.27	24.22	27.22	0.5273
77	15	20	633334	3500.01	CP-OFDM 64 QAM	53@26	19.58	19.39	22.50	25.50	0.3545
77	15	20	633334	3500.01	CP-OFDM 64 QAM	1@1	19.44	19.31	22.39	25.39	0.3456
77	15	20	633334	3500.01	CP-OFDM 64 QAM	1@104	19.61	19.48	22.56	25.56	0.3594
77	15	20	633334	3500.01	CP-OFDM 256 QAM	53@26	16.37	16.28	19.34	22.34	0.1712
77	15	20	633334	3500.01	CP-OFDM 256 QAM	1@1	16.57	16.16	19.38	22.38	0.1730

77	15	20	633334	3500.01	CP-OFDM 256 QAM	1@104	16.66	16.35	19.52	22.52	0.1786
77	15	20	636000	3540	CP-OFDM QPSK	53@26	21.75	21.56	24.67	27.67	0.5843
77	15	20	636000	3540	CP-OFDM QPSK	1@1	21.74	21.55	24.66	27.66	0.5830
77	15	20	636000	3540	CP-OFDM QPSK	1@104	21.68	21.47	24.59	27.59	0.5737
77	15	20	636000	3540	CP-OFDM 16 QAM	53@26	21.23	21.11	24.18	27.18	0.5225
77	15	20	636000	3540	CP-OFDM 16 QAM	1@1	21.36	21.31	24.35	27.35	0.5427
77	15	20	636000	3540	CP-OFDM 16 QAM	1@104	21.19	21.23	24.22	27.22	0.5273
77	15	20	636000	3540	CP-OFDM 64 QAM	53@26	19.74	19.51	22.64	25.64	0.3662
77	15	20	636000	3540	CP-OFDM 64 QAM	1@1	19.87	19.6	22.75	25.75	0.3756
77	15	20	636000	3540	CP-OFDM 64 QAM	1@104	19.71	19.61	22.67	25.67	0.3690
77	15	20	636000	3540	CP-OFDM 256 QAM	53@26	16.51	16.44	19.49	22.49	0.1772
77	15	20	636000	3540	CP-OFDM 256 QAM	1@1	16.81	15.99	19.43	22.43	0.1750
77	15	20	636000	3540	CP-OFDM 256 QAM	1@104	16.74	16.27	19.52	22.52	0.1787

NR Band	SCS (kHz)	Bandwidth (MHz)	Arfcn	Freq (MHz)	Modulation	RB	ANT1 Power(dBm)	ANT2 Power(dBm)	Conducted Power(dBm)	EIRP (dBm)	EIRP (W)
77	30	10	630334	3455.01	CP-OFDM QPSK	12@6	21.32	21.22	24.28	27.28	0.5346
77	30	10	630334	3455.01	CP-OFDM QPSK	1@1	21.32	21.13	24.24	27.24	0.5292
77	30	10	630334	3455.01	CP-OFDM QPSK	1@22	21.34	21.1	24.23	27.23	0.5287
77	30	10	630334	3455.01	CP-OFDM 16 QAM	12@6	20.84	20.7	23.78	26.78	0.4765
77	30	10	630334	3455.01	CP-OFDM 16 QAM	1@1	20.87	20.67	23.78	26.78	0.4766
77	30	10	630334	3455.01	CP-OFDM 16 QAM	1@22	20.96	20.63	23.81	26.81	0.4796
77	30	10	630334	3455.01	CP-OFDM 64 QAM	12@6	19.39	19.23	22.32	25.32	0.3405
77	30	10	630334	3455.01	CP-OFDM 64 QAM	1@1	19.53	19.08	22.32	25.32	0.3405
77	30	10	630334	3455.01	CP-OFDM 64 QAM	1@22	19.61	19.03	22.34	25.34	0.3420
77	30	10	630334	3455.01	CP-OFDM 256 QAM	12@6	16.33	16.14	19.25	22.25	0.1677
77	30	10	630334	3455.01	CP-OFDM 256 QAM	1@1	16.29	16.19	19.25	22.25	0.1679
77	30	10	630334	3455.01	CP-OFDM 256 QAM	1@22	16.36	16.1	19.24	22.24	0.1676
77	30	10	633334	3500.01	CP-OFDM QPSK	12@6	21.32	21.26	24.30	27.30	0.5371
77	30	10	633334	3500.01	CP-OFDM QPSK	1@1	21.38	21.18	24.29	27.29	0.5360
77	30	10	633334	3500.01	CP-OFDM QPSK	1@22	21.3	21.19	24.26	27.26	0.5316
77	30	10	633334	3500.01	CP-OFDM 16 QAM	12@6	20.87	20.75	23.82	26.82	0.4809
77	30	10	633334	3500.01	CP-OFDM 16 QAM	1@1	20.98	20.68	23.84	26.84	0.4834
77	30	10	633334	3500.01	CP-OFDM 16 QAM	1@22	20.94	20.66	23.81	26.81	0.4800
77	30	10	633334	3500.01	CP-OFDM 64 QAM	12@6	19.37	19.3	22.35	25.35	0.3424
77	30	10	633334	3500.01	CP-OFDM 64 QAM	1@1	19.36	19.37	22.38	25.38	0.3448
77	30	10	633334	3500.01	CP-OFDM 64 QAM	1@22	19.32	19.38	22.36	25.36	0.3436
77	30	10	633334	3500.01	CP-OFDM 256 QAM	12@6	16.3	16.18	19.25	22.25	0.1679
77	30	10	633334	3500.01	CP-OFDM 256 QAM	1@1	16.41	16.19	19.31	22.31	0.1703
77	30	10	633334	3500.01	CP-OFDM 256 QAM	1@22	16.31	16.18	19.26	22.26	0.1681
77	30	10	636332	3544.98	CP-OFDM QPSK	12@6	21.39	21.44	24.43	27.43	0.5528
77	30	10	636332	3544.98	CP-OFDM QPSK	1@1	21.32	21.41	24.38	27.38	0.5465
77	30	10	636332	3544.98	CP-OFDM QPSK	1@22	21.34	21.39	24.38	27.38	0.5464
77	30	10	636332	3544.98	CP-OFDM 16 QAM	12@6	20.86	20.95	23.92	26.92	0.4915
77	30	10	636332	3544.98	CP-OFDM 16 QAM	1@1	20.98	20.71	23.86	26.86	0.4850
77	30	10	636332	3544.98	CP-OFDM 16 QAM	1@22	21.01	20.7	23.87	26.87	0.4862
77	30	10	636332	3544.98	CP-OFDM 64 QAM	12@6	19.45	19.57	22.52	25.52	0.3565
77	30	10	636332	3544.98	CP-OFDM 64 QAM	1@1	19.35	19.74	22.56	25.56	0.3597

77	30	10	636332	3544.98	CP-OFDM 64 QAM	1@22	19.35	19.66	22.52	25.52	0.3563
77	30	10	636332	3544.98	CP-OFDM 256 QAM	12@6	16.33	16.54	19.45	22.45	0.1757
77	30	10	636332	3544.98	CP-OFDM 256 QAM	1@1	16.36	16.58	19.48	22.48	0.1771
77	30	10	636332	3544.98	CP-OFDM 256 QAM	1@22	16.38	16.49	19.45	22.45	0.1756
77	30	15	630500	3457.5	CP-OFDM QPSK	19@9	21.37	21.24	24.32	27.32	0.5390
77	30	15	630500	3457.5	CP-OFDM QPSK	1@1	21.28	21.12	24.21	27.21	0.5261
77	30	15	630500	3457.5	CP-OFDM QPSK	1@36	21.35	21.09	24.23	27.23	0.5287
77	30	15	630500	3457.5	CP-OFDM 16 QAM	19@9	20.84	20.69	23.78	26.78	0.4760
77	30	15	630500	3457.5	CP-OFDM 16 QAM	1@1	20.83	20.67	23.76	26.76	0.4744
77	30	15	630500	3457.5	CP-OFDM 16 QAM	1@36	21	20.6	23.81	26.81	0.4803
77	30	15	630500	3457.5	CP-OFDM 64 QAM	19@9	19.33	19.23	22.29	25.29	0.3381
77	30	15	630500	3457.5	CP-OFDM 64 QAM	1@1	19.23	19.33	22.29	25.29	0.3381
77	30	15	630500	3457.5	CP-OFDM 64 QAM	1@36	19.4	19.27	22.35	25.35	0.3424
77	30	15	630500	3457.5	CP-OFDM 256 QAM	19@9	16.29	16.18	19.25	22.25	0.1677
77	30	15	630500	3457.5	CP-OFDM 256 QAM	1@1	16.25	16.14	19.21	22.21	0.1662
77	30	15	630500	3457.5	CP-OFDM 256 QAM	1@36	16.35	16.1	19.24	22.24	0.1674
77	30	15	633334	3500.01	CP-OFDM QPSK	19@9	21.37	21.26	24.33	27.33	0.5402
77	30	15	633334	3500.01	CP-OFDM QPSK	1@1	21.39	21.11	24.26	27.26	0.5324
77	30	15	633334	3500.01	CP-OFDM QPSK	1@36	21.28	21.22	24.26	27.26	0.5322
77	30	15	633334	3500.01	CP-OFDM 16 QAM	19@9	20.84	20.74	23.80	26.80	0.4787
77	30	15	633334	3500.01	CP-OFDM 16 QAM	1@1	20.96	20.7	23.84	26.84	0.4833
77	30	15	633334	3500.01	CP-OFDM 16 QAM	1@36	20.89	20.7	23.81	26.81	0.4793
77	30	15	633334	3500.01	CP-OFDM 64 QAM	19@9	19.31	19.28	22.31	25.31	0.3393
77	30	15	633334	3500.01	CP-OFDM 64 QAM	1@1	19.32	19.33	22.34	25.34	0.3416
77	30	15	633334	3500.01	CP-OFDM 64 QAM	1@36	19.29	19.39	22.35	25.35	0.3428
77	30	15	633334	3500.01	CP-OFDM 256 QAM	19@9	16.3	16.18	19.25	22.25	0.1679
77	30	15	633334	3500.01	CP-OFDM 256 QAM	1@1	16.37	16.14	19.27	22.27	0.1685
77	30	15	633334	3500.01	CP-OFDM 256 QAM	1@36	16.24	16.18	19.22	22.22	0.1667
77	30	15	636166	3542.49	CP-OFDM QPSK	19@9	21.3	21.45	24.39	27.39	0.5478
77	30	15	636166	3542.49	CP-OFDM QPSK	1@1	21.24	21.36	24.31	27.31	0.5384
77	30	15	636166	3542.49	CP-OFDM QPSK	1@36	21.27	21.32	24.31	27.31	0.5377
77	30	15	636166	3542.49	CP-OFDM 16 QAM	19@9	20.82	20.95	23.90	26.90	0.4893
77	30	15	636166	3542.49	CP-OFDM 16 QAM	1@1	20.8	20.89	23.86	26.86	0.4848
77	30	15	636166	3542.49	CP-OFDM 16 QAM	1@36	20.86	20.87	23.88	26.88	0.4870

77	30	15	636166	3542.49	CP-OFDM 64 QAM	19@9	19.27	19.6	22.45	25.45	0.3506
77	30	15	636166	3542.49	CP-OFDM 64 QAM	1@1	19.25	19.66	22.47	25.47	0.3524
77	30	15	636166	3542.49	CP-OFDM 64 QAM	1@36	19.32	19.59	22.47	25.47	0.3522
77	30	15	636166	3542.49	CP-OFDM 256 QAM	19@9	16.23	16.53	19.39	22.39	0.1735
77	30	15	636166	3542.49	CP-OFDM 256 QAM	1@1	16.15	16.47	19.32	22.32	0.1707
77	30	15	636166	3542.49	CP-OFDM 256 QAM	1@36	16.1	16.43	19.28	22.28	0.1690
77	30	20	630668	3460.02	CP-OFDM QPSK	25@12	21.38	21.19	24.30	27.30	0.5366
77	30	20	630668	3460.02	CP-OFDM QPSK	1@1	21.18	21.05	24.13	27.13	0.5159
77	30	20	630668	3460.02	CP-OFDM QPSK	1@49	21.35	21.03	24.20	27.20	0.5252
77	30	20	630668	3460.02	CP-OFDM 16 QAM	25@12	20.85	20.62	23.75	26.75	0.4728
77	30	20	630668	3460.02	CP-OFDM 16 QAM	1@1	20.77	20.54	23.67	26.67	0.4642
77	30	20	630668	3460.02	CP-OFDM 16 QAM	1@49	20.91	20.5	23.72	26.72	0.4699
77	30	20	630668	3460.02	CP-OFDM 64 QAM	25@12	19.32	19.2	22.27	25.27	0.3366
77	30	20	630668	3460.02	CP-OFDM 64 QAM	1@1	19.19	19.25	22.23	25.23	0.3335
77	30	20	630668	3460.02	CP-OFDM 64 QAM	1@49	19.31	19.24	22.29	25.29	0.3377
77	30	20	630668	3460.02	CP-OFDM 256 QAM	25@12	16.35	16.09	19.23	22.23	0.1672
77	30	20	630668	3460.02	CP-OFDM 256 QAM	1@1	16.14	16.08	19.12	22.12	0.1629
77	30	20	630668	3460.02	CP-OFDM 256 QAM	1@49	16.27	15.99	19.14	22.14	0.1638
77	30	20	633334	3500.01	CP-OFDM QPSK	25@12	21.33	21.27	24.31	27.31	0.5383
77	30	20	633334	3500.01	CP-OFDM QPSK	1@1	21.25	21.07	24.17	27.17	0.5213
77	30	20	633334	3500.01	CP-OFDM QPSK	1@49	21.18	21.18	24.19	27.19	0.5236
77	30	20	633334	3500.01	CP-OFDM 16 QAM	25@12	20.84	20.7	23.78	26.78	0.4765
77	30	20	633334	3500.01	CP-OFDM 16 QAM	1@1	20.87	20.56	23.73	26.73	0.4708
77	30	20	633334	3500.01	CP-OFDM 16 QAM	1@49	20.76	20.65	23.72	26.72	0.4694
77	30	20	633334	3500.01	CP-OFDM 64 QAM	25@12	19.36	19.23	22.31	25.31	0.3393
77	30	20	633334	3500.01	CP-OFDM 64 QAM	1@1	19.5	19	22.27	25.27	0.3363
77	30	20	633334	3500.01	CP-OFDM 64 QAM	1@49	19.44	19.07	22.27	25.27	0.3365
77	30	20	633334	3500.01	CP-OFDM 256 QAM	25@12	16.3	16.16	19.24	22.24	0.1675
77	30	20	633334	3500.01	CP-OFDM 256 QAM	1@1	16.32	16.1	19.22	22.22	0.1668
77	30	20	633334	3500.01	CP-OFDM 256 QAM	1@49	16.17	16.14	19.17	22.17	0.1646
77	30	20	636000	3540	CP-OFDM QPSK	25@12	21.26	21.45	24.37	27.37	0.5453
77	30	20	636000	3540	CP-OFDM QPSK	1@1	21.2	21.26	24.24	27.24	0.5297
77	30	20	636000	3540	CP-OFDM QPSK	1@49	21.23	21.27	24.26	27.26	0.5322
77	30	20	636000	3540	CP-OFDM 16 QAM	25@12	20.83	20.84	23.85	26.85	0.4836

77	30	20	636000	3540	CP-OFDM 16 QAM	1@1	20.79	20.84	23.83	26.83	0.4814
77	30	20	636000	3540	CP-OFDM 16 QAM	1@49	20.81	20.81	23.82	26.82	0.4809
77	30	20	636000	3540	CP-OFDM 64 QAM	25@12	19.29	19.59	22.45	25.45	0.3510
77	30	20	636000	3540	CP-OFDM 64 QAM	1@1	19.17	19.62	22.41	25.41	0.3476
77	30	20	636000	3540	CP-OFDM 64 QAM	1@49	19.23	19.58	22.42	25.42	0.3482
77	30	20	636000	3540	CP-OFDM 256 QAM	25@12	16.27	16.47	19.38	22.38	0.1730
77	30	20	636000	3540	CP-OFDM 256 QAM	1@1	16.19	16.44	19.33	22.33	0.1709
77	30	20	636000	3540	CP-OFDM 256 QAM	1@49	16.19	16.37	19.29	22.29	0.1695
77	30	40	631334	3470.01	CP-OFDM QPSK	53@26	21.31	21.05	24.19	27.19	0.5239
77	30	40	631334	3470.01	CP-OFDM QPSK	1@1	20.92	20.69	23.82	26.82	0.4805
77	30	40	631334	3470.01	CP-OFDM QPSK	1@104	21.09	20.74	23.93	26.93	0.4930
77	30	40	631334	3470.01	CP-OFDM 16 QAM	53@26	20.82	20.55	23.70	26.70	0.4675
77	30	40	631334	3470.01	CP-OFDM 16 QAM	1@1	20.49	20.21	23.36	26.36	0.4328
77	30	40	631334	3470.01	CP-OFDM 16 QAM	1@104	20.67	20.23	23.47	26.47	0.4432
77	30	40	631334	3470.01	CP-OFDM 64 QAM	53@26	19.37	19.01	22.20	25.20	0.3314
77	30	40	631334	3470.01	CP-OFDM 64 QAM	1@1	18.67	18.92	21.81	24.81	0.3025
77	30	40	631334	3470.01	CP-OFDM 64 QAM	1@104	18.91	18.96	21.95	24.95	0.3123
77	30	40	631334	3470.01	CP-OFDM 256 QAM	53@26	16.27	16.03	19.16	22.16	0.1645
77	30	40	631334	3470.01	CP-OFDM 256 QAM	1@1	15.9	15.76	18.84	21.84	0.1528
77	30	40	631334	3470.01	CP-OFDM 256 QAM	1@104	16.1	15.73	18.93	21.93	0.1559
77	30	40	633334	3500.01	CP-OFDM QPSK	53@26	21.26	21.22	24.25	27.25	0.5309
77	30	40	633334	3500.01	CP-OFDM QPSK	1@1	20.88	20.76	23.83	26.83	0.4820
77	30	40	633334	3500.01	CP-OFDM QPSK	1@104	20.82	20.89	23.87	26.87	0.4859
77	30	40	633334	3500.01	CP-OFDM 16 QAM	53@26	20.79	20.73	23.77	26.77	0.4754
77	30	40	633334	3500.01	CP-OFDM 16 QAM	1@1	20.54	20.28	23.42	26.42	0.4388
77	30	40	633334	3500.01	CP-OFDM 16 QAM	1@104	20.47	20.46	23.48	26.48	0.4442
77	30	40	633334	3500.01	CP-OFDM 64 QAM	53@26	19.31	19.18	22.26	25.26	0.3354
77	30	40	633334	3500.01	CP-OFDM 64 QAM	1@1	18.87	19	21.95	24.95	0.3123
77	30	40	633334	3500.01	CP-OFDM 64 QAM	1@104	19.12	18.89	22.02	25.02	0.3175
77	30	40	633334	3500.01	CP-OFDM 256 QAM	53@26	16.2	16.14	19.18	22.18	0.1652
77	30	40	633334	3500.01	CP-OFDM 256 QAM	1@1	15.88	15.77	18.84	21.84	0.1526
77	30	40	633334	3500.01	CP-OFDM 256 QAM	1@104	15.88	15.88	18.89	21.89	0.1545
77	30	40	635332	3529.98	CP-OFDM QPSK	53@26	21.17	21.36	24.28	27.28	0.5341
77	30	40	635332	3529.98	CP-OFDM QPSK	1@1	20.78	20.9	23.85	26.85	0.4843

77	30	40	635332	3529.98	CP-OFDM QPSK	1@104	20.86	21.04	23.96	26.96	0.4967
77	30	40	635332	3529.98	CP-OFDM 16 QAM	53@26	20.69	20.87	23.79	26.79	0.4777
77	30	40	635332	3529.98	CP-OFDM 16 QAM	1@1	20.42	20.56	23.50	26.50	0.4468
77	30	40	635332	3529.98	CP-OFDM 16 QAM	1@104	20.48	20.62	23.56	26.56	0.4530
77	30	40	635332	3529.98	CP-OFDM 64 QAM	53@26	19.19	19.46	22.34	25.34	0.3418
77	30	40	635332	3529.98	CP-OFDM 64 QAM	1@1	18.75	19.24	22.01	25.01	0.3171
77	30	40	635332	3529.98	CP-OFDM 64 QAM	1@104	18.86	19.33	22.11	25.11	0.3245
77	30	40	635332	3529.98	CP-OFDM 256 QAM	53@26	16.08	16.5	19.31	22.31	0.1700
77	30	40	635332	3529.98	CP-OFDM 256 QAM	1@1	15.8	16.03	18.93	21.93	0.1558
77	30	40	635332	3529.98	CP-OFDM 256 QAM	1@104	15.89	16.13	19.02	22.02	0.1593
77	30	50	631668	3475.02	CP-OFDM QPSK	67@33	21.39	21.13	24.27	27.27	0.5336
77	30	50	631668	3475.02	CP-OFDM QPSK	1@1	21.12	20.99	24.07	27.07	0.5088
77	30	50	631668	3475.02	CP-OFDM QPSK	1@131	21.34	21.01	24.19	27.19	0.5234
77	30	50	631668	3475.02	CP-OFDM 16 QAM	67@33	20.87	20.59	23.74	26.74	0.4723
77	30	50	631668	3475.02	CP-OFDM 16 QAM	1@1	20.78	20.26	23.54	26.54	0.4506
77	30	50	631668	3475.02	CP-OFDM 16 QAM	1@131	20.95	20.57	23.77	26.77	0.4758
77	30	50	631668	3475.02	CP-OFDM 64 QAM	67@33	19.36	19.1	22.24	25.24	0.3344
77	30	50	631668	3475.02	CP-OFDM 64 QAM	1@1	19.14	19.23	22.20	25.20	0.3308
77	30	50	631668	3475.02	CP-OFDM 64 QAM	1@131	19.24	19.21	22.24	25.24	0.3338
77	30	50	631668	3475.02	CP-OFDM 256 QAM	67@33	16.32	16.06	19.20	22.20	0.1660
77	30	50	631668	3475.02	CP-OFDM 256 QAM	1@1	16.14	15.99	19.08	22.08	0.1613
77	30	50	631668	3475.02	CP-OFDM 256 QAM	1@131	16.27	15.97	19.13	22.13	0.1634
77	30	50	633334	3500.01	CP-OFDM QPSK	67@33	21.31	21.27	24.30	27.30	0.5371
77	30	50	633334	3500.01	CP-OFDM QPSK	1@1	21.21	20.99	24.11	27.11	0.5142
77	30	50	633334	3500.01	CP-OFDM QPSK	1@131	21.17	21.17	24.18	27.18	0.5224
77	30	50	633334	3500.01	CP-OFDM 16 QAM	67@33	20.8	20.77	23.80	26.80	0.4781
77	30	50	633334	3500.01	CP-OFDM 16 QAM	1@1	20.82	20.54	23.69	26.69	0.4669
77	30	50	633334	3500.01	CP-OFDM 16 QAM	1@131	20.75	20.7	23.74	26.74	0.4716
77	30	50	633334	3500.01	CP-OFDM 64 QAM	67@33	19.3	19.24	22.28	25.28	0.3373
77	30	50	633334	3500.01	CP-OFDM 64 QAM	1@1	19.19	19.25	22.23	25.23	0.3335
77	30	50	633334	3500.01	CP-OFDM 64 QAM	1@131	19.1	19.32	22.22	25.22	0.3328
77	30	50	633334	3500.01	CP-OFDM 256 QAM	67@33	16.29	16.24	19.28	22.28	0.1689
77	30	50	633334	3500.01	CP-OFDM 256 QAM	1@1	16.08	16.03	19.07	22.07	0.1609
77	30	50	633334	3500.01	CP-OFDM 256 QAM	1@131	16.13	16.15	19.15	22.15	0.1641

77	30	50	635000	3525	CP-OFDM QPSK	67@33	21.18	21.41	24.31	27.31	0.5379
77	30	50	635000	3525	CP-OFDM QPSK	1@1	21.16	21.01	24.10	27.10	0.5124
77	30	50	635000	3525	CP-OFDM QPSK	1@131	21.15	21.18	24.18	27.18	0.5218
77	30	50	635000	3525	CP-OFDM 16 QAM	67@33	20.65	20.89	23.78	26.78	0.4766
77	30	50	635000	3525	CP-OFDM 16 QAM	1@1	20.75	20.75	23.76	26.76	0.4743
77	30	50	635000	3525	CP-OFDM 16 QAM	1@131	20.79	20.76	23.79	26.79	0.4770
77	30	50	635000	3525	CP-OFDM 64 QAM	67@33	19.15	19.5	22.34	25.34	0.3419
77	30	50	635000	3525	CP-OFDM 64 QAM	1@1	19.16	19.41	22.30	25.30	0.3386
77	30	50	635000	3525	CP-OFDM 64 QAM	1@131	19.12	19.55	22.35	25.35	0.3428
77	30	50	635000	3525	CP-OFDM 256 QAM	67@33	16.09	16.47	19.29	22.29	0.1696
77	30	50	635000	3525	CP-OFDM 256 QAM	1@1	16.12	16.21	19.18	22.18	0.1650
77	30	50	635000	3525	CP-OFDM 256 QAM	1@131	16.13	16.34	19.25	22.25	0.1677
77	30	60	632000	3480	CP-OFDM QPSK	81@40	21.33	21.08	24.22	27.22	0.5269
77	30	60	632000	3480	CP-OFDM QPSK	1@1	21.12	20.95	24.05	27.05	0.5065
77	30	60	632000	3480	CP-OFDM QPSK	1@160	21.36	21.13	24.26	27.26	0.5317
77	30	60	632000	3480	CP-OFDM 16 QAM	81@40	20.86	20.6	23.74	26.74	0.4723
77	30	60	632000	3480	CP-OFDM 16 QAM	1@1	20.78	20.29	23.55	26.55	0.4521
77	30	60	632000	3480	CP-OFDM 16 QAM	1@160	20.97	20.66	23.83	26.83	0.4817
77	30	60	632000	3480	CP-OFDM 64 QAM	81@40	19.38	19.03	22.22	25.22	0.3326
77	30	60	632000	3480	CP-OFDM 64 QAM	1@1	19.01	19.2	22.12	25.12	0.3248
77	30	60	632000	3480	CP-OFDM 64 QAM	1@160	19.29	19.32	22.32	25.32	0.3400
77	30	60	632000	3480	CP-OFDM 256 QAM	81@40	16.31	16.03	19.18	22.18	0.1653
77	30	60	632000	3480	CP-OFDM 256 QAM	1@1	16.06	16	19.04	22.04	0.1600
77	30	60	632000	3480	CP-OFDM 256 QAM	1@160	16.26	16.11	19.20	22.20	0.1658
77	30	60	633334	3500.01	CP-OFDM QPSK	81@40	21.29	21.25	24.28	27.28	0.5346
77	30	60	633334	3500.01	CP-OFDM QPSK	1@1	21.17	21.01	24.10	27.10	0.5130
77	30	60	633334	3500.01	CP-OFDM QPSK	1@160	21.15	21.21	24.19	27.19	0.5236
77	30	60	633334	3500.01	CP-OFDM 16 QAM	81@40	20.81	20.78	23.81	26.81	0.4792
77	30	60	633334	3500.01	CP-OFDM 16 QAM	1@1	20.9	20.49	23.71	26.71	0.4688
77	30	60	633334	3500.01	CP-OFDM 16 QAM	1@160	20.87	20.73	23.81	26.81	0.4798
77	30	60	633334	3500.01	CP-OFDM 64 QAM	81@40	19.3	19.22	22.27	25.27	0.3365
77	30	60	633334	3500.01	CP-OFDM 64 QAM	1@1	19.41	19.24	22.34	25.34	0.3417
77	30	60	633334	3500.01	CP-OFDM 64 QAM	1@160	19.56	19.09	22.34	25.34	0.3421
77	30	60	633334	3500.01	CP-OFDM 256 QAM	81@40	16.25	16.23	19.25	22.25	0.1679

77	30	60	633334	3500.01	CP-OFDM 256 QAM	1@1	16.14	16.04	19.10	22.10	0.1622
77	30	60	633334	3500.01	CP-OFDM 256 QAM	1@160	16.09	16.23	19.17	22.17	0.1648
77	30	60	634666	3519.99	CP-OFDM QPSK	81@40	21.15	21.5	24.34	27.34	0.5419
77	30	60	634666	3519.99	CP-OFDM QPSK	1@1	21.18	21.07	24.14	27.14	0.5171
77	30	60	634666	3519.99	CP-OFDM QPSK	1@160	21.26	21.33	24.31	27.31	0.5377
77	30	60	634666	3519.99	CP-OFDM 16 QAM	81@40	20.69	20.96	23.84	26.84	0.4828
77	30	60	634666	3519.99	CP-OFDM 16 QAM	1@1	20.86	20.77	23.83	26.83	0.4815
77	30	60	634666	3519.99	CP-OFDM 16 QAM	1@160	20.94	20.83	23.90	26.90	0.4893
77	30	60	634666	3519.99	CP-OFDM 64 QAM	81@40	19.2	19.52	22.37	25.37	0.3446
77	30	60	634666	3519.99	CP-OFDM 64 QAM	1@1	19.21	19.48	22.36	25.36	0.3434
77	30	60	634666	3519.99	CP-OFDM 64 QAM	1@160	19.21	19.65	22.45	25.45	0.3504
77	30	60	634666	3519.99	CP-OFDM 256 QAM	81@40	16.13	16.52	19.34	22.34	0.1714
77	30	60	634666	3519.99	CP-OFDM 256 QAM	1@1	16.14	16.32	19.24	22.24	0.1675
77	30	60	634666	3519.99	CP-OFDM 256 QAM	1@160	16.16	16.47	19.33	22.33	0.1709
77	30	80	649334	3490.02	CP-OFDM QPSK	109@54	21.28	21.14	24.22	27.22	0.5273
77	30	80	649334	3490.02	CP-OFDM QPSK	1@1	20.82	20.8	23.82	26.82	0.4809
77	30	80	649334	3490.02	CP-OFDM QPSK	1@215	20.97	21.08	24.04	27.04	0.5053
77	30	80	649334	3490.02	CP-OFDM 16 QAM	109@54	20.8	20.66	23.74	26.74	0.4722
77	30	80	649334	3490.02	CP-OFDM 16 QAM	1@1	20.44	20.32	23.39	26.39	0.4356
77	30	80	649334	3490.02	CP-OFDM 16 QAM	1@215	20.58	20.62	23.61	26.61	0.4582
77	30	80	649334	3490.02	CP-OFDM 64 QAM	109@54	19.32	19.17	22.26	25.26	0.3354
77	30	80	649334	3490.02	CP-OFDM 64 QAM	1@1	18.88	19.01	21.96	24.96	0.3130
77	30	80	649334	3490.02	CP-OFDM 64 QAM	1@215	18.92	19.27	22.11	25.11	0.3243
77	30	80	649334	3490.02	CP-OFDM 256 QAM	109@54	16.3	16.14	19.23	22.23	0.1671
77	30	80	649334	3490.02	CP-OFDM 256 QAM	1@1	15.78	15.8	18.80	21.80	0.1514
77	30	80	649334	3490.02	CP-OFDM 256 QAM	1@215	15.95	16.04	19.01	22.01	0.1587
77	30	80	633334	3500.01	CP-OFDM QPSK	109@54	21.24	21.26	24.26	27.26	0.5321
77	30	80	633334	3500.01	CP-OFDM QPSK	1@1	20.84	20.8	23.83	26.83	0.4820
77	30	80	633334	3500.01	CP-OFDM QPSK	1@215	20.76	20.79	23.79	26.79	0.4770
77	30	80	633334	3500.01	CP-OFDM 16 QAM	109@54	20.74	20.79	23.78	26.78	0.4759
77	30	80	633334	3500.01	CP-OFDM 16 QAM	1@1	20.49	20.41	23.46	26.46	0.4426
77	30	80	633334	3500.01	CP-OFDM 16 QAM	1@215	20.44	20.44	23.45	26.45	0.4416
77	30	80	633334	3500.01	CP-OFDM 64 QAM	109@54	19.22	19.28	22.26	25.26	0.3358
77	30	80	633334	3500.01	CP-OFDM 64 QAM	1@1	18.9	19.05	21.99	24.99	0.3152

77	30	80	633334	3500.01	CP-OFDM 64 QAM	1@215	18.8	19.28	22.06	25.06	0.3204
77	30	80	633334	3500.01	CP-OFDM 256 QAM	109@54	16.22	16.29	19.27	22.27	0.1685
77	30	80	633334	3500.01	CP-OFDM 256 QAM	1@1	15.84	15.83	18.85	21.85	0.1529
77	30	80	633334	3500.01	CP-OFDM 256 QAM	1@215	15.75	16.04	18.91	21.91	0.1552
77	30	80	634000	3510	CP-OFDM QPSK	109@54	21.27	21.28	24.29	27.29	0.5352
77	30	80	634000	3510	CP-OFDM QPSK	1@1	20.98	20.68	23.84	26.84	0.4834
77	30	80	634000	3510	CP-OFDM QPSK	1@215	20.97	20.88	23.94	26.94	0.4938
77	30	80	634000	3510	CP-OFDM 16 QAM	109@54	20.78	20.81	23.81	26.81	0.4792
77	30	80	634000	3510	CP-OFDM 16 QAM	1@1	20.61	20.59	23.61	26.61	0.4582
77	30	80	634000	3510	CP-OFDM 16 QAM	1@215	20.63	20.5	23.58	26.58	0.4545
77	30	80	634000	3510	CP-OFDM 64 QAM	109@54	19.28	19.48	22.39	25.39	0.3461
77	30	80	634000	3510	CP-OFDM 64 QAM	1@1	18.93	19.25	22.10	25.10	0.3238
77	30	80	634000	3510	CP-OFDM 64 QAM	1@215	18.98	19.17	22.09	25.09	0.3226
77	30	80	634000	3510	CP-OFDM 256 QAM	109@54	16.29	16.46	19.39	22.39	0.1732
77	30	80	634000	3510	CP-OFDM 256 QAM	1@1	15.95	16.01	18.99	21.99	0.1581
77	30	80	634000	3510	CP-OFDM 256 QAM	1@215	16.02	16.2	19.12	22.12	0.1630
77	30	100	633334	3500.01	CP-OFDM QPSK	137@68	21.27	21.19	24.24	27.24	0.5297
77	30	100	633334	3500.01	CP-OFDM QPSK	1@1	20.73	20.58	23.67	26.67	0.4641
77	30	100	633334	3500.01	CP-OFDM QPSK	1@271	21.02	20.87	23.96	26.96	0.4961
77	30	100	633334	3500.01	CP-OFDM 16 QAM	137@68	20.81	20.69	23.76	26.76	0.4743
77	30	100	633334	3500.01	CP-OFDM 16 QAM	1@1	20.42	20.25	23.35	26.35	0.4311
77	30	100	633334	3500.01	CP-OFDM 16 QAM	1@271	20.62	20.57	23.61	26.61	0.4577
77	30	100	633334	3500.01	CP-OFDM 64 QAM	137@68	19.3	19.2	22.26	25.26	0.3358
77	30	100	633334	3500.01	CP-OFDM 64 QAM	1@1	18.84	18.81	21.84	24.84	0.3045
77	30	100	633334	3500.01	CP-OFDM 64 QAM	1@271	18.92	19.07	22.01	25.01	0.3167
77	30	100	633334	3500.01	CP-OFDM 256 QAM	137@68	16.26	16.19	19.24	22.24	0.1673
77	30	100	633334	3500.01	CP-OFDM 256 QAM	1@1	15.68	15.6	18.65	21.65	0.1462
77	30	100	633334	3500.01	CP-OFDM 256 QAM	1@271	15.89	15.88	18.90	21.90	0.1547

FR1 N78

Transmitter Conducted Output Power And ERP/EIRP, ($G_T - L_C$)=3.0dB

NR Band	SCS (kHz)	Bandwidth (MHz)	Arfcn	Freq (MHz)	Modulation	RB	Conducted Power(dBm)	EIRP (dBm)	EIRP (W)
78	15	10	630334	3455.01	DFT-s-OFDM PI/2 BPSK	25@12	26.44	29.44	0.8790
78	15	10	630334	3455.01	DFT-s-OFDM PI/2 BPSK	1@1	26.39	29.39	0.8690
78	15	10	630334	3455.01	DFT-s-OFDM PI/2 BPSK	1@50	26.43	29.43	0.8770
78	15	10	630334	3455.01	DFT-s-OFDM QPSK	25@12	26.46	29.46	0.8831
78	15	10	630334	3455.01	DFT-s-OFDM QPSK	1@1	26.51	29.51	0.8933
78	15	10	630334	3455.01	DFT-s-OFDM QPSK	1@50	26.54	29.54	0.8995
78	15	10	630334	3455.01	DFT-s-OFDM 16 QAM	25@12	25.48	28.48	0.7047
78	15	10	630334	3455.01	DFT-s-OFDM 16 QAM	1@1	25.31	28.31	0.6776
78	15	10	630334	3455.01	DFT-s-OFDM 16 QAM	1@50	25.31	28.31	0.6776
78	15	10	630334	3455.01	DFT-s-OFDM 64 QAM	25@12	24.01	27.01	0.5023
78	15	10	630334	3455.01	DFT-s-OFDM 64 QAM	1@1	23.99	26.99	0.5000
78	15	10	630334	3455.01	DFT-s-OFDM 64 QAM	1@50	24.23	27.23	0.5284
78	15	10	630334	3455.01	DFT-s-OFDM 256 QAM	25@12	21.93	24.93	0.3112
78	15	10	630334	3455.01	DFT-s-OFDM 256 QAM	1@1	22.15	25.15	0.3273
78	15	10	630334	3455.01	DFT-s-OFDM 256 QAM	1@50	22.11	25.11	0.3243
78	15	10	630334	3455.01	CP-OFDM QPSK	26@13	24.96	27.96	0.6252
78	15	10	630334	3455.01	CP-OFDM QPSK	1@1	24.97	27.97	0.6266
78	15	10	630334	3455.01	CP-OFDM QPSK	1@50	24.87	27.87	0.6124
78	15	10	633334	3500.01	DFT-s-OFDM PI/2 BPSK	25@12	26.3	29.3	0.8511
78	15	10	633334	3500.01	DFT-s-OFDM PI/2 BPSK	1@1	26.3	29.3	0.8511
78	15	10	633334	3500.01	DFT-s-OFDM PI/2 BPSK	1@50	26.3	29.3	0.8511
78	15	10	633334	3500.01	DFT-s-OFDM QPSK	25@12	26.31	29.31	0.8531
78	15	10	633334	3500.01	DFT-s-OFDM QPSK	1@1	26.41	29.41	0.8730
78	15	10	633334	3500.01	DFT-s-OFDM QPSK	1@50	26.44	29.44	0.8790
78	15	10	633334	3500.01	DFT-s-OFDM 16 QAM	25@12	25.34	28.34	0.6823
78	15	10	633334	3500.01	DFT-s-OFDM 16 QAM	1@1	25.29	28.29	0.6745
78	15	10	633334	3500.01	DFT-s-OFDM 16 QAM	1@50	25.25	28.25	0.6683
78	15	10	633334	3500.01	DFT-s-OFDM 64	25@12	23.79	26.79	0.4775

					QAM				
78	15	10	633334	3500.01	DFT-s-OFDM 64 QAM	1@1	23.81	26.81	0.4797
78	15	10	633334	3500.01	DFT-s-OFDM 64 QAM	1@50	23.81	26.81	0.4797
78	15	10	633334	3500.01	DFT-s-OFDM 256 QAM	25@12	21.79	24.79	0.3013
78	15	10	633334	3500.01	DFT-s-OFDM 256 QAM	1@1	21.98	24.98	0.3148
78	15	10	633334	3500.01	DFT-s-OFDM 256 QAM	1@50	22.01	25.01	0.3170
78	15	10	633334	3500.01	CP-OFDM QPSK	26@13	24.79	27.79	0.6012
78	15	10	633334	3500.01	CP-OFDM QPSK	1@1	24.82	27.82	0.6053
78	15	10	633334	3500.01	CP-OFDM QPSK	1@50	24.8	27.8	0.6026
78	15	10	636333	3544.995	DFT-s-OFDM PI/2 BPSK	25@12	26.18	29.18	0.8279
78	15	10	636333	3544.995	DFT-s-OFDM PI/2 BPSK	1@1	26.2	29.2	0.8318
78	15	10	636333	3544.995	DFT-s-OFDM PI/2 BPSK	1@50	26.24	29.24	0.8395
78	15	10	636333	3544.995	DFT-s-OFDM QPSK	25@12	26.18	29.18	0.8279
78	15	10	636333	3544.995	DFT-s-OFDM QPSK	1@1	26.27	29.27	0.8453
78	15	10	636333	3544.995	DFT-s-OFDM QPSK	1@50	26.3	29.3	0.8511
78	15	10	636333	3544.995	DFT-s-OFDM 16 QAM	25@12	25.17	28.17	0.6561
78	15	10	636333	3544.995	DFT-s-OFDM 16 QAM	1@1	25.24	28.24	0.6668
78	15	10	636333	3544.995	DFT-s-OFDM 16 QAM	1@50	25.3	28.3	0.6761
78	15	10	636333	3544.995	DFT-s-OFDM 64 QAM	25@12	23.67	26.67	0.4645
78	15	10	636333	3544.995	DFT-s-OFDM 64 QAM	1@1	23.67	26.67	0.4645
78	15	10	636333	3544.995	DFT-s-OFDM 64 QAM	1@50	23.71	26.71	0.4688
78	15	10	636333	3544.995	DFT-s-OFDM 256 QAM	25@12	21.76	24.76	0.2992
78	15	10	636333	3544.995	DFT-s-OFDM 256 QAM	1@1	21.86	24.86	0.3062
78	15	10	636333	3544.995	DFT-s-OFDM 256 QAM	1@50	21.87	24.87	0.3069
78	15	10	636333	3544.995	CP-OFDM QPSK	26@13	24.69	27.69	0.5875
78	15	10	636333	3544.995	CP-OFDM QPSK	1@1	24.72	27.72	0.5916
78	15	10	636333	3544.995	CP-OFDM QPSK	1@50	24.66	27.66	0.5834
78	15	15	630500	3457.5	DFT-s-OFDM PI/2 BPSK	36@18	26.64	29.64	0.9204
78	15	15	630500	3457.5	DFT-s-OFDM PI/2 BPSK	1@1	26.57	29.57	0.9057
78	15	15	630500	3457.5	DFT-s-OFDM PI/2 BPSK	1@77	26.58	29.58	0.9078
78	15	15	630500	3457.5	DFT-s-OFDM QPSK	36@18	26.66	29.66	0.9247
78	15	15	630500	3457.5	DFT-s-OFDM QPSK	1@1	26.71	29.71	0.9354
78	15	15	630500	3457.5	DFT-s-OFDM QPSK	1@77	26.68	29.68	0.9290
78	15	15	630500	3457.5	DFT-s-OFDM 16 QAM	36@18	25.68	28.68	0.7379
78	15	15	630500	3457.5	DFT-s-OFDM 16 QAM	1@1	25.45	28.45	0.6998
78	15	15	630500	3457.5	DFT-s-OFDM 16 QAM	1@77	25.45	28.45	0.6998

78	15	15	630500	3457.5	DFT-s-OFDM 64 QAM	36@18	24.17	27.17	0.5212
78	15	15	630500	3457.5	DFT-s-OFDM 64 QAM	1@1	24.3	27.3	0.5370
78	15	15	630500	3457.5	DFT-s-OFDM 64 QAM	1@77	24.03	27.03	0.5047
78	15	15	630500	3457.5	DFT-s-OFDM 256 QAM	36@18	22.17	25.17	0.3289
78	15	15	630500	3457.5	DFT-s-OFDM 256 QAM	1@1	22.22	25.22	0.3327
78	15	15	630500	3457.5	DFT-s-OFDM 256 QAM	1@77	22.16	25.16	0.3281
78	15	15	630500	3457.5	CP-OFDM QPSK	39@19	25.17	28.17	0.6561
78	15	15	630500	3457.5	CP-OFDM QPSK	1@1	25.12	28.12	0.6486
78	15	15	630500	3457.5	CP-OFDM QPSK	1@77	25.01	28.01	0.6324
78	15	15	633334	3500.01	DFT-s-OFDM PI/2 BPSK	36@18	26.52	29.52	0.8954
78	15	15	633334	3500.01	DFT-s-OFDM PI/2 BPSK	1@1	26.41	29.41	0.8730
78	15	15	633334	3500.01	DFT-s-OFDM PI/2 BPSK	1@77	26.42	29.42	0.8750
78	15	15	633334	3500.01	DFT-s-OFDM QPSK	36@18	26.51	29.51	0.8933
78	15	15	633334	3500.01	DFT-s-OFDM QPSK	1@1	26.52	29.52	0.8954
78	15	15	633334	3500.01	DFT-s-OFDM QPSK	1@77	26.53	29.53	0.8974
78	15	15	633334	3500.01	DFT-s-OFDM 16 QAM	36@18	25.52	28.52	0.7112
78	15	15	633334	3500.01	DFT-s-OFDM 16 QAM	1@1	25.28	28.28	0.6730
78	15	15	633334	3500.01	DFT-s-OFDM 16 QAM	1@77	25.33	28.33	0.6808
78	15	15	633334	3500.01	DFT-s-OFDM 64 QAM	36@18	24.05	27.05	0.5070
78	15	15	633334	3500.01	DFT-s-OFDM 64 QAM	1@1	23.91	26.91	0.4909
78	15	15	633334	3500.01	DFT-s-OFDM 64 QAM	1@77	23.86	26.86	0.4853
78	15	15	633334	3500.01	DFT-s-OFDM 256 QAM	36@18	22.06	25.06	0.3206
78	15	15	633334	3500.01	DFT-s-OFDM 256 QAM	1@1	22.08	25.08	0.3221
78	15	15	633334	3500.01	DFT-s-OFDM 256 QAM	1@77	22.12	25.12	0.3251
78	15	15	633334	3500.01	CP-OFDM QPSK	39@19	24.99	27.99	0.6295
78	15	15	633334	3500.01	CP-OFDM QPSK	1@1	24.95	27.95	0.6237
78	15	15	633334	3500.01	CP-OFDM QPSK	1@77	24.9	27.9	0.6166
78	15	15	636166	3542.49	DFT-s-OFDM PI/2 BPSK	36@18	26.49	29.49	0.8892
78	15	15	636166	3542.49	DFT-s-OFDM PI/2 BPSK	1@1	26.37	29.37	0.8650
78	15	15	636166	3542.49	DFT-s-OFDM PI/2 BPSK	1@77	26.51	29.51	0.8933
78	15	15	636166	3542.49	DFT-s-OFDM QPSK	36@18	26.53	29.53	0.8974
78	15	15	636166	3542.49	DFT-s-OFDM QPSK	1@1	26.42	29.42	0.8750
78	15	15	636166	3542.49	DFT-s-OFDM QPSK	1@77	26.52	29.52	0.8954
78	15	15	636166	3542.49	DFT-s-OFDM 16 QAM	36@18	25.56	28.56	0.7178
78	15	15	636166	3542.49	DFT-s-OFDM 16 QAM	1@1	25.64	28.64	0.7311
78	15	15	636166	3542.49	DFT-s-OFDM 16 QAM	1@77	25.78	28.78	0.7551

78	15	15	636166	3542.49	DFT-s-OFDM 64 QAM	36@18	24.01	27.01	0.5023
78	15	15	636166	3542.49	DFT-s-OFDM 64 QAM	1@1	23.81	26.81	0.4797
78	15	15	636166	3542.49	DFT-s-OFDM 64 QAM	1@77	23.78	26.78	0.4764
78	15	15	636166	3542.49	DFT-s-OFDM 256 QAM	36@18	21.88	24.88	0.3076
78	15	15	636166	3542.49	DFT-s-OFDM 256 QAM	1@1	21.53	24.53	0.2838
78	15	15	636166	3542.49	DFT-s-OFDM 256 QAM	1@77	21.6	24.6	0.2884
78	15	15	636166	3542.49	CP-OFDM QPSK	39@19	25	28	0.6310
78	15	15	636166	3542.49	CP-OFDM QPSK	1@1	24.94	27.94	0.6223
78	15	15	636166	3542.49	CP-OFDM QPSK	1@77	25	28	0.6310
78	15	20	630667	3460.005	DFT-s-OFDM PI/2 BPSK	50@25	26.66	29.66	0.9247
78	15	20	630667	3460.005	DFT-s-OFDM PI/2 BPSK	1@1	26.53	29.53	0.8974
78	15	20	630667	3460.005	DFT-s-OFDM PI/2 BPSK	1@104	26.43	29.43	0.8770
78	15	20	630667	3460.005	DFT-s-OFDM QPSK	50@25	26.67	29.67	0.9268
78	15	20	630667	3460.005	DFT-s-OFDM QPSK	1@1	26.65	29.65	0.9226
78	15	20	630667	3460.005	DFT-s-OFDM QPSK	1@104	26.63	29.63	0.9183
78	15	20	630667	3460.005	DFT-s-OFDM 16 QAM	50@25	25.65	28.65	0.7328
78	15	20	630667	3460.005	DFT-s-OFDM 16 QAM	1@1	25.55	28.55	0.7161
78	15	20	630667	3460.005	DFT-s-OFDM 16 QAM	1@104	25.5	28.5	0.7079
78	15	20	630667	3460.005	DFT-s-OFDM 64 QAM	50@25	24.17	27.17	0.5212
78	15	20	630667	3460.005	DFT-s-OFDM 64 QAM	1@1	24.06	27.06	0.5082
78	15	20	630667	3460.005	DFT-s-OFDM 64 QAM	1@104	24.28	27.28	0.5346
78	15	20	630667	3460.005	DFT-s-OFDM 256 QAM	50@25	22.13	25.13	0.3258
78	15	20	630667	3460.005	DFT-s-OFDM 256 QAM	1@1	22.21	25.21	0.3319
78	15	20	630667	3460.005	DFT-s-OFDM 256 QAM	1@104	22.16	25.16	0.3281
78	15	20	630667	3460.005	CP-OFDM QPSK	53@26	25.16	28.16	0.6546
78	15	20	630667	3460.005	CP-OFDM QPSK	1@1	25.09	28.09	0.6442
78	15	20	630667	3460.005	CP-OFDM QPSK	1@104	25.02	28.02	0.6339
78	15	20	633334	3500.01	DFT-s-OFDM PI/2 BPSK	50@25	26.28	29.28	0.8472
78	15	20	633334	3500.01	DFT-s-OFDM PI/2 BPSK	1@1	26.11	29.11	0.8147
78	15	20	633334	3500.01	DFT-s-OFDM PI/2 BPSK	1@104	26.25	29.25	0.8414
78	15	20	633334	3500.01	DFT-s-OFDM QPSK	50@25	26.33	29.33	0.8570
78	15	20	633334	3500.01	DFT-s-OFDM QPSK	1@1	26.18	29.18	0.8279
78	15	20	633334	3500.01	DFT-s-OFDM QPSK	1@104	26.22	29.22	0.8356
78	15	20	633334	3500.01	DFT-s-OFDM 16 QAM	50@25	25.32	28.32	0.6792
78	15	20	633334	3500.01	DFT-s-OFDM 16 QAM	1@1	24.84	27.84	0.6081
78	15	20	633334	3500.01	DFT-s-OFDM 16 QAM	1@104	25.48	28.48	0.7047

78	15	20	633334	3500.01	DFT-s-OFDM 64 QAM	50@25	23.81	26.81	0.4797
78	15	20	633334	3500.01	DFT-s-OFDM 64 QAM	1@1	23.53	26.53	0.4498
78	15	20	633334	3500.01	DFT-s-OFDM 64 QAM	1@104	23.52	26.52	0.4487
78	15	20	633334	3500.01	DFT-s-OFDM 256 QAM	50@25	21.69	24.69	0.2944
78	15	20	633334	3500.01	DFT-s-OFDM 256 QAM	1@1	21.28	24.28	0.2679
78	15	20	633334	3500.01	DFT-s-OFDM 256 QAM	1@104	21.32	24.32	0.2704
78	15	20	633334	3500.01	CP-OFDM QPSK	53@26	24.71	27.71	0.5902
78	15	20	633334	3500.01	CP-OFDM QPSK	1@1	24.57	27.57	0.5715
78	15	20	633334	3500.01	CP-OFDM QPSK	1@104	24.6	27.6	0.5754
78	15	20	636000	3540	DFT-s-OFDM PI/2 BPSK	50@25	26.52	29.52	0.8954
78	15	20	636000	3540	DFT-s-OFDM PI/2 BPSK	1@1	26.37	29.37	0.8650
78	15	20	636000	3540	DFT-s-OFDM PI/2 BPSK	1@104	26.4	29.4	0.8710
78	15	20	636000	3540	DFT-s-OFDM QPSK	50@25	26.5	29.5	0.8913
78	15	20	636000	3540	DFT-s-OFDM QPSK	1@1	26.37	29.37	0.8650
78	15	20	636000	3540	DFT-s-OFDM QPSK	1@104	26.47	29.47	0.8851
78	15	20	636000	3540	DFT-s-OFDM 16 QAM	50@25	25.52	28.52	0.7112
78	15	20	636000	3540	DFT-s-OFDM 16 QAM	1@1	25.62	28.62	0.7278
78	15	20	636000	3540	DFT-s-OFDM 16 QAM	1@104	25.65	28.65	0.7328
78	15	20	636000	3540	DFT-s-OFDM 64 QAM	50@25	24.06	27.06	0.5082
78	15	20	636000	3540	DFT-s-OFDM 64 QAM	1@1	23.68	26.68	0.4656
78	15	20	636000	3540	DFT-s-OFDM 64 QAM	1@104	23.74	26.74	0.4721
78	15	20	636000	3540	DFT-s-OFDM 256 QAM	50@25	21.87	24.87	0.3069
78	15	20	636000	3540	DFT-s-OFDM 256 QAM	1@1	21.47	24.47	0.2799
78	15	20	636000	3540	DFT-s-OFDM 256 QAM	1@104	21.52	24.52	0.2831
78	15	20	636000	3540	CP-OFDM QPSK	53@26	25.01	28.01	0.6324
78	15	20	636000	3540	CP-OFDM QPSK	1@1	24.79	27.79	0.6012
78	15	20	636000	3540	CP-OFDM QPSK	1@104	24.73	27.73	0.5929

NR Band	SCS (kHz)	Bandwidth (MHz)	Arfcn	Freq (MHz)	Modulation	RB	Conducted Power(dBm)	EIRP (dBm)	EIRP (W)
78	30	10	630334	3455.01	DFT-s-OFDM PI/2 BPSK	12@6	26.79	29.79	0.9528
78	30	10	630334	3455.01	DFT-s-OFDM PI/2 BPSK	1@1	26.7	29.7	0.9333
78	30	10	630334	3455.01	DFT-s-OFDM PI/2 BPSK	1@22	26.62	29.62	0.9162
78	30	10	630334	3455.01	DFT-s-OFDM QPSK	12@6	26.84	29.84	0.9638
78	30	10	630334	3455.01	DFT-s-OFDM QPSK	1@1	26.72	29.72	0.9376
78	30	10	630334	3455.01	DFT-s-OFDM QPSK	1@22	26.68	29.68	0.9290
78	30	10	630334	3455.01	DFT-s-OFDM 16 QAM	12@6	25.76	28.76	0.7516
78	30	10	630334	3455.01	DFT-s-OFDM 16 QAM	1@1	25.69	28.69	0.7396
78	30	10	630334	3455.01	DFT-s-OFDM 16 QAM	1@22	25.56	28.56	0.7178
78	30	10	630334	3455.01	DFT-s-OFDM 64 QAM	12@6	24.28	27.28	0.5346
78	30	10	630334	3455.01	DFT-s-OFDM 64 QAM	1@1	24.47	27.47	0.5585
78	30	10	630334	3455.01	DFT-s-OFDM 64 QAM	1@22	24.1	27.1	0.5129
78	30	10	630334	3455.01	DFT-s-OFDM 256 QAM	12@6	22.28	25.28	0.3373
78	30	10	630334	3455.01	DFT-s-OFDM 256 QAM	1@1	22.14	25.14	0.3266
78	30	10	630334	3455.01	DFT-s-OFDM 256 QAM	1@22	22.03	25.03	0.3184
78	30	10	630334	3455.01	CP-OFDM QPSK	12@6	24.99	27.99	0.6295
78	30	10	630334	3455.01	CP-OFDM QPSK	1@1	25.29	28.29	0.6745
78	30	10	630334	3455.01	CP-OFDM QPSK	1@22	25.15	28.15	0.6531
78	30	10	633334	3500.01	DFT-s-OFDM PI/2 BPSK	12@6	26.7	29.7	0.9333
78	30	10	633334	3500.01	DFT-s-OFDM PI/2 BPSK	1@1	26.6	29.6	0.9120
78	30	10	633334	3500.01	DFT-s-OFDM PI/2 BPSK	1@22	26.51	29.51	0.8933
78	30	10	633334	3500.01	DFT-s-OFDM QPSK	12@6	26.69	29.69	0.9311
78	30	10	633334	3500.01	DFT-s-OFDM QPSK	1@1	26.64	29.64	0.9204
78	30	10	633334	3500.01	DFT-s-OFDM QPSK	1@22	26.53	29.53	0.8974
78	30	10	633334	3500.01	DFT-s-OFDM 16 QAM	12@6	25.67	28.67	0.7362
78	30	10	633334	3500.01	DFT-s-OFDM 16 QAM	1@1	25.71	28.71	0.7430
78	30	10	633334	3500.01	DFT-s-OFDM 16 QAM	1@22	25.64	28.64	0.7311
78	30	10	633334	3500.01	DFT-s-OFDM 64 QAM	12@6	24.17	27.17	0.5212
78	30	10	633334	3500.01	DFT-s-OFDM 64 QAM	1@1	24.3	27.3	0.5370
78	30	10	633334	3500.01	DFT-s-OFDM 64 QAM	1@22	24.08	27.08	0.5105
78	30	10	633334	3500.01	DFT-s-OFDM 256 QAM	12@6	22.18	25.18	0.3296
78	30	10	633334	3500.01	DFT-s-OFDM 256 QAM	1@1	22.29	25.29	0.3381
78	30	10	633334	3500.01	DFT-s-OFDM	1@22	21.74	24.74	0.2979

					256 QAM				
78	30	10	633334	3500.01	CP-OFDM QPSK	12@6	25.03	28.03	0.6353
78	30	10	633334	3500.01	CP-OFDM QPSK	1@1	25.31	28.31	0.6776
78	30	10	633334	3500.01	CP-OFDM QPSK	1@22	25.08	28.08	0.6427
78	30	10	636332	3544.98	DFT-s-OFDM PI/2 BPSK	12@6	26.5	29.5	0.8913
78	30	10	636332	3544.98	DFT-s-OFDM PI/2 BPSK	1@1	26.47	29.47	0.8851
78	30	10	636332	3544.98	DFT-s-OFDM PI/2 BPSK	1@22	26.44	29.44	0.8790
78	30	10	636332	3544.98	DFT-s-OFDM QPSK	12@6	26.51	29.51	0.8933
78	30	10	636332	3544.98	DFT-s-OFDM QPSK	1@1	26.51	29.51	0.8933
78	30	10	636332	3544.98	DFT-s-OFDM QPSK	1@22	26.43	29.43	0.8770
78	30	10	636332	3544.98	DFT-s-OFDM 16 QAM	12@6	25.54	28.54	0.7145
78	30	10	636332	3544.98	DFT-s-OFDM 16 QAM	1@1	25.54	28.54	0.7145
78	30	10	636332	3544.98	DFT-s-OFDM 16 QAM	1@22	25.46	28.46	0.7015
78	30	10	636332	3544.98	DFT-s-OFDM 64 QAM	12@6	24.07	27.07	0.5093
78	30	10	636332	3544.98	DFT-s-OFDM 64 QAM	1@1	24.23	27.23	0.5284
78	30	10	636332	3544.98	DFT-s-OFDM 64 QAM	1@22	23.82	26.82	0.4808
78	30	10	636332	3544.98	DFT-s-OFDM 256 QAM	12@6	22.08	25.08	0.3221
78	30	10	636332	3544.98	DFT-s-OFDM 256 QAM	1@1	22.05	25.05	0.3199
78	30	10	636332	3544.98	DFT-s-OFDM 256 QAM	1@22	21.77	24.77	0.2999
78	30	10	636332	3544.98	CP-OFDM QPSK	12@6	25.08	28.08	0.6427
78	30	10	636332	3544.98	CP-OFDM QPSK	1@1	25.2	28.2	0.6607
78	30	10	636332	3544.98	CP-OFDM QPSK	1@22	25.01	28.01	0.6324
78	30	15	630500	3457.5	DFT-s-OFDM PI/2 BPSK	18@9	26.83	29.83	0.9616
78	30	15	630500	3457.5	DFT-s-OFDM PI/2 BPSK	1@1	26.75	29.75	0.9441
78	30	15	630500	3457.5	DFT-s-OFDM PI/2 BPSK	1@36	26.65	29.65	0.9226
78	30	15	630500	3457.5	DFT-s-OFDM QPSK	18@9	26.7	29.7	0.9333
78	30	15	630500	3457.5	DFT-s-OFDM QPSK	1@1	26.73	29.73	0.9397
78	30	15	630500	3457.5	DFT-s-OFDM QPSK	1@36	26.72	29.72	0.9376
78	30	15	630500	3457.5	DFT-s-OFDM 16 QAM	18@9	25.85	28.85	0.7674
78	30	15	630500	3457.5	DFT-s-OFDM 16 QAM	1@1	25.62	28.62	0.7278
78	30	15	630500	3457.5	DFT-s-OFDM 16 QAM	1@36	25.72	28.72	0.7447
78	30	15	630500	3457.5	DFT-s-OFDM 64 QAM	18@9	24.33	27.33	0.5408
78	30	15	630500	3457.5	DFT-s-OFDM 64 QAM	1@1	24.45	27.45	0.5559
78	30	15	630500	3457.5	DFT-s-OFDM 64 QAM	1@36	24.39	27.39	0.5483

78	30	15	630500	3457.5	DFT-s-OFDM 256 QAM	18@9	22.32	25.32	0.3404
78	30	15	630500	3457.5	DFT-s-OFDM 256 QAM	1@1	22.01	25.01	0.3170
78	30	15	630500	3457.5	DFT-s-OFDM 256 QAM	1@36	21.96	24.96	0.3133
78	30	15	630500	3457.5	CP-OFDM QPSK	19@9	25.34	28.34	0.6823
78	30	15	630500	3457.5	CP-OFDM QPSK	1@1	25.34	28.34	0.6823
78	30	15	630500	3457.5	CP-OFDM QPSK	1@36	25.27	28.27	0.6714
78	30	15	633334	3500.01	DFT-s-OFDM PI/2 BPSK	18@9	26.61	29.61	0.9141
78	30	15	633334	3500.01	DFT-s-OFDM PI/2 BPSK	1@1	26.53	29.53	0.8974
78	30	15	633334	3500.01	DFT-s-OFDM PI/2 BPSK	1@36	26.51	29.51	0.8933
78	30	15	633334	3500.01	DFT-s-OFDM QPSK	18@9	26.66	29.66	0.9247
78	30	15	633334	3500.01	DFT-s-OFDM QPSK	1@1	26.55	29.55	0.9016
78	30	15	633334	3500.01	DFT-s-OFDM QPSK	1@36	26.54	29.54	0.8995
78	30	15	633334	3500.01	DFT-s-OFDM 16 QAM	18@9	25.65	28.65	0.7328
78	30	15	633334	3500.01	DFT-s-OFDM 16 QAM	1@1	25.67	28.67	0.7362
78	30	15	633334	3500.01	DFT-s-OFDM 16 QAM	1@36	25.64	28.64	0.7311
78	30	15	633334	3500.01	DFT-s-OFDM 64 QAM	18@9	24.16	27.16	0.5200
78	30	15	633334	3500.01	DFT-s-OFDM 64 QAM	1@1	23.98	26.98	0.4989
78	30	15	633334	3500.01	DFT-s-OFDM 64 QAM	1@36	24.04	27.04	0.5058
78	30	15	633334	3500.01	DFT-s-OFDM 256 QAM	18@9	22.16	25.16	0.3281
78	30	15	633334	3500.01	DFT-s-OFDM 256 QAM	1@1	22.19	25.19	0.3304
78	30	15	633334	3500.01	DFT-s-OFDM 256 QAM	1@36	21.83	24.83	0.3041
78	30	15	633334	3500.01	CP-OFDM QPSK	19@9	25.24	28.24	0.6668
78	30	15	633334	3500.01	CP-OFDM QPSK	1@1	25.2	28.2	0.6607
78	30	15	633334	3500.01	CP-OFDM QPSK	1@36	25.12	28.12	0.6486
78	30	15	636166	3542.49	DFT-s-OFDM PI/2 BPSK	18@9	26.54	29.54	0.8995
78	30	15	636166	3542.49	DFT-s-OFDM PI/2 BPSK	1@1	26.48	29.48	0.8872
78	30	15	636166	3542.49	DFT-s-OFDM PI/2 BPSK	1@36	26.37	29.37	0.8650
78	30	15	636166	3542.49	DFT-s-OFDM QPSK	18@9	26.56	29.56	0.9036
78	30	15	636166	3542.49	DFT-s-OFDM QPSK	1@1	26.44	29.44	0.8790
78	30	15	636166	3542.49	DFT-s-OFDM QPSK	1@36	26.34	29.34	0.8590
78	30	15	636166	3542.49	DFT-s-OFDM 16 QAM	18@9	25.64	28.64	0.7311
78	30	15	636166	3542.49	DFT-s-OFDM 16 QAM	1@1	25.5	28.5	0.7079
78	30	15	636166	3542.49	DFT-s-OFDM 16 QAM	1@36	25.54	28.54	0.7145
78	30	15	636166	3542.49	DFT-s-OFDM 64 QAM	18@9	24.1	27.1	0.5129

78	30	15	636166	3542.49	DFT-s-OFDM 64 QAM	1@1	24.22	27.22	0.5272
78	30	15	636166	3542.49	DFT-s-OFDM 64 QAM	1@36	24.05	27.05	0.5070
78	30	15	636166	3542.49	DFT-s-OFDM 256 QAM	18@9	22.03	25.03	0.3184
78	30	15	636166	3542.49	DFT-s-OFDM 256 QAM	1@1	21.79	24.79	0.3013
78	30	15	636166	3542.49	DFT-s-OFDM 256 QAM	1@36	21.66	24.66	0.2924
78	30	15	636166	3542.49	CP-OFDM QPSK	19@9	25.29	28.29	0.6745
78	30	15	636166	3542.49	CP-OFDM QPSK	1@1	25.13	28.13	0.6501
78	30	15	636166	3542.49	CP-OFDM QPSK	1@36	24.84	27.84	0.6081
78	30	20	630668	3460.02	DFT-s-OFDM PI/2 BPSK	25@12	26.81	29.81	0.9572
78	30	20	630668	3460.02	DFT-s-OFDM PI/2 BPSK	1@1	26.66	29.66	0.9247
78	30	20	630668	3460.02	DFT-s-OFDM PI/2 BPSK	1@49	26.63	29.63	0.9183
78	30	20	630668	3460.02	DFT-s-OFDM QPSK	25@12	26.83	29.83	0.9616
78	30	20	630668	3460.02	DFT-s-OFDM QPSK	1@1	26.71	29.71	0.9354
78	30	20	630668	3460.02	DFT-s-OFDM QPSK	1@49	26.66	29.66	0.9247
78	30	20	630668	3460.02	DFT-s-OFDM 16 QAM	25@12	25.86	28.86	0.7691
78	30	20	630668	3460.02	DFT-s-OFDM 16 QAM	1@1	25.58	28.58	0.7211
78	30	20	630668	3460.02	DFT-s-OFDM 16 QAM	1@49	25.64	28.64	0.7311
78	30	20	630668	3460.02	DFT-s-OFDM 64 QAM	25@12	24.24	27.24	0.5297
78	30	20	630668	3460.02	DFT-s-OFDM 64 QAM	1@1	24.15	27.15	0.5188
78	30	20	630668	3460.02	DFT-s-OFDM 64 QAM	1@49	24.03	27.03	0.5047
78	30	20	630668	3460.02	DFT-s-OFDM 256 QAM	25@12	22.24	25.24	0.3342
78	30	20	630668	3460.02	DFT-s-OFDM 256 QAM	1@1	21.97	24.97	0.3141
78	30	20	630668	3460.02	DFT-s-OFDM 256 QAM	1@49	21.93	24.93	0.3112
78	30	20	630668	3460.02	CP-OFDM QPSK	25@121	23.8	26.8	0.4786
78	30	20	630668	3460.02	CP-OFDM QPSK	1@1	25.26	28.26	0.6699
78	30	20	630668	3460.02	CP-OFDM QPSK	1@49	25.27	28.27	0.6714
78	30	20	633334	3500.01	DFT-s-OFDM PI/2 BPSK	25@12	26.63	29.63	0.9183
78	30	20	633334	3500.01	DFT-s-OFDM PI/2 BPSK	1@1	26.44	29.44	0.8790
78	30	20	633334	3500.01	DFT-s-OFDM PI/2 BPSK	1@49	26.47	29.47	0.8851
78	30	20	633334	3500.01	DFT-s-OFDM QPSK	25@12	26.69	29.69	0.9311
78	30	20	633334	3500.01	DFT-s-OFDM QPSK	1@1	26.53	29.53	0.8974
78	30	20	633334	3500.01	DFT-s-OFDM QPSK	1@49	26.41	29.41	0.8730
78	30	20	633334	3500.01	DFT-s-OFDM 16 QAM	25@12	25.62	28.62	0.7278
78	30	20	633334	3500.01	DFT-s-OFDM 16 QAM	1@1	25.41	28.41	0.6934

78	30	20	633334	3500.01	DFT-s-OFDM 16 QAM	1@49	25.41	28.41	0.6934
78	30	20	633334	3500.01	DFT-s-OFDM 64 QAM	25@12	24.21	27.21	0.5260
78	30	20	633334	3500.01	DFT-s-OFDM 64 QAM	1@1	24.21	27.21	0.5260
78	30	20	633334	3500.01	DFT-s-OFDM 64 QAM	1@49	23.83	26.83	0.4819
78	30	20	633334	3500.01	DFT-s-OFDM 256 QAM	25@12	22.15	25.15	0.3273
78	30	20	633334	3500.01	DFT-s-OFDM 256 QAM	1@1	21.99	24.99	0.3155
78	30	20	633334	3500.01	DFT-s-OFDM 256 QAM	1@49	22.05	25.05	0.3199
78	30	20	633334	3500.01	CP-OFDM QPSK	25@121	23.65	26.65	0.4624
78	30	20	633334	3500.01	CP-OFDM QPSK	1@1	25.13	28.13	0.6501
78	30	20	633334	3500.01	CP-OFDM QPSK	1@49	25.05	28.05	0.6383
78	30	20	636000	3540	DFT-s-OFDM PI/2 BPSK	25@12	26.58	29.58	0.9078
78	30	20	636000	3540	DFT-s-OFDM PI/2 BPSK	1@1	26.5	29.5	0.8913
78	30	20	636000	3540	DFT-s-OFDM PI/2 BPSK	1@49	26.28	29.28	0.8472
78	30	20	636000	3540	DFT-s-OFDM QPSK	25@12	26.62	29.62	0.9162
78	30	20	636000	3540	DFT-s-OFDM QPSK	1@1	26.5	29.5	0.8913
78	30	20	636000	3540	DFT-s-OFDM QPSK	1@49	26.31	29.31	0.8531
78	30	20	636000	3540	DFT-s-OFDM 16 QAM	25@12	25.48	28.48	0.7047
78	30	20	636000	3540	DFT-s-OFDM 16 QAM	1@1	25.55	28.55	0.7161
78	30	20	636000	3540	DFT-s-OFDM 16 QAM	1@49	25.29	28.29	0.6745
78	30	20	636000	3540	DFT-s-OFDM 64 QAM	25@12	23.99	26.99	0.5000
78	30	20	636000	3540	DFT-s-OFDM 64 QAM	1@1	23.94	26.94	0.4943
78	30	20	636000	3540	DFT-s-OFDM 64 QAM	1@49	23.99	26.99	0.5000
78	30	20	636000	3540	DFT-s-OFDM 256 QAM	25@12	22.07	25.07	0.3214
78	30	20	636000	3540	DFT-s-OFDM 256 QAM	1@1	21.69	24.69	0.2944
78	30	20	636000	3540	DFT-s-OFDM 256 QAM	1@49	21.56	24.56	0.2858
78	30	20	636000	3540	CP-OFDM QPSK	25@121	23.58	26.58	0.4550
78	30	20	636000	3540	CP-OFDM QPSK	1@1	25.05	28.05	0.6383
78	30	20	636000	3540	CP-OFDM QPSK	1@49	24.98	27.98	0.6281
78	30	40	631334	3470.01	DFT-s-OFDM PI/2 BPSK	50@25	26.78	29.78	0.9506
78	30	40	631334	3470.01	DFT-s-OFDM PI/2 BPSK	1@1	26.41	29.41	0.8730
78	30	40	631334	3470.01	DFT-s-OFDM PI/2 BPSK	1@104	26.22	29.22	0.8356
78	30	40	631334	3470.01	DFT-s-OFDM QPSK	50@25	26.77	29.77	0.9484
78	30	40	631334	3470.01	DFT-s-OFDM QPSK	1@1	26.34	29.34	0.8590
78	30	40	631334	3470.01	DFT-s-OFDM QPSK	1@104	26.15	29.15	0.8222

78	30	40	631334	3470.01	DFT-s-OFDM 16 QAM	50@25	25.75	28.75	0.7499
78	30	40	631334	3470.01	DFT-s-OFDM 16 QAM	1@1	25.37	28.37	0.6871
78	30	40	631334	3470.01	DFT-s-OFDM 16 QAM	1@104	25.39	28.39	0.6902
78	30	40	631334	3470.01	DFT-s-OFDM 64 QAM	50@25	24.32	27.32	0.5395
78	30	40	631334	3470.01	DFT-s-OFDM 64 QAM	1@1	23.94	26.94	0.4943
78	30	40	631334	3470.01	DFT-s-OFDM 64 QAM	1@104	23.59	26.59	0.4560
78	30	40	631334	3470.01	DFT-s-OFDM 256 QAM	50@25	22.36	25.36	0.3436
78	30	40	631334	3470.01	DFT-s-OFDM 256 QAM	1@1	21.62	24.62	0.2897
78	30	40	631334	3470.01	DFT-s-OFDM 256 QAM	1@104	21.88	24.88	0.3076
78	30	40	631334	3470.01	CP-OFDM QPSK	53@26	25.21	28.21	0.6622
78	30	40	631334	3470.01	CP-OFDM QPSK	1@1	25.03	28.03	0.6353
78	30	40	631334	3470.01	CP-OFDM QPSK	1@104	24.9	27.9	0.6166
78	30	40	633334	3500.01	DFT-s-OFDM PI/2 BPSK	50@25	26.72	29.72	0.9376
78	30	40	633334	3500.01	DFT-s-OFDM PI/2 BPSK	1@1	26.23	29.23	0.8375
78	30	40	633334	3500.01	DFT-s-OFDM PI/2 BPSK	1@104	26.22	29.22	0.8356
78	30	40	633334	3500.01	DFT-s-OFDM QPSK	50@25	26.7	29.7	0.9333
78	30	40	633334	3500.01	DFT-s-OFDM QPSK	1@1	26.27	29.27	0.8453
78	30	40	633334	3500.01	DFT-s-OFDM QPSK	1@104	26.2	29.2	0.8318
78	30	40	633334	3500.01	DFT-s-OFDM 16 QAM	50@25	25.69	28.69	0.7396
78	30	40	633334	3500.01	DFT-s-OFDM 16 QAM	1@1	25.16	28.16	0.6546
78	30	40	633334	3500.01	DFT-s-OFDM 16 QAM	1@104	25.11	28.11	0.6471
78	30	40	633334	3500.01	DFT-s-OFDM 64 QAM	50@25	24.18	27.18	0.5224
78	30	40	633334	3500.01	DFT-s-OFDM 64 QAM	1@1	23.92	26.92	0.4920
78	30	40	633334	3500.01	DFT-s-OFDM 64 QAM	1@104	23.89	26.89	0.4887
78	30	40	633334	3500.01	DFT-s-OFDM 256 QAM	50@25	22.26	25.26	0.3357
78	30	40	633334	3500.01	DFT-s-OFDM 256 QAM	1@1	21.89	24.89	0.3083
78	30	40	633334	3500.01	DFT-s-OFDM 256 QAM	1@104	21.51	24.51	0.2825
78	30	40	633334	3500.01	CP-OFDM QPSK	53@26	25.11	28.11	0.6471
78	30	40	633334	3500.01	CP-OFDM QPSK	1@1	24.83	27.83	0.6067
78	30	40	633334	3500.01	CP-OFDM QPSK	1@104	24.85	27.85	0.6095
78	30	40	635332	3529.98	DFT-s-OFDM PI/2 BPSK	50@25	26.57	29.57	0.9057
78	30	40	635332	3529.98	DFT-s-OFDM PI/2 BPSK	1@1	26.25	29.25	0.8414
78	30	40	635332	3529.98	DFT-s-OFDM PI/2 BPSK	1@104	26.02	29.02	0.7980
78	30	40	635332	3529.98	DFT-s-OFDM QPSK	50@25	26.62	29.62	0.9162

78	30	40	635332	3529.98	DFT-s-OFDM QPSK	1@1	26.18	29.18	0.8279
78	30	40	635332	3529.98	DFT-s-OFDM QPSK	1@104	25.98	28.98	0.7907
78	30	40	635332	3529.98	DFT-s-OFDM 16 QAM	50@25	25.64	28.64	0.7311
78	30	40	635332	3529.98	DFT-s-OFDM 16 QAM	1@1	25.36	28.36	0.6855
78	30	40	635332	3529.98	DFT-s-OFDM 16 QAM	1@104	25.22	28.22	0.6637
78	30	40	635332	3529.98	DFT-s-OFDM 64 QAM	50@25	24.11	27.11	0.5140
78	30	40	635332	3529.98	DFT-s-OFDM 64 QAM	1@1	23.55	26.55	0.4519
78	30	40	635332	3529.98	DFT-s-OFDM 64 QAM	1@104	23.72	26.72	0.4699
78	30	40	635332	3529.98	DFT-s-OFDM 256 QAM	50@25	22.15	25.15	0.3273
78	30	40	635332	3529.98	DFT-s-OFDM 256 QAM	1@1	21.72	24.72	0.2965
78	30	40	635332	3529.98	DFT-s-OFDM 256 QAM	1@104	21.26	24.26	0.2667
78	30	40	635332	3529.98	CP-OFDM QPSK	53@26	25.08	28.08	0.6427
78	30	40	635332	3529.98	CP-OFDM QPSK	1@1	24.81	27.81	0.6039
78	30	40	635332	3529.98	CP-OFDM QPSK	1@104	24.63	27.63	0.5794
78	30	50	631668	3475.02	DFT-s-OFDM PI/2 BPSK	64@32	26.84	29.84	0.9638
78	30	50	631668	3475.02	DFT-s-OFDM PI/2 BPSK	1@1	26.64	29.64	0.9204
78	30	50	631668	3475.02	DFT-s-OFDM PI/2 BPSK	1@131	26.47	29.47	0.8851
78	30	50	631668	3475.02	DFT-s-OFDM QPSK	64@32	26.82	29.82	0.9594
78	30	50	631668	3475.02	DFT-s-OFDM QPSK	1@1	26.64	29.64	0.9204
78	30	50	631668	3475.02	DFT-s-OFDM QPSK	1@131	26.51	29.51	0.8933
78	30	50	631668	3475.02	DFT-s-OFDM 16 QAM	64@32	25.77	28.77	0.7534
78	30	50	631668	3475.02	DFT-s-OFDM 16 QAM	1@1	25.66	28.66	0.7345
78	30	50	631668	3475.02	DFT-s-OFDM 16 QAM	1@131	25.64	28.64	0.7311
78	30	50	631668	3475.02	DFT-s-OFDM 64 QAM	64@32	24.32	27.32	0.5395
78	30	50	631668	3475.02	DFT-s-OFDM 64 QAM	1@1	24.38	27.38	0.5470
78	30	50	631668	3475.02	DFT-s-OFDM 64 QAM	1@131	24.19	27.19	0.5236
78	30	50	631668	3475.02	DFT-s-OFDM 256 QAM	64@32	22.31	25.31	0.3396
78	30	50	631668	3475.02	DFT-s-OFDM 256 QAM	1@1	22.26	25.26	0.3357
78	30	50	631668	3475.02	DFT-s-OFDM 256 QAM	1@131	21.88	24.88	0.3076
78	30	50	631668	3475.02	CP-OFDM QPSK	67@33	25.35	28.35	0.6839
78	30	50	631668	3475.02	CP-OFDM QPSK	1@1	25.32	28.32	0.6792
78	30	50	631668	3475.02	CP-OFDM QPSK	1@131	25.18	28.18	0.6577
78	30	50	633334	3500.01	DFT-s-OFDM PI/2 BPSK	64@32	26.73	29.73	0.9397
78	30	50	633334	3500.01	DFT-s-OFDM PI/2 BPSK	1@1	26.52	29.52	0.8954

78	30	50	633334	3500.01	DFT-s-OFDM PI/2 BPSK	1@131	26.42	29.42	0.8750
78	30	50	633334	3500.01	DFT-s-OFDM QPSK	64@32	26.74	29.74	0.9419
78	30	50	633334	3500.01	DFT-s-OFDM QPSK	1@1	26.54	29.54	0.8995
78	30	50	633334	3500.01	DFT-s-OFDM QPSK	1@131	26.48	29.48	0.8872
78	30	50	633334	3500.01	DFT-s-OFDM 16 QAM	64@32	25.76	28.76	0.7516
78	30	50	633334	3500.01	DFT-s-OFDM 16 QAM	1@1	25.38	28.38	0.6887
78	30	50	633334	3500.01	DFT-s-OFDM 16 QAM	1@131	25.11	28.11	0.6471
78	30	50	633334	3500.01	DFT-s-OFDM 64 QAM	64@32	24.23	27.23	0.5284
78	30	50	633334	3500.01	DFT-s-OFDM 64 QAM	1@1	23.79	26.79	0.4775
78	30	50	633334	3500.01	DFT-s-OFDM 64 QAM	1@131	23.5	26.5	0.4467
78	30	50	633334	3500.01	DFT-s-OFDM 256 QAM	64@32	22.23	25.23	0.3334
78	30	50	633334	3500.01	DFT-s-OFDM 256 QAM	1@1	22.25	25.25	0.3350
78	30	50	633334	3500.01	DFT-s-OFDM 256 QAM	1@131	22.18	25.18	0.3296
78	30	50	633334	3500.01	CP-OFDM QPSK	67@33	25.18	28.18	0.6577
78	30	50	633334	3500.01	CP-OFDM QPSK	1@1	25.24	28.24	0.6668
78	30	50	633334	3500.01	CP-OFDM QPSK	1@131	25.22	28.22	0.6637
78	30	50	635000	3525	DFT-s-OFDM PI/2 BPSK	64@32	26.64	29.64	0.9204
78	30	50	635000	3525	DFT-s-OFDM PI/2 BPSK	1@1	26.5	29.5	0.8913
78	30	50	635000	3525	DFT-s-OFDM PI/2 BPSK	1@131	26.29	29.29	0.8492
78	30	50	635000	3525	DFT-s-OFDM QPSK	64@32	26.79	29.79	0.9528
78	30	50	635000	3525	DFT-s-OFDM QPSK	1@1	26.52	29.52	0.8954
78	30	50	635000	3525	DFT-s-OFDM QPSK	1@131	26.2	29.2	0.8318
78	30	50	635000	3525	DFT-s-OFDM 16 QAM	64@32	25.76	28.76	0.7516
78	30	50	635000	3525	DFT-s-OFDM 16 QAM	1@1	25.38	28.38	0.6887
78	30	50	635000	3525	DFT-s-OFDM 16 QAM	1@131	24.96	27.96	0.6252
78	30	50	635000	3525	DFT-s-OFDM 64 QAM	64@32	24.28	27.28	0.5346
78	30	50	635000	3525	DFT-s-OFDM 64 QAM	1@1	24.08	27.08	0.5105
78	30	50	635000	3525	DFT-s-OFDM 64 QAM	1@131	23.84	26.84	0.4831
78	30	50	635000	3525	DFT-s-OFDM 256 QAM	64@32	22.16	25.16	0.3281
78	30	50	635000	3525	DFT-s-OFDM 256 QAM	1@1	21.94	24.94	0.3119
78	30	50	635000	3525	DFT-s-OFDM 256 QAM	1@131	21.72	24.72	0.2965
78	30	50	635000	3525	CP-OFDM QPSK	67@33	25.2	28.2	0.6607
78	30	50	635000	3525	CP-OFDM QPSK	1@1	25.15	28.15	0.6531
78	30	50	635000	3525	CP-OFDM QPSK	1@131	24.97	27.97	0.6266

78	30	60	632000	3480	DFT-s-OFDM PI/2 BPSK	81@40	26.78	29.78	0.9506
78	30	60	632000	3480	DFT-s-OFDM PI/2 BPSK	1@1	26.63	29.63	0.9183
78	30	60	632000	3480	DFT-s-OFDM PI/2 BPSK	1@160	26.52	29.52	0.8954
78	30	60	632000	3480	DFT-s-OFDM QPSK	81@40	26.76	29.76	0.9462
78	30	60	632000	3480	DFT-s-OFDM QPSK	1@1	26.7	29.7	0.9333
78	30	60	632000	3480	DFT-s-OFDM QPSK	1@160	26.55	29.55	0.9016
78	30	60	632000	3480	DFT-s-OFDM 16 QAM	81@40	25.74	28.74	0.7482
78	30	60	632000	3480	DFT-s-OFDM 16 QAM	1@1	25.38	28.38	0.6887
78	30	60	632000	3480	DFT-s-OFDM 16 QAM	1@160	25.22	28.22	0.6637
78	30	60	632000	3480	DFT-s-OFDM 64 QAM	81@40	24.28	27.28	0.5346
78	30	60	632000	3480	DFT-s-OFDM 64 QAM	1@1	23.84	26.84	0.4831
78	30	60	632000	3480	DFT-s-OFDM 64 QAM	1@160	23.51	26.51	0.4477
78	30	60	632000	3480	DFT-s-OFDM 256 QAM	81@40	22.47	25.47	0.3524
78	30	60	632000	3480	DFT-s-OFDM 256 QAM	1@1	22.1	25.1	0.3236
78	30	60	632000	3480	DFT-s-OFDM 256 QAM	1@160	21.97	24.97	0.3141
78	30	60	632000	3480	CP-OFDM QPSK	81@40	25.29	28.29	0.6745
78	30	60	632000	3480	CP-OFDM QPSK	1@1	25.29	28.29	0.6745
78	30	60	632000	3480	CP-OFDM QPSK	1@160	25.08	28.08	0.6427
78	30	60	633334	3500.01	DFT-s-OFDM PI/2 BPSK	81@40	26.77	29.77	0.9484
78	30	60	633334	3500.01	DFT-s-OFDM PI/2 BPSK	1@1	26.51	29.51	0.8933
78	30	60	633334	3500.01	DFT-s-OFDM PI/2 BPSK	1@160	26.44	29.44	0.8790
78	30	60	633334	3500.01	DFT-s-OFDM QPSK	81@40	26.76	29.76	0.9462
78	30	60	633334	3500.01	DFT-s-OFDM QPSK	1@1	26.61	29.61	0.9141
78	30	60	633334	3500.01	DFT-s-OFDM QPSK	1@160	26.47	29.47	0.8851
78	30	60	633334	3500.01	DFT-s-OFDM 16 QAM	81@40	25.77	28.77	0.7534
78	30	60	633334	3500.01	DFT-s-OFDM 16 QAM	1@1	25.52	28.52	0.7112
78	30	60	633334	3500.01	DFT-s-OFDM 16 QAM	1@160	25.15	28.15	0.6531
78	30	60	633334	3500.01	DFT-s-OFDM 64 QAM	81@40	24.26	27.26	0.5321
78	30	60	633334	3500.01	DFT-s-OFDM 64 QAM	1@1	23.68	26.68	0.4656
78	30	60	633334	3500.01	DFT-s-OFDM 64 QAM	1@160	23.3	26.3	0.4266
78	30	60	633334	3500.01	DFT-s-OFDM 256 QAM	81@40	22.24	25.24	0.3342
78	30	60	633334	3500.01	DFT-s-OFDM 256 QAM	1@1	21.91	24.91	0.3097
78	30	60	633334	3500.01	DFT-s-OFDM 256 QAM	1@160	21.8	24.8	0.3020
78	30	60	633334	3500.01	CP-OFDM QPSK	81@40	25.18	28.18	0.6577

78	30	60	633334	3500.01	CP-OFDM QPSK	1@1	25.29	28.29	0.6745
78	30	60	633334	3500.01	CP-OFDM QPSK	1@160	25.27	28.27	0.6714
78	30	60	634666	3519.99	DFT-s-OFDM PI/2 BPSK	81@40	26.76	29.76	0.9462
78	30	60	634666	3519.99	DFT-s-OFDM PI/2 BPSK	1@1	26.55	29.55	0.9016
78	30	60	634666	3519.99	DFT-s-OFDM PI/2 BPSK	1@160	26.28	29.28	0.8472
78	30	60	634666	3519.99	DFT-s-OFDM QPSK	81@40	26.73	29.73	0.9397
78	30	60	634666	3519.99	DFT-s-OFDM QPSK	1@1	26.56	29.56	0.9036
78	30	60	634666	3519.99	DFT-s-OFDM QPSK	1@160	26.34	29.34	0.8590
78	30	60	634666	3519.99	DFT-s-OFDM 16 QAM	81@40	25.72	28.72	0.7447
78	30	60	634666	3519.99	DFT-s-OFDM 16 QAM	1@1	25.57	28.57	0.7194
78	30	60	634666	3519.99	DFT-s-OFDM 16 QAM	1@160	25	28	0.6310
78	30	60	634666	3519.99	DFT-s-OFDM 64 QAM	81@40	24.24	27.24	0.5297
78	30	60	634666	3519.99	DFT-s-OFDM 64 QAM	1@1	23.62	26.62	0.4592
78	30	60	634666	3519.99	DFT-s-OFDM 64 QAM	1@160	23.67	26.67	0.4645
78	30	60	634666	3519.99	DFT-s-OFDM 256 QAM	81@40	22.27	25.27	0.3365
78	30	60	634666	3519.99	DFT-s-OFDM 256 QAM	1@1	21.95	24.95	0.3126
78	30	60	634666	3519.99	DFT-s-OFDM 256 QAM	1@160	21.76	24.76	0.2992
78	30	60	634666	3519.99	CP-OFDM QPSK	81@40	25.21	28.21	0.6622
78	30	60	634666	3519.99	CP-OFDM QPSK	1@1	25.16	28.16	0.6546
78	30	60	634666	3519.99	CP-OFDM QPSK	1@160	24.92	27.92	0.6194
78	30	80	632668	3490.02	DFT-s-OFDM PI/2 BPSK	108@54	26.55	29.55	0.9016
78	30	80	632668	3490.02	DFT-s-OFDM PI/2 BPSK	1@1	26.14	29.14	0.8204
78	30	80	632668	3490.02	DFT-s-OFDM PI/2 BPSK	1@215	25.85	28.85	0.7674
78	30	80	632668	3490.02	DFT-s-OFDM QPSK	108@54	26.54	29.54	0.8995
78	30	80	632668	3490.02	DFT-s-OFDM QPSK	1@1	26.21	29.21	0.8337
78	30	80	632668	3490.02	DFT-s-OFDM QPSK	1@215	25.89	28.89	0.7745
78	30	80	632668	3490.02	DFT-s-OFDM 16 QAM	108@54	25.59	28.59	0.7228
78	30	80	632668	3490.02	DFT-s-OFDM 16 QAM	1@1	24.78	27.78	0.5998
78	30	80	632668	3490.02	DFT-s-OFDM 16 QAM	1@215	24.56	27.56	0.5702
78	30	80	632668	3490.02	DFT-s-OFDM 64 QAM	108@54	23.98	26.98	0.4989
78	30	80	632668	3490.02	DFT-s-OFDM 64 QAM	1@1	23.38	26.38	0.4345
78	30	80	632668	3490.02	DFT-s-OFDM 64 QAM	1@215	22.94	25.94	0.3926
78	30	80	632668	3490.02	DFT-s-OFDM 256 QAM	108@54	21.96	24.96	0.3133
78	30	80	632668	3490.02	DFT-s-OFDM 256 QAM	1@1	21.45	24.45	0.2786

78	30	80	632668	3490.02	DFT-s-OFDM 256 QAM	1@215	21.6	24.6	0.2884
78	30	80	632668	3490.02	CP-OFDM QPSK	109@54	24.63	27.63	0.5794
78	30	80	632668	3490.02	CP-OFDM QPSK	1@1	24.61	27.61	0.5768
78	30	80	632668	3490.02	CP-OFDM QPSK	1@215	24.4	27.4	0.5495
78	30	80	633334	3500.01	DFT-s-OFDM PI/2 BPSK	108@54	26.57	29.57	0.9057
78	30	80	633334	3500.01	DFT-s-OFDM PI/2 BPSK	1@1	26.11	29.11	0.8147
78	30	80	633334	3500.01	DFT-s-OFDM PI/2 BPSK	1@215	25.77	28.77	0.7534
78	30	80	633334	3500.01	DFT-s-OFDM QPSK	108@54	26.57	29.57	0.9057
78	30	80	633334	3500.01	DFT-s-OFDM QPSK	1@1	26.3	29.3	0.8511
78	30	80	633334	3500.01	DFT-s-OFDM QPSK	1@215	25.87	28.87	0.7709
78	30	80	633334	3500.01	DFT-s-OFDM 16 QAM	108@54	25.5	28.5	0.7079
78	30	80	633334	3500.01	DFT-s-OFDM 16 QAM	1@1	25.37	28.37	0.6871
78	30	80	633334	3500.01	DFT-s-OFDM 16 QAM	1@215	25.15	28.15	0.6531
78	30	80	633334	3500.01	DFT-s-OFDM 64 QAM	108@54	23.99	26.99	0.5000
78	30	80	633334	3500.01	DFT-s-OFDM 64 QAM	1@1	23.42	26.42	0.4385
78	30	80	633334	3500.01	DFT-s-OFDM 64 QAM	1@215	23.04	26.04	0.4018
78	30	80	633334	3500.01	DFT-s-OFDM 256 QAM	108@54	21.96	24.96	0.3133
78	30	80	633334	3500.01	DFT-s-OFDM 256 QAM	1@1	21.64	24.64	0.2911
78	30	80	633334	3500.01	DFT-s-OFDM 256 QAM	1@215	21.69	24.69	0.2944
78	30	80	633334	3500.01	CP-OFDM QPSK	109@54	25.05	28.05	0.6383
78	30	80	633334	3500.01	CP-OFDM QPSK	1@1	24.7	27.7	0.5888
78	30	80	633334	3500.01	CP-OFDM QPSK	1@215	24.37	27.37	0.5458
78	30	80	634000	3510	DFT-s-OFDM PI/2 BPSK	108@54	26.49	29.49	0.8892
78	30	80	634000	3510	DFT-s-OFDM PI/2 BPSK	1@1	26.14	29.14	0.8204
78	30	80	634000	3510	DFT-s-OFDM PI/2 BPSK	1@215	25.74	28.74	0.7482
78	30	80	634000	3510	DFT-s-OFDM QPSK	108@54	26.53	29.53	0.8974
78	30	80	634000	3510	DFT-s-OFDM QPSK	1@1	26.2	29.2	0.8318
78	30	80	634000	3510	DFT-s-OFDM QPSK	1@215	25.8	28.8	0.7586
78	30	80	634000	3510	DFT-s-OFDM 16 QAM	108@54	25.55	28.55	0.7161
78	30	80	634000	3510	DFT-s-OFDM 16 QAM	1@1	25.46	28.46	0.7015
78	30	80	634000	3510	DFT-s-OFDM 16 QAM	1@215	24.99	27.99	0.6295
78	30	80	634000	3510	DFT-s-OFDM 64 QAM	108@54	23.96	26.96	0.4966
78	30	80	634000	3510	DFT-s-OFDM 64 QAM	1@1	23.66	26.66	0.4634
78	30	80	634000	3510	DFT-s-OFDM 64 QAM	1@215	23.1	26.1	0.4074

78	30	80	634000	3510	DFT-s-OFDM 256 QAM	108@54	22.18	25.18	0.3296
78	30	80	634000	3510	DFT-s-OFDM 256 QAM	1@1	21.31	24.31	0.2698
78	30	80	634000	3510	DFT-s-OFDM 256 QAM	1@215	21.34	24.34	0.2716
78	30	80	634000	3510	CP-OFDM QPSK	109@54	25.01	28.01	0.6324
78	30	80	634000	3510	CP-OFDM QPSK	1@1	24.68	27.68	0.5861
78	30	80	634000	3510	CP-OFDM QPSK	1@215	24.36	27.36	0.5445
78	30	100	633334	3500.01	DFT-s-OFDM PI/2 BPSK	135@67	26.55	29.55	0.9016
78	30	100	633334	3500.01	DFT-s-OFDM PI/2 BPSK	1@1	25.98	28.98	0.7907
78	30	100	633334	3500.01	DFT-s-OFDM PI/2 BPSK	1@271	25.36	28.36	0.6855
78	30	100	633334	3500.01	DFT-s-OFDM QPSK	135@67	26.54	29.54	0.8995
78	30	100	633334	3500.01	DFT-s-OFDM QPSK	1@1	26.06	29.06	0.8054
78	30	100	633334	3500.01	DFT-s-OFDM QPSK	1@271	25.42	28.42	0.6950
78	30	100	633334	3500.01	DFT-s-OFDM 16 QAM	135@67	25.54	28.54	0.7145
78	30	100	633334	3500.01	DFT-s-OFDM 16 QAM	1@1	25.26	28.26	0.6699
78	30	100	633334	3500.01	DFT-s-OFDM 16 QAM	1@271	24.64	27.64	0.5808
78	30	100	633334	3500.01	DFT-s-OFDM 64 QAM	135@67	23.92	26.92	0.4920
78	30	100	633334	3500.01	DFT-s-OFDM 64 QAM	1@1	23.33	26.33	0.4295
78	30	100	633334	3500.01	DFT-s-OFDM 64 QAM	1@271	22.73	25.73	0.3741
78	30	100	633334	3500.01	DFT-s-OFDM 256 QAM	135@67	21.95	24.95	0.3126
78	30	100	633334	3500.01	DFT-s-OFDM 256 QAM	1@1	21.09	24.09	0.2564
78	30	100	633334	3500.01	DFT-s-OFDM 256 QAM	1@271	21	24	0.2512
78	30	100	633334	3500.01	CP-OFDM QPSK	137@68	24.97	27.97	0.6266
78	30	100	633334	3500.01	CP-OFDM QPSK	1@1	24.42	27.42	0.5521
78	30	100	633334	3500.01	CP-OFDM QPSK	1@271	23.99	26.99	0.5000

FR1 n77 UL-MIMO(15kHz)

Peak-to-Average Ratio

Mode	FR1 UL-MIMO n77 / 20MHz / CP-OFDM (Port 1)				
Mod.	QPSK	QPSK			Limit: 13dB
RB Size	1RB	Full RB			Result
Lowest CH	7.77	8.32			PASS
Middle CH	7.83	8.29			
Highest CH	7.77	8.26			

Mode	FR1 UL-MIMO n77 / 20MHz / CP-OFDM (Port 2)				
Mod.	QPSK	QPSK			Limit: 13dB
RB Size	1RB	Full RB			Result
Lowest CH	7.25	8.09			PASS
Middle CH	7.28	7.77			
Highest CH	6.96	7.88			

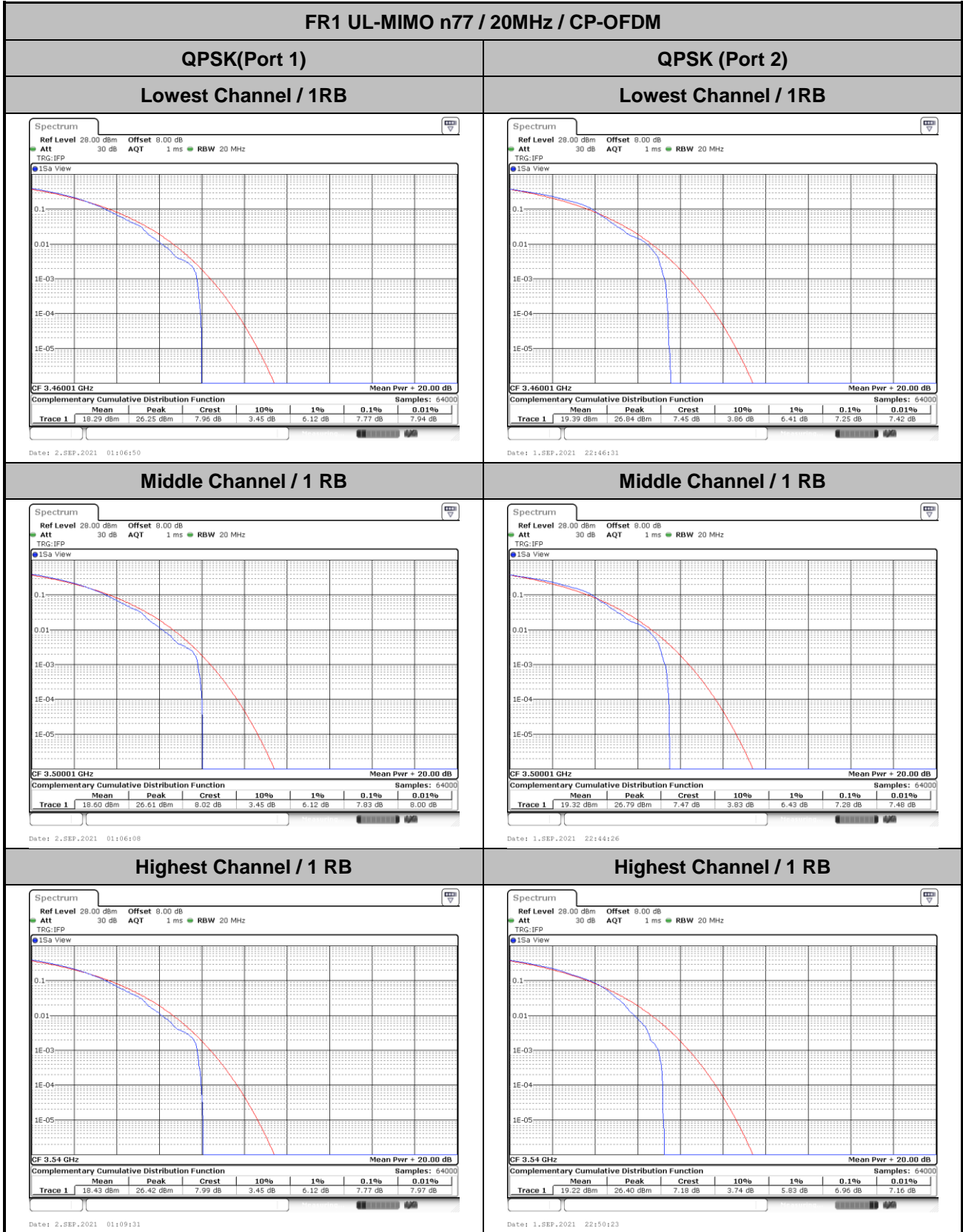

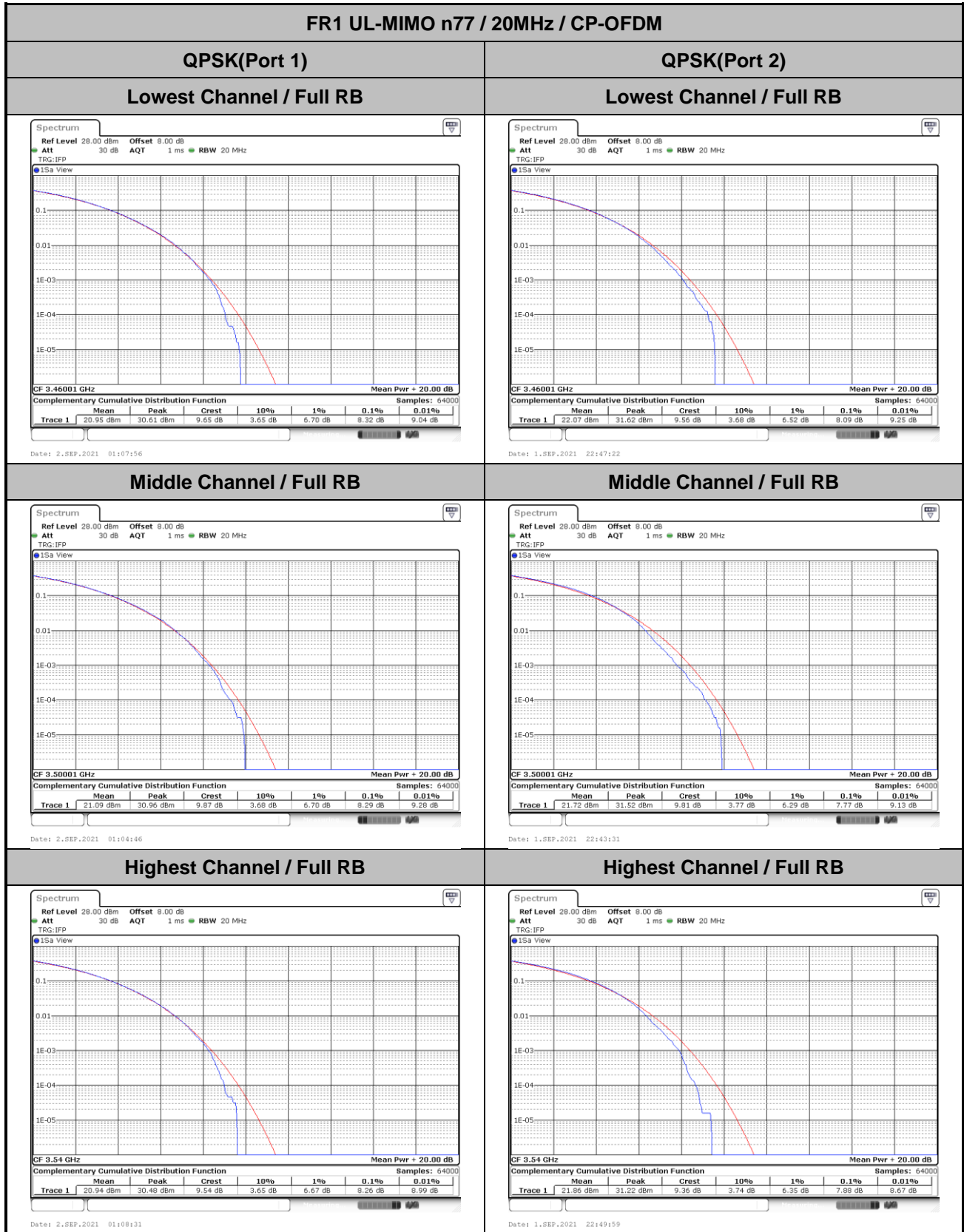



26dB Bandwidth

Mode	FR1 UL-MIMO n77 : 26dB BW(MHz) / CP-OFDM							
	Port 1				Port 2			
BW	10MHz	10MHz	10MHz	10MHz	10MHz	10MHz	10MHz	10MHz
Mod.	QPSK	16QAM	64QAM	256QAM	QPSK	16QAM	64QAM	256QAM
Middle CH	9.81	9.67	9.71	9.75	9.87	9.71	9.79	9.61

Mode	FR1 UL-MIMO n77 : 26dB BW(MHz) / CP-OFDM							
	Port 1				Port 2			
BW	15MHz	15MHz	15MHz	15MHz	15MHz	15MHz	15MHz	15MHz
Mod.	QPSK	16QAM	64QAM	256QAM	QPSK	16QAM	64QAM	256QAM
Middle CH	14.87	14.84	14.87	14.87	14.87	14.93	14.84	14.87

Mode	FR1 UL-MIMO n77 : 26dB BW(MHz) / CP-OFDM							
	Port 1				Port 2			
BW	20MHz	20MHz	20MHz	20MHz	20MHz	20MHz	20MHz	20MHz
Mod.	QPSK	16QAM	64QAM	256QAM	QPSK	16QAM	64QAM	256QAM
Middle CH	19.82	19.86	19.82	19.66	19.74	19.70	19.82	19.78

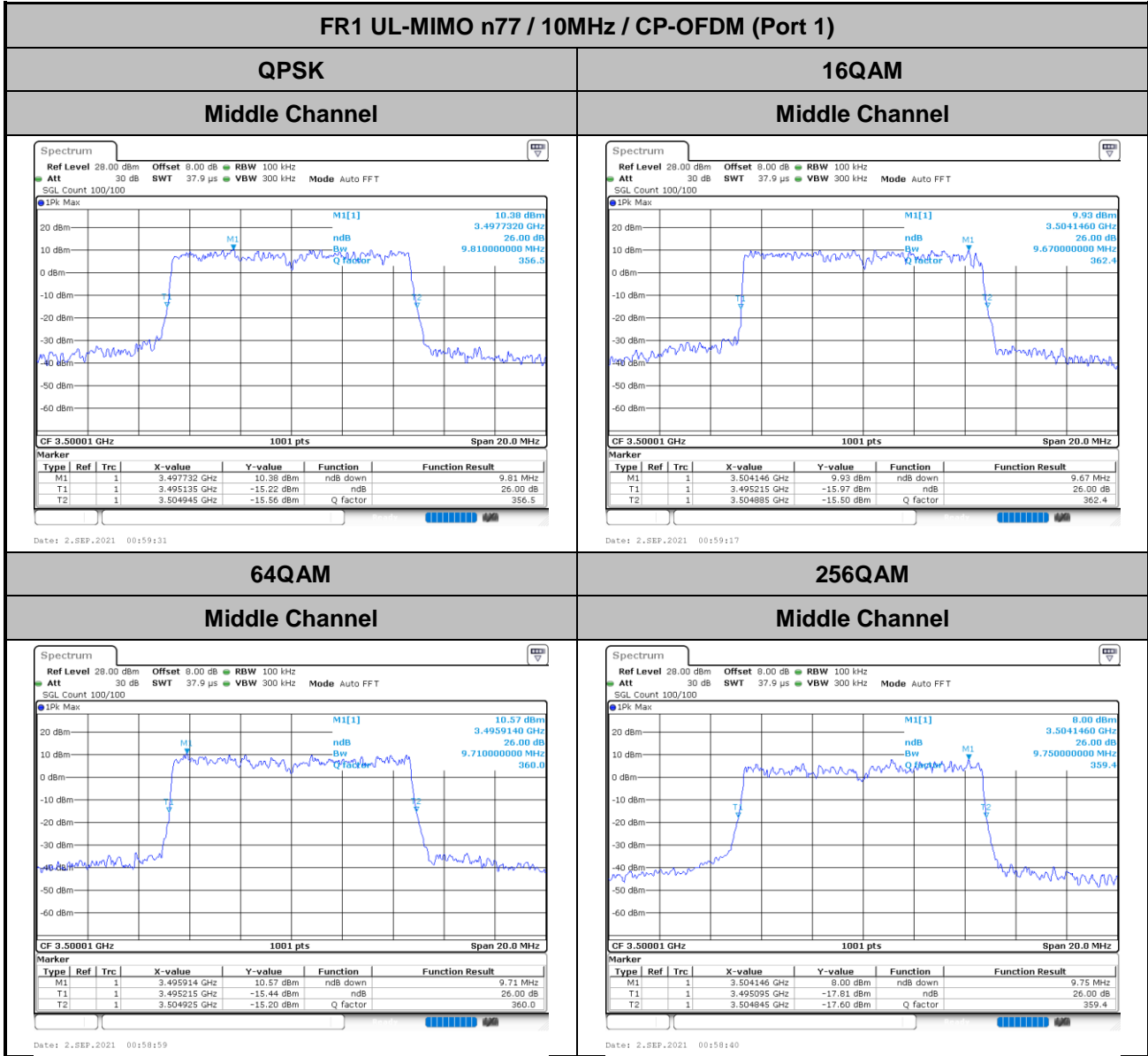

FR1 UL-MIMO n77 / 10MHz / CP-OFDM (Port 2)

QPSK

16QAM

Middle Channel

Middle Channel

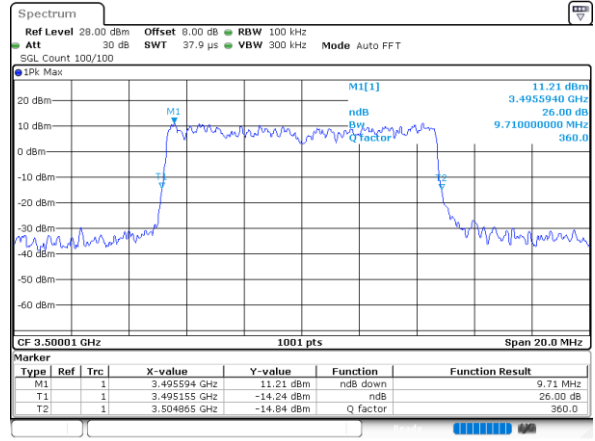
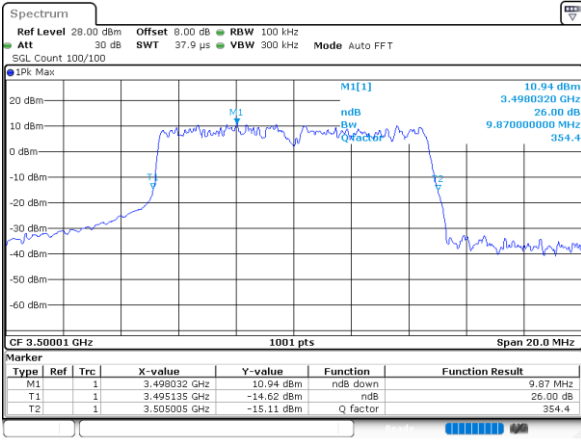

64QAM

256QAM

Middle Channel

Middle Channel

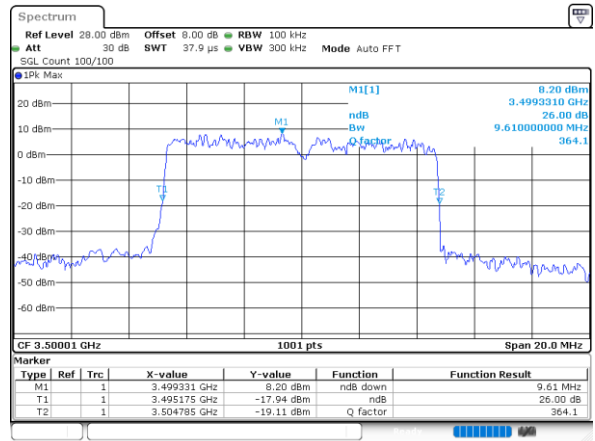
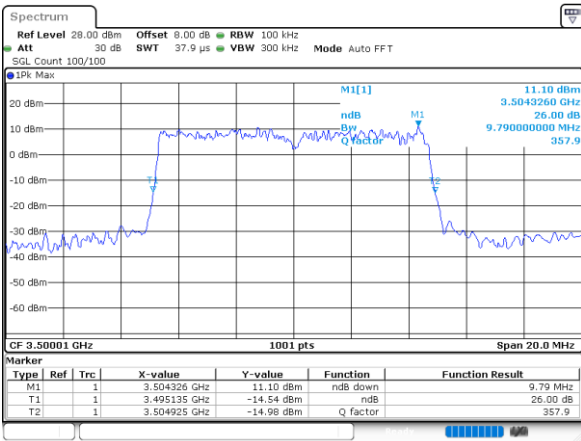



FR1 UL-MIMO n77 / 15MHz / CP-OFDM (Port 1)

QPSK

16QAM

Middle Channel

Middle Channel

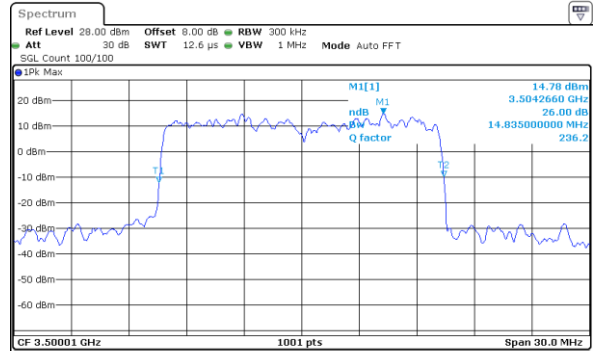
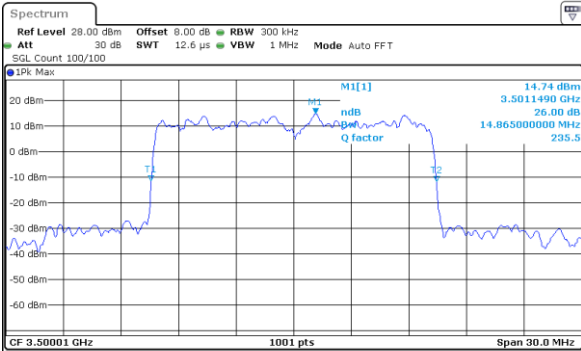

Date: 2_SEP.2021 00:59:48

Date: 2_SEP.2021 01:00:01

64QAM

256QAM

Middle Channel

Middle Channel

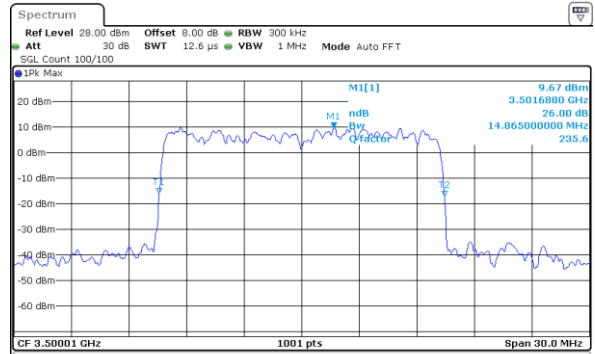
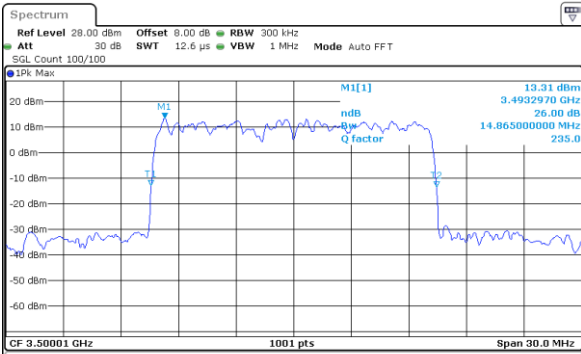

Date: 2_SEP.2021 01:00:14

Date: 2_SEP.2021 01:00:27



FR1 UL-MIMO n77 / 15MHz / CP-OFDM (Port 2)

QPSK

16QAM

Middle Channel

Middle Channel

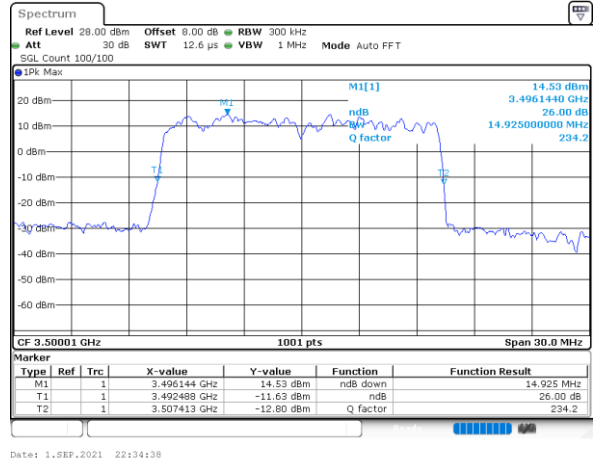
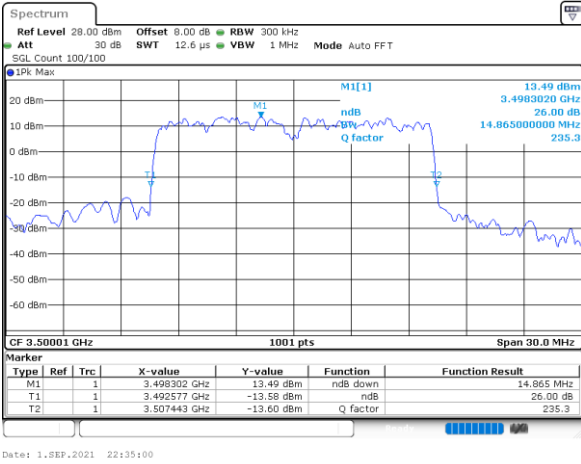

64QAM

256QAM

Middle Channel

Middle Channel

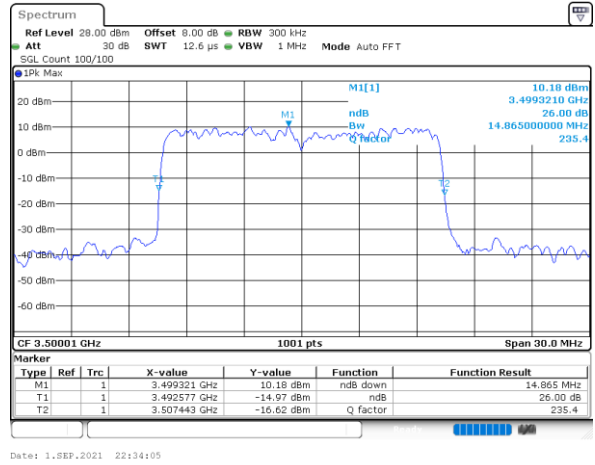
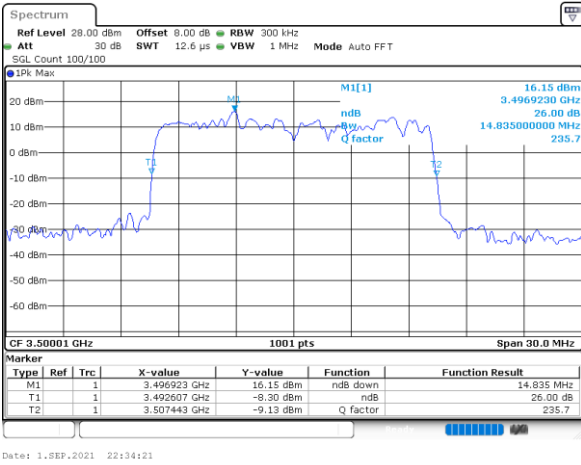

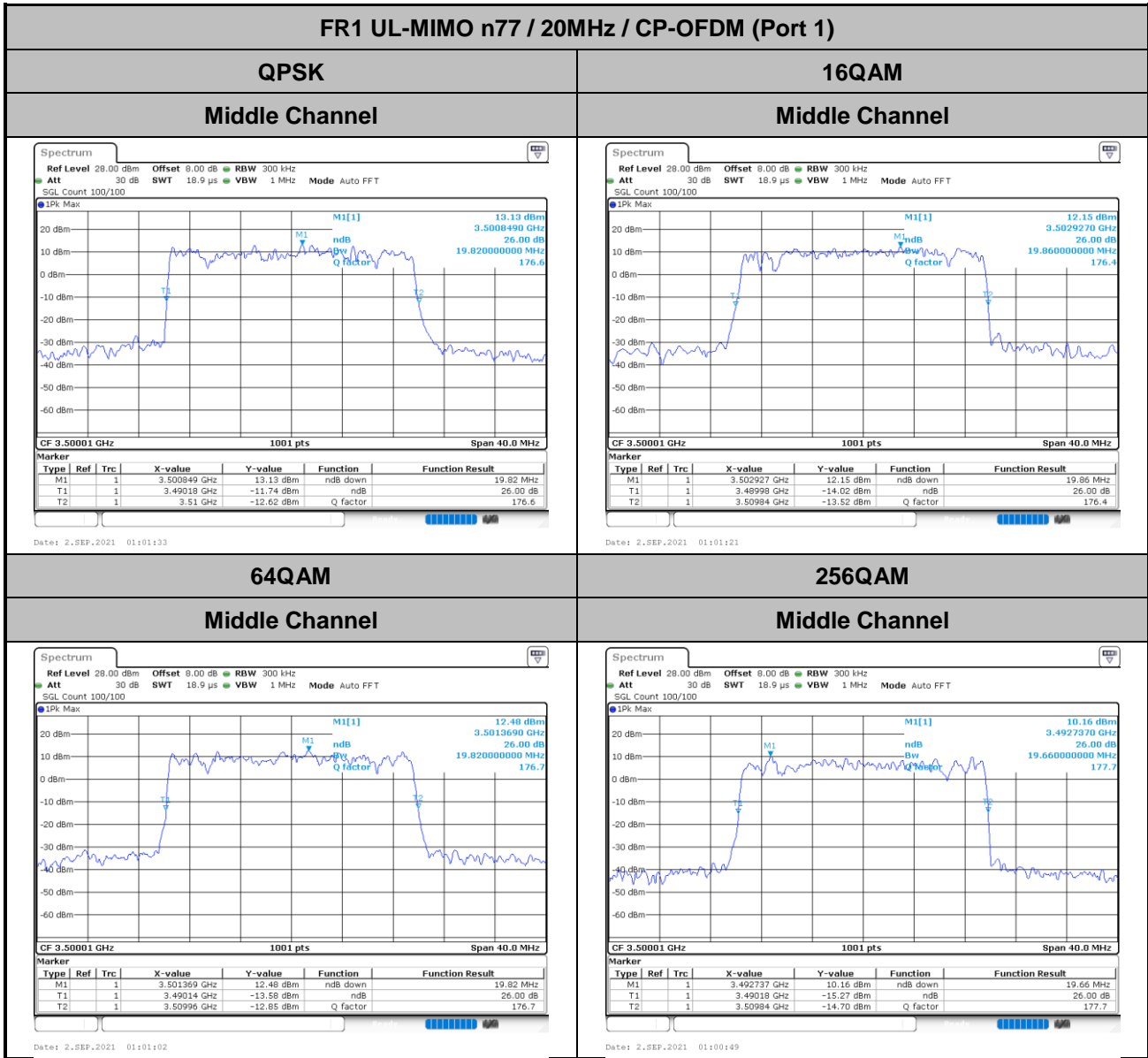

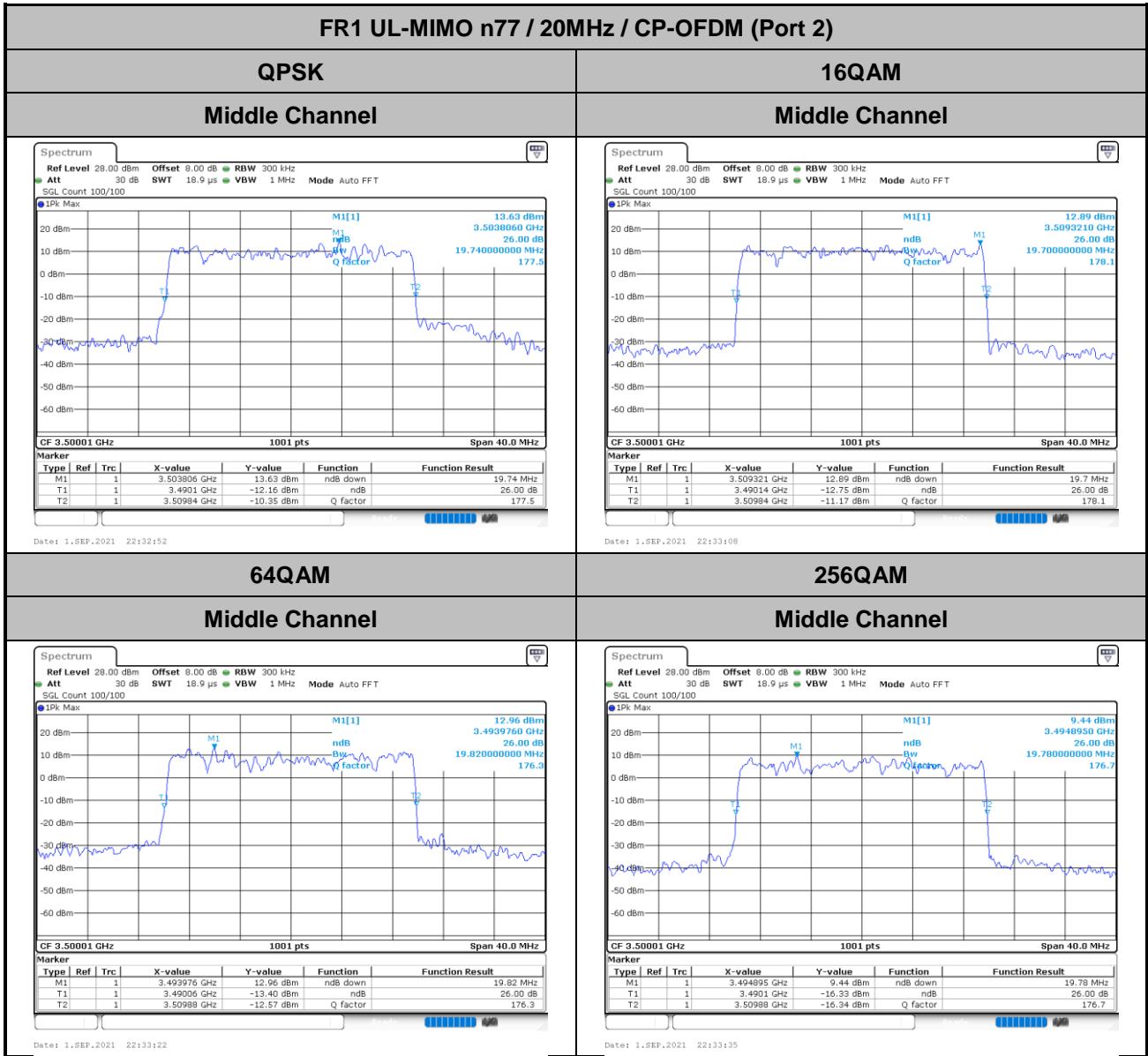



Occupied Bandwidth

Mode	FR1 UL-MIMO n77 : OBW(MHz) / CP-OFDM							
	Port 1				Port 2			
BW	10MHz	10MHz	10MHz	10MHz	10MHz	10MHz	10MHz	10MHz
Mod.	QPSK	16QAM	64QAM	256QAM	QPSK	16QAM	64QAM	256QAM
Middle CH	9.29	9.33	9.27	9.29	9.29	9.27	9.29	9.29

Mode	FR1 UL-MIMO n77 : OBW(MHz) / CP-OFDM							
	Port 1				Port 2			
BW	15MHz	15MHz	15MHz	15MHz	15MHz	15MHz	15MHz	15MHz
Mod.	QPSK	16QAM	64QAM	256QAM	QPSK	16QAM	64QAM	256QAM
Middle CH	14.12	14.09	14.09	14.15	14.21	14.18	14.12	14.03

Mode	FR1 UL-MIMO n77 : OBW(MHz) / CP-OFDM							
	Port 1				Port 2			
BW	20MHz	20MHz	20MHz	20MHz	20MHz	20MHz	20MHz	20MHz
Mod.	QPSK	16QAM	64QAM	256QAM	QPSK	16QAM	64QAM	256QAM
Middle CH	18.94	18.94	18.94	18.90	18.90	18.90	18.98	18.98

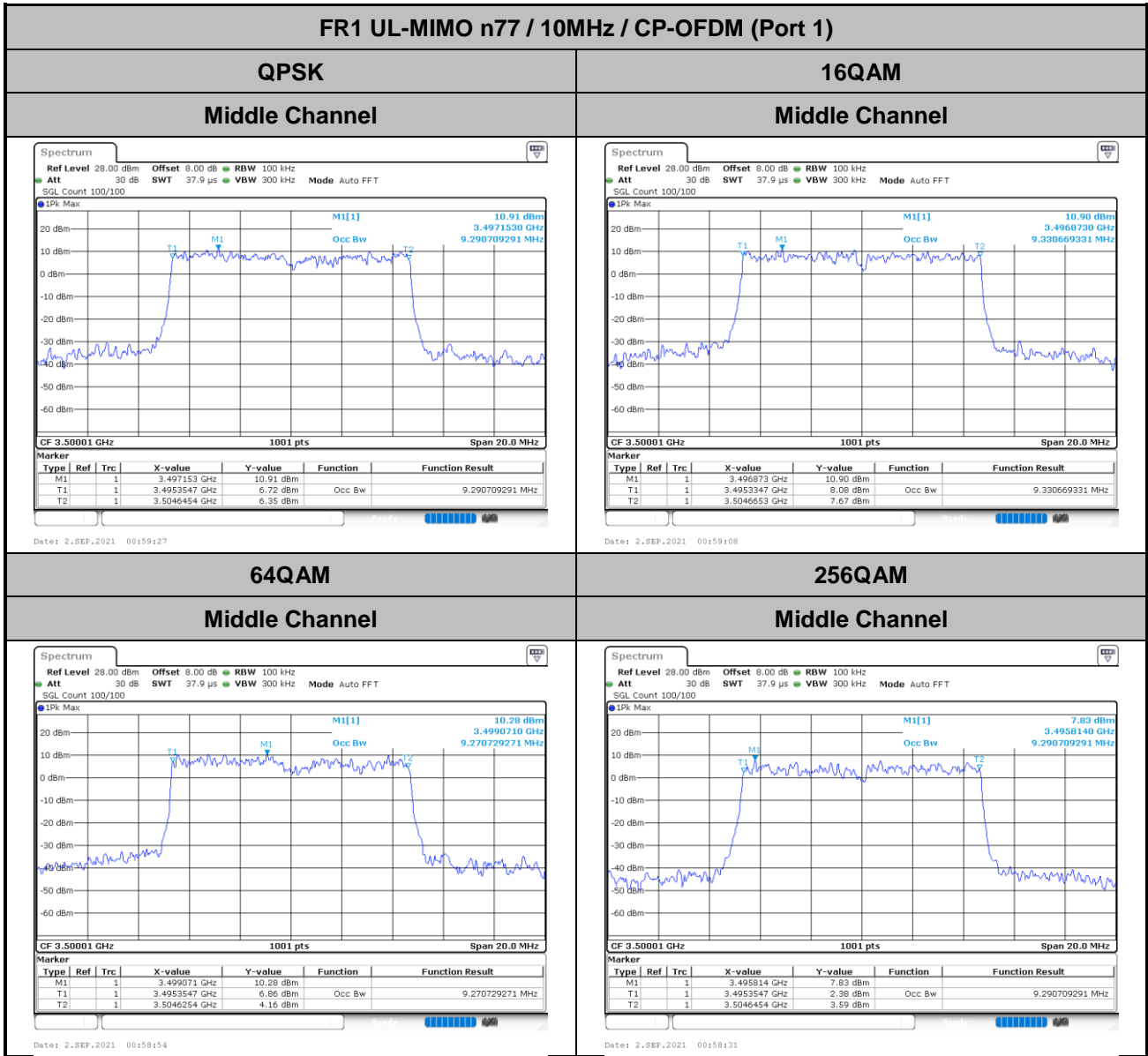

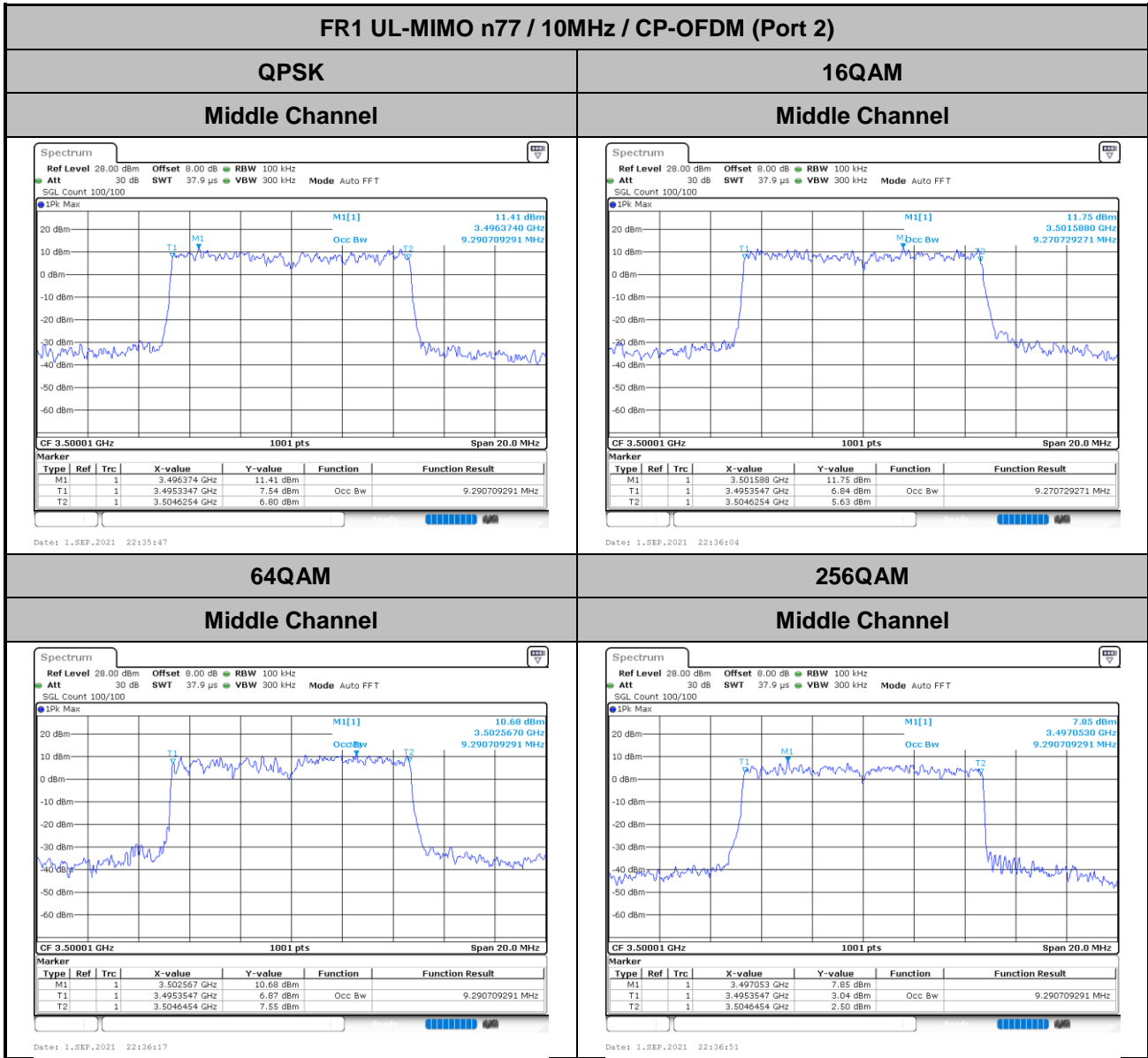

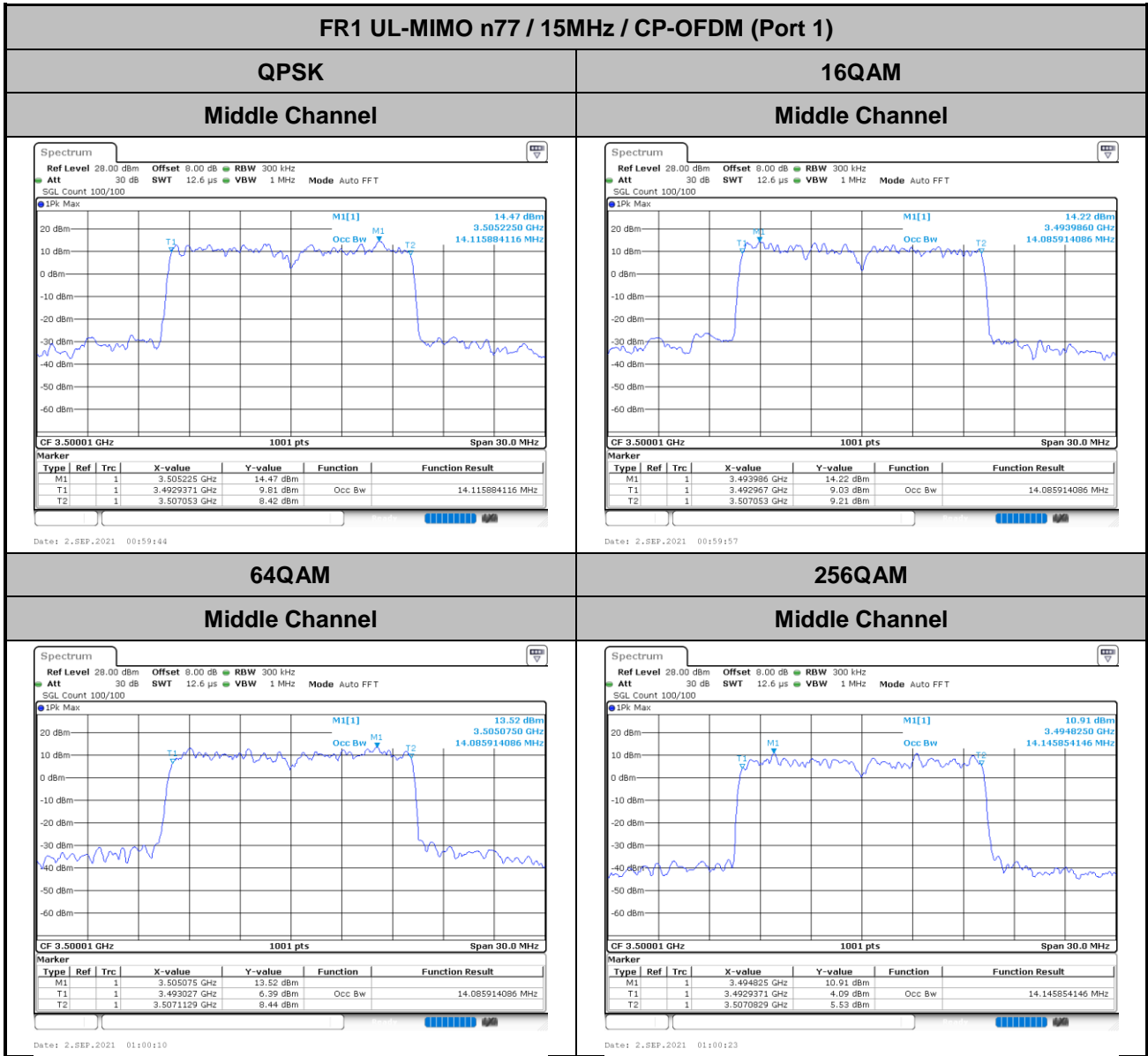

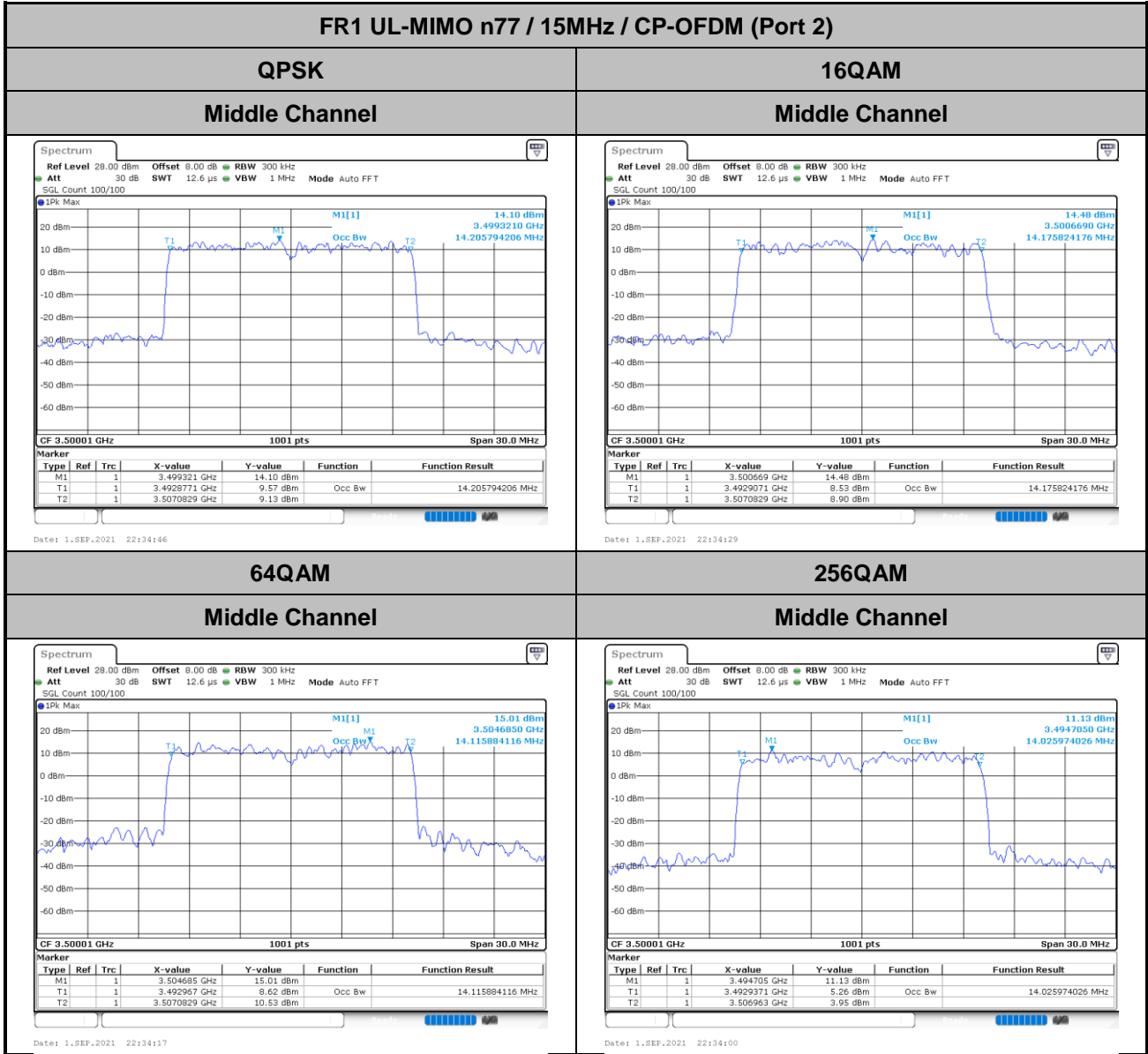

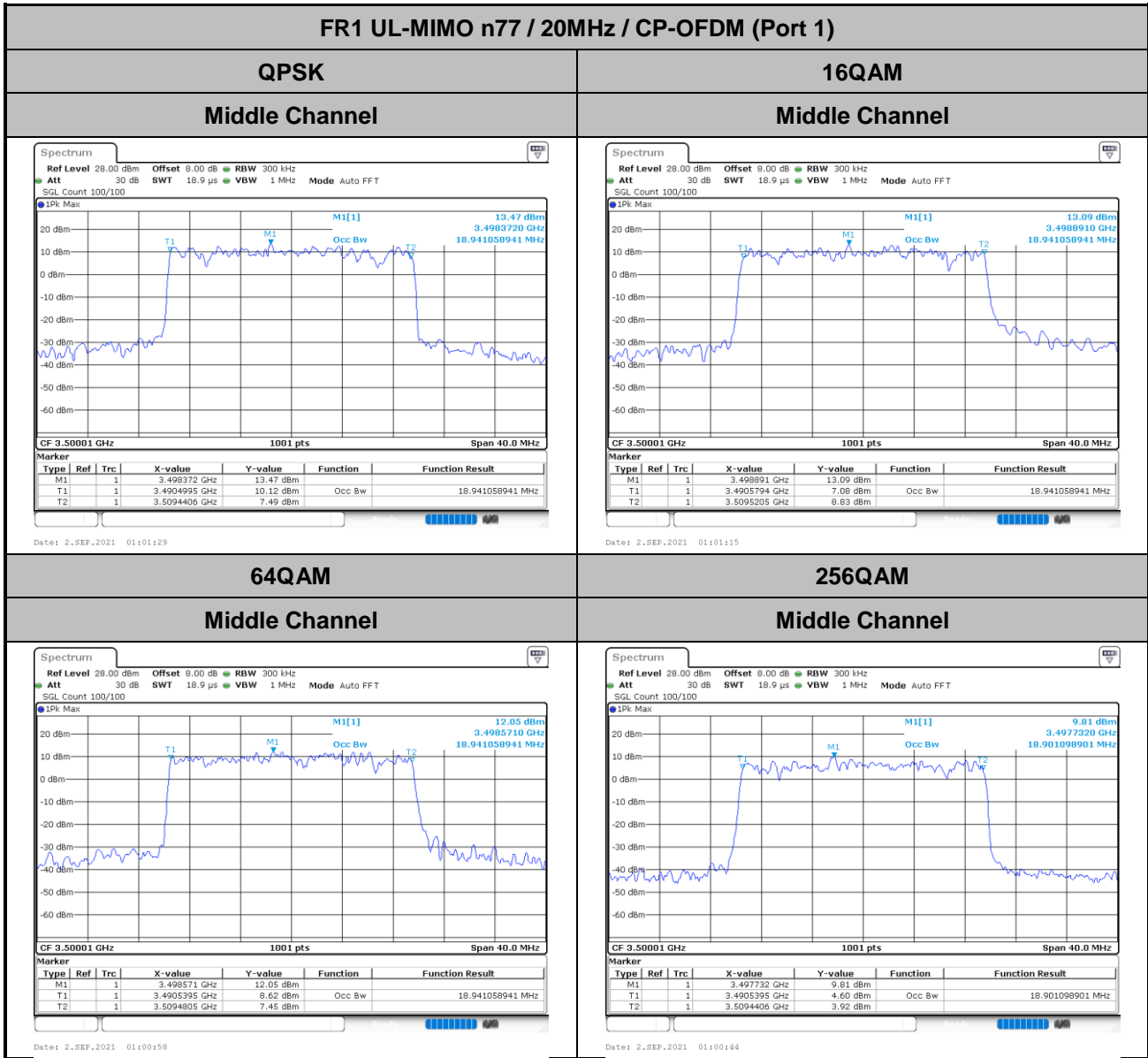

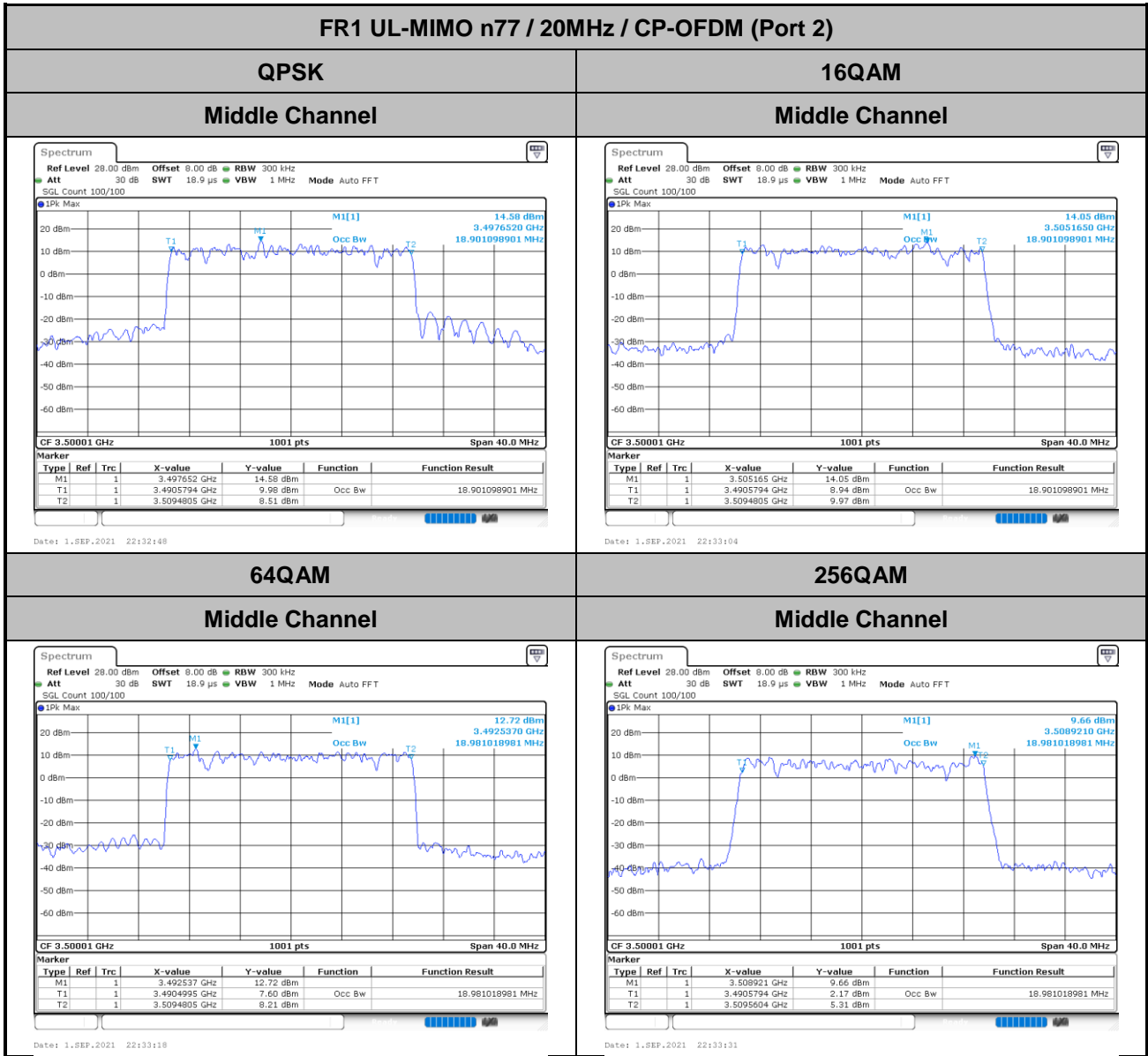



Conducted Band Edge

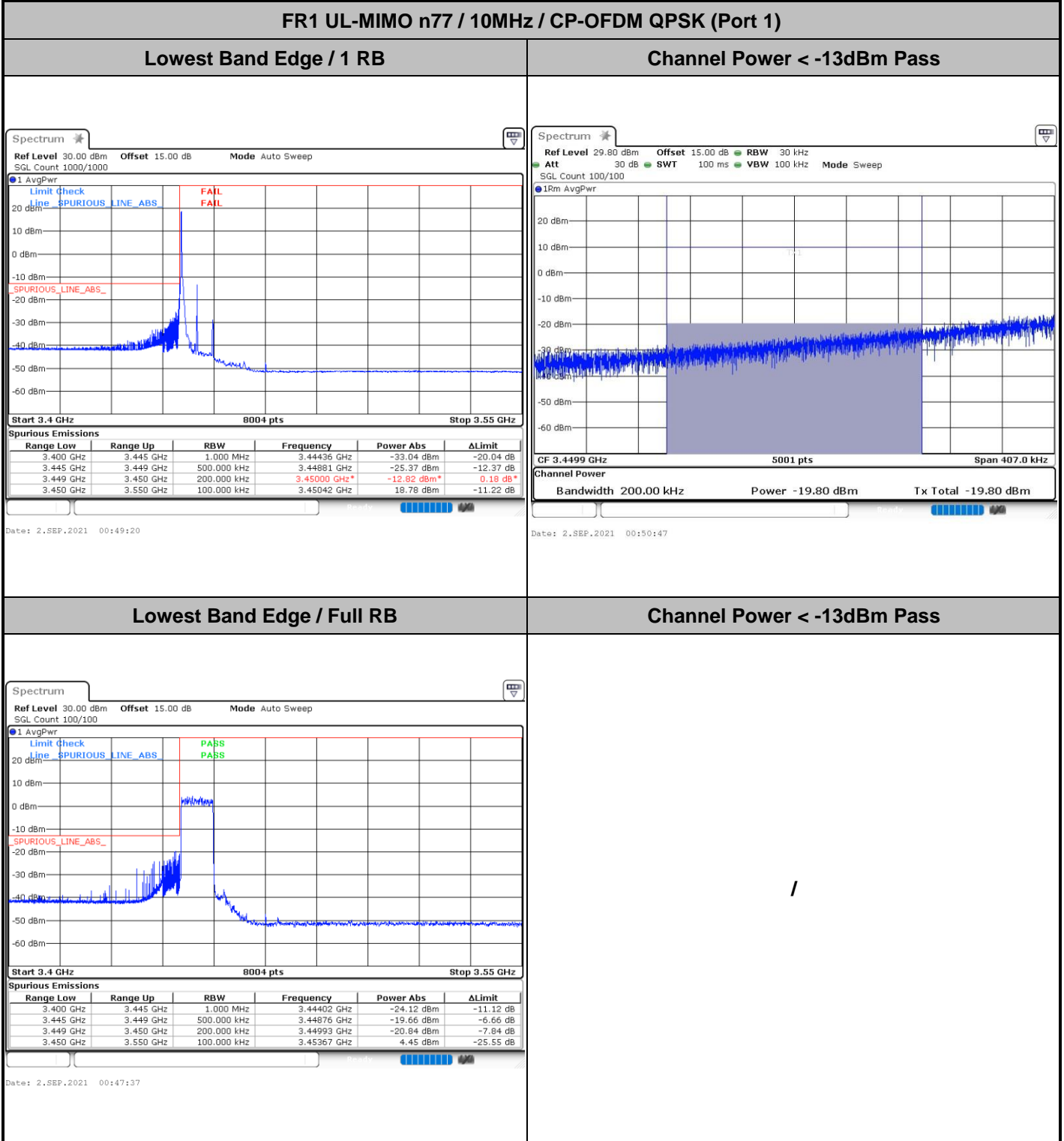



FR1 UL-MIMO n77 / 10MHz / CP-OFDM QPSK (Port 1)

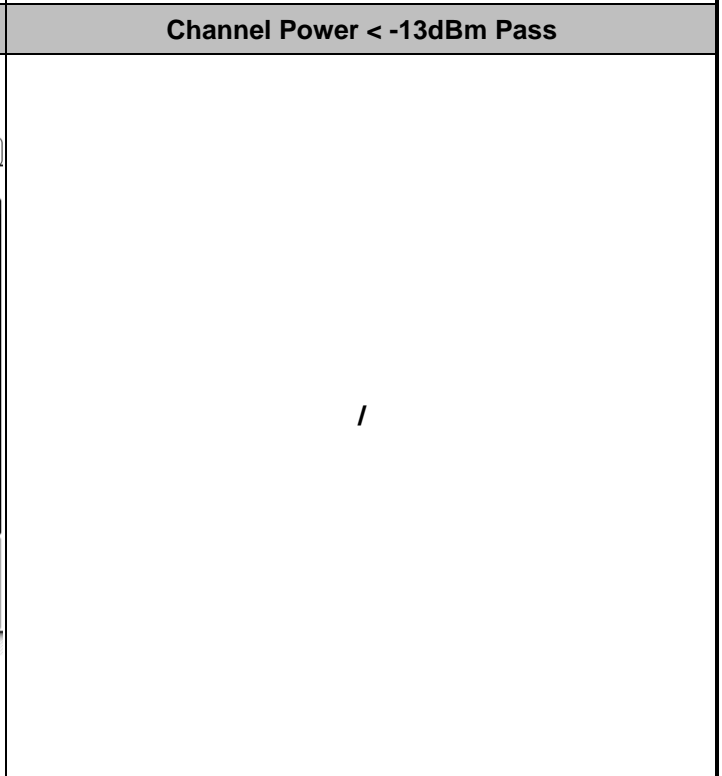
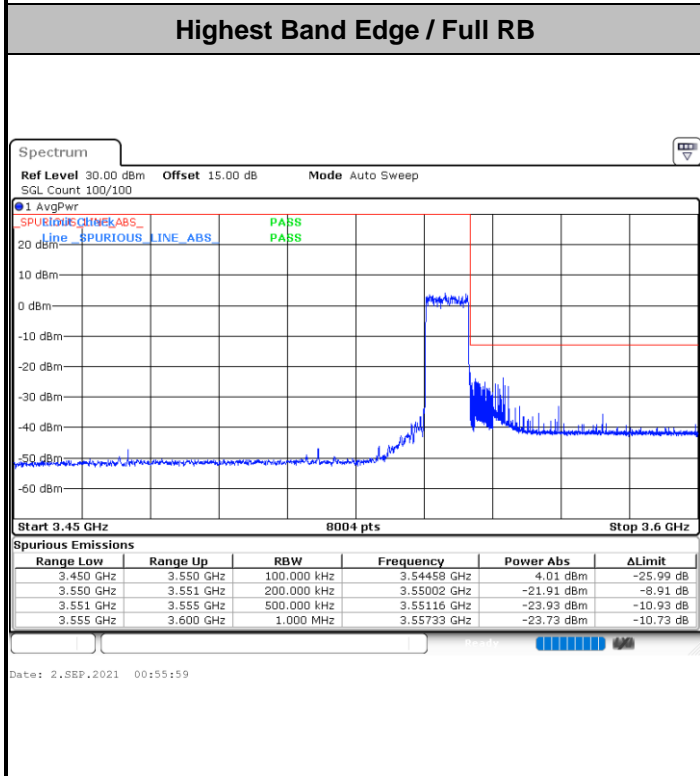
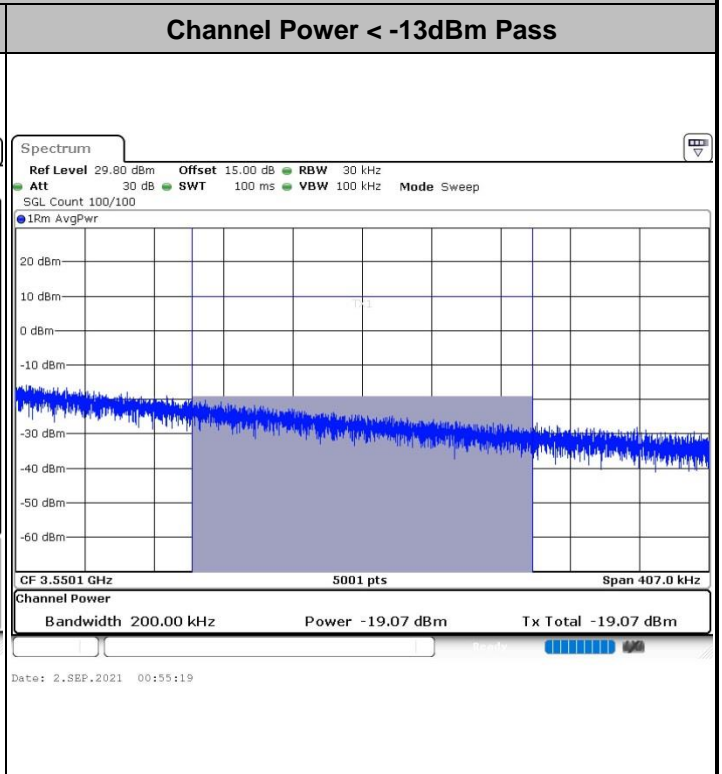
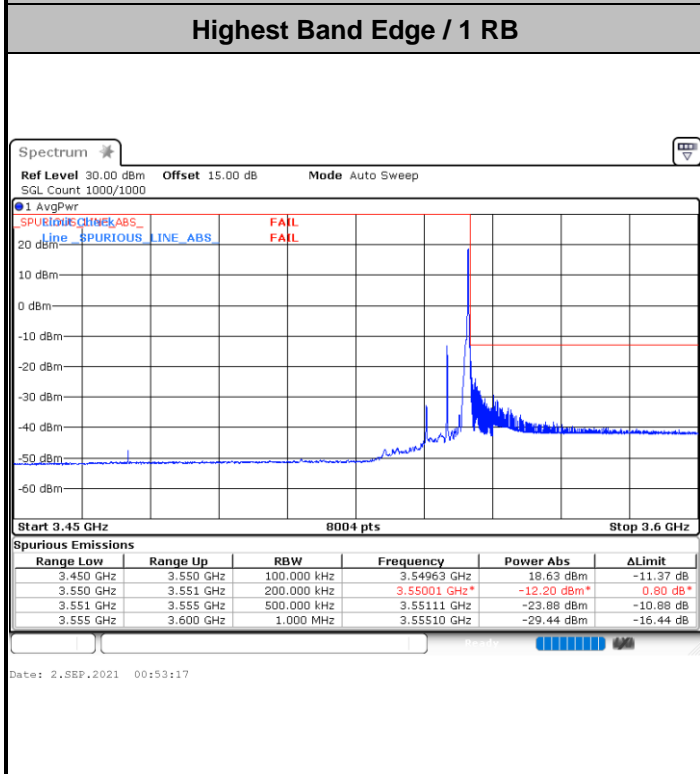



FR1 UL-MIMO n77 / 10MHz / CP-OFDM QPSK (Port 2)

Lowest Band Edge / 1 RB

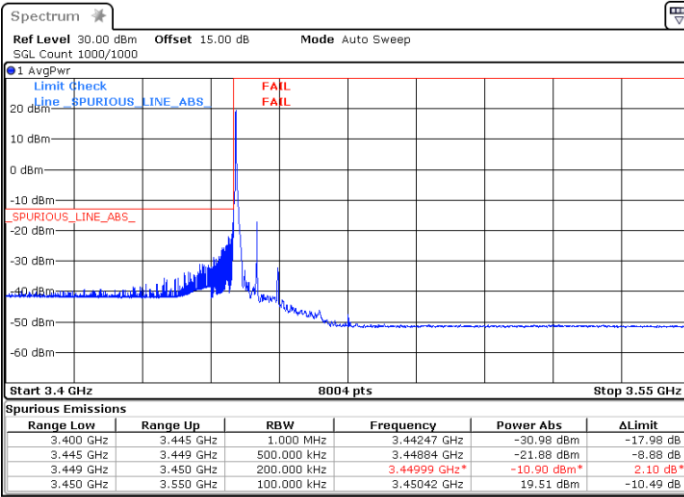

Channel Power < -13dBm Pass

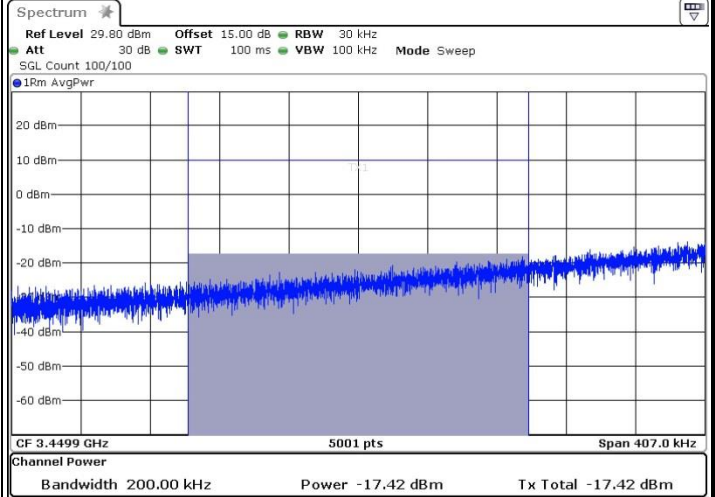

Lowest Band Edge / Full RB

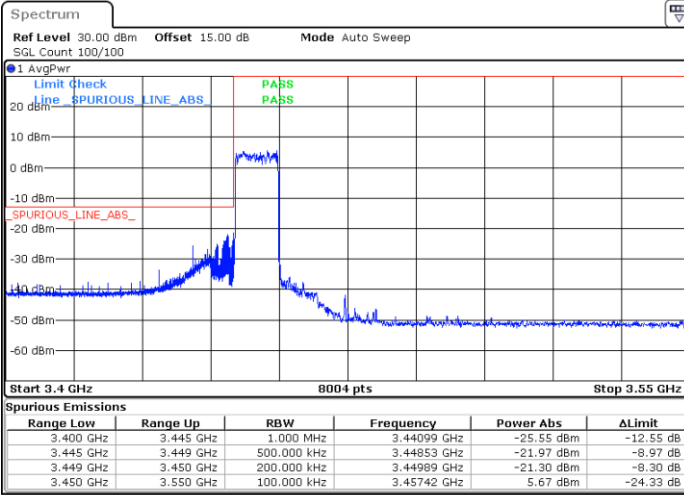

Channel Power < -13dBm Pass

/



FR1 UL-MIMO n77 / 10MHz / CP-OFDM QPSK (Port 2)

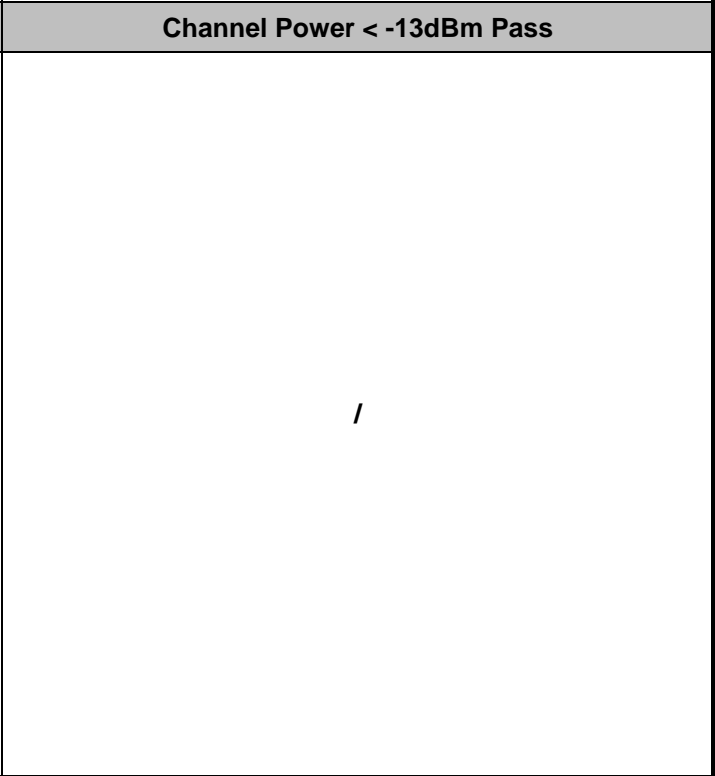
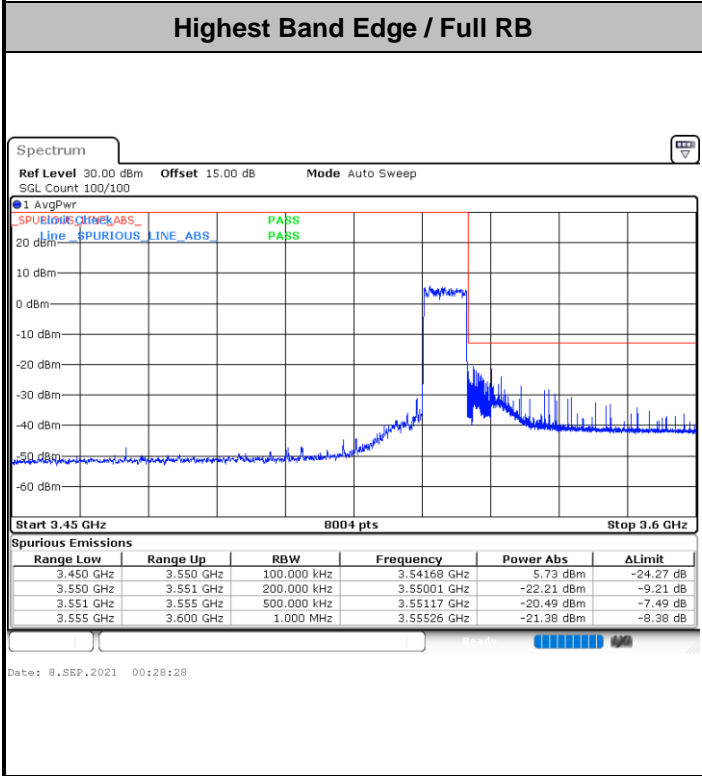
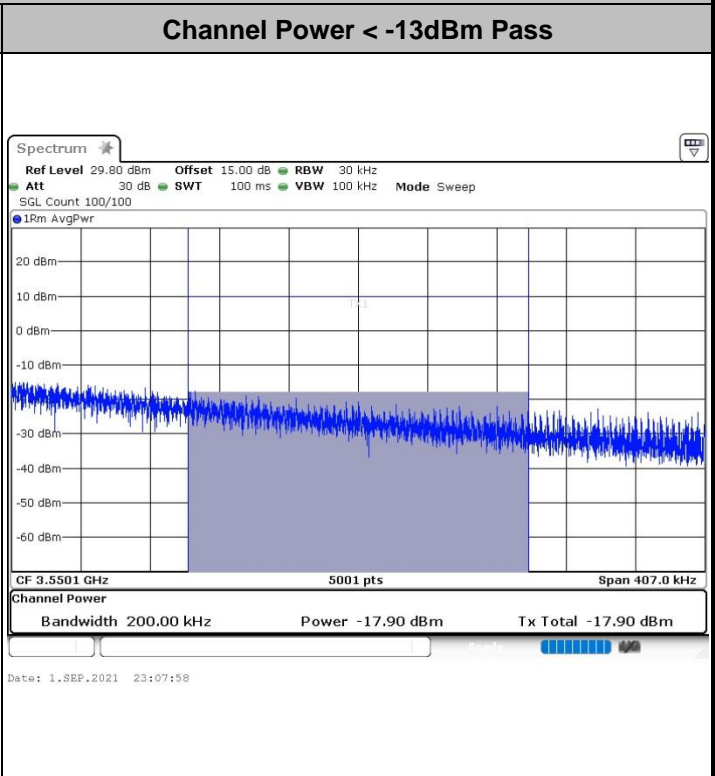
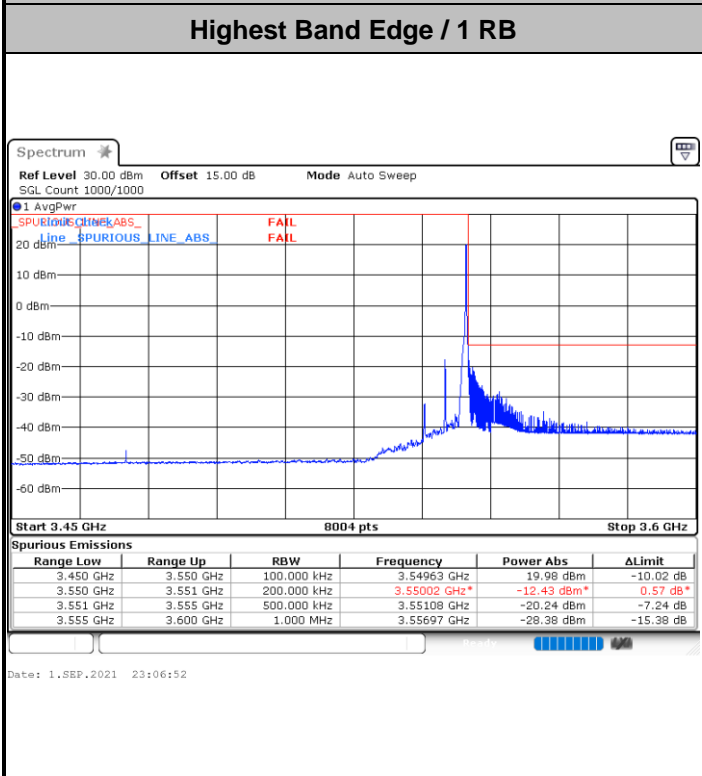



FR1 UL-MIMO n77 / 15MHz / CP-OFDM QPSK (Port 1)

Lowest Band Edge / 1 RB

Channel Power < -13dBm Pass

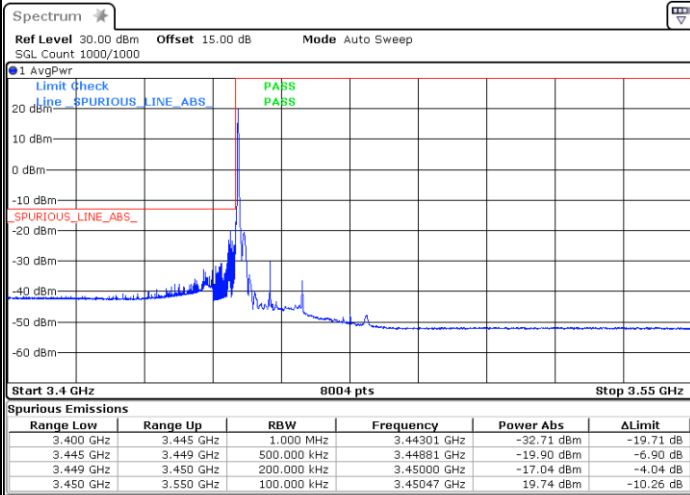

Date: 29_SEP.2021 11:28:42

Lowest Band Edge / Full RB

Channel Power < -13dBm Pass

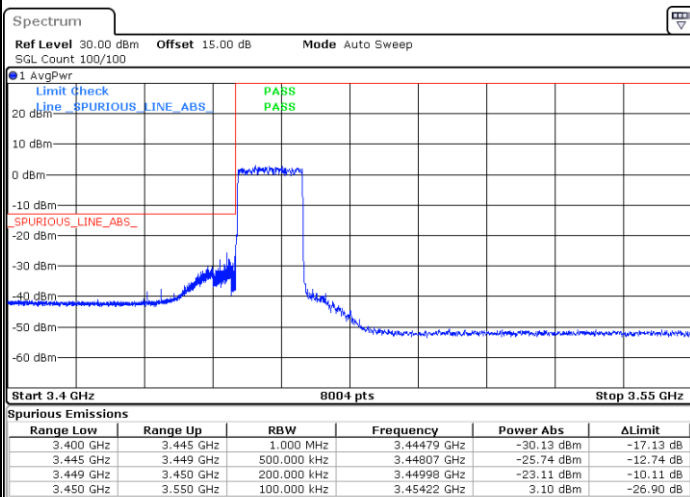

Date: 29_SEP.2021 11:24:57



FR1 UL-MIMO n77 / 15MHz / CP-OFDM QPSK (Port 1)

Highest Band Edge / 1 RB

Channel Power < -13dBm Pass

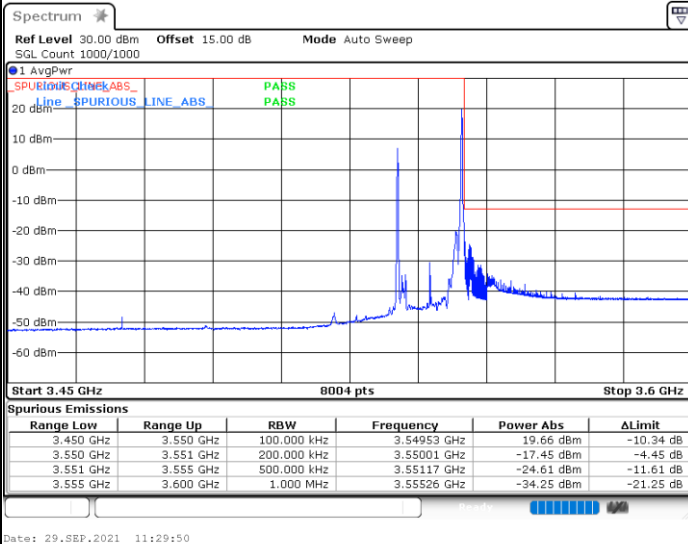

Date: 29_SEP.2021 11:29:50

Highest Band Edge / Full RB

Channel Power < -13dBm Pass

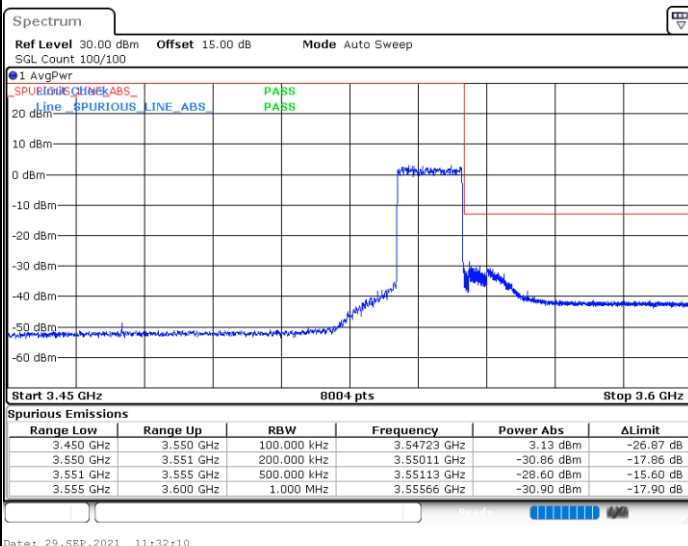

Date: 29_SEP.2021 11:32:10



FR1 UL-MIMO n77 / 15MHz / CP-OFDM QPSK (Port 2)

Lowest Band Edge / 1 RB

Channel Power < -13dBm Pass

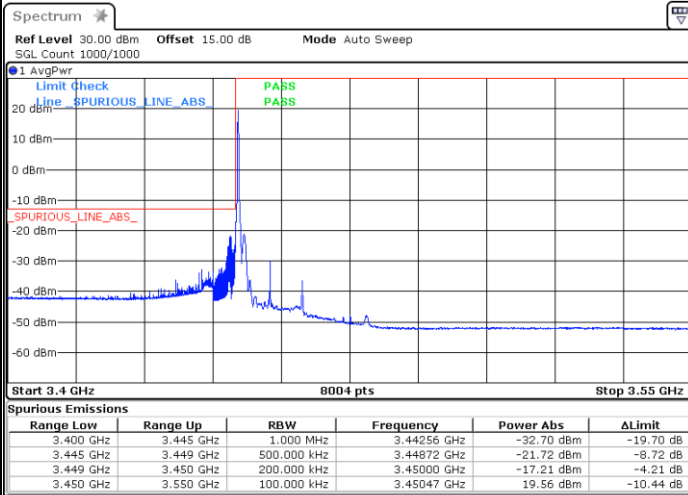

Date: 29_SEP.2021 11:27:04

Lowest Band Edge / Full RB

Channel Power < -13dBm Pass

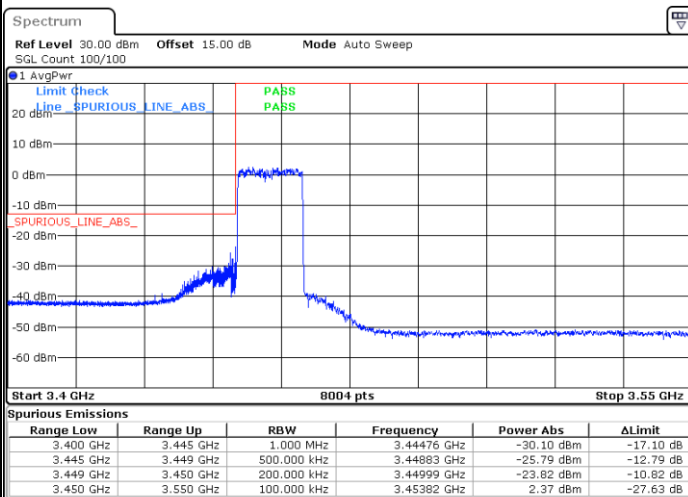

Date: 29_SEP.2021 11:25:09