

X1 Carbon Gen 9 and X1 Yoga Gen 6 User Guide

ThinkPad



Lenovo

Read this first

Before using this documentation and the product it supports, ensure that you read and understand the following:

- *Safety and Warranty Guide*
- *Setup Guide*
- [Generic Safety and Compliance Notices](#)

First Edition (February 2021)

© Copyright Lenovo 2021.

LIMITED AND RESTRICTED RIGHTS NOTICE: If data or software is delivered pursuant to a General Services Administration "GSA" contract, use, reproduction, or disclosure is subject to restrictions set forth in Contract No. GS-35F-05925.

Contents

Discover your Lenovo notebook.iii	Protect your privacy (for selected models)	31
Chapter 1. Meet your computer.	1	Protect data against power loss (for selected models)	31
Front view	1	UEFI BIOS passwords	31
Side view	5	Password types	31
Bottom view	6	Set, change, or remove a password	33
Specifications	6	Associate your fingerprints with passwords (for selected models)	34
USB specifications.	6		
Chapter 2. Get started with your computer.	9	Chapter 5. Configure advanced settings.	35
Access networks	9	UEFI BIOS	35
Connect to Wi-Fi networks.	9	Enter the UEFI BIOS menu.	35
Connect to the wired Ethernet	9	Navigate in the UEFI BIOS interface	35
Connect to a cellular network (for selected models)	9	Set the system date and time.	35
Turn on the Airplane mode.	10	Change the startup sequence	35
Interact with your computer	10	Update UEFI BIOS	35
Use the keyboard shortcuts	10	Recovery	36
Use the TrackPoint pointing device	12	Restore system files and settings to an earlier point	36
Use the trackpad	13	Restore your files from a backup	36
Use the touch screen (for selected models)	14	Reset your computer	36
Connect to an external display	16	Use advanced options	36
Get to know YOGA modes	17	Windows automatic recovery.	36
Use Lenovo Integrated Pen (for ThinkPad X1 Yoga Gen 6 only)	18	Create and use a recovery USB device	37
		Install Windows 10 and drivers	37
Chapter 3. Explore your computer	21	Chapter 6. CRU replacement	39
Lenovo apps	21	CRU list	39
Smart features (for selected models).	21	Disable Fast Startup and the built-in battery.	39
Intelligent cooling	23	Replace a CRU	40
Manage power	24	Base cover assembly	40
Check the battery status	24	2242 M.2 solid-state drive	41
Charge the computer	24		
Change the power settings	25	Chapter 7. Help and support	43
Transfer data	26	Frequently asked questions	43
Set up a Bluetooth connection	26	Error messages	44
Set up an NFC connection (for selected models)	26	Beep errors	45
Accessories	26	Self-help resources	46
Purchase accessories	27	Windows label	46
		Call Lenovo	47
		Before you contact Lenovo	47
		Lenovo Customer Support Center.	48
Chapter 4. Secure your computer and information	29	Purchase additional services.	49
Lock the computer	29		
Log in with your fingerprint	29	Appendix A. Accessibility and ergonomic information	51
Log in with your face ID (for selected models)	30		
Detect human presence (for selected models)	30		

**Appendix B. Compliance
information. 55**

**Appendix C. Notices and
trademarks. 61**

Discover your Lenovo notebook

Thank you for choosing a Lenovo notebook! We are dedicated to delivering the best solution to you.

Before starting your tour, please read the following information:

- Illustrations in this documentation might look different from your product.
- Depending on the model, some optional accessories, features, software programs, and user interface instructions might not be applicable to your computer.
- Documentation content is subject to change without notice. To get the latest documentation, go to <https://pcsupport.lenovo.com>.





Chapter 1. Meet your computer

Front view

ThinkPad X1 Yoga Gen 6



	IR camera* / Camera*		Privacy shutter (Camera cover)
	Microphones		Power button with fingerprint reader
	TrackPoint® pointing stick		Speaker

	NFC (near field communication) mark*		Trackpad
	TrackPoint buttons		Touch screen

* for selected models

Privacy shutter











Slide Privacy shutter to cover or uncover the camera lens. It is designed to protect your privacy.

Related topics

- “Log in with your face ID (for selected models)” on page 30
- “Log in with your fingerprint” on page 29
- “Detect human presence (for selected models)” on page 30
- “Use the touch screen (for selected models)” on page 14
- “Use the TrackPoint pointing device” on page 12
- “Use the trackpad” on page 13
- “Set up an NFC connection (for selected models)” on page 26

ThinkPad X1 Carbon Gen 9



	IR camera* / Camera*		Privacy Shutter (Camera cover)
	Microphones		Power button with fingerprint reader
	TrackPoint® pointing stick		Speaker
	NFC (near field communication) mark*		Trackpad
	TrackPoint buttons		Touch screen*

* for selected models



ThinkShutter





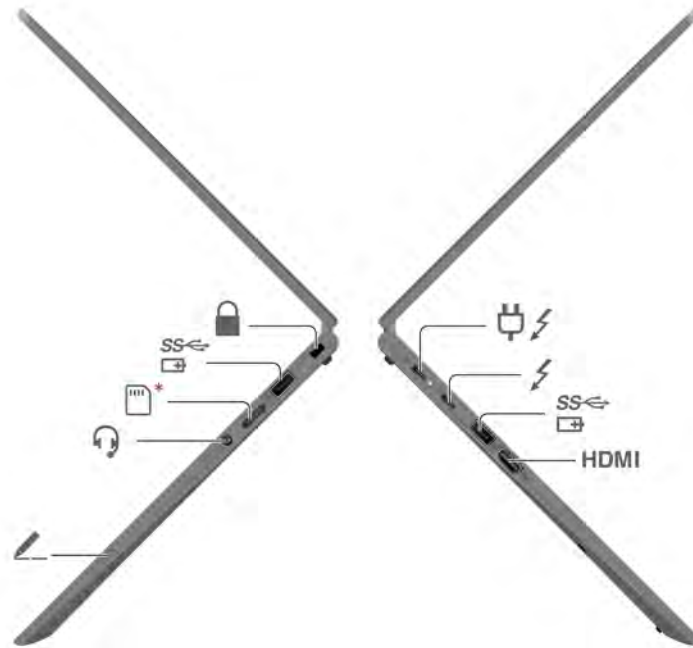

Slide Privacy Shutter to cover or uncover the camera lens. It is designed to protect your privacy.

Related topics

- “Log in with your face ID (for selected models)” on page 30
- “Log in with your fingerprint” on page 29
- “Detect human presence (for selected models)” on page 30
- “Use the touch screen (for selected models)” on page 14
- “Use the TrackPoint pointing device” on page 12
- “Use the trackpad” on page 13
- “Set up an NFC connection (for selected models)” on page 26

Side view



	Power connector		Thunderbolt™ 4 connector (USB-C®)
	Always on USB 3.2 connector Gen 1		Lenovo Integrated Pen (for ThinkPad X1 Yoga Gen 6 only)
	Audio connector		Nano-SIM-card tray
	Security-lock slot		

* for selected models

Related topics

- “Connect to a cellular network (for selected models)” on page 9
- “Charge the computer” on page 24
- “Connect to an external display” on page 16
- “Use Lenovo Integrated Pen (for ThinkPad X1 Yoga Gen 6 only)” on page 18
- “USB specifications” on page 6
- “Lock the computer” on page 29
-

Bottom view

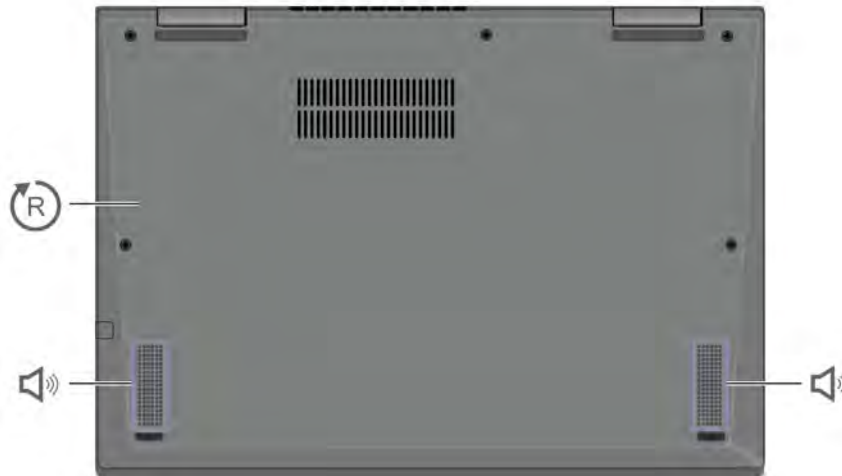

Emergency-reset hole



Speaker



Emergency-reset hole

If the computer stops responding and you cannot turn it off by pressing the power button, reset your computer:

1. Disconnect your computer from ac power.
2. Insert a straightened paper clip into the hole to cut off power supply temporarily.
3. Connect your computer to ac power and then turn on your computer.



Specifications



For detailed specifications of your computer, go to <https://psref.lenovo.com>.

USB specifications

Notes:

- Depending on the model, some USB connectors might not be available on your computer.
- On very rare occasions, the USB-C compatible devices connected to the USB-C connector might interfere with the wireless features. If your computer cannot be connected to Wi-Fi or cellular network, or if your location cannot be pinpointed through the GPS function, detach the USB-C compatible devices from the USB-C connector.

Connector name	Description
 <ul style="list-style-type: none"> •  USB 2.0 connector •  USB 3.2 connector Gen 1 	<p>Connect USB-compatible devices, such as a USB keyboard, USB mouse, USB storage device, or USB printer.</p>

 <ul style="list-style-type: none"> • USB-C (3.2 Gen 1) connector • USB-C (3.2 Gen 2) connector •  Thunderbolt 3 connector (USB-C) •  Thunderbolt 4 connector (USB-C) 	<ul style="list-style-type: none"> • Charge USB-C compatible devices with the output voltage and current of 5 V and 1.5 A. • Connect to an external display: <ul style="list-style-type: none"> – USB-C to VGA: up to 1920 x 1200 pixels, 60 Hz – USB-C to DP: up to 5120 x 3200 pixels, 60 Hz • Connect to USB-C accessories to help expand your computer functionality. To purchase USB-C accessories, go to https://www.lenovo.com/accessories.
--	---

Statement on USB transfer rate

Depending on many factors such as the processing capability of the host and peripheral devices, file attributes, and other factors related to system configuration and operating environments, the actual transfer rate using the various USB connectors on this device will vary and will be slower than the data rate listed below for each corresponding device.

USB device	Data rate (Gbit/s)
3.2 Gen 1 / 3.1 Gen 1	5
Thunderbolt 3 connector (USB-C)	40
Thunderbolt 4 connector (USB-C)	40

Chapter 2. Get started with your computer

Access networks

This section helps you connect to a wireless or wired network.

Connect to Wi-Fi networks

Click the network icon in the Windows® notification area, and then select a network for connection. Provide required information, if needed.

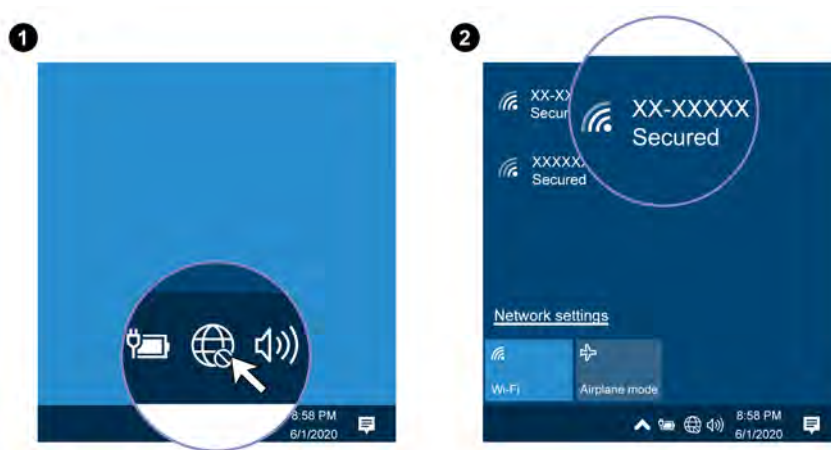

Connect to the wired Ethernet

To connect your computer to a local network, you need a Lenovo USB-C to Ethernet Adapter. Lenovo USB-C to Ethernet Adapter is available as an option and shipped with some computer models. You can purchase one from Lenovo at <https://www.lenovo.com/accessories>.



Connect to a cellular network (for selected models)

If your computer has a wireless wide area network (WWAN) card and a nano-SIM card installed, you can connect to a cellular data network and get online everywhere.

Note: The cellular service is provided by authorized mobile service carriers in some countries or regions. You must have a cellular plan from a service carrier to connect to the cellular network.

To establish a cellular connection:

1. Turn off the computer.
2. Turn over the computer to prevent nano-SIM card from falling.
3. Locate the nano-SIM card slot and insert the nano-SIM card as shown. Note the orientation of the card and ensure that it is seated correctly.

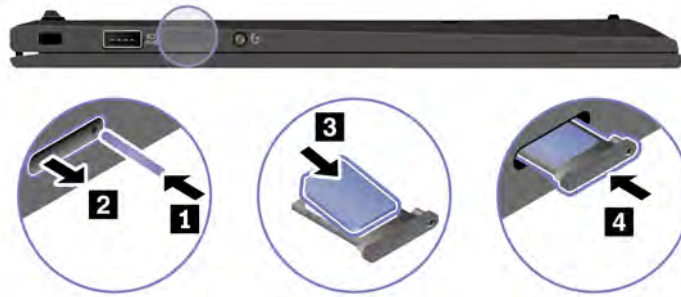

4. Turn over the computer and turn it on.
5. Click the network icon, and then select the cellular network icon from the list. Provide required information, if needed.

Turn on the Airplane mode

When the Airplane mode is enabled, all wireless features are disabled.

1. Click the action center icon in the Windows notification area.
2. Click **Airplane mode** to turn on the Airplane mode.

Interact with your computer

Your computer provides you various ways to navigate the screen.

Use the keyboard shortcuts

The special keys on the keyboard help you work more effectively.



<https://support.lenovo.com/solutions/featurevideo>



Invoke the special function printed as an icon on each key or standard function of F1–F12 function keys.

FnLock indicator on: standard function

FnLock indicator off: special function



















Enable / disable speakers



Decrease volume



Increase volume

	Enable / disable microphones
	Darken display
	Brighten display
	Manage external displays
	Enable / disable airplane mode
	Open / collapse notification center
	Answer incoming calls
	This function only works with some apps, such as Skype for Business 2016 and Microsoft Teams 1.0. By default, the function works with Skype for Business 2016. You can change the default setting on the Vantage app.
	Decline incoming calls
	This function only works with some apps, such as Skype for Business 2016 and Microsoft Teams 1.0.
	By default, the function works with Skype for Business 2016. You can change the default setting on the Vantage app. Note: You can also press F11 to hang up ongoing calls on Skype for Business 2016.
	Customize the function of this key on the Vantage app
	Open Snipping Tool
	Toggle keyboard backlight
	Break operation
	Pause operation
	Scroll contents
	Send system request
	Enter sleep mode To wake up the computer, press Fn or the power button.



Go to beginning



Go to end

Use the TrackPoint pointing device

The TrackPoint pointing device enables you to perform all the functions of a traditional mouse, such as pointing, clicking, and scrolling.

Use the TrackPoint pointing device

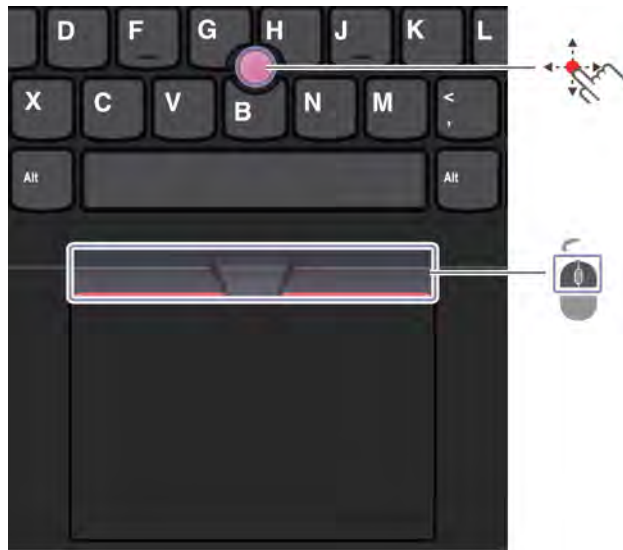

TrackPoint pointing stick

Use your finger to apply pressure to the pointing-stick nonslip cap in any direction parallel to the keyboard. The pointer on the screen moves accordingly. The higher the pressure applied, the faster the pointer moves.



TrackPoint buttons

The left-click button and right-click button correspond to the left and right buttons on a traditional mouse. Press and hold the dotted middle button while using your finger to applying pressure to the pointing stick in the vertical or horizontal direction. Then, you can scroll through the document, Web site, or apps.

Disable the TrackPoint pointing device

The TrackPoint pointing device is active by default. To disable the device:

1. Open the **Start** menu, and then click **Settings** → **Devices** → **Mouse**.
2. Follow the on-screen instructions to disable TrackPoint.

Replace the pointing-stick nonslip cap

Note: Ensure that the new cap has grooves **a**.

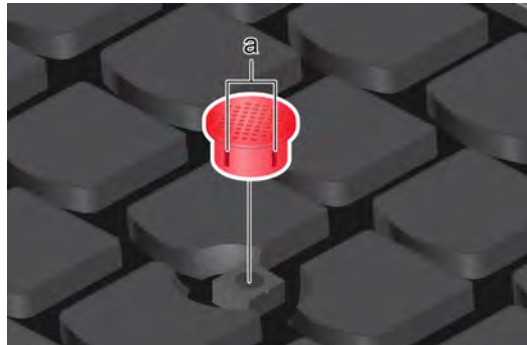

Use the trackpad

You can use the trackpad to perform all the pointing, clicking, and scrolling functions of a traditional mouse.

Use the trackpad



 Left-click zone	 Right-click zone
---	--

Use the touch gestures

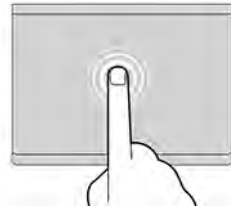

Tap once to select or open an item.

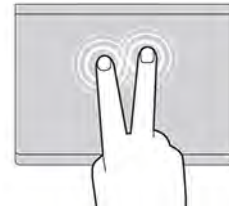

Tap twice quickly to display a shortcut menu.

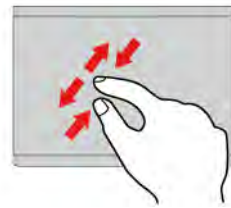

Two-finger zoom in or zoom out.

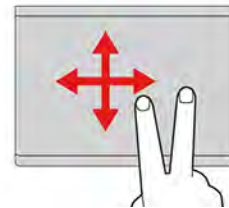

Scroll through items.

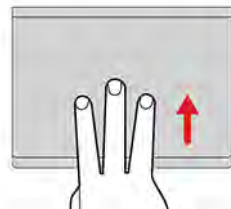

Open the task view to see all open windows.

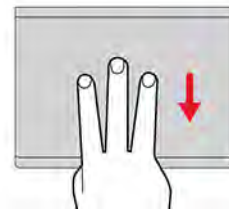

Show the desktop.

Notes:

- When using two or more fingers, ensure that you position your fingers slightly apart.
- Some gestures are not available if the last action was done from the TrackPoint pointing device.
- Some gestures are only available when you are using certain apps.
- If the trackpad surface is stained with oil, turn off the computer first. Then, gently wipe the trackpad surface with a soft and lint-free cloth moistened with lukewarm water or computer cleaner.

For more gestures, see the help information of the pointing device.

Disable the trackpad

The trackpad is active by default. To disable the device:

1. Open the **Start** menu, and then click **Settings** → **Devices** → **Touchpad**.
2. In the Touchpad section, turn off the **Touchpad** control.

Use the touch screen (for selected models)

If your computer display supports the multi-touch function, you can navigate the screen with simple touch gestures.

Note: Some gestures might not be available when you are using certain apps.



Tap once to single click



Tap twice quickly to double-click



Tap and hold to right-click

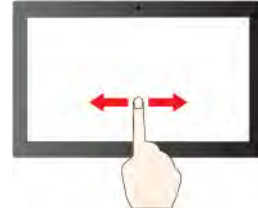

Slide to scroll through items



Zoom out



Zoom in



Swipe from the left: view all open windows



Swipe from the right: open action center



Swipe downwards shortly: show title bar

Swipe downwards: close the current app



Drag

Maintenance tips:

- Turn off the computer before cleaning the touch screen.
- Use a dry, soft, and lint-free cloth or a piece of absorbent cotton to remove fingerprints or dust from the touch screen. Do not apply solvents to the cloth.
- The touch screen is a glass panel covered with a plastic film. Do not apply pressure or place any metallic object on the screen, which might damage the touch panel or cause it to malfunction.
- Do not use fingernails, gloved fingers, or inanimate objects for input on the screen.
- Regularly calibrate the accuracy of the finger input to avoid a discrepancy.

Connect to an external display

Connect your computer to a projector or a monitor to give presentations or expand your workspace.

Connect to a wired display

If your computer cannot detect the external display, right-click a blank area on the desktop, and then click **Display settings** → **Detect**.

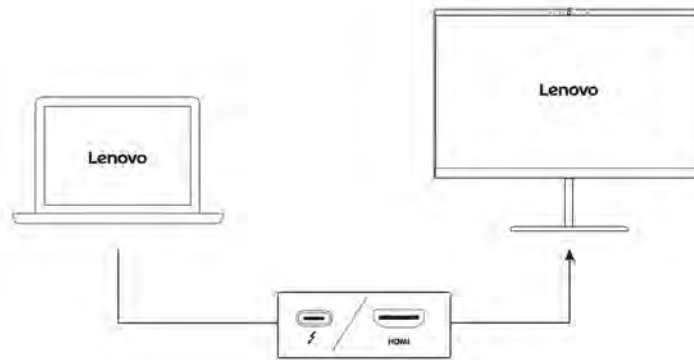



Supported resolution

The following table lists the supported maximum resolution of the external display.



Connect the external display to	Supported resolution
Thunderbolt 4 connectors (USB-C)	Up to 5120 x 3200 pixels / 60 Hz
HDMI™ connector	Up to 3840 x 2160 pixels / 60 Hz

Connect to a wireless display

To use a wireless display, ensure that both your computer and the external display support the Miracast® feature.

Press  +  and then select a wireless display to connect with.

Set the display mode

Press  or  +  and then select a display mode of your preference.

Change display settings

1. Right-click a blank area on the desktop and select **Display settings**.
2. Select the display that you want to configure.
3. Change display settings of your preference.

You can change the settings for both the computer display and the external display. For example, you can define which one is the main display and which one is the secondary display. You also can change the resolution and orientation.

Get to know YOGA modes

Rotate the display to switch among different YOGA modes according to your preference. The keyboard and the pointing devices are automatically disabled in the stand mode, tent mode, and tablet mode. Use the touch screen to control your computer instead.

Attention: Do not rotate the computer display with too much force, or apply too much force to the upper-right or upper-left corner of the computer display. Otherwise the computer display or hinges might get damaged.



Notebook mode



Stand mode



Tent mode



Tablet mode

Use Lenovo Integrated Pen (for ThinkPad X1 Yoga Gen 6 only)

The garaged rechargeable electronic Lenovo Integrated Pen enables a more precise and easier way of writing and sketching.



Eraser button



Right-click button

Lenovo Integrated Pen is not waterproof. Keep the pen away from water and excessive moisture. To purchase Lenovo Integrated Pen, go to <https://www.lenovo.com/accessories>.

Charge Lenovo Integrated Pen

1. Ensure that your computer is on or in sleep mode.
2. Insert the pen back into the pen slot. The pen is 80% charged in about 15 seconds and 100% charged in about five minutes.



Chapter 3. Explore your computer

Lenovo apps

This section provides introduction to the Vantage and Lenovo Quick Clean apps.

The Vantage app

The preinstalled Vantage app is a customized one-stop solution to help you maintain your computer with automated updates and fixes, configure hardware settings, and get personalized support.

To access the Vantage app, type Vantage in the search box.

Key features

The Vantage app enables you to:

- Know the device status easily and customize device settings.
- Download and install UEFI BIOS, firmware, and driver updates to keep your computer up-to-date.
- Monitor your computer health, and secure your computer against outside threats.
- Scan your computer hardware and diagnose hardware problems.
- Look up warranty status (online).
- Access *User Guide* and helpful articles.

Notes:

- The available features vary depending on the computer model.
- The Vantage app makes periodic updates of the features to keep improving your experience with your computer. The description of features might be different from that on your actual user interface.

Lenovo Quick Clean



Depending on the model, your computer might support the Lenovo Quick Clean feature. The preinstalled Lenovo Quick Clean enables you to temporarily disable the keyboard, screen, trackpad, and TrackPoint pointing device for cleaning.

To access Lenovo Quick Clean, do one of the following:

- Open the Start menu and click **Lenovo Quick Clean**.
- Type **Lenovo Quick Clean** in the search box.
- Press **Fn** and the right **Shift** key at the same time.

To download the latest version of Lenovo Quick Clean, go to <https://pcsupport.lenovo.com>.

Smart features (for selected models)

Your computer might be preinstalled with Glance by Mirametrix. Glance can capture your eye direction and head position through camera and makes your computer smarter and more efficient.

Access Glance by Mirametrix

- Open the **Start** menu and click **Glance by Mirametrix**.
- Use Windows Search.

Note: If Glance is uninstalled, you can request it through <https://support.lenovo.com/contactus> for applicable system.

Explore key features

Depending on the model, some features might not be available on your computer.

- **Protect privacy**
 - **Presence Detection:** Keep your computer awake when in use and automatically lock the computer when your head moves out of the camera range.
 - **Privacy Alert:** When a shoulder surfer is detected, an alert icon appears on your computer screen.



- **Privacy Guard:** When a shoulder surfer is detected, your screen is blurred. Press Alt+F2 to cancel the blur effect.
- **Smart Display:** Blur screens you are not looking at. If you look away, all screens are blurred. Press Alt+F2 to cancel the blur effect.

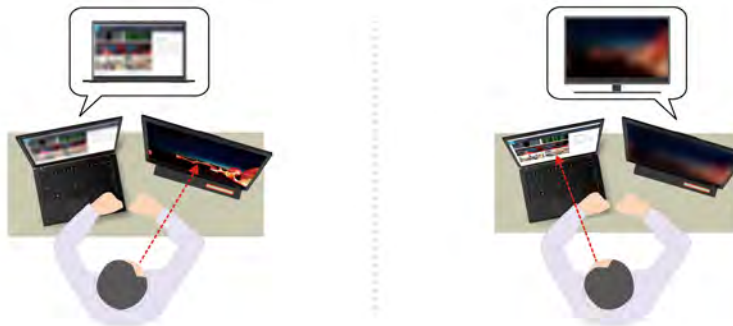

Note: If your computer comes with an ePrivacy screen, it can work with Glance to achieve better privacy protection. For details, go to <https://support.lenovo.com/us/en/videos/vid500144>.

- **Improve productivity**
 - **Smart Player:** Pause the media player when you look away from the screen. Smart Player might not work when you are using certain media players.
 - **Snap Window:** When your computer is connected to external displays and you select a window, the window automatically snaps to the top center of the screen you are facing.
 - **Smart Pointer:** Relocate the Windows pointer to the screen you are facing. When the pointer moves from screen to screen, it is momentarily drawn large.

Note: Snap Window and Smart Pointer only work with external displays. External displays should be positioned beside the computer on its same level.

- **Promote digital wellness**

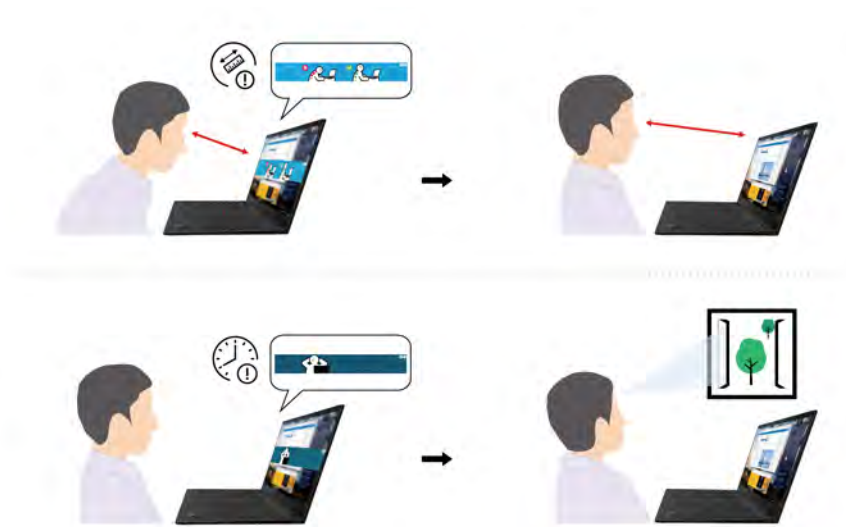

- **Posture check:** Remind you if you hunch toward the screen while using the computer.
- **20/20/20 Alert:** Remind you to look away from the screen for 20 seconds every 20 minutes.



Intelligent cooling

The Intelligent Cooling feature helps you adjust fan speed, computer temperature and performance. This feature works in auto mode by default. Press Fn+T to switch between manual mode and auto mode.

Manual mode

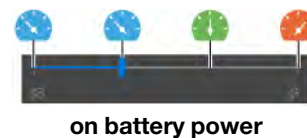
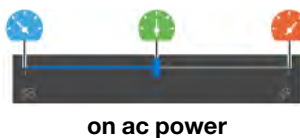

-  Quiet mode: the least fan noise
-  Balanced mode: balanced performance and fan noise
-  Performance mode: the highest performance and normal fan noise



Do the following to select the preferred mode:

1. Click the battery status icon in the Windows notification area.
2. Move the slider to the left or right to select your preferred mode.

Auto mode

-  Auto battery mode: Switch between quiet mode and battery mode automatically based on the amount of system activity.
-  Auto performance mode: Switch among quiet mode, balanced mode and performance mode automatically based on the amount of system activity.

Manage power

Use the information in this section to achieve the best balance between performance and power efficiency.

Check the battery status

Click the battery icon in the Windows notification area to check the battery status, view the current power plan, change the power mode, and access battery settings quickly. For more details about your battery, refer to the Vantage app.

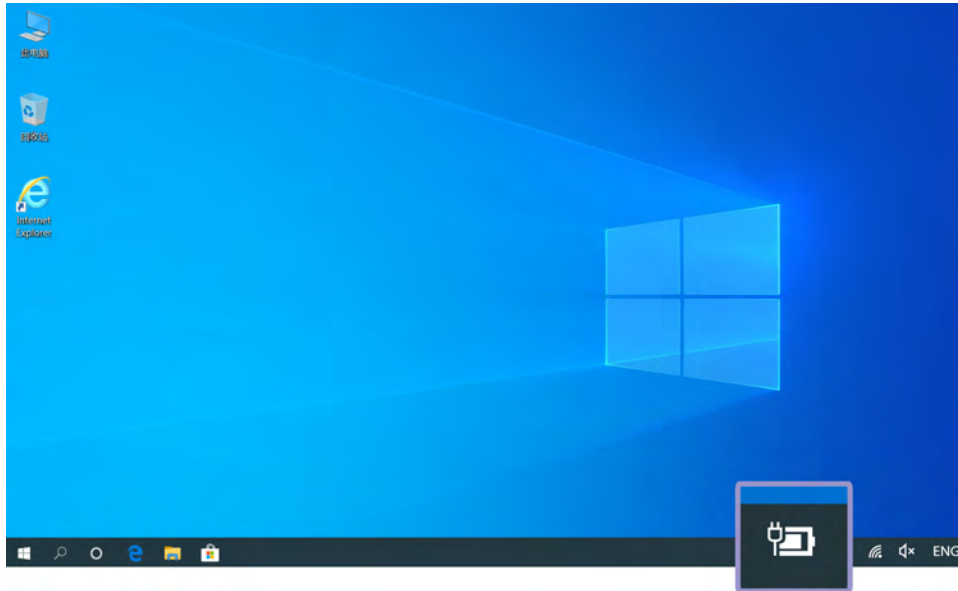

Charge the computer

Use ac power



Notes: To maximize the life of the battery:

- Use the battery until the charge is depleted and recharge the battery completely before using it. Once the battery is fully charged, it must discharge to 94% or lower before it will be allowed to recharge again.
- The battery may optimize its full charge capacity based on your usage. After prolonged periods of limited use, full battery capacity may not be available until you discharge to as low as 20% and recharge completely. For more information, refer to the power section of the Vantage app.

Use P-to-P 2.0 (Peer to Peer 2.0) charging function

Both Thunderbolt 4 connectors (USB-C) on the computer feature the Lenovo-unique P-to-P 2.0 charging function. To use the function, ensure that **Always On USB** and **Charge in Battery Mode** are enabled in UEFI BIOS of your computers, so that the function works even when the computers are off or in hibernation mode.

To enable **Always On USB** and **Charge in Battery Mode**:

1. Press F1 to enter the UEFI BIOS menu.
2. Click **Config** → **USB**, and then to enable **Always On USB** and **Charge in Battery Mode**.

- **When no ac power is available:**



Note: The remaining battery power of computer A should be at least 30% and be 3% higher than that of computer B.

- **When ac power is available:**

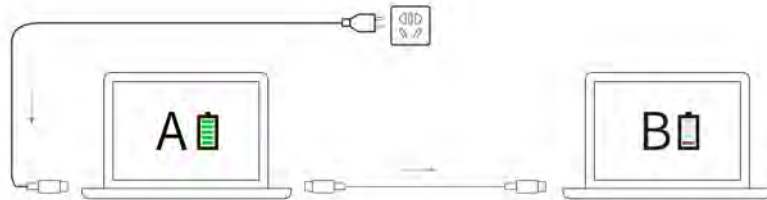

Note: The actual charging speed of your computer depends on many factors, such as the remaining battery power of the computers, the wattage of the ac power adapter, and whether you are using the computers.

Change the power settings

For ENERGY STAR® compliant computers, the following power plan takes effect when your computer has been idle for a specified duration:

- Turn off the display: After 10 minutes
- Put the computer to sleep: After 30 minutes

To reset the power plan:

1. Right-click the battery status icon and select **Power Options**.
2. Choose or customize a power plan of your preference.

To reset the power button function:

1. Right-click the battery status icon and select **Power Options** → **Choose what the power buttons do**.
2. Change the settings as you prefer.

Transfer data

Quickly share your files using the built-in Bluetooth or NFC technology among devices with the same features.

Set up a Bluetooth connection

You can connect all types of Bluetooth-enabled devices to your computer, such as a keyboard, a mouse, a smartphone, or speakers. To ensure successful connection, place the devices at most 10 meters (33 feet) from the computer.

1. Click the action center icon  in the Windows notification area, and enable the Bluetooth feature.
2. Right-click the **Bluetooth** icon.
3. Select **Go To Settings → Add Bluetooth or other device → Bluetooth**.
4. Select a Bluetooth device, and then follow the on-screen instructions.

Set up an NFC connection (for selected models)

If your computer supports NFC, you will see an NFC mark  around the trackpad area.

To turn on NFC:

1. Open the **Start** menu and click **Settings → Network & Internet → Airplane mode**.
2. Ensure that the Airplane mode is off and turn on the NFC function.

By using NFC, you can simply tap the left side of the trackpad to pair you computer with an NFC card or NFC-enabled device.



Note: Ensure that the NFC card is in NFC Data Exchange Format (NDEF), otherwise the card cannot be detected.

Accessories

This section provides instructions on how to use hardware accessories to expand your computer functionalities.

Purchase accessories

Lenovo has a number of hardware accessories and upgrades to help expand the functionalities of your computer. Options include memory modules, storage devices, network cards, port replicators or docking stations, batteries, power adapters, keyboards, mice, and more.

To shop at Lenovo, go to <https://www.lenovo.com/accessories>.

Chapter 4. Secure your computer and information

Lock the computer

Lock your computer to a desk, table, or other fixtures through a compatible security cable lock.

Note: The slot supports cable locks that conform to the Kensington NanoSaver® lock standards using Cleat™ locking technology. You are responsible for evaluating, selecting, and implementing the locking device and security feature. Lenovo is not responsible for the locking device and security feature. You can purchase the cable locks at <https://smartfind.lenovo.com>.



Log in with your fingerprint

The fingerprint reader is combined with the power button. You can use it to enroll your fingerprints. After enrollment, you can tap your finger on the fingerprint reader to log in to Windows.

1. Open the **Start** menu and then click **Settings** → **Accounts** → **Sign-in options**.
2. Follow the on-screen instructions to finish the enrollment.

Note: It is recommended that you put your finger at the middle of the fingerprint reader during enrollment and enroll more than one fingerprint in case of any injuries to your fingers. After the enrollment, the fingerprints are associated with the Windows password automatically.

3. Log in with your fingerprint. When the fingerprint reader indicator is solid green, tap your finger on the fingerprint reader for authentication.

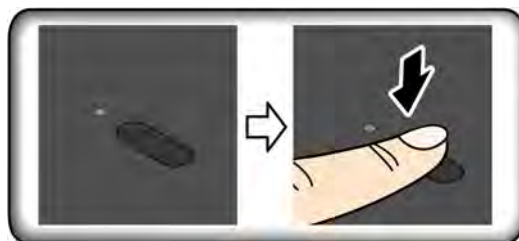

Associate your fingerprints with UEFI BIOS passwords

You can associate your fingerprints with your power-on password and hard disk password. See “Associate your fingerprints with passwords (for selected models)” on page 34.

Maintenance tips:

- Do not scratch the surface of the reader with anything hard.
- Do not use or touch the reader with a wet, dirty, wrinkled, or injured finger.

Log in with your face ID (for selected models)

Create your face ID and unlock your computer by scanning your face:

1. Open the **Start** menu and click **Settings → Accounts → Sign-in options**.
2. Locate the **Password** section and click **Add** to create a password.
3. Locate the **Windows Hello Face** section and click **Set up** under **Face Recognition**. Then, click **Get Started**. The camera preview starts.
4. Follow the on-screen instructions to create a Personal Identification Number (PIN) and complete the setup.
5. Click **Improve Recognition** to improve the image so that **Windows Hello** can recognize you in different light conditions or when your appearance changes.
6. Look straight at the camera to log in with your face ID.

Detect human presence (for selected models)

With a face ID created, your computer can support human presence detection.

- Unlock or wake up the computer automatically. You need to face the camera and be at most 1.4 meters (4.6 feet) from the computer. The function does not work when your computer is in hibernation mode or has been turned off.



- Dim the display and lock the computer when you are leaving. The function does not work if you set the power options to never turn off the display.



The human presence sensor is enabled by default. To disable the function:

1. Restart the computer. When the logo screen is displayed, press F1 to enter the UEFI BIOS menu.
2. Select **Security → I/O Port Access**, and then turn on or turn off **Human Presence Sensor**.

To customize the sensitivity of human presence detection:

1. Restart the computer. When the logo screen is displayed, press F1 to enter the UEFI BIOS menu.
2. Select **Security → Intelligent Security**, and then follow the on-screen instructions.



Notes:

- These features might not work when your computer is in tent, tablet, or stand mode.

- If the Airplane mode is enabled, human presence detection is disabled.
- Your computer uses a human presence sensor to detect your presence and the IR camera to recognize your face. Lenovo does not collect any personal data. For some countries or regions, the human presence sensor is disabled according to local regulations.

Protect your privacy (for selected models)

Use the ePrivacy screen



Your computer might come with an ePrivacy screen. It can reduce screen visibility from side angles to protect screen content against visual hacking. By default, this function is disabled. You can press F12 or Fn +D to enable it. You will be prompted by the on-screen icon  or  every time the function is enabled or disabled.

Your ePrivacy screen can work in case that you are required to input passwords. By default, this automatic function for passwords is disabled. You can enable it on the Vantage app.

The ePrivacy screen also can work with the preinstalled Glance app to better protect your privacy. For details, go to <https://support.lenovo.com/us/en/videos/vid500144>.

Set the privacy level

The privacy level of this function varies depending on the screen brightness level, the contrast ratio, and the physical environment where you are using this function.

- Press  to increase the privacy level.
- Press  to decrease the privacy level.

Protect data against power loss (for selected models)

NVMe (Non-Volatile Memory express) M.2 solid-state drive features the Lenovo-unique PLP (Power Loss Protection) function to avoid data loss or damage. If your computer is not responding and you might have to shut down your computer by pressing and holding the power button for several seconds. In this case, the PLP function enables your computer data to be saved timely. However, there is no guarantee that all data is saved in any situation. To check the type of your M.2 solid-state drive:

1. Restart the computer. When the logo screen is displayed, press F10 to enter the Lenovo diagnostics window.
2. On the TOOLS tab, select **SYSTEM INFORMATION** → **STORAGE** using the arrow keys.
3. Locate the **Device Type** section to check the information

UEFI BIOS passwords

You can set passwords in UEFI (Unified Extensible Firmware Interface) BIOS (Basic Input/Output System) to strengthen the security of your computer.

Password types

You can set a power-on password, supervisor password, system management password, or hard disk password in UEFI BIOS to prevent unauthorized access to your computer. However, you are not prompted to enter any UEFI BIOS password when your computer resumes from sleep mode.

Power-on password

If you set a power-on password, a window is displayed on the screen when you turn on the computer. Enter the correct password to use the computer.

Supervisor password

The supervisor password protects the system information stored in UEFI BIOS. When entering the UEFI BIOS menu, enter the correct supervisor password in the window prompted. You also can press Enter to skip the password prompt. However, you cannot change most of the system configuration options in UEFI BIOS.

If you have set both the supervisor password and power-on password, you can use the supervisor password to access your computer when you turn it on. The supervisor password overrides the power-on password.

System management password

The system management password can also protect the system information stored in UEFI BIOS like a supervisor password, but it has lower authority by default. The system management password can be set through the UEFI BIOS menu or through Windows Management Instrumentation (WMI) with the Lenovo client-management interface.

You can enable the system management password to have the same authority as the supervisor password to control security-related features. To customize the authority of the system management password through the UEFI BIOS menu:

1. Restart the computer. When the logo screen is displayed, press F1 to enter the UEFI BIOS menu.
2. Select **Security → Password → System Management Password Access Control**.
3. Follow the on-screen instructions.

If you have set both the supervisor password and the system management password, the supervisor password overrides the system management password. If you have set both the system management password and the power-on password, the system management password overrides the power-on password.

Hard disk passwords

The hard disk password prevents unauthorized access to the data on the storage drive. When a hard disk password is set, you are prompted to type a correct password each time you try to access the storage drive.

- **User hard disk password only**

When a user hard disk password is set without a master hard disk password, the user must enter the user hard disk password to access files and applications on the storage drive.

- **Master hard disk password + User hard disk password**

The master hard disk password is set and used by a system administrator. It enables the administrator to access any storage drive in a system or any computer connected in the same network. The administrator can also assign a user hard disk password for each computer in the network. The user of the computer can change the user hard disk password as desired, but only the administrator can remove the user hard disk password.

When prompted to enter a hard disk password, press F1 to switch between the master hard disk password and user hard disk password.

Notes: The hard disk password is not available in the following situations:

- A Trusted Computing Group (TCG) Opal-compliant storage drive and a TCG Opal management software program are installed in the computer, and the TCG Opal management software program is activated.

- An eDrive storage drive is installed in the computer preinstalled with the Windows 10 operating system.

Set, change, or remove a password

Before you start, print these instructions.

1. Restart the computer. When the logo screen is displayed, press F1 to enter the UEFI BIOS menu.
2. Select **Security** → **Password** by using the arrow keys.
3. Select the password type. Then, follow the on-screen instructions to set, change, or remove a password.

You should record all your passwords and store them in a safe place. If you forget any of your passwords, any potential repair actions required are not covered under warranty.

What to do if you forget your power-on password

If you forget your power-on password, do the following to remove the power-on password:

- If you have set a supervisor password or a system management password and remember it:
 1. Restart the computer. When the logo screen is displayed, immediately press F1.
 2. Type the supervisor password or the system management password to enter the UEFI BIOS menu.
 3. Select **Security** → **Password** → **Power-On Password** by using the arrow keys.
 4. Type the current supervisor password or the system management password in the **Enter Current Password** field. Then, leave the **Enter New Password** field blank, and press Enter twice.
 5. In the Changes have been saved window, press Enter.
 6. Press F10 to save changes and exit the UEFI BIOS menu.
- If you have not set a supervisor password or a system management password, contact a Lenovo authorized service provider to have the power-on password removed.

What to do if you forget your system management password

If you forget your system management password, do the following to remove the system management password:

- If you have set a supervisor password and remember it:
 1. Restart the computer. When the logo screen is displayed, immediately press F1.
 2. Type the supervisor password to enter the UEFI BIOS menu.
 3. Select **Security** → **Password** → **System Management Password** by using the arrow keys.
 4. Type the current supervisor password in the **Enter Current Password** field. Then, leave the **Enter New Password** field blank, and press Enter twice.
 5. In the Changes have been saved window, press Enter.
 6. Press F10 to save changes and exit the UEFI BIOS menu.
- If you have not set a supervisor password, contact a Lenovo authorized service provider to have the system management password removed.

What to do if you forget your hard disk password

If you forget your user hard disk password or both user and master hard disk passwords, there is no service procedure to remove the password or recover data from the storage drive. You can contact a Lenovo authorized service provider to have the storage drive replaced. A fee will be charged for parts and service. If the storage drive is a CRU (Customer Replaceable Unit), you can also contact Lenovo to purchase a new storage drive to replace the old one by yourself. To check whether the storage drive is a CRU and the relevant replacement procedure, see Chapter 6 “CRU replacement” on page 39.

What to do if you forget your supervisor password

If you forget your supervisor password, there is no service procedure to remove the password. You can contact a Lenovo authorized service provider to have the system board replaced. A fee will be charged for parts and service.

Associate your fingerprints with passwords (for selected models)

Do the following to associate your fingerprints with the power-on password and hard disk password:

1. Turn off and then turn on the computer.
2. When prompted, scan your finger on the fingerprint reader.
3. Enter your power-on password, hard disk password, or both as required. The association is established.

When you start the computer again, you can use your fingerprints to log in to the computer without entering your Windows password, power-on password, or hard disk password. To change settings, press F1 to enter the UEFI BIOS menu, and then select **Security → Fingerprint**.

Attention: If you always use your fingerprint to log in to the computer, you might forget your passwords. Write down your passwords, and keep them in a safe place.

Chapter 5. Configure advanced settings

UEFI BIOS

UEFI BIOS is the first program that the computer runs. When the computer turns on, UEFI BIOS performs a self test to make sure that various devices in the computer are functioning.

Enter the UEFI BIOS menu

Restart the computer. When the logo screen is displayed, press F1 to enter the UEFI BIOS menu.

Navigate in the UEFI BIOS interface

You can navigate in the UEFI BIOS interface by pressing the following keys:

- F1: General Help
- F9: Setup Defaults
- F10: Save and Exit
- F5 / F6: Change boot priority order
- ↑ ↓ or PgUp / PgDn: Select / Scroll page
- ← →: Move keyboard focus
- Esc: Back / Close dialog
- Enter: Select / Open submenu

Set the system date and time

1. Restart the computer. When the logo screen is displayed, press F1.
2. Select **Date/Time** and set the system date and time as desired.
3. Press F10 to save changes and exit.

Change the startup sequence

1. Restart the computer. When the logo screen is displayed, press F1.
2. Select **Startup → Boot**. Then, press Enter. The default device order list is displayed.

Note: No bootable device is displayed if the computer cannot start from any devices or the operating system cannot be found.

3. Set the startup sequence as desired.
4. Press F10 to save the changes and exit.

To change the startup sequence temporarily:

1. Restart the computer. When the logo screen is displayed, press F12.
2. Select the device that you want the computer to start from and press Enter.

Update UEFI BIOS

When you install a new program, device driver, or hardware component, you might need to update UEFI BIOS.

Download and install the latest UEFI BIOS update package by one of the following methods:

- Open the Vantage app to check the available update packages. If the latest UEFI BIOS update package is available, follow the on-screen instructions to download and install the package.
- Go to <https://pcsupport.lenovo.com> and select the entry for your computer. Then, follow the on-screen instructions to download and install the latest UEFI BIOS update package.

To know more about UEFI BIOS, visit Knowledge Base of your computer at <https://pcsupport.lenovo.com>.

Recovery

This section introduces the recovery information of the Windows 10 operating system. Ensure that you read and follow the on-screen recovery instructions. The data on your computer might be deleted during the recovery process. To avoid data loss, make a backup copy of all the data that you want to keep.

Restore system files and settings to an earlier point

1. Go to **Control Panel** and view by Large icons or Small icons.
2. Click **Recovery** → **Open System Restore**. Then, follow the on-screen instructions.

Restore your files from a backup

Note: If you use the File History tool to restore your files from a backup, ensure that you backed up your data earlier with the tool.

1. Go to **Control Panel** and view by Large icons or Small icons.
2. Click **File History** → **Restore personal files**. Then, follow the on-screen instructions.

Reset your computer

In the resetting process, you can choose to keep your files or remove them when you reinstall the operating system.

Note: The items in the graphical user interface (GUI) might change without notice.

1. Open the **Start** menu, and then click **Settings** → **Update & Security** → **Recovery**.
2. In the **Reset this PC** section, click **Get started**.
3. Follow the on-screen instructions to reset your computer.

Use advanced options

Note: The items in the graphical user interface (GUI) might change without notice.

1. Open the **Start** menu, and then click **Settings** → **Update & security** → **Recovery**.
2. In the **Advanced startup** section, click **Restart now** → **Troubleshoot** → **Advanced options**.
3. Select a preferred option, and then follow the on-screen instructions.

Windows automatic recovery

Note: Ensure that your computer is connected to ac power during the recovery process.

The Windows recovery environment on your computer operates independently from the Windows 10 operating system. It enables you to recover or repair the operating system even if the Windows 10 operating system fails to start.

After two consecutive failed boot attempts, the Windows recovery environment starts automatically. Then you can choose repair and recovery options by following the on-screen instructions.

To know more about recovery information, visit Knowledge Base of your computer at <https://pcsupport.lenovo.com>.

Create and use a recovery USB device

It is recommended that you create a recovery USB drive as early as possible as a backup for the Windows recovery programs. With the recovery USB drive, you can troubleshoot and fix the problems even if the preinstalled Windows recovery programs are damaged. If you did not create a recovery USB drive as a precautionary measure, you can contact Lenovo Customer Support Center and purchase one from Lenovo. For a list of the Lenovo Support phone numbers for your country or region, go to:

<https://pcsupport.lenovo.com/supportphonenumberlist>

Create a recovery USB drive

Attention: The creation process deletes anything stored on the USB drive. To avoid data loss, make a backup copy of all the data that you want to keep.

1. Ensure that your computer is connected to ac power.
2. Prepare a USB drive with at least 16 GB of storage capacity. The actual USB capacity required depends on the size of the recovery image.
3. Connect the prepared USB drive to the computer.
4. Type *recovery* in the search box. Then, click **Create a recovery drive**.
5. Click **Yes** in the User Account Control window to allow the Recovery Media Creator program to start.
6. In the Recovery Drive window, follow the on-screen instructions to create a recovery USB drive.

Use the recovery USB drive

1. Ensure that your computer is connected to ac power.
2. Connect the recovery USB drive to the computer.
3. Turn on or restart the computer. When the logo screen is displayed, press F12. The Boot Menu window opens.
4. Select the recovery USB drive as the boot device. Then, follow the on-screen instructions to complete the process.

Install Windows 10 and drivers

This section provides instructions on installing a Windows 10 operating system and device drivers.

Install a Windows 10 operating system

Microsoft constantly makes updates to the Windows 10 operating system. Before installing a particular Windows 10 version, check the compatibility list for the Windows version. For details, go to <https://support.lenovo.com/us/en/solutions/windows-support>.

Attention:

- It is recommended that you update your operating system through official channels. Any unofficial update might cause security risks.
- The process of installing a new operating system deletes all the data on your internal storage drive, including the data stored in a hidden folder.

1. If you are using the Windows BitLocker Drive Encryption feature and your computer has a Trusted Platform Module, ensure that you have disabled the feature.
2. Ensure that the security chip is set to **Active**.
 - a. Restart the computer. When the logo screen is displayed, press F1 to enter the UEFI BIOS menu.
 - b. Select **Security → Security Chip** and press Enter. The **Security Chip** submenu opens.
 - c. Ensure that the security chip for TPM 2.0 is set to **Active**.
 - d. Press F10 to save the settings and exit.
3. Connect the drive that contains the operating system installation program to the computer.
4. Restart the computer. When the logo screen is displayed, press F1 to enter the UEFI BIOS menu.
5. Select **Startup → Boot** to display the **Boot Priority Order** submenu.
6. Select the drive that contains the operating system installation program, for example, **USB HDD**. Then, press Esc.

Attention: After you change the startup sequence, ensure that you select the correct device during a copy, a save, or a format operation. If you select the wrong device, the data on that device might be erased or overwritten.

7. Select **Restart** and ensure that **OS Optimized Defaults** is enabled. Then, press F10 to save the settings and exit.
8. Follow the on-screen instructions to install the device drivers and necessary programs.
9. After installing the device drivers, apply Windows Update to get the latest updates, for example the security patches.

Install device drivers

You should download the latest driver for a component when you notice poor performance from that component or when you added a component. This action might eliminate the driver as the potential cause of a problem. Download and install the latest driver by one of the following methods:

- Open the Vantage app to check the available update packages. Select the update packages you want, and then follow the on-screen instructions to download and install the packages.
- Go to <https://pcsupport.lenovo.com> and select the entry for your computer. Then, follow the on-screen instructions to download and install necessary drivers and software.

Chapter 6. CRU replacement

Customer Replaceable Units (CRUs) are parts that can be upgraded or replaced by the customer. The computers contain the following types of CRUs:

- **Self-service CRUs:** Refer to parts that can be installed or replaced easily by customer themselves or by trained service technicians at an additional cost.
- **Optional-service CRUs:** Refer to parts that can be installed or replaced by customers with a greater skill level. Trained service technicians can also provide service to install or replace the parts under the type of warranty designated for the customer's machine.

If you intend on installing a CRU, Lenovo will ship the CRU to you. CRU information and replacement instructions are shipped with your product and are available from Lenovo at any time upon request. You might be required to return the defective part that is replaced by the CRU. When return is required: (1) return instructions, a prepaid shipping label, and a container will be included with the replacement CRU; and (2) you might be charged for the replacement CRU if Lenovo does not receive the defective CRU within thirty (30) days of your receipt of the replacement CRU. For full details, see the Lenovo Limited Warranty documentation at https://www.lenovo.com/warranty/llw_02.

CRU list

The following is a list of CRUs of your computer.

Self-service CRUs

- ac power adapter
- Base cover assembly
- Nano-SIM-card tray*
- Lenovo Integrated Pen (for ThinkPad X1 Yoga Gen 6 only)
- 2242 M.2 solid-state drive
- 2242 M.2 solid-state drive bracket

* for selected models

Disable Fast Startup and the built-in battery

Before replacing any CRU, ensure that you disable Fast Startup first and then disable the built-in battery.

To disable Fast Startup:

1. Go to **Control Panel** and view by Large icons or Small icons.
2. Click **Power Options**, and then click **Choose what the power buttons do** on the left pane.
3. Click **Change settings that are currently unavailable** at the top.
4. If prompted by User Account Control (UAC), click **Yes**.
5. Clear the **Turn on fast startup** check box, and then click **Save changes**.

To disable the built-in battery:

1. Restart your computer. When the logo screen is displayed, immediately press F1 to enter the UEFI BIOS menu.

2. Select **Config** → **Power**. The **Power** submenu is displayed.
3. Select **Disable Built-in Battery** and press Enter.
4. Select **Yes** in the Setup Confirmation window. The built-in battery is disabled and the computer turns off automatically. Wait three to five minutes to let the computer cool.

Replace a CRU

Follow the replacement procedure to replace a CRU.

Base cover assembly

Prerequisite

Before you start, read [Generic Safety and Compliance Notices](#) and print the following instructions.

Note: Do not remove the base cover assembly when your computer is connected to ac power. Otherwise, there might be a risk of short circuits.

For access, do the following:

1. Disable the built-in battery. See “Disable Fast Startup and the built-in battery” on page 39.
2. Turn off the computer and disconnect the computer from ac power and all connected cables.
3. Close the computer display and turn over the computer.

Removal procedure

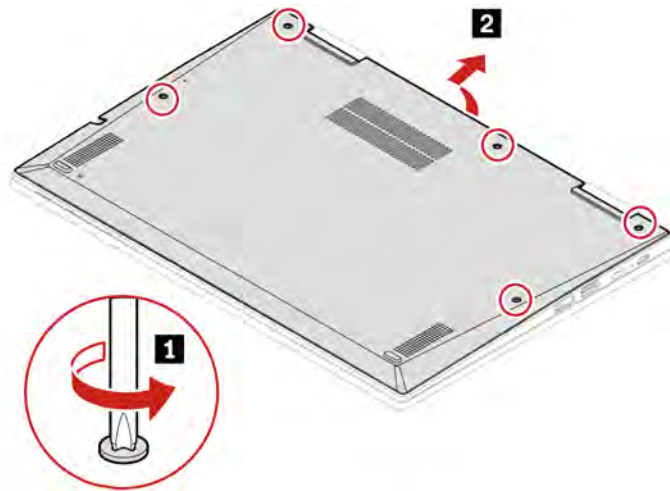

Installation procedure

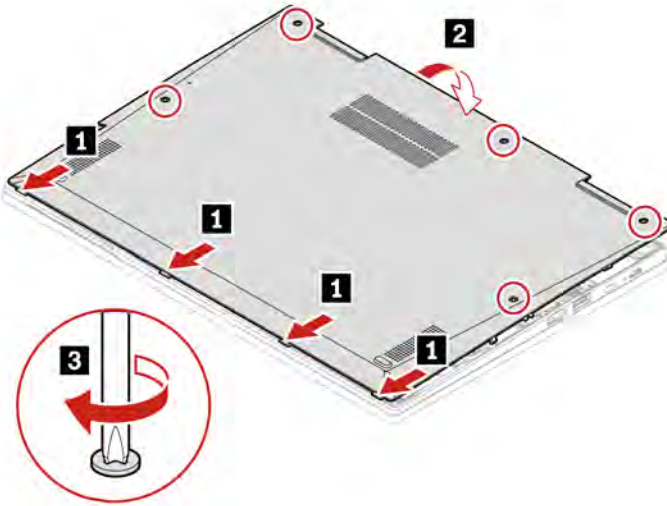

Troubleshooting

If the computer does not start up after you reinstall the base cover assembly, disconnect the ac power adapter and then reconnect it to the computer.

2242 M.2 solid-state drive

Prerequisite

Before you start, read [Generic Safety and Compliance Notices](#) and print the following instructions.

Attention: If you replace a 2242 M.2 solid-state drive, you might need to install a new operating system. For details on how to install a new operating system, see “Install Windows 10 and drivers” on page 37. The M.2 solid-state drive is sensitive. Inappropriate handling might cause damage and permanent loss of data.

When handling the M.2 solid-state drive, observe the following guidelines:

- Replace the M.2 solid-state drive only for upgrade or repair. The M.2 solid-state drive is not designed for frequent changes or replacement.
- Before replacing the M.2 solid-state drive, make a backup copy of all the data that you want to keep.
- Do not apply pressure to the M.2 solid-state drive.
- Do not touch the contact edge or circuit board of the M.2 solid-state drive. Otherwise, the M.2 solid-state drive might get damaged.
- Do not make the M.2 solid-state drive subject to physical shocks or vibration. Put the M.2 solid-state drive on a soft material, such as cloth, to absorb physical shocks.

For access, do the following:

1. Disable the built-in battery. See “Disable Fast Startup and the built-in battery” on page 39.
2. Turn off the computer and disconnect the computer from ac power and all connected cables.
3. Close the computer display and turn over the computer.
4. Remove the base cover assembly. See “Base cover assembly” on page 40.

Removal procedure

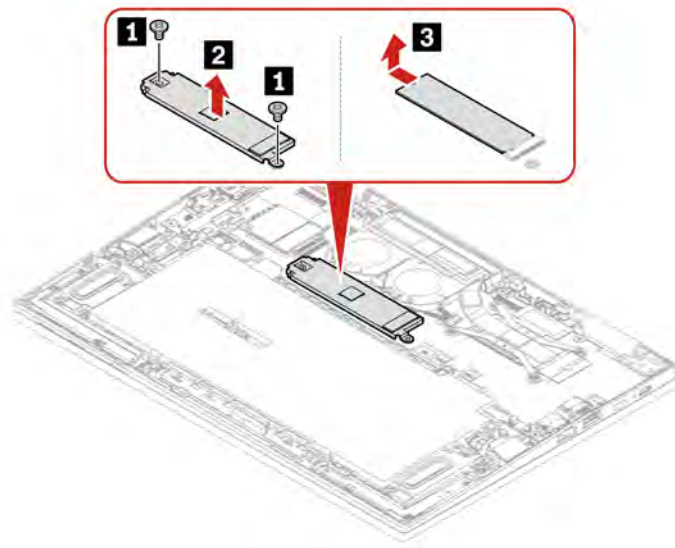

Chapter 7. Help and support

Frequently asked questions

How do I access Control Panel ?	<ul style="list-style-type: none">• Open the Start menu and click Windows System → Control Panel.• Use Windows Search.
How do I turn off my computer?	Open the Start menu and click Power . Then, click Shut down .
How do I partition my storage drive?	https://support.lenovo.com/solutions/ht503851
What do I do if my computer stops responding.	<ol style="list-style-type: none">1. Press and hold the power button until the computer turns off. Then, restart the computer.2. If step 1 does not work:<ul style="list-style-type: none">• For models with an emergency reset hole: Insert a straightened paper clip into the emergency reset hole to cut off power supply temporarily. Then, restart the computer with ac power connected.• For models without an emergency reset hole:<ul style="list-style-type: none">– For models with the removable battery, remove the removable battery and disconnect all power sources. Then, reconnect to ac power and restart the computer.– For models with the built-in battery, disconnect all power sources. Press and hold the power button for about seven seconds. Then, reconnect to ac power and restart the computer.
What do I do if I spill liquid on the computer?	<ol style="list-style-type: none">1. Carefully unplug the ac power adapter and turn off the computer immediately. The more quickly you stop the current from passing through the computer the more likely you will reduce damage from short circuits. Attention: Although you might lose some data or work by turning off the computer immediately, leaving the computer on might make your computer unusable.2. Do not try to drain out the liquid by turning over the computer. If your computer has keyboard drainage holes on the bottom, the liquid will be drained out through the holes.3. Wait until you are certain that all the liquid is dry before turning on your computer.
How do I enter the UEFI BIOS menu?	Restart the computer. When the logo screen is displayed, press F1 to enter the UEFI BIOS menu.
How do I disable my trackpad?	<ol style="list-style-type: none">1. Open the Start menu, and then click Settings → Devices → Touchpad.2. In the Touchpad section, turn off the Touchpad control.
Where can I get the latest device drivers and UEFI BIOS?	<ul style="list-style-type: none">• From the Vantage app. See “Install Windows 10 and drivers” on page 37 and “Update UEFI BIOS” on page 35.• Download from Lenovo Support Web site at https://pcsupport.lenovo.com.

Error messages

If you see a message that is not included in the following table, record the error message first, then shut down the computer and call Lenovo for help. See “Lenovo Customer Support Center” on page 48.

Message	Solution
0190: Critical low-battery error	The computer turned off because the battery power is low. Connect the ac power adapter to the computer and charge the batteries.
0191: System Security - Invalid remote change requested	The system configuration change has failed. Confirm the operation and try again.
0199: System Security - Security password retry count exceeded.	This message is displayed when you enter a wrong supervisor password more than three times. Confirm the supervisor password and try again.
0271: Check Date and Time settings.	The date or the time is not set in the computer. Enter the UEFI BIOS menu and set the date and time.
210x/211x: Detection/Read error on HDDx/SSDx	The storage drive is not working. Reinstall the storage drive. If the problem still exists, replace the storage drive.
Error: The non-volatile system UEFI variable storage is nearly full.	<p>Note: This error indicates that the operating system or programs cannot create, modify, or delete data in the non-volatile system UEFI variable storage due to insufficient storage space after POST.</p> <p>The non-volatile system UEFI variable storage is used by the UEFI BIOS and by the operating system or programs. This error occurs when the operating system or programs store large amounts of data in the variable storage. All data needed for POST, such as UEFI BIOS setup settings, chipset, or platform configuration data, are stored in a separate UEFI variable storage. Press F1 after the error message is displayed to enter the UEFI BIOS menu. A dialog asks for confirmation to clean up the storage. If you select “Yes”, all data that were created by the operating system or programs will be deleted except global variables defined by the Unified Extensible Firmware Interface Specification. If you select “No”, all data will be kept, but the operating system or programs will not be able to create, modify, or delete data in the storage.</p> <p>If this error happens at a service center, Lenovo authorized service personnel will clean up the non-volatile system UEFI variable storage using the preceding solution.</p>
Fan error. Press ESC to startup with limited performance.	The thermal fan might not work correctly. After the error message is displayed, press ESC within five seconds to start up the computer with limited performance. Otherwise, the computer will shut down immediately. If the problem still exists when you starts up next time, have your computer serviced.

Beep errors

Lenovo SmartBeep technology enables you to decode beep errors with your smartphone when a black screen occurs with beeps from your computer. To decode the beep error with Lenovo SmartBeep technology:

1. Go to <https://support.lenovo.com/smartbeep> or scan the following QR Code.



2. Download the proper diagnostic app and install it on your smartphone.
3. Run the diagnostic app and place the smartphone near the computer.
4. Press Fn on your computer to emit the beep again. The diagnostic app decodes the beep error and shows possible solutions on the smartphone.

Note: Do not attempt to service a product yourself unless instructed to do so by the Customer Support Center or product documentation. Only use a Lenovo-authorized service provider to repair your product.

Self-help resources

Use the following self-help resources to learn more about the computer and troubleshoot problems.

Resources	How to access?
<p>Use the Vantage app to:</p> <ul style="list-style-type: none">• Configure device settings.• Download and install UEFI BIOS, drivers, and firmware updates.• Secure your computer from outside threats.• Diagnose hardware problems.• Check the computer warranty status.• Access <i>User Guide</i> and helpful articles. <p>Note: The available features vary depending on the computer model.</p>	Type Vantage in the search box.
<p>Product documentation:</p> <ul style="list-style-type: none">• <i>Safety and Warranty Guide</i>• <i>Generic Safety and Compliance Notices</i>• <i>Setup Guide</i>• This <i>User Guide</i>• <i>Regulatory Notice</i>	Go to https://pcsupport.lenovo.com . Then, follow the on-screen instructions to filter out the documentation you want.
<p>Lenovo Support Web site with the latest support information of the following:</p> <ul style="list-style-type: none">• Drivers and software• Diagnostic solutions• Product and service warranty• Product and parts details• Knowledge base and frequently asked questions	https://pcsupport.lenovo.com
Windows help information	<ul style="list-style-type: none">• Open the Start menu and click Get Help or Tips.• Use Windows Search or the Cortana® personal assistant.• Microsoft support Web site: https://support.microsoft.com

Windows label

Your computer might have a Windows 10 Genuine Microsoft label affixed to its cover depending on the following factors:

- Your geographic location
- Edition of Windows 10 that is preinstalled

Go to <https://www.microsoft.com/en-us/howtotell/Hardware.aspx> for illustrations of the various types of Genuine Microsoft labels.

- In the People's Republic of China, the Genuine Microsoft label is required on all computer models preinstalled with any version of Windows 10.
- In other countries and regions, the Genuine Microsoft label is required only on computer models licensed for Windows 10 Pro.

The absence of a Genuine Microsoft label does not indicate that the preinstalled Windows version is not genuine. For details on how to tell whether your preinstalled Windows product is genuine, refer to the information provided by Microsoft at <https://www.microsoft.com/en-us/howtotell/default.aspx>.

There are no external, visual indicators of the Product ID or Windows version for which the computer is licensed. Instead, the Product ID is recorded in the computer firmware. Whenever a Windows 10 product is installed, the installation program checks the computer firmware for a valid, matching Product ID to complete the activation.

In some cases, an earlier Windows version might be preinstalled under the terms of the Windows 10 Pro license downgrade rights.

Call Lenovo

If you have tried to correct the problem yourself and still need help, you can call Lenovo Customer Support Center.

Before you contact Lenovo

Prepare the following before you contact Lenovo:

1. Record the problem symptoms and details:
 - What is the problem? Is it continuous or intermittent?
 - Any error message or error code?
 - What operating system are you using? Which version?
 - Which software applications were running at the time of the problem?
 - Can the problem be reproduced? If so, how?
2. Record the system information:
 - Product name
 - Machine type and serial number

The following illustration shows where to find the machine type and serial number of your computer.

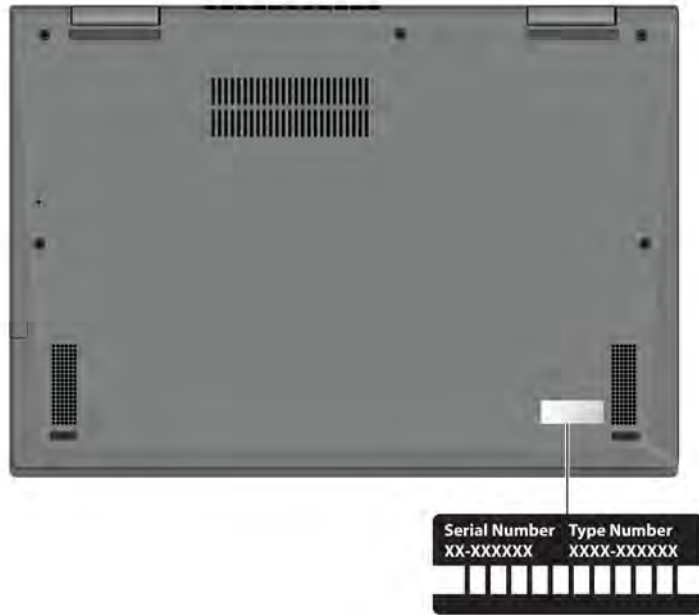

Lenovo Customer Support Center

During the warranty period, you can call Lenovo Customer Support Center for help.

Telephone numbers

For a list of the Lenovo Support phone numbers for your country or region, go to <https://pcsupport.lenovo.com/supportphonenumberlist> for the latest phone numbers.

Note: Phone numbers are subject to change without notice. If the number for your country or region is not provided, contact your Lenovo reseller or Lenovo marketing representative.

Services available during the warranty period

- Problem determination - Trained personnel are available to assist you with determining if you have a hardware problem and deciding what action is necessary to fix the problem.
- Lenovo hardware repair - If the problem is determined to be caused by Lenovo hardware under warranty, trained service personnel are available to provide the applicable level of service.
- Engineering change management - Occasionally, there might be changes that are required after a product has been sold. Lenovo or your reseller, if authorized by Lenovo, will make selected Engineering Changes (ECs) that apply to your hardware available.

Services not covered

- Replacement or use of parts not manufactured for or by Lenovo or nonwarranted parts
- Identification of software problem sources
- Configuration of UEFI BIOS as part of an installation or upgrade
- Changes, modifications, or upgrades to device drivers
- Installation and maintenance of network operating systems (NOS)
- Installation and maintenance of programs

For the terms and conditions of the Lenovo Limited Warranty that apply to your Lenovo hardware product, go to:

- https://www.lenovo.com/warranty/llw_02

- <https://pcsupport.lenovo.com/warrantylookup>

Purchase additional services

During and after the warranty period, you can purchase additional services from Lenovo at <https://www.lenovo.com/services>.

Service availability and service name might vary by country or region.

Appendix A. Accessibility and ergonomic information

This chapter provides information about accessibility and ergonomics.

Accessibility information

Lenovo is committed to providing users who have hearing, vision, and mobility limitations with greater access to information and technology. This section provides information about the ways these users can get the most out of their computer experience. You also can get the most up-to-date accessibility information from the following Web site:

<https://www.lenovo.com/accessibility>

Keyboard shortcuts

The following list contains keyboard shortcuts that can help make your computer easier to use.

Note: Depending on your keyboard, some of the following keyboard shortcuts might not be available.

- **Windows logo key + U:** Open Ease of Access Center
- **Right Shift for eight seconds:** Turn on or turn off Filter Keys
- **Shift five times:** Turn on or turn off Sticky Keys
- **Num Lock for five seconds:** Turn on or turn off Toggle Keys
- **Left Alt+Left Shift+Num Lock:** Turn on or turn off Mouse Keys
- **Left Alt+Left Shift+PrtScn (or PrtSc):** Turn on or turn off High Contrast

For more information, go to <https://windows.microsoft.com>, and then search using any of the following keywords: keyboard shortcuts, key combinations, shortcut keys.

Ease of Access Center

Ease of Access Center on the Windows operating system enables you to configure your computers to suit their physical and cognitive needs.

To access Ease of Access Center:

1. Go to **Control Panel** and view by Category.
2. Click **Ease of Access → Ease of Access Center**.
3. Choose the appropriate tool by following the on-screen instructions.

Ease of Access Center mainly includes the following tools:

- **Magnifier**
Magnifier is a useful utility that enlarges the entire screen or part of the screen so that you can see the items better.
- **Narrator**
Narrator is a screen reader that reads what is displayed on the screen aloud and describes events such as error messages.
- **On-Screen Keyboard**
If you prefer to type or enter data into your computer using a mouse, joystick, or other pointing device instead of a physical keyboard, you can use On-Screen Keyboard. On-Screen Keyboard displays a visual

keyboard with all the standard keys. You can select keys using the mouse or another pointing device, or you can tap to select the keys if your computer supports multi-touch screen.

- **High Contrast**

High Contrast is a feature that heightens the color contrast of some text and images on your screen. As a result, those items are more distinct and easier to identify.

- **Personalized keyboard**

Adjust keyboard settings to make your keyboard easier to use. For example, you can use your keyboard to control the pointer and make the keyboard easier to type certain key combinations.

- **Personalized mouse**

Adjust mouse settings to make your mouse easier to use. For example, you can change the pointer appearance and make your mouse easier to manage windows.

Speech Recognition

Speech Recognition enables you to control your computer by voice.

You can use verbal instructions to control the keyboard and mouse. With verbal instructions, you can start programs, open menus, click objects on the screen, dictate text into documents, and write and send e-mails.

To use Speech Recognition:

1. Go to **Control Panel** and view by Category.
2. Click **Ease of Access → Speech Recognition**.
3. Follow the on-screen instructions.

Screen-reader technologies

Screen-reader technologies are primarily focused on software program interfaces, help systems, and various online documents. For additional information about screen readers, see the following:

- Use PDFs with screen readers:
<https://www.adobe.com/accessibility.html?promoid=DJGVE>
- Use the JAWS screen reader:
<https://www.freedomscientific.com/Products/Blindness/JAWS>
- Use the NVDA screen reader:
<https://www.nvaccess.org/>

Screen resolution

You can make the text and images on your screen easier to read by adjusting the screen resolution of your computer.

To adjust the screen resolution:

1. Right-click a blank area on the desktop and then click **Display settings → Display**.
2. Follow the on-screen instructions.

Note: Setting a resolution too low might prevent some items from fitting on the screen.

Customizable item size

You can make the items on your screen easier to read by changing the item size.

- To change the item size temporarily, use the Magnifier tool in Ease of Access Center.
- To change the item size permanently:

- Change the size of all the items on your screen.
 1. Right-click a blank area on the desktop and then click **Display settings → Display**.
 2. Change the item size by following the on-screen instructions. For some applications, your configuration might not take effect until you sign out and then sign in again.
- Change the size of the items on a Web page.

Press and hold Ctrl, and then press the plus-sign key (+) to enlarge or the minus-sign key (–) to reduce the text size.
- Change the size of the items on the desktop or a window.

Note: This function might not work on some windows.

If your mouse has a wheel, press and hold Ctrl, and then scroll the wheel to change the item size.

Industry-standard connectors

Your computer provides industry-standard connectors that enable you to connect assistive devices.

Documentation in accessible formats

Lenovo provides electronic documentation in accessible formats, such as properly tagged PDF files or HyperText Markup Language (HTML) files. Lenovo electronic documentation is developed to ensure that visually impaired users can read the documentation through a screen reader. Each image in the documentation also includes adequate alternative text so that visually impaired users can understand the image when they use a screen reader.

Ergonomic information

Good ergonomic practice is important to get the most from your personal computer and to avoid discomfort. Arrange your workplace and the equipment you use to suit your individual needs and the kind of work that you perform. In addition, use healthy work habits to maximize your performance and comfort when using your computer.

Working in the virtual office might mean adapting to frequent changes in your environment. Adapting to the surrounding light sources, active seating, and the placement of your computer hardware, can help you improve your performance and achieve greater comfort.

This example shows someone in a conventional setting. Even when not in such a setting, you can follow many of these tips. Develop good habits, and they will serve you well.



General posture: Make minor modifications in your working posture to deter the onset of discomfort caused by long periods of working in the same position. Frequent short breaks from your work also help to prevent minor discomfort associated with your working posture.

Display: Position the display to maintain a comfortable viewing distance of 510 mm to 760 mm (20 inches to 30 inches). Avoid glare or reflections on the display from overhead lighting or outside sources of light. Keep the display screen clean and set the brightness to levels that enable you to see the screen clearly. Press the brightness control keys to adjust display brightness.

Head position: Keep your head and neck in a comfortable and neutral (vertical, or upright) position.

Chair: Use a chair that gives you good back support and seat height adjustment. Use chair adjustments to best suit your comfort posture.

Arm and hand position: If available, use chair arm rests or an area on your working surface to provide weight support for your arms. Keep your forearms, wrists, and hands in a relaxed and neutral (horizontal) position. Type with a soft touch without pounding the keys.

Leg position: Keep your thighs parallel to the floor and your feet flat on the floor or on a footrest.

What if you are traveling?

It might not be possible to observe the best ergonomic practices when you are using your computer while on the move or in a casual setting. Regardless of the setting, try to observe as many of the tips as possible. Sitting properly and using adequate lighting, for example, helps you maintain desirable levels of comfort and performance. If your work area is not in an office setting, ensure to take special note of employing active sitting and taking work breaks. Many product solutions are available to help you modify and expand your computer to best suit your needs. You can find some of these options at <https://www.lenovo.com/accessories>. Explore your options for docking solutions and external products that provide the adjustability and features that you want.

Questions about vision?

The visual display screens of notebook computers are designed to meet the highest standards. These visual display screens provide you with clear, crisp images and large, bright displays that are easy to see, yet easy on the eyes. Any concentrated and sustained visual activity can be tiring. If you have questions on eye fatigue or visual discomfort, consult a vision-care specialist for advice.

Appendix B. Compliance information

Note: For more compliance information, refer to *Generic Safety and Compliance Notices and Regulatory Notice* at <https://pcsupport.lenovo.com>.

Certification-related information

Product name	Compliance ID	Machine types
ThinPad X1 Yoga Gen 6	TP00128A	20XY and 20Y0
ThinkPad X1 Yoga Gen 6 HPD (for mainland China only)	TP00128A0*	
ThinkPad X1 Yoga Gen 6 LTE2 (for mainland China only)		
ThinkPad X1 Yoga Gen 6 5G (for mainland China only)		
ThinkPad X1 Yoga Gen 6 LTE2 HPD (for mainland China only)		
ThinkPad X1 Yoga Gen 6 5G HPD (for mainland China only)		
ThinkPad X1 Carbon Gen 9	TP00129A	20XW and 20XX
ThinkPad X1 Carbon Gen 9 HPD (for mainland China only)	TP00129A0*	
ThinkPad X1 Carbon Gen 9 LTE1 (for mainland China only)		
ThinkPad X1 Carbon Gen 9 LTE2 (for mainland China only)		
ThinkPad X1 Carbon Gen 9 5G (for mainland China only)		
ThinkPad X1 Carbon Gen 9 LTE1 HPD (for mainland China only)		
ThinkPad X1 Carbon Gen 9 LTE2 HPD (for mainland China only)		
ThinkPad X1 Carbon Gen 9 5G HPD (for mainland China only)		

* for India only

The latest compliance information is available at:

<https://www.lenovo.com/compliance>

Locate the UltraConnect wireless antennas

Your computer has an UltraConnect™ wireless antenna system. You can enable wireless communication wherever you are.

The following illustration shows the antenna locations on ThinkPad X1 Yoga Gen 6:



- 1** Wireless LAN antenna (auxiliary)
- 2** Wireless LAN antenna (main)
- 3** Wireless WAN antenna* (MIMO1)
- 4** Wireless WAN antenna* (main)
- 5** Wireless WAN antenna* (auxiliary)
- 6** Wireless WAN antenna* (MIMO2)

* for selected models

The following illustration shows the antenna locations on ThinkPad X1 Carbon Gen 9:



- 1 Wireless LAN antenna (main and auxiliary)
- 2 Wireless WAN antenna (MIMO1)*
- 3 Wireless WAN antenna (main)*
- 4 Wireless WAN antenna (auxiliary)*
- 5 Wireless WAN antenna (MIMO2)*

* for selected models

Federal Communications Commission (FCC) Supplier’s Declaration of Conformity

The following information refers to products below:

Product name	Machine types
ThinPad X1 Yoga Gen 6	20XY and 20Y0
ThinkPad X1 Carbon Gen 9	20XW and 20XX

This equipment has been tested and found to comply with the limits for a Class B digital device, pursuant to Part 15 of the FCC Rules. These limits are designed to provide reasonable protection against harmful interference in a residential installation. This equipment generates, uses, and can radiate radio frequency energy and, if not installed and used in accordance with the instructions, may cause harmful interference to radio communications. However, there is no guarantee that interference will not occur in a particular installation. If this equipment does cause harmful interference to radio or television reception, which can be determined by turning the equipment off and on, the user is encouraged to try to correct the interference by one or more of the following measures:

- Reorient or relocate the receiving antenna.
- Increase the separation between the equipment and receiver.
- Connect the equipment into an outlet on a circuit different from that to which the receiver is connected.
- Consult an authorized dealer or service representative for help.

Lenovo is not responsible for any radio or television interference caused by using other than recommended cables and connectors or by unauthorized changes or modifications to this equipment. Unauthorized changes or modifications could void the user's authority to operate the equipment.

This device complies with Part 15 of the FCC Rules. Operation is subject to the following two conditions: (1) this device may not cause harmful interference, and (2) this device must accept any interference received, including interference that may cause undesired operation.

Responsible Party:
Lenovo (United States) Incorporated
7001 Development Drive
Morrisville, NC 27560
Email: FCC@lenovo.com



FCC ID and IC Certification information

You can find the FCC and IC Certification information through one of the following methods:

- Through an electronic-label screen (E-label screen) preinstalled on your computer. To view the E-label screen, see “Regulatory labels” on page 59.
- On a physical label attached to the outside of your computer shipping carton.

Korea radio frequency compliance statement

무선설비 전파 혼신 (사용주파수 2400 ~ 2483.5 , 5725 ~ 5825 무선제품해당)

해당 무선설비가 전파혼신 가능성이 있으므로 인명안전과 관련된 서비스는 할 수 없음

SAR 정보

본 장치는 전파 노출에 대한 가이드라인을 충족합니다.

본 장치는 무선 송수신기입니다. 본 장치는 국제 가이드라인으로 권장되는 전파 노출에 대한 제한을 초과하지 않도록 설계되었습니다. 장치 액세서리 및 최신 부품을 사용할 경우 SAR 값이 달라질 수 있습니다. SAR 값은 국가 보고 및 테스트 요구 사항과 네트워크 대역에 따라 다를 수 있습니다. 본 장치는 사람의 신체에서 20mm 이상의 거리에서 사용할 수 있습니다.

Operating environment

Maximum altitude (without pressurization)

3048 m (10 000 ft)

Temperature

- Operating: 5°C to 35°C (41°F to 95°F)
- Storage and transportation in original shipping packaging: -20°C to 60°C (-4°F to 140°F)
- Storage without packaging: 5°C to 43°C (41°F to 109°F)

Note: When you charge the battery, its temperature must be no lower than 10°C (50°F).

Relative humidity

- Operating: 8% to 95% at wet-bulb temperature 23°C (73°F)
- Storage and transportation: 5% to 95% at wet-bulb temperature 27°C (81°F)

Regulatory labels

Depending on your country or region, you can find the government-required regulatory information through one of the following methods:

- On a physical label attached to the outside of your computer shipping carton
- On a physical label attached to your computer
- Through an electronic-label screen (E-label screen) preinstalled on your computer

To access the E-label screen, restart the computer. When the logo screen is displayed, press F9, or tap the prompt to enter the Startup Interrupt menu and the Regulatory Information option subsequently.

Korean E-label notice

이 제품은 전자적표시(e-labelling)가 되어있습니다.

Appendix C. Notices and trademarks

Notices

Lenovo may not offer the products, services, or features discussed in this document in all countries. Consult your local Lenovo representative for information on the products and services currently available in your area. Any reference to a Lenovo product, program, or service is not intended to state or imply that only that Lenovo product, program, or service may be used. Any functionally equivalent product, program, or service that does not infringe any Lenovo intellectual property right may be used instead. However, it is the user's responsibility to evaluate and verify the operation of any other product, program, or service.

Lenovo may have patents or pending patent programs covering subject matter described in this document. The furnishing of this document does not give you any license to these patents. You can send license inquiries, in writing, to:

*Lenovo (United States), Inc.
8001 Development Drive
Morrisville, NC 27560
U.S.A.
Attention: Lenovo Director of Licensing*

LENOVO PROVIDES THIS PUBLICATION "AS IS" WITHOUT WARRANTY OF ANY KIND, EITHER EXPRESS OR IMPLIED, INCLUDING, BUT NOT LIMITED TO, THE IMPLIED WARRANTIES OF NON-INFRINGEMENT, MERCHANTABILITY OR FITNESS FOR A PARTICULAR PURPOSE. Some jurisdictions do not allow disclaimer of express or implied warranties in certain transactions, therefore, this statement may not apply to you.

Changes are made periodically to the information herein; these changes will be incorporated in new editions of the publication. To provide better service, Lenovo reserves the right to improve and/or modify the products and software programs described in the manuals included with your computer, and the content of the manual, at any time without additional notice.

The software interface and function and hardware configuration described in the manuals included with your computer might not match exactly the actual configuration of the computer that you purchase. For the configuration of the product, refer to the related contract (if any) or product packing list, or consult the distributor for the product sales. Lenovo may use or distribute any of the information you supply in any way it believes appropriate without incurring any obligation to you.

The products described in this document are not intended for use in implantation or other life support applications where malfunction may result in injury or death to persons. The information contained in this document does not affect or change Lenovo product specifications or warranties. Nothing in this document shall operate as an express or implied license or indemnity under the intellectual property rights of Lenovo or third parties. All information contained in this document was obtained in specific environments and is presented as an illustration. The result obtained in other operating environments may vary.

Lenovo may use or distribute any of the information you supply in any way it believes appropriate without incurring any obligation to you.

Any references in this publication to non-Lenovo Web sites are provided for convenience only and do not in any manner serve as an endorsement of those Web sites. The materials at those Web sites are not part of the materials for this Lenovo product, and use of those Web sites is at your own risk.

Any performance data contained herein was determined in a controlled environment. Therefore, the result obtained in other operating environments may vary significantly. Some measurements may have been made on development-level systems and there is no guarantee that these measurements will be the same on generally available systems. Furthermore, some measurements may have been estimated through extrapolation. Actual results may vary. Users of this document should verify the applicable data for their specific environment.

This document is copyrighted by Lenovo and is not covered by any open source license, including any Linux® agreement(s) which may accompany software included with this product. Lenovo may update this document at any time without notice.

For the latest information or any questions or comments, contact or visit the Lenovo Web site:

<https://pcsupport.lenovo.com>

Trademarks

LENOVO, LENOVO logo, THINKPAD, THINKPAD logo, TRACKPOINT, and ULTRACONNECT are trademarks of Lenovo. Intel and Thunderbolt are trademarks of Intel Corporation or its subsidiaries in the U.S. and/or other countries. Microsoft, Windows, BitLocker, and Cortana are trademarks of the Microsoft group of companies. DisplayPort is a trademarks of the Video Electronics Standards Association. The terms HDMI and HDMI High-Definition Multimedia Interface are trademarks or registered trademarks of HDMI Licensing LLC in the United States and other countries. USB-C® is a registered trademark of USB Implementers Forum. Wi-Fi, Wi-Fi Alliance, and Miracast are registered trademarks of Wi-Fi Alliance. All other trademarks are the property of their respective owners. © 2021 Lenovo.