

FCC Test Report (Part 22)

Report No.: RF200109E02

FCC ID: 2AQ68T99W175

Test Model: T99W175

Received Date: Jan. 10, 2020

Test Date: Feb. 13 ~ Feb. 25, 2020

Issued Date: Mar. 13, 2020

Applicant: Hon Lin Technology Co., Ltd.

Address: 11F, No. 32, Jihu Rd., Neihu Dist., Taipei City 114, Taiwan R.O.C.

Issued By: Bureau Veritas Consumer Products Services (H.K.) Ltd., Taoyuan Branch
Lin Kou Laboratories

Lab Address: No. 47-2, 14th Ling, Chia Pau Vil., Lin Kou Dist., New Taipei City, Taiwan

Test Location: No.19, Hwa Ya 2nd Rd., Wen Hwa Vil., Kwei Shan Dist., Taoyuan City
33383, Taiwan

FCC Registration / 788550 / TW0003

Designation Number:



This report is for your exclusive use. Any copying or replication of this report to or for any other person or entity, or use of our name or trademark, is permitted only with our prior written permission. This report sets forth our findings solely with respect to the test samples identified herein. The results set forth in this report are not indicative or representative of the quality or characteristics of the lot from which a test sample was taken or any similar or identical product unless specifically and expressly noted. Our report includes all of the tests requested by you and the results thereof based upon the information that you provided to us. You have 60 days from date of issuance of this report to notify us of any material error or omission caused by our negligence, provided, however, that such notice shall be in writing and shall specifically address the issue you wish to raise. A failure to raise such issue within the prescribed time shall constitute your unqualified acceptance of the completeness of this report, the tests conducted and the correctness of the report contents. Unless specific mention, the uncertainty of measurement has been explicitly taken into account to declare the compliance or non-compliance to the specification. The report must not be used by the client to claim product certification, approval, or endorsement by TAF or any government agencies

Table of Contents

Release Control Record	4
1 Certificate of Conformity	5
2 Summary of Test Results	6
2.1 Measurement Uncertainty.....	6
2.2 Test Site and Instruments.....	7
3 General Information	8
3.1 General Description of EUT.....	8
3.2 Configuration of System under Test.....	12
3.2.1 Description of Support Units.....	12
3.3 Test Mode Applicability and Tested Channel Detail.....	13
3.4 EUT Operating Conditions.....	19
3.5 General Description of Applied Standards and References.....	19
4 Test Types and Results	20
4.1 Output Power Measurement.....	20
4.1.1 Limits of Output Power Measurement.....	20
4.1.2 Test Procedures.....	20
4.1.3 Test Setup.....	20
4.1.4 Test Results.....	21
4.2 Modulation Characteristics Measurement.....	41
4.2.1 Limits of Modulation Characteristics.....	41
4.2.2 Test Procedure.....	41
4.2.3 Test Setup.....	41
4.2.4 Test Results.....	42
4.3 Frequency Stability Measurement.....	45
4.3.1 Limits of Frequency Stability Measurement.....	45
4.3.2 Test Procedure.....	45
4.3.3 Test Setup.....	45
4.3.4 Test Results.....	46
4.4 Occupied Bandwidth Measurement.....	56
4.4.1 Test Procedure.....	56
4.4.2 Test Setup.....	56
4.4.3 Test Result.....	57
4.5 Band Edge Measurement.....	67
4.5.1 Limits of Band Edge Measurement.....	67
4.5.2 Test Setup.....	67
4.5.3 Test Procedures.....	67
4.5.4 Test Results.....	68
4.6 Peak to Average Ratio.....	78
4.6.1 Limits of Peak to Average Ratio Measurement.....	78
4.6.2 Test Setup.....	78
4.6.3 Test Procedures.....	78
4.6.4 Test Results.....	79
4.7 Conducted Spurious Emissions.....	84
4.7.1 Limits of Conducted Spurious Emissions Measurement.....	84
4.7.2 Test Setup.....	84
4.7.3 Test Procedure.....	84
4.7.4 Test Results.....	85
4.8 Radiated Emission Measurement.....	97
4.8.1 Limits of Radiated Emission Measurement.....	97
4.8.2 Test Procedure.....	97
4.8.3 Deviation from Test Standard.....	97
4.8.4 Test Setup.....	98
4.8.5 Test Results.....	99

5	Pictures of Test Arrangements.....	119
	Appendix – Information of the Testing Laboratories	120



Release Control Record

Issue No.	Description	Date Issued
RF200109E02	Original release	Mar. 13, 2020

1 Certificate of Conformity

Product: 5G WWAN Module

Brand: Foxconn

Test Model: T99W175

Sample Status: Engineering Sample

Applicant: Hon Lin Technology Co., Ltd.

Test Date: Feb. 13 ~ Feb. 25, 2020

Standards: FCC Part 22, Subpart H

The above equipment has been tested by **Bureau Veritas Consumer Products Services (H.K.) Ltd., Taoyuan Branch**, and found compliance with the requirement of the above standards. The test record, data evaluation & Equipment Under Test (EUT) configurations represented herein are true and accurate accounts of the measurements of the sample's RF characteristics under the conditions specified in this report.

Prepared by : Pettie Chen , **Date:** Mar. 13, 2020
Pettie Chen / Senior Specialist

Approved by : Bruce Chen , **Date:** Mar. 13, 2020
Bruce Chen / Senior Project Engineer

2 Summary of Test Results

Applied Standard: FCC Part 22 & Part 2			
FCC Clause	Test Item	Result	Remarks
2.1046 22.913 (a)	Effective radiated power	Pass	Meet the requirement of limit.
2.1047	Modulation Characteristics	Pass	Meet the requirement
22.913 (d)	Peak To Average Ratio	Pass	Meet the requirement of limit.
2.1055 22.355	Frequency Stability	Pass	Meet the requirement of limit.
2.1049	Occupied Bandwidth	Pass	Meet the requirement of limit.
22.917	Band Edge Measurements	Pass	Meet the requirement of limit.
2.1051 22.917	Conducted Spurious Emissions	Pass	Meet the requirement of limit.
2.1053 22.917	Radiated Spurious Emissions	Pass	Meet the requirement of limit. Minimum passing margin is -26.5dB at 44.55MHz.

Note: Determining compliance based on the results of the compliance measurement, not taking into account measurement instrumentation uncertainty.

2.1 Measurement Uncertainty

Where relevant, the following measurement uncertainty levels have been estimated for tests performed on the EUT as specified in CISPR 16-4-2:

Measurement	Frequency	Expanded Uncertainty (k=2) (\pm)
Radiated Emissions up to 1 GHz	9kHz ~ 30MHz	3.04 dB
	30MHz ~ 200MHz	3.63 dB
	200MHz ~ 1000MHz	3.64 dB
Radiated Emissions above 1 GHz	1GHz ~ 18GHz	2.29 dB
	18GHz ~ 40GHz	2.29 dB

2.2 Test Site and Instruments

Description & Manufacturer	Model No.	Serial No.	Cal. Date	Cal. Due
Test Receiver ROHDE & SCHWARZ	ESCI	100424	Dec. 31, 2019	Dec. 30, 2020
Spectrum Analyzer ROHDE & SCHWARZ	FSP40	100040	Sep. 23, 2019	Sep. 22, 2020
Spectrum Analyzer KEYSIGHT	N9030B	MY57140953	Jul. 03, 2019	Jul. 02, 2020
Radio Communication Analyzer Anritsu	MT8821C	6261806803	Jan. 18, 2020	Jan. 17, 2021
MXG Vector signal generator Agilent	N5182B	MY53050162	Jan. 14, 2020	Jan. 13, 2021
BILOG Antenna SCHWARZBECK	VULB9168	9168-158	Nov. 08, 2019	Nov. 07, 2020
BILOG Antenna SCHWARZBECK	VULB9168	9168-155	Nov. 11, 2019	Nov. 10, 2020
HORN Antenna SCHWARZBECK	BBHA 9120D	9120D-1170	Nov. 24, 2019	Nov. 23, 2020
HORN Antenna SCHWARZBECK	BBHA 9170	BBHA9170241	Nov. 24, 2019	Nov. 23, 2020
Loop Antenna TESEQ	HLA 6121	45745	Jul. 01, 2019	Jun. 30, 2020
Preamplifier Agilent (Below 1GHz)	8447D	2944A10631	Jul. 11, 2019	Jul. 10, 2020
Preamplifier KEYSIGHT (Above 1GHz)	83017A	MY53270295	Jun. 11, 2019	Jun. 10, 2020
RF Coaxial Cable WOKEN With 5dB PAD	8D-FB	Cable-CH4-01	Aug. 20, 2019	Aug. 19, 2020
RF Coaxial Cable EMCI	EMC102-KM-KM-3000	150929	Aug. 20, 2019	Aug. 19, 2020
RF Coaxial Cable EMCI	EMC102-KM-KM-600	150928	Aug. 20, 2019	Aug. 19, 2020
RF signal cable HUBER+SUHNER	SUCOFLEX 104	MY 13380+295012/04	Jul. 11, 2019	Jul. 10, 2020
RF signal cable HUBER+SUHNER	SUCOFLEX 104	Cable-CH4-03 (250724)	Jul. 11, 2019	Jul. 10, 2020
Software BV ADT	ADT_Radiated_V7.6.15.9.5	NA	NA	NA
Antenna Tower inn-co GmbH	MA 4000	010303	NA	NA
Antenna Tower Controller BV ADT	AT100	AT93021703	NA	NA
Boresight Antenna Fixture	FBA-01	FBA-SIP01	NA	NA
Standard Temperature And Humidity Chamber	MHU-225AU	920842	May 31, 2019	May 30, 2020
JFW 20dB attenuation	50HF-020-SMA	NA	NA	NA
True RMS Clamp Meter Fluke	325	31130711WS	May 21, 2019	May 20, 2020
DC power supply	U8002A	MY56330015	NA	NA

Note: 1. The calibration interval of the above test instruments is 12 months and the calibrations are traceable to NML/ROC and NIST/USA.

2. The test was performed in HwaYa Chamber 4.

3 General Information

3.1 General Description of EUT

Product	5G WWAN Module	
Brand	Foxconn	
Test Model	T99W175	
Sample Status	Engineering Sample	
Power Supply Rating	5 Vdc (Host equipment) 3.135Vdc~3.63Vdc (Module)	
Modulation Type	WCDMA: BPSK, QPSK HSDPA: BPSK HSUPA: QPSK LTE: QPSK, 16QAM, 64QAM	
Operating Frequency	WCDMA Band 5	826.4~846.6MHz
	LTE Band 5 (Channel Bandwidth 1.4MHz)	824.7~848.3MHz
	LTE Band 5 (Channel Bandwidth 3MHz)	825.5~847.5MHz
	LTE Band 5 (Channel Bandwidth 5MHz)	826.5~846.5MHz
	LTE Band 5 (Channel Bandwidth 10MHz)	829.0~844.0MHz
	LTE Band 26 (Channel Bandwidth 1.4MHz)	824.7~848.3MHz
	LTE Band 26 (Channel Bandwidth 3MHz)	825.5~847.5MHz
	LTE Band 26 (Channel Bandwidth 5MHz)	826.5~846.5MHz
	LTE Band 26 (Channel Bandwidth 10MHz)	829.0~844.0MHz
	LTE Band 26 (Channel Bandwidth 15MHz)	831.5~841.5MHz

Max. ERP Power	WCDMA Band 5	327.341mW (25.15dBm)		
		QPSK	16QAM	64QAM
	LTE Band 5 (Channel Bandwidth 1.4MHz)	358.922mW (25.55dBm)	292.415mW (24.66dBm)	214.289mW (23.31dBm)
	LTE Band 5 (Channel Bandwidth 3MHz)	365.595mW (25.63dBm)	304.789mW (24.84dBm)	229.087mW (23.60dBm)
	LTE Band 5 (Channel Bandwidth 5MHz)	365.595mW (25.63dBm)	320.627mW (25.06dBm)	232.809mW (23.67dBm)
	LTE Band 5 (Channel Bandwidth 10MHz)	383.707mW (25.84dBm)	327.341mW (25.15dBm)	232.274mW (23.66dBm)
	LTE Band 26 (Channel Bandwidth 1.4MHz)	358.096mW (25.54dBm)	295.801mW (24.71dBm)	218.776mW (23.40dBm)
	LTE Band 26 (Channel Bandwidth 3MHz)	366.438mW (25.64dBm)	322.849mW (25.09dBm)	221.820mW (23.46dBm)
	LTE Band 26 (Channel Bandwidth 5MHz)	366.438mW (25.64dBm)	315.500mW (24.99dBm)	215.774mW (23.34dBm)
	LTE Band 26 (Channel Bandwidth 10MHz)	357.273mW (25.53dBm)	321.366mW (25.07dBm)	231.739mW (23.65dBm)
	LTE Band 26 (Channel Bandwidth 15MHz)	365.595mW (25.63dBm)	331.131mW (25.20dBm)	238.232mW (23.77dBm)
Emission Designator	WCDMA Band 5	4M16F9W		
		QPSK	16QAM	64QAM
	LTE Band 5 (Channel Bandwidth 1.4MHz)	1M09G7D	1M09D7W	1M09D7W
	LTE Band 5 (Channel Bandwidth 3MHz)	2M70G7D	2M70D7W	2M70D7W
	LTE Band 5 (Channel Bandwidth 5MHz)	4M49G7D	4M49D7W	4M49D7W
	LTE Band 5 (Channel Bandwidth 10MHz)	8M96G7D	8M96D7W	8M95D7W
	LTE Band 26 (Channel Bandwidth 1.4MHz)	1M09G7D	1M09D7W	1M09D7W
	LTE Band 26 (Channel Bandwidth 3MHz)	2M70G7D	2M70D7W	2M70D7W
	LTE Band 26 (Channel Bandwidth 5MHz)	4M49G7D	4M49D7W	4M49D7W
	LTE Band 26 (Channel Bandwidth 10MHz)	8M95G7D	8M96D7W	8M95D7W
LTE Band 26 (Channel Bandwidth 15MHz)	13M4G7D	13M4D7W	13M4D7W	
Antenna Type	Refer to Note as below			
Antenna Connector	Refer to Note as below			
Accessory Device	NA			
Cable Supplied	NA			

Note:

- There are four Difference HW of T99W175.

Brand	Model	HW
Foxconn	T99W175	1. 3G+LTE+Sub6+eSIM
		2. 3G+LTE+Sub6 only w/o eSIM
		3. 3G+LTE+Sub6+eSIM+GNSS connector
		4. 3G+LTE+Sub6 only+w/o eSIM+GNSS connector

*After pre-testing, "HW: 1. 3G+LTE+Sub6+eSIM" is the worst for the final tests.

2. The following antennas were provided to the EUT.

Antenna No.	RF Chain No.	Brand	Model	Antenna Net Gain(dBi)	Frequency range (MHz)	Antenna Type	Connector Type
1		WHA YU	C107-511720-A	4.41	660~803	PCB	I-PEX
2		WHA YU	C107-511721-A	3.81 4.03	791~960 1447.9~1606	PCB	I-PEX
3		WHA YU	C107-511722-A	4.27 5.31	1710~2170 2500~2690	PCB	I-PEX
4		WHA YU	C107-511723-A	2.99 0.92	2300~2400 3500~3700	PCB	I-PEX
5		WHA YU	C107-511724-A	6.45	5150~5925	PCB	I-PEX
6		WHA YU	C107-511725-A	4.89	3400~3700	PCB	I-PEX
7		AVX	5000106-R1-X01	2.91	699~803	Monopole	I-PEX
8		AVX	5000107-R1-X01	2.59	791~960	Monopole	I-PEX
9		AVX	5000108-R1-X01	2.85	1427~1610	Monopole	I-PEX
10		AVX	5000109-R1-X01	2.23 2.94	1710~2200 5150~5925	Monopole	I-PEX
11		AVX	5000110-R1-X01	0.9	2300~2690	Monopole	I-PEX
12		AVX	5000111-R1-X01	0.87	3300~5000	Monopole	I-PEX
13	Tx1/ Rx1	Ethertronics	5003806	0.4 -1.61 0.39 2.95 1.98 0.38 0.83 2.31	698-821 824-960 1425-1515 1710-2200 2300-2690 3300-4200 4400-5000 5150-5925	PIFA	I-PEX
	Rx2	Ethertronics	5003807	-2.24 -4.52 2.87 2.99 2.93 2.91 2.23 -0.85 -3.04	716-821 824-960 1425-1515 1557-1610 1805-2200 2300-2690 3300-4200 4400-5000 5150-5925	PIFA	I-PEX
	Tx2/ Rx3	Ethertronics	5003806	2.21 2.25 -0.45 2.6	1710-2200 2300-2690 3300-4200 4400-5000	PIFA	I-PEX
	Rx4	Ethertronics	5003700	1.38 2.87 0.6 -2.09	1805-2200 2300-2690 3300-4200 4400-5000	PIFA	I-PEX

Antenna No.	RF Chain No.	Brand	Model	Antenna Net Gain(dBi)	Frequency range (MHz)	Antenna Type	Connector Type
14	Ant. 0 (TX/RX)	Master Wave	NA	2.4 2.2 2.9 2.9 2.9 NA	880~960 1020~2170 2545~2595 3565~3600 3900~4000 GPS	PCB	I-PEX
	Ant. 2 (TX/RX)	Master Wave	NA	NA 2.2 2.8 2.9 2.8 NA	880~960 1020~2170 2545~2595 3565~3600 3900~4000 GPS	PCB	I-PEX
	Ant. 1 (RX)	Master Wave	NA	NA 5.3 5.1 4.3 4.5 NA	880~960 1020~2170 2545~2595 3565~3600 3900~4000 GPS	PCB	I-PEX
	Ant. 3 (RX)	Master Wave	NA	1.3 6.8 3.7 6.4 6.2 3.7	880~960 1020~2170 2545~2595 3565~3600 3900~4000 GPS	PCB	I-PEX

*The antenna for the final tests as following table.

	Band	Antenna
WCDMA	2	Antenna 3
	4	Antenna 3
	5	Antenna 2
LTE	2	Antenna 3
	4	Antenna 3
	5	Antenna 2
	7	Antenna 3
	12	Antenna 1
	13	Antenna 1
	14	Antenna 1
	17	Antenna 1
	25	Antenna 3
	26	Antenna 2
	30	Antenna 4
	66	Antenna 3
	71	Antenna 1
	38	Antenna 3
	41	Antenna 3
48	Antenna 4	

3.2 Configuration of System under Test

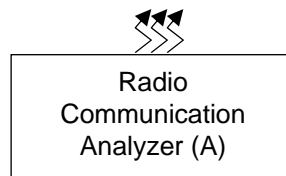
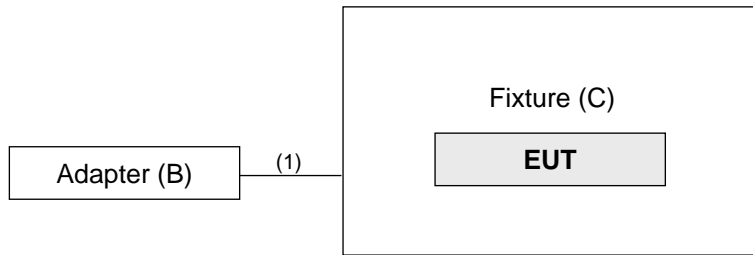

3.2.1 Description of Support Units

The EUT has been tested as an independent unit together with other necessary accessories or support units. The following support units or accessories were used to form a representative test configuration during the tests.

ID	Product	Brand	Model No.	Serial No.	FCC ID	Remarks
A.	Radio Communication Analyzer	Anritsu	MT8821C	6261806803	NA	-
B.	Adapter	LITEON	PA-1050-39	NA	NA	-
C.	Fixture	NA	NA	NA	NA	Provided by client.

Note:

1. All power cords of the above support units are non-shielded (1.8m).
2. Item A acted as a communication partner to transfer data.

ID	Descriptions	Qty.	Length (m)	Shielding (Yes/No)	Cores (Qty.)	Remarks
1.	USB cable	1	1.5	Y	0	-

3.3 Test Mode Applicability and Tested Channel Detail

Pre-Scan has been conducted to determine the worst-case mode from all possible combinations between available modulations, data rates, XYZ axis and antenna ports. The worst case was found when positioned on Z-plane. Following channel(s) was (were) selected for the final test as listed below.

WCDMA Band 5

EUT Configure Mode	Test Item	Available Channel	Tested Channel	Mode
-	ERP	4132 to 4233	4132 (826.4MHz), 4182 (836.4MHz), 4233 (846.6MHz)	WCDMA
-	Modulation Characteristics	4132 to 4233	4182 (836.4MHz)	WCDMA, HSDPA, HSUPA
-	Frequency Stability	4132 to 4233	4132 (826.4MHz), 4233 (846.6MHz)	WCDMA
-	Occupied Bandwidth	4132 to 4233	4132 (826.4MHz), 4182 (836.4MHz), 4233 (846.6MHz)	WCDMA, HSDPA, HSUPA
-	Band Edge	4132 to 4233	4132 (826.4MHz), 4233 (846.6MHz)	WCDMA, HSDPA, HSUPA
-	Peak To Average Ratio	4132 to 4233	4132 (826.4MHz), 4182 (836.4MHz), 4233 (846.6MHz)	WCDMA, HSDPA, HSUPA
-	Conducted Emission	4132 to 4233	4132 (826.4MHz), 4182 (836.4MHz), 4233 (846.6MHz)	WCDMA, HSDPA, HSUPA
-	Radiated Emission Below 1GHz	4132 to 4233	4233 (846.6MHz)	WCDMA
-	Radiated Emission Above 1GHz	4132 to 4233	4132 (826.4MHz), 4182 (836.4MHz), 4233 (846.6MHz)	WCDMA

Note: For radiated emission below 1GHz, select the worst radiated emission (above 1GHz) channel for final testing.

LTE Band 5

EUT Configure Mode	Test item	Available channel	Tested channel	Channel Bandwidth	Modulation	Mode
-	ERP	20407 to 20643	20407(824.7MHz), 20525(836.5MHz), 20643(848.3MHz)	1.4MHz	QPSK / 16QAM / 64QAM	1 RB / 0 RB Offset 1 RB / 2 RB Offset 1 RB / 5 RB Offset 3 RB / 0 RB Offset 3 RB / 1 RB Offset 3 RB / 3 RB Offset 6 RB / 0 RB Offset
		20415 to 20635	20415(825.5MHz), 20525(836.5MHz), 20635(847.5MHz)	3MHz	QPSK / 16QAM / 64QAM	1 RB / 0 RB Offset 1 RB / 7 RB Offset 1 RB / 14 RB Offset 8 RB / 0 RB Offset 8 RB / 3 RB Offset 8 RB / 7 RB Offset 15 RB / 0 RB Offset
		20425 to 20625	20425(826.5MHz), 20525(836.5MHz), 20625(846.5MHz)	5MHz	QPSK / 16QAM / 64QAM	1 RB / 0 RB Offset 1 RB / 12 RB Offset 1 RB / 24 RB Offset 12 RB / 0 RB Offset 12 RB / 6 RB Offset 12 RB / 13 RB Offset 25 RB / 0 RB Offset
		20450 to 20600	20450(829.0MHz), 20525(836.5MHz), 20600(844.0MHz)	10MHz	QPSK / 16QAM / 64QAM	1 RB / 0 RB Offset 1 RB / 24 RB Offset 1 RB / 49 RB Offset 25 RB / 0 RB Offset 25 RB / 12 RB Offset 25 RB / 25 RB Offset 50 RB / 0 RB Offset
-	Modulation characteristics	20450 to 20600	20525(836.5MHz)	10MHz	QPSK / 16QAM / 64QAM	50 RB / 0 RB Offset
-	Frequency Stability	20407 to 20643	20407(824.7MHz), 20643(848.3MHz)	1.4MHz	QPSK	6 RB / 0 RB Offset
		20415 to 20635	20415(825.5MHz), 20635(847.5MHz)	3MHz	QPSK	15 RB / 0 RB Offset
		20425 to 20625	20425(826.5MHz), 20625(846.5MHz)	5MHz	QPSK	25 RB / 0 RB Offset
		20450 to 20600	20450(829.0MHz), 20600(844.0MHz)	10MHz	QPSK	50 RB / 0 RB Offset
-	Occupied Bandwidth	20407 to 20643	20407(824.7MHz), 20525(836.5MHz), 20643(848.3MHz)	1.4MHz	QPSK / 16QAM / 64QAM	6 RB / 0RB Offset
		20415 to 20635	20415(825.5MHz), 20525(836.5MHz), 20635(847.5MHz)	3MHz	QPSK / 16QAM / 64QAM	15 RB / 0RB Offset
		20425 to 20625	20425(826.5MHz), 20525(836.5MHz), 20625(846.5MHz)	5MHz	QPSK / 16QAM / 64QAM	25RB / 0RB Offset
		20450 to 20600	20450(829.0MHz), 20525(836.5MHz), 20600(844.0MHz)	10MHz	QPSK / 16QAM / 64QAM	50RB / 0RB Offset

EUT Configure Mode	Test item	Available channel	Tested channel	Channel Bandwidth	Modulation	Mode
-	Band Edge	20407 to 20643	20407(824.7MHz), 20643(848.3MHz)	1.4MHz	QPSK	1 RB / 0 RB Offset 1 RB / 5 RB Offset 6 RB / 0 RB Offset
		20415 to 20635	20415(825.5MHz), 20635(847.5MHz)	3MHz	QPSK	1 RB / 0 RB Offset 1 RB / 14 RB Offset 15 RB / 0 RB Offset
		20425 to 20625	20425(826.5MHz), 20625(846.5MHz)	5MHz	QPSK	1 RB / 0 RB Offset 1 RB / 24 RB Offset 25 RB / 0 RB Offset
		20450 to 20600	20450(829.0MHz), 20600(844.0MHz)	10MHz	QPSK	1 RB / 0 RB Offset 1 RB / 49 RB Offset 50 RB / 0 RB Offset
-	Peak to Average Ratio	20407 to 20643	20407(824.7MHz), 20525(836.5MHz), 20643(848.3MHz)	1.4MHz	QPSK / 16QAM / 64QAM	3 RB / 1 RB Offset
		20415 to 20635	20415(825.5MHz), 20525(836.5MHz), 20635(847.5MHz)	3MHz	QPSK / 16QAM / 64QAM	1 RB / 0 RB Offset
		20425 to 20625	20425(826.5MHz), 20525(836.5MHz), 20625(846.5MHz)	5MHz	QPSK / 16QAM / 64QAM	1 RB / 12 RB Offset
		20450 to 20600	20450(829.0MHz), 20525(836.5MHz), 20600(844.0MHz)	10MHz	QPSK / 16QAM / 64QAM	1 RB / 0 RB Offset
-	Conducted Emission	20407 to 20643	20407(824.7MHz), 20525(836.5MHz), 20643(848.3MHz)	1.4MHz	QPSK	3 RB / 1 RB Offset
		20415 to 20635	20415(825.5MHz), 20525(836.5MHz), 20635(847.5MHz)	3MHz	QPSK	1 RB / 0 RB Offset
		20425 to 20625	20425(826.5MHz), 20525(836.5MHz), 20625(846.5MHz)	5MHz	QPSK	1 RB / 12 RB Offset
		20450 to 20600	20450(829.0MHz), 20525(836.5MHz), 20600(844.0MHz)	10MHz	QPSK	1 RB / 0 RB Offset
-	Radiated Emission Below 1GHz	20450 to 20600	20525(836.5MHz)	10MHz	QPSK	1 RB / 0 RB Offset
-	Radiated Emission Above 1GHz	20407 to 20643	20407(824.7MHz), 20525(836.5MHz), 20643(848.3MHz)	1.4MHz	QPSK	3 RB / 1 RB Offset
		20425 to 20625	20425(826.5MHz), 20525(836.5MHz), 20625(846.5MHz)	5MHz	QPSK	1 RB / 12 RB Offset
		20450 to 20600	20450(829.0MHz), 20525(836.5MHz), 20600(844.0MHz)	10MHz	QPSK	1 RB / 0 RB Offset

Note:

1. For radiated emission above 1GHz, according to 3GPP 36.521 Section 6.6.3.1.4, choose the lowest, 5MHz & highest channel bandwidth for final test.
2. The conducted output power for QPSK, 16QAM and 64QAM, measured value of QPSK is higher than 16QAM and 64QAM mode. Therefore, only ERP, Modulation characteristics, occupied bandwidth and Peak to average ratio items had been tested under QPSK, 16QAM and 64QAM modes, the other test items were performed under QPSK mode only.

LTE Band 26

EUT Configure Mode	Test item	Available channel	Tested channel	Channel Bandwidth	Modulation	Mode
-	ERP	26797 to 27033	26797 (824.7MHz), 26915 (836.5MHz), 27033 (848.3MHz)	1.4MHz	QPSK / 16QAM / 64QAM	1 RB / 0 RB Offset 1 RB / 2 RB Offset 1 RB / 5 RB Offset 3 RB / 0 RB Offset 3 RB / 1 RB Offset 3 RB / 3 RB Offset 6 RB / 0 RB Offset
		26805 to 27025	26805 (825.5MHz), 26915 (836.5MHz), 27025 (847.5MHz)	3MHz	QPSK / 16QAM / 64QAM	1 RB / 0 RB Offset 1 RB / 7 RB Offset 1 RB / 14 RB Offset 8 RB / 0 RB Offset 8 RB / 3 RB Offset 8 RB / 7 RB Offset 15 RB / 0 RB Offset
		26815 to 27015	26815 (826.5MHz), 26915 (836.5MHz), 27015 (846.5MHz)	5MHz	QPSK / 16QAM / 64QAM	1 RB / 0 RB Offset 1 RB / 12 RB Offset 1 RB / 24 RB Offset 12 RB / 0 RB Offset 12 RB / 6 RB Offset 12 RB / 13 RB Offset 25 RB / 0 RB Offset
		26840 to 26990	26840 (829MHz), 26915 (836.5MHz), 26990 (844MHz)	10MHz	QPSK / 16QAM / 64QAM	1 RB / 0 RB Offset 1 RB / 24 RB Offset 1 RB / 49 RB Offset 25 RB / 0 RB Offset 25 RB / 12 RB Offset 25 RB / 25 RB Offset 50 RB / 0 RB Offset
		26865 to 26965	26865 (831.5MHz), 26915 (836.5MHz), 26965 (841.5MHz)	15MHz	QPSK / 16QAM / 64QAM	1 RB / 0 RB Offset 1 RB / 37 RB Offset 1 RB / 74 RB Offset 36 RB / 0 RB Offset 36 RB / 19 RB Offset 36 RB / 39 RB Offset 75 RB / 0 RB Offset
-	Modulation Characteristics	26865 to 26965	26915 (836.5MHz)	15MHz	QPSK / 16QAM / 64QAM	75 RB / 0 RB Offset
-	Frequency Stability	26797 to 27033	26797 (824.7MHz), 27033 (848.3MHz)	1.4MHz	QPSK	6 RB / 0 RB Offset
		26805 to 27025	26805 (825.5MHz), 27025 (847.5MHz)	3MHz	QPSK	15 RB / 0 RB Offset
		26815 to 27015	26815 (826.5MHz), 27015 (846.5MHz)	5MHz	QPSK	25 RB / 0 RB Offset
		26840 to 26990	26840 (829MHz), 26990 (844MHz)	10MHz	QPSK	50 RB / 0 RB Offset
		26865 to 26965	26865 (831.5MHz), 26965 (841.5MHz)	15MHz	QPSK	75 RB / 0 RB Offset

EUT Configure Mode	Test item	Available channel	Tested channel	Channel Bandwidth	Modulation	Mode
-	Occupied Bandwidth	26797 to 27033	26797 (824.7MHz), 26915 (836.5MHz), 27033 (848.3MHz)	1.4MHz	QPSK / 16QAM / 64QAM	6 RB / 0RB Offset
		26805 to 27025	26805 (825.5MHz), 26915 (836.5MHz), 27025 (847.5MHz)	3MHz	QPSK / 16QAM / 64QAM	15 RB / 0RB Offset
		26815 to 27015	26815 (826.5MHz), 26915 (836.5MHz), 27015 (846.5MHz)	5MHz	QPSK / 16QAM / 64QAM	25RB / 0RB Offset
		26840 to 26990	26840 (829MHz), 26915 (836.5MHz), 26990 (844MHz)	10MHz	QPSK / 16QAM / 64QAM	50RB / 0RB Offset
		26865 to 26965	26865 (831.5MHz), 26915 (836.5MHz), 26965 (841.5MHz)	15MHz	QPSK / 16QAM / 64QAM	75 RB / 0 RB Offset
-	Band Edge	26797 to 27033	26797 (824.7MHz), 27033 (848.3MHz)	1.4MHz	QPSK	1 RB / 0 RB Offset 1 RB / 5 RB Offset 6 RB / 0 RB Offset
		26805 to 27025	26805 (825.5MHz), 27025 (847.5MHz)	3MHz	QPSK	1 RB / 0 RB Offset 1 RB / 14 RB Offset 15 RB / 0 RB Offset
		26815 to 27015	26815 (826.5MHz), 27015 (846.5MHz)	5MHz	QPSK	1 RB / 0 RB Offset 1 RB / 24 RB Offset 25 RB / 0 RB Offset
		26840 to 26990	26840 (829MHz), 26990 (844MHz)	10MHz	QPSK	1 RB / 0 RB Offset 1 RB / 49 RB Offset 50 RB / 0 RB Offset
		26865 to 26965	26865 (831.5MHz), 26965 (841.5MHz)	15MHz	QPSK	1 RB / 0 RB Offset 1 RB / 74 RB Offset 75 RB / 0 RB Offset
-	Peak to Average Ratio	26797 to 27033	26797 (824.7MHz), 26915 (836.5MHz), 27033 (848.3MHz)	1.4MHz	QPSK / 16QAM / 64QAM	1 RB / 2 RB Offset
		26805 to 27025	26805 (825.5MHz), 26915 (836.5MHz), 27025 (847.5MHz)	3MHz	QPSK / 16QAM / 64QAM	1 RB / 7 RB Offset
		26815 to 27015	26815 (826.5MHz), 26915 (836.5MHz), 27015 (846.5MHz)	5MHz	QPSK / 16QAM / 64QAM	1 RB / 12 RB Offset
		26840 to 26990	26840 (829MHz), 26915 (836.5MHz), 26990 (844MHz)	10MHz	QPSK / 16QAM / 64QAM	1 RB / 0 RB Offset
		26865 to 26965	26865 (831.5MHz), 26915 (836.5MHz), 26965 (841.5MHz)	15MHz	QPSK / 16QAM / 64QAM	1 RB / 74 RB Offset
-	Conducted Emission	26797 to 27033	26797 (824.7MHz), 26915 (836.5MHz), 27033 (848.3MHz)	1.4MHz	QPSK	1 RB / 2 RB Offset
		26805 to 27025	26805 (825.5MHz), 26915 (836.5MHz), 27025 (847.5MHz)	3MHz	QPSK	1 RB / 7 RB Offset
		26815 to 27015	26815 (826.5MHz), 26915 (836.5MHz), 27015 (846.5MHz)	5MHz	QPSK	1 RB / 12 RB Offset
		26840 to 26990	26840 (829MHz), 26915 (836.5MHz), 26990 (844MHz)	10MHz	QPSK	1 RB / 0 RB Offset
		26865 to 26965	26865 (831.5MHz), 26915 (836.5MHz), 26965 (841.5MHz)	15MHz	QPSK	1 RB / 74 RB Offset

EUT Configure Mode	Test item	Available channel	Tested channel	Channel Bandwidth	Modulation	Mode
-	Radiated Emission Below 1GHz	26797 to 27033	26797 (824.7MHz)	1.4MHz	QPSK	1 RB / 2 RB Offset
-	Radiated Emission Above 1GHz	26797 to 27033	26797 (824.7MHz), 26915 (836.5MHz), 27033 (848.3MHz)	1.4MHz	QPSK	1 RB / 2 RB Offset
		26815 to 27015	26815 (826.5MHz), 26915 (836.5MHz), 27015 (846.5MHz)	5MHz	QPSK	1 RB / 12 RB Offset
		26865 to 26965	26865 (831.5MHz), 26915 (836.5MHz), 26965 (841.5MHz)	15MHz	QPSK	1 RB / 74 RB Offset

Note:

1. For radiated emission above 1GHz, according to 3GPP 36.521 Section 6.6.3.1.4, choose the lowest, 5MHz & highest channel bandwidth for final test.
2. The conducted output power for QPSK, 16QAM and 64QAM, measured value of QPSK is higher than 16QAM and 64QAM mode. Therefore, only ERP, Modulation characteristics, occupied bandwidth and Peak to average ratio items had been tested under QPSK, 16QAM and 64QAM modes, the other test items were performed under QPSK mode only.

Test Condition:

Test Item	Environmental Conditions	Input Power (system)	Tested By
ERP	25deg. C, 70%RH	5Vdc	James Yang
Modulation Characteristics	24deg. C, 64%RH	5Vdc	James Yang
Frequency Stability	24deg. C, 64%RH	5Vdc	James Yang
Occupied Bandwidth	24deg. C, 64%RH	5Vdc	James Yang
Band Edge	24deg. C, 64%RH	5Vdc	James Yang
Peak To Average Ratio	24deg. C, 64%RH	5Vdc	James Yang
Conducted Emission	24deg. C, 64%RH	5Vdc	James Yang
Radiated Emission	22deg. C, 68%RH 25deg. C, 70%RH	120Vac, 60Hz	Greg Lin Luis Lee

3.4 EUT Operating Conditions

The EUT makes a call to the communication simulator. The communication simulator station system controlled a EUT to export maximum output power under transmission mode and specific channel frequency

3.5 General Description of Applied Standards and References

The EUT is a RF Product. According to the specifications of the manufacturer, it must comply with the requirements of the following standards and References:

Test Standard:

FCC 47 CFR Part 2

FCC 47 CFR Part 22

ANSI/TIA/EIA-603-E 2016

ANSI 63.26-2015

All test items have been performed and recorded as per the above standards.

References Test Guidance:

KDB 971168 D01 Power Meas License Digital Systems v03r01

All test items have been performed as a reference to the above KDB test guidance.

4 Test Types and Results

4.1 Output Power Measurement

4.1.1 Limits of Output Power Measurement

Mobile / Portable station are limited to 7 watts e.r.p.

4.1.2 Test Procedures

Conducted Power Measurement:

The EUT was set up for the maximum power with WCDMA, LTE link data modulation and link up with simulator. Set the EUT to transmit under low, middle and high channel and record the power level shown on simulator.

Maximum EIRP

The relevant equation for determining the maximum ERP or EIRP from the measured RF output power is given in Equation as follows:

$$\text{ERP or EIRP} = P_{\text{Meas}} + G_{\text{T}}$$

where

ERP or EIRP effective radiated power or equivalent isotropically radiated power, respectively
(expressed in the same units as P_{Meas} , e.g., dBm or dBW)

P_{Meas} measured transmitter output power or PSD, in dBm or dBW

G_{T} gain of the transmitting antenna, in dBd (ERP) or dBi (EIRP)

4.1.3 Test Setup

Conducted Power Measurement:



For the actual test configuration, please refer to the attached file (Test Setup Photo).

4.1.4 Test Results

Conducted Output Power (dBm)

Band	WCDMA V		
	4132	4182	4233
TX Channel	4132	4182	4233
Rx Channel	4357	4407	4458
Frequency (MHz)	826.4	836.4	846.6
RMC 12.2K	23.35	23.41	23.49
HSDPA Subtest-1	22.16	22.03	22.25
HSDPA Subtest-2	22.20	22.11	22.23
HSDPA Subtest-3	22.16	22.05	22.15
HSDPA Subtest-4	22.13	22.12	22.18
HSUPA Subtest-1	21.26	21.29	21.33
HSUPA Subtest-2	21.22	21.23	21.28
HSUPA Subtest-3	21.19	21.20	21.16
HSUPA Subtest-4	21.23	21.15	21.22

LTE Band 5						
BW	MCS Index	RB Size	RB Offset	Low	Mid	High
		Channel		20407	20525	20643
		Frequency (MHz)		824.7	836.5	848.3
1.4M	QPSK	1	0	23.81	23.69	23.49
		1	2	23.79	23.76	23.54
		1	5	23.81	23.71	23.42
		3	0	23.87	23.69	23.46
		3	1	23.89	23.71	23.62
		3	3	23.86	23.75	23.55
		6	0	22.95	22.87	22.61
	16QAM	1	0	22.93	22.92	22.87
		1	2	23.00	22.98	22.89
		1	5	22.82	22.93	22.67
		3	0	22.87	22.81	22.64
		3	1	22.99	22.87	22.68
		3	3	22.96	22.89	22.59
		6	0	21.98	21.88	21.72
	64QAM	1	0	21.59	21.49	21.24
		1	2	21.65	21.55	21.32
		1	5	21.57	21.52	21.26
		3	0	21.51	21.39	21.13
		3	1	21.45	21.40	21.14
		3	3	21.45	21.44	21.38
		6	0	20.47	20.39	20.39

LTE Band 5						
BW	MCS Index	RB Size	RB Offset	Low	Mid	High
		Channel		20415	20525	20635
		Frequency (MHz)		825.5	836.5	847.5
3M	QPSK	1	0	23.97	23.87	23.86
		1	7	23.88	23.83	23.65
		1	14	23.85	23.77	23.79
		8	0	23.03	22.91	23.01
		8	3	23.00	22.88	22.94
		8	7	22.97	22.83	22.82
		15	0	23.04	22.94	22.87
	16QAM	1	0	23.05	23.03	23.18
		1	7	23.12	23.06	23.08
		1	14	22.87	23.01	23.16
		8	0	22.03	21.99	22.04
		8	3	22.07	22.07	22.09
		8	7	21.94	21.94	21.95
		15	0	22.08	21.95	21.86
	64QAM	1	0	21.48	21.83	21.82
		1	7	21.53	21.56	21.80
		1	14	21.37	21.94	21.92
		8	0	20.54	20.48	20.41
		8	3	20.53	20.49	20.42
		8	7	20.51	20.46	20.29
		15	0	20.42	20.45	20.38

LTE Band 5						
BW	MCS Index	RB Size	RB Offset	Low	Mid	High
		Channel		20425	20525	20625
		Frequency (MHz)		826.5	836.5	846.5
5M	QPSK	1	0	23.84	23.79	23.91
		1	12	23.86	23.86	23.97
		1	24	23.86	23.86	23.82
		12	0	23.07	22.99	22.98
		12	6	23.02	22.97	23.02
		12	13	22.98	22.88	22.89
		25	0	23.05	22.99	22.98
	16QAM	1	0	23.21	23.15	23.35
		1	12	23.39	23.07	23.36
		1	24	23.40	23.06	23.24
		12	0	22.11	22.03	21.99
		12	6	22.06	21.94	21.92
		12	13	22.02	21.89	21.92
		25	0	22.06	22.00	21.91
	64QAM	1	0	21.59	21.88	21.55
		1	12	21.51	21.91	21.50
		1	24	21.88	22.01	21.64
		12	0	20.38	20.42	20.26
		12	6	20.42	20.46	20.28
		12	13	20.44	20.52	20.30
		25	0	20.41	20.45	20.32

LTE Band 5						
BW	MCS Index	RB Size	RB Offset	Low	Mid	High
		Channel		20450	20525	20600
		Frequency (MHz)		829	836.5	844
10M	QPSK	1	0	24.18	24.02	24.04
		1	24	23.84	23.60	23.74
		1	49	23.73	23.82	23.42
		25	0	22.96	22.93	22.94
		25	12	22.95	22.95	22.89
		25	25	22.91	22.91	23.10
		50	0	22.97	23.01	22.95
	16QAM	1	0	22.94	23.01	23.49
		1	24	22.83	23.31	23.43
		1	49	22.89	23.39	22.94
		25	0	21.77	21.81	22.03
		25	12	21.86	21.88	21.97
		25	25	21.95	21.79	21.97
		50	0	22.01	21.86	21.96
	64QAM	1	0	21.55	22.00	21.79
		1	24	21.57	21.38	21.71
		1	49	21.99	21.98	21.53
		25	0	20.43	20.45	20.18
		25	12	20.41	20.51	20.30
		25	25	20.52	20.47	20.41
		50	0	20.47	20.48	20.42

LTE Band 26						
BW	MCS Index	RB Size	RB Offset	Low	Mid	High
		Channel		26797	26915	27033
		Frequency (MHz)		824.7	836.5	848.3
1.4M	QPSK	1	0	23.75	23.70	23.18
		1	2	23.88	23.81	23.45
		1	5	23.75	23.70	23.41
		3	0	23.79	23.79	23.24
		3	1	23.87	23.78	23.53
		3	3	23.84	23.77	23.36
		6	0	22.85	22.79	22.45
	16QAM	1	0	22.87	22.81	22.97
		1	2	23.05	22.92	23.00
		1	5	22.75	22.95	22.80
		3	0	23.00	22.88	22.45
		3	1	23.00	22.88	22.60
		3	3	22.90	22.91	22.24
		6	0	21.86	21.85	21.25
	64QAM	1	0	21.69	21.46	21.34
		1	2	21.74	21.57	21.40
		1	5	21.73	21.34	21.32
		3	0	21.42	21.40	21.28
		3	1	21.39	21.42	21.39
		3	3	21.37	21.22	21.39
		6	0	20.42	20.39	20.49

LTE Band 26						
BW	MCS Index	RB Size	RB Offset	Low	Mid	High
		Channel		26805	26915	27025
		Frequency (MHz)		825.5	836.5	847.5
3M	QPSK	1	0	23.92	23.77	23.77
		1	7	23.98	23.76	23.57
		1	14	23.91	23.74	23.70
		8	0	22.88	22.84	22.77
		8	3	22.98	22.89	22.60
		8	7	22.85	22.80	22.67
		15	0	22.88	22.87	22.72
	16QAM	1	0	22.79	23.00	23.43
		1	7	22.80	23.30	22.91
		1	14	22.86	23.37	22.95
		8	0	22.01	21.94	21.89
		8	3	22.03	21.87	21.82
		8	7	21.93	21.88	21.78
		15	0	21.95	21.87	21.83
	64QAM	1	0	21.53	21.34	21.76
		1	7	21.50	21.52	21.80
		1	14	21.53	21.49	21.77
		8	0	20.59	20.44	20.45
		8	3	20.66	20.42	20.45
		8	7	20.59	20.49	20.40
		15	0	20.56	20.36	20.39

LTE Band 26						
BW	MCS Index	RB Size	RB Offset	Low	Mid	High
		Channel		26815	26915	27015
		Frequency (MHz)		826.5	836.5	846.5
5M	QPSK	1	0	23.70	23.79	23.74
		1	12	23.75	23.98	23.79
		1	24	23.78	23.83	23.85
		12	0	22.86	22.84	22.88
		12	6	22.96	22.90	22.87
		12	13	22.89	22.81	22.88
		25	0	22.88	22.81	22.85
	16QAM	1	0	23.12	23.26	22.87
		1	12	23.18	23.30	22.90
		1	24	23.20	23.33	22.84
		12	0	21.83	21.85	21.86
		12	6	21.92	21.82	21.91
		12	13	21.87	21.88	21.82
		25	0	21.83	21.83	21.90
	64QAM	1	0	21.54	21.44	21.64
		1	12	21.52	21.52	21.68
		1	24	21.56	21.59	21.65
		12	0	20.40	20.38	20.30
		12	6	20.50	20.40	20.35
		12	13	20.42	20.45	20.29
		25	0	20.43	20.39	20.26

LTE Band 26						
BW	MCS Index	RB Size	RB Offset	Low	Mid	High
		Channel		26840	26915	26990
		Frequency (MHz)		829	836.5	844
10M	QPSK	1	0	23.78	23.59	23.87
		1	24	23.71	23.46	23.70
		1	49	23.63	23.78	23.28
		25	0	22.82	22.82	22.80
		25	12	22.86	22.83	22.82
		25	25	22.88	22.86	22.84
		50	0	22.77	22.78	22.74
	16QAM	1	0	23.41	23.19	23.07
		1	24	23.08	23.15	23.10
		1	49	23.02	23.20	22.47
		25	0	21.80	21.63	21.84
		25	12	21.77	21.80	21.74
		25	25	21.62	21.88	21.83
		50	0	21.89	21.83	21.71
	64QAM	1	0	21.66	21.47	21.84
		1	24	21.86	21.89	21.74
		1	49	21.55	21.99	21.52
		25	0	20.37	20.32	20.22
		25	12	20.35	20.39	20.38
		25	25	20.33	20.52	20.25
		50	0	20.36	20.40	20.38

LTE Band 26						
BW	MCS Index	RB Size	RB Offset	Low	Mid	High
		Channel		26865	26915	26965
		Frequency (MHz)		831.5	836.5	841.5
15M	QPSK	1	0	23.96	23.95	23.91
		1	37	23.85	23.86	23.90
		1	74	23.96	23.97	23.58
		36	0	22.98	23.07	23.00
		36	19	23.10	23.07	23.00
		36	39	22.99	23.09	23.13
		75	0	22.98	23.01	23.10
	16QAM	1	0	23.32	22.96	23.12
		1	37	23.36	22.93	23.11
		1	74	23.54	22.84	22.51
		36	0	22.00	22.09	22.10
		36	19	22.17	21.99	21.94
		36	39	21.99	21.99	21.96
		75	0	22.00	22.01	21.99
	64QAM	1	0	21.69	22.11	21.94
		1	37	21.89	21.59	21.61
		1	74	21.72	21.49	21.97
		36	0	20.52	20.58	20.35
		36	19	20.63	20.61	20.49
		36	39	20.62	20.67	20.58
		75	0	20.57	20.64	20.61

ERP Power (dBm)

Band	WCDMA V		
TX Channel	4132	4182	4233
Rx Channel	4357	4407	4458
Frequency (MHz)	826.4	836.4	846.6
RMC 12.2K	25.01	25.07	25.15
HSDPA Subtest-1	23.82	23.69	23.91
HSDPA Subtest-2	23.86	23.77	23.89
HSDPA Subtest-3	23.82	23.71	23.81
HSDPA Subtest-4	23.79	23.78	23.84
HSUPA Subtest-1	22.92	22.95	22.99
HSUPA Subtest-2	22.88	22.89	22.94
HSUPA Subtest-3	22.85	22.86	22.82
HSUPA Subtest-4	22.89	22.81	22.88

*ERP = Conducted + antenna gain (3.81dBi)-2.15

LTE Band 5						
BW	MCS Index	RB Size	RB Offset	Low	Mid	High
		Channel		20407	20525	20643
		Frequency (MHz)		824.7	836.5	848.3
1.4M	QPSK	1	0	25.47	25.35	25.15
		1	2	25.45	25.42	25.20
		1	5	25.47	25.37	25.08
		3	0	25.53	25.35	25.12
		3	1	25.55	25.37	25.28
		3	3	25.52	25.41	25.21
		6	0	24.61	24.53	24.27
	16QAM	1	0	24.59	24.58	24.53
		1	2	24.66	24.64	24.55
		1	5	24.48	24.59	24.33
		3	0	24.53	24.47	24.30
		3	1	24.65	24.53	24.34
		3	3	24.62	24.55	24.25
		6	0	23.64	23.54	23.38
	64QAM	1	0	23.25	23.15	22.90
		1	2	23.31	23.21	22.98
		1	5	23.23	23.18	22.92
		3	0	23.17	23.05	22.79
		3	1	23.11	23.06	22.80
		3	3	23.11	23.10	23.04
		6	0	22.13	22.05	22.05

*ERP = Conducted + antenna gain (3.81dBi)-2.15

LTE Band 5						
BW	MCS Index	RB Size	RB Offset	Low	Mid	High
		Channel		20415	20525	20635
		Frequency (MHz)		825.5	836.5	847.5
3M	QPSK	1	0	25.63	25.53	25.52
		1	7	25.54	25.49	25.31
		1	14	25.51	25.43	25.45
		8	0	24.69	24.57	24.67
		8	3	24.66	24.54	24.60
		8	7	24.63	24.49	24.48
		15	0	24.70	24.60	24.53
	16QAM	1	0	24.71	24.69	24.84
		1	7	24.78	24.72	24.74
		1	14	24.53	24.67	24.82
		8	0	23.69	23.65	23.70
		8	3	23.73	23.73	23.75
		8	7	23.60	23.60	23.61
		15	0	23.74	23.61	23.52
	64QAM	1	0	23.14	23.49	23.48
		1	7	23.19	23.22	23.46
		1	14	23.03	23.60	23.58
		8	0	22.20	22.14	22.07
		8	3	22.19	22.15	22.08
		8	7	22.17	22.12	21.95
		15	0	22.08	22.11	22.04

*ERP = Conducted + antenna gain (3.81dBi)-2.15

LTE Band 5						
BW	MCS Index	RB Size	RB Offset	Low	Mid	High
		Channel		20425	20525	20625
		Frequency (MHz)		826.5	836.5	846.5
5M	QPSK	1	0	25.50	25.45	25.57
		1	12	25.52	25.52	25.63
		1	24	25.52	25.52	25.48
		12	0	24.73	24.65	24.64
		12	6	24.68	24.63	24.68
		12	13	24.64	24.54	24.55
		25	0	24.71	24.65	24.64
	16QAM	1	0	24.87	24.81	25.01
		1	12	25.05	24.73	25.02
		1	24	25.06	24.72	24.90
		12	0	23.77	23.69	23.65
		12	6	23.72	23.60	23.58
		12	13	23.68	23.55	23.58
		25	0	23.72	23.66	23.57
	64QAM	1	0	23.25	23.54	23.21
		1	12	23.17	23.57	23.16
		1	24	23.54	23.67	23.30
		12	0	22.04	22.08	21.92
		12	6	22.08	22.12	21.94
		12	13	22.10	22.18	21.96
		25	0	22.07	22.11	21.98

*ERP = Conducted + antenna gain (3.81dBi)-2.15

LTE Band 5						
BW	MCS Index	RB Size	RB Offset	Low	Mid	High
		Channel		20450	20525	20600
		Frequency (MHz)		829	836.5	844
10M	QPSK	1	0	25.84	25.50	25.44
		1	24	25.50	25.26	25.40
		1	49	25.39	25.48	25.08
		25	0	24.62	24.59	24.60
		25	12	24.61	24.61	24.55
		25	25	24.57	24.57	24.76
		50	0	24.63	24.67	24.61
	16QAM	1	0	24.60	24.67	25.15
		1	24	24.49	24.97	25.09
		1	49	24.55	25.05	24.60
		25	0	23.43	23.47	23.69
		25	12	23.52	23.54	23.63
		25	25	23.61	23.45	23.63
		50	0	23.67	23.52	23.62
	64QAM	1	0	23.21	23.66	23.45
		1	24	23.23	23.04	23.37
		1	49	23.65	23.64	23.19
		25	0	22.09	22.11	21.84
		25	12	22.07	22.17	21.96
		25	25	22.18	22.13	22.07
		50	0	22.13	22.14	22.08

*ERP = Conducted + antenna gain (3.81dBi)-2.15

LTE Band 26						
BW	MCS Index	RB Size	RB Offset	Low	Mid	High
		Channel		26797	26915	27033
		Frequency (MHz)		824.7	836.5	848.3
1.4M	QPSK	1	0	25.41	25.36	24.84
		1	2	25.54	25.47	25.11
		1	5	25.41	25.36	25.07
		3	0	25.45	25.45	24.90
		3	1	25.53	25.44	25.19
		3	3	25.50	25.43	25.02
		6	0	24.51	24.45	24.11
	16QAM	1	0	24.53	24.47	24.63
		1	2	24.71	24.58	24.66
		1	5	24.41	24.61	24.46
		3	0	24.66	24.54	24.11
		3	1	24.66	24.54	24.26
		3	3	24.56	24.57	23.90
		6	0	23.52	23.51	22.91
	64QAM	1	0	23.35	23.12	23.00
		1	2	23.40	23.23	23.06
		1	5	23.39	23.00	22.98
		3	0	23.08	23.06	22.94
		3	1	23.05	23.08	23.05
		3	3	23.03	22.88	23.05
		6	0	22.08	22.05	22.15

*ERP = Conducted + antenna gain (3.81dBi)-2.15

LTE Band 26						
BW	MCS Index	RB Size	RB Offset	Low	Mid	High
		Channel		26805	26915	27025
		Frequency (MHz)		825.5	836.5	847.5
3M	QPSK	1	0	25.58	25.43	25.43
		1	7	25.64	25.42	25.23
		1	14	25.57	25.40	25.36
		8	0	24.54	24.50	24.43
		8	3	24.64	24.55	24.26
		8	7	24.51	24.46	24.33
		15	0	24.54	24.53	24.38
	16QAM	1	0	24.45	24.66	25.09
		1	7	24.46	24.96	24.57
		1	14	24.52	25.03	24.61
		8	0	23.67	23.60	23.55
		8	3	23.69	23.53	23.48
		8	7	23.59	23.54	23.44
		15	0	23.61	23.53	23.49
	64QAM	1	0	23.19	23.00	23.42
		1	7	23.16	23.18	23.46
		1	14	23.19	23.15	23.43
		8	0	22.25	22.10	22.11
		8	3	22.32	22.08	22.11
		8	7	22.25	22.15	22.06
		15	0	22.22	22.02	22.05

*ERP = Conducted + antenna gain (3.81dBi)-2.15

LTE Band 26						
BW	MCS Index	RB Size	RB Offset	Low	Mid	High
		Channel		26815	26915	27015
		Frequency (MHz)		826.5	836.5	846.5
5M	QPSK	1	0	25.36	25.45	25.40
		1	12	25.41	25.64	25.45
		1	24	25.44	25.49	25.51
		12	0	24.52	24.50	24.54
		12	6	24.62	24.56	24.53
		12	13	24.55	24.47	24.54
		25	0	24.54	24.47	24.51
	16QAM	1	0	24.78	24.92	24.53
		1	12	24.84	24.96	24.56
		1	24	24.86	24.99	24.50
		12	0	23.49	23.51	23.52
		12	6	23.58	23.48	23.57
		12	13	23.53	23.54	23.48
		25	0	23.49	23.49	23.56
	64QAM	1	0	23.20	23.10	23.30
		1	12	23.18	23.18	23.34
		1	24	23.22	23.25	23.31
		12	0	22.06	22.04	21.96
		12	6	22.16	22.06	22.01
		12	13	22.08	22.11	21.95
		25	0	22.09	22.05	21.92

*ERP = Conducted + antenna gain (3.81dBi)-2.15

LTE Band 26						
BW	MCS Index	RB Size	RB Offset	Low	Mid	High
		Channel		26840	26915	26990
		Frequency (MHz)		829	836.5	844
10M	QPSK	1	0	25.44	25.25	25.53
		1	24	25.37	25.12	25.36
		1	49	25.29	25.44	24.94
		25	0	24.48	24.48	24.46
		25	12	24.52	24.49	24.48
		25	25	24.54	24.52	24.50
		50	0	24.43	24.44	24.40
	16QAM	1	0	25.07	24.85	24.73
		1	24	24.74	24.81	24.76
		1	49	24.68	24.86	24.13
		25	0	23.46	23.29	23.50
		25	12	23.43	23.46	23.40
		25	25	23.28	23.54	23.49
		50	0	23.55	23.49	23.37
	64QAM	1	0	23.32	23.13	23.50
		1	24	23.52	23.55	23.40
		1	49	23.21	23.65	23.18
		25	0	22.03	21.98	21.88
		25	12	22.01	22.05	22.04
		25	25	21.99	22.18	21.91
		50	0	22.02	22.06	22.04

*ERP = Conducted + antenna gain (3.81dBi)-2.15

LTE Band 26						
BW	MCS Index	RB Size	RB Offset	Low	Mid	High
		Channel		26865	26915	26965
		Frequency (MHz)		831.5	836.5	841.5
15M	QPSK	1	0	25.62	25.61	25.57
		1	37	25.51	25.52	25.56
		1	74	25.62	25.63	25.24
		36	0	24.64	24.73	24.66
		36	19	24.76	24.73	24.66
		36	39	24.65	24.75	24.79
		75	0	24.64	24.67	24.76
	16QAM	1	0	24.98	24.62	24.78
		1	37	25.02	24.59	24.77
		1	74	25.20	24.50	24.17
		36	0	23.66	23.75	23.76
		36	19	23.83	23.65	23.60
		36	39	23.65	23.65	23.62
		75	0	23.66	23.67	23.65
	64QAM	1	0	23.35	23.77	23.60
		1	37	23.55	23.25	23.27
		1	74	23.38	23.15	23.63
		36	0	22.18	22.24	22.01
		36	19	22.29	22.27	22.15
		36	39	22.28	22.33	22.24
		75	0	22.23	22.30	22.27

*ERP = Conducted + antenna gain (3.81dBi)-2.15

4.2 Modulation Characteristics Measurement

4.2.1 Limits of Modulation Characteristics

N/A

4.2.2 Test Procedure

Connect the EUT to Communication Simulator via the antenna connector, The frequency band is set as EUT supported Modulation and Channels, the EUT output is matched with 50 ohm load, the waveform quality and constellation of the EUT was tested.

4.2.3 Test Setup



4.2.4 Test Results

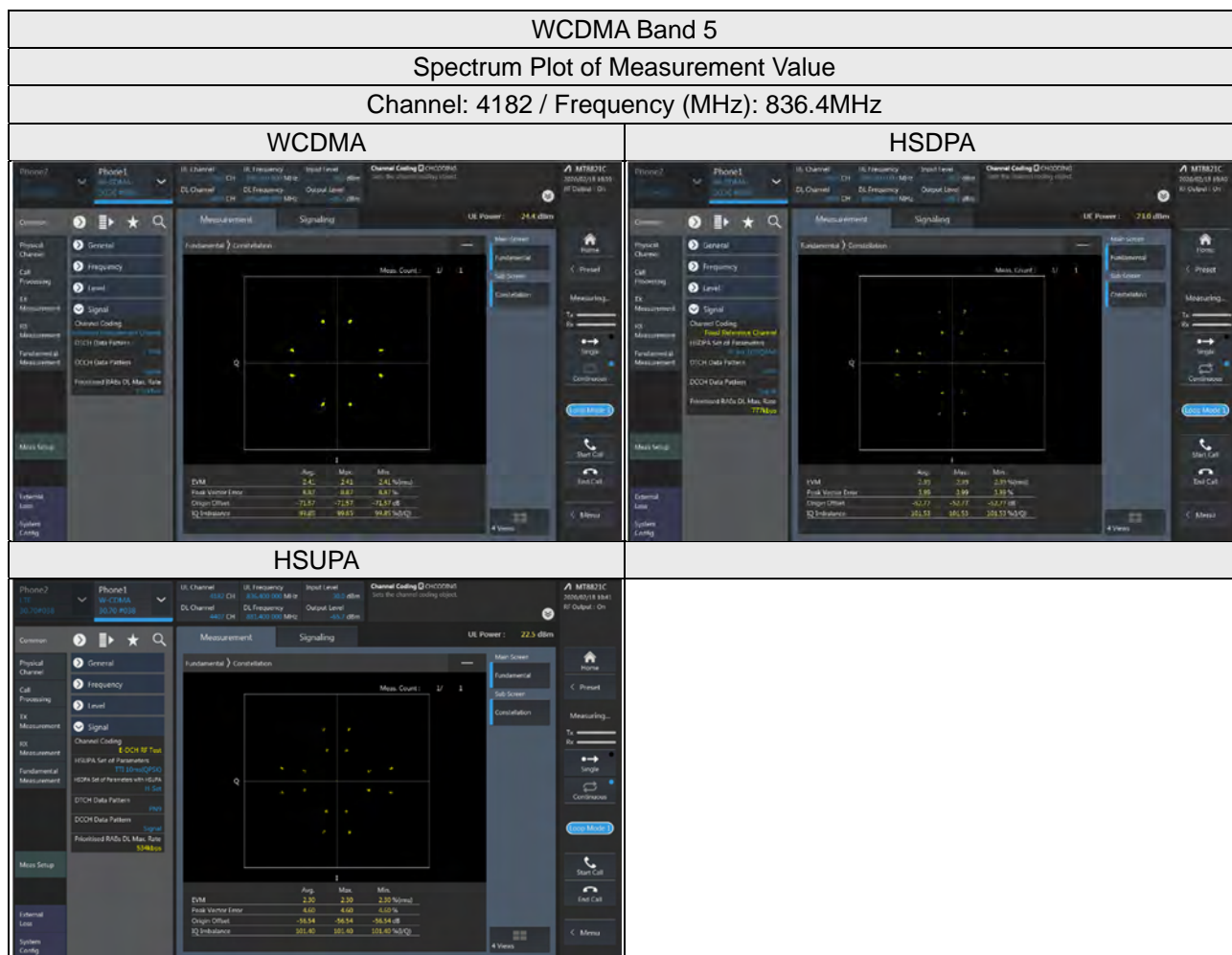

LTE Band 5

Spectrum Plot of Measurement Value

Channel: 20525 / Frequency (MHz): 836.5MHz

QPSK

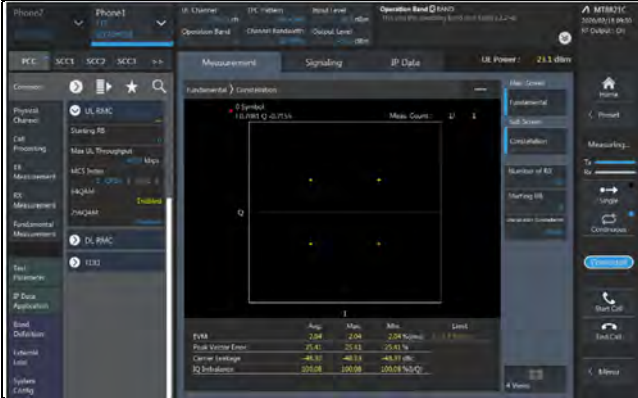

16QAM

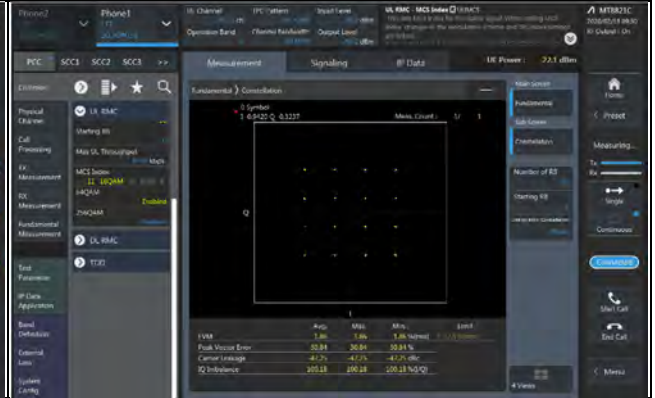

64QAM

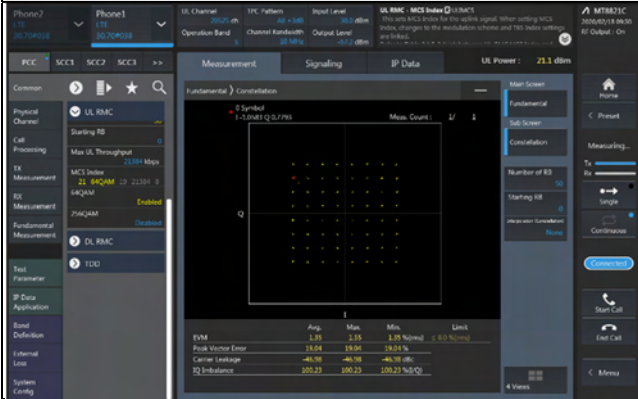

LTE Band 26

Spectrum Plot of Measurement Value

Channel: 26915 / Frequency (MHz): 836.5MHz

QPSK

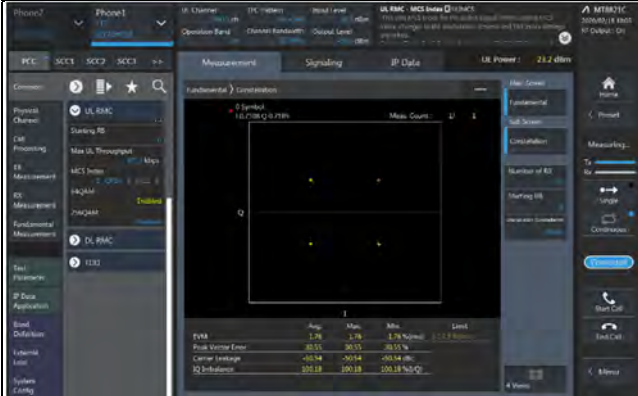

16QAM

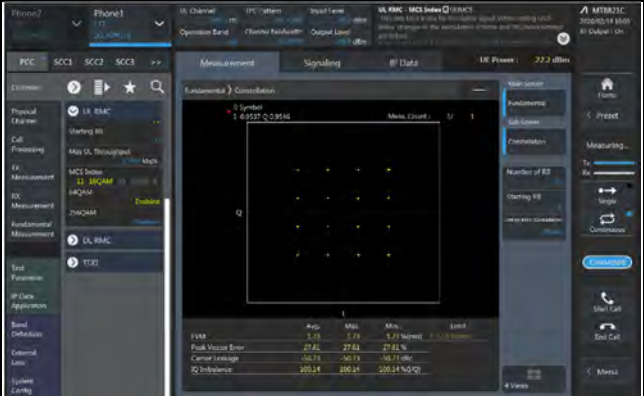

64QAM

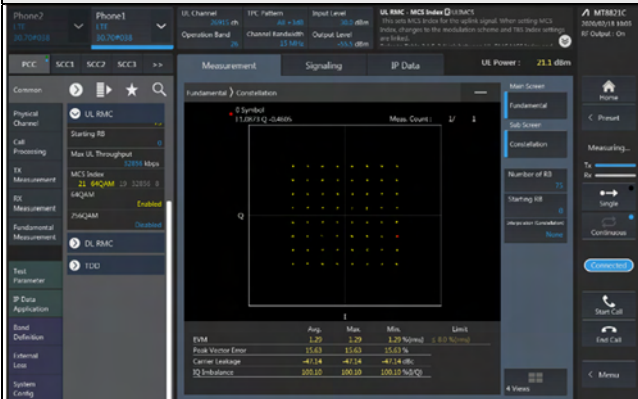

4.3 Frequency Stability Measurement

4.3.1 Limits of Frequency Stability Measurement

1.5 ppm is for base and fixed station. 2.5 ppm is for mobile station.

4.3.2 Test Procedure

- Device is placed at the oven room. The oven room could control the temperatures and humidity. Power warm up is at least 15 min and power applied should perform before recording frequency error.
- EUT is connected the external power supply to control the DC input power. The test voltage range is from minimum to maximum working voltage. Each step shall be record the frequency error rate.
- The temperature range step is 10 degrees in this test items. All temperature levels shall be hold the ± 0.5 °C during the measurement testing. The each temperature step shall be at least 0.5 hours, consider the EUT could be test under the stability condition.

Note: The frequency error was recorded frequency error from the communication simulator.

4.3.3 Test Setup

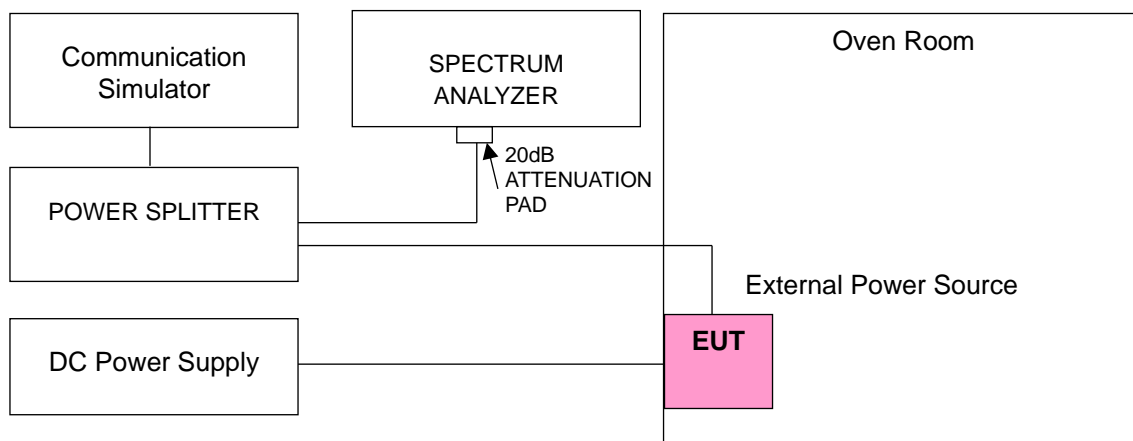

4.3.4 Test Results

Frequency Error vs. Voltage

Voltage (Volts)	WCDMA Band 5			
	Low Channel		High Channel	
	Frequency (MHz)	Frequency Error (ppm)	Frequency (MHz)	Frequency Error (ppm)
4.25	826.400003	0.004	846.600002	0.002
5	826.400003	0.003	846.600002	0.002
5.75	826.400004	0.004	846.600002	0.002

Note: The applicant defined the normal working voltage is from 4.25Vdc to 5.75Vdc.

Frequency Error vs. Temperature

Temp. (°C)	WCDMA Band 5			
	Low Channel		High Channel	
	Frequency (MHz)	Frequency Error (ppm)	Frequency (MHz)	Frequency Error (ppm)
-30	826.400003	0.004	846.600001	0.001
-20	826.400004	0.004	846.600001	0.001
-10	826.400001	0.001	846.600003	0.004
0	826.400003	0.003	846.600001	0.002
10	826.400003	0.004	846.600001	0.001
20	826.399999	-0.002	846.599999	-0.001
30	826.399999	-0.001	846.599996	-0.005
40	826.399997	-0.003	846.599998	-0.002
50	826.399998	-0.002	846.599997	-0.004

Frequency Error vs. Voltage

Voltage (Volts)	LTE Band 5			
	Channel Bandwidth: 1.4 MHz			
	Low Channel		High Channel	
	Frequency (MHz)	Frequency Error (ppm)	Frequency (MHz)	Frequency Error (ppm)
4.25	824.700001	0.002	848.300002	0.002
5	824.700004	0.004	848.300001	0.001
5.75	824.700002	0.003	848.300003	0.003

Note: The applicant defined the normal working voltage is from 4.25Vdc to 5.75Vdc.

Frequency Error vs. Temperature

Temp. (°C)	LTE Band 5			
	Channel Bandwidth: 1.4 MHz			
	Low Channel		High Channel	
	Frequency (MHz)	Frequency Error (ppm)	Frequency (MHz)	Frequency Error (ppm)
-30	824.700004	0.005	848.300004	0.004
-20	824.700001	0.002	848.300003	0.004
-10	824.700003	0.004	848.300001	0.001
0	824.700003	0.003	848.300004	0.004
10	824.700003	0.003	848.300004	0.004
20	824.699997	-0.004	848.299998	-0.003
30	824.699996	-0.005	848.299997	-0.004
40	824.699997	-0.004	848.299997	-0.004
50	824.699998	-0.002	848.299998	-0.002

Frequency Error vs. Voltage

Voltage (Volts)	LTE Band 5			
	Channel Bandwidth: 3 MHz			
	Low Channel		High Channel	
	Frequency (MHz)	Frequency Error (ppm)	Frequency (MHz)	Frequency Error (ppm)
4.25	825.500003	0.003	847.500003	0.003
5	825.500004	0.004	847.500004	0.004
5.75	825.500003	0.004	847.500002	0.002

Note: The applicant defined the normal working voltage is from 4.25Vdc to 5.75Vdc.

Frequency Error vs. Temperature

Temp. (°C)	LTE Band 5			
	Channel Bandwidth: 3 MHz			
	Low Channel		High Channel	
	Frequency (MHz)	Frequency Error (ppm)	Frequency (MHz)	Frequency Error (ppm)
-30	825.500002	0.002	847.500004	0.004
-20	825.500003	0.004	847.500003	0.004
-10	825.500002	0.002	847.500002	0.003
0	825.500004	0.005	847.500004	0.004
10	825.500001	0.001	847.500004	0.004
20	825.499997	-0.004	847.499999	-0.002
30	825.499997	-0.004	847.499999	-0.001
40	825.499998	-0.002	847.499998	-0.002
50	825.499996	-0.005	847.499997	-0.003

Frequency Error vs. Voltage

Voltage (Volts)	LTE Band 5			
	Channel Bandwidth: 5 MHz			
	Low Channel		High Channel	
	Frequency (MHz)	Frequency Error (ppm)	Frequency (MHz)	Frequency Error (ppm)
4.25	826.500004	0.004	846.500001	0.002
5	826.500003	0.004	846.500004	0.005
5.75	826.500003	0.004	846.500002	0.002

Note: The applicant defined the normal working voltage is from 4.25Vdc to 5.75Vdc.

Frequency Error vs. Temperature

Temp. (°C)	LTE Band 5			
	Channel Bandwidth: 5 MHz			
	Low Channel		High Channel	
	Frequency (MHz)	Frequency Error (ppm)	Frequency (MHz)	Frequency Error (ppm)
-30	826.500002	0.002	846.500003	0.003
-20	826.500003	0.004	846.500003	0.004
-10	826.500002	0.003	846.500003	0.004
0	826.500004	0.005	846.500002	0.003
10	826.500004	0.005	846.500003	0.003
20	826.499998	-0.003	846.499997	-0.003
30	826.499999	-0.001	846.499997	-0.003
40	826.499997	-0.003	846.499998	-0.002
50	826.499996	-0.004	846.499997	-0.004

Frequency Error vs. Voltage

Voltage (Volts)	LTE Band 5			
	Channel Bandwidth: 10 MHz			
	Low Channel		High Channel	
	Frequency (MHz)	Frequency Error (ppm)	Frequency (MHz)	Frequency Error (ppm)
4.25	829.000003	0.003	844.000002	0.002
5	829.000004	0.004	844.000003	0.004
5.75	829.000003	0.003	844.000003	0.003

Note: The applicant defined the normal working voltage is from 4.25Vdc to 5.75Vdc.

Frequency Error vs. Temperature

Temp. (°C)	LTE Band 5			
	Channel Bandwidth: 10 MHz			
	Low Channel		High Channel	
	Frequency (MHz)	Frequency Error (ppm)	Frequency (MHz)	Frequency Error (ppm)
-30	829.000001	0.002	844.000003	0.004
-20	829.000002	0.002	844.000004	0.005
-10	829.000004	0.004	844.000004	0.005
0	829.000002	0.003	844.000003	0.003
10	829.000001	0.002	844.000002	0.002
20	828.999999	-0.001	843.999999	-0.001
30	828.999997	-0.003	843.999999	-0.001
40	828.999998	-0.002	843.999998	-0.002
50	828.999999	-0.001	843.999997	-0.003

Frequency Error vs. Voltage

Voltage (Volts)	LTE Band 26			
	Channel Bandwidth: 1.4 MHz			
	Low Channel		High Channel	
	Frequency (MHz)	Frequency Error (ppm)	Frequency (MHz)	Frequency Error (ppm)
4.25	824.700001	0.001	848.300002	0.002
5	824.700004	0.004	848.300003	0.004
5.75	824.700002	0.002	848.300004	0.004

Note: The applicant defined the normal working voltage is from 4.25Vdc to 5.75Vdc.

Frequency Error vs. Temperature

Temp. (°C)	LTE Band 26			
	Channel Bandwidth: 1.4 MHz			
	Low Channel		High Channel	
	Frequency (MHz)	Frequency Error (ppm)	Frequency (MHz)	Frequency Error (ppm)
-30	824.700004	0.005	848.300002	0.003
-20	824.700003	0.004	848.300002	0.002
-10	824.700001	0.001	848.300003	0.004
0	824.700003	0.004	848.300001	0.002
10	824.700002	0.003	848.300001	0.001
20	824.699997	-0.004	848.299998	-0.002
30	824.699998	-0.002	848.299998	-0.003
40	824.699998	-0.003	848.299996	-0.004
50	824.699997	-0.003	848.299999	-0.002

Frequency Error vs. Voltage

Voltage (Volts)	LTE Band 26			
	Channel Bandwidth: 3 MHz			
	Low Channel		High Channel	
	Frequency (MHz)	Frequency Error (ppm)	Frequency (MHz)	Frequency Error (ppm)
4.25	825.500004	0.004	847.500004	0.004
5	825.500004	0.005	847.500002	0.002
5.75	825.500003	0.004	847.500001	0.001

Note: The applicant defined the normal working voltage is from 4.25Vdc to 5.75Vdc.

Frequency Error vs. Temperature

Temp. (°C)	LTE Band 26			
	Channel Bandwidth: 3 MHz			
	Low Channel		High Channel	
	Frequency (MHz)	Frequency Error (ppm)	Frequency (MHz)	Frequency Error (ppm)
-30	825.500003	0.004	847.500003	0.003
-20	825.500003	0.004	847.500004	0.004
-10	825.500001	0.001	847.500002	0.002
0	825.500003	0.004	847.500001	0.002
10	825.500003	0.004	847.500003	0.004
20	825.499997	-0.004	847.499998	-0.003
30	825.499999	-0.001	847.499996	-0.004
40	825.499996	-0.004	847.499996	-0.005
50	825.499996	-0.005	847.499997	-0.004

Frequency Error vs. Voltage

Voltage (Volts)	LTE Band 26			
	Channel Bandwidth: 5 MHz			
	Low Channel		High Channel	
	Frequency (MHz)	Frequency Error (ppm)	Frequency (MHz)	Frequency Error (ppm)
4.25	826.500002	0.003	846.500004	0.004
5	826.500002	0.002	846.500004	0.004
5.75	826.500001	0.001	846.500002	0.003

Note: The applicant defined the normal working voltage is from 4.25Vdc to 5.75Vdc.

Frequency Error vs. Temperature

Temp. (°C)	LTE Band 26			
	Channel Bandwidth: 5 MHz			
	Low Channel		High Channel	
	Frequency (MHz)	Frequency Error (ppm)	Frequency (MHz)	Frequency Error (ppm)
-30	826.500003	0.004	846.500002	0.002
-20	826.500001	0.001	846.500002	0.003
-10	826.500004	0.004	846.500002	0.003
0	826.500002	0.002	846.500003	0.003
10	826.500002	0.002	846.500004	0.005
20	826.499998	-0.002	846.499998	-0.003
30	826.499997	-0.004	846.499997	-0.004
40	826.499997	-0.004	846.499998	-0.003
50	826.499997	-0.004	846.499998	-0.002

Frequency Error vs. Voltage

Voltage (Volts)	LTE Band 26			
	Channel Bandwidth: 10 MHz			
	Low Channel		High Channel	
	Frequency (MHz)	Frequency Error (ppm)	Frequency (MHz)	Frequency Error (ppm)
4.25	829.000001	0.002	844.000001	0.002
5	829.000003	0.003	844.000001	0.002
5.75	829.000002	0.002	844.000004	0.005

Note: The applicant defined the normal working voltage is from 4.25Vdc to 5.75Vdc.

Frequency Error vs. Temperature

Temp. (°C)	LTE Band 26			
	Channel Bandwidth: 10 MHz			
	Low Channel		High Channel	
	Frequency (MHz)	Frequency Error (ppm)	Frequency (MHz)	Frequency Error (ppm)
-30	829.000003	0.004	844.000002	0.002
-20	829.000003	0.003	844.000004	0.004
-10	829.000001	0.001	844.000004	0.004
0	829.000001	0.002	844.000004	0.005
10	829.000004	0.004	844.000002	0.002
20	828.999997	-0.004	843.999998	-0.002
30	828.999999	-0.002	843.999997	-0.003
40	828.999997	-0.003	843.999999	-0.002
50	828.999998	-0.003	843.999999	-0.002

Frequency Error vs. Voltage

Voltage (Volts)	LTE Band 26			
	Channel Bandwidth: 15 MHz			
	Low Channel		High Channel	
	Frequency (MHz)	Frequency Error (ppm)	Frequency (MHz)	Frequency Error (ppm)
4.25	831.500002	0.003	841.500004	0.004
5	831.500001	0.002	841.500002	0.002
5.75	831.500003	0.004	841.500003	0.004

Note: The applicant defined the normal working voltage is from 4.25Vdc to 5.75Vdc.

Frequency Error vs. Temperature

Temp. (°C)	LTE Band 26			
	Channel Bandwidth: 15 MHz			
	Low Channel		High Channel	
	Frequency (MHz)	Frequency Error (ppm)	Frequency (MHz)	Frequency Error (ppm)
-30	831.500004	0.005	841.500003	0.003
-20	831.500003	0.003	841.500004	0.004
-10	831.500002	0.003	841.500002	0.002
0	831.500001	0.001	841.500002	0.002
10	831.500003	0.003	841.500002	0.002
20	831.499996	-0.005	841.499998	-0.002
30	831.499998	-0.002	841.499997	-0.004
40	831.499998	-0.003	841.499998	-0.002
50	831.499997	-0.003	841.499996	-0.005

4.4 Occupied Bandwidth Measurement

4.4.1 Test Procedure

The EUT makes a call to the communication simulator. All measurements were done at low, middle and high operational frequency range. The communication simulator station system controlled a EUT to export maximum output power under transmission mode and specific channel frequency. Use OBW measurement function of Spectrum analyzer to measure 99 % occupied bandwidth.

4.4.2 Test Setup

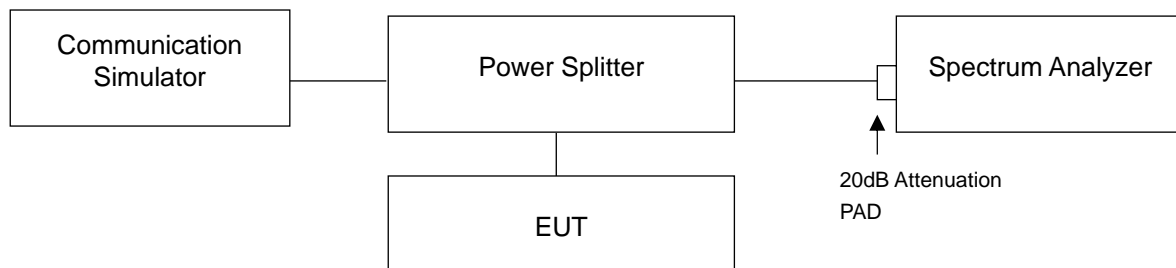

4.4.3 Test Result

Occupied Bandwidth WCDMA Band 5

Channel	Frequency (MHz)	99% Occupied Bandwidth (MHz)		
		WCDMA	HSDPA	HSUPA
4132	826.4	4.13	4.15	4.15
4182	836.4	4.16	4.15	4.16
4233	846.6	4.15	4.15	4.16

Spectrum Plot of Worst Value

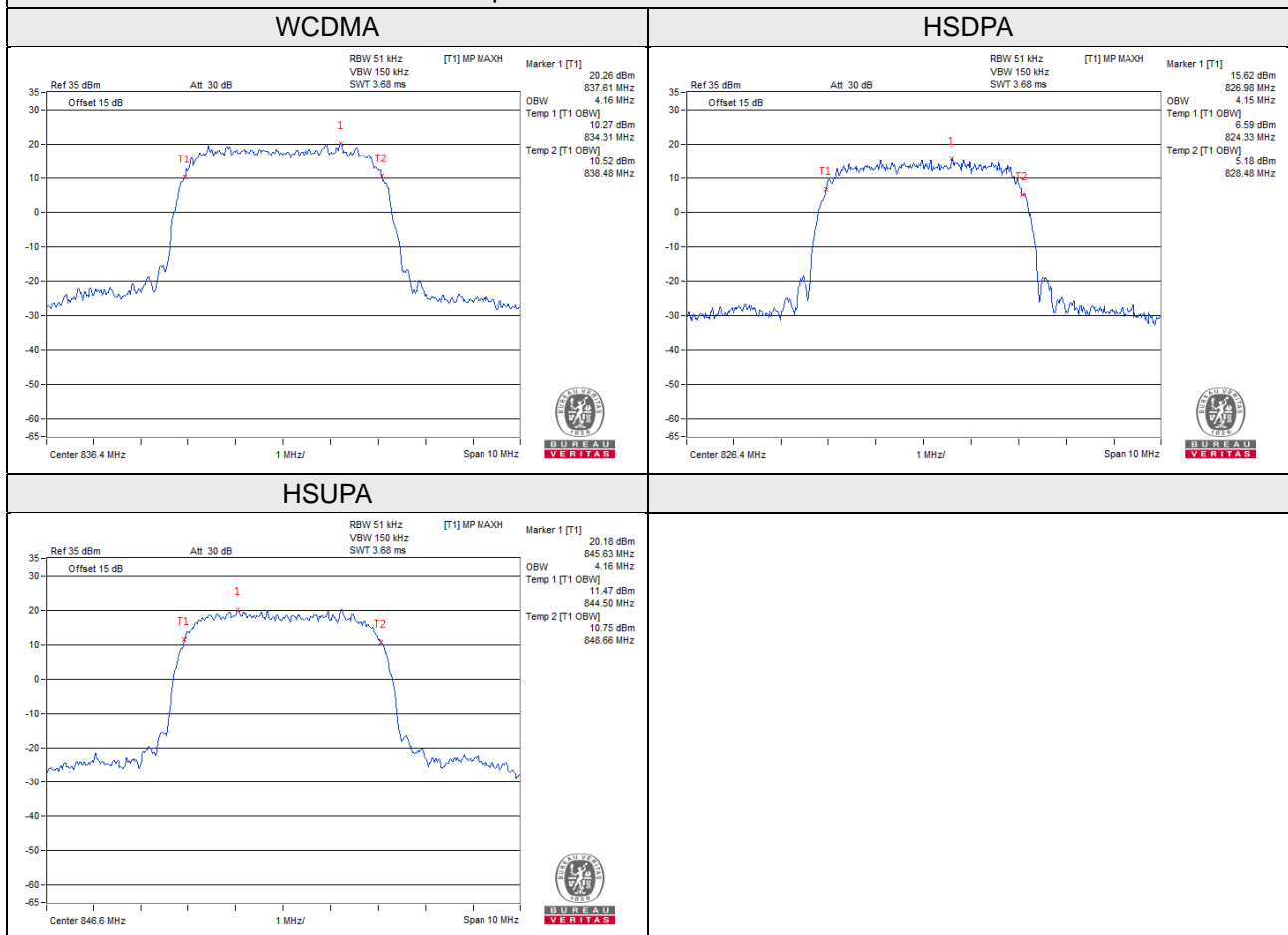

LTE Band 5

LTE Band 5, Channel Bandwidth 1.4MHz				
Channel	Frequency (MHz)	99% Occupied Bandwidth (MHz)		
		QPSK	16QAM	64QAM
20407	824.7	1.09	1.09	1.09
20525	836.5	1.09	1.09	1.09
20643	848.3	1.09	1.09	1.09
LTE Band 5, Channel Bandwidth 3MHz				
Channel	Frequency (MHz)	99% Occupied Bandwidth (MHz)		
		QPSK	16QAM	64QAM
20415	825.5	2.70	2.69	2.70
20525	836.5	2.70	2.69	2.70
20635	847.5	2.70	2.70	2.70
LTE Band 5, Channel Bandwidth 5MHz				
Channel	Frequency (MHz)	99% Occupied Bandwidth (MHz)		
		QPSK	16QAM	64QAM
20425	826.5	4.49	4.49	4.49
20525	836.5	4.49	4.49	4.49
20625	846.5	4.49	4.49	4.49
LTE Band 5, Channel Bandwidth 10MHz				
Channel	Frequency (MHz)	99% Occupied Bandwidth (MHz)		
		QPSK	16QAM	64QAM
20450	829.0	8.96	8.96	8.95
20525	836.5	8.95	8.95	8.95
20600	844.0	8.94	8.94	8.94

Spectrum Plot of Worst Value

1.4MHz / 16QAM



3MHz / 64QAM



5MHz / 64QAM



10MHz / QPSK



LTE Band 26

LTE Band 26, Channel Bandwidth 1.4MHz				
Channel	Frequency (MHz)	99% Occupied Bandwidth (MHz)		
		QPSK	16QAM	64QAM
26797	824.7	1.09	1.09	1.09
26915	836.5	1.09	1.09	1.09
27033	848.3	1.09	1.09	1.09
LTE Band 26, Channel Bandwidth 3MHz				
Channel	Frequency (MHz)	99% Occupied Bandwidth (MHz)		
		QPSK	16QAM	64QAM
26805	825.5	2.70	2.69	2.70
26915	836.5	2.70	2.70	2.70
27025	847.5	2.70	2.69	2.70
LTE Band 26, Channel Bandwidth 5MHz				
Channel	Frequency (MHz)	99% Occupied Bandwidth (MHz)		
		QPSK	16QAM	64QAM
26815	826.5	4.49	4.49	4.49
26915	836.5	4.49	4.49	4.49
27015	846.5	4.48	4.49	4.49
LTE Band 26, Channel Bandwidth 10MHz				
Channel	Frequency (MHz)	99% Occupied Bandwidth (MHz)		
		QPSK	16QAM	64QAM
26840	829.0	8.95	8.96	8.95
26915	836.5	8.95	8.96	8.95
26990	844.0	8.94	8.94	8.94
LTE Band 26, Channel Bandwidth 15MHz				
Channel	Frequency (MHz)	99% Occupied Bandwidth (MHz)		
		QPSK	16QAM	64QAM
26865	831.5	13.44	13.43	13.42
26915	836.5	13.44	13.44	13.42
26965	841.5	13.43	13.42	13.41

Spectrum Plot of Worst Value

1.4MHz / 16QAM



3MHz / 64QAM

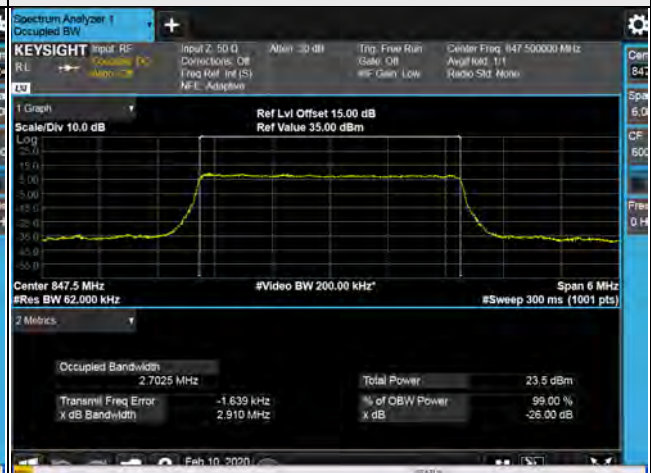

5MHz / 64QAM



10MHz / 16QAM

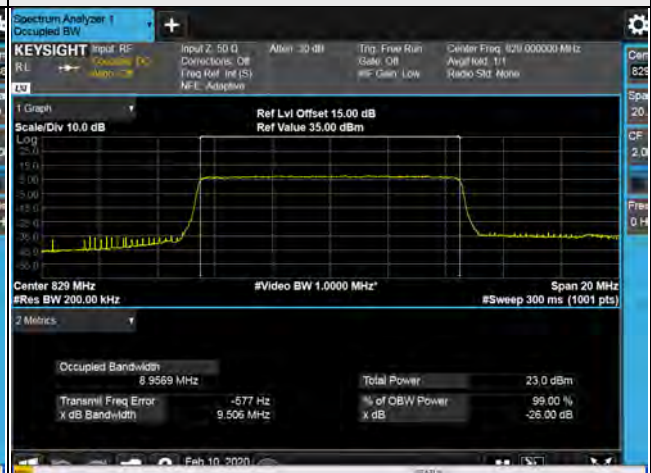

15MHz / QPSK



26dB Bandwidth
WCDMA Band 5

Channel	Frequency (MHz)	26dB Bandwidth (MHz)		
		WCDMA	HSDPA	HSUPA
4132	826.4	4.70	4.72	4.69
4182	836.4	4.73	4.72	4.71
4233	846.6	4.69	4.72	4.71

Spectrum Plot of Worst Value

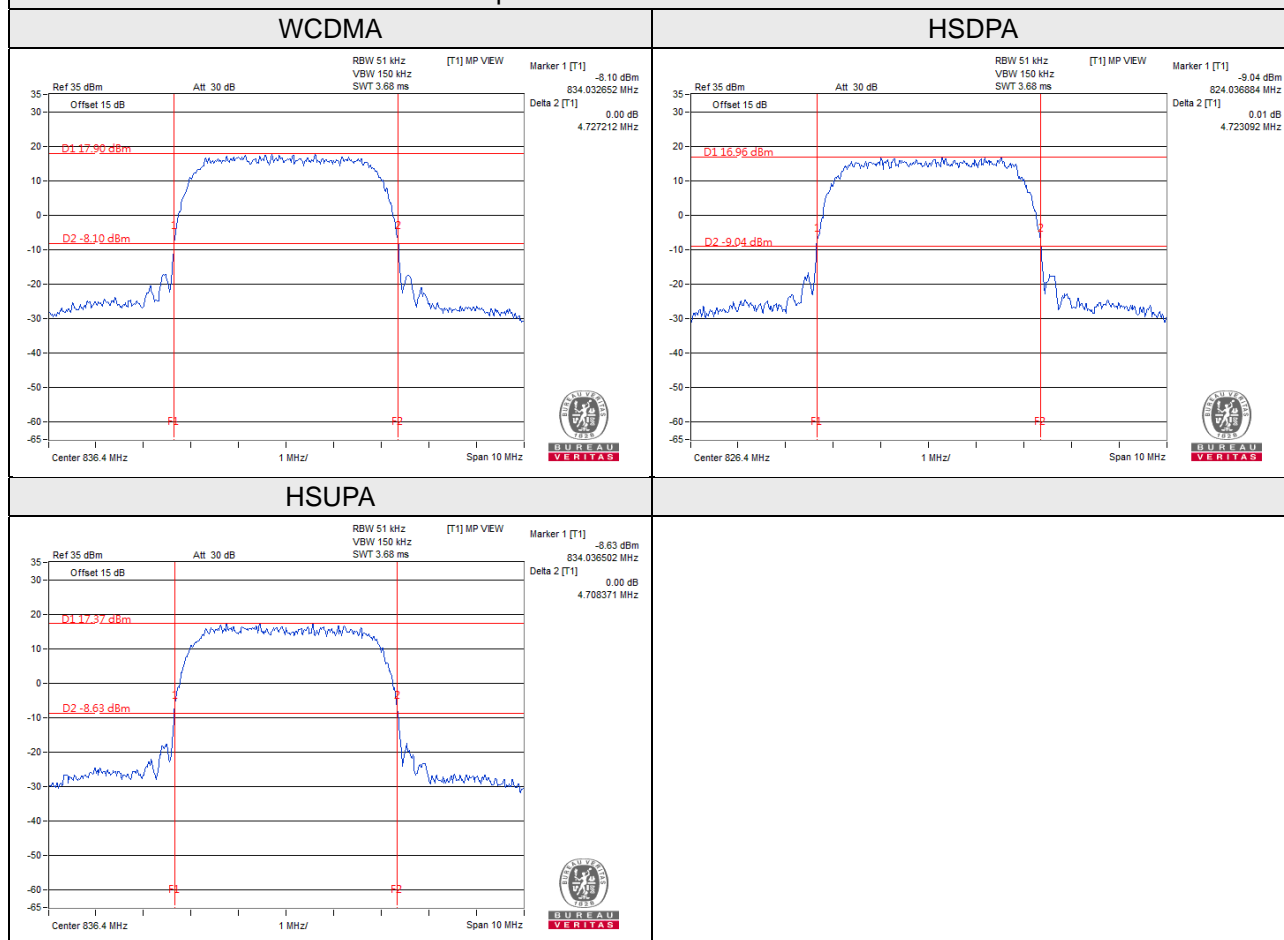

LTE Band 5

LTE Band 5, Channel Bandwidth 1.4MHz				
Channel	Frequency (MHz)	26dB Bandwidth (MHz)		
		QPSK	16QAM	64QAM
20407	824.7	1.21	1.22	1.21
20525	836.5	1.21	1.21	1.21
20643	848.3	1.21	1.21	1.21
LTE Band 5, Channel Bandwidth 3MHz				
Channel	Frequency (MHz)	26dB Bandwidth (MHz)		
		QPSK	16QAM	64QAM
20415	825.5	2.91	2.93	2.92
20525	836.5	2.92	2.92	2.92
20635	847.5	2.92	2.93	2.91
LTE Band 5, Channel Bandwidth 5MHz				
Channel	Frequency (MHz)	26dB Bandwidth (MHz)		
		QPSK	16QAM	64QAM
20425	826.5	4.80	4.79	4.79
20525	836.5	4.79	4.80	4.80
20625	846.5	4.79	4.80	4.80
LTE Band 5, Channel Bandwidth 10MHz				
Channel	Frequency (MHz)	26dB Bandwidth (MHz)		
		QPSK	16QAM	64QAM
20450	829.0	9.50	9.51	9.52
20525	836.5	9.51	9.50	9.51
20600	844.0	9.49	9.49	9.50

Spectrum Plot of Worst Value

1.4MHz / 16QAM



3MHz / 16QAM

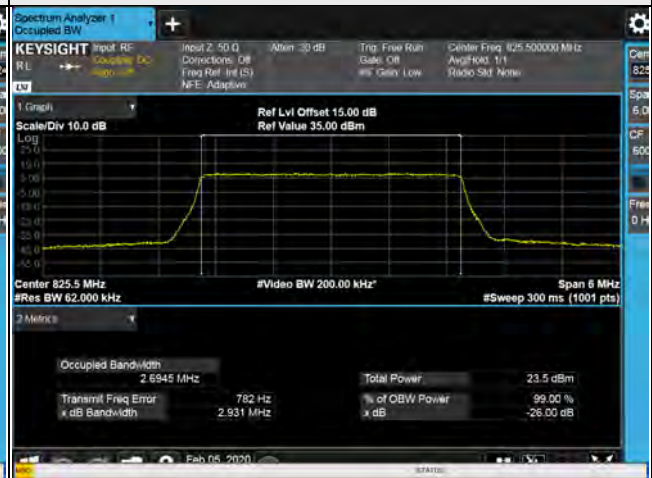

5MHz / 64QAM

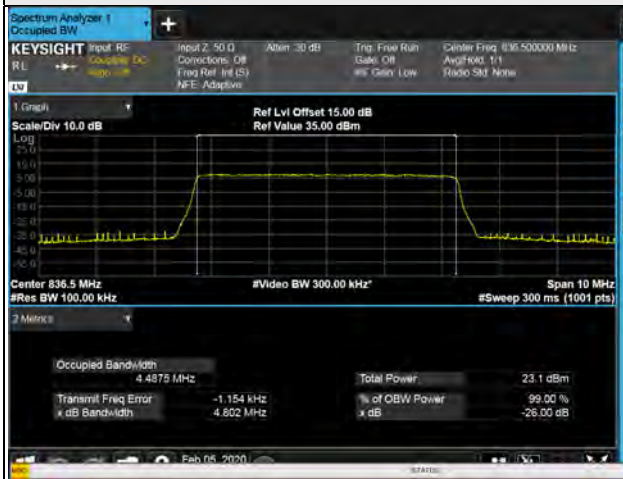

10MHz / 64QAM



LTE Band 26

LTE Band 26, Channel Bandwidth 1.4MHz				
Channel	Frequency (MHz)	26dB Bandwidth (MHz)		
		QPSK	16QAM	64QAM
26797	824.7	1.21	1.21	1.21
26915	836.5	1.22	1.22	1.21
27033	848.3	1.22	1.22	1.22
LTE Band 26, Channel Bandwidth 3MHz				
Channel	Frequency (MHz)	26dB Bandwidth (MHz)		
		QPSK	16QAM	64QAM
26805	825.5	2.92	2.92	2.91
26915	836.5	2.91	2.92	2.91
27025	847.5	2.92	2.91	2.91
LTE Band 26, Channel Bandwidth 5MHz				
Channel	Frequency (MHz)	26dB Bandwidth (MHz)		
		QPSK	16QAM	64QAM
26815	826.5	4.80	4.79	4.80
26915	836.5	4.80	4.80	4.80
27015	846.5	4.80	4.79	4.79
LTE Band 26, Channel Bandwidth 10MHz				
Channel	Frequency (MHz)	26dB Bandwidth (MHz)		
		QPSK	16QAM	64QAM
26840	829.0	9.50	9.51	9.50
26915	836.5	9.49	9.51	9.49
26990	844.0	9.49	9.50	9.50
LTE Band 26, Channel Bandwidth 15MHz				
Channel	Frequency (MHz)	26dB Bandwidth (MHz)		
		QPSK	16QAM	64QAM
26865	831.5	14.23	14.23	14.24
26915	836.5	14.24	14.24	14.23
26965	841.5	14.24	14.24	14.23

Spectrum Plot of Worst Value

1.4MHz / 64QAM



3MHz / QPSK



5MHz / 64QAM

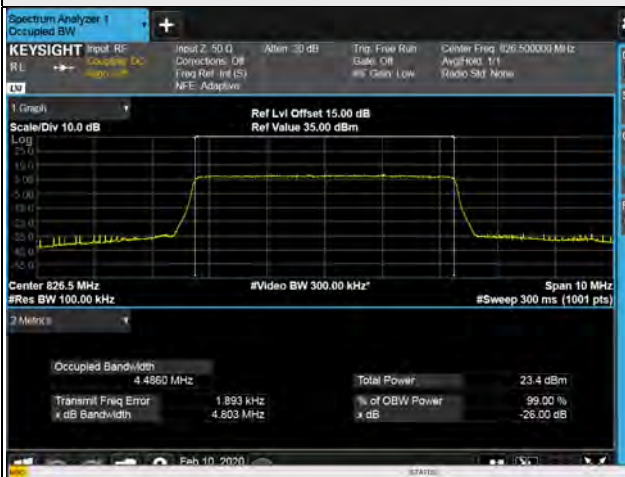

10MHz / 16QAM



15MHz / QPSK



4.5 Band Edge Measurement

4.5.1 Limits of Band Edge Measurement

Power of any emission outside of the authorized operating frequency ranges must be attenuated below the transmitting power (P) by a factor of at least $43 + 10 \log(P)$ dB. In the 1 MHz bands immediately outside and adjacent to the frequency block a resolution bandwidth of at least one percent of the emission bandwidth of the fundamental emission of the transmitter may be employed.

4.5.2 Test Setup

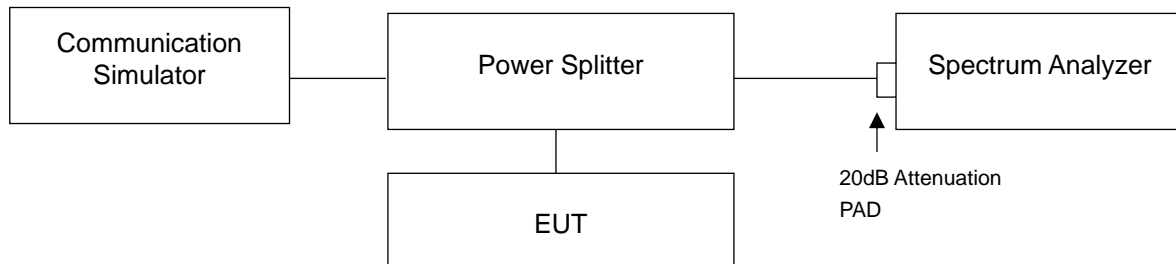

4.5.3 Test Procedures

- a. All measurements were done at low and high operational frequency range.
- b. The center frequency of spectrum is the band edge frequency and span is 10MHz. RB of the spectrum is 51kHz and VB of the spectrum is 150kHz (WCDMA / HSDPA / HSUPA).
- c. The center frequency of spectrum is the band edge frequency and span is 1MHz. RB of the spectrum is 15kHz and VB of the spectrum is 51kHz (LTE Channel Bandwidth 1.4MHz).
- d. The center frequency of spectrum is the band edge frequency and span is 1MHz. RB of the spectrum is 30kHz and VB of the spectrum is 100kHz (LTE Channel Bandwidth 3MHz).
- e. The center frequency of spectrum is the band edge frequency and span is 1MHz. RB of the spectrum is 51kHz and VB of the spectrum is 160kHz (LTE Channel Bandwidth 5MHz).
- f. The center frequency of spectrum is the band edge frequency and span is 1MHz. RB of the spectrum is 100kHz and VB of the spectrum is 300kHz (LTE Channel Bandwidth 10MHz).
- g. The center frequency of spectrum is the band edge frequency and span is 1MHz. RB of the spectrum is 150kHz and VB of the spectrum is 470kHz (LTE Channel Bandwidth 15MHz).
- h. Record the max trace plot into the test report.

4.5.4 Test Results

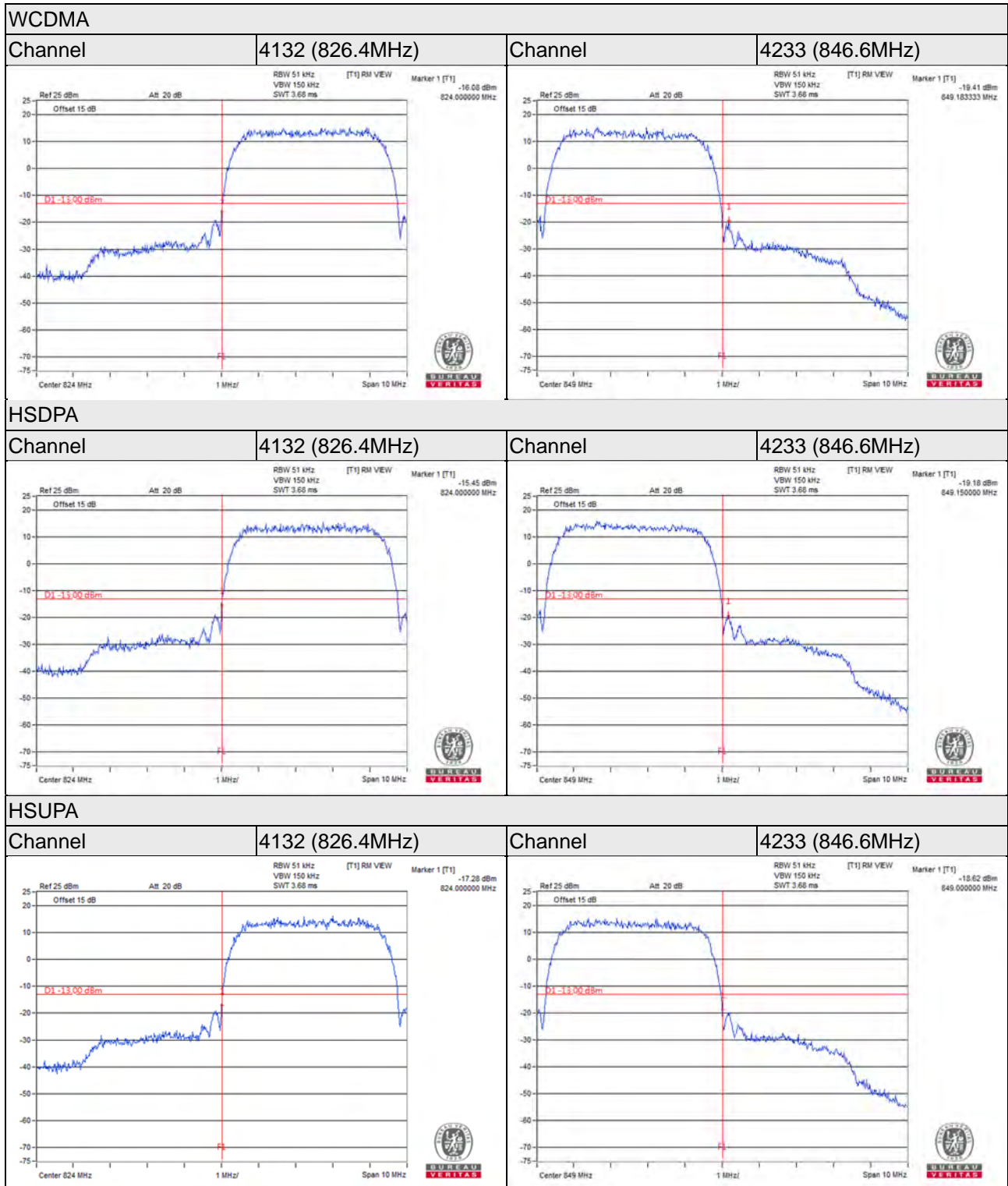

LTE Band 5, Channel Bandwidth 1.4MHz

Channel 20407
(824.7MHz)

QPSK

1 RB / 0 RB Offset

Channel 20643
(848.3MHz)

QPSK

1 RB / 5 RB Offset

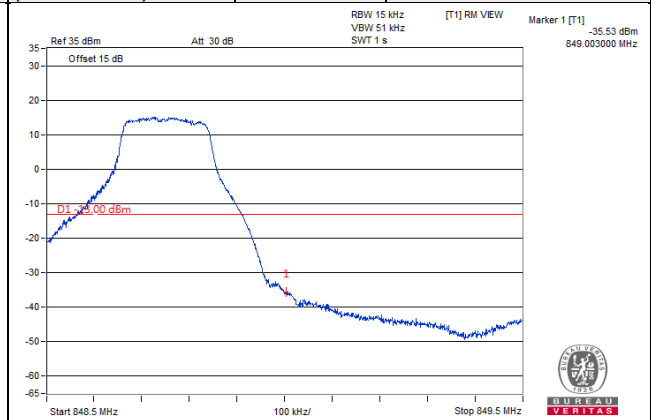
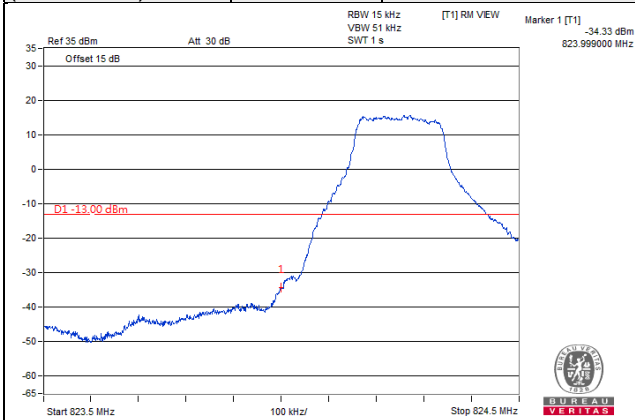

Channel 20407
(824.7MHz)

QPSK

6 RB / 0 RB Offset

Channel 20643
(848.3MHz)

QPSK

6 RB / 0 RB Offset

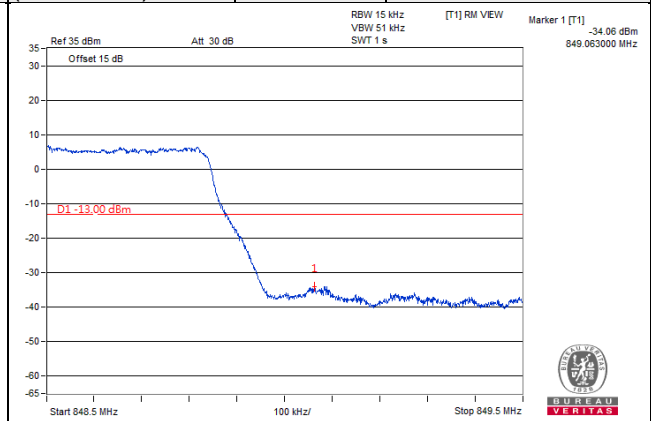
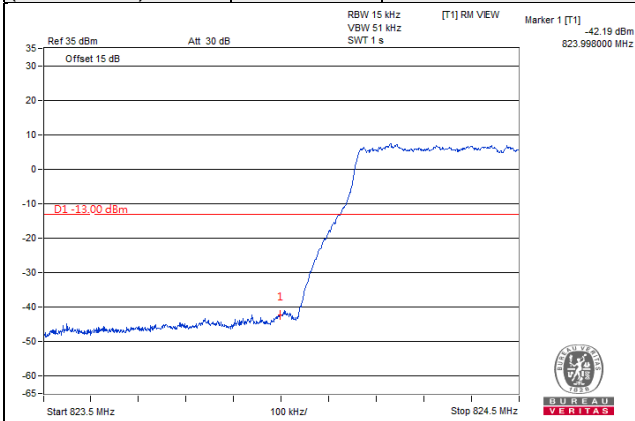

LTE Band 5, Channel Bandwidth 3MHz

Channel 20415 (825.5MHz)	QPSK	1 RB / 0 RB Offset	Channel 20635 (847.5MHz)	QPSK	1 RB / 14 RB Offset
-----------------------------	------	--------------------	-----------------------------	------	---------------------

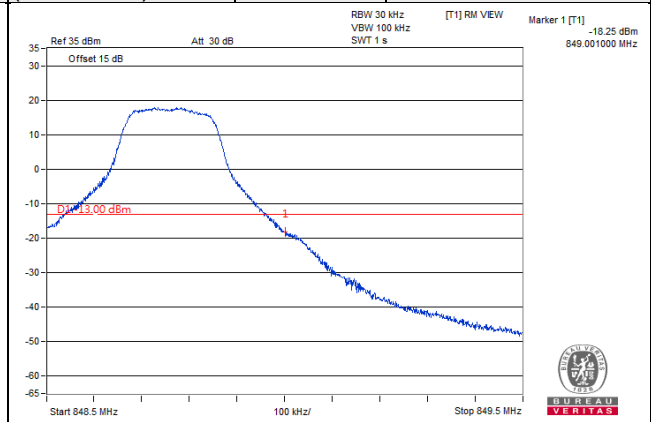
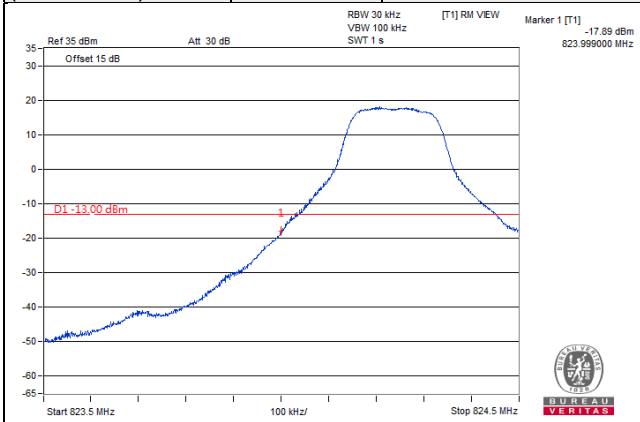

Channel 20415 (825.5MHz)	QPSK	15 RB / 0 RB Offset	Channel 20635 (847.5MHz)	QPSK	15 RB / 0 RB Offset
-----------------------------	------	---------------------	-----------------------------	------	---------------------

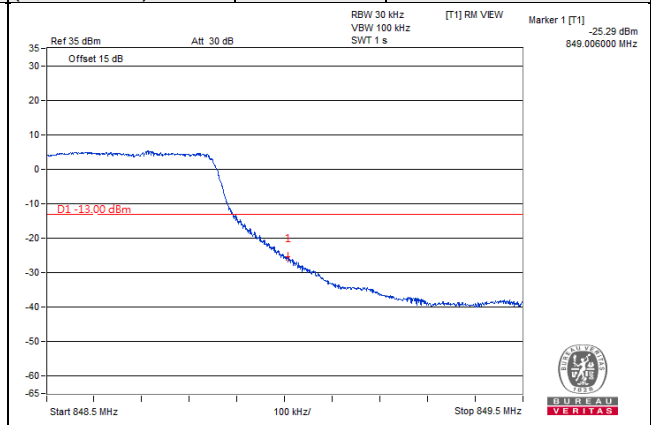
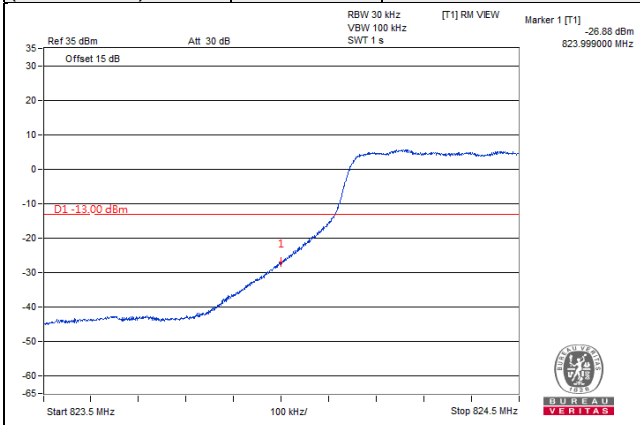

LTE Band 5, Channel Bandwidth 5MHz

Channel 20425
(826.5MHz)

QPSK

1 RB / 0 RB Offset

Channel 20625
(846.5MHz)

QPSK

1 RB / 24 RB Offset

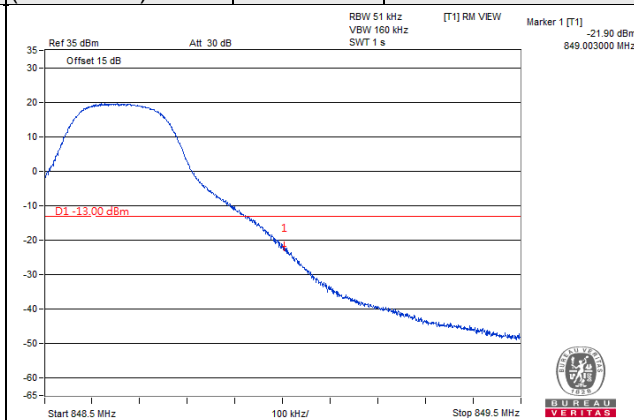
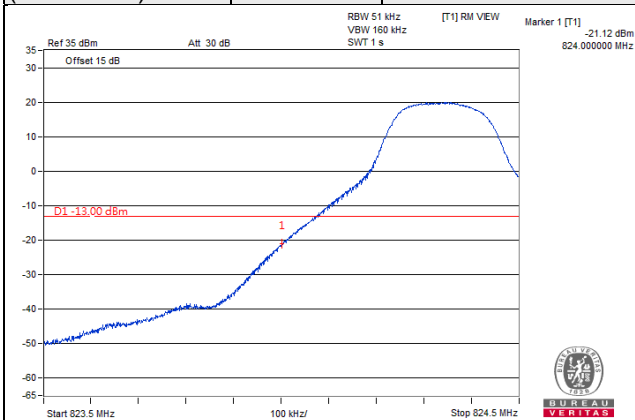

Channel 20425
(826.5MHz)

QPSK

25 RB / 0 RB Offset

Channel 20625
(846.5MHz)

QPSK

25 RB / 0 RB Offset

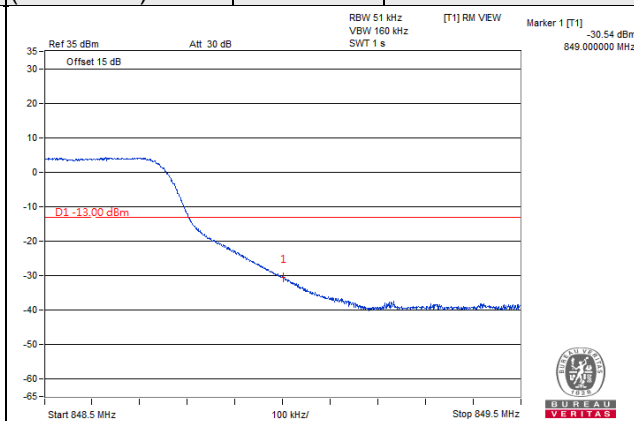
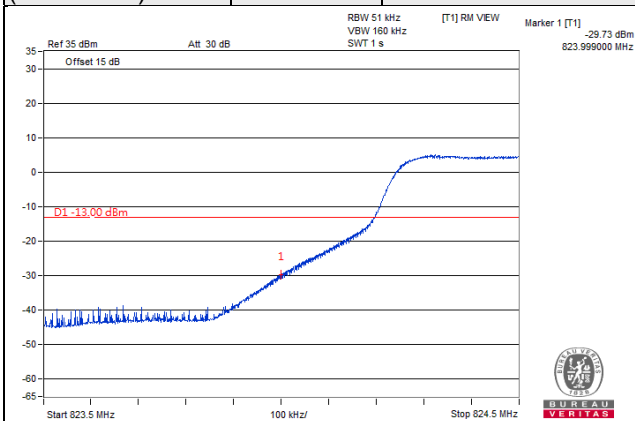

LTE Band 5, Channel Bandwidth 10MHz

Channel 20450
(829.0MHz)

QPSK

1 RB / 0 RB Offset

Channel 20600
(844.0MHz)

QPSK

1 RB / 49 RB Offset

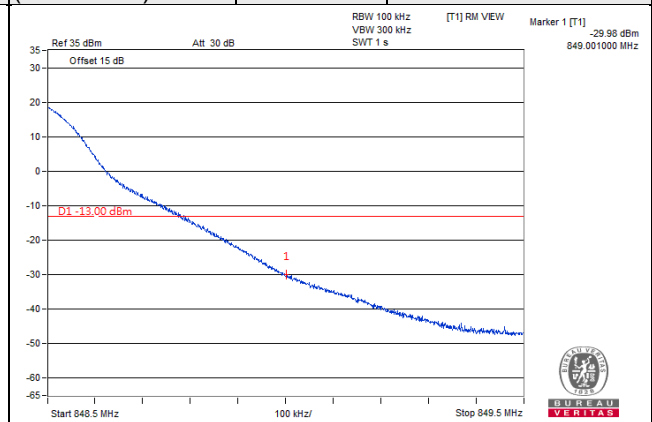
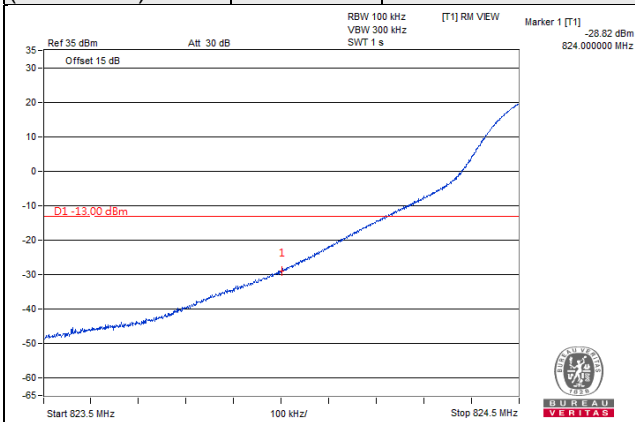

Channel 20450
(829.0MHz)

QPSK

50 RB / 0 RB Offset

Channel 20600
(844.0MHz)

QPSK

50 RB / 0 RB Offset

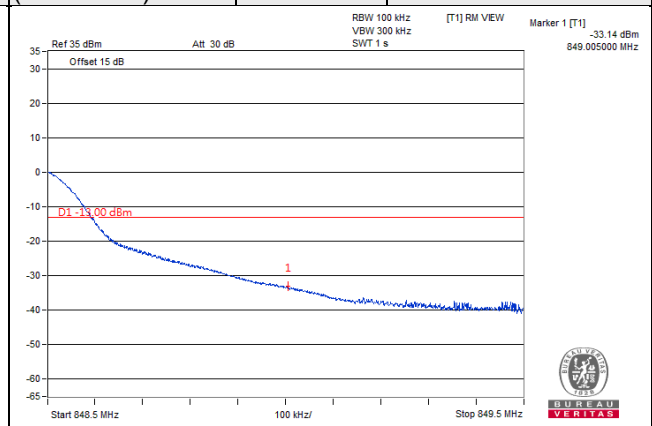
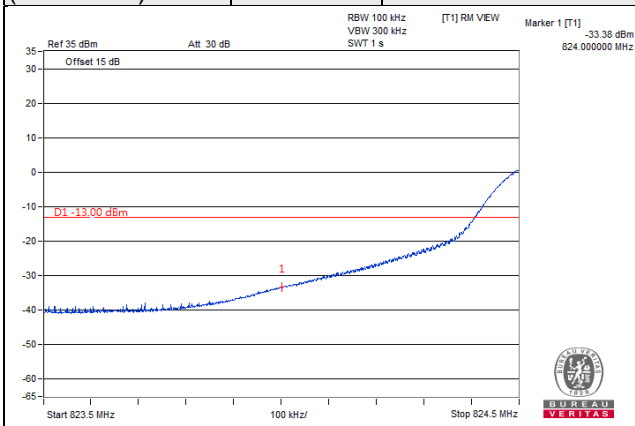

LTE Band 26, Channel Bandwidth 1.4MHz

Channel 26797
(824.7MHz)

QPSK

1 RB / 0 RB Offset

Channel 27033
(848.3MHz)

QPSK

1 RB / 5 RB Offset

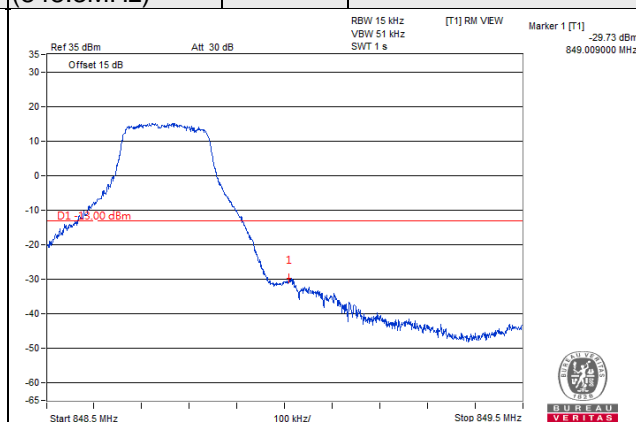
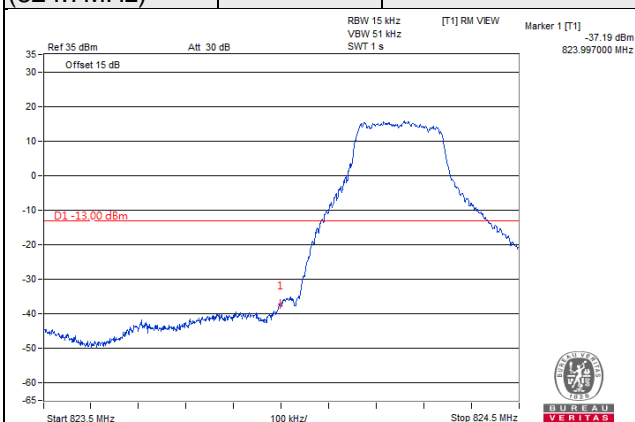

Channel 26797
(824.7MHz)

QPSK

6 RB / 0 RB Offset

Channel 27033
(848.3MHz)

QPSK

6 RB / 0 RB Offset

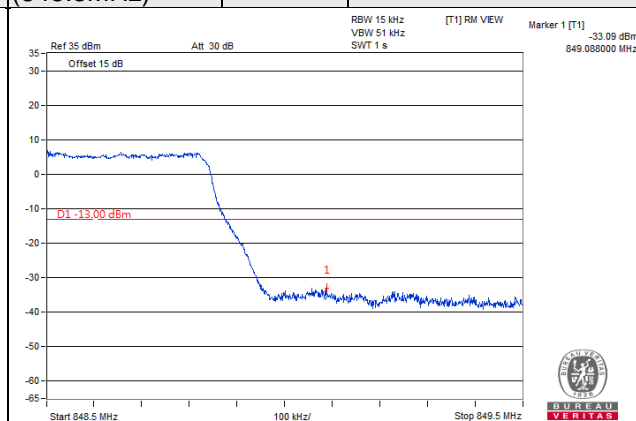
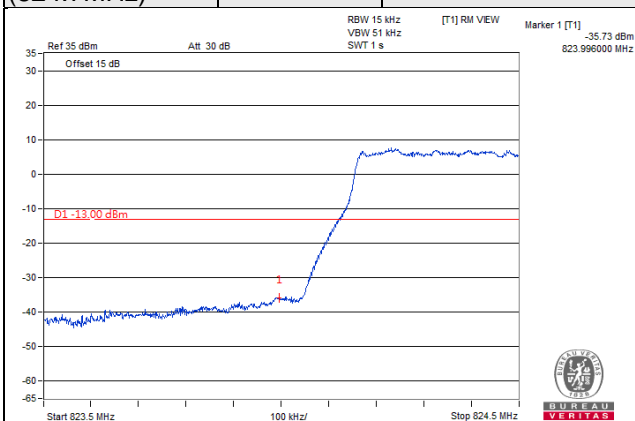

LTE Band 26, Channel Bandwidth 3MHz

Channel 26805 (825.5MHz)	QPSK	1 RB / 0 RB Offset	Channel 27025 (847.5MHz)	QPSK	1 RB / 14 RB Offset
-----------------------------	------	--------------------	-----------------------------	------	---------------------

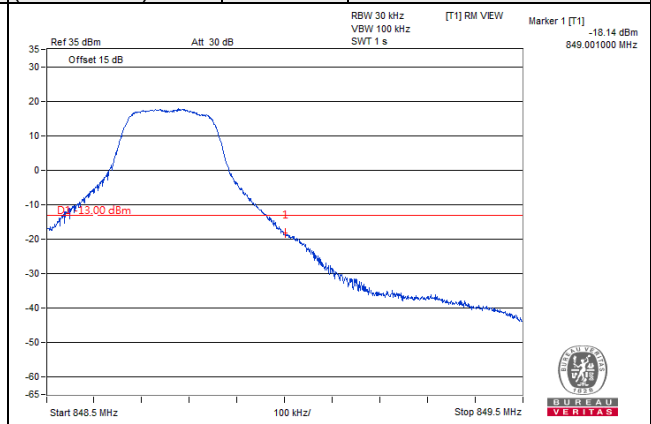
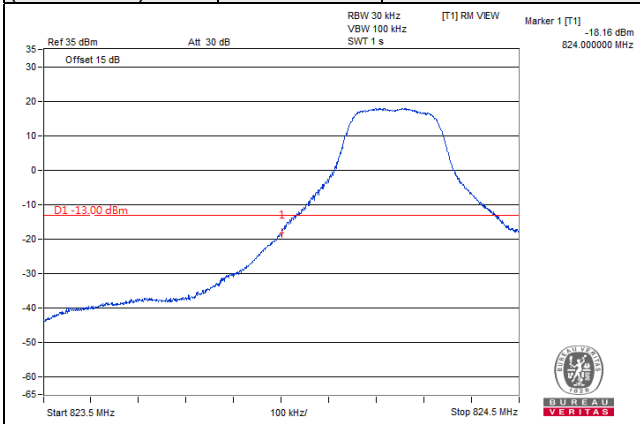

Channel 26805 (825.5MHz)	QPSK	15 RB / 0 RB Offset	Channel 27025 M(847.5MHz)	QPSK	15 RB / 0 RB Offset
-----------------------------	------	---------------------	------------------------------	------	---------------------

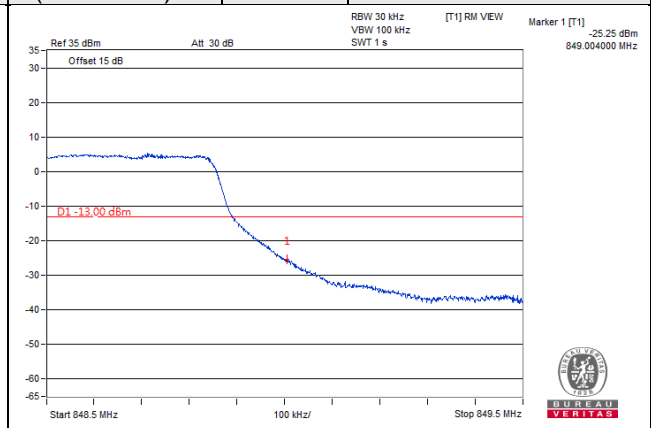
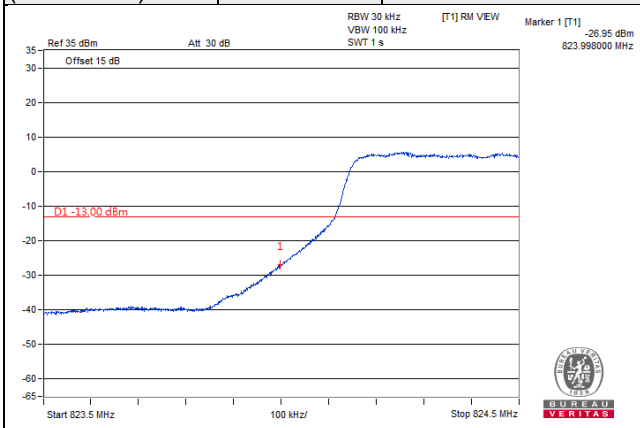

LTE Band 26, Channel Bandwidth 5MHz

Channel 26815
(826.5MHz)

QPSK

1 RB / 0 RB Offset

Channel 27015
(846.5MHz)

QPSK

1 RB / 24 RB Offset

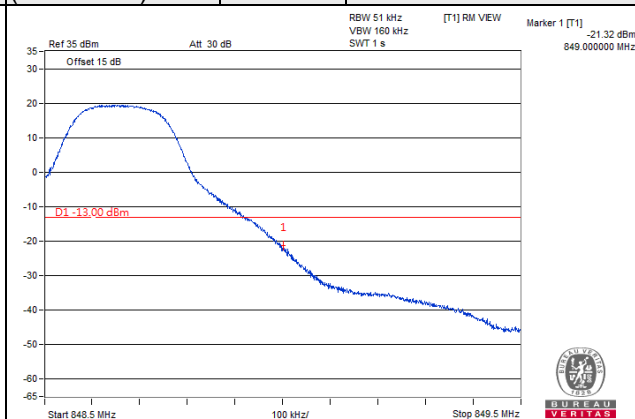
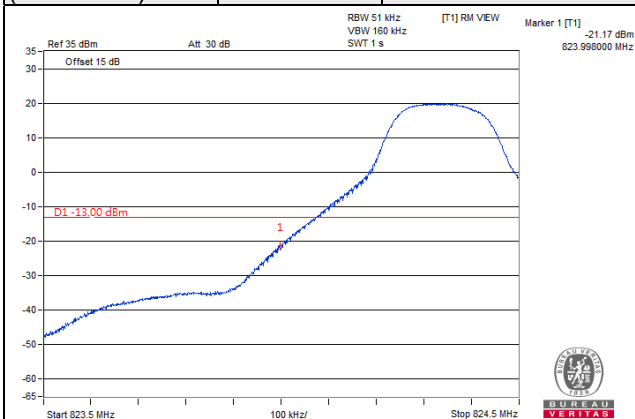

Channel 26815
(826.5MHz)

QPSK

25 RB / 0 RB Offset

Channel 27015
(846.5MHz)

QPSK

25 RB / 0 RB Offset

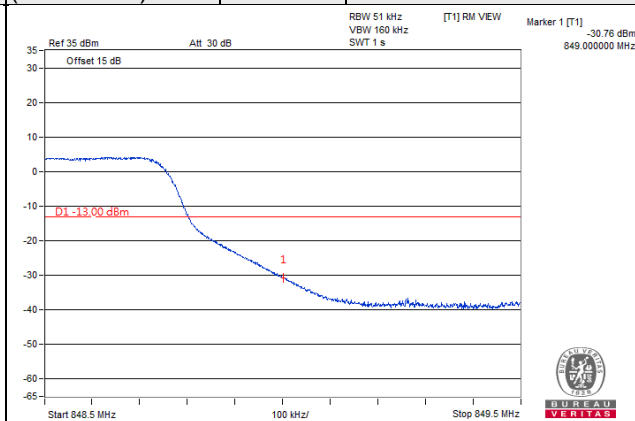
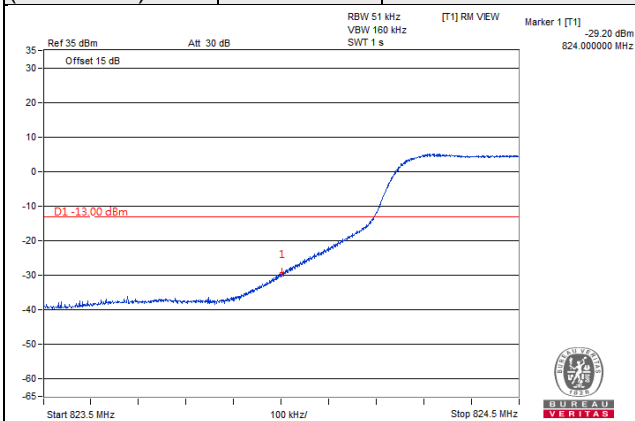

LTE Band 26, Channel Bandwidth 10MHz

Channel 26840 (829MHz)	QPSK	1 RB / 0 RB Offset	Channel 26990 (844MHz)	QPSK	1 RB / 49 RB Offset
---------------------------	------	--------------------	---------------------------	------	---------------------

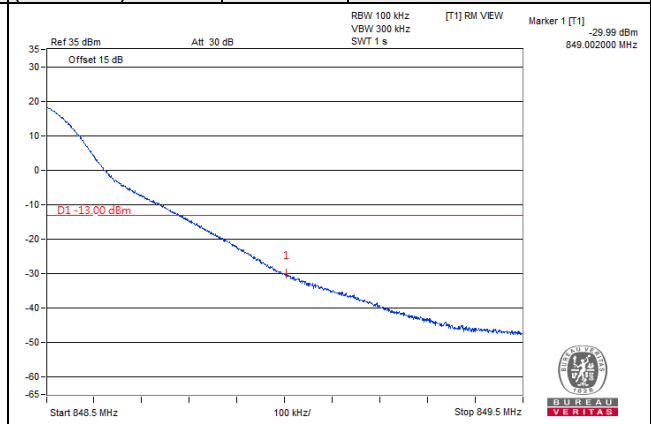
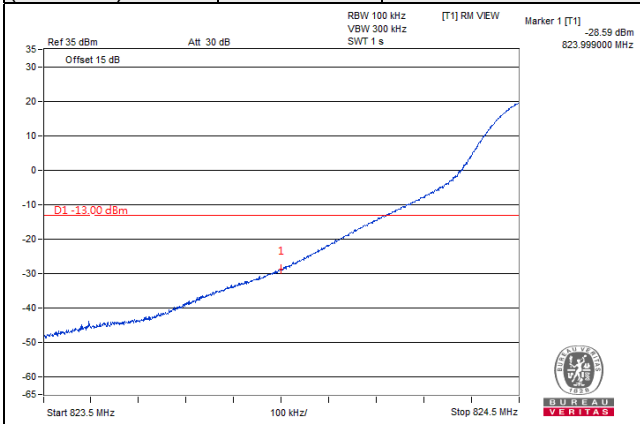

Channel 26840 (829MHz)	QPSK	50 RB / 0 RB Offset	Channel 26990 (844MHz)	QPSK	50 RB / 0 RB Offset
---------------------------	------	---------------------	---------------------------	------	---------------------

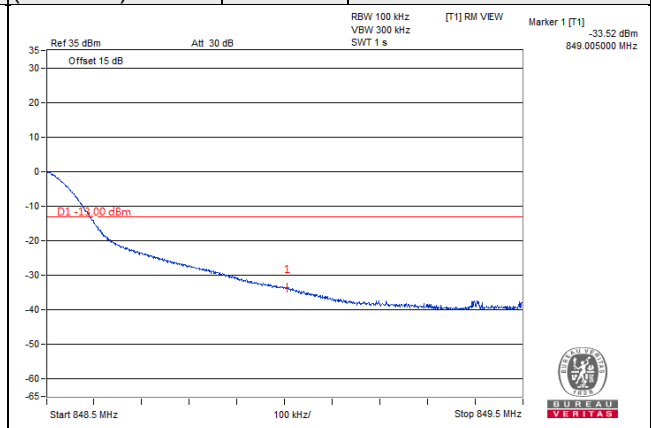
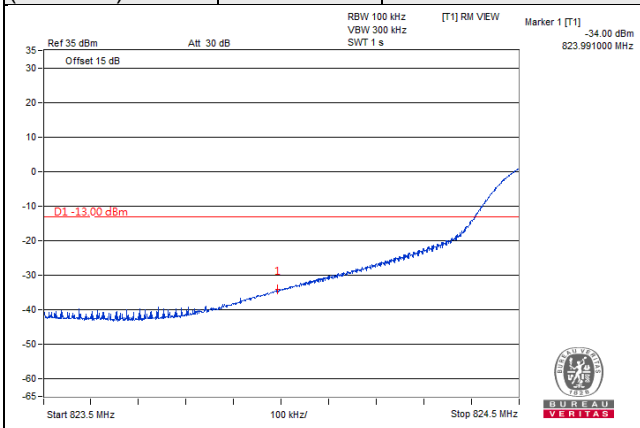

LTE Band 26, Channel Bandwidth 15MHz

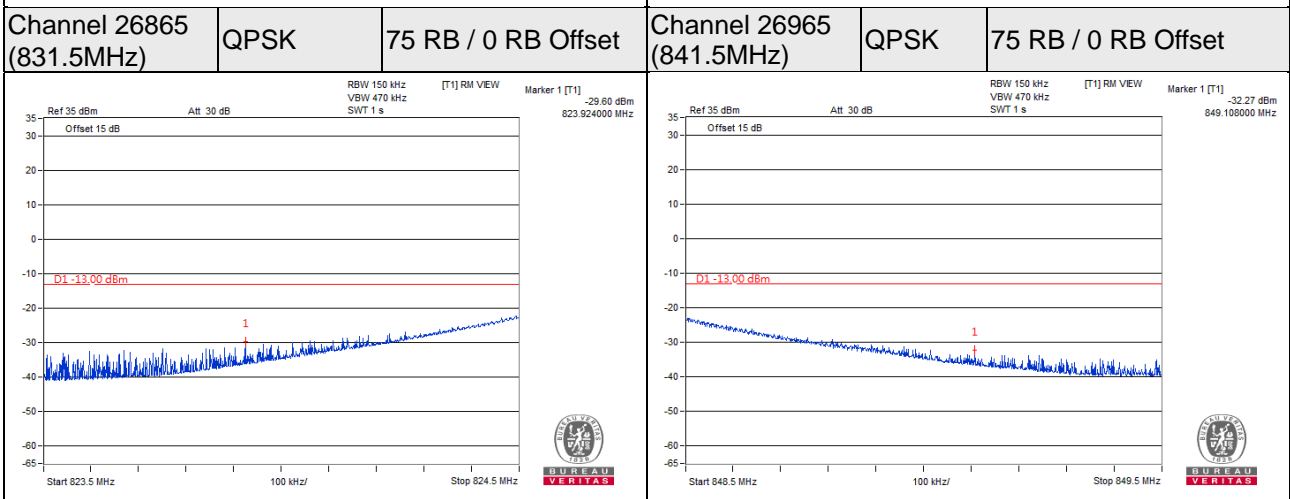
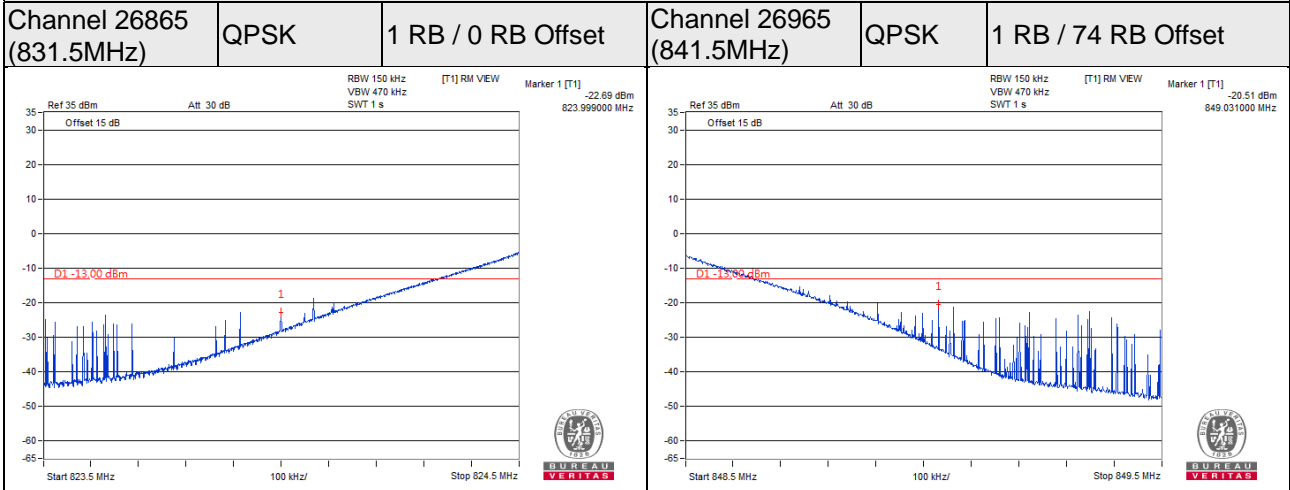

4.6 Peak to Average Ratio

4.6.1 Limits of Peak to Average Ratio Measurement

In measuring transmissions in this band using an average power technique, the peak to-average ratio (PAR) of the transmission may not exceed 13 dB

4.6.2 Test Setup

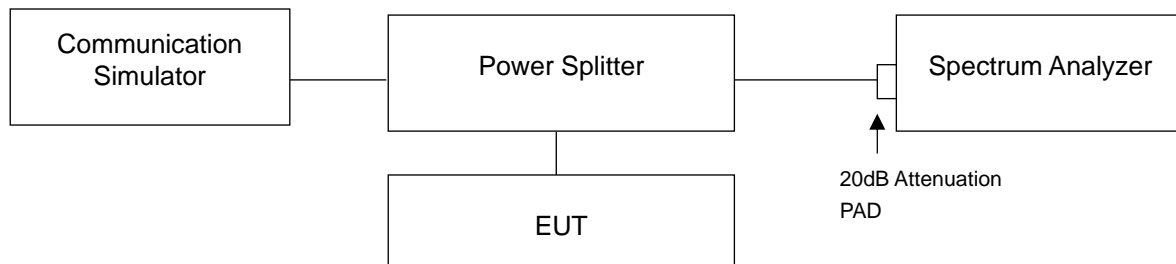

4.6.3 Test Procedures

- Set resolution/measurement bandwidth \geq signal's occupied bandwidth;
- Set the number of counts to a value that stabilizes the measured CCDF curve;
- Record the maximum PAPR level associated with a probability of 0.1%.

4.6.4 Test Results

WCDMA Band 5

Channel	Frequency (MHz)	Peak To Average Ratio (dB)		
		WCDMA	HSDPA	HSUPA
4132	826.4	2.88	2.89	2.89
4182	836.4	2.85	2.85	2.85
4233	846.6	2.92	2.91	2.91

Spectrum Plot of Worst Value

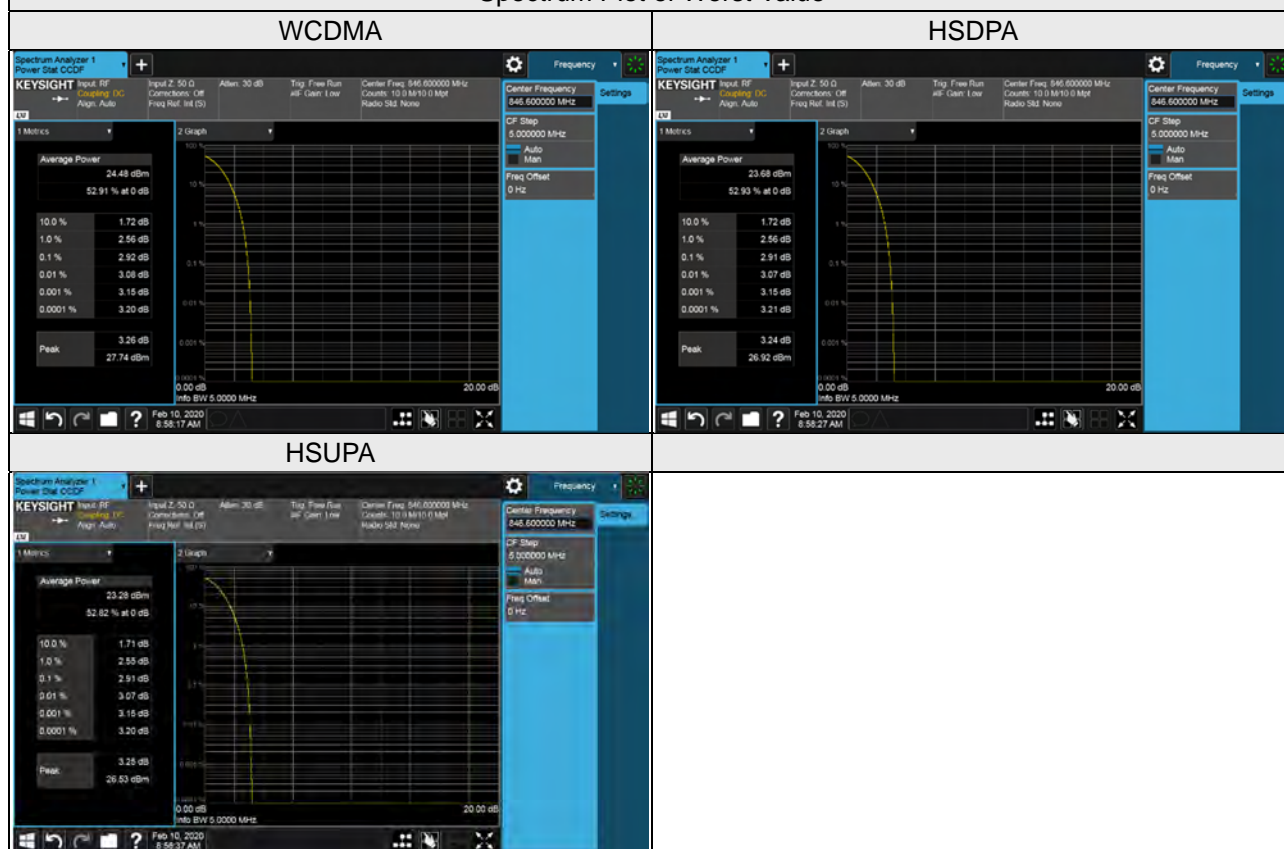

LTE Band 5

LTE Band 5, Channel Bandwidth 1.4MHz				
Channel	Frequency (MHz)	Peak To Average Ratio (dB)		
		QPSK	16QAM	64QAM
20407	824.7	3.90	5.48	5.64
20525	836.5	3.80	5.40	5.57
20643	848.3	3.74	4.39	4.47
LTE Band 5, Channel Bandwidth 3MHz				
Channel	Frequency (MHz)	Peak To Average Ratio (dB)		
		QPSK	16QAM	64QAM
20415	825.5	3.69	5.37	5.49
20525	836.5	3.65	5.55	5.53
20635	847.5	3.54	4.68	4.80
LTE Band 5, Channel Bandwidth 5MHz				
Channel	Frequency (MHz)	Peak To Average Ratio (dB)		
		QPSK	16QAM	64QAM
20425	826.5	3.56	5.32	5.40
20525	836.5	3.61	5.44	5.46
20625	846.5	3.59	5.28	5.33
LTE Band 5, Channel Bandwidth 10MHz				
Channel	Frequency (MHz)	Peak To Average Ratio (dB)		
		QPSK	16QAM	64QAM
20450	829.0	3.59	5.13	5.30
20525	836.5	3.79	5.41	5.66
20600	844.0	3.54	5.08	5.29

Spectrum Plot of Worst Value

1.4MHz / 64QAM

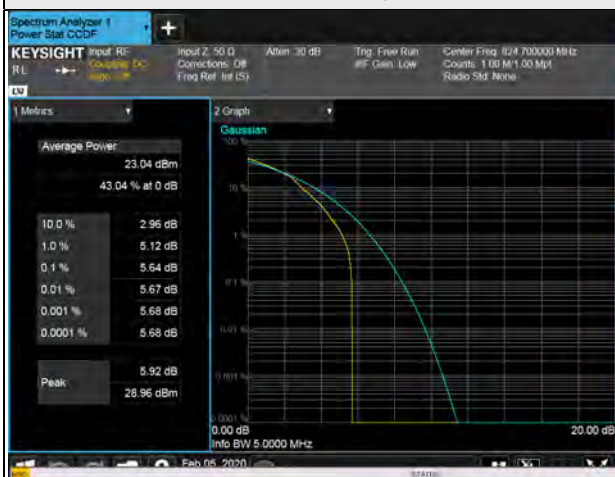

3MHz / 16QAM



5MHz / 64QAM

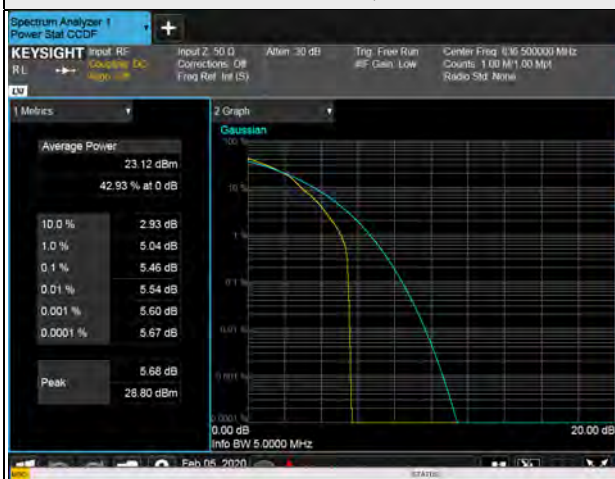

10MHz / 64QAM

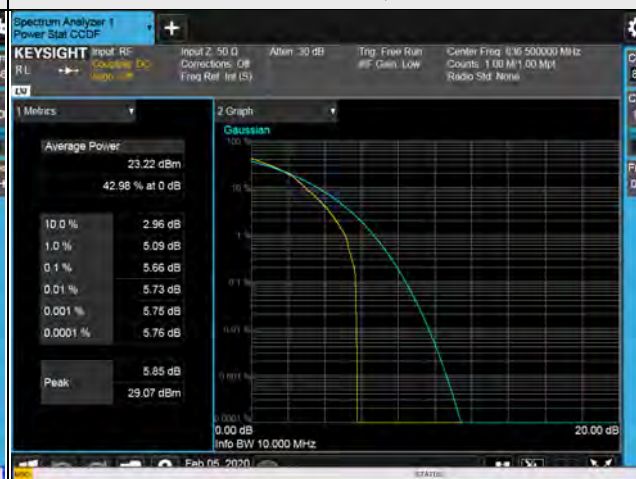

LTE Band 26

LTE Band 26, Channel Bandwidth 1.4MHz				
Channel	Frequency (MHz)	Peak To Average Ratio (dB)		
		QPSK	16QAM	64QAM
26797	824.7	3.86	5.54	5.62
26915	836.5	3.78	5.39	5.48
27033	848.3	3.60	4.21	4.47
LTE Band 26, Channel Bandwidth 3MHz				
Channel	Frequency (MHz)	Peak To Average Ratio (dB)		
		QPSK	16QAM	64QAM
26805	825.5	3.67	5.34	5.44
26915	836.5	3.66	5.49	5.49
27025	847.5	3.55	4.46	4.55
LTE Band 26, Channel Bandwidth 5MHz				
Channel	Frequency (MHz)	Peak To Average Ratio (dB)		
		QPSK	16QAM	64QAM
26815	826.5	3.63	5.37	5.39
26915	836.5	3.77	5.54	5.62
27015	846.5	3.62	5.06	5.13
LTE Band 26, Channel Bandwidth 10MHz				
Channel	Frequency (MHz)	Peak To Average Ratio (dB)		
		QPSK	16QAM	64QAM
26840	829.0	3.47	5.21	5.36
26915	836.5	3.85	5.59	5.75
26990	844.0	3.56	5.10	5.31
LTE Band 26, Channel Bandwidth 15MHz				
Channel	Frequency (MHz)	Peak To Average Ratio (dB)		
		QPSK	16QAM	64QAM
26865	831.5	3.35	5.15	5.18
26915	836.5	3.55	5.38	5.49
26965	841.5	3.56	5.26	5.46

Spectrum Plot of Worst Value

1.4MHz / 64QAM



3MHz / 64QAM

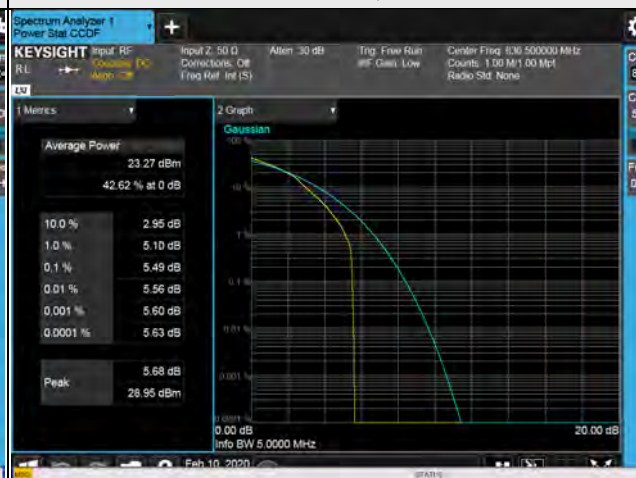

5MHz / 64QAM

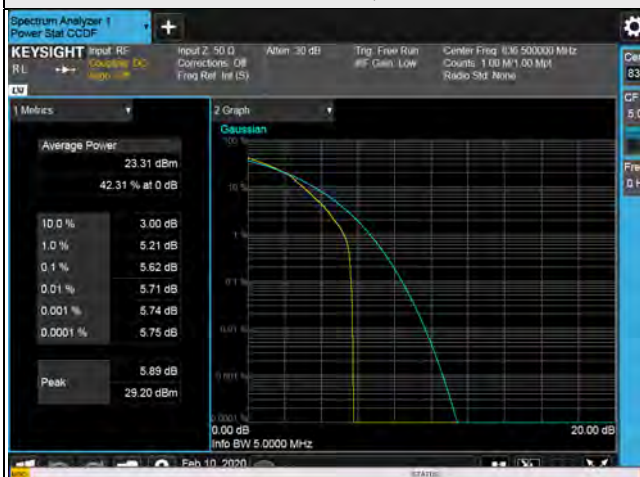

10MHz / 64QAM

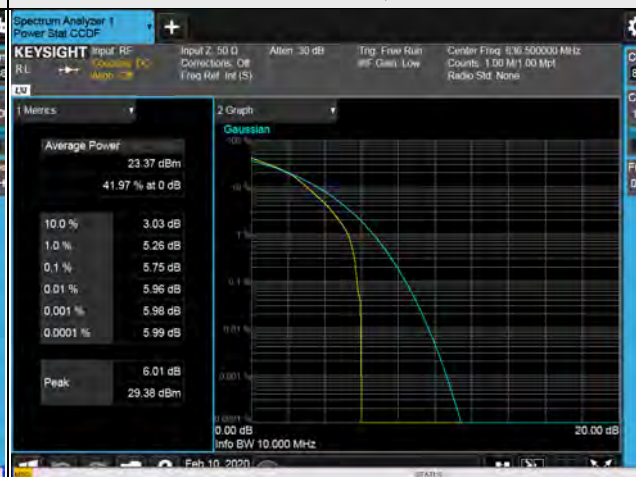

15MHz / 64QAM

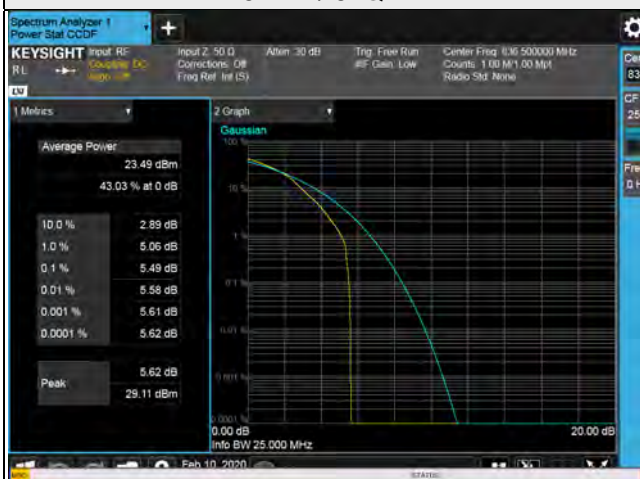

4.7 Conducted Spurious Emissions

4.7.1 Limits of Conducted Spurious Emissions Measurement

The power of any emission outside of the authorized operating frequency ranges must be attenuated below the transmitting power (P) by a factor of at least $43 + 10 \log(P)$ dB. The emission limit equal to -13dBm .

4.7.2 Test Setup

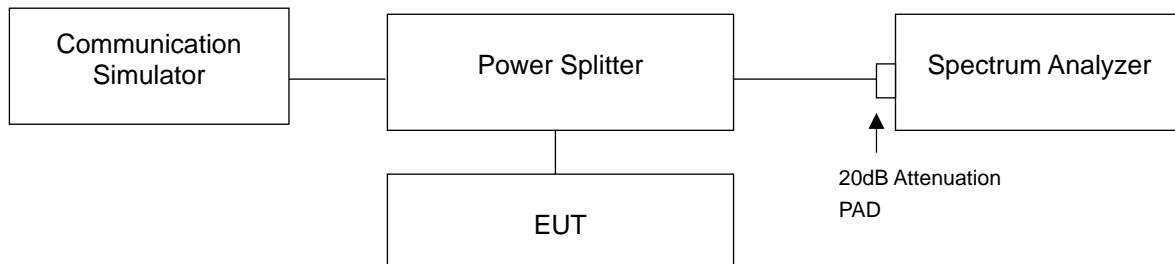

4.7.3 Test Procedure

- The EUT makes a phone call to the communication simulator. All measurements were done at low, middle and high operational frequency range.
- Measuring frequency range is from 9kHz to 9GHz /10GHz. 20dB attenuation pad is connected with spectrum. RBW=1MHz and VBW=3MHz is used for conducted emission measurement.

4.7.4 Test Results



*The 9kHz signal over the limit is from Spectrum.

HSDPA

Channel 4132 (826.4MHz)

Frequency Range : 9kHz~1GHz

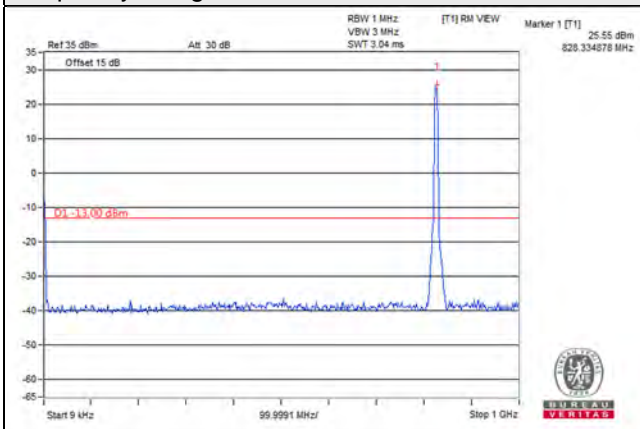

Frequency Range : 1GHz~10GHz

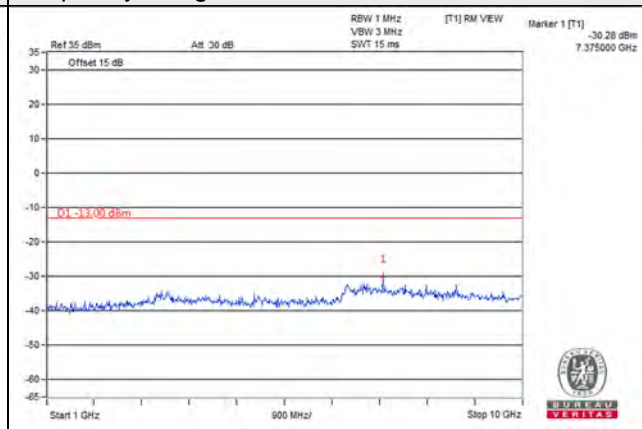

Channel 4182 (836.4MHz)

Frequency Range : 9kHz~1GHz

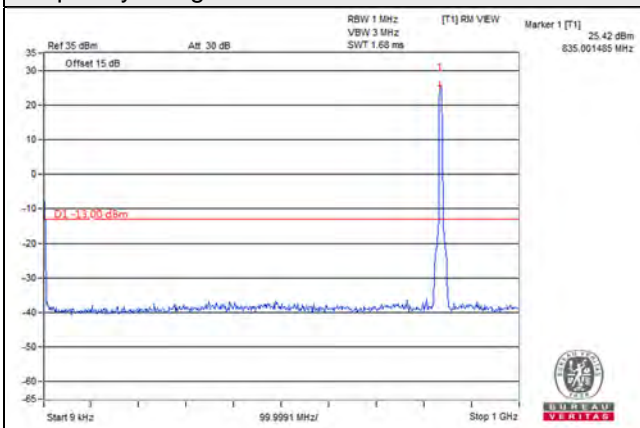

Frequency Range : 1GHz~10GHz

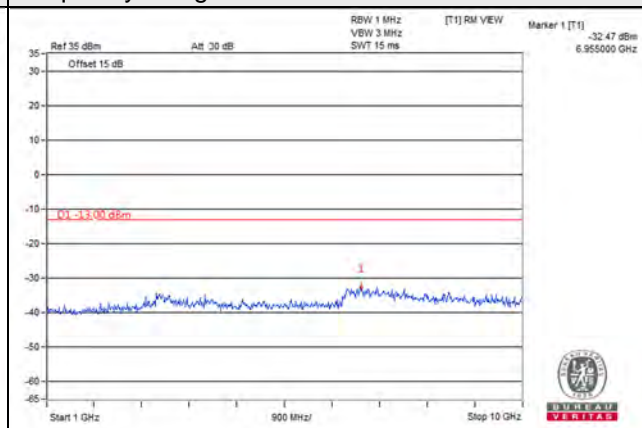

Channel 4233 (846.6MHz)

Frequency Range : 9kHz~1GHz

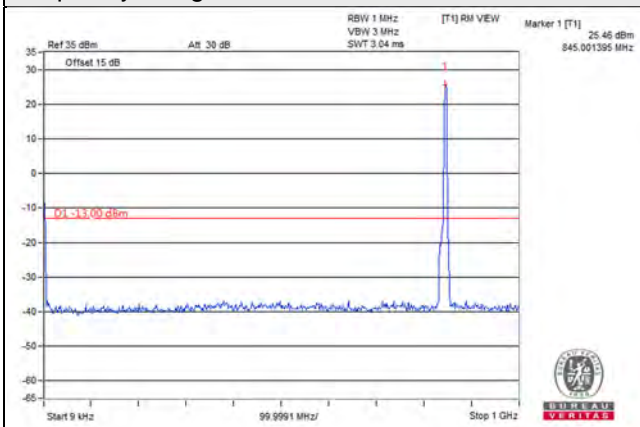

Frequency Range : 1GHz~10GHz

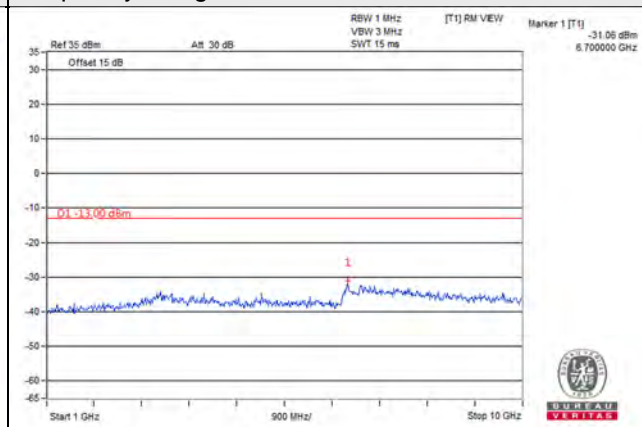

*The 9kHz signal over the limit is from Spectrum.

HSUPA

Channel 4132 (826.4MHz)

Frequency Range : 9kHz~1GHz

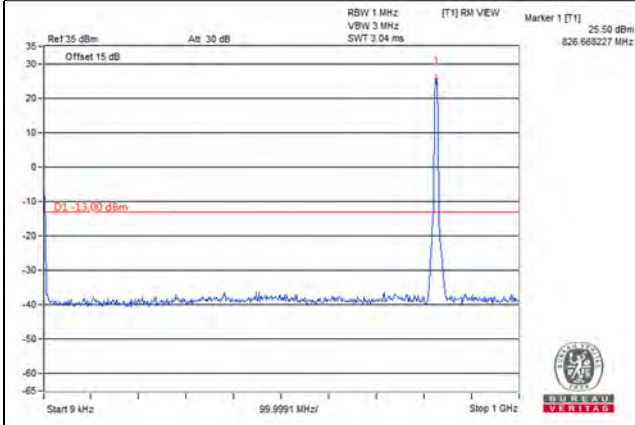

Frequency Range : 1GHz~10GHz

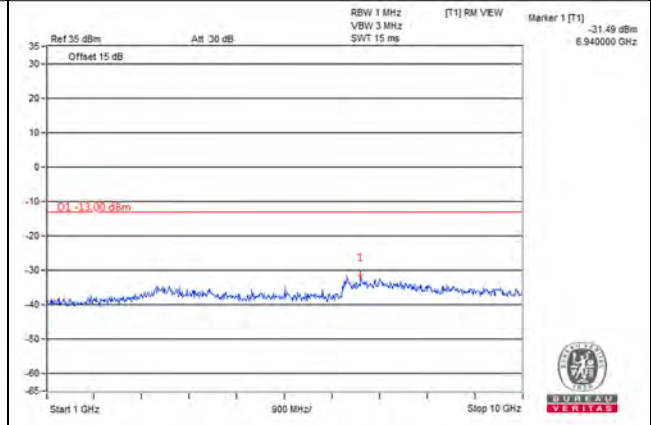

Channel 4182 (836.4MHz)

Frequency Range : 9kHz~1GHz

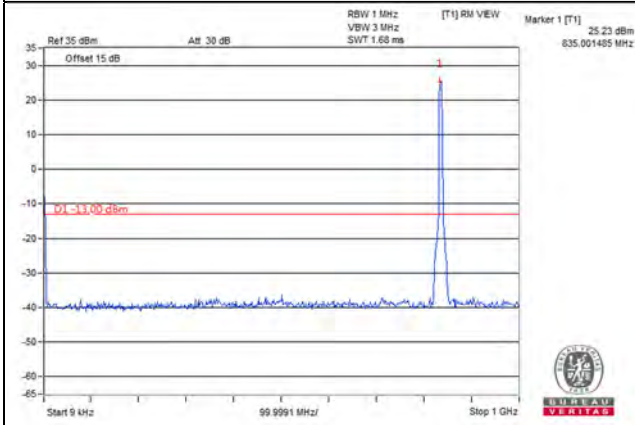

Frequency Range : 1GHz~10GHz

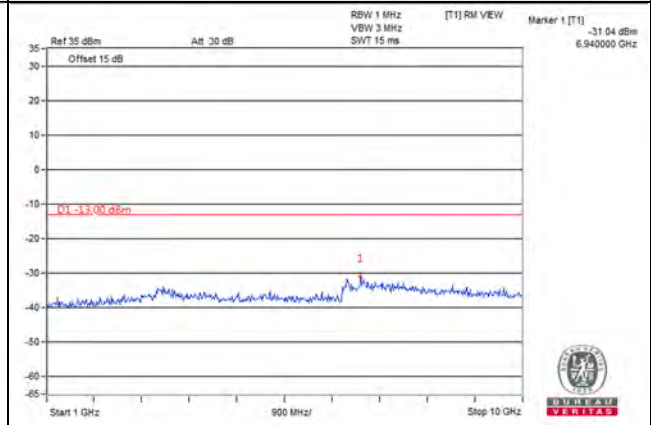

Channel 4233 (846.6MHz)

Frequency Range : 9kHz~1GHz

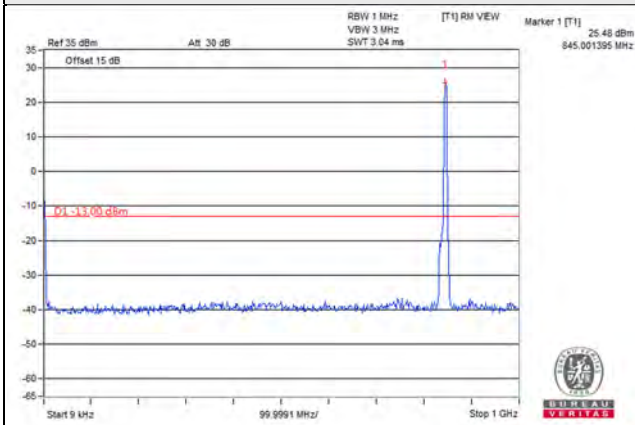

Frequency Range : 1GHz~10GHz

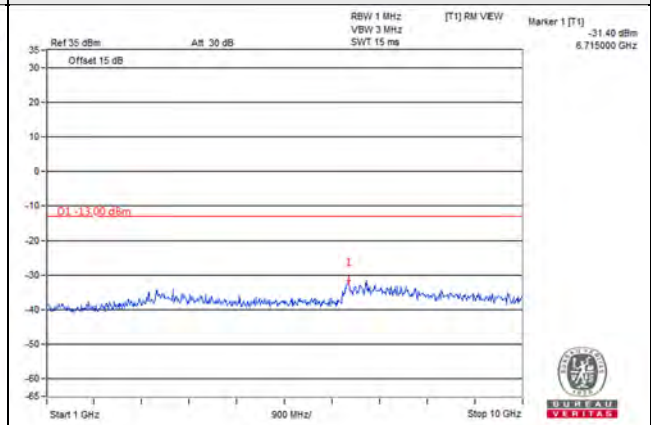

*The 9kHz signal over the limit is from Spectrum.

LTE Band 5, Channel Bandwidth 1.4MHz

Channel 20407 (824.7MHz)

Frequency Range : 9kHz~1GHz

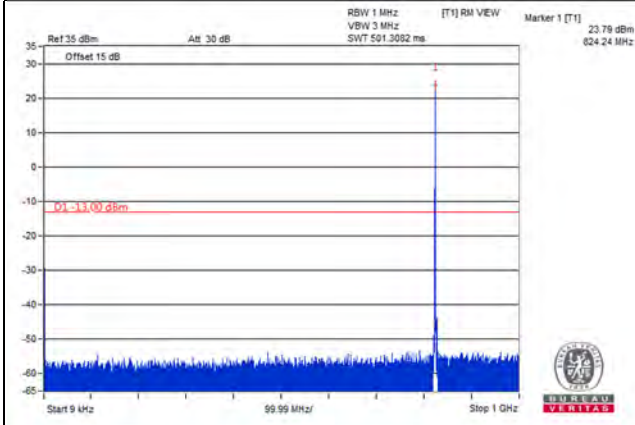

Frequency Range : 1GHz~9GHz

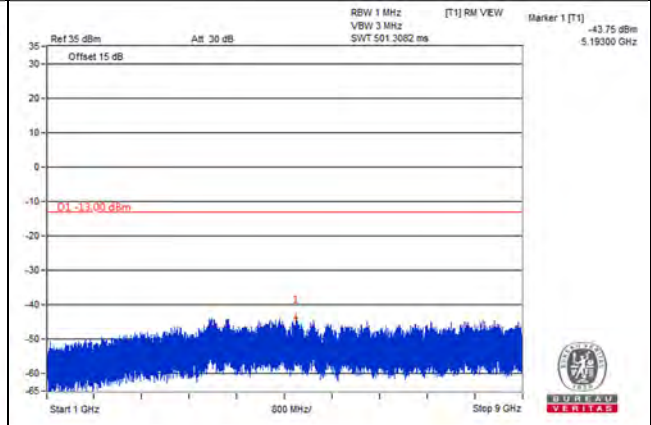

Channel 20525 (836.5MHz)

Frequency Range : 9kHz~1GHz

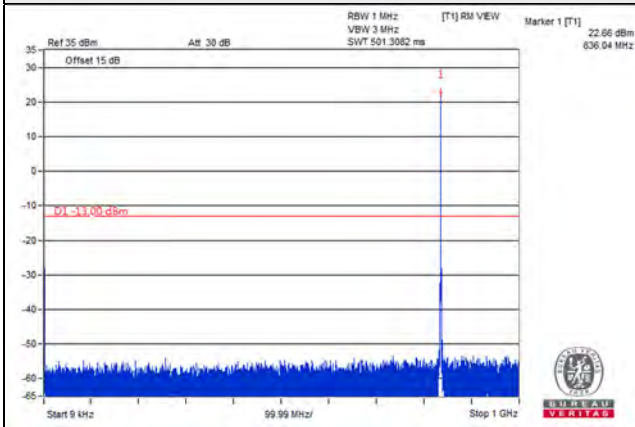

Frequency Range : 1GHz~9GHz

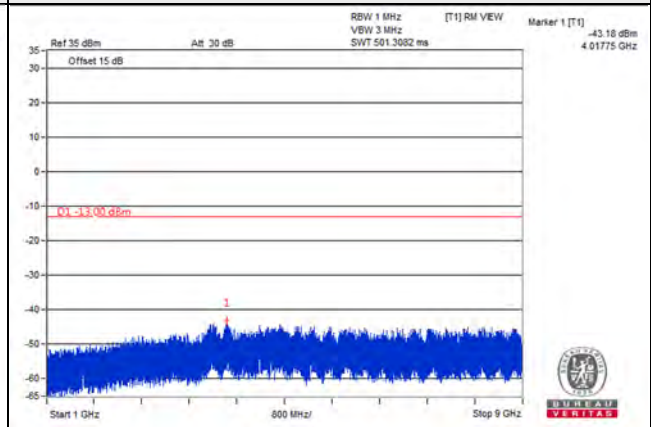

Channel 20643 (848.3MHz)

Frequency Range : 9kHz~1GHz

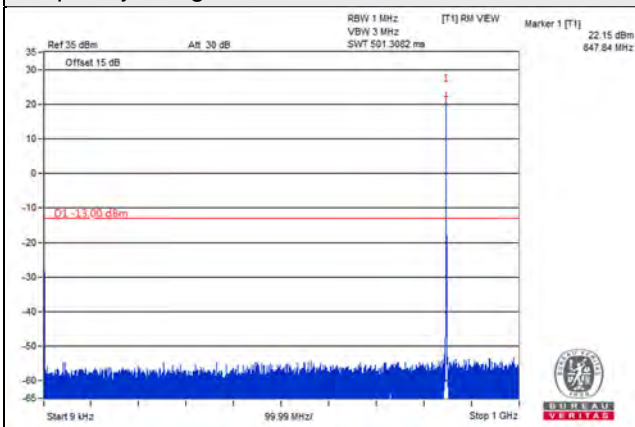

Frequency Range : 1GHz~9GHz

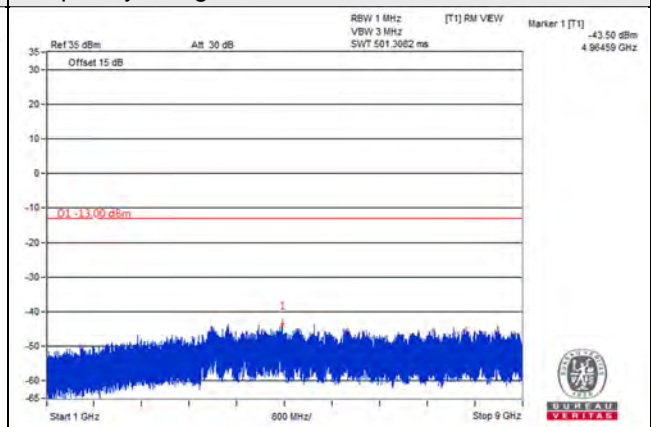

*The 9kHz signal over the limit is from Spectrum.

LTE Band 5, Channel Bandwidth 3MHz

Channel 20415 (825.5MHz)

Frequency Range : 9kHz~1GHz

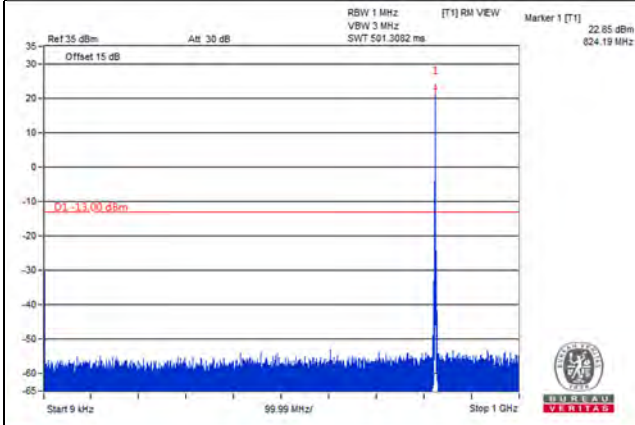

Frequency Range : 1GHz~9GHz

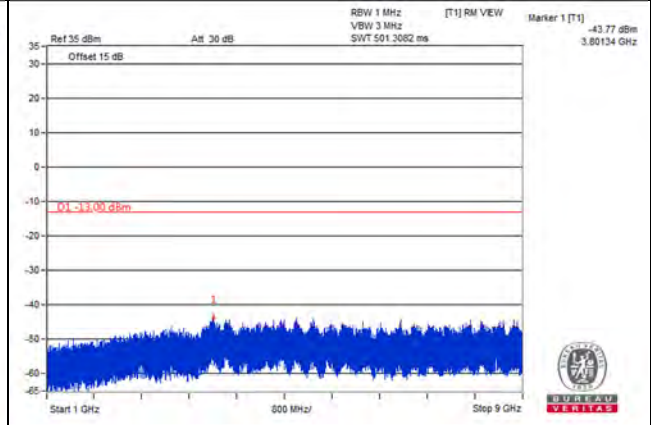

Channel 20525 (836.5MHz)

Frequency Range : 9kHz~1GHz

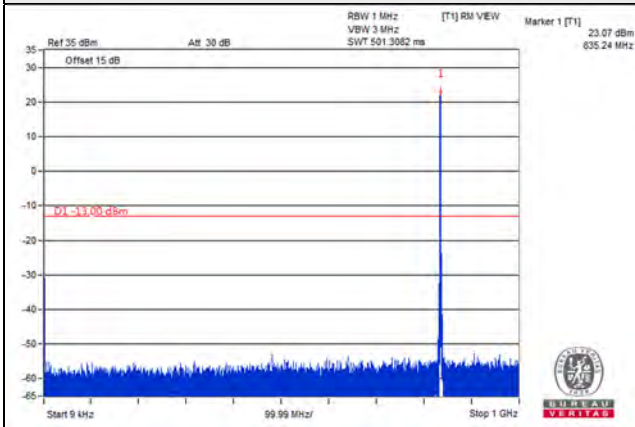

Frequency Range : 1GHz~9GHz

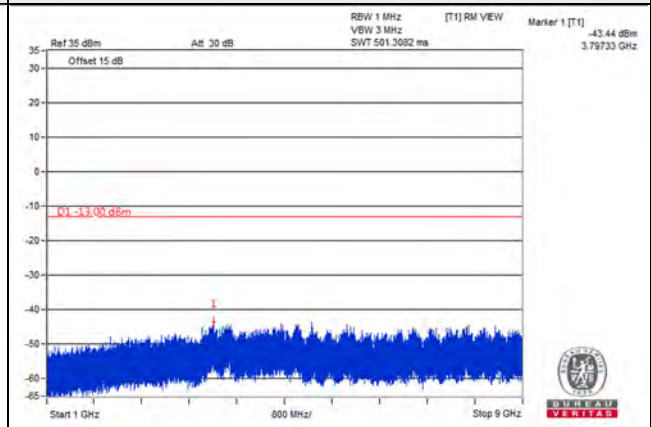

Channel 20635 (847.5MHz)

Frequency Range : 9kHz~1GHz

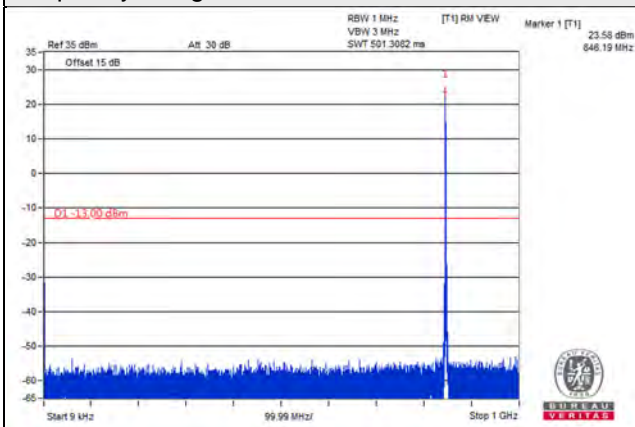

Frequency Range : 1GHz~9GHz

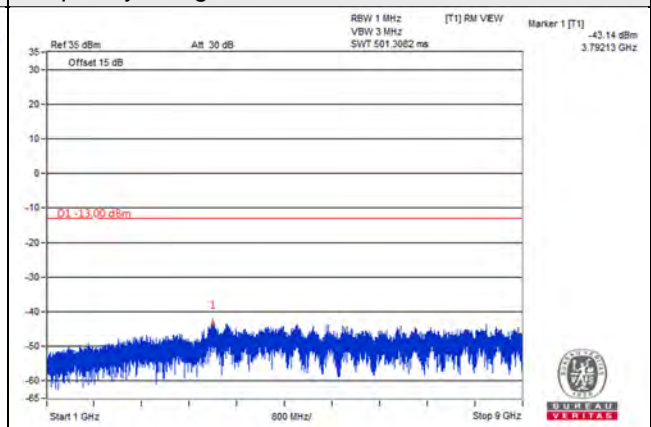

*The 9kHz signal over the limit is from Spectrum.

LTE Band 5, Channel Bandwidth 5MHz

Channel 20425 (826.5MHz)

Frequency Range : 9kHz~1GHz

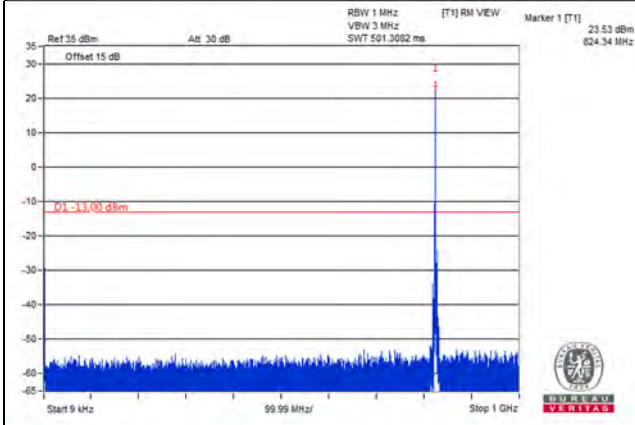

Frequency Range : 1GHz~9GHz

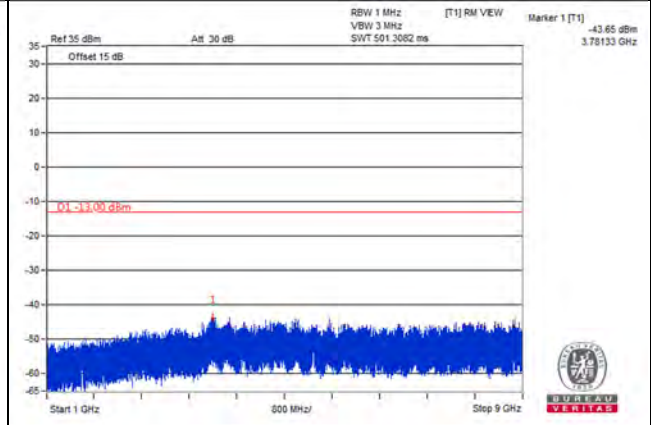

Channel 20525 (836.5MHz)

Frequency Range : 9kHz~1GHz

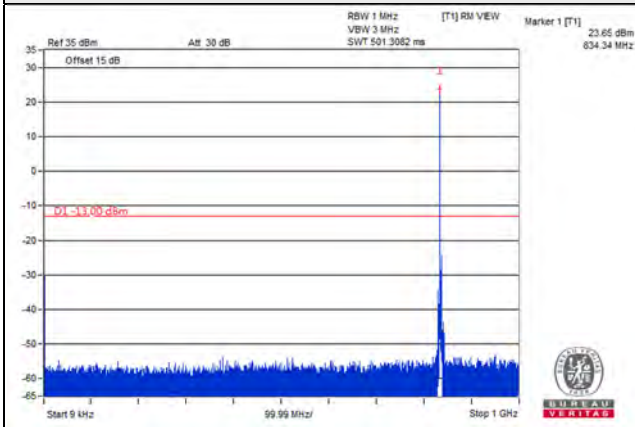

Frequency Range : 1GHz~9GHz

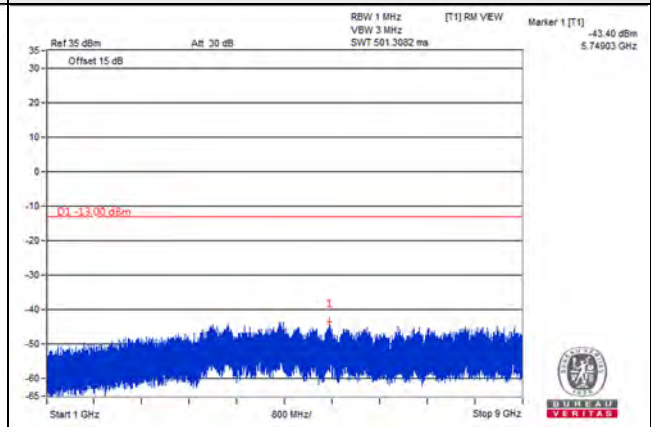

Channel 20625 (846.5MHz)

Frequency Range : 9kHz~1GHz

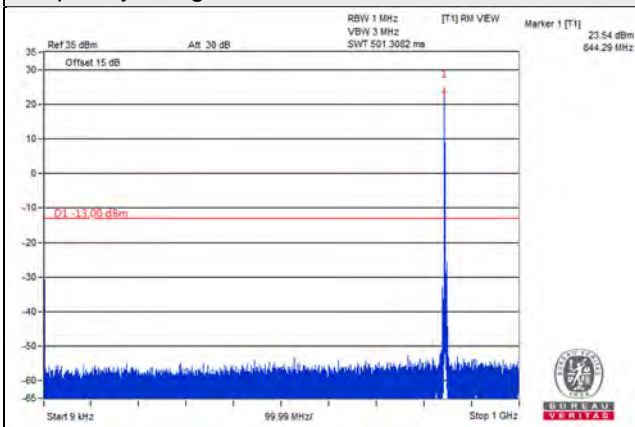

Frequency Range : 1GHz~9GHz

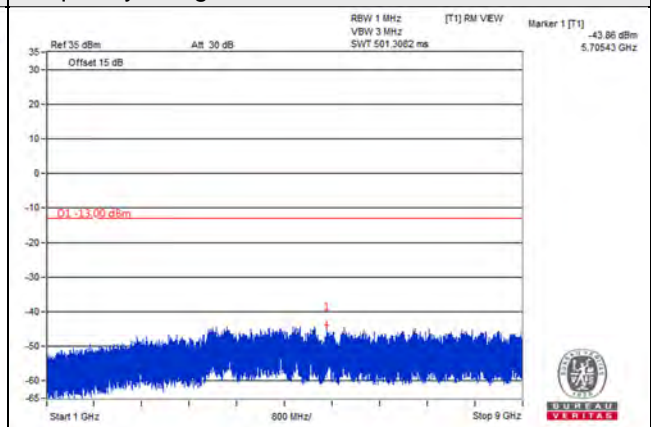

*The 9kHz signal over the limit is from Spectrum.

LTE Band 5, Channel Bandwidth 10MHz

Channel 20450 (829.0MHz)

Frequency Range : 9kHz~1GHz

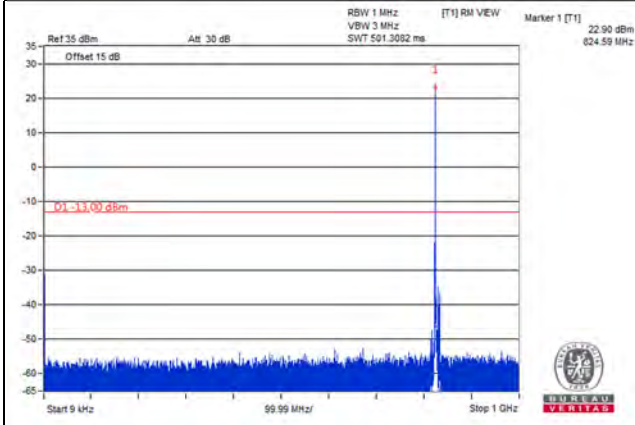

Frequency Range : 1GHz~9GHz

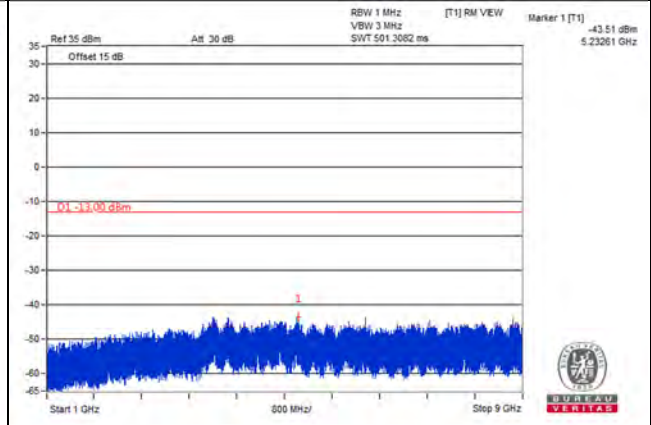

Channel 20525 (836.5MHz)

Frequency Range : 9kHz~1GHz

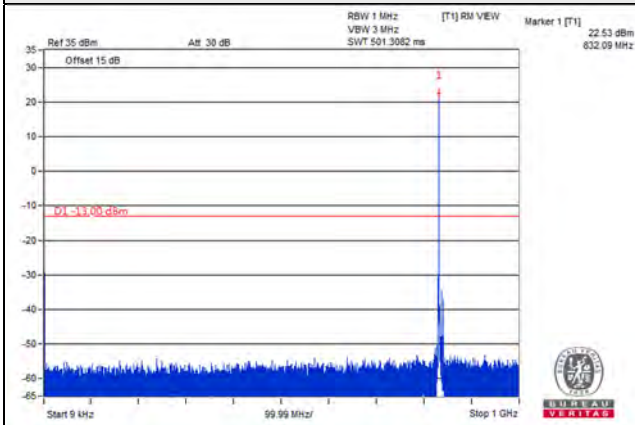

Frequency Range : 1GHz~9GHz

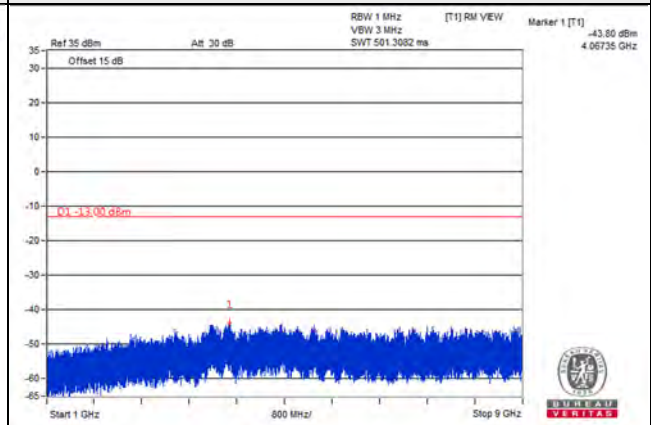

Channel 20600 (844.0MHz)

Frequency Range : 9kHz~1GHz

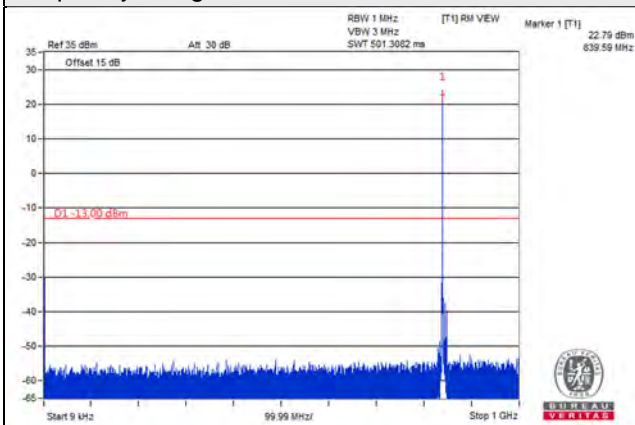

Frequency Range : 1GHz~9GHz

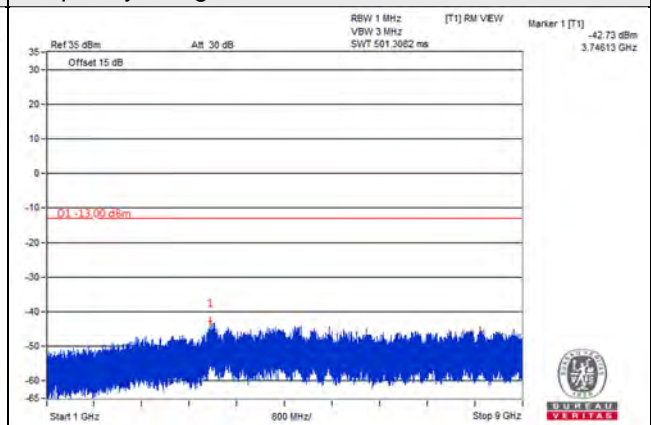

*The 9kHz signal over the limit is from Spectrum.

LTE Band 26, Channel Bandwidth 1.4MHz

Channel 26797 (824.7MHz)

Frequency Range : 9kHz~1GHz

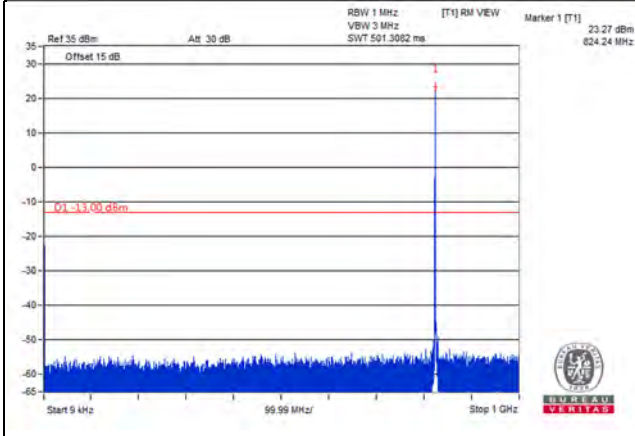

Frequency Range : 1GHz~9GHz

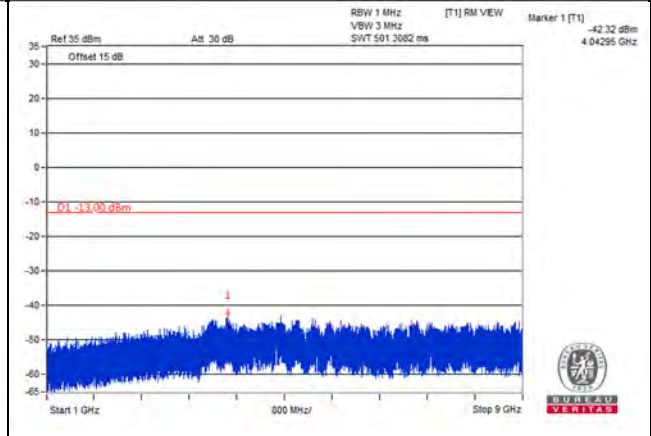

Channel 26915 (836.5MHz)

Frequency Range : 9kHz~1GHz

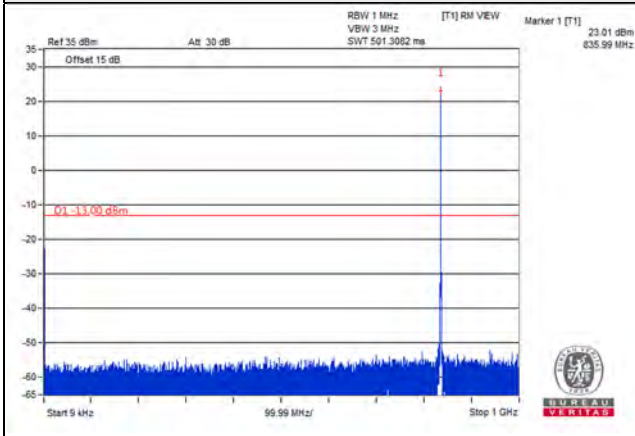

Frequency Range : 1GHz~9GHz

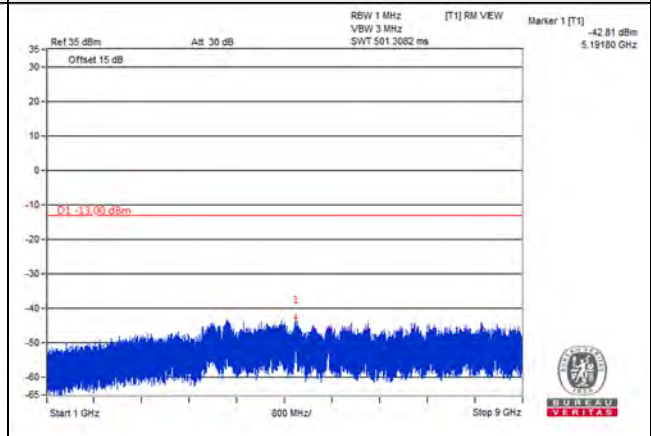

Channel 27033 (848.3MHz)

Frequency Range : 9kHz~1GHz

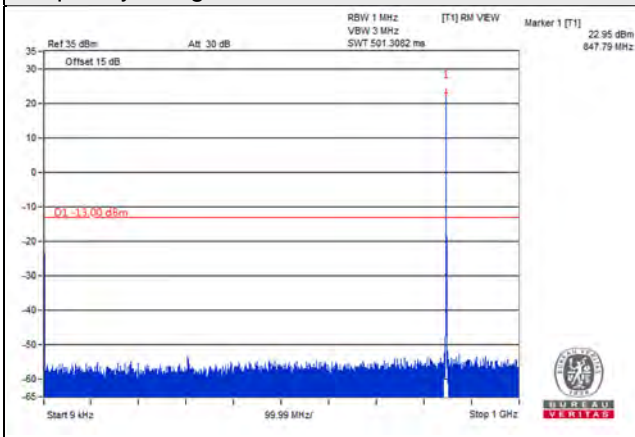

Frequency Range : 1GHz~9GHz

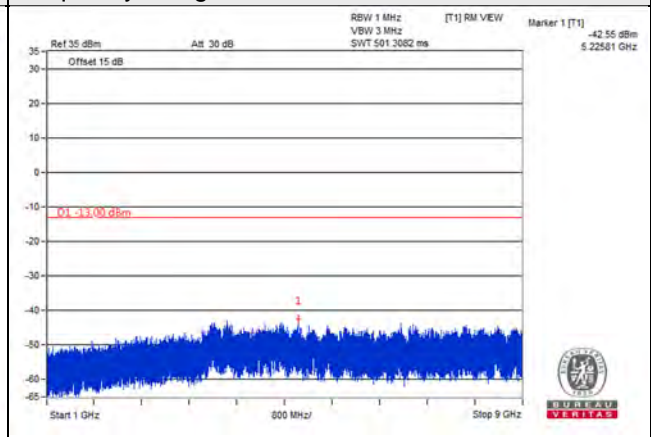

LTE Band 26, Channel Bandwidth 3MHz

Channel 26805 (825.5MHz)

Frequency Range : 9kHz~1GHz

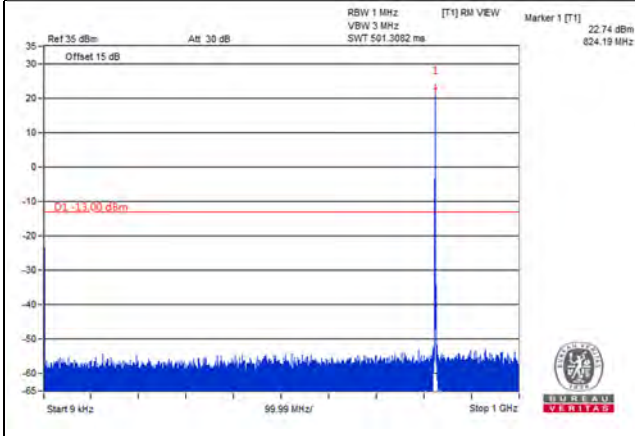

Frequency Range : 1GHz~9GHz

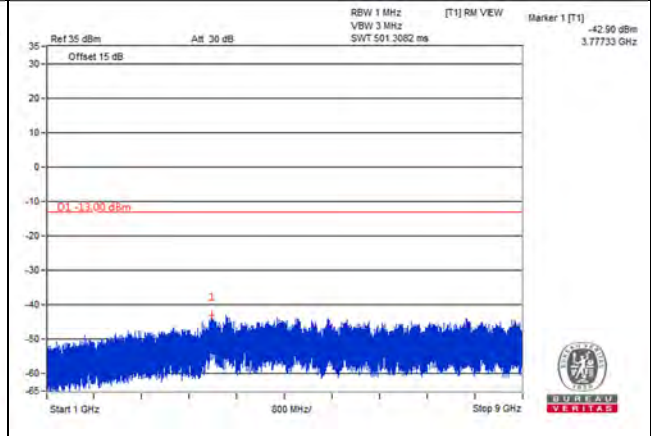

Channel 26915 (836.5MHz)

Frequency Range : 9kHz~1GHz

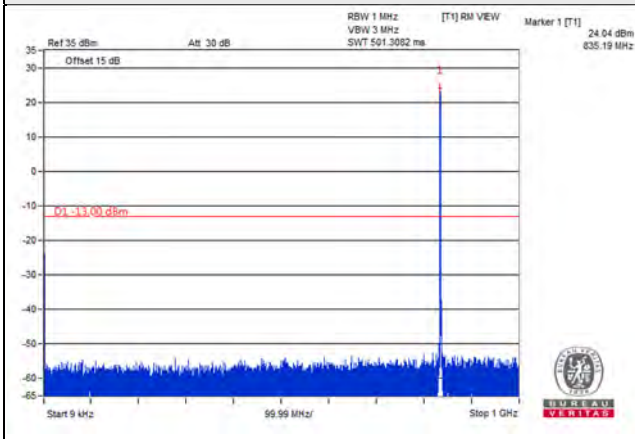

Frequency Range : 1GHz~9GHz

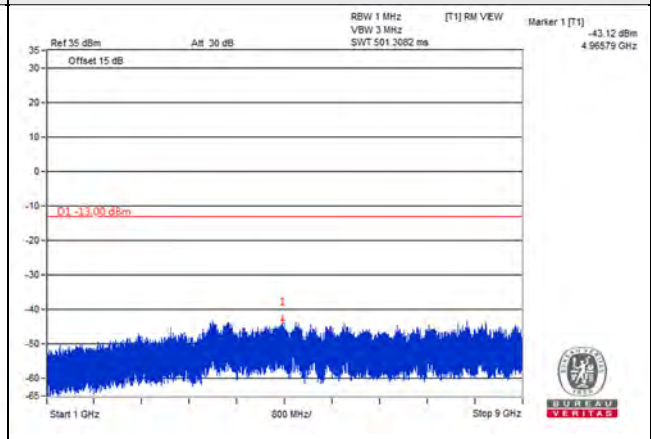

Channel 27025 (847.5MHz)

Frequency Range : 9kHz~1GHz

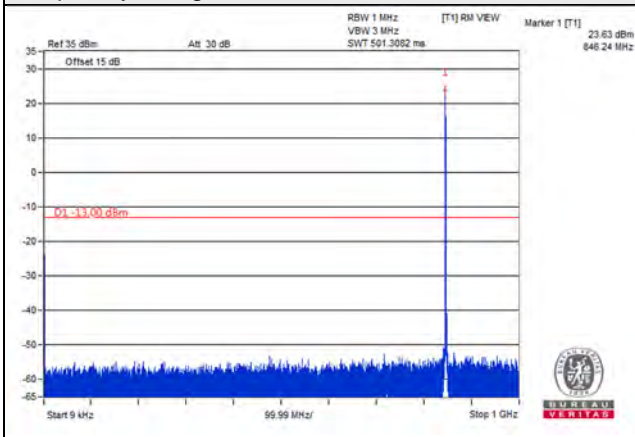

Frequency Range : 1GHz~9GHz

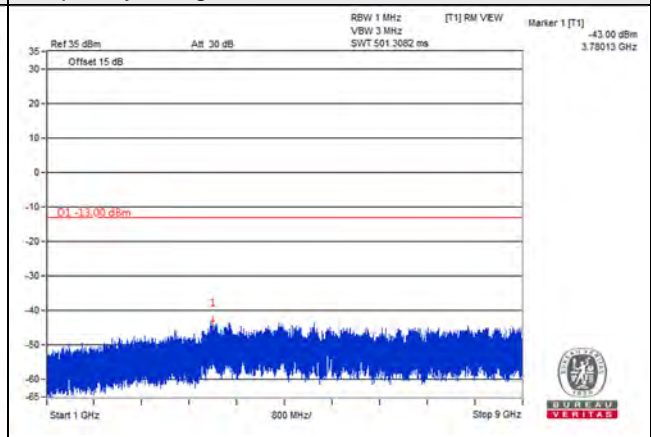

LTE Band 26, Channel Bandwidth 5MHz

Channel 26815 (826.5MHz)

Frequency Range : 9kHz~1GHz

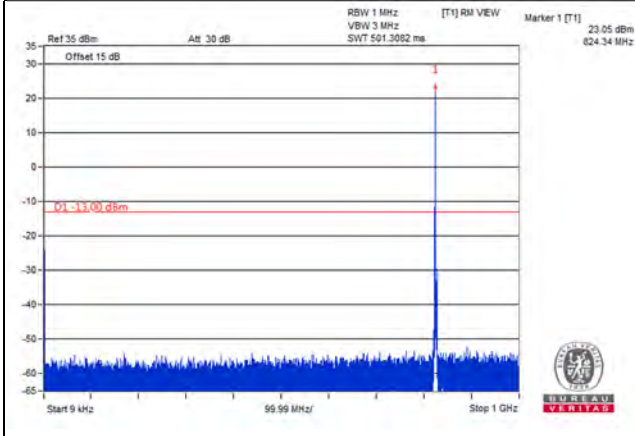

Frequency Range : 1GHz~9GHz

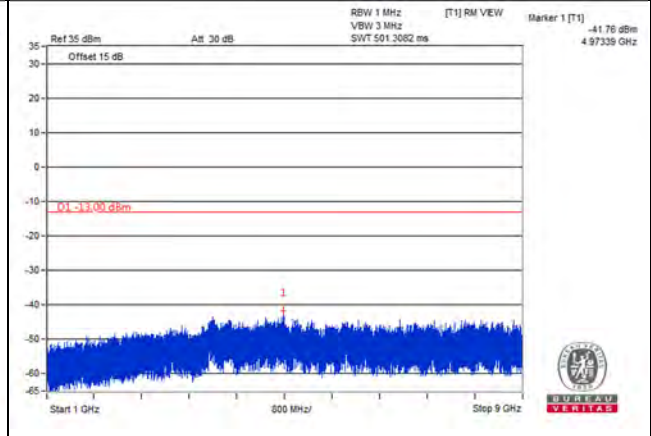

Channel 26915 (836.5MHz)

Frequency Range : 9kHz~1GHz

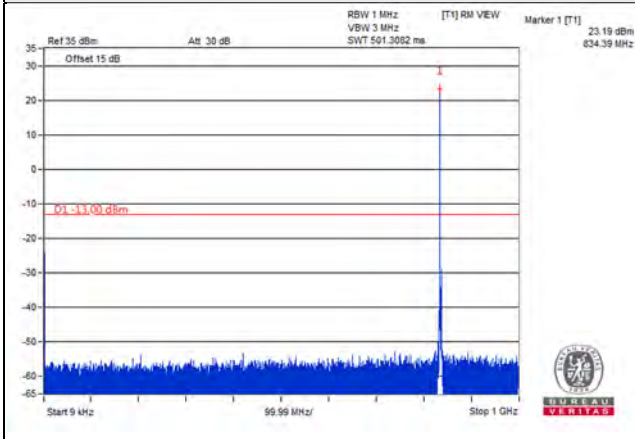

Frequency Range : 1GHz~9GHz

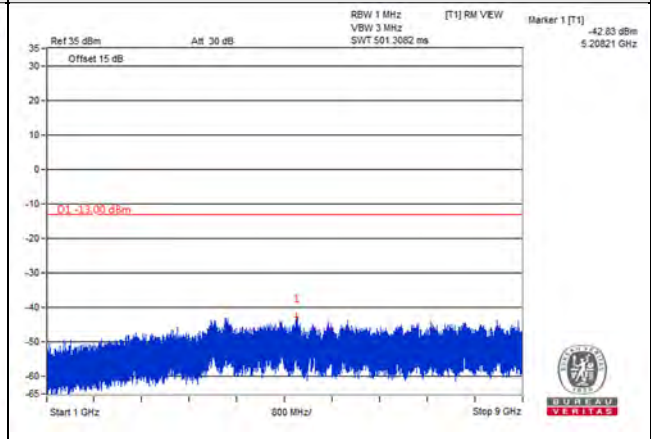

Channel 27015 (846.5MHz)

Frequency Range : 9kHz~1GHz

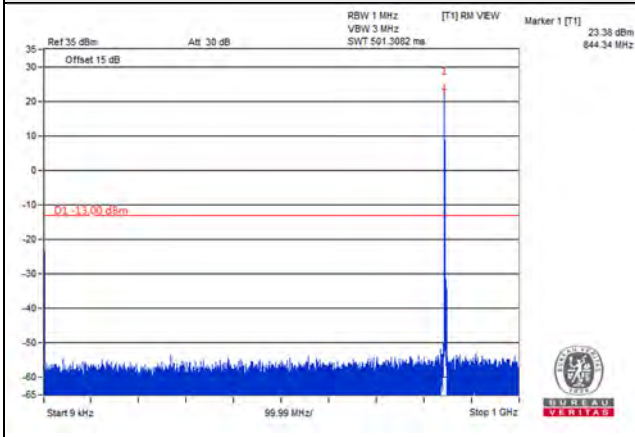

Frequency Range : 1GHz~9GHz

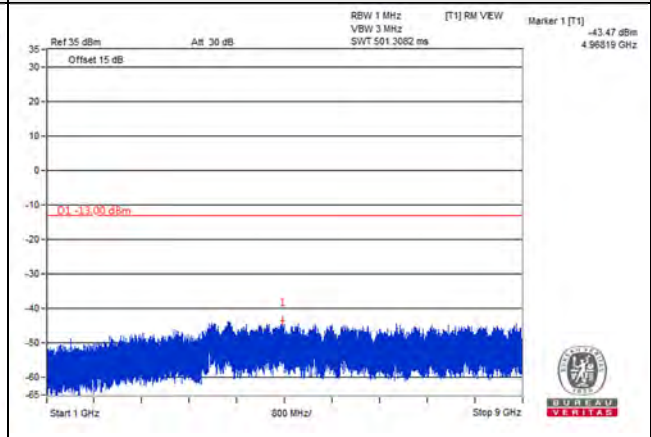

*The 9kHz signal over the limit is from Spectrum.

LTE Band 26, Channel Bandwidth 10MHz

Channel 26840 (829MHz)

Frequency Range : 9kHz~1GHz

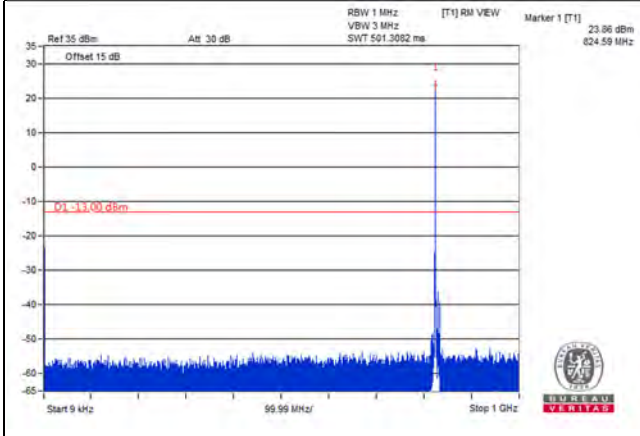

Frequency Range : 1GHz~9GHz

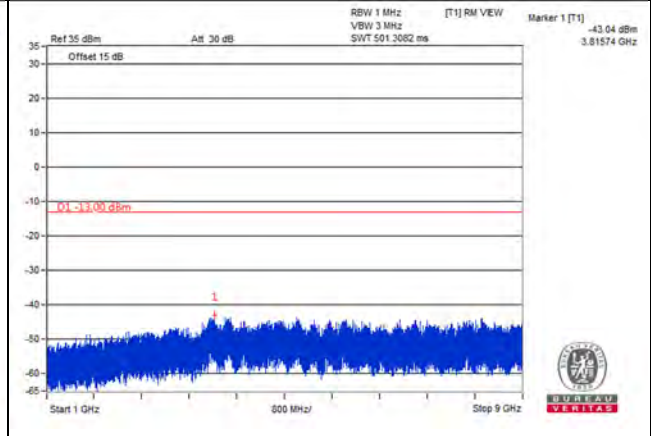

Channel 26915 (836.5MHz)

Frequency Range : 9kHz~1GHz

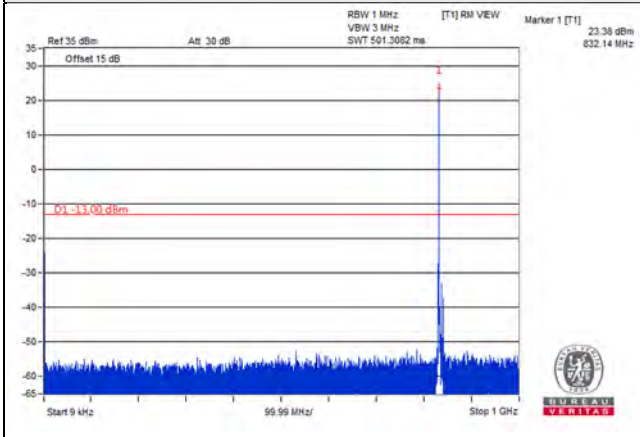

Frequency Range : 1GHz~9GHz

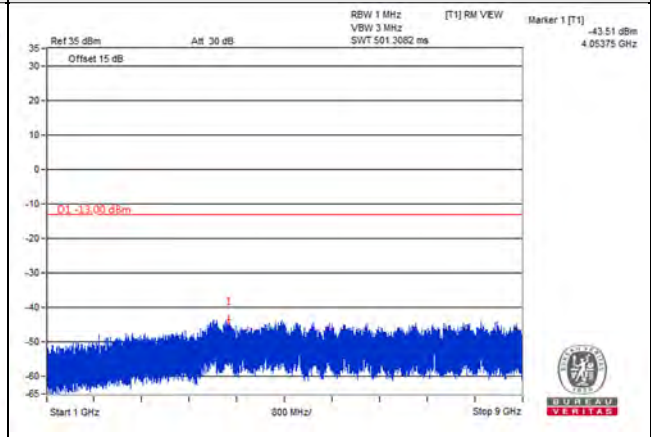

Channel 26990 (844MHz)

Frequency Range : 9kHz~1GHz

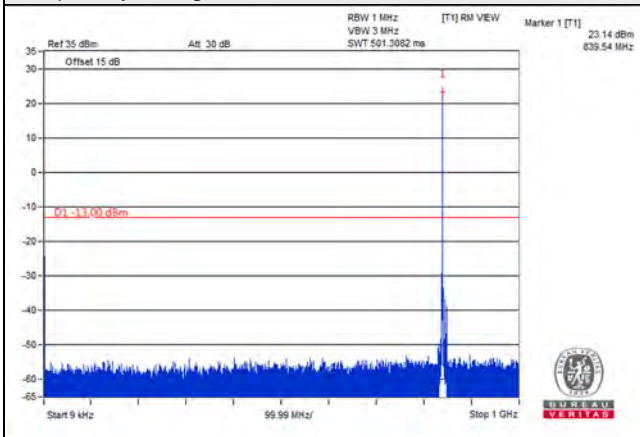

Frequency Range : 1GHz~9GHz

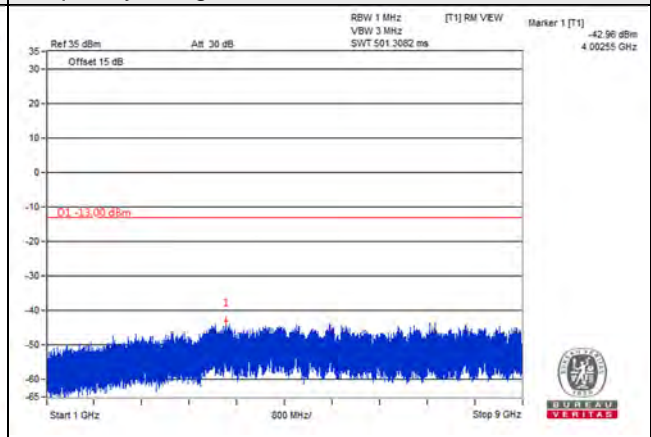

LTE Band 26, Channel Bandwidth 15MHz

Channel 26865 (831.5MHz)

Frequency Range : 9kHz~1GHz

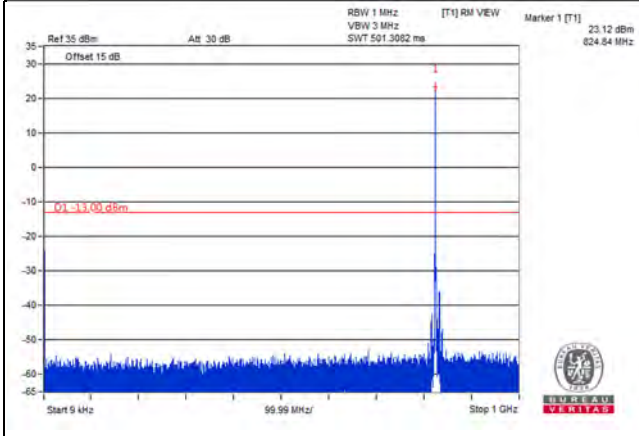

Frequency Range : 1GHz~9GHz

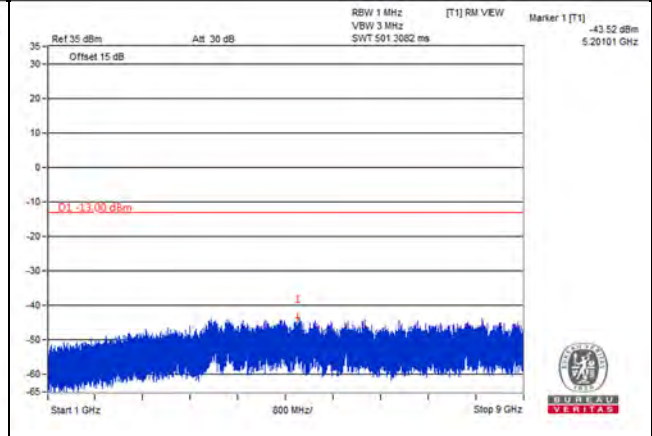

Channel 26915 (836.5MHz)

Frequency Range : 9kHz~1GHz

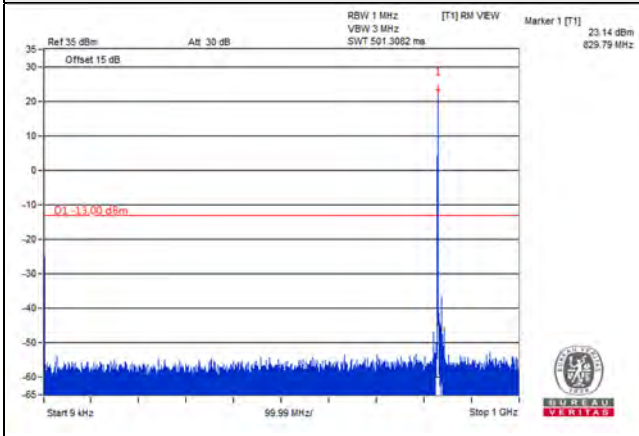

Frequency Range : 1GHz~9GHz

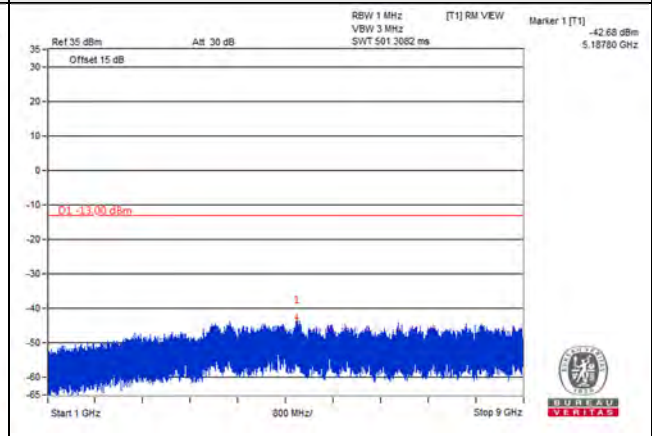

Channel 26965 (841.5MHz)

Frequency Range : 9kHz~1GHz

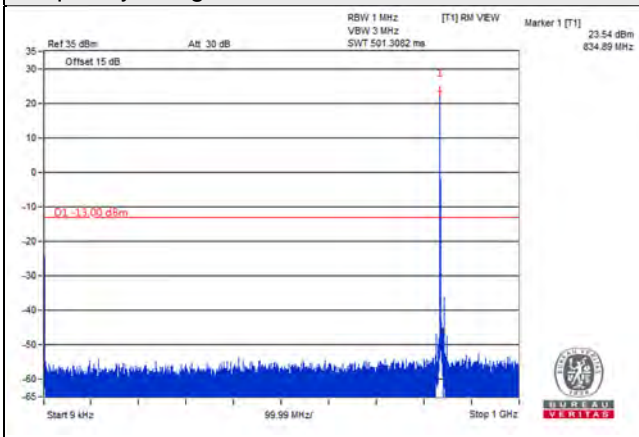

Frequency Range : 1GHz~9GHz

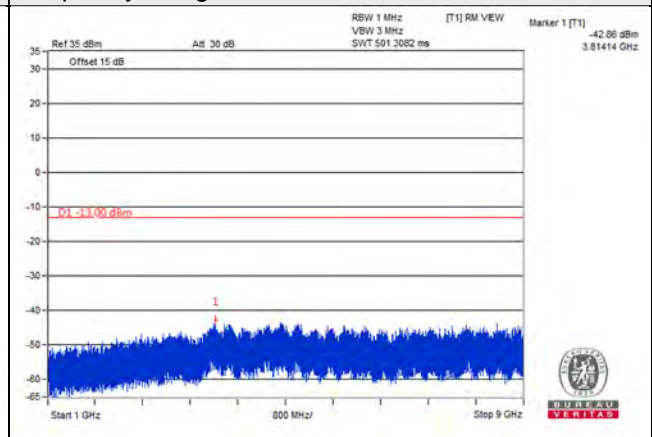

4.8 Radiated Emission Measurement

4.8.1 Limits of Radiated Emission Measurement

The power of any emission outside of the authorized operating frequency ranges must be attenuated below the transmitting power (P) by a factor of at least $43 + 10 \log(P)$ dB. The emission limit equal to -13dBm .

4.8.2 Test Procedure

- a. Substitution method is used for E.I.R.P measurement. In the semi-anechoic chamber, EUT placed on the 0.8m (below or equal 1 GHz) and/or 1.5 m (above 1 GHz) height of Turn Table, rotated the table around 360 degrees to search the maximum radiation power and receiver antenna shall be rotated vertical and horizontal polarization and moved height from 1m to 4m to find the maximum polar radiated power. The "Read Value" is the spectrum reading the maximum power value.
- b. The substitution horn antenna is substituted for EUT at the same position and signals generator export the CW signal to the substitution antenna via a TX cable. Rotated the Turn Table and moved receiving antenna to find the maximum radiation power. Adjust output power level of S.G to get a Value of spectrum reading equal to "Read Value" of step a. Record the power level of S.G
- c. $\text{EIRP} = \text{Output power level of S.G} - \text{TX cable loss} + \text{Antenna gain of substitution horn.}$
- d. E.R.P power can be calculated form E.I.R.P power by subtracting the gain of dipole, $\text{E.R.P power} = \text{E.I.R.P power} - 2.15\text{dBi.}$

NOTE: The resolution bandwidth and video bandwidth of test receiver/spectrum analyzer is 1MHz/3MHz.

4.8.3 Deviation from Test Standard

No deviation.

4.8.4 Test Setup

For radiated emission 30MHz to 1GHz

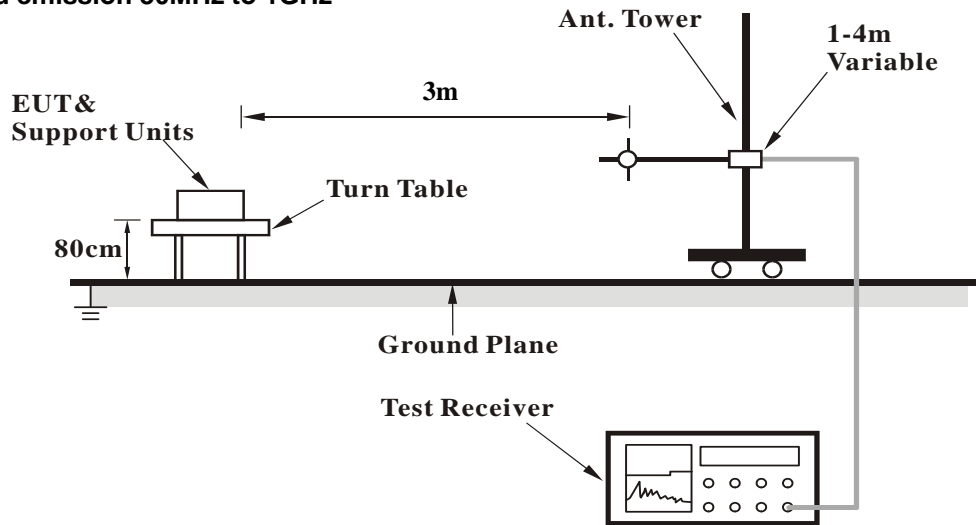

For radiated emission above 1GHz

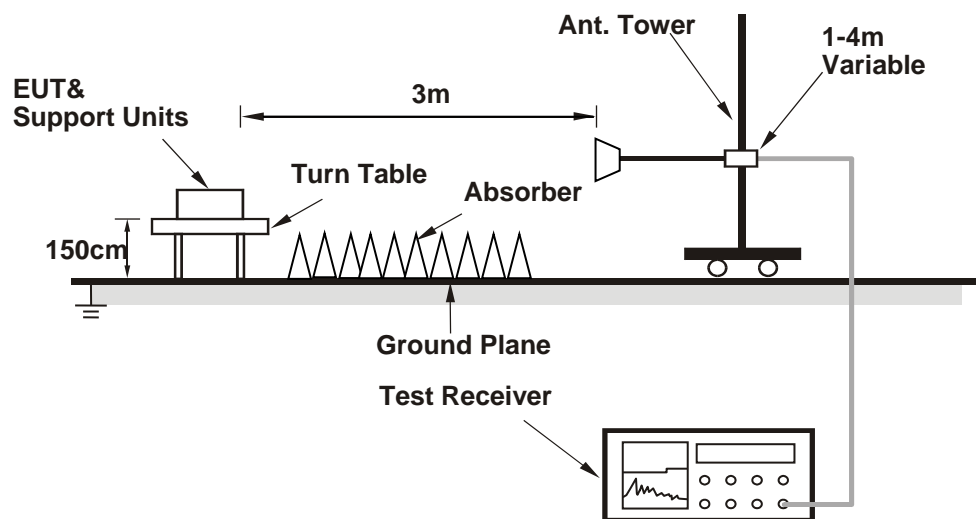

For the actual test configuration, please refer to the attached file (Test Setup Photo).

4.8.5 Test Results

Below 1GHz
WCDMA Band 5

Mode	TX channel 4233 (846.6MHz)	Frequency Range	Below 1000 MHz
Environmental Conditions	22deg. C, 66%RH	Input Power	120Vac, 60Hz
Tested By	Greg Lin		

Antenna Polarity & Test Distance: Horizontal at 3 M							
No.	Freq. (MHz)	Reading (dBm)	S.G Power Value (dBm)	Correction Factor (dB)	ERP (dBm)	Limit (dBm)	Margin (dB)
1	30.97	-50.2	-29.9	-18.8	-48.7	-13.0	-35.7
2	79.47	-41.5	-49.2	0.6	-48.6	-13.0	-35.6
3	203.63	-50.5	-58.5	-2.1	-60.6	-13.0	-47.6
4	256.98	-50.9	-56.8	-1.5	-58.3	-13.0	-45.3
5	297.72	-52.6	-55.8	-1.7	-57.5	-13.0	-44.5
6	773.02	-55.9	-57.2	4.0	-53.2	-13.0	-40.2

Remarks:

- ERP (dBm) = S.G Value (dBm) + Correction Factor (dB).
- Correction Factor (dB) = Substitution Antenna Gain (dB) - Cable Loss (dB) + 2.15dB.

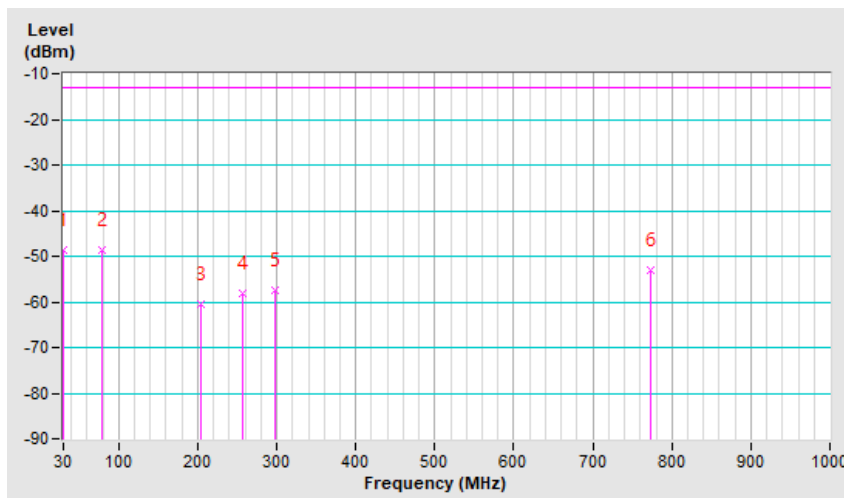

Mode	TX channel 4233 (846.6MHz)	Frequency Range	Below 1000 MHz
Environmental Conditions	22deg. C, 66%RH	Input Power	120Vac, 60Hz
Tested By	Greg Lin		

Antenna Polarity & Test Distance: Vertical at 3 M							
No.	Freq. (MHz)	Reading (dBm)	S.G Power Value (dBm)	Correction Factor (dB)	ERP (dBm)	Limit (dBm)	Margin (dB)
1	31.94	-43.2	-37.6	-18.3	-55.9	-13.0	-42.9
2	86.26	-48.8	-57.0	0.1	-56.9	-13.0	-43.9
3	205.57	-54.9	-57.3	-2.0	-59.3	-13.0	-46.3
4	259.89	-55.8	-55.5	-1.5	-57.0	-13.0	-44.0
5	599.39	-60.4	-62.7	3.8	-58.9	-13.0	-45.9
6	742.95	-56.6	-55.5	3.6	-51.9	-13.0	-38.9

Remarks:

1. ERP (dBm) = S.G Value (dBm) + Correction Factor (dB).
2. Correction Factor (dB) = Substitution Antenna Gain (dB) - Cable Loss (dB) + 2.15dB.

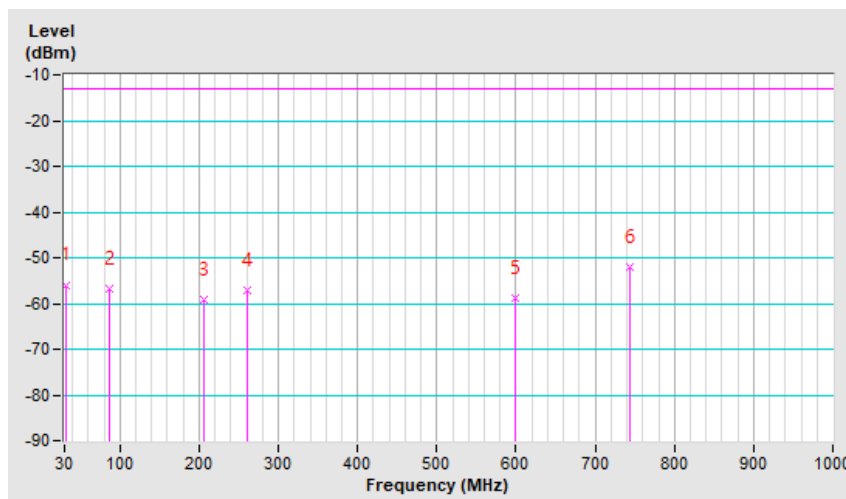

LTE Band 5, Channel Bandwidth: 10MHz

Mode	TX channel 20525 (836.5MHz)	Frequency Range	Below 1000 MHz
Environmental Conditions	22deg. C, 66%RH	Input Power	120Vac, 60Hz
Tested By	Greg Lin		

Antenna Polarity & Test Distance: Horizontal at 3 M							
No.	Freq. (MHz)	Reading (dBm)	S.G Power Value (dBm)	Correction Factor (dB)	ERP (dBm)	Limit (dBm)	Margin (dB)
1	44.55	-38.6	-28.6	-10.9	-39.5	-13.0	-26.5
2	97.90	-47.1	-56.6	-1.4	-58.0	-13.0	-45.0
3	211.39	-51.9	-60.4	-2.1	-62.5	-13.0	-49.5
4	273.47	-48.0	-52.9	-1.6	-54.5	-13.0	-41.5
5	732.28	-66.4	-68.2	3.6	-64.6	-13.0	-51.6
6	893.30	-57.1	-55.5	3.5	-52.0	-13.0	-39.0

Remarks:

- ERP (dBm) = S.G Value (dBm) + Correction Factor (dB).
- Correction Factor (dB) = Substitution Antenna Gain (dB) - Cable Loss (dB) + 2.15dB.

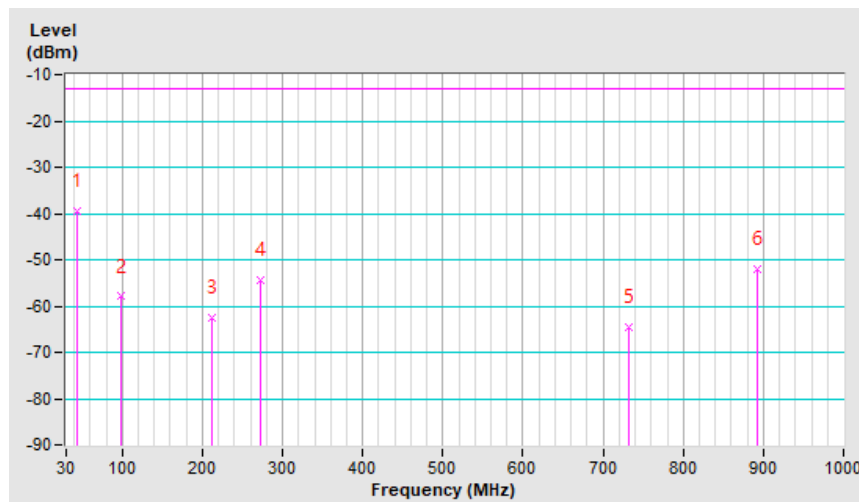

Mode	TX channel 20525 (836.5MHz)	Frequency Range	Below 1000 MHz
Environmental Conditions	22deg. C, 66%RH	Input Power	120Vac, 60Hz
Tested By	Greg Lin		

Antenna Polarity & Test Distance: Vertical at 3 M							
No.	Freq. (MHz)	Reading (dBm)	S.G Power Value (dBm)	Correction Factor (dB)	ERP (dBm)	Limit (dBm)	Margin (dB)
1	53.28	-38.5	-41.4	-6.2	-47.6	-13.0	-34.6
2	87.23	-49.9	-58.1	-0.1	-58.2	-13.0	-45.2
3	200.72	-61.9	-63.0	-2.3	-65.3	-13.0	-52.3
4	253.10	-60.6	-61.2	-1.4	-62.6	-13.0	-49.6
5	729.37	-65.8	-65.1	3.6	-61.5	-13.0	-48.5
6	893.30	-55.9	-53.2	3.5	-49.7	-13.0	-36.7

Remarks:

- ERP (dBm) = S.G Value (dBm) + Correction Factor (dB).
- Correction Factor (dB) = Substitution Antenna Gain (dB) - Cable Loss (dB) + 2.15dB.

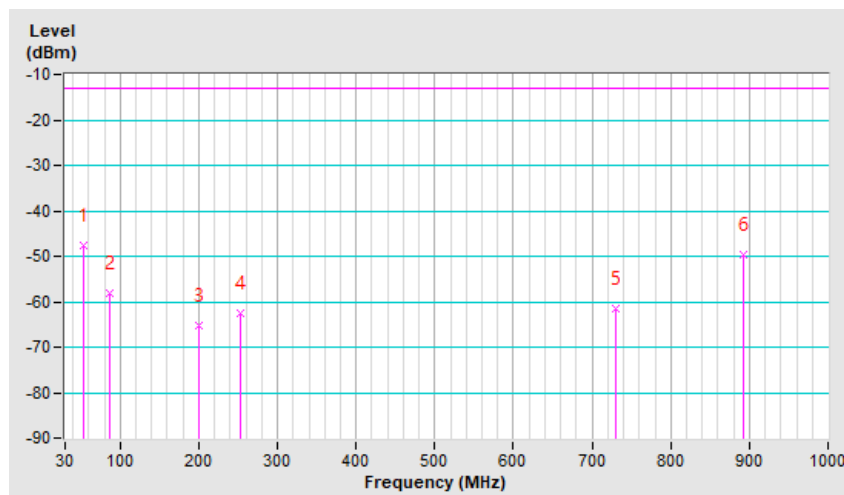

LTE Band 26, Channel Bandwidth 1.4MHz

Mode	TX channel 26797 (824.7MHz)	Frequency Range	Below 1000 MHz
Environmental Conditions	22deg. C, 66%RH	Input Power	120Vac, 60Hz
Tested By	Greg Lin		

Antenna Polarity & Test Distance: Horizontal at 3 M							
No.	Freq. (MHz)	Reading (dBm)	S.G Power Value (dBm)	Correction Factor (dB)	ERP (dBm)	Limit (dBm)	Margin (dB)
1	89.17	-39.0	-48.9	-0.1	-49.0	-13.0	-36.0
2	193.93	-45.0	-53.0	-2.6	-55.6	-13.0	-42.6
3	245.34	-44.6	-52.2	-1.6	-53.8	-13.0	-40.8
4	555.74	-59.9	-65.2	3.7	-61.5	-13.0	-48.5
5	652.74	-57.3	-60.9	3.6	-57.3	-13.0	-44.3
6	891.36	-54.9	-53.3	3.5	-49.8	-13.0	-36.8

Remarks:

- ERP (dBm) = S.G Value (dBm) + Correction Factor (dB).
- Correction Factor (dB) = Substitution Antenna Gain (dB) - Cable Loss (dB) + 2.15dB.

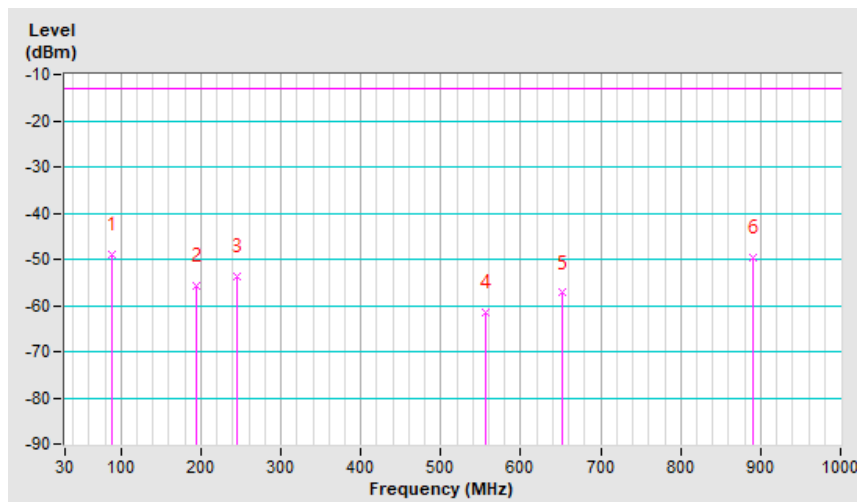

Mode	TX channel 26797 (824.7MHz)	Frequency Range	Below 1000 MHz
Environmental Conditions	22deg. C, 66%RH	Input Power	120Vac, 60Hz
Tested By	Greg Lin		

Antenna Polarity & Test Distance: Vertical at 3 M							
No.	Freq. (MHz)	Reading (dBm)	S.G Power Value (dBm)	Correction Factor (dB)	ERP (dBm)	Limit (dBm)	Margin (dB)
1	30.00	-46.8	-39.4	-19.4	-58.8	-13.0	-45.8
2	82.38	-56.5	-63.5	0.4	-63.1	-13.0	-50.1
3	273.47	-62.6	-60.5	-1.6	-62.1	-13.0	-49.1
4	599.39	-60.8	-63.1	3.8	-59.3	-13.0	-46.3
5	737.13	-59.5	-58.7	3.7	-55.0	-13.0	-42.0
6	894.27	-57.9	-55.2	3.5	-51.7	-13.0	-38.7

Remarks:

- ERP (dBm) = S.G Value (dBm) + Correction Factor (dB).
- Correction Factor (dB) = Substitution Antenna Gain (dB) - Cable Loss (dB) + 2.15dB.

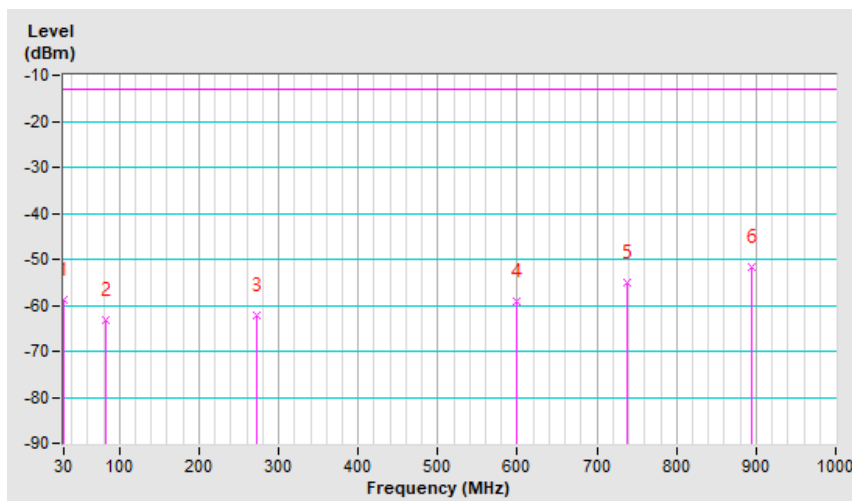

Above 1GHz
WCDMA Band 5

Mode	TX channel 4132 (826.4MHz)	Frequency Range	1GHz ~ 10GHz
Environmental Conditions	25deg. C, 70%RH	Input Power	120Vac, 60Hz
Tested By	Luis Lee		

Antenna Polarity & Test Distance: Horizontal at 3 M							
No.	Freq. (MHz)	Reading (dBm)	S.G Power Value (dBm)	Correction Factor (dB)	ERP (dBm)	Limit (dBm)	Margin (dB)
1	1652.80	-55.4	-58.6	5.5	-53.1	-13.0	-40.1
Antenna Polarity & Test Distance: Vertical at 3 M							
No.	Freq. (MHz)	Reading (dBm)	S.G Power Value (dBm)	Correction Factor (dB)	ERP (dBm)	Limit (dBm)	Margin (dB)
1	1652.80	-62.2	-63.2	5.5	-57.7	-13.0	-44.7

Remarks:

1. ERP (dBm) = S.G Value (dBm) + Correction Factor (dB).
2. Correction Factor (dB) = Substitution Antenna Gain (dB) - Cable Loss (dB) + 2.15dB.

Mode	TX channel 4182 (836.4MHz)	Frequency Range	1GHz ~ 10GHz
Environmental Conditions	25deg. C, 70%RH	Input Power	120Vac, 60Hz
Tested By	Luis Lee		

Antenna Polarity & Test Distance: Horizontal at 3 M							
No.	Freq. (MHz)	Reading (dBm)	S.G Power Value (dBm)	Correction Factor (dB)	ERP (dBm)	Limit (dBm)	Margin (dB)
1	1672.80	-55.6	-58.6	5.5	-53.1	-13.0	-40.1
Antenna Polarity & Test Distance: Vertical at 3 M							
No.	Freq. (MHz)	Reading (dBm)	S.G Power Value (dBm)	Correction Factor (dB)	ERP (dBm)	Limit (dBm)	Margin (dB)
1	1672.80	-62.2	-63.0	5.5	-57.5	-13.0	-44.5

Remarks:

1. ERP (dBm) = S.G Value (dBm) + Correction Factor (dB).
2. Correction Factor (dB) = Substitution Antenna Gain (dB) - Cable Loss (dB) + 2.15dB.

Mode	TX channel 4233 (846.6MHz)	Frequency Range	1GHz ~ 10GHz
Environmental Conditions	25deg. C, 70%RH	Input Power	120Vac, 60Hz
Tested By	Luis Lee		

Antenna Polarity & Test Distance: Horizontal at 3 M							
No.	Freq. (MHz)	Reading (dBm)	S.G Power Value (dBm)	Correction Factor (dB)	ERP (dBm)	Limit (dBm)	Margin (dB)
1	1693.20	-54.8	-57.6	5.6	-52.0	-13.0	-39.0
Antenna Polarity & Test Distance: Vertical at 3 M							
No.	Freq. (MHz)	Reading (dBm)	S.G Power Value (dBm)	Correction Factor (dB)	ERP (dBm)	Limit (dBm)	Margin (dB)
1	1693.20	-62.0	-62.6	5.6	-57.0	-13.0	-44.0

Remarks:

1. $ERP (dBm) = S.G \text{ Value (dBm)} + \text{Correction Factor (dB)}$.
2. $\text{Correction Factor (dB)} = \text{Substitution Antenna Gain (dB)} - \text{Cable Loss (dB)} + 2.15dB$.

LTE Band 5, Channel Bandwidth: 1.4MHz

Mode	TX channel 20407 (824.7MHz)	Frequency Range	1GHz ~ 10GHz
Environmental Conditions	22deg. C, 68%RH	Input Power	120Vac, 60Hz
Tested By	Greg Lin		

Antenna Polarity & Test Distance: Horizontal at 3 M

No.	Freq. (MHz)	Reading (dBm)	S.G Power Value (dBm)	Correction Factor (dB)	ERP (dBm)	Limit (dBm)	Margin (dB)
1	1649.40	-63.9	-56.2	0.9	-55.3	-13.0	-42.3

Antenna Polarity & Test Distance: Vertical at 3 M

No.	Freq. (MHz)	Reading (dBm)	S.G Power Value (dBm)	Correction Factor (dB)	ERP (dBm)	Limit (dBm)	Margin (dB)
1	1649.40	-62.1	-54.9	0.9	-54.0	-13.0	-41.0

Remarks:

1. ERP (dBm) = S.G Value (dBm) + Correction Factor (dB).
2. Correction Factor (dB) = Substitution Antenna Gain (dB) - Cable Loss (dB) + 2.15dB.

Mode	TX channel 20525 (836.5MHz)	Frequency Range	1GHz ~ 10GHz
Environmental Conditions	22deg. C, 68%RH	Input Power	120Vac, 60Hz
Tested By	Greg Lin		

Antenna Polarity & Test Distance: Horizontal at 3 M

No.	Freq. (MHz)	Reading (dBm)	S.G Power Value (dBm)	Correction Factor (dB)	ERP (dBm)	Limit (dBm)	Margin (dB)
1	1673.00	-64.2	-56.6	0.8	-55.8	-13.0	-42.8

Antenna Polarity & Test Distance: Vertical at 3 M

No.	Freq. (MHz)	Reading (dBm)	S.G Power Value (dBm)	Correction Factor (dB)	ERP (dBm)	Limit (dBm)	Margin (dB)
1	1673.00	-61.9	-54.6	0.8	-53.8	-13.0	-40.8

Remarks:

1. ERP (dBm) = S.G Value (dBm) + Correction Factor (dB).
2. Correction Factor (dB) = Substitution Antenna Gain (dB) - Cable Loss (dB) + 2.15dB.

Mode	TX channel 20643 (848.3MHz)	Frequency Range	1GHz ~ 10GHz
Environmental Conditions	22deg. C, 68%RH	Input Power	120Vac, 60Hz
Tested By	Greg Lin		

Antenna Polarity & Test Distance: Horizontal at 3 M							
No.	Freq. (MHz)	Reading (dBm)	S.G Power Value (dBm)	Correction Factor (dB)	ERP (dBm)	Limit (dBm)	Margin (dB)
1	1696.60	-63.4	-55.8	0.7	-55.1	-13.0	-42.1
Antenna Polarity & Test Distance: Vertical at 3 M							
No.	Freq. (MHz)	Reading (dBm)	S.G Power Value (dBm)	Correction Factor (dB)	ERP (dBm)	Limit (dBm)	Margin (dB)
1	1696.60	-62.0	-54.7	0.7	-54.0	-13.0	-41.0

Remarks:

1. ERP (dBm) = S.G Value (dBm) + Correction Factor (dB).
2. Correction Factor (dB) = Substitution Antenna Gain (dB) - Cable Loss (dB) + 2.15dB.

LTE Band 5, Channel Bandwidth: 5MHz

Mode	TX channel 20425 (826.5MHz)	Frequency Range	1GHz ~ 10GHz
Environmental Conditions	22deg. C, 68%RH	Input Power	120Vac, 60Hz
Tested By	Greg Lin		

Antenna Polarity & Test Distance: Horizontal at 3 M

No.	Freq. (MHz)	Reading (dBm)	S.G Power Value (dBm)	Correction Factor (dB)	ERP (dBm)	Limit (dBm)	Margin (dB)
1	1653.00	-63.6	-55.9	0.9	-55.0	-13.0	-42.0

Antenna Polarity & Test Distance: Vertical at 3 M

No.	Freq. (MHz)	Reading (dBm)	S.G Power Value (dBm)	Correction Factor (dB)	ERP (dBm)	Limit (dBm)	Margin (dB)
1	1653.00	-62.0	-54.8	0.9	-53.9	-13.0	-40.9

Remarks:

1. ERP (dBm) = S.G Value (dBm) + Correction Factor (dB).
2. Correction Factor (dB) = Substitution Antenna Gain (dB) - Cable Loss (dB) + 2.15dB.

Mode	TX channel 20525 (836.5MHz)	Frequency Range	1GHz ~ 10GHz
Environmental Conditions	22deg. C, 68%RH	Input Power	120Vac, 60Hz
Tested By	Greg Lin		

Antenna Polarity & Test Distance: Horizontal at 3 M

No.	Freq. (MHz)	Reading (dBm)	S.G Power Value (dBm)	Correction Factor (dB)	ERP (dBm)	Limit (dBm)	Margin (dB)
1	1673.00	-63.7	-56.0	0.8	-55.2	-13.0	-42.2

Antenna Polarity & Test Distance: Vertical at 3 M

No.	Freq. (MHz)	Reading (dBm)	S.G Power Value (dBm)	Correction Factor (dB)	ERP (dBm)	Limit (dBm)	Margin (dB)
1	1673.00	-62.2	-54.9	0.8	-54.1	-13.0	-41.1

Remarks:

1. ERP (dBm) = S.G Value (dBm) + Correction Factor (dB).
2. Correction Factor (dB) = Substitution Antenna Gain (dB) - Cable Loss (dB) + 2.15dB.

Mode	TX channel 20625 (846.5MHz)	Frequency Range	1GHz ~ 10GHz
Environmental Conditions	22deg. C, 68%RH	Input Power	120Vac, 60Hz
Tested By	Greg Lin		

Antenna Polarity & Test Distance: Horizontal at 3 M							
No.	Freq. (MHz)	Reading (dBm)	S.G Power Value (dBm)	Correction Factor (dB)	ERP (dBm)	Limit (dBm)	Margin (dB)
1	1693.00	-63.4	-55.8	0.7	-55.1	-13.0	-42.1
Antenna Polarity & Test Distance: Vertical at 3 M							
No.	Freq. (MHz)	Reading (dBm)	S.G Power Value (dBm)	Correction Factor (dB)	ERP (dBm)	Limit (dBm)	Margin (dB)
1	1693.00	-61.8	-54.5	0.7	-53.8	-13.0	-40.8

Remarks:

1. ERP (dBm) = S.G Value (dBm) + Correction Factor (dB).
2. Correction Factor (dB) = Substitution Antenna Gain (dB) - Cable Loss (dB) + 2.15dB.

LTE Band 5, Channel Bandwidth: 10MHz

Mode	TX channel 20450 (829.0MHz)	Frequency Range	1GHz ~ 10GHz
Environmental Conditions	22deg. C, 68%RH	Input Power	120Vac, 60Hz
Tested By	Greg Lin		

Antenna Polarity & Test Distance: Horizontal at 3 M

No.	Freq. (MHz)	Reading (dBm)	S.G Power Value (dBm)	Correction Factor (dB)	ERP (dBm)	Limit (dBm)	Margin (dB)
1	1658.00	-63.3	-55.7	0.9	-54.8	-13.0	-41.8

Antenna Polarity & Test Distance: Vertical at 3 M

No.	Freq. (MHz)	Reading (dBm)	S.G Power Value (dBm)	Correction Factor (dB)	ERP (dBm)	Limit (dBm)	Margin (dB)
1	1658.00	-62.4	-55.1	0.9	-54.2	-13.0	-41.2

Remarks:

1. ERP (dBm) = S.G Value (dBm) + Correction Factor (dB).
2. Correction Factor (dB) = Substitution Antenna Gain (dB) - Cable Loss (dB) + 2.15dB.

Mode	TX channel 20525 (836.5MHz)	Frequency Range	1GHz ~ 10GHz
Environmental Conditions	22deg. C, 68%RH	Input Power	120Vac, 60Hz
Tested By	Greg Lin		

Antenna Polarity & Test Distance: Horizontal at 3 M

No.	Freq. (MHz)	Reading (dBm)	S.G Power Value (dBm)	Correction Factor (dB)	ERP (dBm)	Limit (dBm)	Margin (dB)
1	1673.00	-63.8	-56.1	0.8	-55.3	-13.0	-42.3

Antenna Polarity & Test Distance: Vertical at 3 M

No.	Freq. (MHz)	Reading (dBm)	S.G Power Value (dBm)	Correction Factor (dB)	ERP (dBm)	Limit (dBm)	Margin (dB)
1	1673.00	-61.8	-54.4	0.8	-53.6	-13.0	-40.6

Remarks:

1. ERP (dBm) = S.G Value (dBm) + Correction Factor (dB).
2. Correction Factor (dB) = Substitution Antenna Gain (dB) - Cable Loss (dB) + 2.15dB.

Mode	TX channel 20600 (844.0MHz)	Frequency Range	1GHz ~ 10GHz
Environmental Conditions	22deg. C, 68%RH	Input Power	120Vac, 60Hz
Tested By	Greg Lin		

Antenna Polarity & Test Distance: Horizontal at 3 M							
No.	Freq. (MHz)	Reading (dBm)	S.G Power Value (dBm)	Correction Factor (dB)	ERP (dBm)	Limit (dBm)	Margin (dB)
1	1688.00	-63.8	-56.1	0.7	-55.4	-13.0	-42.4
Antenna Polarity & Test Distance: Vertical at 3 M							
No.	Freq. (MHz)	Reading (dBm)	S.G Power Value (dBm)	Correction Factor (dB)	ERP (dBm)	Limit (dBm)	Margin (dB)
1	1688.00	-62.8	-55.5	0.7	-54.8	-13.0	-41.8

Remarks:

1. ERP (dBm) = S.G Value (dBm) + Correction Factor (dB).
2. Correction Factor (dB) = Substitution Antenna Gain (dB) - Cable Loss (dB) + 2.15dB.

LTE Band 26, Channel Bandwidth 1.4MHz

Mode	TX channel 26797 (824.7MHz)	Frequency Range	1GHz ~ 10GHz
Environmental Conditions	22deg. C, 68%RH	Input Power	120Vac, 60Hz
Tested By	Greg Lin		

Antenna Polarity & Test Distance: Horizontal at 3 M							
No.	Freq. (MHz)	Reading (dBm)	S.G Power Value (dBm)	Correction Factor (dB)	ERP (dBm)	Limit (dBm)	Margin (dB)
1	1649.40	-62.1	-54.4	0.9	-53.5	-13.0	-40.5
Antenna Polarity & Test Distance: Vertical at 3 M							
No.	Freq. (MHz)	Reading (dBm)	S.G Power Value (dBm)	Correction Factor (dB)	ERP (dBm)	Limit (dBm)	Margin (dB)
1	1649.40	-59.6	-52.4	0.9	-51.5	-13.0	-38.5

Remarks:

1. ERP (dBm) = S.G Value (dBm) + Correction Factor (dB).
2. Correction Factor (dB) = Substitution Antenna Gain (dB) - Cable Loss (dB) + 2.15dB.

Mode	TX channel 26915 (836.5MHz)	Frequency Range	1GHz ~ 10GHz
Environmental Conditions	22deg. C, 68%RH	Input Power	120Vac, 60Hz
Tested By	Greg Lin		

Antenna Polarity & Test Distance: Horizontal at 3 M							
No.	Freq. (MHz)	Reading (dBm)	S.G Power Value (dBm)	Correction Factor (dB)	ERP (dBm)	Limit (dBm)	Margin (dB)
1	1673.00	-62.8	-55.1	0.8	-54.3	-13.0	-41.3
Antenna Polarity & Test Distance: Vertical at 3 M							
No.	Freq. (MHz)	Reading (dBm)	S.G Power Value (dBm)	Correction Factor (dB)	ERP (dBm)	Limit (dBm)	Margin (dB)
1	1673.00	-59.9	-52.6	0.8	-51.8	-13.0	-38.8

Remarks:

1. ERP (dBm) = S.G Value (dBm) + Correction Factor (dB).
2. Correction Factor (dB) = Substitution Antenna Gain (dB) - Cable Loss (dB) + 2.15dB.

Mode	TX channel 27033 (848.3MHz)	Frequency Range	1GHz ~ 10GHz
Environmental Conditions	22deg. C, 68%RH	Input Power	120Vac, 60Hz
Tested By	Greg Lin		

Antenna Polarity & Test Distance: Horizontal at 3 M							
No.	Freq. (MHz)	Reading (dBm)	S.G Power Value (dBm)	Correction Factor (dB)	ERP (dBm)	Limit (dBm)	Margin (dB)
1	1696.60	-62.6	-55.1	0.7	-54.4	-13.0	-41.4
Antenna Polarity & Test Distance: Vertical at 3 M							
No.	Freq. (MHz)	Reading (dBm)	S.G Power Value (dBm)	Correction Factor (dB)	ERP (dBm)	Limit (dBm)	Margin (dB)
1	1696.60	-60.0	-52.7	0.7	-52.0	-13.0	-39.0

Remarks:

1. $ERP (dBm) = S.G \text{ Value (dBm)} + \text{Correction Factor (dB)}$.
2. $\text{Correction Factor (dB)} = \text{Substitution Antenna Gain (dB)} - \text{Cable Loss (dB)} + 2.15dB$.

LTE Band 26, Channel Bandwidth 5MHz

Mode	TX channel 26815 (826.5MHz)	Frequency Range	1GHz ~ 10GHz
Environmental Conditions	22deg. C, 68%RH	Input Power	120Vac, 60Hz
Tested By	Greg Lin		

Antenna Polarity & Test Distance: Horizontal at 3 M							
No.	Freq. (MHz)	Reading (dBm)	S.G Power Value (dBm)	Correction Factor (dB)	ERP (dBm)	Limit (dBm)	Margin (dB)
1	1653.00	-62.0	-54.3	0.9	-53.4	-13.0	-40.4
Antenna Polarity & Test Distance: Vertical at 3 M							
No.	Freq. (MHz)	Reading (dBm)	S.G Power Value (dBm)	Correction Factor (dB)	ERP (dBm)	Limit (dBm)	Margin (dB)
1	1653.00	-59.5	-52.3	0.9	-51.4	-13.0	-38.4

Remarks:

1. ERP (dBm) = S.G Value (dBm) + Correction Factor (dB).
2. Correction Factor (dB) = Substitution Antenna Gain (dB) - Cable Loss (dB) + 2.15dB.

Mode	TX channel 26915 (836.5MHz)	Frequency Range	1GHz ~ 10GHz
Environmental Conditions	22deg. C, 68%RH	Input Power	120Vac, 60Hz
Tested By	Greg Lin		

Antenna Polarity & Test Distance: Horizontal at 3 M							
No.	Freq. (MHz)	Reading (dBm)	S.G Power Value (dBm)	Correction Factor (dB)	ERP (dBm)	Limit (dBm)	Margin (dB)
1	1673.00	-62.2	-54.5	0.8	-53.7	-13.0	-40.7
Antenna Polarity & Test Distance: Vertical at 3 M							
No.	Freq. (MHz)	Reading (dBm)	S.G Power Value (dBm)	Correction Factor (dB)	ERP (dBm)	Limit (dBm)	Margin (dB)
1	1673.00	-59.6	-52.3	0.8	-51.5	-13.0	-38.5

Remarks:

1. ERP (dBm) = S.G Value (dBm) + Correction Factor (dB).
2. Correction Factor (dB) = Substitution Antenna Gain (dB) - Cable Loss (dB) + 2.15dB.

Mode	TX channel 27015 (846.5MHz)	Frequency Range	1GHz ~ 10GHz
Environmental Conditions	22deg. C, 68%RH	Input Power	120Vac, 60Hz
Tested By	Greg Lin		

Antenna Polarity & Test Distance: Horizontal at 3 M							
No.	Freq. (MHz)	Reading (dBm)	S.G Power Value (dBm)	Correction Factor (dB)	ERP (dBm)	Limit (dBm)	Margin (dB)
1	1693.00	-62.2	-54.7	0.7	-54.0	-13.0	-41.0
Antenna Polarity & Test Distance: Vertical at 3 M							
No.	Freq. (MHz)	Reading (dBm)	S.G Power Value (dBm)	Correction Factor (dB)	ERP (dBm)	Limit (dBm)	Margin (dB)
1	1693.00	-59.8	-52.4	0.7	-51.7	-13.0	-38.7

Remarks:

1. ERP (dBm) = S.G Value (dBm) + Correction Factor (dB).
2. Correction Factor (dB) = Substitution Antenna Gain (dB) - Cable Loss (dB) + 2.15dB.

LTE Band 26, Channel Bandwidth 15MHz

Mode	TX channel 26865 (831.5MHz)	Frequency Range	1GHz ~ 10GHz
Environmental Conditions	22deg. C, 68%RH	Input Power	120Vac, 60Hz
Tested By	Greg Lin		

Antenna Polarity & Test Distance: Horizontal at 3 M							
No.	Freq. (MHz)	Reading (dBm)	S.G Power Value (dBm)	Correction Factor (dB)	ERP (dBm)	Limit (dBm)	Margin (dB)
1	1663.00	-62.1	-54.5	0.9	-53.6	-13.0	-40.6
Antenna Polarity & Test Distance: Vertical at 3 M							
No.	Freq. (MHz)	Reading (dBm)	S.G Power Value (dBm)	Correction Factor (dB)	ERP (dBm)	Limit (dBm)	Margin (dB)
1	1663.00	-59.6	-52.4	0.9	-51.5	-13.0	-38.5

Remarks:

1. ERP (dBm) = S.G Value (dBm) + Correction Factor (dB).
2. Correction Factor (dB) = Substitution Antenna Gain (dB) - Cable Loss (dB) + 2.15dB.

Mode	TX channel 26915 (836.5MHz)	Frequency Range	1GHz ~ 10GHz
Environmental Conditions	22deg. C, 68%RH	Input Power	120Vac, 60Hz
Tested By	Greg Lin		

Antenna Polarity & Test Distance: Horizontal at 3 M							
No.	Freq. (MHz)	Reading (dBm)	S.G Power Value (dBm)	Correction Factor (dB)	ERP (dBm)	Limit (dBm)	Margin (dB)
1	1673.00	-62.2	-54.5	0.8	-53.7	-13.0	-40.7
Antenna Polarity & Test Distance: Vertical at 3 M							
No.	Freq. (MHz)	Reading (dBm)	S.G Power Value (dBm)	Correction Factor (dB)	ERP (dBm)	Limit (dBm)	Margin (dB)
1	1673.00	-60.1	-52.8	0.8	-52.0	-13.0	-39.0

Remarks:

1. ERP (dBm) = S.G Value (dBm) + Correction Factor (dB).
2. Correction Factor (dB) = Substitution Antenna Gain (dB) - Cable Loss (dB) + 2.15dB.

Mode	TX channel 26965 (841.5MHz)	Frequency Range	1GHz ~ 10GHz
Environmental Conditions	22deg. C, 68%RH	Input Power	120Vac, 60Hz
Tested By	Greg Lin		

Antenna Polarity & Test Distance: Horizontal at 3 M							
No.	Freq. (MHz)	Reading (dBm)	S.G Power Value (dBm)	Correction Factor (dB)	ERP (dBm)	Limit (dBm)	Margin (dB)
1	1683.00	-62.2	-54.7	0.8	-53.9	-13.0	-40.9
Antenna Polarity & Test Distance: Vertical at 3 M							
No.	Freq. (MHz)	Reading (dBm)	S.G Power Value (dBm)	Correction Factor (dB)	ERP (dBm)	Limit (dBm)	Margin (dB)
1	1683.00	-59.8	-52.4	0.8	-51.6	-13.0	-38.6

Remarks:

1. $ERP (dBm) = S.G \text{ Value (dBm)} + \text{Correction Factor (dB)}$.
2. $\text{Correction Factor (dB)} = \text{Substitution Antenna Gain (dB)} - \text{Cable Loss (dB)} + 2.15dB$.

5 Pictures of Test Arrangements

Please refer to the attached file (Test Setup Photo).

Appendix – Information of the Testing Laboratories

We, Bureau Veritas Consumer Products Services (H.K.) Ltd., Taoyuan Branch, were founded in 1988 to provide our best service in EMC, Radio, Telecom and Safety consultation. Our laboratories are FCC recognized accredited test firms and accredited and approved according to ISO/IEC 17025.

If you have any comments, please feel free to contact us at the following:

Lin Kou EMC/RF Lab

Tel: 886-2-26052180

Fax: 886-2-26051924

Hsin Chu EMC/RF/Telecom Lab

Tel: 886-3-6668565

Fax: 886-3-6668323

Hwa Ya EMC/RF/Safety Lab

Tel: 886-3-3183232

Fax: 886-3-3270892

Email: service.adt@tw.bureauveritas.com

Web Site: www.bureauveritas-adt.com

The address and road map of all our labs can be found in our web site also.

--- END ---