

X1 Yoga Gen 5 and X1 Carbon Gen 8 User Guide



Read this first

Before using this documentation and the product it supports, ensure that you read and understand the following:

- Appendix A “Important safety information” on page 69
- *Safety and Warranty Guide*
- *Setup Guide*

First Edition (April 2020)

© Copyright Lenovo 2020.

LIMITED AND RESTRICTED RIGHTS NOTICE: If data or software is delivered pursuant to a General Services Administration “GSA” contract, use, reproduction, or disclosure is subject to restrictions set forth in Contract No. GS-35F-05925.

Contents

About this documentation iii

Chapter 1. Meet your computer 1

Front	1
Base	3
Left	4
Right	6
Rear	8
Bottom	9
Features and specifications	10
Statement on USB transfer rate	11

Chapter 2. Get started with your computer 13

Get started with Windows 10	13
Windows account	13
Windows user interface	14
Windows label	15
Connect to networks	15
Connect to the wired Ethernet	15
Connect to Wi-Fi networks	15
Connect to a cellular network	16
Use Lenovo Vantage	16
Interact with your computer	17
Use the keyboard shortcuts	18
Use the TrackPoint pointing device	20
Use the trackpad	21
Use the multi-touch screen (for selected models)	23
Use the PrivacyGuard feature (for selected models)	25
Use the Intelligent Cooling feature	26
Use multimedia	27
Use audio	27
Connect to an external display	27
Get to know YOGA modes (for X1 Yoga Gen 5 only)	28
Use ThinkPad Pen Pro (for X1 Yoga Gen 5 only)	30

Chapter 3. Explore your computer 33

Manage power	33
Check the battery status and temperature	33
Charge the computer	33
Maximize the battery life	34
Set power button behaviors	34
Set the power plan	34
Transfer data	35
Connect to a Bluetooth-enabled device	35

Set up an NFC connection	35
Airplane mode	36

Chapter 4. Accessories 37

Purchase options	37
Docking station	37
Front view	38
Rear view	39
Attach a docking station	40
Detach a docking station	41
Connect multiple external displays	42

Chapter 5. Secure your computer and information 43

Lock the computer	43
Use passwords	43
Password types	43
Set, change, and remove a password	45
Use Power Loss Protection function (for selected models)	46
Use the fingerprint reader (for selected models)	46
Use face authentication (for selected models)	47
Use firewalls and antivirus programs	47

Chapter 6. Configure advanced settings 49

UEFI BIOS	49
What is UEFI BIOS	49
Enter the UEFI BIOS menu	49
Navigate in the UEFI BIOS interface	49
Change the startup sequence	49
Set the system date and time	50
Update UEFI BIOS	50
Recovery information	50
Restore system files and settings to an earlier point	50
Restore your files from a backup	50
Reset your computer	50
Use advanced options	51
Windows automatic recovery	51
Create and use a recovery USB device	51
Install Windows 10 and drivers	52

Chapter 7. CRU replacement 55

What are CRUs	55
Disable Fast Startup and the built-in battery	55
Replace a CRU	56
Base cover assembly	56

Wireless-WAN card (for selected models) . . .	57
M.2 solid-state drive	59
Pen charger (for X1 Yoga Gen 5 only)	61
Chapter 8. Help and support	63
Frequently asked questions	63
Error messages	64
Beep errors	65
Self-help resources	66
Call Lenovo	67
Before you contact Lenovo	67
Lenovo Customer Support Center	67
Purchase additional services.	68

Appendix A. Important safety information.	69
--	-----------

Appendix B. Accessibility and ergonomic information	83
--	-----------

Appendix C. Supplemental information about the Linux operating system	87
--	-----------

Appendix D. Compliance information.	89
--	-----------

Appendix E. Notices and trademarks.	103
--	------------

About this documentation

- Illustrations in this documentation might look different from your product.
- Depending on the model, some optional accessories, features, and software programs might not be available on your computer.
- Depending on the version of operating systems and programs, some user interface instructions might not be applicable to your computer.
- Documentation content is subject to change without notice. Lenovo makes constant improvements on the documentation of your computer, including this *User Guide*. To get the latest documentation, go to <https://pcsupport.lenovo.com>.
- Microsoft® makes periodic feature changes to the Windows® operating system through Windows Update. As a result, some information in this documentation might become outdated. Refer to Microsoft resources for the latest information.

Chapter 1. Meet your computer

Front

X1 Yoga Gen 5

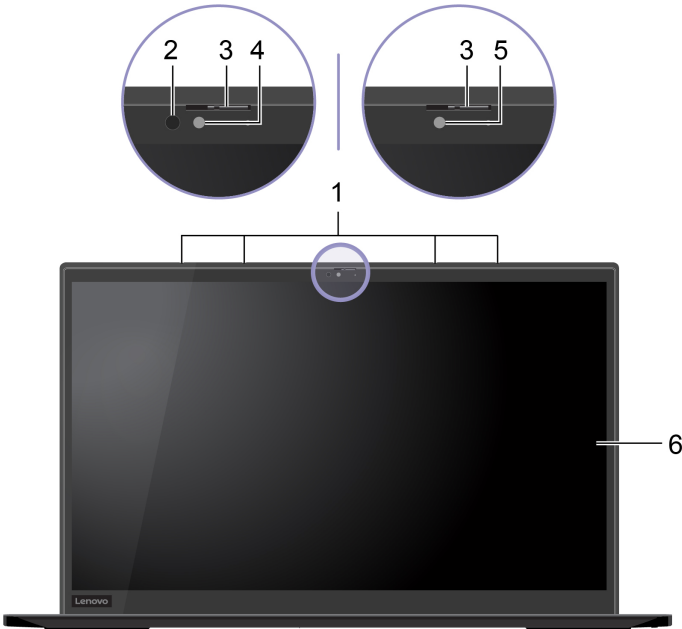

X1 Carbon Gen 8

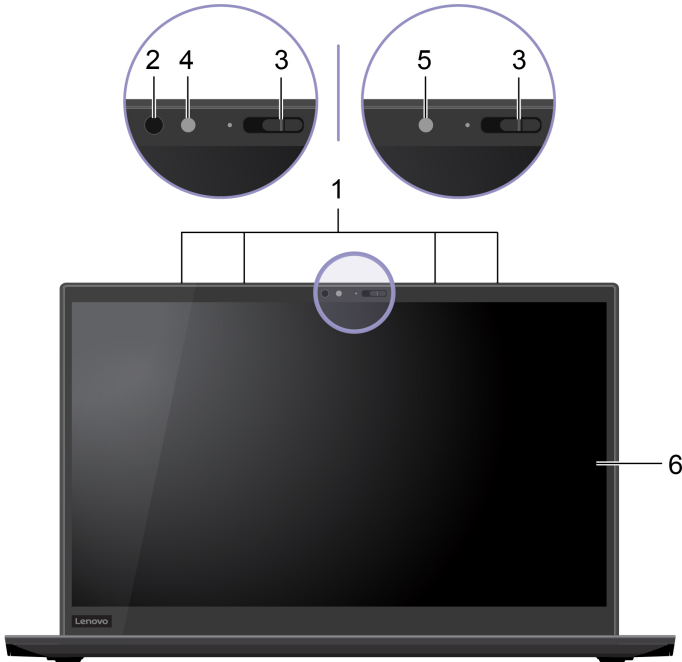

1. Microphones	Capture or record sound.
2. Infrared LED*	Emit infrared (IR) light. Note: Do not block the IR light-emitting diode (LED). Otherwise, the IR function might not work.
3. ThinkShutter	Slide ThinkShutter to cover or uncover the camera lens. It is designed to protect your privacy.
4. Camera with IR function*	<ul style="list-style-type: none"> • Take pictures or record videos by clicking Camera from the Start menu. The indicator next to the camera is on when the camera is in use. • Log in to your computer with face authentication. See “Use face authentication (for selected models)” on page 47. • If you use other apps that support photographing, video chatting, and video conference, the camera starts automatically when you enable the camera-required feature from the app.
5. Camera*	Take pictures or record videos by clicking Camera from the Start menu. The indicator next to the camera is on when the camera is in use. If you use other apps that support photographing, video chatting, and video conference, the camera starts automatically when you enable the camera-required feature from the app.
6. Multi-touch screen*	Enable you to use your computer with simple touch gestures. See “Use the multi-touch screen (for selected models)” on page 23.

* for selected models

Base

X1 Yoga Gen 5



X1 Carbon Gen 8

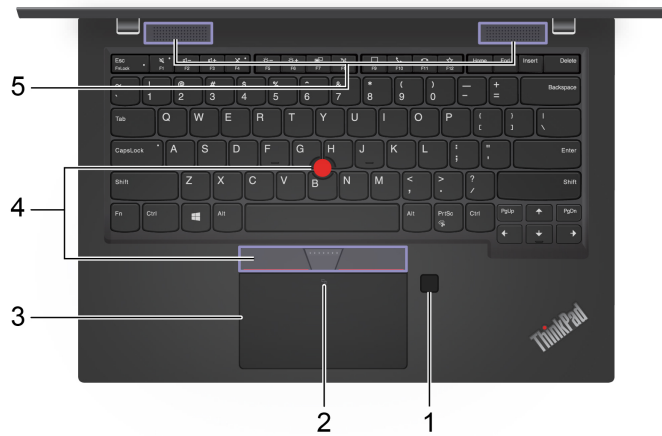

1. Fingerprint reader	Log in to your computer with enrolled fingerprints. See “Use the fingerprint reader (for selected models)” on page 46.
2. NFC mark*	Your computer supports NFC (near field communication). You can share information with another NFC-enabled device. See “Set up an NFC connection” on page 35.
3. Trackpad	Perform finger touch and all the functions of a traditional mouse. See “Use the trackpad” on page 21.
4. TrackPoint® pointing device	Perform all the functions of a traditional mouse. See “Use the TrackPoint pointing device” on page 20.
5. Speakers	Enable you to experience high-quality sound.

* for selected models

Left

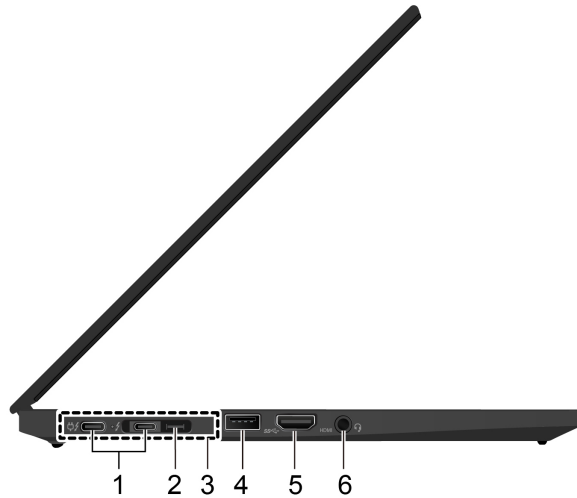

1. Thunderbolt™ 3 connectors (USB-C)

- Charge your computer.
- Charge USB-C compatible devices with the output voltage and current of 5 V and 1.5 A.
- Transfer data:
 - Thunderbolt 3 speed, up to 40 Gbps (when the device connected is Thunderbolt 3 compatible)
 - USB 3.2 Gen 2 speed, up to 10 Gbps (when the device connected is not Thunderbolt 3 compatible)
- Connect to an external display:
 - USB-C to VGA: 1920 x 1200 pixels, 60 Hz
 - USB-C to DP: 3840 x 2160 pixels, 60 Hz
- Connect to USB-C accessories to help expand your computer functionality. To purchase USB-C accessories, go to <https://www.lenovo.com/accessories>.
- Supply power to another computer using P-to-P (Peer to Peer) 2.0 charging function. See “Use P-to-P 2.0 charging function” on page 33.

Notes:

- When the battery power is below 10%, the connected USB-C accessories might not work correctly.
- If your computer supports wireless wide area network (WAN) and Global Positioning System (GPS) functions, the USB device or Thunderbolt 3 device connected to the Thunderbolt 3 connectors might influence these functions. If your computer cannot establish wireless WAN communications, or if your location cannot be pinpointed through the GPS function of your computer, detach the device from the Thunderbolt 3 connectors.

2. Ethernet extension connector Gen 2

Make your computer thinner than the ones with a standard Ethernet connector. Use a ThinkPad Ethernet Extension Adapter Gen 2 to connect your computer to a local area network (LAN) through this connector. The ThinkPad Ethernet Extension Adapter Gen 2 is available as an option and shipped with some computer models only. You can purchase a ThinkPad Ethernet Extension Adapter Gen 2 from Lenovo at: <https://www.lenovo.com/accessories>.

3. Docking-station connector	<p>Connect the computer to one of the following supported docks to extend the computer capabilities:</p> <ul style="list-style-type: none"> • ThinkPad Basic Docking Station • ThinkPad Pro Docking Station • ThinkPad Ultra Docking Station
4. USB 3.2 connector Gen 1	<p>Connect a USB-compatible device, such as a USB keyboard, USB mouse, USB storage device, or USB printer.</p> <p>Note: If your computer supports wireless wide area network (WAN) and Global Positioning System (GPS) functions, the USB device connected to the USB 3.2 connector Gen 1 might influence these functions. If your computer cannot establish wireless WAN communications, or if your location cannot be pinpointed through the GPS function of your computer, detach the device from the USB 3.2 connector Gen 1.</p>
5. HDMI™ connector	<p>Connect to a compatible digital audio device or video monitor, such as an HDTV.</p>
6. Audio connector	<ul style="list-style-type: none"> • Connect headphones with a 3.5-mm (0.14-inch) and 4-pole plug to listen to the sound from the computer. • Connect a headset with a 3.5-mm (0.14-inch) and 4-pole plug to listen to the sound from the computer or talk with others. <p>Note: This connector does not support standalone external microphones.</p>

Right

X1 Yoga Gen 5

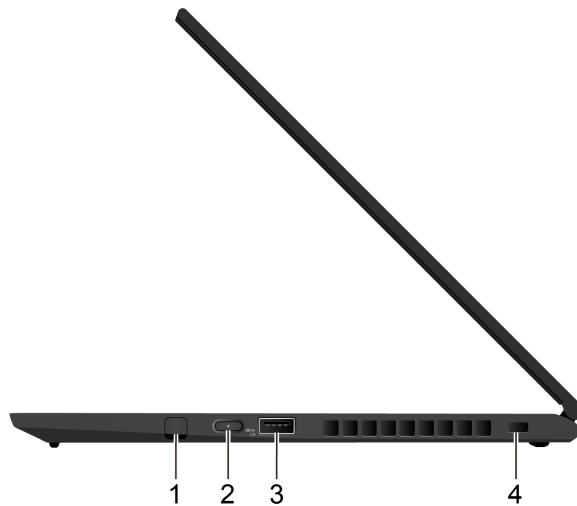

X1 Carbon Gen 8

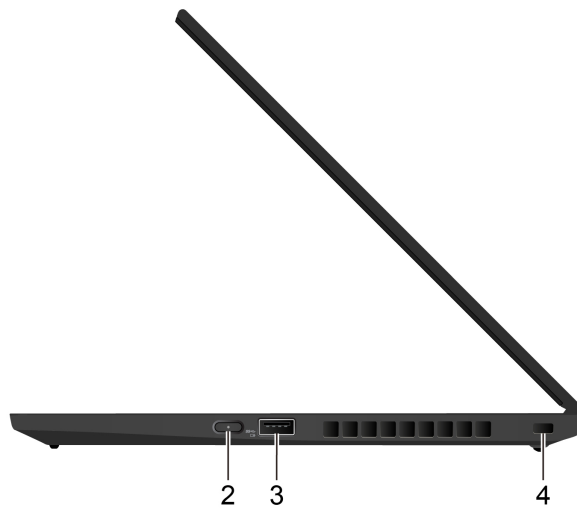

1. ThinkPad Pen Pro

See “Use ThinkPad Pen Pro (for X1 Yoga Gen 5 only)” on page 30.

Press to turn on the computer or put the computer to sleep mode.

To turn off the computer, open the Start menu, click **Power**, and then select **Shut down**.

2. Power button

The indicator in the power button shows the system status of your computer.

- **Blinking for three times:** The computer is initially connected to power.
 - **On:** The computer is on.
 - **Off:** The computer is off or in hibernation mode.
 - **Blinking rapidly:** The computer is entering sleep or hibernation mode.
 - **Blinking slowly:** The computer is in sleep mode.
-

3. Always On USB 3.2 connector Gen 1

With the Always On USB feature enabled, the Always On USB 3.2 connector Gen 1 can charge a USB-compatible device when the computer is on, off, in sleep mode, or in hibernation mode.

Notes:

- By default, **Always On USB** is enabled and **Charge in Battery Mode** is disabled in UEFI BIOS.
- When the computer is off or in hibernation mode, and **Charge in Battery Mode** is disabled in UEFI BIOS, ensure that you have connected the computer to ac power.

To enable the Always On USB feature:

1. Enter the UEFI BIOS menu. See “Enter the UEFI BIOS menu” on page 49.
2. Click **Config → USB → Always On USB** to enable the Always On USB feature.

Note: If your computer supports wireless wide area network (WAN) and Global Positioning System (GPS) functions, the USB device connected to the Always On USB 3.2 connector Gen 1 might influence these functions. If your computer cannot establish wireless WAN communications, or if your location cannot be pinpointed through the GPS function of your computer, detach the device from the Always On USB 3.2 connector Gen 1.

4. Mini security-lock slot

Lock your computer to a desk, table, or other fixtures through a compatible security cable lock. See “Lock the computer” on page 43 .

Rear

X1 Yoga Gen 5

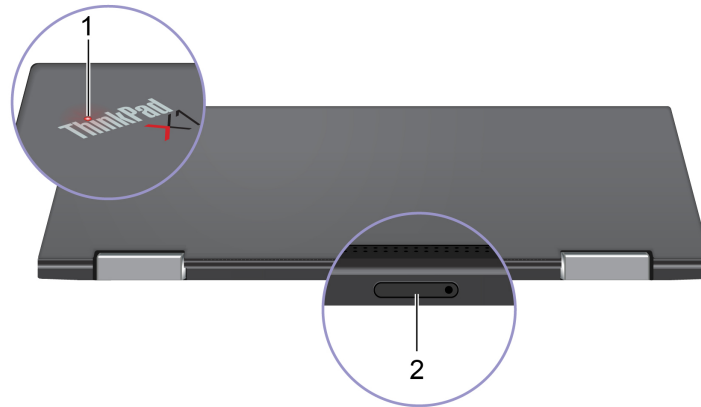

X1 Carbon Gen 8

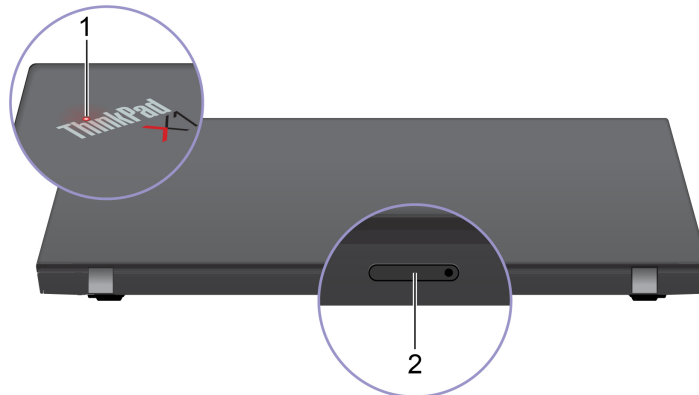

1. System status indicator

The indicator in the ThinkPad logo on the computer lid shows the system status of your computer.

- **Blinking for three times:** The computer is initially connected to power.
- **On:** The computer is on.
- **Off:** The computer is off or in hibernation mode.
- **Blinking rapidly:** The computer is entering sleep or hibernation mode.
- **Blinking slowly:** The computer is in sleep mode.

2. Nano-SIM-card tray*

Use the Nano Subscriber Identity Module (SIM) card to connect to a wireless-WAN network. See “Connect to a cellular network” on page 16.

* for selected models

Bottom

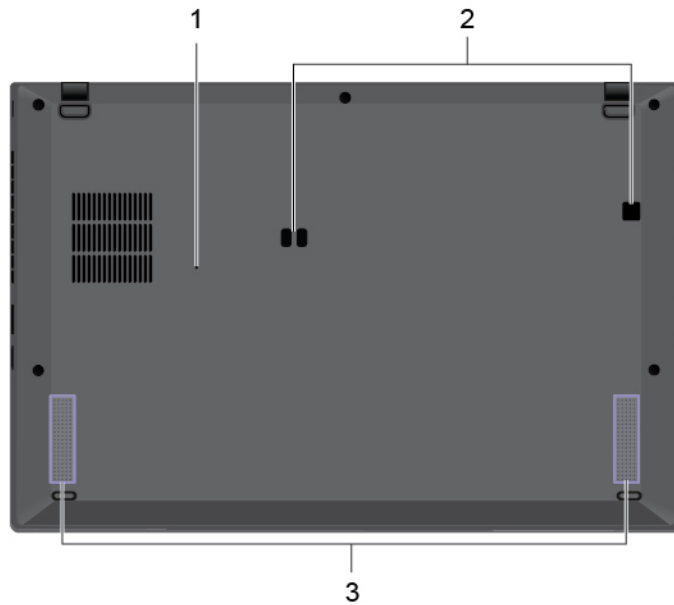

1. Emergency-reset hole	<p>If the computer stops responding and you cannot turn it off by pressing the power button, reset your computer:</p> <ol style="list-style-type: none">1. Disconnect your computer from ac power.2. Insert a straightened paper clip into the hole to cut off power supply temporarily.3. Connect your computer to ac power and then turn on your computer.
2. Docking-station hook holes	Use the docking-station hook holes to secure a supported docking station.
3. Speakers	Enable you to experience high-quality sound.

Features and specifications

Dimensions	<ul style="list-style-type: none">• X1 Yoga Gen 5:<ul style="list-style-type: none">– Width: 322.9 mm (12.7 inches)– Depth: 218.1 mm (8.6 inches)– Thickness: 15.5 mm (0.61 inches)• X1 Carbon Gen 8:<ul style="list-style-type: none">– Width: 323.5 mm (12.7 inches)– Depth: 217.1 mm (8.5 inches)– Thickness: 14.9 mm (0.59 inches)
Maximum heat output (depending on the model)	<ul style="list-style-type: none">• 45 W (154 Btu/hr)• 65 W (222 Btu/hr)
Power source (ac power adapter)	<ul style="list-style-type: none">• Sine-wave input at 50 Hz to 60 Hz• Input rating of the ac power adapter: 100 V to 240 V ac, 50 Hz to 60 Hz
Microprocessor	To view the microprocessor information of your computer, right-click the Start button and then click System .
Memory	Low power double data rate 3 (LPDDR3) memory module, soldered on the system board, up to 16 GB
Storage device	<ul style="list-style-type: none">• M.2 solid-state drive*• Hybrid solid-state drive* (with Intel® Optane™ memory)
Display	<ul style="list-style-type: none">• Brightness control• Color display with In-Plane Switching (IPS) technology• Display size: 355.6 mm (14 inches)• Display resolution: 1920 x 1080 pixels, 2560 x 1440 pixels, or 3840 x 2160 pixels• Intel UHD Graphics• Multi-touch technology*• Privacy Guard feature*
Keyboard	<ul style="list-style-type: none">• Function keys• Six-row keyboard with backlight• Trackpad• TrackPoint pointing device
Connectors and slots	<ul style="list-style-type: none">• Audio connector• Ethernet extension connector Gen 2• HDMI connector• Nano-SIM-card tray*• Two USB 3.2 connectors Gen 1 (including one Always On USB 3.2 connector Gen 1)• Two Thunderbolt 3 connectors (USB-C)

Security features	<ul style="list-style-type: none"> • Face authentication* • Fingerprint reader • Mini security-lock slot • Password • Trusted Platform Module (TPM)*
Wireless features	<ul style="list-style-type: none"> • Bluetooth • Global Positioning System (GPS) satellite receiver (available on models with wireless WAN)* • Near field communication (NFC)* • Proximity sensor* • Wireless LAN • Wireless WAN*
Others	<ul style="list-style-type: none"> • Camera • Microphones

* for selected models

Statement on USB transfer rate

Depending on many factors such as the processing capability of the host and peripheral devices, file attributes, and other factors related to system configuration and operating environments, the actual transfer rate using the various USB connectors on this device will vary and will be slower than the data rate listed below for each corresponding device.

USB device	Data rate (Gbit/s)
3.2 Gen 1 / 3.1 Gen 1	5
3.2 Gen 2 / 3.1 Gen 2	10
3.2 Gen 2 × 2	20

Chapter 2. Get started with your computer

Get started with Windows 10

Learn the basics of Windows 10 and start working with it right away. For more information about Windows 10, see the Windows help information.

Windows account

A user account is required to use the Windows operating system. It can either be a Windows user account or a Microsoft account.

Windows user account

When you start Windows for the first time, you are prompted to create a Windows user account. This first account you created is of the “Administrator” type. With an Administrator account, you can create additional user accounts or change account types by doing the following:

1. Open the **Start** menu and select **Settings → Accounts → Family & other users**.
2. Follow the on-screen instructions.

Microsoft account

You can also log in to the Windows operating system with a Microsoft account.









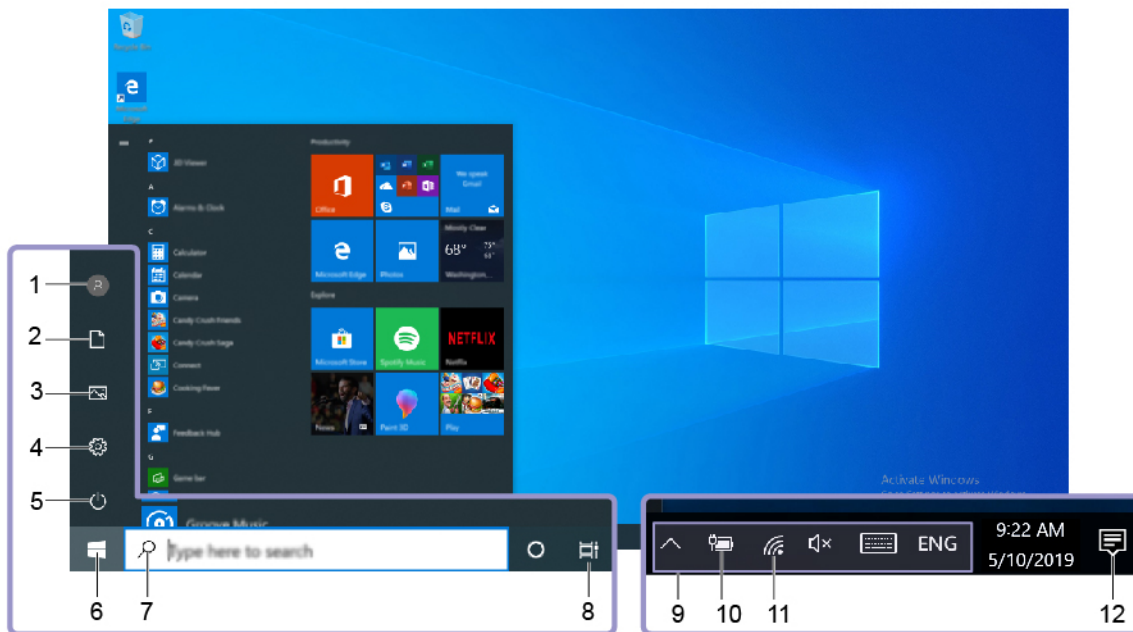

To create a Microsoft account, go to the Microsoft sign-up page at <https://signup.live.com> and follow the on-screen instructions.

With a Microsoft account, you can:

- Enjoy one-time signing in if you are using other Microsoft services, such as OneDrive, Skype, and Outlook.com.
- Sync personalized settings across other Windows-based devices.

Windows user interface



1. Account 	Change account settings, lock the computer, or sign out from the current account.
2. Documents 	Open the Documents folder, a default folder to save your received files.
3. Pictures 	Open the Pictures folder, a default folder to save your received pictures.
4. Settings 	Launch Settings.
5. Power 	Shut down, restart, or put the computer into sleep mode.
6. Start button 	Open the Start menu.
7. Windows Search 	Type what you are looking for in the search box and get search results from your computer and the Web.
8. Task View 	Display all opened apps and switch among them.
9. Windows notification area	Display notifications and status of some features.
10. Battery status icon	Display power status and change battery or power settings. When your computer is not connected to ac power, the icon changes to  .
11. Network icon	Connect to an available wireless network and display the network status. When connected to a wired network, the icon changes to  .
12. Action center 	Display the latest notifications from apps and provide quick access to some features.

Open the Start menu

- Click the **Start** button.
- Press the Windows logo key on the keyboard.

Access Control Panel

- Open the **Start** menu and click **Windows System** → **Control Panel**.

- Use Windows Search.

Launch an app

- Open the **Start** menu and select the app you want to launch.
- Use Windows Search.

Windows label

Your computer might have a Windows 10 Genuine Microsoft label affixed to its cover depending on the following factors:

- Your geographic location
- Edition of Windows 10 that is preinstalled

Go to <https://www.microsoft.com/en-us/howtotell/Hardware.aspx> for illustrations of the various types of Genuine Microsoft labels.

- In the People's Republic of China, the Genuine Microsoft label is required on all computer models preinstalled with any version of Windows 10.
- In other countries and regions, the Genuine Microsoft label is required only on computer models licensed for Windows 10 Pro.

The absence of a Genuine Microsoft label does not indicate that the preinstalled Windows version is not genuine. For details on how to tell whether your preinstalled Windows product is genuine, refer to the information provided by Microsoft at <https://www.microsoft.com/en-us/howtotell/default.aspx>.

There are no external, visual indicators of the Product ID or Windows version for which the computer is licensed. Instead, the Product ID is recorded in the computer firmware. Whenever a Windows 10 product is installed, the installation program checks the computer firmware for a valid, matching Product ID to complete the activation.

In some cases, an earlier Windows version might be preinstalled under the terms of the Windows 10 Pro license downgrade rights.

Connect to networks

Your computer helps you connect to the world through a wired or wireless network.

Connect to the wired Ethernet

Connect your computer to a local network through the Ethernet extension connector Gen 2 on your computer with a ThinkPad Ethernet Extension Adapter Gen 2.

The Ethernet extension adapter is available as an option and shipped with some computer models. You can purchase one from Lenovo at <https://www.lenovo.com/accessories>.

Connect to Wi-Fi networks

1. Click the network icon in the Windows notification area. A list of available wireless networks is displayed.
2. Select a network available for connection. Provide required information, if needed.

Connect to a cellular network

If your computer has a wireless wide area network (WAN) card and a nano-SIM card installed, you can connect to a cellular data network and get online using the cellular signal.

Note: The cellular service is provided by authorized mobile service carriers in some countries or regions. You must have a cellular plan from a service carrier to connect to the cellular network.

To establish a cellular connection:

1. Locate the nano-SIM-card slot.
2. Install a nano-SIM card into the slot:
 - a. Insert a straightened paper clip into the hole in the tray and the tray ejects.
 - b. Install a new nano-SIM card into the tray with the metal contacts facing downward.
 - c. Insert the tray into the nano-SIM-card slot until you hear a click.

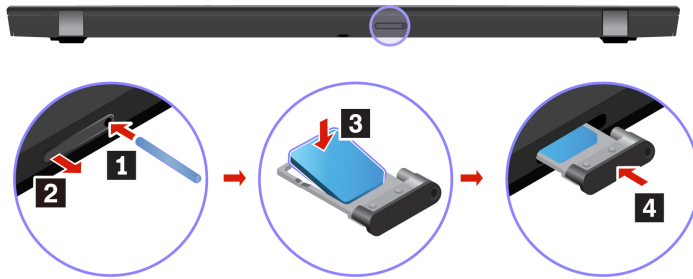

3. Click the network icon in the Windows notification area, and then select the cellular network icon  from the list.
4. Provide required information if needed.

Use Lenovo Vantage



The preinstalled Lenovo Vantage is a customized one-stop solution to help you maintain your computer with automated updates and fixes, configure hardware settings, and get personalized support.

Access Lenovo Vantage

Open the **Start** menu and click **Lenovo Vantage**. You also can type **Lenovo Vantage** in the search box.

To download the latest version of Lenovo Vantage, go to Microsoft Store and search by the app name.

Key features

Lenovo Vantage enables you to:

- Know the device status easily and customize device settings.
- Download and install UEFI BIOS, firmware, and driver updates to keep your computer up-to-date.
- Monitor your computer health, and secure your computer against outside threats.
- Look up warranty status (online).

- Access *User Guide* and helpful articles.

Notes:

- The available features vary depending on the computer model.
- Lenovo Vantage makes periodic updates of the features to keep improving your experience with your computer. The description of features might be different from that on your actual user interface.





Interact with your computer



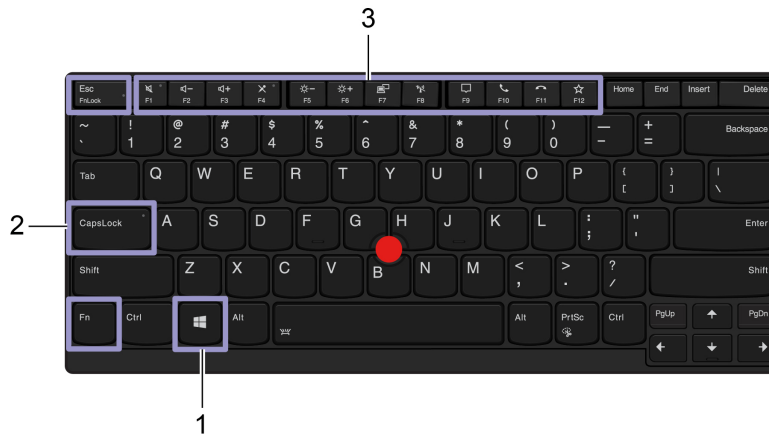







Your computer provides you various ways to navigate the screen.

Use the keyboard shortcuts

The special keys on the keyboard help you work more easily and effectively.



1. Windows logo key	<p>Open the Start menu.</p> <p>For information about using this key with other keys, see the Windows help information.</p>
2. Caps Lock key	<p>Switch the letter case between the upper case and lower case.</p> <p>When the key indicator is on, you can type uppercase letters.</p>
3. F1–F12 function keys	<p>Invoke the special function printed as an icon on each key or standard function.</p> <p>To choose whether to invoke the special function or standard function:</p> <ol style="list-style-type: none"> 1. Go to Control Panel and view by Large icons or Small icons. 2. Click Keyboard or Lenovo - Keyboard Manager and select the option of your preference.
 + 	<p>Switch the function of the F1–F12 keys between the standard function and special function printed as an icon on each key.</p> <p>When the Fn Lock indicator is on:</p> <ul style="list-style-type: none"> • Press F1-F12 to use the standard function. • Press Fn+F1-F12 to use the special function. <p>When the Fn Lock indicator is off:</p> <ul style="list-style-type: none"> • Press Fn+F1-F12 to use the standard function. • Press F1-F12 to use the special function.
	<p>Mute or unmute the speakers.</p> <p>When the key indicator is on, the speakers are muted.</p> <p>If you mute the speakers and turn off your computer, the speakers remain muted when you turn on your computer.</p>
	Volume down.
	Volume up.

	Mute or unmute the microphones. When the key indicator is on, the microphones are muted.
	Brightness down.
	Brightness up.
	Manage external displays.
	Wireless on / wireless off.
	Expand or collapse the notification center.
	Answer incoming calls. This function only works with some apps, such as Skype for Business 2016 and Microsoft Teams 1.0. By default, the function works with Skype for Business 2016. You can change the default setting on Lenovo Vantage.
	Decline incoming calls. This function only works with some apps, such as Skype for Business 2016 and Microsoft Teams 1.0. By default, the function works with Skype for Business 2016. You can change the default setting on Lenovo Vantage. Note: You can also press F11 to hang up ongoing calls on Skype for Business 2016.
	Invoke the function defined by yourself. Open Lenovo Vantage, and you can define different functions for the F12 key.
	Open the Snipping Tool program.
Fn+Spacebar	Switch between different keyboard backlight statuses if your computer supports keyboard backlight.
Fn+B	Equal the Break key on a conventional external keyboard.
Fn+K	Equal the ScrLK or Scroll Lock key on a conventional external keyboard.
Fn+P	Equal the Pause key on a conventional external keyboard.
Fn+S	Equal the SysRq key on a conventional external keyboard.
Fn+4	Put the computer to sleep mode. To wake up the computer, press Fn or the power button.
Fn+D	If your computer supports the Privacy Guard feature, press Fn+D to enable or disable this feature. For more information, see “Use face authentication (for selected models)” on page 47.
Fn+Left arrow key	Equal the Home key.
Fn+Right arrow key	Equal the End key.

Use the TrackPoint pointing device

The TrackPoint pointing device enables you to perform all the functions of a traditional mouse, such as pointing, clicking, and scrolling.

Use the TrackPoint pointing device



1. Pointing stick

Use your index finger or middle finger to apply pressure to the pointing-stick nonslip cap in any direction parallel to the keyboard. The pointer on the screen moves accordingly but the pointing stick itself does not move. The higher the pressure applied, the faster the pointer moves.

2. Left-click button

Press to select or open an item.

3. Right-click button

Press to display a shortcut menu.

4. Middle button

Press and hold the dotted middle button while applying pressure to the pointing stick in the vertical or horizontal direction. Then, you can scroll through the document, Web site, or apps.

Disable the TrackPoint pointing device

The TrackPoint pointing device is active by default. To disable the device:

1. Open the **Start** menu, and then click **Settings** → **Devices** → **Mouse**.
2. Follow the on-screen instructions to disable TrackPoint.

Replace the pointing-stick nonslip cap

Note: Ensure that the new cap has grooves **a**.

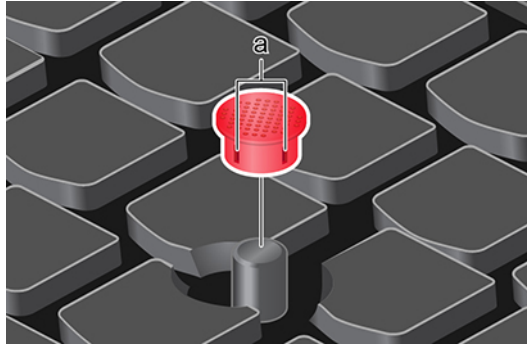

Use the trackpad

The entire trackpad surface is sensitive to finger touch and movement. You can use the trackpad to perform all the pointing, clicking, and scrolling functions of a traditional mouse.

Use the trackpad



1. Left-click zone

Press to select or open an item.

You also can tap anywhere on the surface of the trackpad with one finger to perform the left-click action.

2. Right-click zone

Press to display a shortcut menu.

You also can tap anywhere on the surface of the trackpad with two fingers to perform the right-click action.

Use the touch gestures

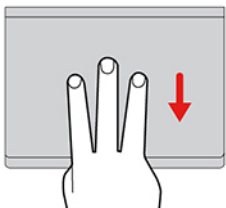
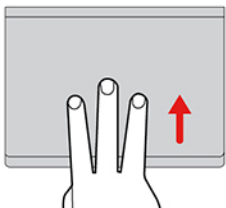
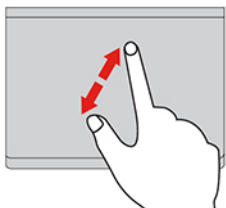
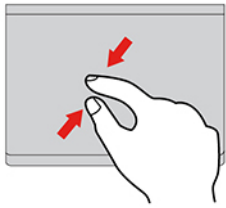
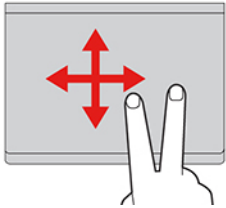
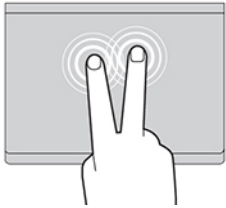
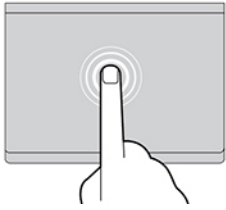

Tap

Tap anywhere on the trackpad with one finger to select or open an item.

Two-finger tap

Tap anywhere on the trackpad with two fingers to display a shortcut menu.

Two-finger scroll

Put two fingers on the trackpad and move them in the vertical or horizontal direction. This action enables you to scroll through the document, Web site, or apps.

Two-finger zoom out

Put two fingers on the trackpad and move them closer together to zoom out.

Two-finger zoom in

Put two fingers on the trackpad and move them farther apart to zoom in.

Swipe three fingers up

Put three fingers on the trackpad and move them up to open the task view to see all your open windows.

Swipe three fingers down

Put three fingers on the trackpad and move them down to show the desktop.

Notes:

- When using two or more fingers, ensure that you position your fingers slightly apart.
- Some gestures are not available if the last action was done from the TrackPoint pointing device.
- Some gestures are only available when you are using certain apps.
- If the trackpad surface is stained with oil, turn off the computer first. Then, gently wipe the trackpad surface with a soft and lint-free cloth moistened with lukewarm water or computer cleaner.

For more gestures, see the help information of the pointing device.

Disable the trackpad

The trackpad is active by default. To disable the device:

1. Open the **Start** menu, and then click **Settings → Devices → Touchpad**.
2. In the Touchpad section, turn off the **Touchpad** control.

Use the multi-touch screen (for selected models)

If your computer display supports the multi-touch function, you can navigate the screen with simple touch gestures.

Note: Some gestures might not be available depending on the app you use.

**Tap once**

- From the **Start** menu: Open an app or item.
- From the desktop: Select an app or item.
- In an open app: Perform an action such as **Copy**, **Save**, and **Delete**, depending on the app.

**Tap twice quickly**

Open an app or item from the desktop.

**Tap and hold**

Open a shortcut menu.

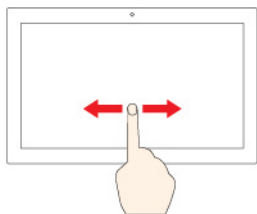
**Slide**

Scroll through items, such as lists, pages, and photos.

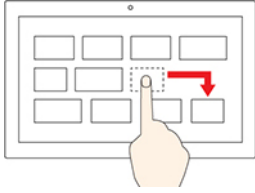

Drag an item to the location you want

Move an object.

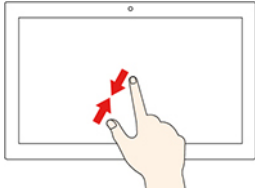

Move two fingers closer together

Zoom out.

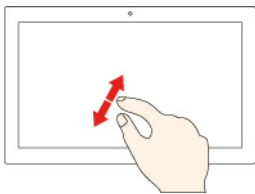

Move two fingers farther apart

Zoom in.

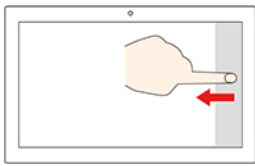

Swipe in from the right edge

Open the action center to see your notifications and quick actions.

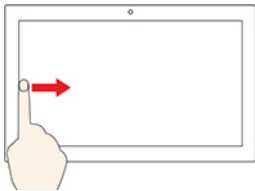

Swipe in from the left edge

View all your open windows in task view.

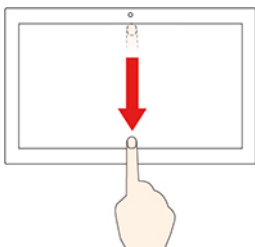

- **Swipe downwards shortly from the top edge (for full-screened app or when your computer is in the tablet mode)**

Show a hidden title bar.

- **Swipe in from the top edge to the bottom edge (when your computer is in the tablet mode)**

Close the current app.

Tips

- Turn off the computer before cleaning the multi-touch screen.
- Use a dry, soft, and lint-free cloth or a piece of absorbent cotton to remove fingerprints or dust from the multi-touch screen. Do not apply solvents to the cloth.
- The multi-touch screen is a glass panel covered with a plastic film. Do not apply pressure or place any metallic object on the screen, which might damage the touch panel or cause it to malfunction.



- Do not use fingernails, gloved fingers, or inanimate objects for input on the screen.
- Regularly calibrate the accuracy of the finger input to avoid a discrepancy.

Use the PrivacyGuard feature (for selected models)

Depending on the model, your computer might support the PrivacyGuard feature.

The PrivacyGuard feature prevents others from peeking at your screen to protect your privacy whenever needed. When the feature is enabled, it darkens the screen and narrows the viewing angle.

The effective direction of the PrivacyGuard feature varies depending on your screen direction. If you use the screen in landscape mode, the feature is effective with horizontal angles. If you use the screen in portrait mode, the feature is effective with vertical angles.

-  People can see the screen contents.
-  People can hardly see the screen contents.

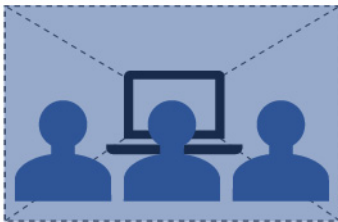

PrivacyGuard disabled

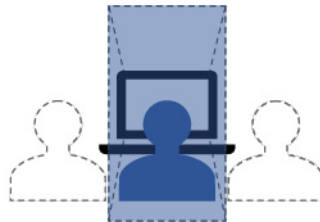

PrivacyGuard enabled and screen in landscape mode

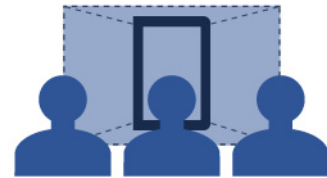

PrivacyGuard enabled and screen in portrait mode

Note: The privacy level of this feature varies depending on the screen brightness level, the contrast ratio, and the physical environment where you are using this feature.



By default, the PrivacyGuard feature is disabled. You can press Fn+D to enable it. You will be prompted by the on-screen display every time the feature is enabled or disabled.

Automatic PrivacyGuard feature for passwords

Note: The automatic PrivacyGuard feature for passwords is not supported on computers with the Linux® operating system.

The PrivacyGuard feature is turned on automatically when you are required to input passwords for password-protected objects, such as encrypted documents, or applications and Web sites that need password authentication. By default, the automatic PrivacyGuard feature for passwords is disabled. You can open Lenovo Vantage to enable it.

Tips on using the PrivacyGuard feature



- To increase privacy level, press  until the desired level is achieved. This is useful in darker environments.
- To decrease privacy level, press  until the desired level is achieved. This is useful in brighter environments.

Use the Intelligent Cooling feature



Intelligent cooling feature helps you adjust fan speed, computer temperature and performance. This feature works in auto mode by default. Press Fn+T to switch between manual mode and auto mode.

When in manual mode

The Intelligent Cooling feature enables your computer to work in the following three modes:

- Quiet mode : Your computer works with the least fan noise.
- Balanced mode : Your computer works with balanced performance and noise.
- Performance mode : Your computer works with the highest performance and normal noise.

When in auto mode

- Auto battery mode  enables your computer to switch between quiet mode or battery mode based on the amount of system activity.
- Auto performance mode  enables your computer to switch between quiet mode, balanced mode or performance mode based on the amount of system activity.

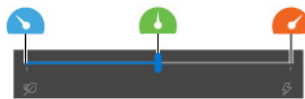

on ac power





on battery power

For computer models installed with Linux operating system, the computer always starts up in performance mode by default without power slider bar for selection. Do the following to switch to the preferred mode:

- Press Fn+L to switch to quiet mode.
- Press Fn+M to switch to balanced mode.
- Press Fn+H to switch to performance mode.

When in auto mode:

The Intelligent Cooling feature enables your computer to work in the following two modes automatically:

- Auto battery mode : Your computer is automatically adjusted to quiet mode or battery mode based on the amount of system activity.
- Auto performance mode : Your computer is automatically adjusted to quiet mode, balanced mode or performance mode based on the amount of system activity.

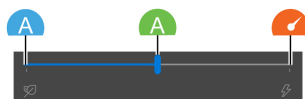

on ac power

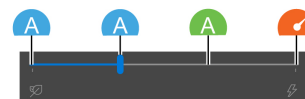

on battery power

Note: The computer models installed with Linux operating system does not support the auto mode of Intelligent Cooling feature.



Use multimedia

Use your computer for business or entertainment with the built-in components (camera, speakers, and audio features) or connected external devices (an external projector, monitor, and HDTV).

Use audio

To enhance your audio experience, connect speakers, headphones, or a headset with a 3.5-mm (0.14-inch), 4-pole plug to the audio connector.

Adjust the speaker volume

Press  to increase the speaker volume or press  to decrease the speaker volume.

Change the sound settings

1. Go to **Control Panel** and view by category.
2. Click **Hardware and Sound** → **Sound**.
3. Change the settings as you prefer.

Connect to an external display

Connect your computer to a projector or a monitor to give presentations or expand your workspace.

Connect to a wired display

1. Connect the external display to an appropriate video connector on your computer, such as the HDMI connector or either of the Thunderbolt 3 connectors (USB-C).
2. Connect the external display to an electrical outlet.
3. Turn on the external display.

If your computer cannot detect the external display, right-click a blank area on the desktop, and then click **Display settings** → **Detect**.

Supported resolution

The following table lists the supported maximum resolution of the external display.



Connect the external display to	Supported resolution
the Thunderbolt 3 connector (USB-C)	Up to 4096 x 2304 pixels / 60 Hz
the HDMI connector	Up to 4096 x 2160 pixels / 30 Hz

Connect to a wireless display

To use a wireless display, ensure that both your computer and the external display support the Miracast® feature.

- Open the Start menu, and then click **Settings** → **Devices** → **Bluetooth & other devices** → **Add Bluetooth or other device**. In the Add a device window, click **Wireless display or dock**. Then, follow the instructions on the screen.
- Click the action center icon  in the Windows notification area and click **Connect**. Select the wireless display and follow the on-screen instructions.

Set the display mode

Press  or  +  and then select a display mode of your preference.

- **PC screen only:** Displays the video output only on your computer screen.

Note: Depending on the situation, you might see **Disconnect**, **PC screen only**, **Computer only**, or **Disconnect projector**.

- **Duplicate:** Displays the same video output on both your computer screen and an external display.
- **Extend:** Extends the video output from your computer display to an external display. You can drag and move items between the two displays.
- **Second screen only:** Displays the video output only on an external display.

Note: Depending on the situation, you might see **Projector only** or **Second screen only**.

If you show programs using DirectDraw or Direct3D® in full-screen mode, only the main display shows the video output.

Change display settings

1. Right-click a blank area on the desktop and select **Display settings**.
2. Select the display that you want to configure.
3. Change display settings of your preference.

You can change the settings for both the computer display and the external display. For example, you can define which one is the main display and which one is the secondary display. You also can change the resolution and orientation.

Note: If you set a higher resolution for the computer display than the external display, only part of the screen can be displayed on the external display.

Get to know YOGA modes (for X1 Yoga Gen 5 only)

Your computer display can be rotated to any angle up to 360 degrees.

Attention: Do not rotate the computer display with too much force, or apply too much force to the upper-right or upper-left corner of the computer display. Otherwise, the computer display or hinges might get damaged.



Your computer features the following four YOGA modes. You can switch among different modes according to your preference.

Note: The keyboard and the pointing devices are automatically disabled in the stand mode, tent mode, and tablet mode. Use the touch screen to control your computer instead.



Notebook mode



Stand mode



Tent mode



Tablet mode

Use ThinkPad Pen Pro (for X1 Yoga Gen 5 only)

The ThinkPad Pen Pro is an electronic pen stored in the pen slot. To use the pen, slide it out of the slot.



Notes:

- The ThinkPad Pen Pro is not waterproof. Keep the pen away from water and excessive moisture.

- To purchase the ThinkPad Pen Pro, go to <https://www.lenovo.com/accessories>.

Use the ThinkPad Pen Pro

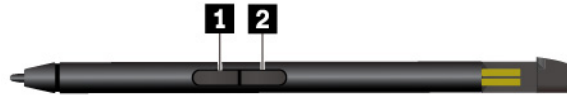

1 Eraser button

2 Click button

You can perform the following operations with the ThinkPad Pen Pro:

- To click or make a selection, tap the display once.
- To double-click, tap twice without pausing.
- To right-click, tap the display and hold the pen there for one second. Alternatively, you can press and hold the click button **2** and tap the display.
- To erase ink, press and hold the eraser button **1**, tap the display, and drag the pen across the ink you want to erase.

Charge the ThinkPad Pen Pro

1. Ensure that your computer is on or in sleep mode.
2. Insert the pen back into the pen slot. The pen is 80% charged in about 15 seconds and 100% charged in about five minutes.



Chapter 3. Explore your computer

Manage power

Use the information in this section to achieve the best balance between performance and power efficiency.

Check the battery status and temperature

Check the battery status

The battery status icon  or  is in the Windows notification area. You can click the icon to check the battery status, view the current power plan, change the power mode, and access battery settings quickly.

Check the battery temperature

Open Lenovo Vantage, and then follow the on-screen instructions to view battery details.

Charge the computer

Use ac power

When the battery power is low, charge your battery by connecting your computer to ac power.

The battery is fully charged in about four to eight hours. If the power adapter shipped with your computer supports the rapid charge function, the battery is 80% charged in about one hour when the computer is turned off. The actual charging time depends on the battery size, the physical environment, and whether you are using the computer.

Battery charging is also affected by the battery temperature. The recommended battery temperature range for charging the battery is between 10°C (50°F) and 35°C (95°F).

Note: To maximize the life of the battery, the computer does not recharge the battery if the remaining power is greater than 95%.

Use P-to-P 2.0 charging function

Both Thunderbolt 3 connectors (USB-C) on the computer feature the Lenovo-unique P-to-P 2.0 charging function. When no ac power is available, this feature enables one computer to supply power to another computer through a USB-C to USB-C cable. When ac power is available for only one computer, this feature enables both computers to get charged by ac power.

Before using the function, ensure that:

- The selected connectors support the P-to-P 2.0 charging function and power delivery function.
- **Always On USB** and **Charge in Battery Mode** are enabled in UEFI BIOS of both computers, so that the function works even when the computers are off or in hibernation mode. To enable **Always On USB** and **Charge in Battery Mode**:
 1. Enter the UEFI BIOS menu. See “Enter the UEFI BIOS menu” on page 49.
 2. Click **Config** → **USB** to enable **Always On USB** and **Charge in Battery Mode**.

To use the function:

- **When no ac power is available:**

The remaining battery power of computer A should be at least 30% and be 3% higher than that of computer B. To check the battery status, see “Check the battery status and temperature” on page 33. Connect the computers to each other with a USB-C to USB-C cable. In this situation, computer A works as the power supply. Once the remaining battery power of computer A is lower than 30%, computer A stops supplying power to computer B.

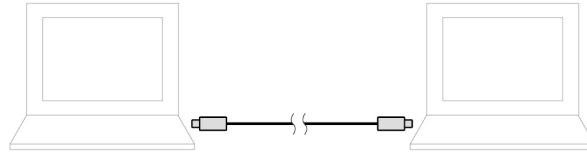

- **When ac power is available:**

Connect the computers to each other with a USB-C to USB-C cable. Connect one computer to ac power. In this situation, ac power works as the power supply and both computers get charged.

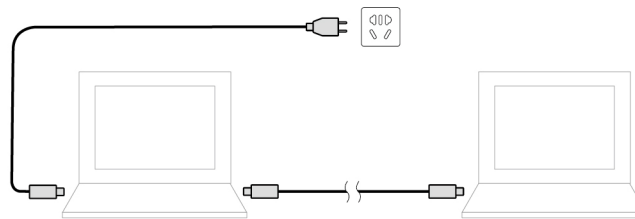

Note: The actual charging speed using the Lenovo-unique P-to-P 2.0 charging function varies depending on many factors, such as the remaining battery power of the computers, the wattage of the ac power adapter, and whether you are using the computers.

Maximize the battery life

- Lower the brightness of the computer display.
- Turn off the wireless features when not in use.
- Use the battery until the charge is depleted.
- Recharge the battery completely before using it.

Set power button behaviors

You can define what the power button does according to your preference. For example, by pressing the power button, you can turn off the computer or put the computer to sleep or hibernation mode.

To change what the power button does:

1. Right-click the battery status icon in the Windows notification area.
2. Click **Power Options** → **Choose what the power buttons do**.
3. Change the settings as you prefer.

Set the power plan

For ENERGY STAR® compliant computers, the following power plan takes effect when your computers have been idle for a specified duration:

Table 1. Default power plan (when plugged into ac power)

<ul style="list-style-type: none">• Turn off the display: After 10 minutes• Put the computer to sleep: After 30 minutes
--

To reset the power plan to achieve the best balance between performance and power saving:

1. Right-click the battery status icon and select **Power Options**.
2. Choose or customize a power plan of your preference.

Transfer data

Quickly share your files using the built-in Bluetooth or NFC technology among devices with the same features.

Connect to a Bluetooth-enabled device

You can connect all types of Bluetooth-enabled devices to your computer, such as a keyboard, a mouse, a smartphone, or speakers. To ensure the connection is successful, place the devices 10 meters (33 feet), at most, from the computer.

1. Turn on Bluetooth on the computer.
 - Click the action center icon  in the Windows notification area. Enable the Bluetooth feature.
 - Open the **Start** menu, and then click **Settings → Devices → Bluetooth & other devices**. Turn on the **Bluetooth** switch.
2. Click **Add Bluetooth or other device → Bluetooth**.
3. Select a Bluetooth device, and then follow the on-screen instructions.

Your Bluetooth-enabled device and computer will automatically connect the next time if the two devices are in range of each other with Bluetooth turned on. You can use Bluetooth for data transfer or remote control and communication.

Set up an NFC connection

If your computer supports NFC, you will see an NFC mark or label  around the trackpad area.

NFC is a high-frequency and short-range wireless communication technology. By using NFC, you can simply tap and connect your computer and another NFC-enabled device over a few centimeters or inches.

Turn on NFC

1. Open the **Start** menu and click **Settings → Network & Internet → Airplane mode**.
2. Turn off the Airplane mode.
3. Turn on the NFC function.

Pair with an NFC card or NFC-enabled smartphone

Before you start, ensure that:

- The card is in NFC Data Exchange Format (NDEF), otherwise the card cannot be detected.
- The smartphone screen is facing upward.

To pair with an NFC card or smartphone:

1. Place the card or smartphone closely near the NFC mark or label area on your computer.
2. Slowly move the card or smartphone around the NFC mark or label until you are prompted that the device has been successfully detected.

Attention: During the data transfer, do not put your computer to sleep mode or lock the smartphone; otherwise, your data might get damaged.

Airplane mode

When the Airplane mode is enabled, all wireless features are disabled.

To enable or disable the Airplane mode:

1. Open the **Start** menu.
2. Click **Settings** → **Network & Internet** → **Airplane mode**.
3. Turn on or turn off the **Airplane mode** switch.

Chapter 4. Accessories

This chapter provides instructions on how to use hardware accessories to expand your computer capabilities.

Purchase options

Lenovo has a number of hardware accessories and upgrades to help expand the capabilities of your computer. Options include memory modules, storage devices, network cards, port replicators or docking stations, batteries, power adapters, keyboards, mice, and more.

To shop at Lenovo, go to <https://www.lenovo.com/accessories>.

Docking station

You can use the following docking stations to extend the capacity of your computer:

- ThinkPad Basic Docking Station
- ThinkPad Pro Docking Station
- ThinkPad Ultra Docking Station

Front view

Note: The following illustration is based on ThinkPad Basic Docking Station. The ThinkPad Pro Docking Station and ThinkPad Ultra Docking Station might look slightly different.

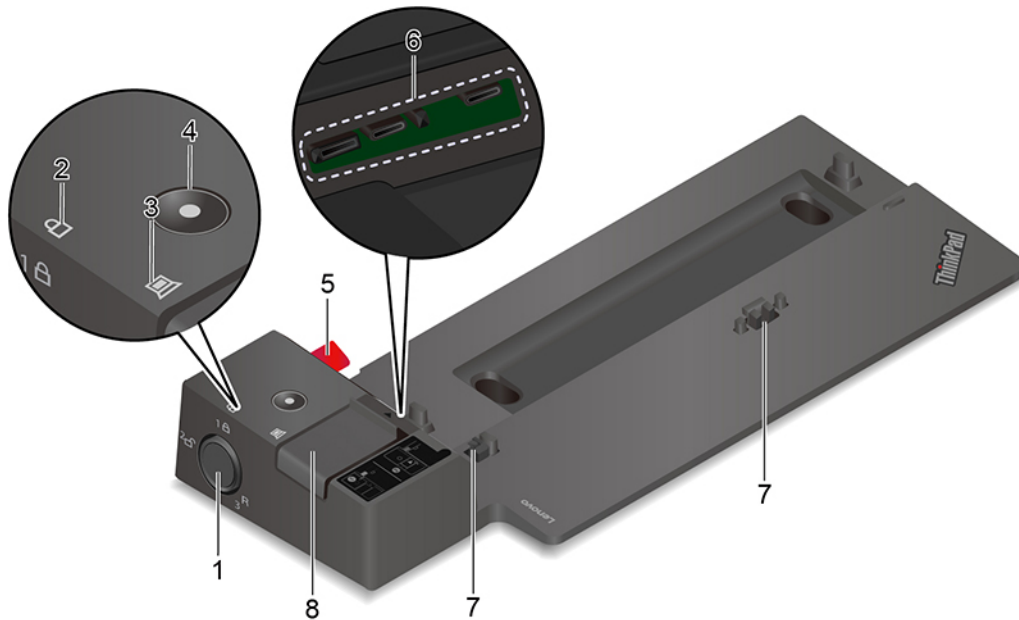

Use the system lock in the following ways:

1. System lock

- Locked position **1A**: The latch is locked, and you cannot attach or detach your computer.
- Unlocked position **2**: The latch is unlocked, and you can attach or detach your computer.
- Removal position **3R**: You can remove the system lock from the system-lock slot.

Note: The ThinkPad Basic Docking Station does not ship with a system lock installed. You can contact Lenovo sales to purchase a system lock with the option part number 4XE0Q56388.

2. Key lock indicator	This indicator turns on when the system lock key is in the locked position.
3. Docking status indicator	This indicator turns on when your computer is successfully connected to the docking station.
4. Power button	Press the power button to turn on or turn off the computer attached to the docking station.
5. Guide post	Use the guide post to help you position your computer properly when you attach the computer to the docking station.
6. Docking-station connector	Connect the computer to the docking station.
7. Hooks	Hold and secure the computer to the docking station.
8. Latch	Slide the latch to attach or detach the computer.

Rear view

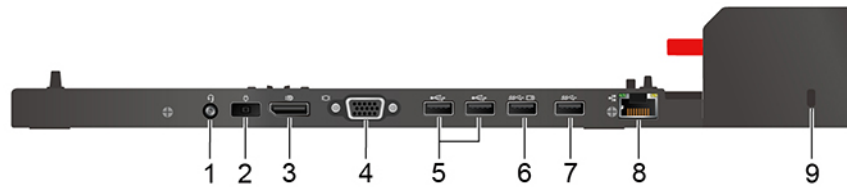

Figure 1. ThinkPad Basic Docking Station

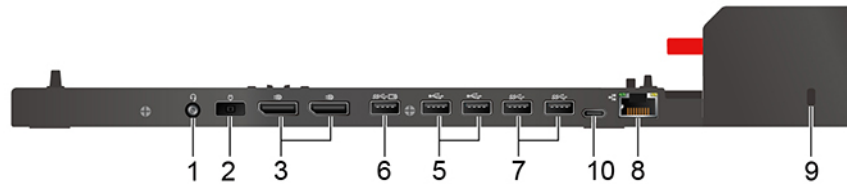

Figure 2. ThinkPad Pro Docking Station

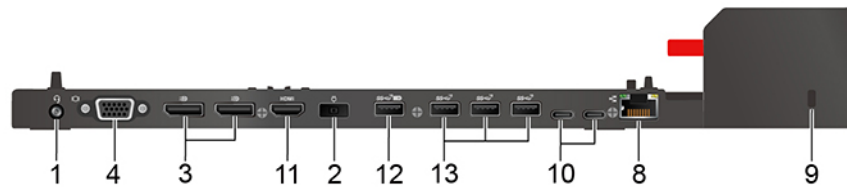

Figure 3. ThinkPad Ultra Docking Station

Connectors	ThinkPad Basic Docking Station	ThinkPad Pro Docking Station	ThinkPad Ultra Docking Station
1. Audio connector	√	√	√
2. ac power connector	√	√	√
3. DisplayPort® connector	√	√	√
4. VGA connector	√		√
5. USB 2.0 connector	√	√	
6. Always On USB 3.2 connector Gen 1	√	√	
7. USB 3.2 connector Gen 1	√	√	
8. Ethernet connector	√	√	√
9. Security-lock slot	√	√	√
10. USB-C connector		√	√
11. HDMI connector			√
12. Always On USB 3.2 connector Gen 2			√
13. USB 3.2 connector Gen 2			√

Note: The security-lock slot supports cable locks that conform to the Kensington MicroSaver lock standards (using T-bar locking technology) or MiniSaver lock standards (using Cleat locking technology).

Attach a docking station

Notes:

- The ThinkPad Basic Docking Station does not ship with a system lock installed. If you do not purchase and install a system lock, skip step 4 and step 7 in the following instruction.
- If you do not connect the docking station to ac power, the computer attached runs on battery power.

1. Connect the docking station to ac power.
2. Disconnect the cables and devices from the left side of the computer.
3. Turn the system lock key to the unlocked position (🔓).

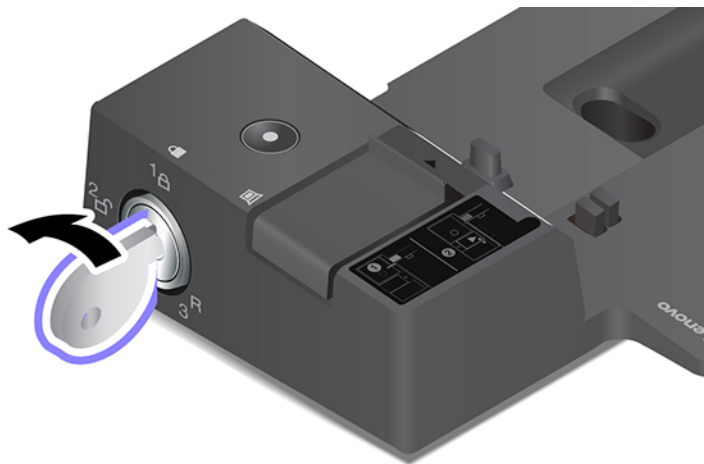

4. Align the top-left corner of the computer with the guide post of the docking station. Attach your computer to the docking station as shown **1** until you hear a click. Slide the latch in the direction as shown **2**.

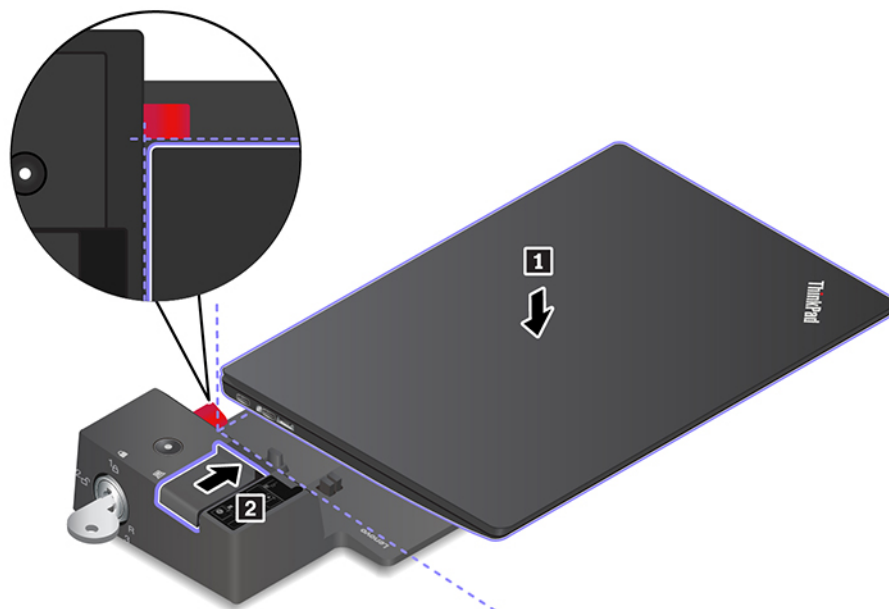

5. Check the docking status indicator. The docking status indicator turns on when the computer is successfully docked.

Note: If the indicator is off, your computer is not attached to the docking station successfully. To solve the problem, detach and reattach the computer.

6. Turn the system lock key to the locked position (1🔒).

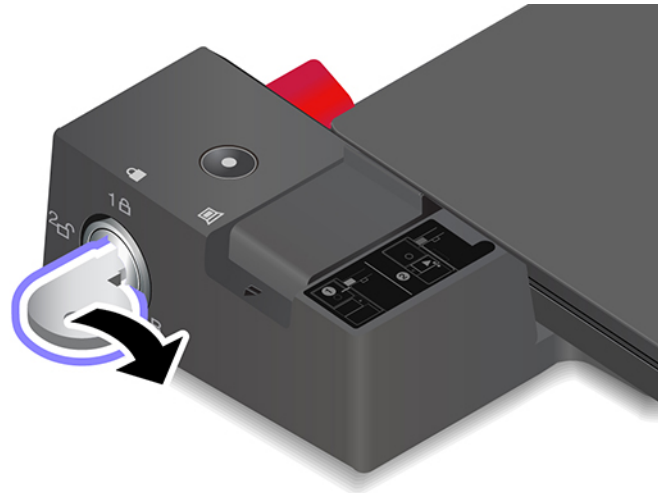

Attention: When the computer is attached to a docking station, always hold the whole assembly when you need to move your computer. Otherwise, the docking station might drop down.

Detach a docking station

Note: The ThinkPad Basic Docking Station does not ship with a system lock installed. If you do not purchase and install a system lock, skip step 1 in the following instruction.

1. Turn the system lock key to the unlocked position (2🔓).



- Slide the latch in the direction as shown **1** to release the computer, and then grasp both sides of the computer to remove it **2**.

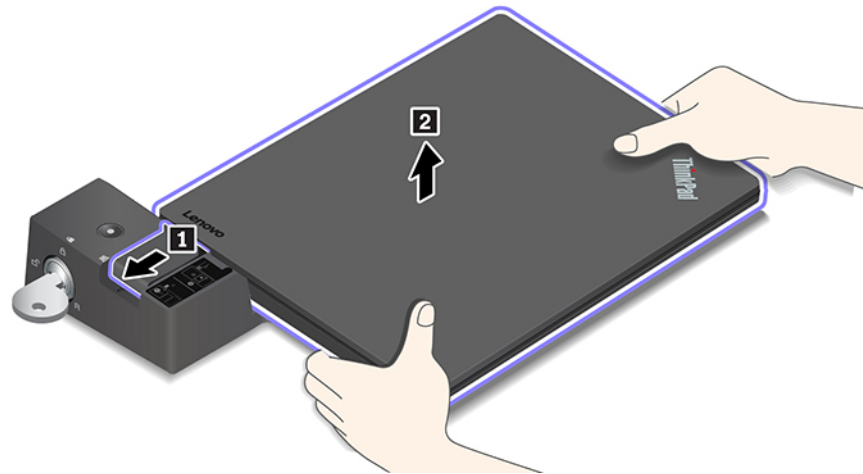

Connect multiple external displays

You can connect multiple external displays to a supported docking station. To ensure that the multiple displays work correctly, observe the following guidelines and connect the external displays to the appropriate connectors.

Docking station	Supported external displays	Video connectors
ThinkPad Basic Docking Station	Up to two	DisplayPort VGA
ThinkPad Pro Docking Station	Up to two	DisplayPort (x2)
ThinkPad Ultra Docking Station	Up to three	DisplayPort (x2) HDMI VGA

Chapter 5. Secure your computer and information

Lock the computer

Lock your computer to a desk, table, or other fixtures through a compatible security cable lock.

Note: The slot supports cable locks that conform to the Kensington MiniSaver® lock standards using Cleat™ locking technology. Do not attempt to use other types of cable locks that use a rotating T-bar™ locking mechanism. You are responsible for evaluating, selecting, and implementing the locking device and security feature. Lenovo makes no comments, judgments, or warranties about the function, quality, or performance of the locking device and security feature. Cable locks for your product are available from Lenovo at <https://www.lenovoquickpick.com/>.

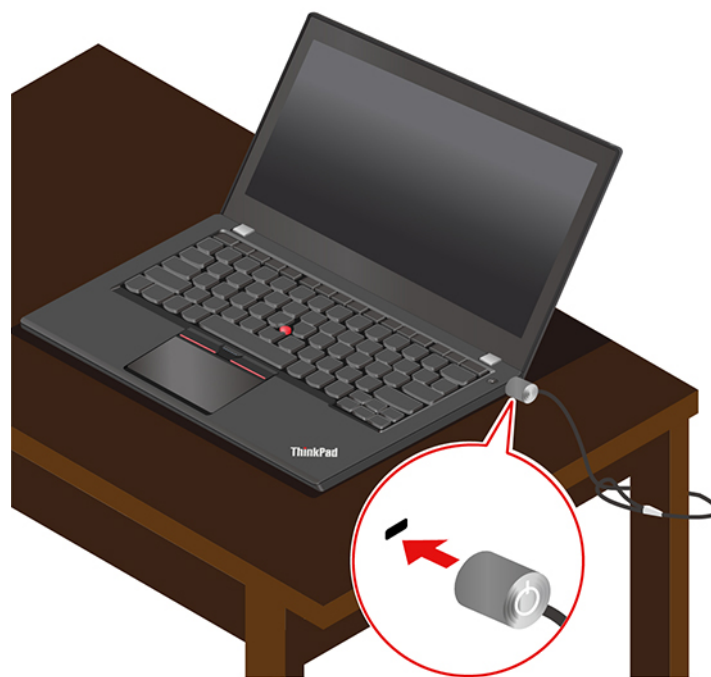

Use passwords

This section introduces types of passwords in UEFI (Unified Extensible Firmware Interface) BIOS (Basic Input/Output System) and how to set, change, and remove a password.

Password types

You can set a power-on password, supervisor password, system management password or hard disk password in UEFI BIOS to prevent unauthorized access to your computer. However, you are not prompted to enter any UEFI BIOS password when your computer resumes from sleep mode.

Power-on password

If you set a power-on password, the icon  is displayed on the screen when you turn on the computer. Enter the correct password to use the computer.