

FCC Test Report

(PART 90S)

Report No.: RF170106C02-5

FCC ID: ZMOL850GL

Test Model: L850-GL

Received Date: Jan. 06, 2017

Test Date: Jan. 11, 2017 ~ Feb. 02, 2017

Issued Date: Feb. 21, 2017

Applicant: Fibocom Wireless Inc.

Address: 5/F, Tower A, Technology Building II, 1057 Nanhai Blvd, Nanshan,
Shenzhen, China

Issued By: Bureau Veritas Consumer Products Services (H.K.) Ltd., Taoyuan Branch

Lab Address: No. 47-2, 14th Ling, Chia Pau Vil., Lin Kou Dist., New Taipei City, Taiwan
(R.O.C)

Test Location: No. 19, Hwa Ya 2nd Rd, Wen Hwa Tsuen, Kwei Shan Hsiang, Taoyuan
Hsien 333, Taiwan, R.O.C.

This report is for your exclusive use. Any copying or replication of this report to or for any other person or entity, or use of our name or trademark, is permitted only with our prior written permission. This report sets forth our findings solely with respect to the test samples identified herein. The results set forth in this report are not indicative or representative of the quality or characteristics of the lot from which a test sample was taken or any similar or identical product unless specifically and expressly noted. Our report includes all of the tests requested by you and the results thereof based upon the information that you provided to us. You have 60 days from date of issuance of this report to notify us of any material error or omission caused by our negligence, provided, however, that such notice shall be in writing and shall specifically address the issue you wish to raise. A failure to raise such issue within the prescribed time shall constitute your unqualified acceptance of the completeness of this report, the tests conducted and the correctness of the report contents. Unless specific mention, the uncertainty of measurement has been explicitly taken into account to declare the compliance or non-compliance to the specification. The report must not be used by the client to claim product certification, approval, or endorsement by TAF or any government agency.

Table of Contents

Release Control Record	3
1 Certificate of Conformity	4
2 Summary of Test Results	5
2.1 Measurement Uncertainty	5
2.2 Test Site and Instruments	6
3 General Information	8
3.1 General Description of EUT	8
3.2 Configuration of System under Test	9
3.2.1 Description of Support Units	9
3.3 Test Mode Applicability and Tested Channel Detail	9
3.4 EUT Operating Conditions	10
3.5 General Description of Applied Standards	10
4 Test Types and Results	11
4.1 Output Power Measurement	11
4.1.1 Limits of Output Power Measurement	11
4.1.2 Test Procedures	11
4.1.3 Test Setup	12
4.1.4 Test Results	13
4.2 Frequency Stability Measurement	16
4.2.1 Limits of Frequency Stability Measurement	16
4.2.2 Test Procedure	16
4.2.3 Test Setup	16
4.2.4 Test Results	17
4.3 Occupied Bandwidth Measurement	21
4.3.1 Test Procedure	21
4.3.2 Test Setup	21
4.3.3 Test Result	22
4.4 Emission Mask Measurement	24
4.4.1 Limits of Band Edge Measurement	24
4.4.2 Test Setup	24
4.4.3 Test Procedures	24
4.4.4 Test Results	25
4.5 Conducted Spurious Emissions	28
4.5.1 Limits of Conducted Spurious Emissions Measurement	28
4.5.2 Test Setup	28
4.5.3 Test Procedure	28
4.5.4 Test Results	29
4.6 Radiated Emission Measurement	32
4.6.1 Limits of Radiated Emission Measurement	32
4.6.2 Test Procedure	32
4.6.3 Deviation from Test Standard	32
4.6.4 Test Setup	32
4.6.5 Test Results	33
5 Pictures of Test Arrangements	39
Appendix – Information on the Testing Laboratories	40

Release Control Record

Issue No.	Description	Date Issued
RF170106C02-5	Original Release	Feb. 21, 2017

1 Certificate of Conformity

Product: LTE module
Brand: Fibocom
Test Model: L850-GL
Sample Status: Identical Prototype
Applicant: Fibocom Wireless Inc.
Test Date: Jan. 11, 2017 ~ Feb. 02, 2017
Standards: FCC Part 90, Subpart S

The above equipment has been tested by **Bureau Veritas Consumer Products Services (H.K.) Ltd., Taoyuan Branch**, and found compliance with the requirement of the above standards. The test record, data evaluation & Equipment Under Test (EUT) configurations represented herein are true and accurate accounts of the measurements of the sample's EMC characteristics under the conditions specified in this report.

Prepared by : Gina Liu , **Date:** Feb. 21, 2017
Gina Liu / Specialist

Approved by : David Huang , **Date:** Feb. 21, 2017
David Huang / Project Engineer

2 Summary of Test Results

Applied Standard: FCC Part 90 & Part 2			
FCC Clause	Test Item	Result	Remarks
2.1046 90.635 (b)	Effective Radiated Power	Pass	Meet the requirement of limit.
2.1055 90.213	Frequency Stability	Pass	Meet the requirement of limit.
2.1049 90.209	Occupied Bandwidth (*)	Pass	Meet the requirement of limit.
2.1051 90.209	Emission Masks	Pass	Meet the requirement of limit.
2.1051 90.691	Conducted Spurious Emissions	Pass	Meet the requirement of limit.
2.1053 90.691	Radiated Spurious Emissions	Pass	Meet the requirement of limit. Minimum passing margin is -33.41 dB at 223.03 MHz.

2.1 Measurement Uncertainty

Where relevant, the following measurement uncertainty levels have been estimated for tests performed on the EUT as specified in CISPR 16-4-2:

Measurement	Frequency	Expanded Uncertainty (k=2) (±)
Conducted Emissions at mains ports	150 kHz ~ 30 MHz	2.44 dB
Radiated Emissions up to 1 GHz	30 MHz ~ 200 MHz	2.93 dB
	200 MHz ~ 1000 MHz	2.95 dB
Radiated Emissions above 1 GHz	1 GHz ~ 18 GHz	2.26 dB
	18 GHz ~ 40 GHz	1.94 dB

2.2 Test Site and Instruments

Description & Manufacturer	Model No.	Serial No.	Date of Calibration	Due Date of Calibration
Test Receiver Agilent Technologies	N9038A	MY52260177	Jun. 21, 2016	Jun. 20, 2017
Spectrum Analyzer Agilent	N9010A	MY52220314	Dec. 16, 2016	Dec. 15, 2017
Spectrum Analyzer ROHDE & SCHWARZ	FSU43	101261	Dec. 13, 2016	Dec. 12, 2017
BILOG Antenna SCHWARZBECK	VULB9168	9168-472	Dec. 26, 2016	Dec. 27, 2017
HORN Antenna SCHWARZBECK	BBHA 9120 D	9120D-969	Dec. 12, 2016	Dec. 13, 2017
Double Ridge Guide Horn Antenna EMCO	3115	5619	Dec. 26, 2016	Dec. 27, 2017
BILOG Antenna SCHWARZBECK	VULB 9168	9168-153	Dec. 12, 2016	Dec. 13, 2017
Agilent Communications Tester-Wireless	8960 Series 10	MY53201073	Jul. 03, 2015	Jul. 02, 2017
Preamplifier EMCI	EMC 012645	980115	Oct. 21, 2016	Oct. 20, 2017
Preamplifier EMCI	EMC 184045	980116	Oct. 21, 2016	Oct. 20, 2017
Preamplifier EMCI	EMC 330H	980112	Oct. 21, 2016	Oct. 20, 2017
Power Meter Anritsu	ML2495A	1232002	Sep. 08, 2016	Sep. 07, 2017
Power Sensor Anritsu	MA2411B	1207325	Sep. 08, 2016	Sep. 07, 2017
RF signal cable HUBER+SUHNNER	SUCOFLEX 104	309219/4 2950114	Oct. 21, 2016	Oct. 20, 2017
RF signal cable HUBER+SUHNNER	SUCOFLEX 104	250130/4	Oct. 21, 2016	Oct. 20, 2017
RF Coaxial Cable Worken	8D-FB	Cable-Ch10-01	Oct. 21, 2016	Oct. 20, 2017
Software BV ADT	E3 6.120103	NA	NA	NA
Antenna Tower MF	MFA-440H	NA	NA	NA
Turn Table MF	MFT-201SS	NA	NA	NA
Antenna Tower & Turn Table Controller MF	MF-7802	NA	NA	NA
Radio Communication Analyzer	MT8820C	6201300640	Aug. 10, 2015	Aug. 09, 2017
Temperature & Humidity Chamber	GTH-120-40-CP-A R	MAA1306-019	Sep. 02, 2016	Sep. 01, 2017
DC Power Supply Topward	33010D	807748	Oct. 25, 2016	Oct. 24, 2018
Digital Multimeter Fluke	87-III	70360742	Jul. 01, 2016	Jun. 30, 2017

- Note:
1. The calibration interval of the above test instruments is 12 / 24 months and the calibrations are traceable to NML/ROC and NIST/USA.
 2. The test was performed in HwaYa Chamber 10.
 3. The horn antenna and preamplifier (model: EMC 184045) are used only for the measurement of emission frequency above 1 GHz if tested.
 4. The FCC Site Registration No. is 690701.
 5. The IC Site Registration No. is IC7450F-10.

3 General Information

3.1 General Description of EUT

Product	LTE module	
Brand	Fibocom	
Test Model	L850-GL	
Status of EUT	Identical Prototype	
Power Supply Rating	3.3 Vdc (from Host Equipment)	
Modulation Type	LTE	QPSK, 16QAM
Frequency Range	LTE Band 26 (Channel Bandwidth: 1.4 MHz)	814.7 ~ 823.3 MHz
	LTE Band 26 (Channel Bandwidth: 3 MHz)	815.5 ~ 822.5 MHz
	LTE Band 26 (Channel Bandwidth: 5 MHz)	816.5 ~ 821.5 MHz
	LTE Band 26 (Channel Bandwidth: 10 MHz)	819 MHz
Emission Designator	LTE Band 26 (Channel Bandwidth: 1.4 MHz)	1M09W7D
	LTE Band 26 (Channel Bandwidth: 3 MHz)	2M70G7D
	LTE Band 26 (Channel Bandwidth: 5 MHz)	4M50W7D
	LTE Band 26 (Channel Bandwidth: 10 MHz)	9M00G7D
Max. ERP Power	LTE Band 26 (Channel Bandwidth: 1.4 MHz)	81.47 mW
	LTE Band 26 (Channel Bandwidth: 3 MHz)	86.70 mW
	LTE Band 26 (Channel Bandwidth: 5 MHz)	94.84 mW
	LTE Band 26 (Channel Bandwidth: 10 MHz)	98.63 mW
Antenna Type	External Antenna	
Accessory Device	Refer to Note as below	
Data Cable Supplied	Refer to Note as below	

Note:

1. The above EUT information is declared by manufacturer and for more detailed features description, please refer to the manufacturer's specifications or user's manual.

3.2 Configuration of System under Test

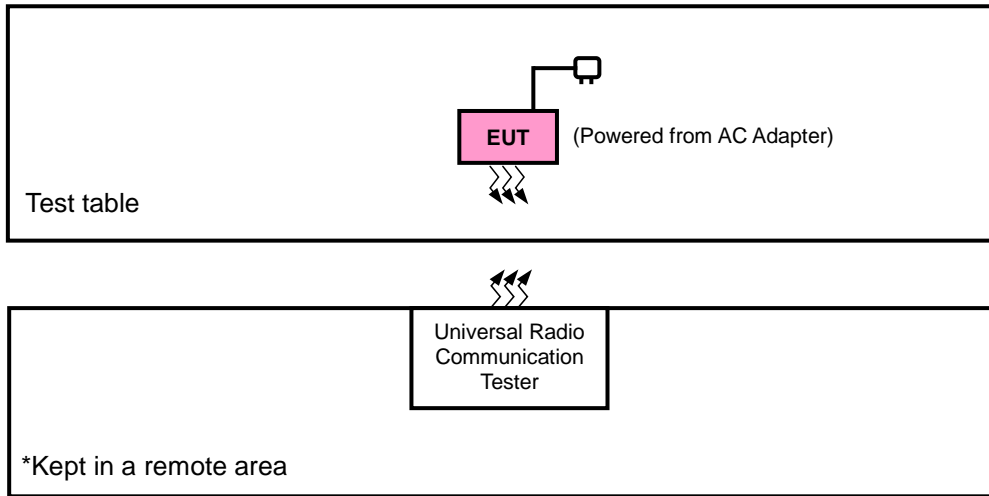

3.2.1 Description of Support Units

The EUT has been tested as an independent unit together with other necessary accessories or support units.

3.3 Test Mode Applicability and Tested Channel Detail

Pre-Scan has been conducted to determine the worst-case mode from all possible combinations between available modulations, data rates, XYZ axis, and antenna ports

The worst case was found when positioned as the table below. Following channel(s) was (were) selected for the final test as listed below:

Band	ERP	Radiated Emission
LTE Band 26	X-plane	Z-axis

LTE Band 26

EUT Configure Mode	Test Item	Available Channel	Tested Channel	Channel Bandwidth	Modulation	Mode
-	ERP	26697 to 26783	26697, 26740, 26783	1.4 MHz	QPSK, 16QAM	1 RB / 2 RB Offset
		26705 to 26775	26705, 26740, 26775	3 MHz	QPSK, 16QAM	1 RB / 7 RB Offset
		26715 to 26765	26715, 26740, 26765	5 MHz	QPSK, 16QAM	1 RB / 12 RB Offset
		26740	26740	10 MHz	QPSK, 16QAM	1 RB / 49 RB Offset
-	Frequency Stability	26697 to 26783	26697, 26783	1.4 MHz	QPSK	1 RB / 2 RB Offset
		26705 to 26775	26705, 26775	3 MHz	QPSK	1 RB / 7 RB Offset
		26715 to 26765	26715, 26765	5 MHz	QPSK	1 RB / 12 RB Offset
		26740	26740	10 MHz	QPSK	1 RB / 49 RB Offset
-	Occupied Bandwidth	26697 to 26783	26697, 26740, 26783	1.4 MHz	QPSK, 16QAM	6 RB / 0 RB Offset
		26705 to 26775	26705, 26740, 26775	3 MHz	QPSK, 16QAM	15 RB / 0 RB Offset
		26715 to 26765	26715, 26740, 26765	5 MHz	QPSK, 16QAM	25 RB / 0 RB Offset
		26740	26740	10 MHz	QPSK, 16QAM	50 RB / 0 RB Offset

EUT Configure Mode	Test Item	Available Channel	Tested Channel	Channel Bandwidth	Modulation	Mode
-	Emission Mask	26697 to 26783	26697, 26740, 26783	1.4 MHz	QPSK, 16QAM	6 RB / 0 RB Offset
		26705 to 26775	26705, 26740, 26775	3 MHz	QPSK, 16QAM	15 RB / 0 RB Offset
		26715 to 26765	26715, 26740, 26765	5 MHz	QPSK, 16QAM	25 RB / 0 RB Offset
		26740	26740	10 MHz	QPSK, 16QAM	50 RB / 0 RB Offset
-	Conducted Emission	26697 to 26783	26697, 26740, 26783	1.4 MHz	QPSK	1 RB / 0 RB Offset
		26705 to 26775	26705, 26740, 26775	3 MHz	QPSK	1 RB / 0 RB Offset
		26715 to 26765	26715, 26740, 26765	5 MHz	QPSK	1 RB / 0 RB Offset
		26740	26740	10 MHz	QPSK	1 RB / 0 RB Offset
-	Radiated Emission	26740	26740	10 MHz	QPSK	1 RB / 49 RB Offset

Note: This device was tested under all bandwidths, RB configurations and modulations. The worst case was found in QPSK modulation.

Test Condition:

Test Item	Environmental Conditions	Input Power	Tested By
ERP	25 deg. C, 65 % RH	3.3 Vdc	Getaz Yang
Frequency Stability	25 deg. C, 65 % RH	3.3 Vdc	Carlos Chen
Occupied Bandwidth	25 deg. C, 65 % RH	3.3 Vdc	Carlos Chen
Band Edge	25 deg. C, 65 % RH	3.3 Vdc	Carlos Chen
Peak to Average Ratio	25 deg. C, 65 % RH	3.3 Vdc	Carlos Chen
Condcudeted Emission	25 deg. C, 65 % RH	3.3 Vdc	Carlos Chen
Radiated Emission	25 deg. C, 65 % RH	120 Vac, 60 Hz	Getaz Yang

3.4 EUT Operating Conditions

The EUT makes a call to the communication simulator. The communication simulator station system controlled a EUT to export maximum output power under transmission mode and specific channel frequency

3.5 General Description of Applied Standards

The EUT is a RF Product. According to the specifications of the manufacturer, it must comply with the requirements of the following standards:

FCC 47 CFR Part 2

FCC 47 CFR Part 90

ANSI/TIA/EIA-603-D 2010

Note: All test items have been performed and recorded as per the above standards.

4 Test Types and Results

4.1 Output Power Measurement

4.1.1 Limits of Output Power Measurement

Mobile / Portable station are limited to 100 watts e.r.p.

4.1.2 Test Procedures

EIRP / ERP Measurement:

- a. All measurements were done at low, middle and high operational frequency range. RBW and VBW is 5 MHz for CDMA and 10 MHz for LTE mode.
- b. Substitution method is used for E.I.R.P measurement. In the semi-anechoic chamber, EUT placed on the 0.8 m height of Turn Table, rotated the table around 360 degrees to search the maximum radiation power and receiver antenna shall be rotated vertical and horizontal polarization and moved height from 1 m to 4 m to find the maximum polar radiated power. The "Read Value" is the spectrum reading the maximum power value.
- c. The substitution horn antenna is substituted for EUT at the same position and signals generator export the CW signal to the substitution antenna via a tx cable. Rotated the Turn Table and moved receiving antenna to find the maximum radiation power. Adjust output power level of S.G to get a Value of spectrum reading equal to "Read Value" of step b. Record the power level of S.G.
- d. $EIRP = \text{Output power level of S.G} - \text{TX cable loss} + \text{Antenna gain of substitution horn}$. E.R.P power can be calculated form E.I.R.P power by subtracting the gain of dipole, $E.R.P \text{ power} = E.I.P.R \text{ power} - 2.15 \text{ dBi}$.

Conducted Power Measurement:

- a. The EUT was set up for the maximum power with LTE link data modulation and link up with simulator.
- b. Set the EUT to transmit under low, middle and high channel and record the power level shown on simulator.

4.1.3 Test Setup

EIRP / ERP Measurement:

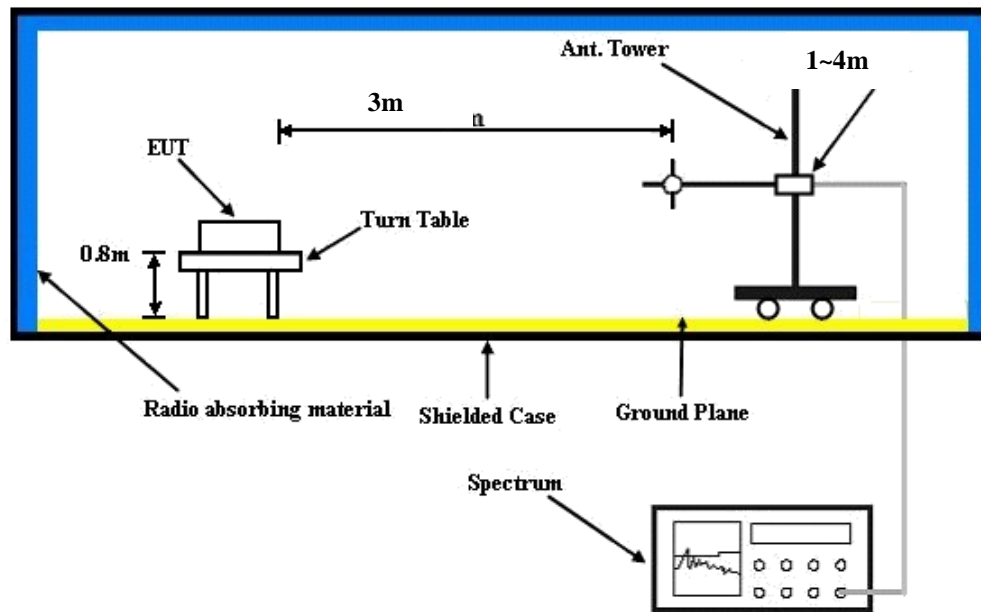

For the actual test configuration, please refer to the attached file (Test Setup Photo).

Conducted Power Measurement:



4.1.4 Test Results

Conducted Output Power (dBm)

Band / BW	RB Size	RB Offset	QPSK			3GPP MPR (dB)	16QAM			3GPP MPR (dB)
			Low Ch 26697	Mid Ch 26740	High Ch 26783		Low Ch 26697	Mid Ch 26740	High Ch 26783	
			814.7 MHz	819.0 MHz	823.3 MHz		814.7 MHz	819.0 MHz	823.3 MHz	
26 / 1.4M	1	0	22.39	22.21	22.01	0	21.36	21.14	20.99	1
	1	2	22.26	22.10	21.88	0	21.25	21.04	20.85	1
	1	5	22.15	21.92	21.66	0	21.04	20.88	20.55	1
	3	0	22.35	22.17	21.98	0	21.32	21.14	20.94	1
	3	1	22.17	21.97	21.87	0	21.17	20.99	20.70	1
	3	3	22.13	21.94	21.62	0	21.01	20.80	20.53	1
	6	0	21.22	21.17	20.93	1	20.12	19.93	19.75	2

Band / BW	RB Size	RB Offset	QPSK			3GPP MPR (dB)	16QAM			3GPP MPR (dB)
			Low Ch 26705	Mid Ch 26740	High Ch 26775		Low Ch 26705	Mid Ch 26740	High Ch 26775	
			815.5 MHz	819.0 MHz	822.5 MHz		815.5 MHz	819.0 MHz	822.5 MHz	
26 / 3M	1	0	22.45	22.30	22.13	0	21.36	21.28	21.04	1
	1	7	22.32	22.18	21.98	0	21.24	21.06	20.99	1
	1	14	22.16	22.02	21.82	0	21.12	21.00	20.79	1
	8	0	21.41	21.24	21.04	1	20.21	20.15	19.96	2
	8	3	21.26	21.04	20.84	1	20.23	20.00	19.79	2
	8	7	21.14	21.01	20.79	1	20.02	19.91	19.66	2
	15	0	21.44	21.14	20.91	1	20.26	20.09	19.98	2

Band / BW	RB Size	RB Offset	QPSK			3GPP MPR (dB)	16QAM			3GPP MPR (dB)
			Low Ch 26715	Mid Ch 26740	High Ch 26765		Low Ch 26715	Mid Ch 26740	High Ch 26765	
			816.5 MHz	819.0 MHz	821.5 MHz		816.5 MHz	819.0 MHz	821.5 MHz	
26 / 5M	1	0	22.59	22.43	22.25	0	21.58	21.34	21.21	1
	1	12	22.49	22.29	22.15	0	21.48	21.30	21.06	1
	1	24	22.33	22.16	21.97	0	21.20	21.07	20.88	1
	12	0	21.51	21.42	21.22	1	20.35	20.31	20.05	2
	12	6	21.36	21.30	21.13	1	20.29	20.27	20.03	2
	12	13	21.22	21.08	20.85	1	20.11	20.09	19.92	2
	25	0	21.43	21.34	21.21	1	20.47	20.34	20.15	2

Band / BW	RB Size	RB Offset	QPSK	3GPP MPR (dB)	16QAM	3GPP MPR (dB)
			Mid Ch 26740		Mid Ch 26740	
			819.0 MHz		819.0 MHz	
26 / 10M	1	0	22.73	0	21.72	1
	1	24	22.61	0	21.59	1
	1	49	22.46	0	21.34	1
	25	0	21.60	1	20.51	2
	25	12	21.51	1	20.49	2
	25	25	21.22	1	20.23	2
	50	0	21.68	1	20.55	2

ERP Power (dBm)

LTE Band 26							
Channel Bandwidth: 1.4 MHz / QPSK							
Plane	Channel	Frequency (MHz)	LVL (dBm)	Correction Factor (dB)	ERP (dBm)	ERP (mW)	Polarization (H/V)
X	26697	814.7	-10.99	32.01	18.87	77.09	H
	26740	819.0	-10.85	32.11	19.11	81.47	
	26783	823.3	-11.35	32.32	18.82	76.21	
	26697	814.7	-18.98	32.54	11.41	13.84	V
	26740	819.0	-18.85	32.51	11.51	14.16	
	26783	823.3	-19.03	32.51	11.33	13.58	
Channel Bandwidth: 1.4 MHz / 16QAM							
X	26697	814.7	-11.88	32.01	17.98	62.81	H
	26740	819.0	-11.78	32.11	18.18	65.77	
	26783	823.3	-12.48	32.32	17.69	58.75	
	26697	814.7	-20.02	32.54	10.37	10.89	V
	26740	819.0	-19.94	32.51	10.42	11.02	
	26783	823.3	-20.18	32.51	10.18	10.42	

LTE Band 26							
Channel Bandwidth: 3 MHz / QPSK							
Plane	Channel	Frequency (MHz)	LVL (dBm)	Correction Factor (dB)	ERP (dBm)	ERP (mW)	Polarization (H/V)
X	26705	815.5	-10.68	32.02	19.19	82.99	H
	26740	819	-10.58	32.11	19.38	86.70	
	26775	822.5	-10.99	32.18	19.04	80.17	
	26705	815.5	-18.78	32.5	11.57	14.35	V
	26740	819	-18.68	32.51	11.68	14.72	
	26775	822.5	-18.84	32.47	11.48	14.06	
Channel Bandwidth: 3 MHz / 16QAM							
X	26705	815.5	-11.79	32.02	18.08	64.27	H
	26740	819.0	-11.65	32.11	18.31	67.76	
	26775	822.5	-12.05	32.18	17.98	62.81	
	26705	815.5	-19.89	32.5	10.46	11.12	V
	26740	819.0	-19.75	32.51	10.61	11.51	
	26775	822.5	-19.94	32.47	10.38	10.91	

LTE Band 26							
Channel Bandwidth: 5 MHz / QPSK							
Plane	Channel	Frequency (MHz)	LVL (dBm)	Correction Factor (dB)	ERP (dBm)	ERP (mW)	Polarization (H/V)
X	26715	816.5	-10.35	32.04	19.54	89.95	H
	26740	819.0	-10.19	32.11	19.77	94.84	
	26765	821.5	-10.69	31.79	18.95	78.52	
	26715	816.5	-18.47	32.52	11.90	15.49	V
	26740	819.0	-18.24	32.51	12.12	16.29	
	26765	821.5	-18.55	32.17	11.47	14.03	
Channel Bandwidth: 5 MHz / 16QAM							
X	26715	816.5	-11.49	32.04	18.40	69.18	H
	26740	819.0	-11.33	32.11	18.63	72.95	
	26765	821.5	-11.82	31.79	17.82	60.53	
	26715	816.5	-19.56	32.52	10.81	12.05	V
	26740	819.0	-19.48	32.51	10.88	12.25	
	26765	821.5	-19.62	32.17	10.40	10.96	

LTE Band 26							
Channel Bandwidth: 10 MHz / QPSK							
Plane	Channel	Frequency (MHz)	LVL (dBm)	Correction Factor (dB)	ERP (dBm)	ERP (mW)	Polarization (H/V)
X	26740	819.0	-10.02	32.11	19.94	98.63	H
	26740	819.0	-17.85	32.51	12.51	17.82	V
Channel Bandwidth: 10 MHz / 16QAM							
X	26740	819.0	-11.26	32.11	18.70	74.13	H
	26740	819.0	-18.93	32.51	11.43	13.90	V

4.2 Frequency Stability Measurement

4.2.1 Limits of Frequency Stability Measurement

1.5 ppm is for base and fixed station. 2.5 ppm is for mobile station.

4.2.2 Test Procedure

- Device is placed at the oven room. The oven room could control the temperatures and humidity. Power warm up is at least 15 min and power applied should perform before recording frequency error.
- EUT is connected the external power supply to control the DC input power. The test voltage range is from minimum to maximum working voltage. Each step shall be record the frequency error rate.
- The temperature range step is 10 degrees in this test items. All temperature levels shall be hold the ± 0.5 °C during the measurement testing. The each temperature step shall be at least 0.5 hours, consider the EUT could be test under the stability condition.

NOTE: The frequency error was recorded frequency error from the communication simulator.

4.2.3 Test Setup

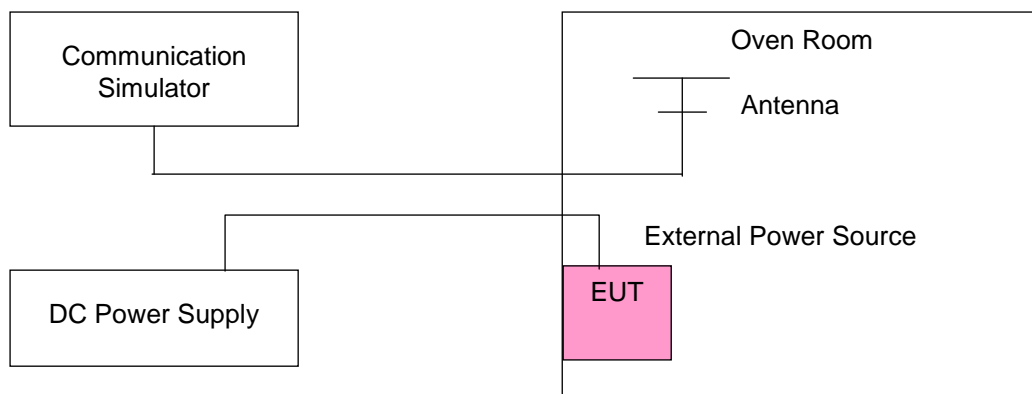

4.2.4 Test Results

Frequency Error vs. Voltage

Voltage (Volts)	LTE Band 26				Limit (ppm)
	Channel Bandwidth: 1.4 MHz				
	Low Channel		High Channel		
	Frequency (MHz)	Frequency Error (ppm)	Frequency (MHz)	Frequency Error (ppm)	
3.3	815.500001	0.002	822.500002	0.002	2.5
3.14	815.500001	0.002	822.500002	0.002	2.5
4.4	815.500004	0.004	822.500004	0.005	2.5

Note: The applicant defined the normal working voltage of the battery is from 3.14 Vdc to 4.4 Vdc.

Frequency Error vs. Temperature

Temp. (°C)	LTE Band 26				Limit (ppm)
	Channel Bandwidth: 1.4 MHz				
	Low Channel		High Channel		
	Frequency (MHz)	Frequency Error (ppm)	Frequency (MHz)	Frequency Error (ppm)	
-20	816.500002	0.002	821.500003	0.003	2.5
-10	816.500002	0.003	821.500001	0.001	2.5
0	816.500001	0.002	821.500002	0.003	2.5
10	816.500004	0.005	821.500004	0.005	2.5
20	816.499997	-0.004	821.499997	-0.004	2.5
30	816.499998	-0.003	821.499997	-0.004	2.5
40	816.499997	-0.004	821.499997	-0.004	2.5
50	816.499997	-0.004	821.499997	-0.003	2.5
55	816.499996	-0.005	821.499997	-0.004	2.5

Frequency Error vs. Voltage

Voltage (Volts)	LTE Band 26				Limit (ppm)
	Channel Bandwidth: 3 MHz				
	Low Channel		High Channel		
	Frequency (MHz)	Frequency Error (ppm)	Frequency (MHz)	Frequency Error (ppm)	
3.3	815.500001	0.002	822.500002	0.002	2.5
3.14	815.500001	0.002	822.500002	0.002	2.5
4.4	815.500004	0.004	822.500004	0.005	2.5

Note: The applicant defined the normal working voltage of the battery is from 3.14 Vdc to 4.4 Vdc.

Frequency Error vs. Temperature

Temp. (°C)	LTE Band 26				Limit (ppm)
	Channel Bandwidth: 3 MHz				
	Low Channel		High Channel		
	Frequency (MHz)	Frequency Error (ppm)	Frequency (MHz)	Frequency Error (ppm)	
-20	815.500001	0.002	822.500004	0.004	2.5
-10	815.500003	0.004	822.500004	0.004	2.5
0	815.500002	0.003	822.500003	0.003	2.5
10	815.500003	0.004	822.500004	0.005	2.5
20	815.499999	-0.002	822.499996	-0.005	2.5
30	815.499999	-0.002	822.499997	-0.003	2.5
40	815.499997	-0.004	822.499997	-0.004	2.5
50	815.499999	-0.002	822.499998	-0.003	2.5
55	815.499996	-0.005	822.499998	-0.003	2.5

Frequency Error vs. Voltage

Voltage (Volts)	LTE Band 26				Limit (ppm)
	Channel Bandwidth: 5 MHz				
	Low Channel		High Channel		
	Frequency (MHz)	Frequency Error (ppm)	Frequency (MHz)	Frequency Error (ppm)	
3.3	816.500001	0.001	821.500003	0.004	2.5
3.14	816.500002	0.002	821.500001	0.001	2.5
4.4	816.500001	0.002	821.500002	0.003	2.5

Note: The applicant defined the normal working voltage of the battery is from 3.14 Vdc to 4.4 Vdc.

Frequency Error vs. Temperature

Temp. (°C)	LTE Band 26				Limit (ppm)
	Channel Bandwidth: 5 MHz				
	Low Channel		High Channel		
	Frequency (MHz)	Frequency Error (ppm)	Frequency (MHz)	Frequency Error (ppm)	
-20	816.500002	0.002	821.500003	0.003	2.5
-10	816.500002	0.003	821.500001	0.001	2.5
0	816.500001	0.002	821.500002	0.003	2.5
10	816.500004	0.005	821.500004	0.005	2.5
20	816.499997	-0.004	821.499997	-0.004	2.5
30	816.499998	-0.003	821.499997	-0.004	2.5
40	816.499997	-0.004	821.499997	-0.004	2.5
50	816.499997	-0.004	821.499997	-0.003	2.5
55	816.499996	-0.005	821.499997	-0.004	2.5

Frequency Error vs. Voltage

Voltage (Volts)	LTE Band 26		Limit (ppm)
	Channel Bandwidth: 10 MHz		
	Low Channel		
	Frequency (MHz)	Frequency Error (ppm)	
3.3	819.000004	0.004	2.5
3.14	819.000002	0.003	2.5
4.4	819.000004	0.004	2.5

Note: The applicant defined the normal working voltage of the battery is from 3.14 Vdc to 4.4 Vdc.

Frequency Error vs. Temperature

Temp. (°C)	LTE Band 26		Limit (ppm)
	Channel Bandwidth: 10 MHz		
	Low Channel		
	Frequency (MHz)	Frequency Error (ppm)	
-20	819.000004	0.005	2.5
-10	819.000004	0.005	2.5
0	819.000003	0.004	2.5
10	819.000004	0.004	2.5
20	818.999997	-0.003	2.5
30	818.999998	-0.002	2.5
40	818.999997	-0.004	2.5
50	818.999999	-0.001	2.5
55	818.999998	-0.003	2.5

4.3 Occupied Bandwidth Measurement

4.3.1 Test Procedure

The EUT makes a call to the communication simulator. All measurements were done at low, middle and high operational frequency range. The communication simulator station system controlled a EUT to export maximum output power under transmission mode and specific channel frequency. Use OBW measurement function of Spectrum analyzer to measure 99 % occupied bandwidth.

4.3.2 Test Setup

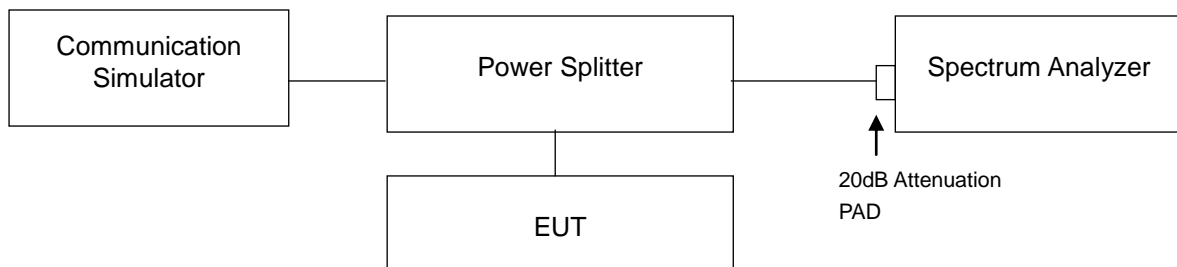

4.3.3 Test Result

LTE Band 26							
Channel Bandwidth: 1.4 MHz				Channel Bandwidth: 3 MHz			
Channel	Frequency (MHz)	99 % Occupied Bandwidth (MHz)		Channel	Frequency (MHz)	99 % Occupied Bandwidth (MHz)	
		QPSK	16QAM			QPSK	16QAM
26697	814.7	1.09	1.10	26705	815.5	2.70	2.70
26740	819.0	1.09	1.09	26740	819.0	2.70	2.70
26783	823.3	1.09	1.09	26775	822.5	2.70	2.70

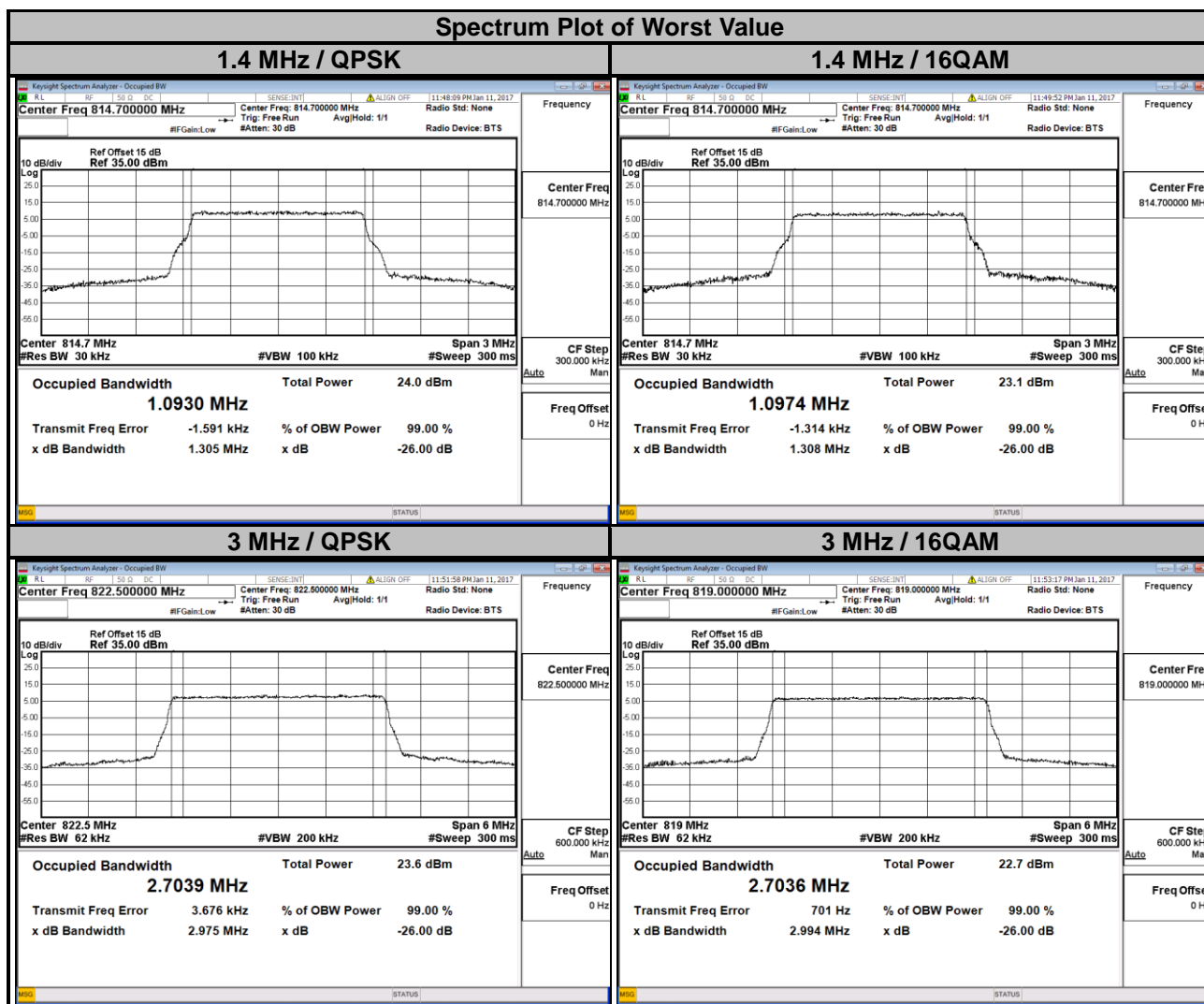

LTE Band 26							
Channel Bandwidth: 5 MHz				Channel Bandwidth: 10 MHz			
Channel	Frequency (MHz)	99 % Occupied Bandwidth (MHz)		Channel	Frequency (MHz)	99 % Occupied Bandwidth (MHz)	
		QPSK	16QAM			QPSK	16QAM
26715	816.5	4.50	4.50	26740	819.0	9.01	9.00
26740	819.0	4.50	4.50				
26765	821.5	4.50	4.50				

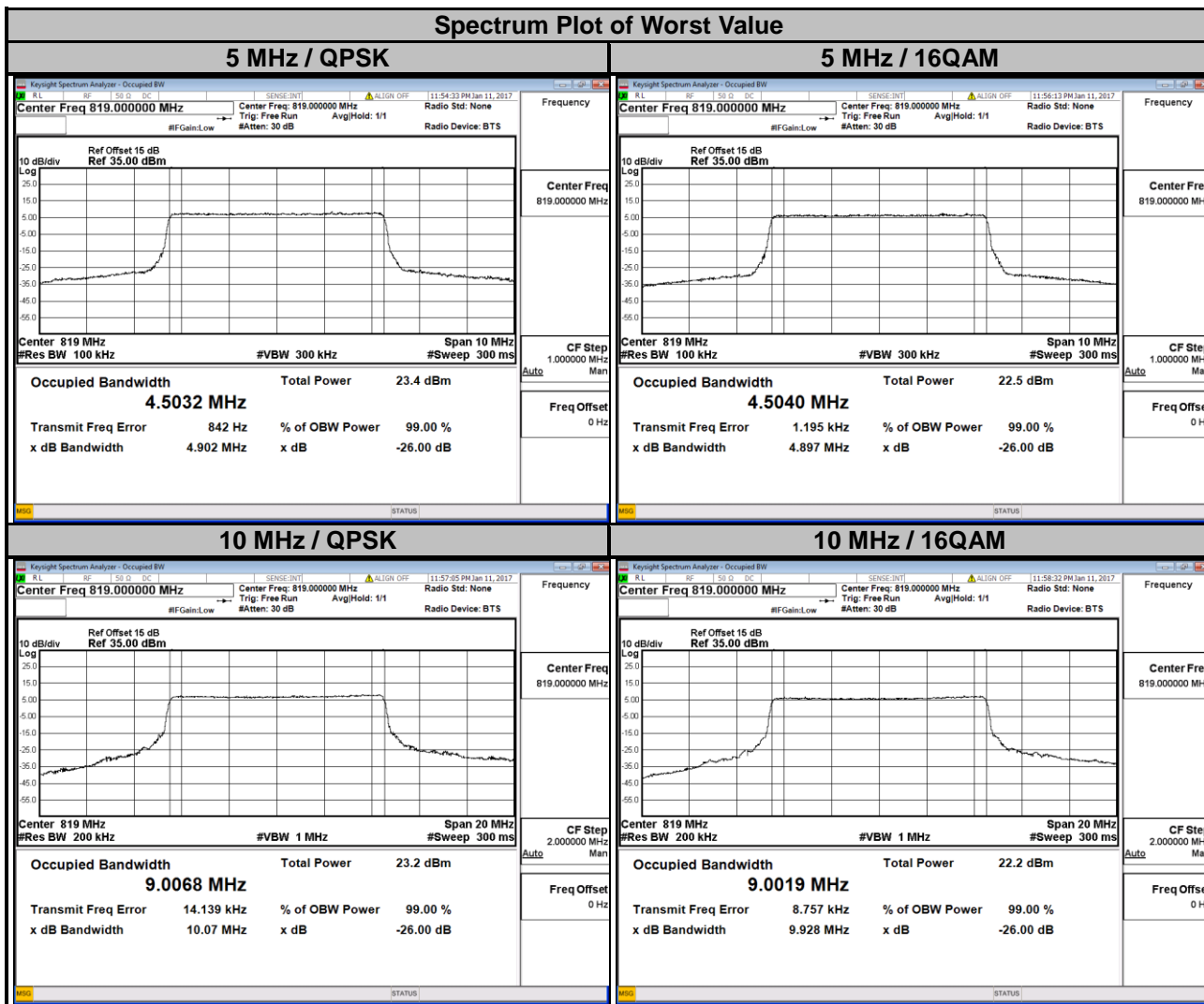

4.4 Emission Mask Measurement

4.4.1 Limits of Band Edge Measurement

According to FCC part 90.691 shall be tested the emission mask. For any frequency removed from the EA licensee's frequency block by up to and including 37.5 kHz, the power of any emission shall be attenuated below the transmitter power (P) in watts by at least $116 \text{ Log}_{10}(f/6.1)$ decibels or $50+10\text{Log}_{10}(P)$ decibels or 80 decibels, whichever is the lesser attenuation, where f is the frequency removed from the center of the outer channel in the block in kilohertz and where f is greater than 12.5 kHz.

4.4.2 Test Setup

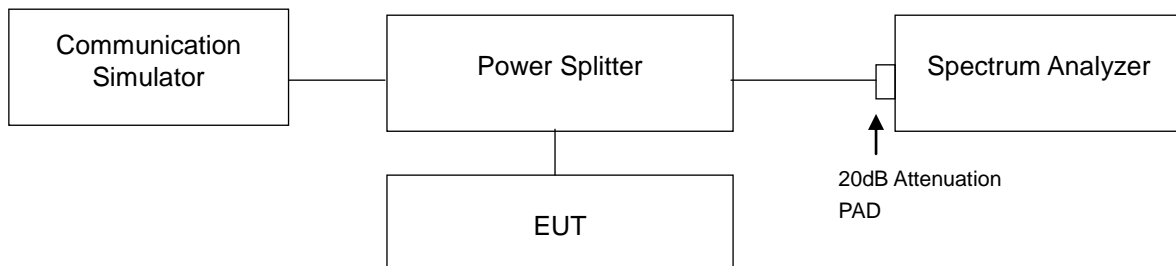

4.4.3 Test Procedures

- a. The measurement used the power splitter via EUT RF power connector between simulation base station and spectrum analyzer.
- b. Record the test plot.

4.4.4 Test Results

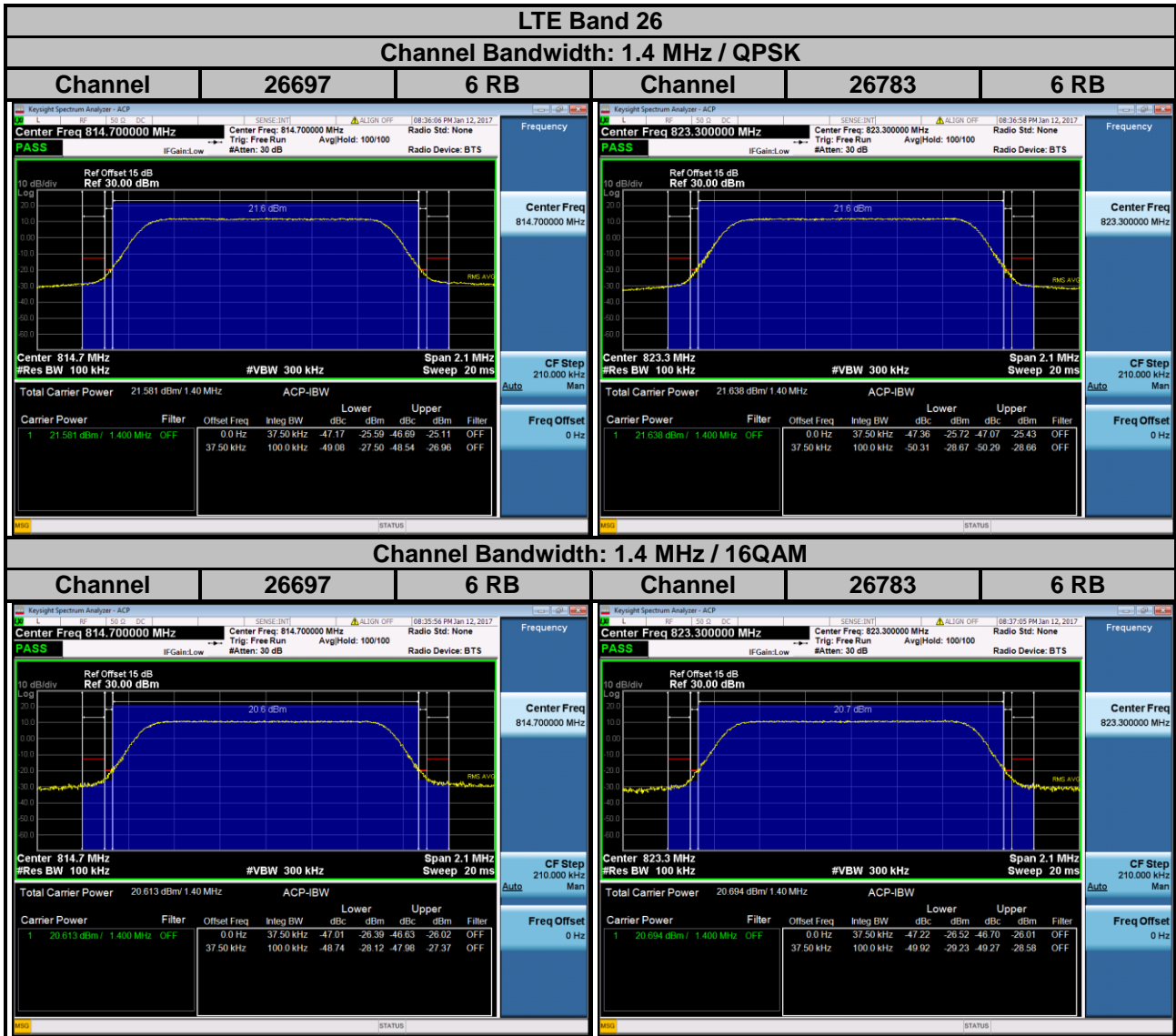

LTE Band 26
Channel Bandwidth: 3 MHz / QPSK

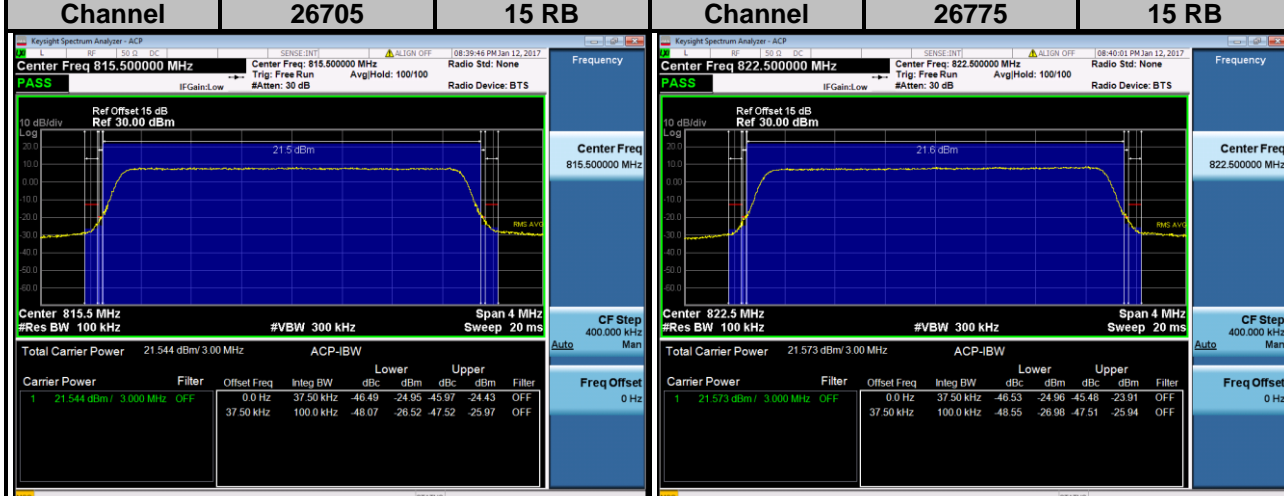

Channel Bandwidth: 3 MHz / 16QAM

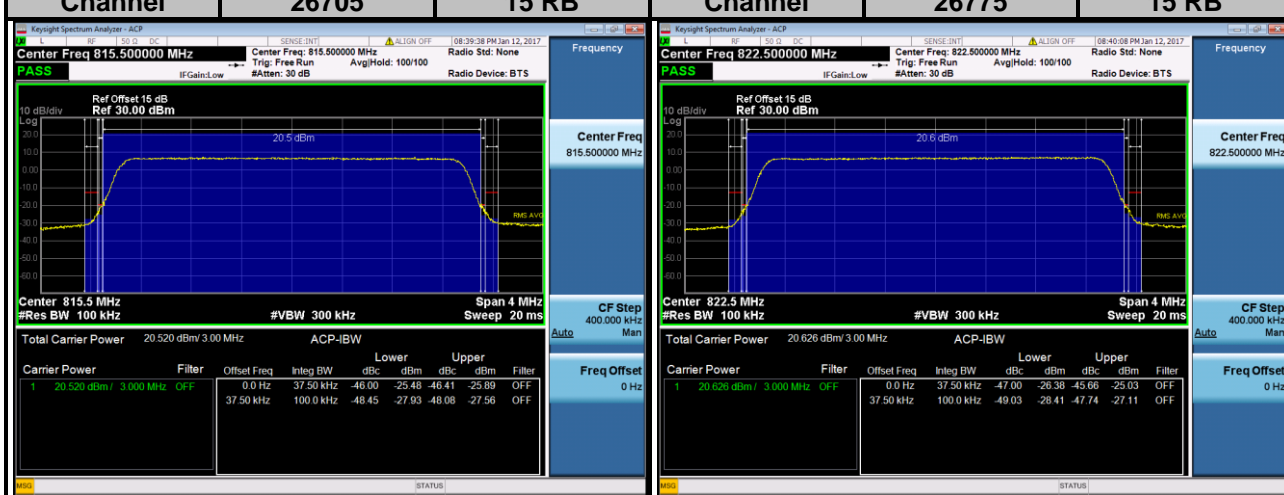

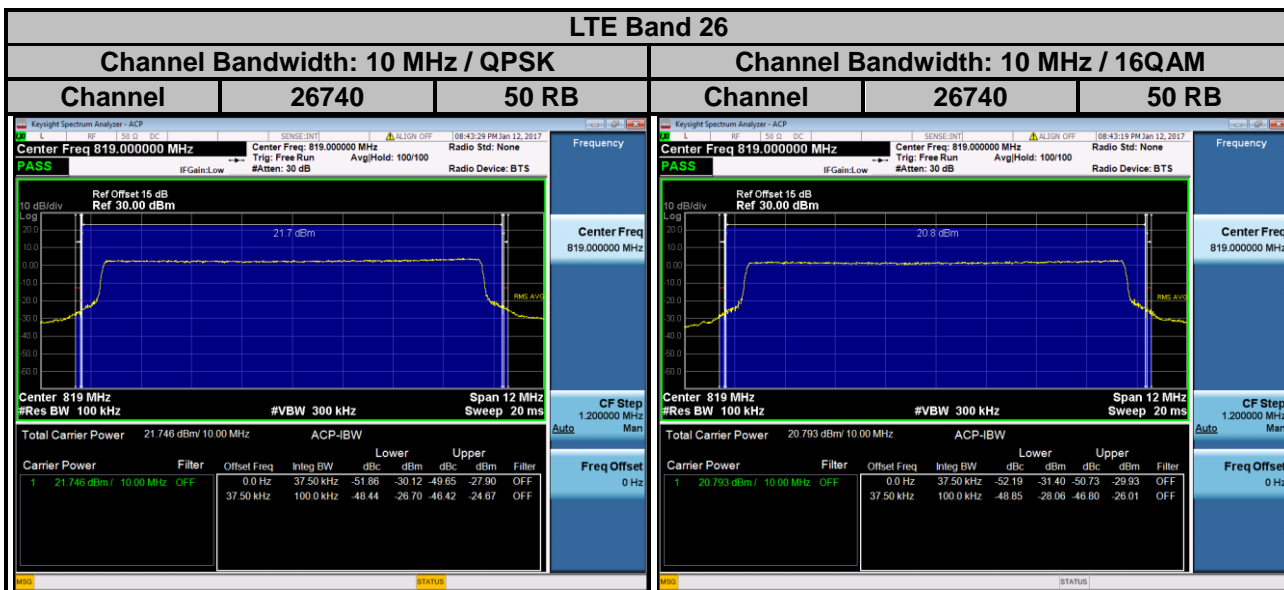
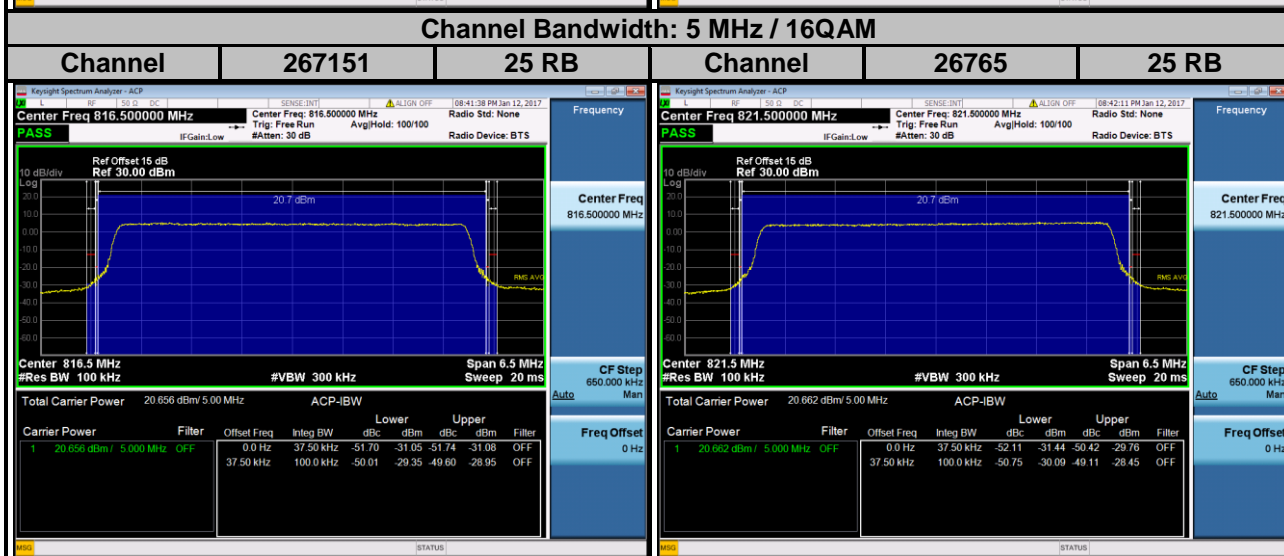
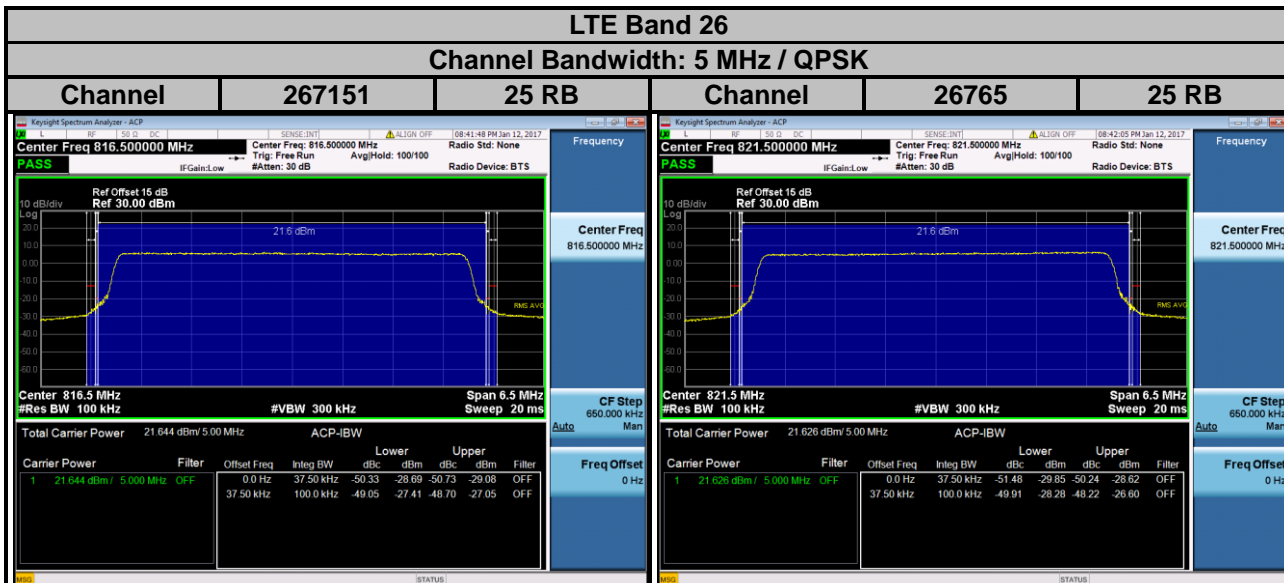

4.5 Conducted Spurious Emissions

4.5.1 Limits of Conducted Spurious Emissions Measurement

The power of any emission outside a licensee's frequency block shall be attenuated below the transmitter power (P) by at least $43 + 10 \log_{10}(P)$ dB. The limit of emission is equal to -13 dBm.

4.5.2 Test Setup

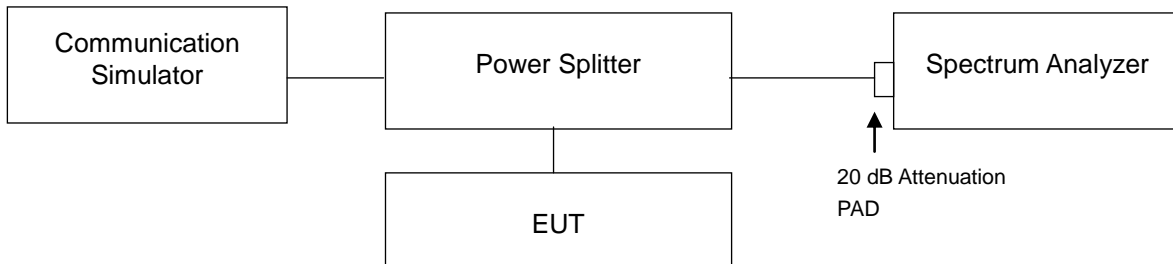

4.5.3 Test Procedure

- The EUT makes a phone call to the communication simulator. All measurements were done at low, middle and high operational frequency range.
- Measuring frequency range is from 30 MHz to 9 GHz. 10 dB attenuation pad is connected with spectrum. RBW=1 MHz and VBW=3 MHz are used for conducted emission measurement.

4.5.4 Test Results

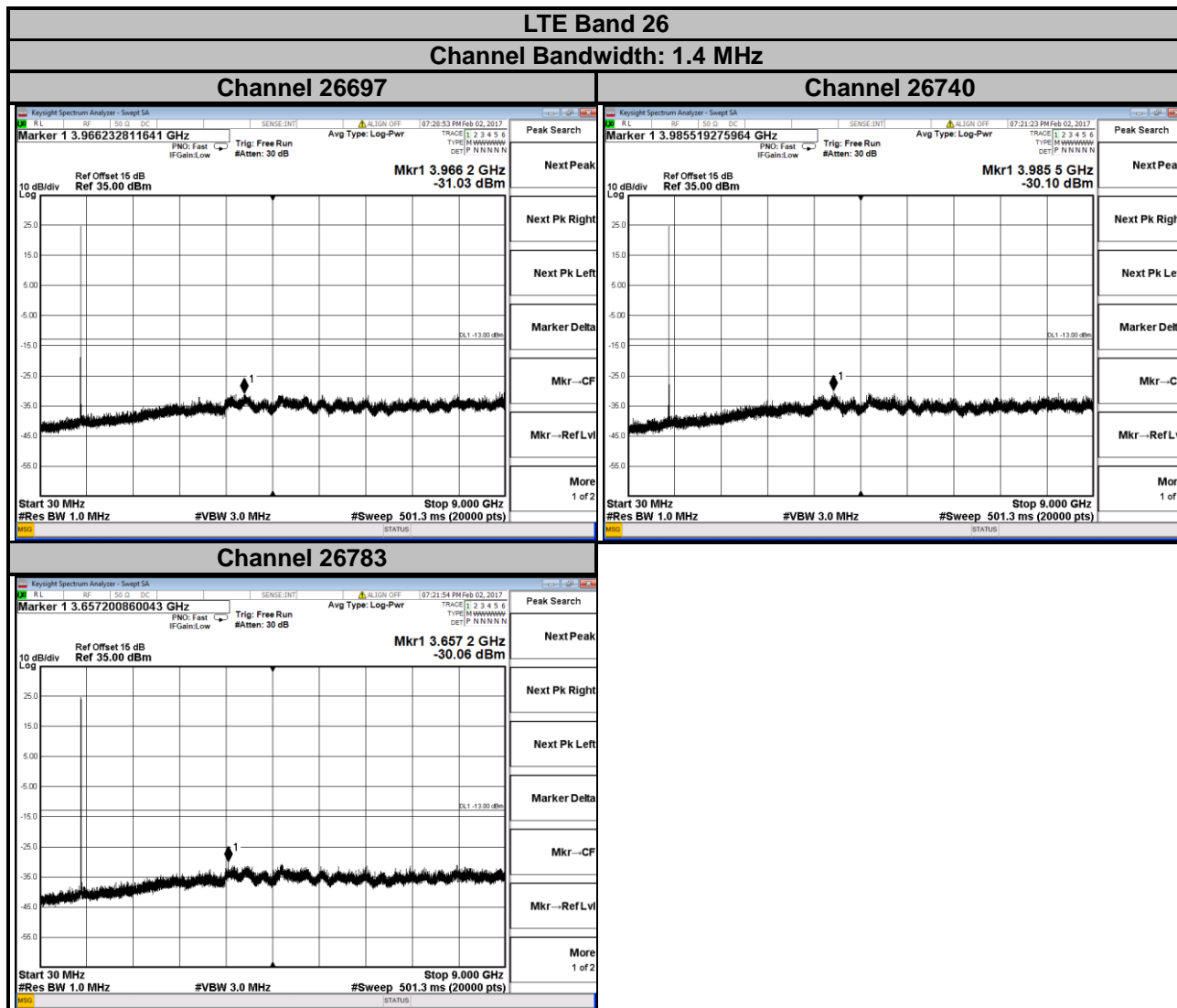

LTE Band 26
Channel Bandwidth: 3 MHz

Channel 26705

Channel 26740

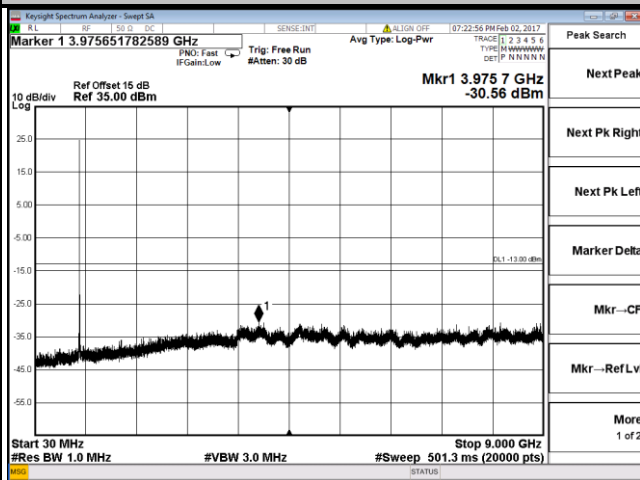
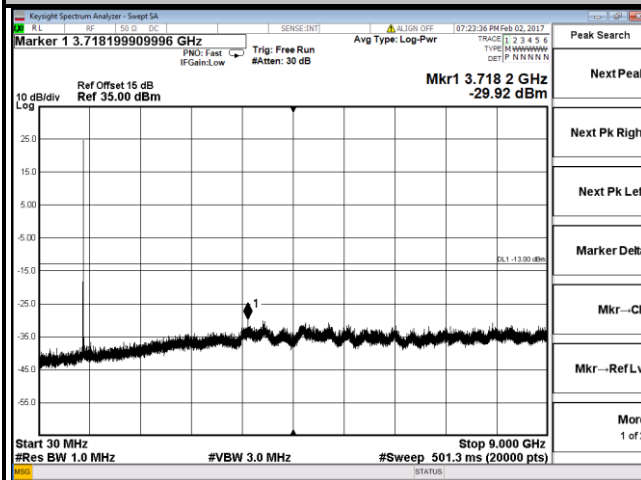

Channel 26775

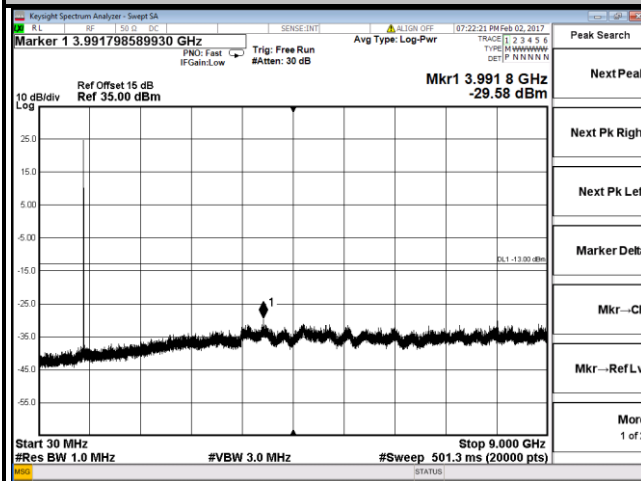

LTE Band 26
Channel Bandwidth: 5 MHz

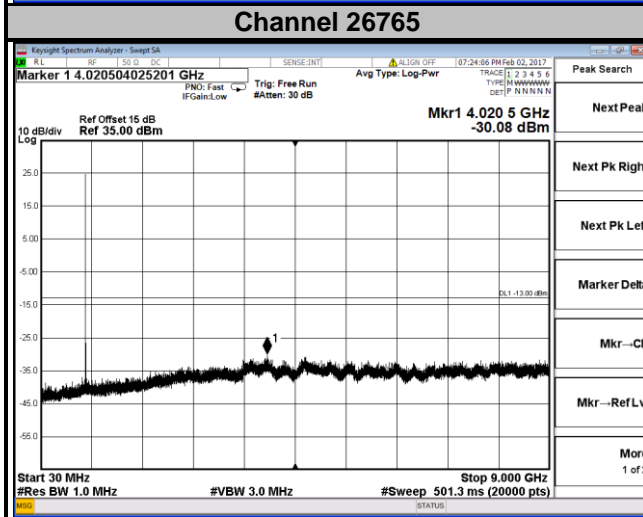
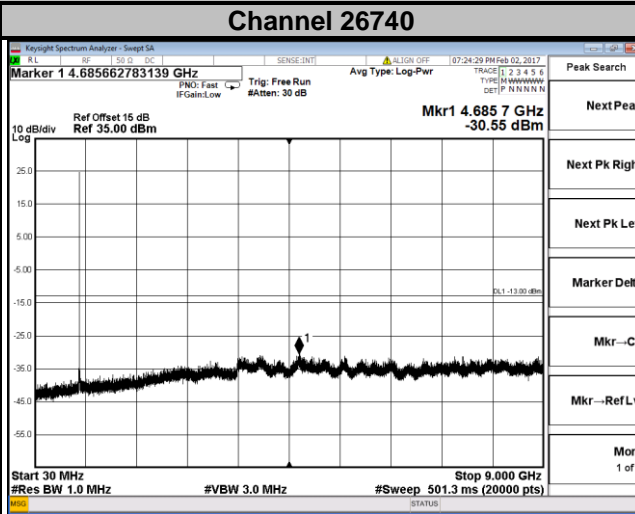
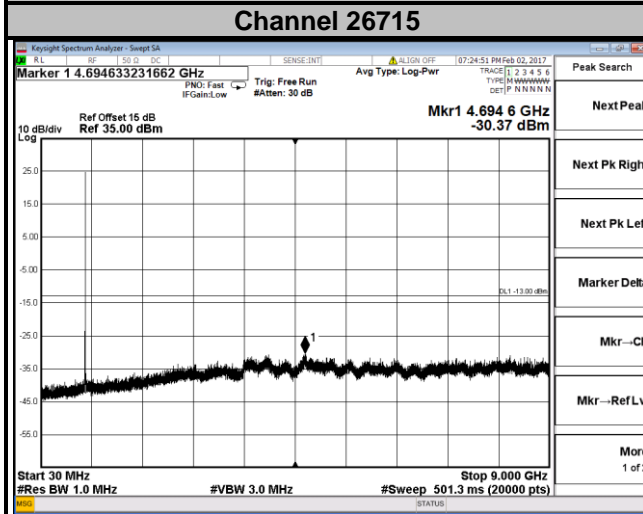

LTE Band 26
Channel Bandwidth: 10 MHz
Channel 26740

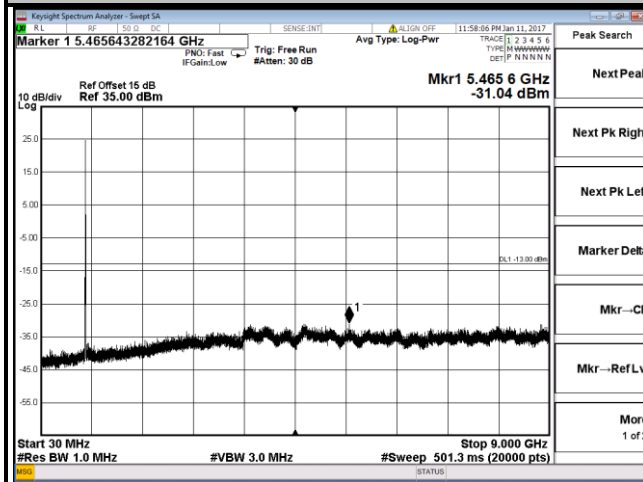

4.6 Radiated Emission Measurement

4.6.1 Limits of Radiated Emission Measurement

The power of any emission outside a licensee's frequency block shall be attenuated below the transmitter power (P) by at least $43 + 10 \log_{10}(P)$ dB. The limit of emission is equal to -13 dBm.

4.6.2 Test Procedure

- Substitution method is used for E.I.R.P measurement. In the semi-anechoic chamber, EUT placed on the 0.8 m height of Turn Table, rotated the table around 360 degrees to search the maximum radiation power and receiver antenna shall be rotated vertical and horizontal polarization and moved height from 1 m to 4 m to find the maximum polar radiated power. The "Read Value" is the spectrum reading the maximum power value.
- The substitution horn antenna is substituted for EUT at the same position and signals generator export the CW signal to the substitution antenna via a TX cable. Rotated the Turn Table and moved receiving antenna to find the maximum radiation power. Adjust output power level of S.G to get a Value of spectrum reading equal to "Read Value" of step a. Record the power level of S.G.
- $EIRP = \text{Output power level of S.G} - \text{TX cable loss} + \text{Antenna gain of substitution horn.}$
- E.R.P power can be calculated form E.I.R.P power by subtracting the gain of dipole, $E.R.P \text{ power} = E.I.P.R \text{ power} - 2.15 \text{ dBi.}$

Note: The resolution bandwidth of spectrum analyzer is 1 MHz and the video bandwidth is 3 MHz.

4.6.3 Deviation from Test Standard

No deviation.

4.6.4 Test Setup

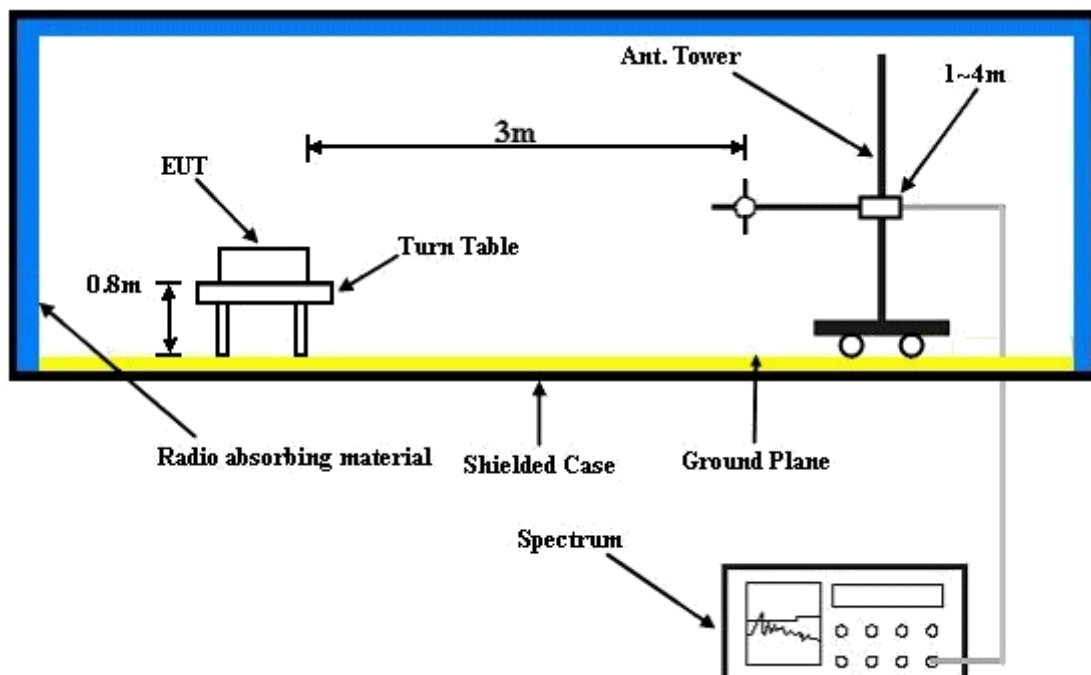

For the actual test configuration, please refer to the attached file (Test Setup Photo).

4.6.5 Test Results

LTE Band 26
Channel Bandwidth: 10 MHz / QPSK
Low Channel



Bureau Veritas Consumer Products Services Ltd., Taoyuan Branch

A D T

Data: 3

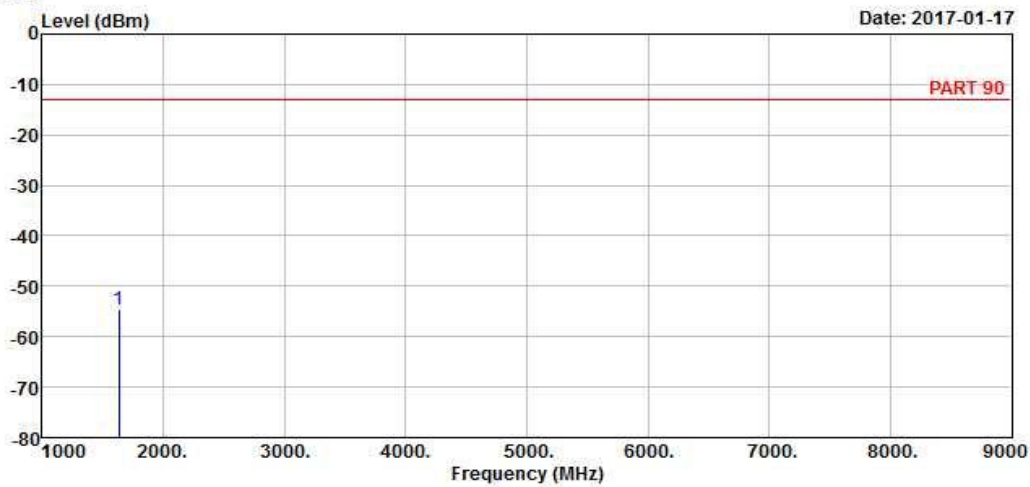

Site : 966 Chamber 5
Condition: PART 90 HORIZONTAL
Remak : LTE Band 26 QPSK_10M_L-CH Link
Tested by: Getaz Yang

Freq	Level	Read Level	Limit Line	Over Limit	Factor	Remark
MHz	dBm	dBm	dBm	dB	dB	
1 pp 1633.00	-54.74	-39.95	-13.00	-41.74	-14.79	Peak



Bureau Veritas Consumer Products Services Ltd., Taoyuan Branch

A D T

Data: 4

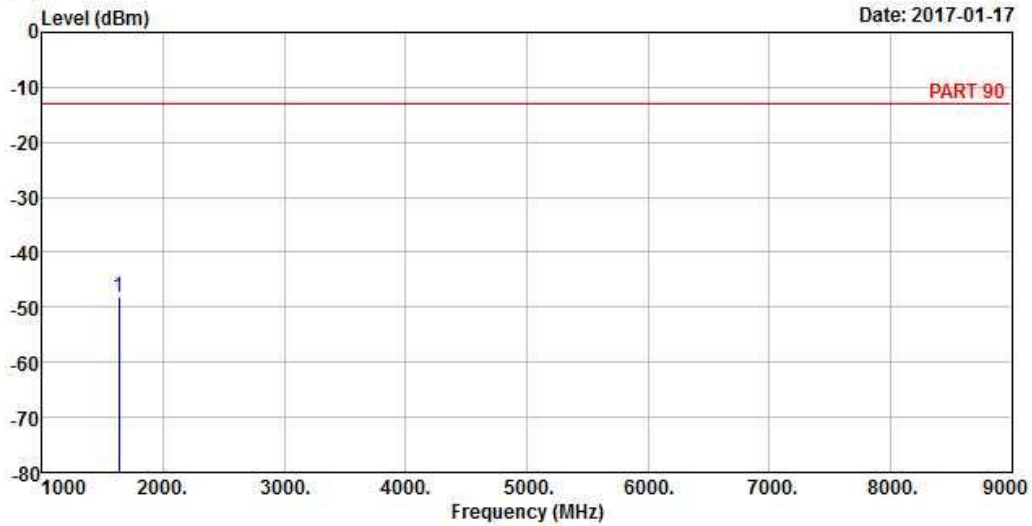

Site : 966 Chamber 5
 Condition: PART 90 VERTICAL
 Remak : LTE Band 26 QPSK_10M_L-CH Link
 Tested by: Getaz Yang

Freq	Level	Read Level	Limit Line	Over Limit	Factor	Remark
MHz	dBm	dBm	dBm	dB	dB	
1 pp 1633.00	-48.06	-33.27	-13.00	-35.06	-14.79	Peak

Middle Channel



Bureau Veritas Consumer Products Services Ltd., Taoyuan Branch

A D T

Data: 3

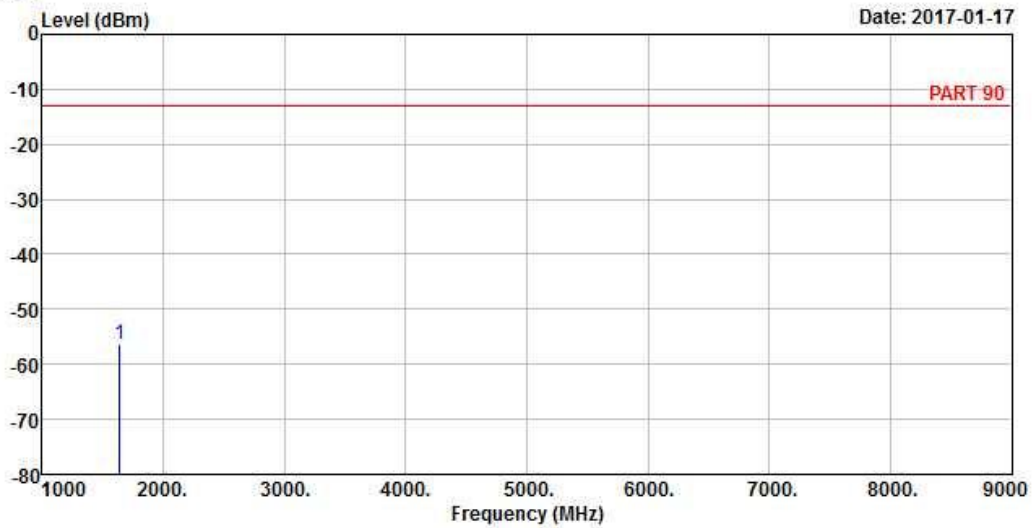

Site : 966 Chamber 5
 Condition: PART 90 HORIZONTAL
 Remak : LTE Band 26 QPSK_10M_M-CH Link
 Tested by: Getaz Yang

Freq	Level	Read Level	Limit Line	Over Limit	Factor	Remark
MHz	dBm	dBm	dBm	dB	dB	
1 pp 1638.00	-56.32	-41.53	-13.00	-43.32	-14.79	Peak



A D T

Data: 4

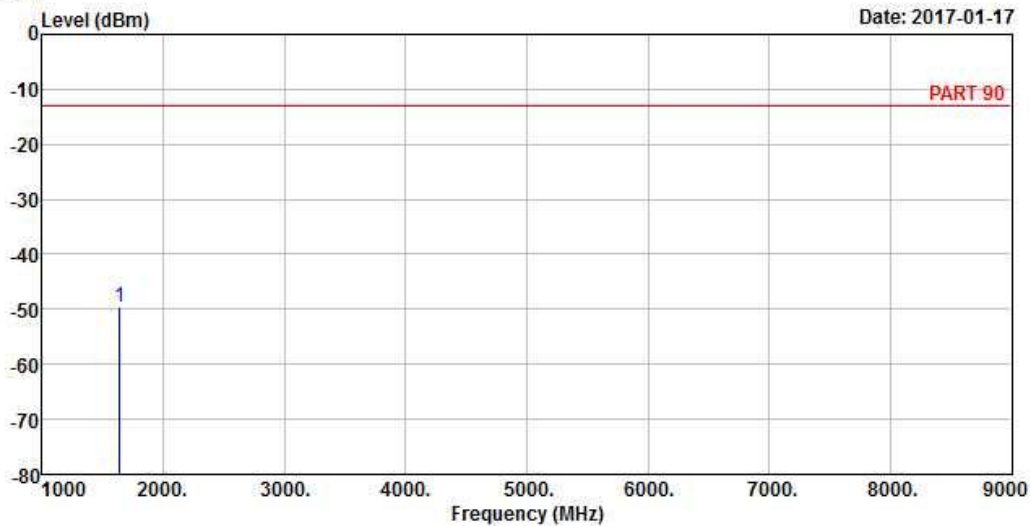

Site : 966 Chamber 5
 Condition: PART 90 VERTICAL
 Remak : LTE Band 26 QPSK_10M_M-CH Link
 Tested by: Getaz Yang

Freq	Level	Read Level	Limit Line	Over Limit	Factor	Remark
MHz	dBm	dBm	dBm	dB	dB	
1 pp 1638.00	-49.45	-34.66	-13.00	-36.45	-14.79	Peak

High Channel



Bureau Veritas Consumer Products Services Ltd., Taoyuan Branch

A D T

Data: 5

Date: 2017-01-17

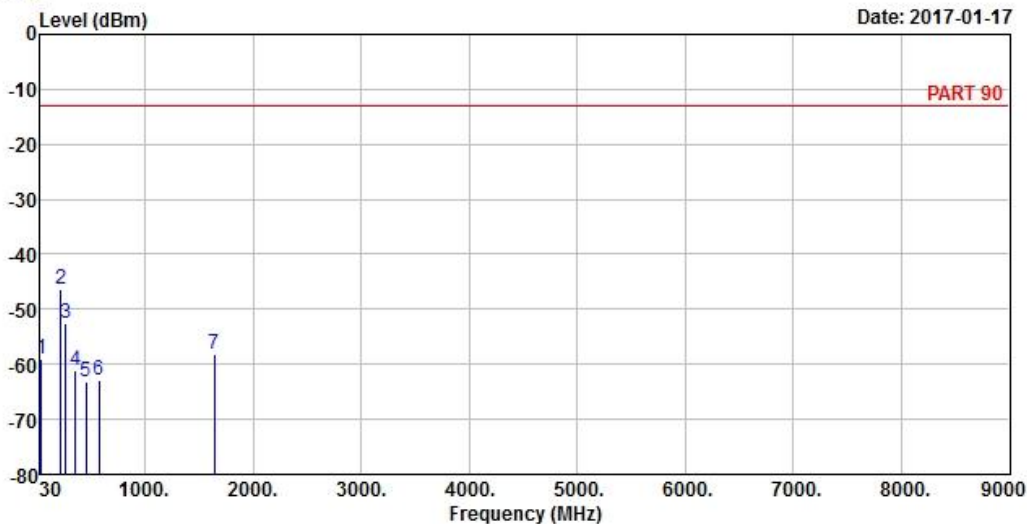

Site : 966 Chamber 5
 Condition: PART 90 HORIZONTAL
 Remak : LTE Band 26 QPSK_10M_H-CH Link
 Tested by: Getaz Yang

	Freq	Level	Read Level	Limit Line	Over Limit	Factor	Remark
	MHz	dBm	dBm	dBm	dB	dB	
1	41.64	-59.18	-58.77	-13.00	-46.18	-0.41	Peak
2 pp	223.03	-46.41	-39.33	-13.00	-33.41	-7.08	Peak
3	265.71	-52.46	-46.15	-13.00	-39.46	-6.31	Peak
4	353.01	-61.25	-55.03	-13.00	-48.25	-6.22	Peak
5	451.95	-63.31	-57.80	-13.00	-50.31	-5.51	Peak
6	576.11	-62.82	-61.06	-13.00	-49.82	-1.76	Peak
7	1643.00	-58.18	-43.45	-13.00	-45.18	-14.73	Peak



A D T

Data: 6

Date: 2017-01-17

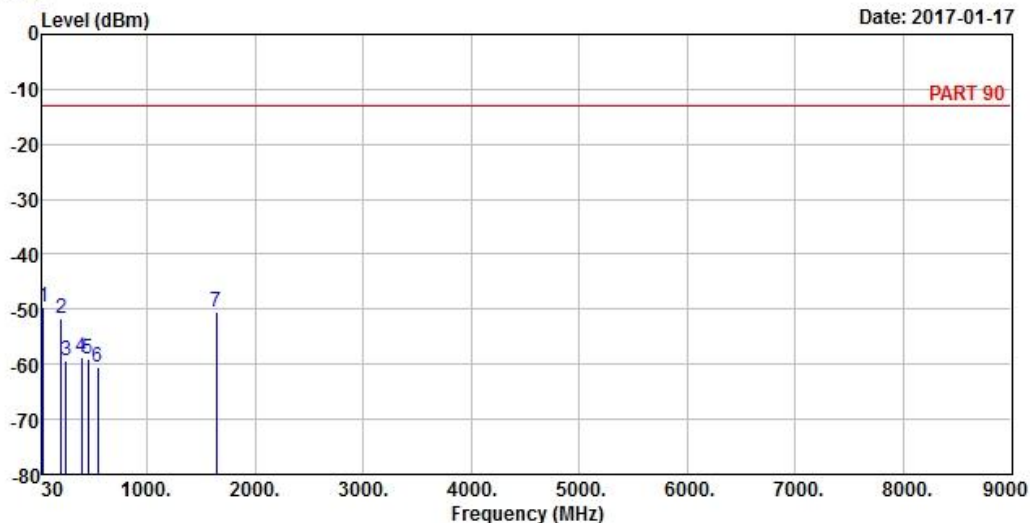

Site : 966 Chamber 5
 Condition: PART 90 VERTICAL
 Remak : LTE Band 26 QPSK_10M_H-CH Link
 Tested by: Getaz Yang

	Freq	Level	Read Level	Limit Line	Over Limit	Factor	Remark
	MHz	dBm	dBm	dBm	dB	dB	
1 pp	41.64	-49.53	-49.12	-13.00	-36.53	-0.41	Peak
2	204.60	-51.75	-43.92	-13.00	-38.75	-7.83	Peak
3	251.16	-59.31	-53.30	-13.00	-46.31	-6.01	Peak
4	395.69	-58.65	-52.68	-13.00	-45.65	-5.97	Peak
5	454.86	-58.98	-53.52	-13.00	-45.98	-5.46	Peak
6	546.04	-60.42	-57.43	-13.00	-47.42	-2.99	Peak
7	1643.00	-50.46	-35.73	-13.00	-37.46	-14.73	Peak

5 Pictures of Test Arrangements

Please refer to the attached file (Test Setup Photo).

Appendix – Information on the Testing Laboratories

We, Bureau Veritas Consumer Products Services (H.K.) Ltd., Taoyuan Branch, were founded in 1988 to provide our best service in EMC, Radio, Telecom and Safety consultation. Our laboratories are accredited and approved according to ISO/IEC 17025.

If you have any comments, please feel free to contact us at the following:

Linko EMC/RF Lab

Tel: 886-2-26052180

Fax: 886-2-26051924

Hsin Chu EMC/RF/Telecom Lab

Tel: 886-3-6668565

Fax: 886-3-6668323

Hwa Ya EMC/RF/Safety

Tel: 886-3-3183232

Fax: 886-3-3270892

Email: service.adt@tw.bureauveritas.com

Web Site: www.bureauveritas-adt.com

The address and road map of all our labs can be found in our web site also.

--- END ---