

FCC Test Report

(PART 24)

Report No.: RF170106C02-1

FCC ID: ZMOL850GL

Test Model: L850-GL

Received Date: Jan. 06, 2017

Test Date: Jan. 10, 2017 ~ Feb. 02, 2017

Issued Date: Feb. 21, 2017

Applicant: Fibocom Wireless Inc.

Address: 5/F, Tower A, Technology Building II, 1057 Nanhai Blvd, Nanshan,
Shenzhen, China

Issued By: Bureau Veritas Consumer Products Services (H.K.) Ltd., Taoyuan Branch

Lab Address: No. 47-2, 14th Ling, Chia Pau Vil., Lin Kou Dist., New Taipei City, Taiwan
(R.O.C)

Test Location: No. 19, Hwa Ya 2nd Rd, Wen Hwa Tsuen, Kwei Shan Hsiang, Taoyuan
Hsien 333, Taiwan, R.O.C.



This report is for your exclusive use. Any copying or replication of this report to or for any other person or entity, or use of our name or trademark, is permitted only with our prior written permission. This report sets forth our findings solely with respect to the test samples identified herein. The results set forth in this report are not indicative or representative of the quality or characteristics of the lot from which a test sample was taken or any similar or identical product unless specifically and expressly noted. Our report includes all of the tests requested by you and the results thereof based upon the information that you provided to us. You have 60 days from date of issuance of this report to notify us of any material error or omission caused by our negligence, provided, however, that such notice shall be in writing and shall specifically address the issue you wish to raise. A failure to raise such issue within the prescribed time shall constitute your unqualified acceptance of the completeness of this report, the tests conducted and the correctness of the report contents. Unless specific mention, the uncertainty of measurement has been explicitly taken into account to declare the compliance or non-compliance to the specification. The report must not be used by the client to claim product certification, approval, or endorsement by TAF or any government agencies.

Table of Contents

Release Control Record	3
1 Certificate of Conformity	4
2 Summary of Test Results	5
2.1 Measurement Uncertainty	5
2.2 Test Site And Instruments	6
3 General Information	8
3.1 General Description of EUT	8
3.2 Configuration of System under Test	9
3.2.1 Description of Support Units	9
3.3 Test Mode Applicability and Tested Channel Detail	9
3.4 EUT Operating Conditions	11
3.5 General Description of Applied Standards	11
4 Test Types and Results	12
4.1 Output Power Measurement	12
4.1.1 Limits of Output Power Measurement	12
4.1.2 Test Procedures	12
4.1.3 Test Setup	13
4.1.4 Test Results	14
4.2 Frequency Stability Measurement	20
4.2.1 Limits of Frequency Stability Measurement	20
4.2.2 Test Procedure	20
4.2.3 Test Setup	20
4.2.4 Test Results	21
4.3 Occupied Bandwidth Measurement	28
4.3.1 Test Procedure	28
4.3.2 Test Setup	28
4.3.3 Test Result	29
4.4 Band Edge Measurement	33
4.4.1 Limits of Band Edge Measurement	33
4.4.2 Test Setup	33
4.4.3 Test Procedures	33
4.4.4 Test Results	34
4.5 Peak to Average Ratio	40
4.5.1 Limits of Peak to Average Ratio Measurement	40
4.5.2 Test Setup	40
4.5.3 Test Procedures	40
4.5.4 Test Results	41
4.6 Conducted Spurious Emissions	45
4.6.1 Limits of Conducted Spurious Emissions Measurement	45
4.6.2 Test Setup	45
4.6.3 Test Procedure	45
4.6.4 Test Results	46
4.7 Radiated Emission Measurement	53
4.7.1 Limits of Radiated Emission Measurement	53
4.7.2 Test Procedure	53
4.7.3 Deviation from Test Standard	53
4.7.4 Test Setup	53
4.7.5 Test Results	54
5 Pictures of Test Arrangements	66
Appendix – Information on the Testing Laboratories	67

Release Control Record

Issue No.	Description	Date Issued
RF170106C02-1	Original Release	Feb. 21, 2017

1 Certificate of Conformity

Product: LTE module

Brand: Fibocom

Test Model: L850-GL

Sample Status: Identical Prototype

Applicant: Fibocom Wireless Inc.

Test Date: Jan. 10, 2017 ~ Feb. 02, 2017

Standards: FCC Part 24, Subpart E

The above equipment has been tested by **Bureau Veritas Consumer Products Services (H.K.) Ltd., Taoyuan Branch**, and found compliance with the requirement of the above standards. The test record, data evaluation & Equipment Under Test (EUT) configurations represented herein are true and accurate accounts of the measurements of the sample's EMC characteristics under the conditions specified in this report.

Prepared by :  , **Date:** Feb. 21, 2017
Gina Liu / Specialist

Approved by :  , **Date:** Feb. 21, 2017
David Huang / Project Engineer

2 Summary of Test Results

Applied Standard: FCC Part 24 & Part 2			
FCC Clause	Test Item	Result	Remarks
2.1046 24.232	Effective Isotropic Radiated Power	Pass	Meet the requirement of limit.
2.1046 24.232(d)	Peak to Average Ratio	Pass	Meet the requirement of limit.
2.1055 24.235	Frequency Stability	Pass	Meet the requirement of limit.
2.1049 24.238(b)	Occupied Bandwidth	Pass	Meet the requirement of limit.
24.238(b)	Band Edge Measurements	Pass	Meet the requirement of limit.
2.1051 24.238	Conducted Spurious Emissions	Pass	Meet the requirement of limit.
2.1053 24.238	Radiated Spurious Emissions	Pass	Meet the requirement of limit. Minimum passing margin is -33.43 dB at 222.06 MHz.

2.1 Measurement Uncertainty

Where relevant, the following measurement uncertainty levels have been estimated for tests performed on the EUT as specified in CISPR 16-4-2:

Measurement	Frequency	Expanded Uncertainty (k=2) (±)
Conducted Emissions at mains ports	150 kHz ~ 30 MHz	2.44 dB
Radiated Emissions up to 1 GHz	30 MHz ~ 200 MHz	2.93 dB
	200 MHz ~ 1000 MHz	2.95 dB
Radiated Emissions above 1 GHz	1 GHz ~ 18 GHz	2.26 dB
	18 GHz ~ 40 GHz	1.94 dB

2.2 Test Site And Instruments

Description & Manufacturer	Model No.	Serial No.	Date of Calibration	Due Date of Calibration
Test Receiver Agilent Technologies	N9038A	MY52260177	Jun. 21, 2016	Jun. 20, 2017
Spectrum Analyzer Agilent	N9010A	MY52220314	Dec. 16, 2016	Dec. 15, 2017
Spectrum Analyzer ROHDE & SCHWARZ	FSU43	101261	Dec. 13, 2016	Dec. 12, 2017
BILOG Antenna SCHWARZBECK	VULB9168	9168-472	Dec. 26, 2016	Dec. 27, 2017
HORN Antenna SCHWARZBECK	BBHA 9120 D	9120D-969	Dec. 12, 2016	Dec. 13, 2017
Double Ridge Guide Horn Antenna EMCO	3115	5619	Dec. 26, 2016	Dec. 27, 2017
BILOG Antenna SCHWARZBECK	VULB 9168	9168-153	Dec. 12, 2016	Dec. 13, 2017
Agilent Communications Tester-Wireless	8960 Series 10	MY53201073	Jul. 03, 2015	Jul. 02, 2017
Preamplifier EMCI	EMC 012645	980115	Oct. 21, 2016	Oct. 20, 2017
Preamplifier EMCI	EMC 184045	980116	Oct. 21, 2016	Oct. 20, 2017
Preamplifier EMCI	EMC 330H	980112	Oct. 21, 2016	Oct. 20, 2017
Power Meter Anritsu	ML2495A	1232002	Sep. 08, 2016	Sep. 07, 2017
Power Sensor Anritsu	MA2411B	1207325	Sep. 08, 2016	Sep. 07, 2017
RF signal cable HUBER+SUHNNER	SUCOFLEX 104	309219/4 2950114	Oct. 21, 2016	Oct. 20, 2017
RF signal cable HUBER+SUHNNER	SUCOFLEX 104	250130/4	Oct. 21, 2016	Oct. 20, 2017
RF Coaxial Cable Worken	8D-FB	Cable-Ch10-01	Oct. 21, 2016	Oct. 20, 2017
Software BV ADT	E3 6.120103	NA	NA	NA
Antenna Tower MF	MFA-440H	NA	NA	NA
Turn Table MF	MFT-201SS	NA	NA	NA
Antenna Tower & Turn Table Controller MF	MF-7802	NA	NA	NA
Radio Communication Analyzer	MT8820C	6201300640	Aug. 10, 2015	Aug. 09, 2017
Temperature & Humidity Chamber	GTH-120-40-CP-A R	MAA1306-019	Sep. 02, 2016	Sep. 01, 2017
DC Power Supply Topward	33010D	807748	Oct. 25, 2016	Oct. 24, 2018
Digital Multimeter Fluke	87-III	70360742	Jul. 01, 2016	Jun. 30, 2017

- Note:
1. The calibration interval of the above test instruments is 12 / 24 months and the calibrations are traceable to NML/ROC and NIST/USA.
 2. The test was performed in HwaYa Chamber 10.
 3. The horn antenna and preamplifier (model: EMC 184045) are used only for the measurement of emission frequency above 1 GHz if tested.
 4. The FCC Site Registration No. is 690701.
 5. The IC Site Registration No. is IC7450F-10.

3 General Information

3.1 General Description of EUT

Product	LTE module	
Brand	Fibocom	
Test Model	L850-GL	
Status of EUT	Identical Prototype	
Power Supply Rating	3.3 Vdc (from Host Equipment)	
Modulation Type	WCDMA	BPSK
	LTE	QPSK, 16QAM
Frequency Range	WCDMA	1852.4 ~ 1907.6 MHz
	LTE Band 2 (Channel Bandwidth: 1.4 MHz)	1850.7 ~ 1909.3 MHz
	LTE Band 2 (Channel Bandwidth: 3 MHz)	1851.5 ~ 1908.5 MHz
	LTE Band 2 (Channel Bandwidth: 5 MHz)	1852.5 ~ 1907.5 MHz
	LTE Band 2 (Channel Bandwidth: 10 MHz)	1855.0 ~ 1905.0 MHz
	LTE Band 2 (Channel Bandwidth: 15 MHz)	1857.5 ~ 1902.5 MHz
	LTE Band 2 (Channel Bandwidth: 20 MHz)	1860.0 ~ 1900.0 MHz
Max. EIRP Power	WCDMA	428.84 mW
	LTE Band 2 (Channel Bandwidth: 1.4 MHz)	209.07 mW
	LTE Band 2 (Channel Bandwidth: 3 MHz)	215.43 mW
	LTE Band 2 (Channel Bandwidth: 5 MHz)	220.44 mW
	LTE Band 2 (Channel Bandwidth: 10 MHz)	226.62 mW
	LTE Band 2 (Channel Bandwidth: 15 MHz)	231.37 mW
	LTE Band 2 (Channel Bandwidth: 20 MHz)	235.67 mW
Emission Designator	WCDMA	4M14F9W
	LTE Band 2 (Channel Bandwidth: 1.4 MHz)	1M09W7D
	LTE Band 2 (Channel Bandwidth: 3 MHz)	2M70W7D
	LTE Band 2 (Channel Bandwidth: 5 MHz)	4M50G7D
	LTE Band 2 (Channel Bandwidth: 10 MHz)	9M90W7D
	LTE Band 2 (Channel Bandwidth: 15 MHz)	13M4G7D
	LTE Band 2 (Channel Bandwidth: 20 MHz)	18M0G7D
Antenna Type	External Antenna	
Accessory Device	Refer to Note as below	
Data Cable Supplied	Refer to Note as below	

Note:

1. The above EUT information is declared by manufacturer and for more detailed features description, please refer to the manufacturer's specifications or user's manual.

3.2 Configuration of System under Test

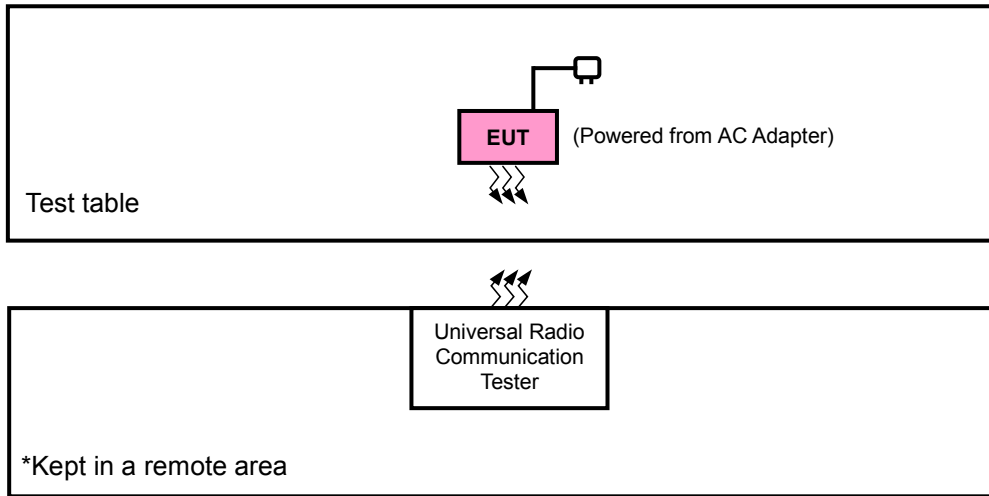

3.2.1 Description of Support Units

The EUT has been tested as an independent unit together with other necessary accessories or support units.

3.3 Test Mode Applicability and Tested Channel Detail

Pre-Scan has been conducted to determine the worst-case mode from all possible combinations between available modulations, data rates, XYZ axis, and antenna ports.

The worst case was found when positioned as the table below. Following channel(s) was (were) selected for the final test as listed below:

Band	EIRP	Radiated Emission
WCDMA	Z-plane	Z-axis
LTE Band 2	Z-plane	Z-axis

WCDMA

EUT Configure Mode	Test Item	Available Channel	Tested Channel	Mode
-	EIRP	9262 to 9538	9262, 9400, 9538	WCDMA
-	Frequency Stability	9262 to 9538	9262, 9538	WCDMA
-	Occupied Bandwidth	9262 to 9538	9262, 9400, 9538	WCDMA
-	Band Edge	9262 to 9538	9262, 9538	WCDMA
-	Peak to Average Ratio	9262 to 9538	9262, 9400, 9538	WCDMA
-	Condcudeted Emission	9262 to 9538	9262, 9400, 9538	WCDMA
-	Radiated Emission	9262 to 9538	9262, 9400, 9538	WCDMA

LTE Band 2

EUT Configure Mode	Test Item	Available Channel	Tested Channel	Channel Bandwidth	Modulation	Mode
-	EIRP	18607 to 19193	18607, 18900, 19193	1.4 MHz	QPSK, 16QAM	1 RB / 0 RB Offset
		18615 to 19185	18615, 18900, 19185	3 MHz	QPSK, 16QAM	1 RB / 0 RB Offset
		18625 to 19175	18625, 18900, 19175	5 MHz	QPSK, 16QAM	1 RB / 0 RB Offset
		18650 to 19150	18650, 18900, 19150	10 MHz	QPSK, 16QAM	1 RB / 0 RB Offset
		18675 to 19125	18675, 18900, 19125	15 MHz	QPSK, 16QAM	1 RB / 0 RB Offset
		18700 to 19100	18700, 18900, 19100	20 MHz	QPSK, 16QAM	1 RB / 0 RB Offset
-	Frequency Stability	18607 to 19193	18607, 19193	1.4 MHz	QPSK	1 RB / 0 RB Offset
		18615 to 19185	18615, 19185	3 MHz	QPSK	1 RB / 0 RB Offset
		18625 to 19175	18625, 19175	5 MHz	QPSK	1 RB / 0 RB Offset
		18650 to 19150	18650, 19150	10 MHz	QPSK	1 RB / 0 RB Offset
		18675 to 19125	18675, 19125	15 MHz	QPSK	1 RB / 0 RB Offset
		18700 to 19100	18700, 19100	20 MHz	QPSK	1 RB / 0 RB Offset
-	Occupied Bandwidth	18607 to 19193	18607, 18900, 19193	1.4 MHz	QPSK, 16QAM	6 RB / 0 RB Offset
		18615 to 19185	18615, 18900, 19185	3 MHz	QPSK, 16QAM	15 RB / 0 RB Offset
		18625 to 19175	18625, 18900, 19175	5 MHz	QPSK, 16QAM	25 RB / 0 RB Offset
		18650 to 19150	18650, 18900, 19150	10 MHz	QPSK, 16QAM	50 RB / 0 RB Offset
		18675 to 19125	18675, 18900, 19125	15 MHz	QPSK, 16QAM	75 RB / 0 RB Offset
		18700 to 19100	18700, 18900, 19100	20 MHz	QPSK, 16QAM	100 RB / 0 RB Offset
-	Peak to Average Ratio	18607 to 19193	18607, 18900, 19193	1.4 MHz	QPSK, 16QAM	1 RB / 0 RB Offset
		18615 to 19185	18615, 18900, 19185	3 MHz	QPSK, 16QAM	1 RB / 0 RB Offset
		18625 to 19175	18625, 18900, 19175	5 MHz	QPSK, 16QAM	1 RB / 0 RB Offset
		18650 to 19150	18650, 18900, 19150	10 MHz	QPSK, 16QAM	1 RB / 0 RB Offset
		18675 to 19125	18675, 18900, 19125	15 MHz	QPSK, 16QAM	1 RB / 0 RB Offset
		18700 to 19100	18700, 18900, 19100	20 MHz	QPSK, 16QAM	1 RB / 0 RB Offset
-	Band Edge	18607 to 19193	18607	1.4 MHz	QPSK	1 RB / 0 RB Offset 6 RB / 0 RB Offset
			19193	1.4 MHz	QPSK	1 RB / 5 RB Offset 6 RB / 0 RB Offset
		18615 to 19185	18615	3 MHz	QPSK	1 RB / 0 RB Offset 15 RB / 0 RB Offset
			19185	3 MHz	QPSK	1 RB / 14 RB Offset 15 RB / 0 RB Offset
		18625 to 19175	18625	5 MHz	QPSK	1 RB / 0 RB Offset 25 RB / 0 RB Offset
			19175	5 MHz	QPSK	1 RB / 24 RB Offset 25 RB / 0 RB Offset
		18650 to 19150	18650	10 MHz	QPSK	1 RB / 0 RB Offset 50 RB / 0 RB Offset
			19150	10 MHz	QPSK	1 RB / 49 RB Offset 50 RB / 0 RB Offset
		18675 to 19125	18675	15 MHz	QPSK	1 RB / 0 RB Offset 75 RB / 0 RB Offset
			19125	15 MHz	QPSK	1 RB / 74 RB Offset 75 RB / 0 RB Offset
		18700 to 19100	18700	20 MHz	QPSK	1 RB / 0 RB Offset 100 RB / 0 RB Offset
			19100	20 MHz	QPSK	1 RB / 99 RB Offset 100 RB / 0 RB Offset

EUT Configure Mode	Test Item	Available Channel	Tested Channel	Channel Bandwidth	Modulation	Mode
-	Conducted Emission	18607 to 19193	18607, 18900, 19193	1.4 MHz	QPSK	1 RB / 0 RB Offset
		18615 to 19185	18615, 18900, 19185	3 MHz	QPSK	1 RB / 0 RB Offset
		18625 to 19175	18625, 18900, 19175	5 MHz	QPSK	1 RB / 0 RB Offset
		18650 to 19150	18650, 18900, 19150	10 MHz	QPSK	1 RB / 0 RB Offset
		18675 to 19125	18675, 18900, 19125	15 MHz	QPSK	1 RB / 0 RB Offset
		18700 to 19100	18700, 18900, 19100	20 MHz	QPSK	1 RB / 0 RB Offset
-	Radiated Emission	18700 to 19100	18700, 18900, 19100	20 MHz	QPSK	1 RB / 0 RB Offset

Note: This device was tested under all bandwidths, RB configurations and modulations. The worst case was found in QPSK modulation.

Test Condition:

Test Item	Environmental Conditions	Input Power	Tested By
EIRP	26 deg. C, 58 % RH	3.3 Vdc	Gavin Wu
Frequency Stability	26 deg. C, 58 % RH	3.3 Vdc	Carlos Chen
Occupied Bandwidth	26 deg. C, 58 % RH	3.3 Vdc	Carlos Chen
Band Edge	26 deg. C, 58 % RH	3.3 Vdc	Carlos Chen
Peak to Average Ratio	26 deg. C, 58 % RH	3.3 Vdc	Carlos Chen
Condcudeted Emission	26 deg. C, 58 % RH	3.3 Vdc	Carlos Chen
Radiated Emission	25 deg. C, 65 % RH	120 Vac, 60 Hz	Gavin Wu

3.4 EUT Operating Conditions

The EUT makes a call to the communication simulator. The communication simulator station system controlled a EUT to export maximum output power under transmission mode and specific channel frequency

3.5 General Description of Applied Standards

The EUT is a RF Product. According to the specifications of the manufacturer, it must comply with the requirements of the following standards:

FCC 47 CFR Part 2

FCC 47 CFR Part 24

KDB 971168 D01 Power Meas License Digital Systems v02r02

ANSI/TIA/EIA-603-D 2010

NOTE: All test items have been performed and recorded as per the above standards.

4 Test Types and Results

4.1 Output Power Measurement

4.1.1 Limits of Output Power Measurement

Mobile / Portable station are limited to 2 watts e.i.r.p.

4.1.2 Test Procedures

EIRP / ERP Measurement:

- a. All measurements were done at low, middle and high operational frequency range. RBW and VBW is 1 MHz for GSM, GPRS & EDGE, 5 MHz for WCDMA and CDMA, and 10 MHz for LTE mode.
- b. Substitution method is used for E.I.R.P measurement. In the semi-anechoic chamber, EUT placed on the 0.8 m height of Turn Table, rotated the table around 360 degrees to search the maximum radiation power and receiver antenna shall be rotated vertical and horizontal polarization and moved height from 1m to 4m to find the maximum polar radiated power. The "Read Value" is the spectrum reading the maximum power value.
- c. The substitution horn antenna is substituted for EUT at the same position and signals generator export the CW signal to the substitution antenna via a tx cable. Rotated the Turn Table and moved receiving antenna to find the maximum radiation power. Adjust output power level of S.G to get a Value of spectrum reading equal to "Read Value" of step b. Record the power level of S.G.
- d. $EIRP = \text{Output power level of S.G} - \text{TX cable loss} + \text{Antenna gain of substitution horn}$. E.R.P power can be calculated form E.I.R.P power by subtracting the gain of dipole, $E.R.P \text{ power} = E.I.P.R \text{ power} - 2.15 \text{ dBi}$.

Conducted Power Measurement:

The EUT was set up for the maximum power with GSM, GPRS, EDGE, WCDMA, CDMA, and LTE link data modulation and link up with simulator. Set the EUT to transmit under low, middle and high channel and record the power level shown on simulator.

4.1.3 Test Setup

EIRP / ERP Measurement:

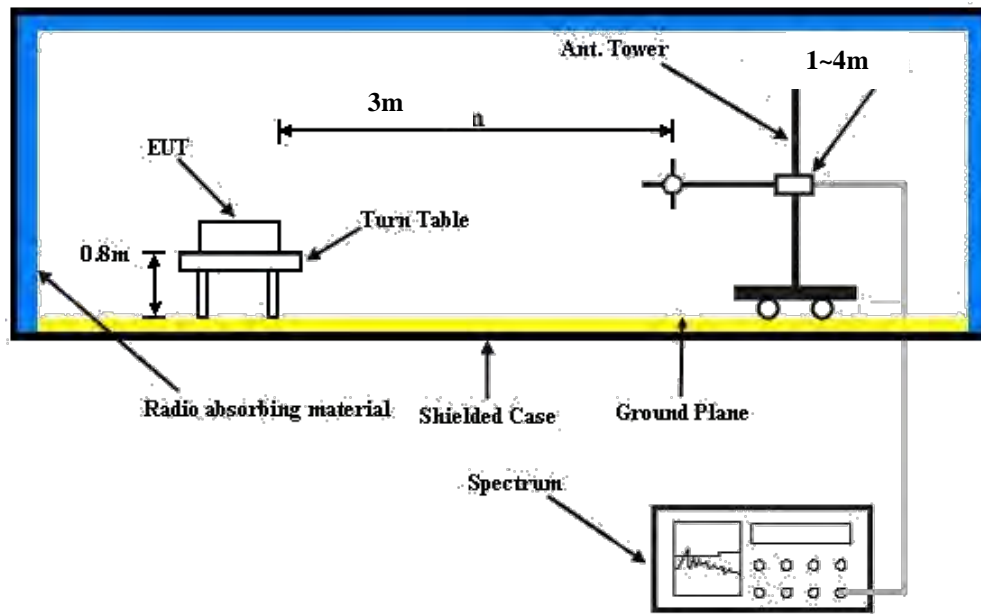

For the actual test configuration, please refer to the attached file (Test Setup Photo).

Conducted Power Measurement:



4.1.4 Test Results

Conducted Output Power (dBm)

Band	WCDMA II		
	Channel	9262	9400
Frequency (MHz)	1852.4	1880.0	1907.6
RMC 12.2K	23.39	23.51	23.62
HSDPA Subtest-1	21.26	22.05	22.14
HSDPA Subtest-2	21.08	22.28	21.99
HSDPA Subtest-3	21.21	22.06	22.13
HSDPA Subtest-4	21.01	22.30	22.13
HSUPA Subtest-1	20.41	20.52	20.19
HSUPA Subtest-2	18.98	19.18	19.04
HSUPA Subtest-3	19.93	19.74	19.94
HSUPA Subtest-4	19.30	19.48	19.22
HSUPA Subtest-5	20.31	20.42	20.22

Band / BW	RB Size	RB Offset	QPSK			3GPP MPR (dB)	16QAM			3GPP MPR (dB)
			Low Ch 18607	Mid Ch 18900	High Ch 19193		Low Ch 18607	Mid Ch 18900	High Ch 19193	
			1850.7 MHz	1880.0 MHz	1909.3 MHz		1850.7 MHz	1880.0 MHz	1909.3 MHz	
2 / 1.4M	1	0	22.28	22.34	22.30	0	21.22	21.31	21.29	1
	1	2	22.16	22.22	22.17	0	21.10	21.10	21.10	1
	1	5	21.91	22.09	22.01	0	20.88	20.92	20.96	1
	3	0	21.31	21.38	21.34	0	20.28	20.31	20.29	1
	3	1	21.13	21.22	21.15	0	20.02	20.21	20.22	1
	3	3	21.03	21.04	21.13	0	19.89	20.03	19.91	1
	6	0	21.13	21.13	21.28	1	20.00	20.12	20.06	2

Band / BW	RB Size	RB Offset	QPSK			3GPP MPR (dB)	16QAM			3GPP MPR (dB)
			Low Ch 18615	Mid Ch 18900	High Ch 19185		Low Ch 18615	Mid Ch 18900	High Ch 19185	
			1851.5 MHz	1880.0 MHz	1908.5 MHz		1851.5 MHz	1880.0 MHz	1908.5 MHz	
2 / 3M	1	0	22.32	22.37	22.44	0	21.25	21.33	21.37	1
	1	7	22.17	22.25	22.30	0	21.19	21.15	21.27	1
	1	14	21.96	21.99	22.09	0	20.95	20.94	21.19	1
	8	0	21.39	21.41	21.45	1	20.37	20.23	20.33	2
	8	3	21.24	21.29	21.30	1	20.22	20.22	20.31	2
	8	7	21.11	21.14	21.09	1	20.07	20.11	20.14	2
	15	0	21.17	21.35	21.28	1	20.16	20.11	20.26	2

Band / BW	RB Size	RB Offset	QPSK			3GPP MPR (dB)	16QAM			3GPP MPR (dB)
			Low Ch 18625	Mid Ch 18900	High Ch 19175		Low Ch 18625	Mid Ch 18900	High Ch 19175	
			1852.5 MHz	1880.0 MHz	1907.5 MHz		1852.5 MHz	1880.0 MHz	1907.5 MHz	
2 / 5M	1	0	22.42	22.46	22.50	0	21.41	21.43	21.47	1
	1	12	22.32	22.33	22.37	0	21.27	21.23	21.36	1
	1	24	22.21	22.09	22.12	0	21.09	21.05	21.22	1
	12	0	21.44	21.47	21.55	1	20.23	20.43	20.40	2
	12	6	21.30	21.31	21.46	1	20.25	20.34	20.31	2
	12	13	21.12	21.17	21.27	1	20.07	20.06	20.31	2
	25	0	21.22	21.36	21.32	1	20.33	20.36	20.32	2

Band / BW	RB Size	RB Offset	QPSK			3GPP MPR (dB)	16QAM			3GPP MPR (dB)
			Low Ch 18650	Mid Ch 18900	High Ch 19150		Low Ch 18650	Mid Ch 18900	High Ch 19150	
			1855.0 MHz	1880.0 MHz	1905.0 MHz		1855.0 MHz	1880.0 MHz	1905.0 MHz	
2 / 10M	1	0	22.50	22.56	22.60	0	21.41	21.55	21.56	1
	1	24	22.37	22.41	22.48	0	21.37	21.37	21.48	1
	1	49	22.18	22.26	22.39	0	21.10	21.17	21.22	1
	25	0	21.48	21.55	21.59	1	20.39	20.38	20.47	2
	25	12	21.39	21.39	21.47	1	20.30	20.35	20.45	2
	25	25	21.20	21.30	21.23	1	20.20	20.16	20.22	2
	50	0	21.32	21.46	21.40	1	20.46	20.36	20.49	2

Band / BW	RB Size	RB Offset	QPSK			3GPP MPR (dB)	16QAM			3GPP MPR (dB)
			Low Ch 18675	Mid Ch 18900	High Ch 19125		Low Ch 18675	Mid Ch 18900	High Ch 19125	
			1857.5 MHz	1880.0 MHz	1902.5 MHz		1857.5 MHz	1880.0 MHz	1902.5 MHz	
2 / 15M	1	0	22.55	22.65	22.68	0	21.48	21.60	21.64	1
	1	37	22.44	22.49	22.52	0	21.38	21.48	21.54	1
	1	74	22.26	22.38	22.47	0	21.28	21.31	21.39	1
	36	0	21.54	21.59	21.67	1	20.42	20.45	20.45	2
	36	19	21.43	21.46	21.52	1	20.38	20.35	20.54	2
	36	39	21.28	21.25	21.39	1	20.27	20.20	20.35	2
	75	0	21.54	21.47	21.58	1	20.46	20.42	20.52	2

Band / BW	RB Size	RB Offset	QPSK			3GPP MPR (dB)	16QAM			3GPP MPR (dB)
			Low Ch 18700	Mid Ch 18900	High Ch 19100		Low Ch 18700	Mid Ch 18900	High Ch 19100	
			1860.0 MHz	1880.0 MHz	1900.0 MHz		1860.0 MHz	1880.0 MHz	1900.0 MHz	
2 / 20M	1	0	22.57	22.68	22.75	0	21.53	21.66	21.68	1
	1	50	22.42	22.55	22.61	0	21.37	21.52	21.58	1
	1	99	22.21	22.36	22.42	0	21.19	21.41	21.53	1
	50	0	21.58	21.64	21.74	1	20.41	20.53	20.57	2
	50	25	21.47	21.52	21.58	1	20.40	20.52	20.61	2
	50	50	21.32	21.26	21.44	1	20.25	20.33	20.28	2
	100	0	21.49	21.50	21.62	1	20.36	20.53	20.64	2

EIRP Power (dBm)

WCDMA							
Plane	Channel	Frequency (MHz)	LVL (dBm)	Correction Factor (dB)	EIRP (dBm)	EIRP (mW)	Polarization (H/V)
Z	9262	1852.4	-29.48	36.57	7.09	5.12	H
	9400	1880.0	-29.88	37.22	7.34	5.43	
	9538	1907.6	-30.06	37.18	7.12	5.15	
	9262	1852.4	-11.56	37.65	26.09	406.54	V
	9400	1880.0	-11.26	37.58	26.32	428.84	
	9538	1907.6	-11.35	37.48	26.13	410.20	

LTE Band 2							
Channel Bandwidth: 1.4 MHz / QPSK							
Plane	Channel	Frequency (MHz)	LVL (dBm)	Correction Factor (dB)	EIRP (dBm)	EIRP (mW)	Polarization (H/V)
Z	18607	1850.7	-25.59	36.57	10.98	12.54	H
	18900	1880.0	-26.17	37.22	11.05	12.75	
	19193	1909.3	-26.23	37.18	10.95	12.45	
	18607	1850.7	-14.53	37.65	23.12	205.16	V
	18900	1880.0	-14.38	37.58	23.20	209.07	
	19193	1909.3	-14.31	37.48	23.17	207.49	
Channel Bandwidth: 1.4 MHz / 16QAM							
Z	18607	1850.7	-25.82	36.57	10.75	11.89	H
	18900	1880.0	-26.43	37.22	10.79	12.01	
	19193	1909.3	-26.51	37.18	10.67	11.67	
	18607	1850.7	-15.11	37.65	22.54	179.51	V
	18900	1880.0	-14.95	37.58	22.63	183.36	
	19193	1909.3	-14.92	37.48	22.56	180.30	

LTE Band 2							
Channel Bandwidth: 3 MHz / QPSK							
Plane	Channel	Frequency (MHz)	LVL (dBm)	Correction Factor (dB)	EIRP (dBm)	EIRP (mW)	Polarization (H/V)
Z	18615	1851.5	-25.41	36.57	11.16	13.07	H
	18900	1880.0	-26.02	37.22	11.20	13.19	
	19185	1908.5	-26.11	37.18	11.07	12.80	
	18615	1851.5	-14.36	37.65	23.29	213.35	V
	18900	1880.0	-14.25	37.58	23.33	215.43	
	19185	1908.5	-14.22	37.48	23.26	211.84	
Channel Bandwidth: 3 MHz / 16QAM							
Z	18615	1851.5	-25.74	36.57	10.83	12.11	H
	18900	1880.0	-26.35	37.22	10.87	12.23	
	19185	1908.5	-26.43	37.18	10.75	11.89	
	18615	1851.5	-15.02	37.65	22.63	183.27	V
	18900	1880.0	-14.83	37.58	22.75	188.50	
	19185	1908.5	-14.83	37.48	22.65	184.08	

LTE Band 2							
Channel Bandwidth: 5 MHz / QPSK							
Plane	Channel	Frequency (MHz)	LVL (dBm)	Correction Factor (dB)	EIRP (dBm)	EIRP (mW)	Polarization (H/V)
Z	18625	1852.5	-25.22	36.57	11.35	13.65	H
	18900	1880.0	-25.82	37.22	11.40	13.82	
	19175	1907.5	-25.80	37.18	11.38	13.75	
	18625	1852.5	-14.28	37.65	23.37	217.32	V
	18900	1880.0	-14.15	37.58	23.43	220.44	
	19175	1907.5	-14.12	37.48	23.36	216.77	
Channel Bandwidth: 5 MHz / 16QAM							
Z	18625	1852.5	-25.65	36.57	10.92	12.37	H
	18900	1880.0	-26.23	37.22	10.99	12.57	
	19175	1907.5	-26.31	37.18	10.87	12.22	
	18625	1852.5	-14.94	37.65	22.71	186.68	V
	18900	1880.0	-14.78	37.58	22.80	190.68	
	19175	1907.5	-14.71	37.48	22.77	189.23	

LTE Band 2							
Channel Bandwidth: 10 MHz / QPSK							
Plane	Channel	Frequency (MHz)	LVL (dBm)	Correction Factor (dB)	EIRP (dBm)	EIRP (mW)	Polarization (H/V)
Z	18650	1855.0	-25.16	36.57	11.41	13.84	H
	18900	1880.0	-25.76	37.22	11.46	14.01	
	19150	1905.0	-25.76	37.18	11.42	13.87	
	18650	1855.0	-14.22	37.65	23.43	220.34	V
	18900	1880.0	-14.03	37.58	23.55	226.62	
	19150	1905.0	-14.01	37.48	23.47	222.33	
Channel Bandwidth: 10 MHz / 16QAM							
Z	18650	1855.0	-25.59	36.57	10.98	12.54	H
	18900	1880.0	-26.19	37.22	11.03	12.69	
	19150	1905.0	-26.24	37.18	10.94	12.42	
	18650	1855.0	-14.82	37.65	22.83	191.91	V
	18900	1880.0	-14.67	37.58	22.91	195.57	
	19150	1905.0	-14.62	37.48	22.86	193.20	

LTE Band 2							
Channel Bandwidth: 15 MHz / QPSK							
Plane	Channel	Frequency (MHz)	LVL (dBm)	Correction Factor (dB)	EIRP (dBm)	EIRP (mW)	Polarization (H/V)
Z	18675	1857.5	-25.05	36.57	11.52	14.20	H
	18900	1880.0	-25.64	37.22	11.58	14.40	
	19125	1902.5	-25.62	37.18	11.56	14.33	
	18675	1857.5	-14.13	37.65	23.52	224.96	V
	18900	1880.0	-13.94	37.58	23.64	231.37	
	19125	1902.5	-13.89	37.48	23.59	228.56	
Channel Bandwidth: 15 MHz / 16QAM							
Z	18675	1857.5	-25.50	36.57	11.07	12.80	H
	18900	1880.0	-26.11	37.22	11.11	12.92	
	19125	1902.5	-26.16	37.18	11.02	12.65	
	18675	1857.5	-14.70	37.65	22.95	197.29	V
	18900	1880.0	-14.52	37.58	23.06	202.44	
	19125	1902.5	-14.51	37.48	22.97	198.15	

LTE Band 2							
Channel Bandwidth: 20 MHz / QPSK							
Plane	Channel	Frequency (MHz)	LVL (dBm)	Correction Factor (dB)	EIRP (dBm)	EIRP (mW)	Polarization (H/V)
Z	18700	1860.0	-24.96	36.57	11.61	14.49	H
	18900	1880.0	-25.57	37.22	11.65	14.64	
	19100	1900.0	-25.55	37.18	11.63	14.56	
	18700	1860.0	-14.05	37.65	23.60	229.14	V
	18900	1880.0	-13.86	37.58	23.72	235.67	
	19100	1900.0	-13.79	37.48	23.69	233.88	
Channel Bandwidth: 20 MHz / 16QAM							
Z	18700	1860.0	-25.43	36.57	11.14	13.01	H
	18900	1880.0	-26.04	37.22	11.18	13.13	
	19100	1900.0	-26.05	37.18	11.13	12.98	
	18700	1860.0	-14.59	37.65	23.06	202.35	V
	18900	1880.0	-14.40	37.58	23.18	208.11	
	19100	1900.0	-14.43	37.48	23.05	201.84	

4.2 Frequency Stability Measurement

4.2.1 Limits of Frequency Stability Measurement

The frequency stability shall be sufficient to ensure that the fundamental emission stays within the authorized frequency block.

4.2.2 Test Procedure

- Device is placed at the oven room. The oven room could control the temperatures and humidity. Power warm up is at least 15 min and power applied should perform before recording frequency error.
- EUT is connected the external power supply to control the DC input power. The test voltage range is from minimum to maximum working voltage. Each step shall be record the frequency error rate.
- The temperature range step is 10 degrees in this test items. All temperature levels shall be hold the ± 0.5 °C during the measurement testing. The each temperature step shall be at least 0.5 hours, consider the EUT could be test under the stability condition.

NOTE: The frequency error was recorded frequency error from the communication simulator.

4.2.3 Test Setup

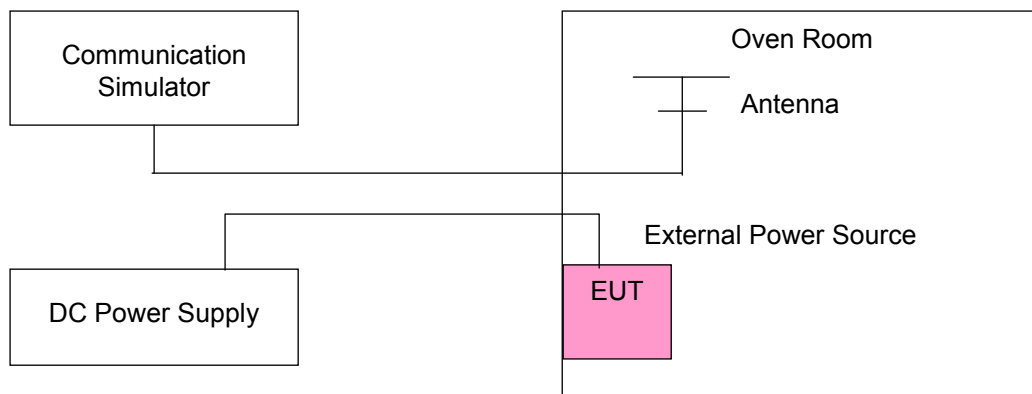

4.2.4 Test Results

Frequency Error vs. Voltage

Voltage (Volts)	WCDMA				Limit (ppm)
	Low Channel		High Channel		
	Frequency (MHz)	Frequency Error (ppm)	Frequency (MHz)	Frequency Error (ppm)	
3.3	1852.400003	0.002	1907.600002	0.001	2.5
3.14	1852.400001	0.001	1907.600002	0.001	2.5
4.4	1852.400003	0.002	1907.600002	0.001	2.5

Note: The applicant defined the normal working voltage of the battery is from 3.14 Vdc to 4.4 Vdc.

Frequency Error vs. Temperature

Temp. (°C)	WCDMA				Limit (ppm)
	Low Channel		High Channel		
	Frequency (MHz)	Frequency Error (ppm)	Frequency (MHz)	Frequency Error (ppm)	
-20	1852.400002	0.001	1907.600002	0.001	2.5
-10	1852.400002	0.001	1907.600001	0.001	2.5
0	1852.400002	0.001	1907.600003	0.001	2.5
10	1852.400003	0.002	1907.600003	0.002	2.5
20	1852.399997	-0.002	1907.599999	-0.001	2.5
30	1852.399997	-0.001	1907.599996	-0.002	2.5
40	1852.399998	-0.001	1907.599998	-0.001	2.5
50	1852.399999	-0.001	1907.599998	-0.001	2.5
55	1852.399997	-0.002	1907.599997	-0.002	2.5

Frequency Error vs. Voltage

Voltage (Volts)	LTE Band 2				Limit (ppm)
	Channel Bandwidth: 1.4 MHz				
	Low Channel		High Channel		
	Frequency (MHz)	Frequency Error (ppm)	Frequency (MHz)	Frequency Error (ppm)	
3.3	1850.700003	0.002	1909.300004	0.002	2.5
3.14	1850.700003	0.002	1909.300003	0.001	2.5
4.4	1850.700002	0.001	1909.300002	0.001	2.5

Note: The applicant defined the normal working voltage of the battery is from 3.14 Vdc to 4.4 Vdc.

Frequency Error vs. Temperature

Temp. (°C)	LTE Band 2				Limit (ppm)
	Channel Bandwidth: 1.4 MHz				
	Low Channel		High Channel		
	Frequency (MHz)	Frequency Error (ppm)	Frequency (MHz)	Frequency Error (ppm)	
-20	1850.700001	0.001	1909.300004	0.002	2.5
-10	1850.700003	0.002	1909.300003	0.001	2.5
0	1850.700002	0.001	1909.300002	0.001	2.5
10	1850.700004	0.002	1909.300002	0.001	2.5
20	1850.699996	-0.002	1909.299998	-0.001	2.5
30	1850.699998	-0.001	1909.299997	-0.002	2.5
40	1850.699997	-0.002	1909.299997	-0.001	2.5
50	1850.699997	-0.002	1909.299998	-0.001	2.5
55	1850.699997	-0.002	1909.299999	-0.001	2.5

Frequency Error vs. Voltage

Voltage (Volts)	LTE Band 2				Limit (ppm)
	Channel Bandwidth: 3 MHz				
	Low Channel		High Channel		
	Frequency (MHz)	Frequency Error (ppm)	Frequency (MHz)	Frequency Error (ppm)	
3.3	1851.500001	0.001	1907.500002	0.001	2.5
3.14	1851.500003	0.001	1907.500001	0.001	2.5
4.4	1851.500004	0.002	1907.500001	0.001	2.5

Note: The applicant defined the normal working voltage of the battery is from 3.14 Vdc to 4.4 Vdc.

Frequency Error vs. Temperature

Temp. (°C)	LTE Band 2				Limit (ppm)
	Channel Bandwidth: 3 MHz				
	Low Channel		High Channel		
	Frequency (MHz)	Frequency Error (ppm)	Frequency (MHz)	Frequency Error (ppm)	
-20	1851.500003	0.002	1907.500001	0.001	2.5
-10	1851.500002	0.001	1907.500002	0.001	2.5
0	1851.500002	0.001	1907.500001	0.001	2.5
10	1851.500003	0.002	1907.500001	0.001	2.5
20	1851.499998	-0.001	1907.499998	-0.001	2.5
30	1851.499998	-0.001	1907.499999	-0.001	2.5
40	1851.499996	-0.002	1907.499997	-0.002	2.5
50	1851.499998	-0.001	1907.499998	-0.001	2.5
55	1851.499997	-0.002	1907.499997	-0.002	2.5

Frequency Error vs. Voltage

Voltage (Volts)	LTE Band 2				Limit (ppm)
	Channel Bandwidth: 5 MHz				
	Low Channel		High Channel		
	Frequency (MHz)	Frequency Error (ppm)	Frequency (MHz)	Frequency Error (ppm)	
3.3	1852.500002	0.001	1907.500004	0.002	2.5
3.14	1852.500003	0.002	1907.500002	0.001	2.5
4.4	1852.500001	0.001	1907.500002	0.001	2.5

Note: The applicant defined the normal working voltage of the battery is from 3.14 Vdc to 4.4 Vdc.

Frequency Error vs. Temperature

Temp. (°C)	LTE Band 2				Limit (ppm)
	Channel Bandwidth: 5 MHz				
	Low Channel		High Channel		
	Frequency (MHz)	Frequency Error (ppm)	Frequency (MHz)	Frequency Error (ppm)	
-20	1852.500001	0.001	1907.500002	0.001	2.5
-10	1852.500003	0.002	1907.500003	0.001	2.5
0	1852.500001	0.001	1907.500004	0.002	2.5
10	1852.500003	0.001	1907.500004	0.002	2.5
20	1852.499998	-0.001	1907.499996	-0.002	2.5
30	1852.499999	-0.001	1907.499999	-0.001	2.5
40	1852.499997	-0.002	1907.499998	-0.001	2.5
50	1852.499999	-0.001	1907.499996	-0.002	2.5
55	1852.499999	-0.001	1907.499996	-0.002	2.5

Frequency Error vs. Voltage

Voltage (Volts)	LTE Band 2				Limit (ppm)
	Channel Bandwidth: 10 MHz				
	Low Channel		High Channel		
	Frequency (MHz)	Frequency Error (ppm)	Frequency (MHz)	Frequency Error (ppm)	
3.3	1855.000002	0.001	1905.000002	0.001	2.5
3.14	1855.000001	0.001	1905.000002	0.001	2.5
4.4	1855.000001	0.001	1905.000002	0.001	2.5

Note: The applicant defined the normal working voltage of the battery is from 3.14 Vdc to 4.4 Vdc.

Frequency Error vs. Temperature

Temp. (°C)	LTE Band 2				Limit (ppm)
	Channel Bandwidth: 10 MHz				
	Low Channel		High Channel		
	Frequency (MHz)	Frequency Error (ppm)	Frequency (MHz)	Frequency Error (ppm)	
-20	1855.000004	0.002	1905.000004	0.002	2.5
-10	1855.000003	0.001	1905.000001	0.001	2.5
0	1855.000001	0.001	1905.000002	0.001	2.5
10	1855.000003	0.002	1905.000004	0.002	2.5
20	1854.999997	-0.002	1904.999998	-0.001	2.5
30	1854.999998	-0.001	1904.999996	-0.002	2.5
40	1854.999999	-0.001	1904.999998	-0.001	2.5
50	1854.999999	-0.001	1904.999997	-0.002	2.5
55	1854.999997	-0.001	1904.999999	-0.001	2.5

Frequency Error vs. Voltage

Voltage (Volts)	LTE Band 2				Limit (ppm)
	Channel Bandwidth: 15 MHz				
	Low Channel		High Channel		
	Frequency (MHz)	Frequency Error (ppm)	Frequency (MHz)	Frequency Error (ppm)	
3.3	1857.500004	0.002	1902.500002	0.001	2.5
3.14	1857.500003	0.002	1902.500002	0.001	2.5
4.4	1857.500001	0.001	1902.500004	0.002	2.5

Note: The applicant defined the normal working voltage of the battery is from 3.14 Vdc to 4.4 Vdc.

Frequency Error vs. Temperature

Temp. (°C)	LTE Band 2				Limit (ppm)
	Channel Bandwidth: 15 MHz				
	Low Channel		High Channel		
	Frequency (MHz)	Frequency Error (ppm)	Frequency (MHz)	Frequency Error (ppm)	
-20	1857.500002	0.001	1902.500002	0.001	2.5
-10	1857.500004	0.002	1902.500003	0.002	2.5
0	1857.500004	0.002	1902.500001	0.001	2.5
10	1857.500002	0.001	1902.500003	0.002	2.5
20	1857.499996	-0.002	1902.499996	-0.002	2.5
30	1857.499998	-0.001	1902.499999	-0.001	2.5
40	1857.499997	-0.002	1902.499997	-0.002	2.5
50	1857.499998	-0.001	1902.499997	-0.001	2.5
55	1857.499999	-0.001	1902.499997	-0.002	2.5

Frequency Error vs. Voltage

Voltage (Volts)	LTE Band 2				Limit (ppm)
	Channel Bandwidth: 20 MHz				
	Low Channel		High Channel		
	Frequency (MHz)	Frequency Error (ppm)	Frequency (MHz)	Frequency Error (ppm)	
3.3	1860.000004	0.002	1900.000001	0.001	2.5
3.14	1860.000003	0.002	1900.000003	0.002	2.5
4.4	1860.000003	0.002	1900.000003	0.001	2.5

Note: The applicant defined the normal working voltage of the battery is from 3.14 Vdc to 4.4 Vdc.

Frequency Error vs. Temperature

Temp. (°C)	LTE Band 2				Limit (ppm)
	Channel Bandwidth: 20 MHz				
	Low Channel		High Channel		
	Frequency (MHz)	Frequency Error (ppm)	Frequency (MHz)	Frequency Error (ppm)	
-20	1860.000003	0.002	1900.000003	0.002	2.5
-10	1860.000003	0.001	1900.000003	0.002	2.5
0	1860.000004	0.002	1900.000001	0.001	2.5
10	1860.000003	0.002	1900.000003	0.002	2.5
20	1859.999998	-0.001	1899.999996	-0.002	2.5
30	1859.999996	-0.002	1899.999997	-0.002	2.5
40	1859.999999	-0.001	1899.999999	-0.001	2.5
50	1859.999999	-0.001	1899.999997	-0.002	2.5
55	1859.999996	-0.002	1899.999998	-0.001	2.5

4.3 Occupied Bandwidth Measurement

4.3.1 Test Procedure

The EUT makes a call to the communication simulator. All measurements were done at low, middle and high operational frequency range. The communication simulator station system controlled a EUT to export maximum output power under transmission mode and specific channel frequency. Use OBW measurement function of Spectrum analyzer to measure 99 % occupied bandwidth.

4.3.2 Test Setup

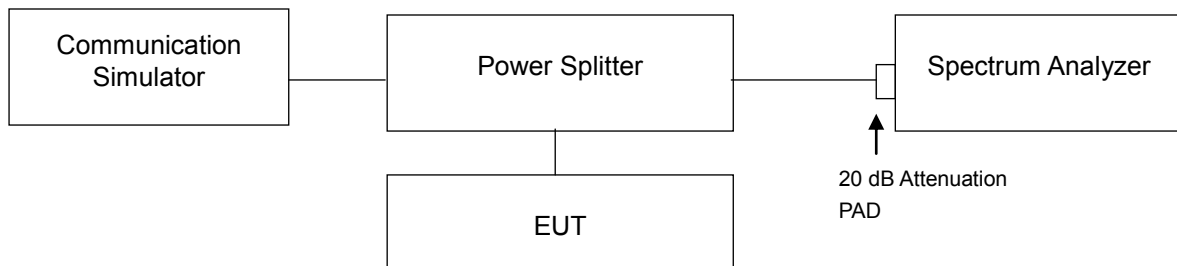

4.3.3 Test Result

Channel	Frequency (MHz)	99 % Occupied Bandwidth (MHz)
		WCDMA
9262	1852.4	4.09
9400	1880.0	4.09
9538	1907.6	4.14

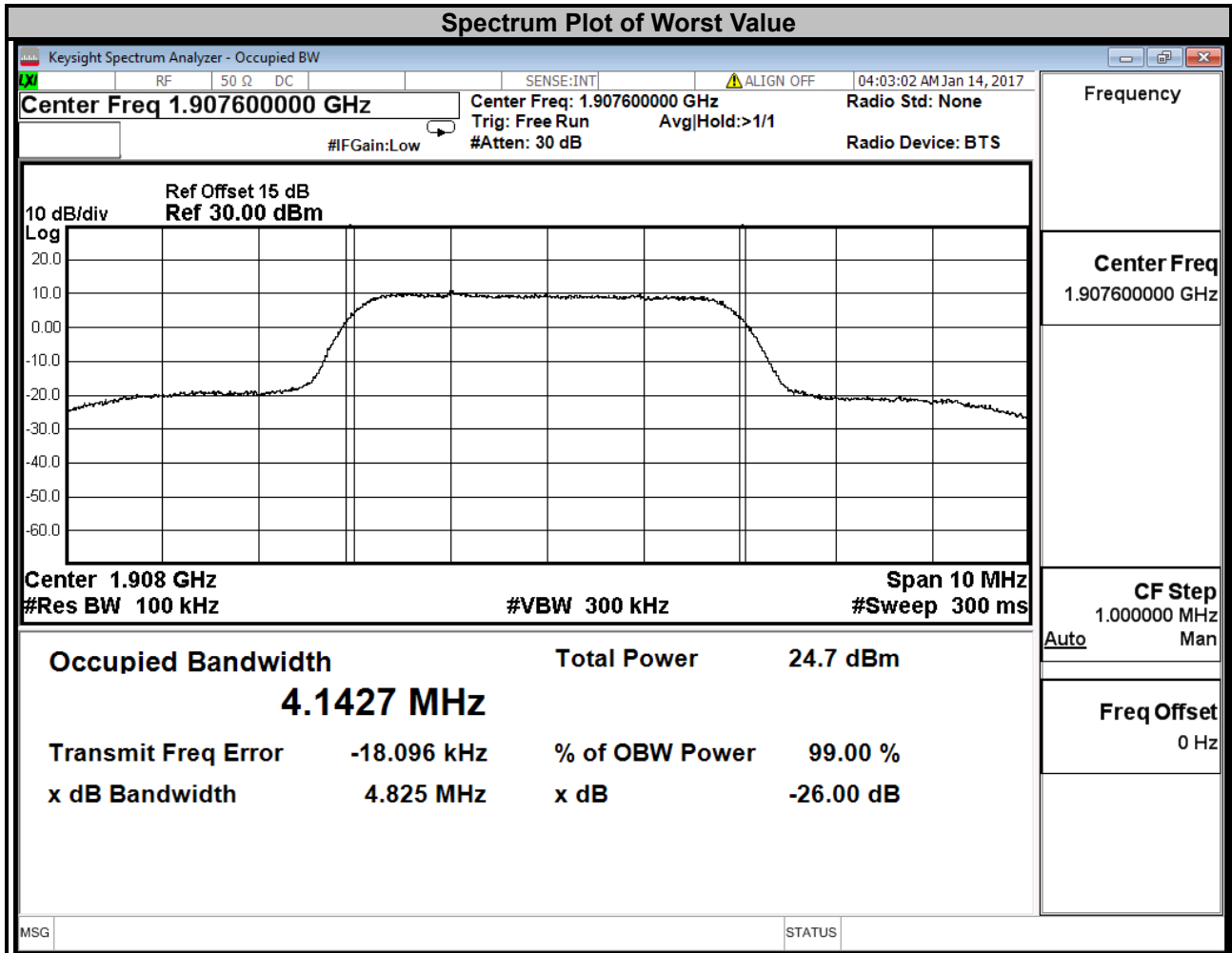

LTE Band 2

Channel Bandwidth: 1.4 MHz				Channel Bandwidth: 3 MHz			
Channel	Frequency (MHz)	99 % Occupied Bandwidth (MHz)		Channel	Frequency (MHz)	99 % Occupied Bandwidth (MHz)	
		QPSK	16QAM			QPSK	16QAM
18607	1850.7	1.09	1.10	18615	1851.5	2.70	2.70
18900	1880.0	1.09	1.10	18900	1880.0	2.70	2.70
19193	1909.3	1.10	1.10	19185	1908.5	2.70	2.70

Spectrum Plot of Worst Value

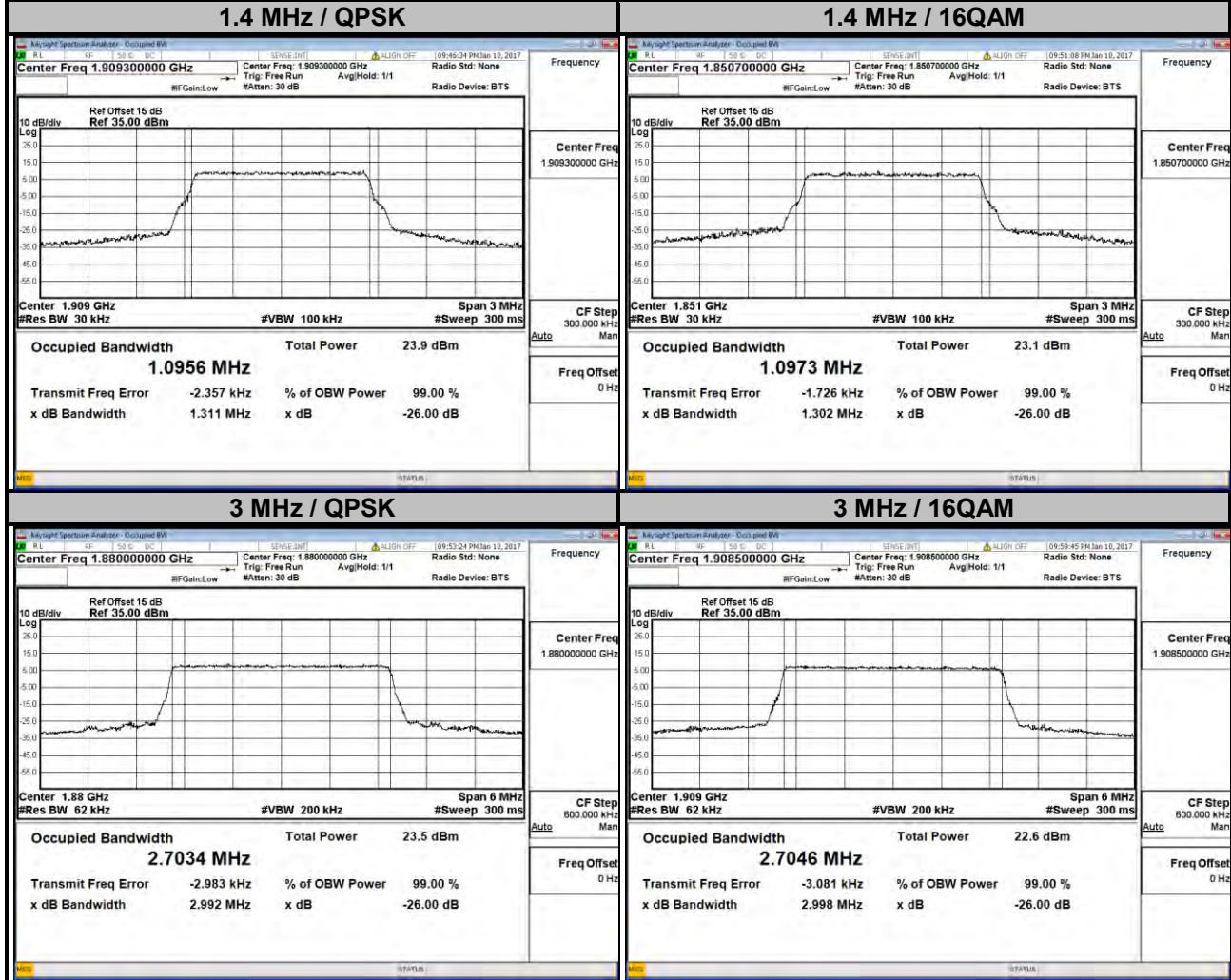

LTE Band 2

Channel Bandwidth: 5 MHz				Channel Bandwidth: 10 MHz			
Channel	Frequency (MHz)	99 % Occupied Bandwidth (MHz)		Channel	Frequency (MHz)	99 % Occupied Bandwidth (MHz)	
		QPSK	16QAM			QPSK	16QAM
18625	1852.5	4.50	4.50	18650	1855.0	9.00	9.00
18900	1880.0	4.50	4.50	18900	1880.0	8.98	8.99
19175	1907.5	4.50	4.50	19150	1905.0	8.97	8.97

Spectrum Plot of Worst Value

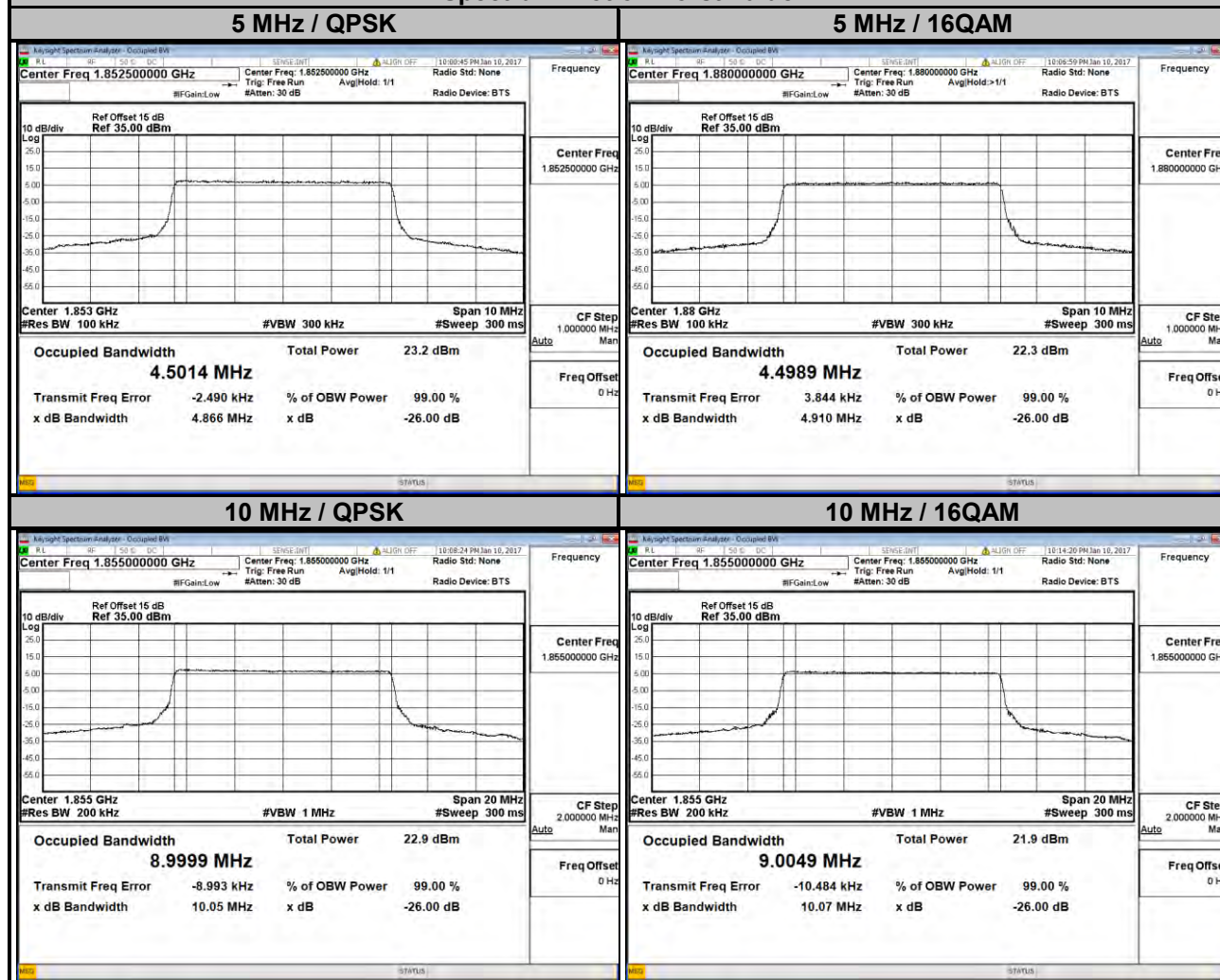

LTE Band 2

Channel Bandwidth: 15 MHz				Channel Bandwidth: 20 MHz			
Channel	Frequency (MHz)	99 % Occupied Bandwidth (MHz)		Channel	Frequency (MHz)	99 % Occupied Bandwidth (MHz)	
		QPSK	16QAM			QPSK	16QAM
18675	1857.5	13.50	13.49	18700	1860.0	18.03	18.02
18900	1880.0	13.45	13.44	18900	1880.0	17.93	17.92
19125	1902.5	13.45	13.44	19100	1900.0	17.99	17.97

Spectrum Plot of Worst Value

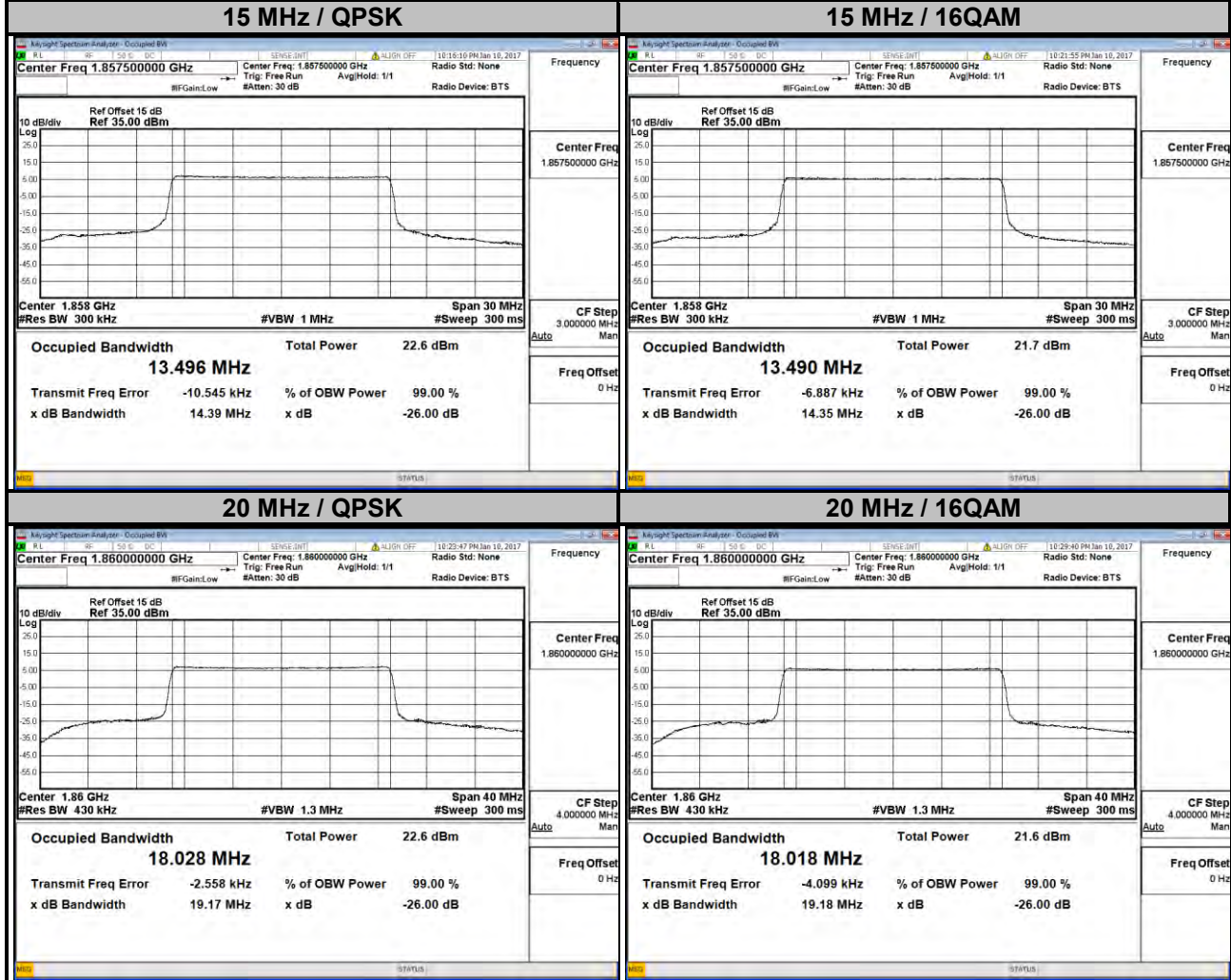

4.4 Band Edge Measurement

4.4.1 Limits of Band Edge Measurement

Power of any emission outside of the authorized operating frequency ranges must be attenuated below the transmitting power (P) by a factor of at least $43 + 10 \log(P)$ dB. In the 1 MHz bands immediately outside and adjacent to the frequency block a resolution bandwidth of at least one percent of the emission bandwidth of the fundamental emission of the transmitter may be employed.

4.4.2 Test Setup

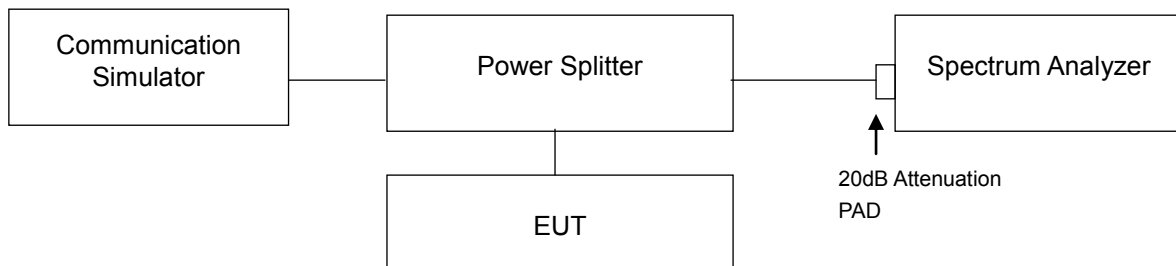

4.4.3 Test Procedures

- All measurements were done at low and high operational frequency range.
- The center frequency of spectrum is the band edge frequency and span is 5 MHz. RB of the spectrum is 100 kHz and VB of the spectrum is 300 kHz (WCDMA).
- The center frequency of spectrum is the band edge frequency and span is 1 MHz. RB of the spectrum is 13 kHz and VB of the spectrum is 51 kHz (LTE Bandwidth 1.4 MHz).
- The center frequency of spectrum is the band edge frequency and span is 1 MHz. RB of the spectrum is 30 kHz and VB of the spectrum is 100 kHz (LTE Bandwidth 3 MHz).
- The center frequency of spectrum is the band edge frequency and span is 1 MHz. RB of the spectrum is 100 kHz and VB of the spectrum is 300 kHz (LTE Bandwidth 5 MHz/10 MHz).
- The center frequency of spectrum is the band edge frequency and span is 1 MHz. RB of the spectrum is 150 kHz and VB of the spectrum is 470 kHz (LTE Bandwidth 15 MHz).
- The center frequency of spectrum is the band edge frequency and span is 1 MHz. RB of the spectrum is 180 kHz and VB of the spectrum is 560 kHz (LTE Bandwidth 20 MHz).
- Record the max trace plot into the test report.

4.4.4 Test Results

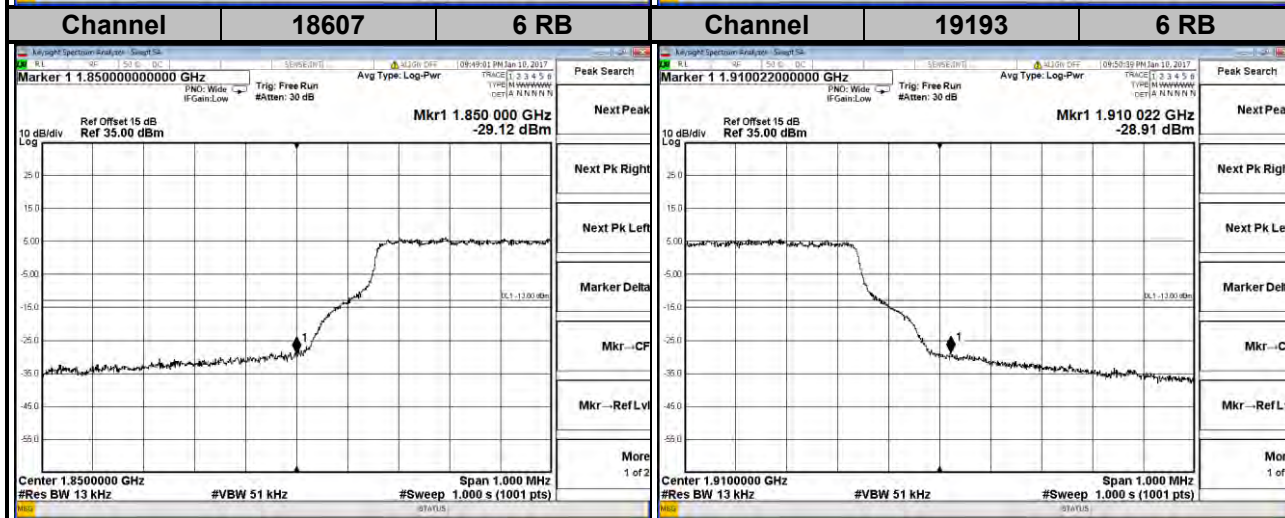
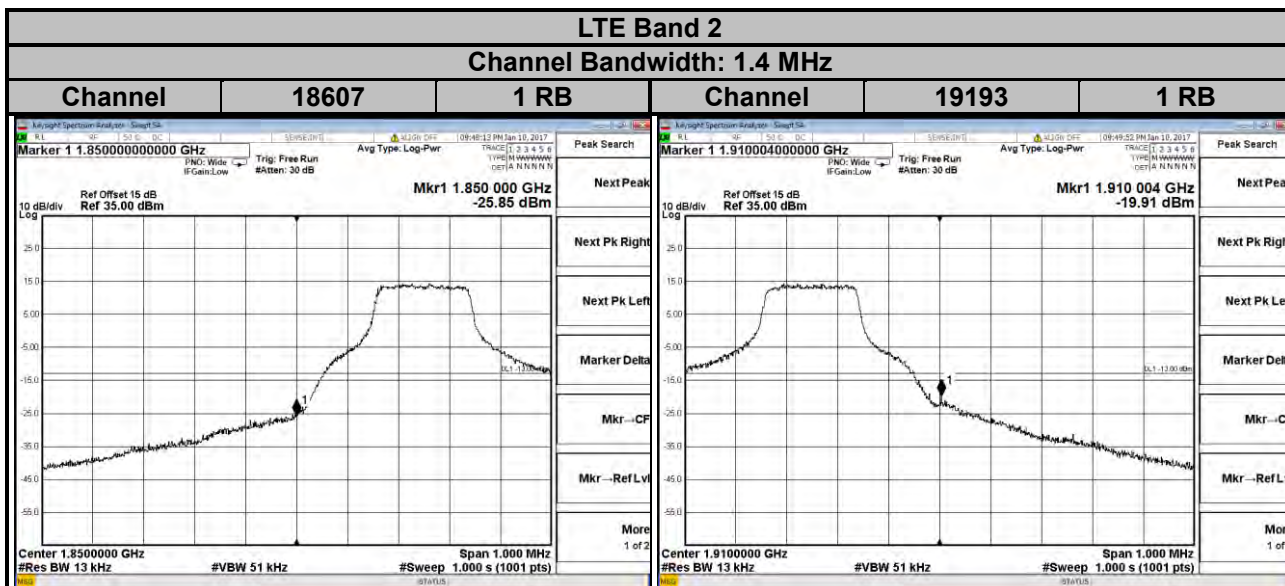
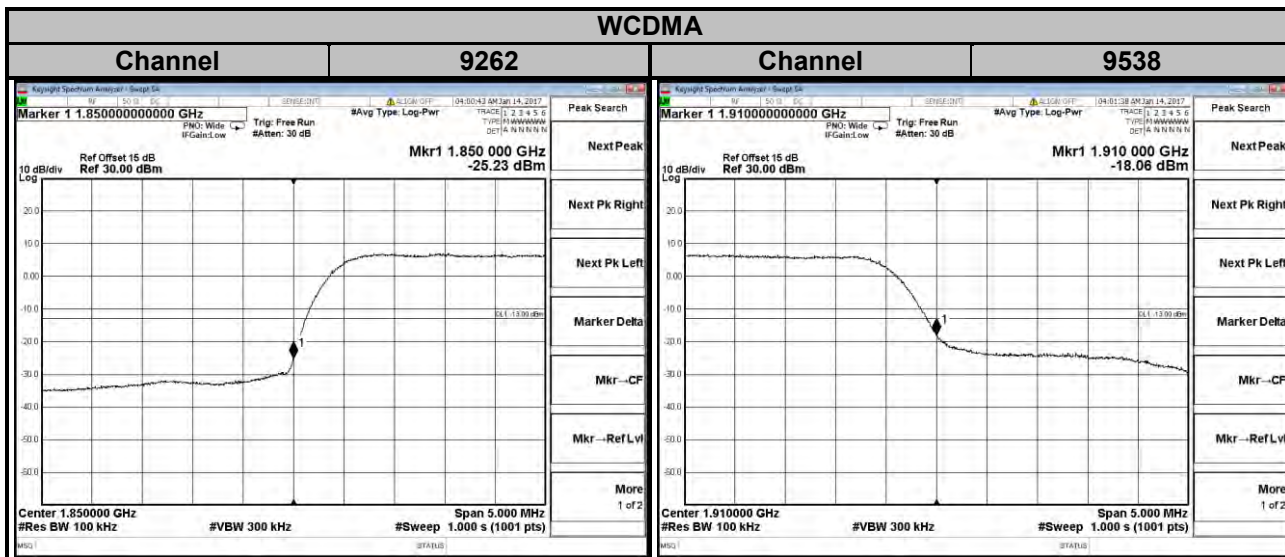

LTE Band 2
Channel Bandwidth: 3 MHz

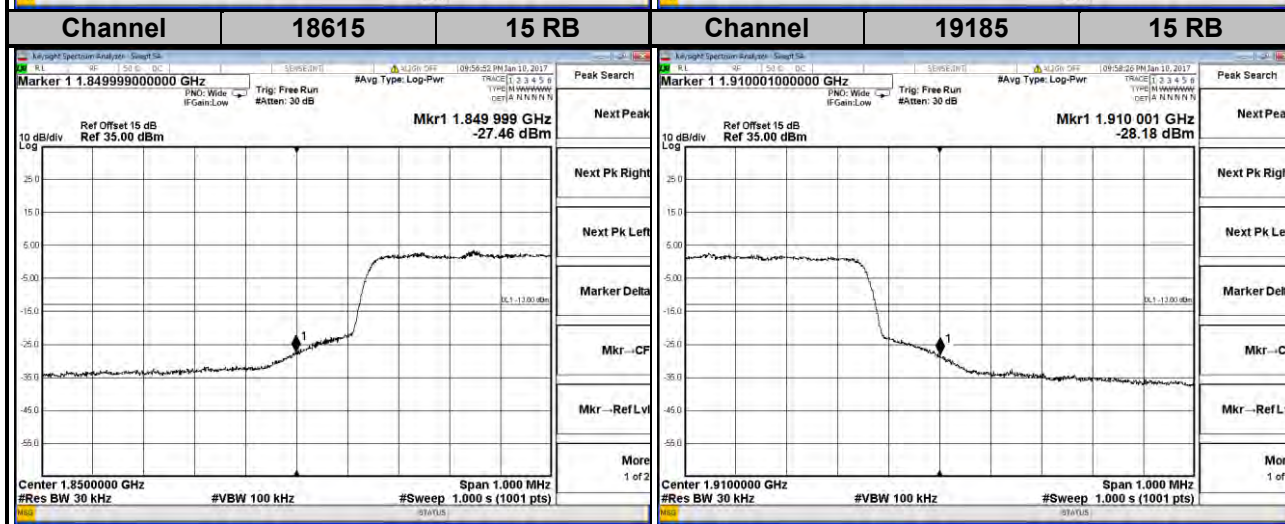
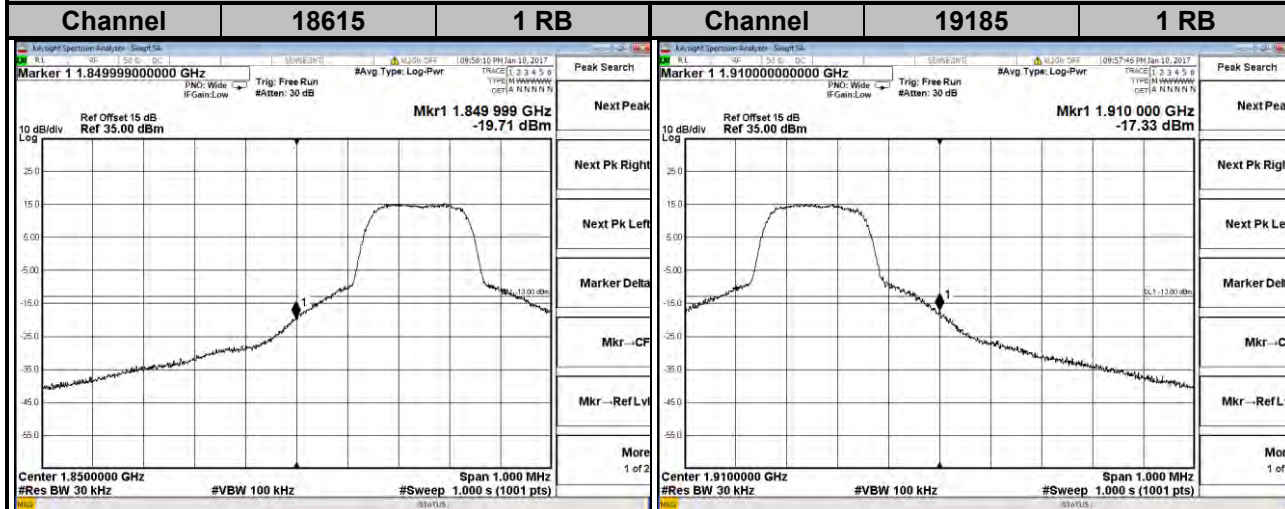

LTE Band 2
Channel Bandwidth: 5 MHz

Channel	18625	1 RB	Channel	19175	1 RB
----------------	--------------	-------------	----------------	--------------	-------------

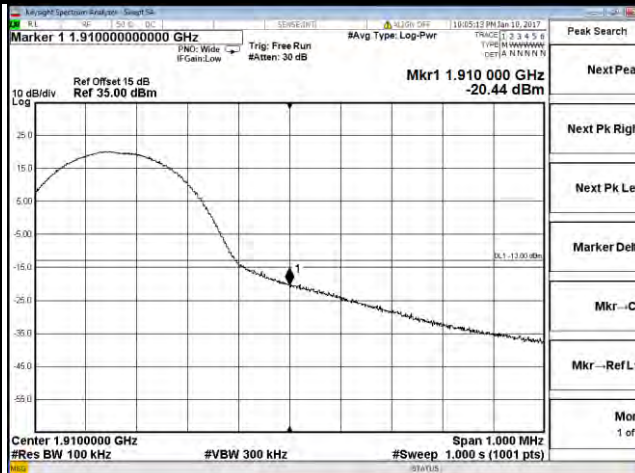
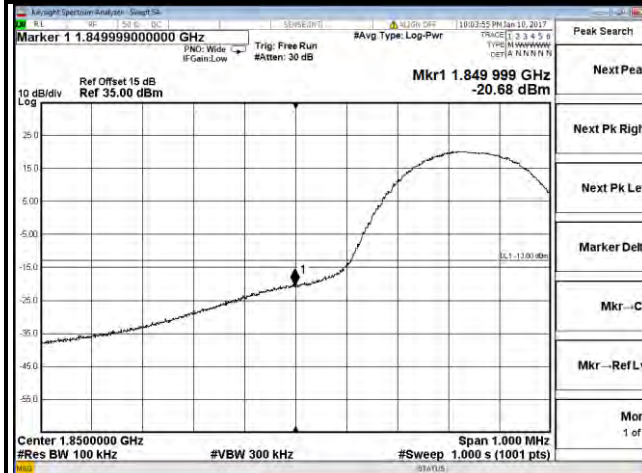

Channel	18625	25 RB	Channel	19175	25 RB
----------------	--------------	--------------	----------------	--------------	--------------

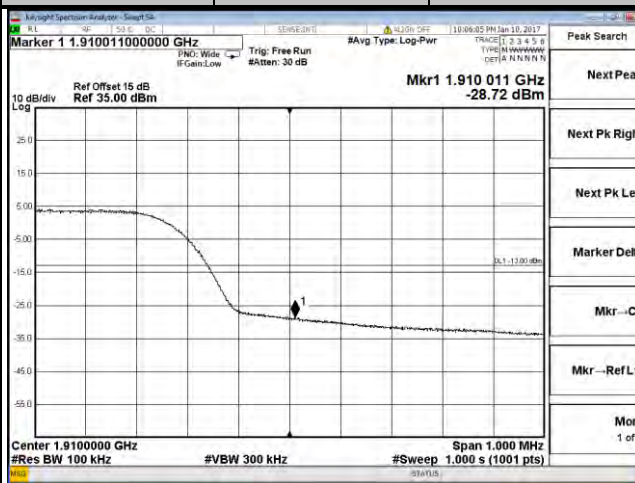
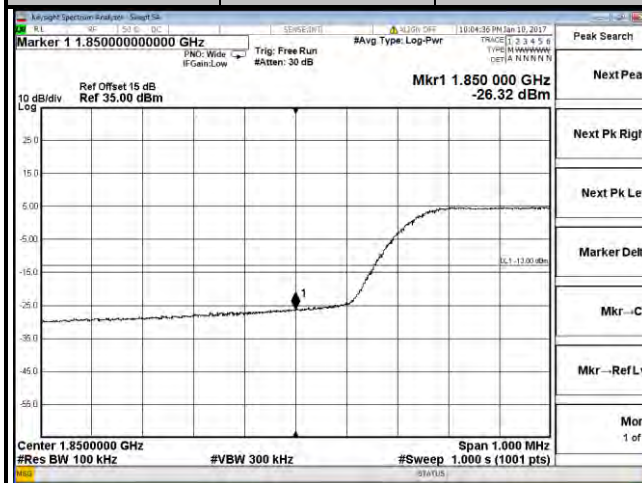

LTE Band 2
Channel Bandwidth: 10 MHz

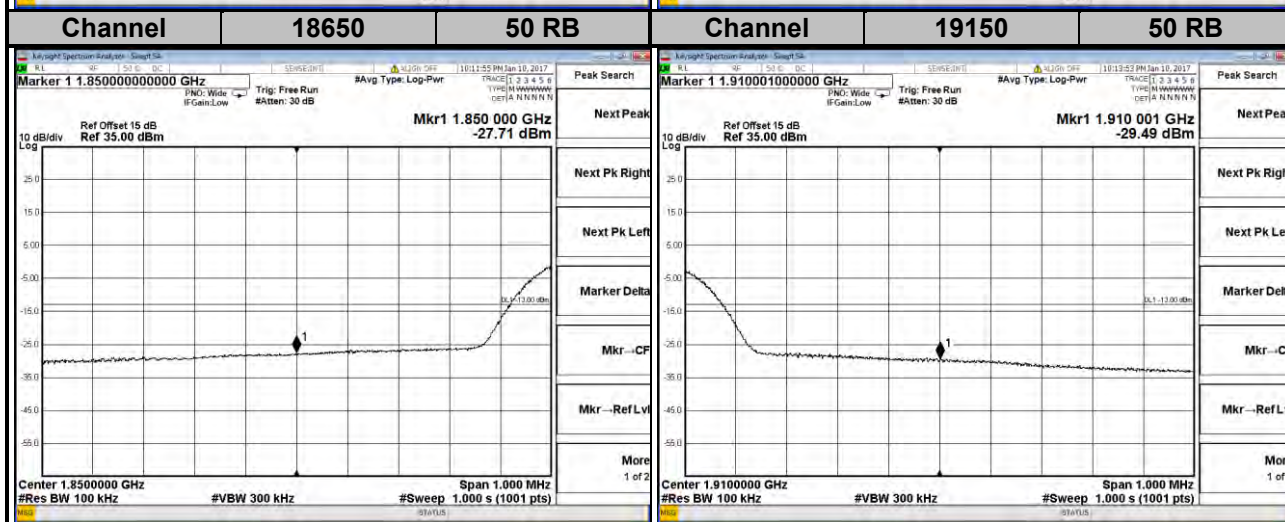
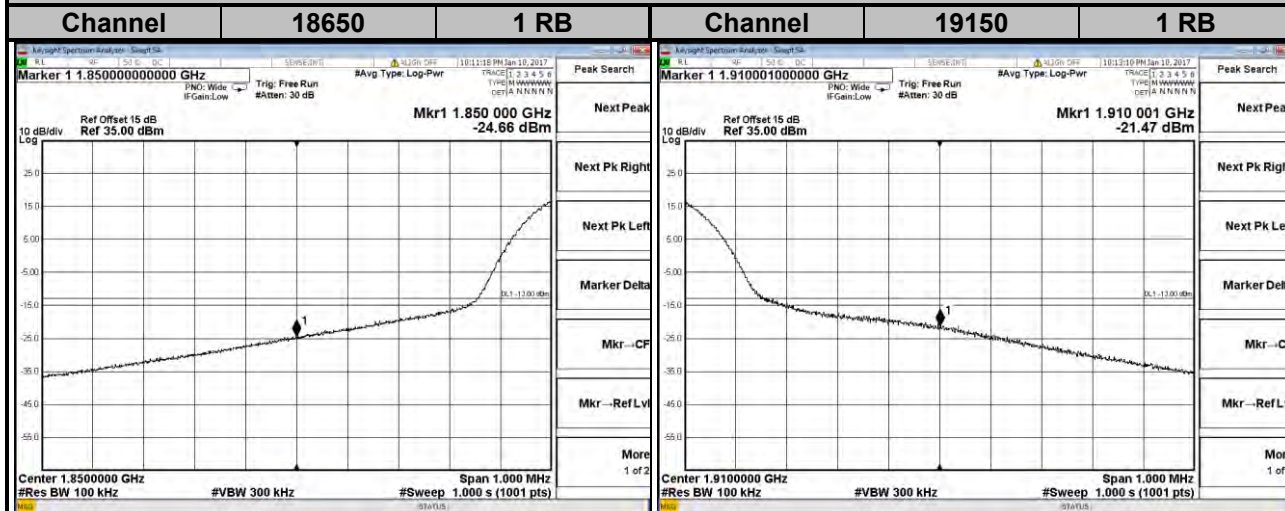

LTE Band 2
Channel Bandwidth: 15 MHz

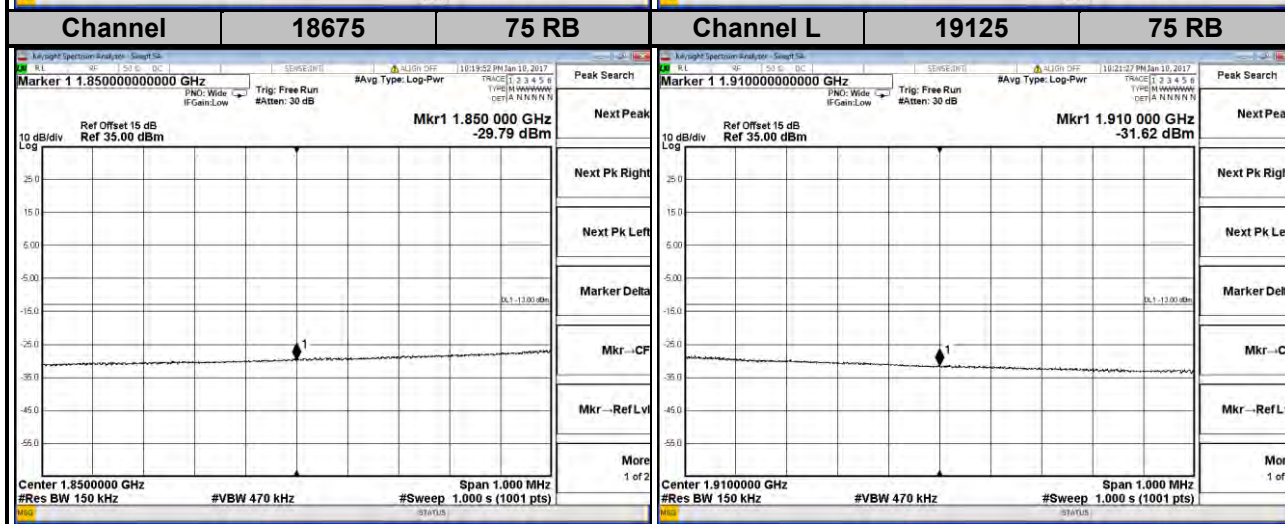
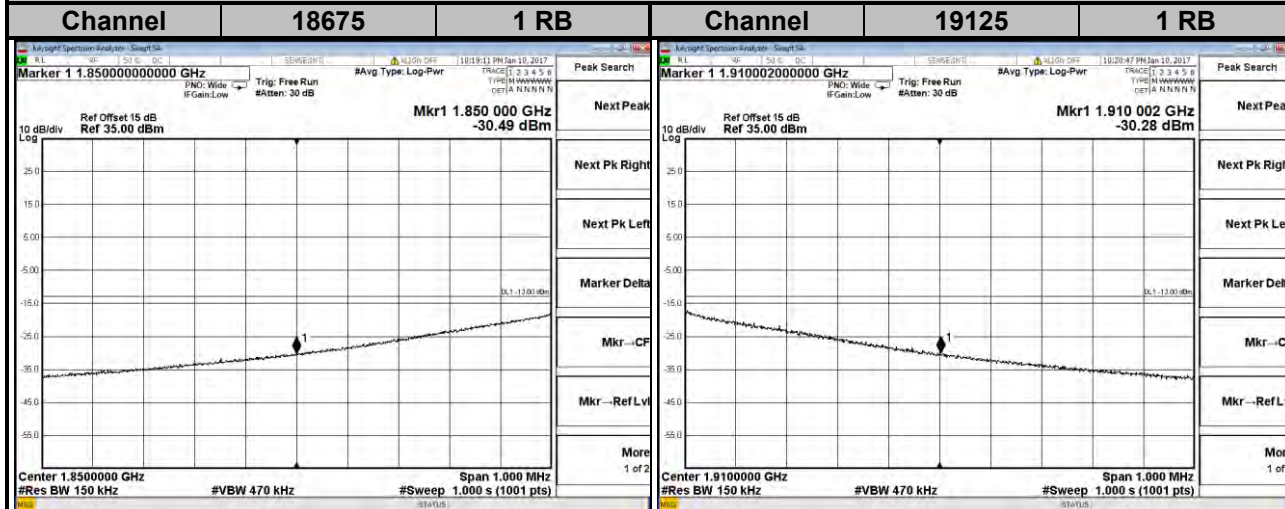

LTE Band 2
Channel Bandwidth: 20 MHz

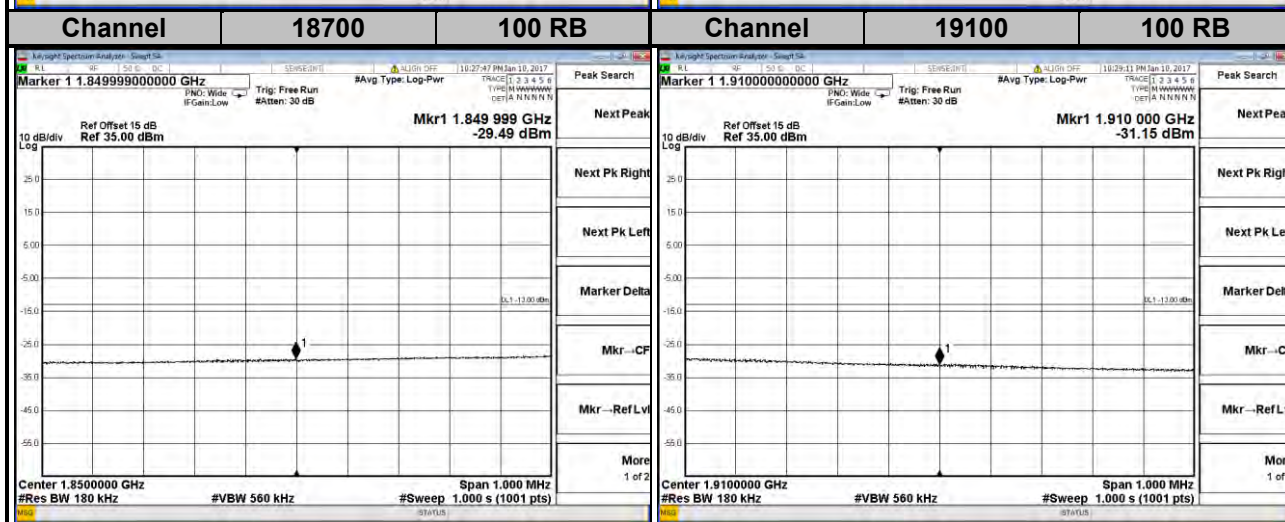
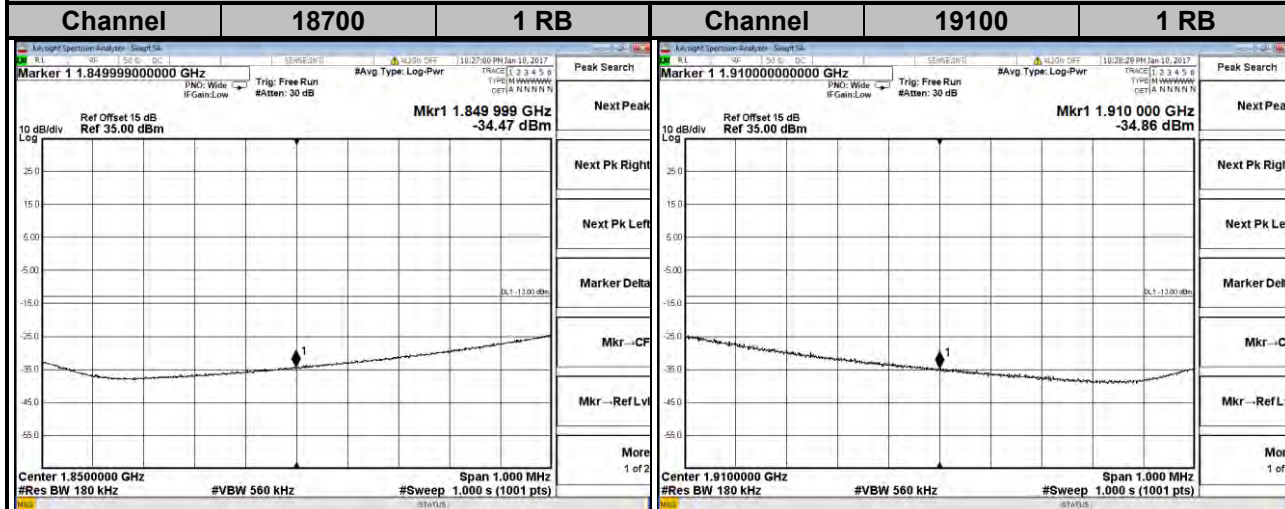

4.5 Peak to Average Ratio

4.5.1 Limits of Peak to Average Ratio Measurement

In measuring transmissions in this band using an average power technique, the peak to-average ratio (PAR) of the transmission may not exceed 13 dB.

4.5.2 Test Setup

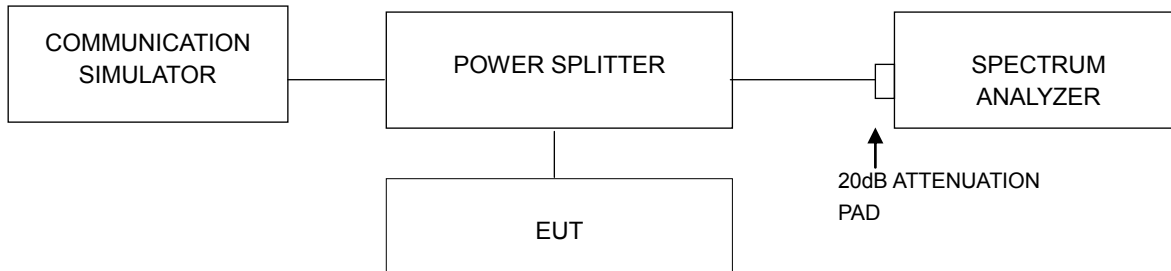

4.5.3 Test Procedures

1. Set resolution/measurement bandwidth \geq signal's occupied bandwidth;
2. Set the number of counts to a value that stabilizes the measured CCDF curve;
3. Record the maximum PAPR level associated with a probability of 0.1 %.

4.5.4 Test Results

Channel	Frequency (MHz)	Peak to Average Ratio (dB)
		WCDMA
9262	1852.4	3.06
9400	1880.0	3.08
9538	1907.6	2.26

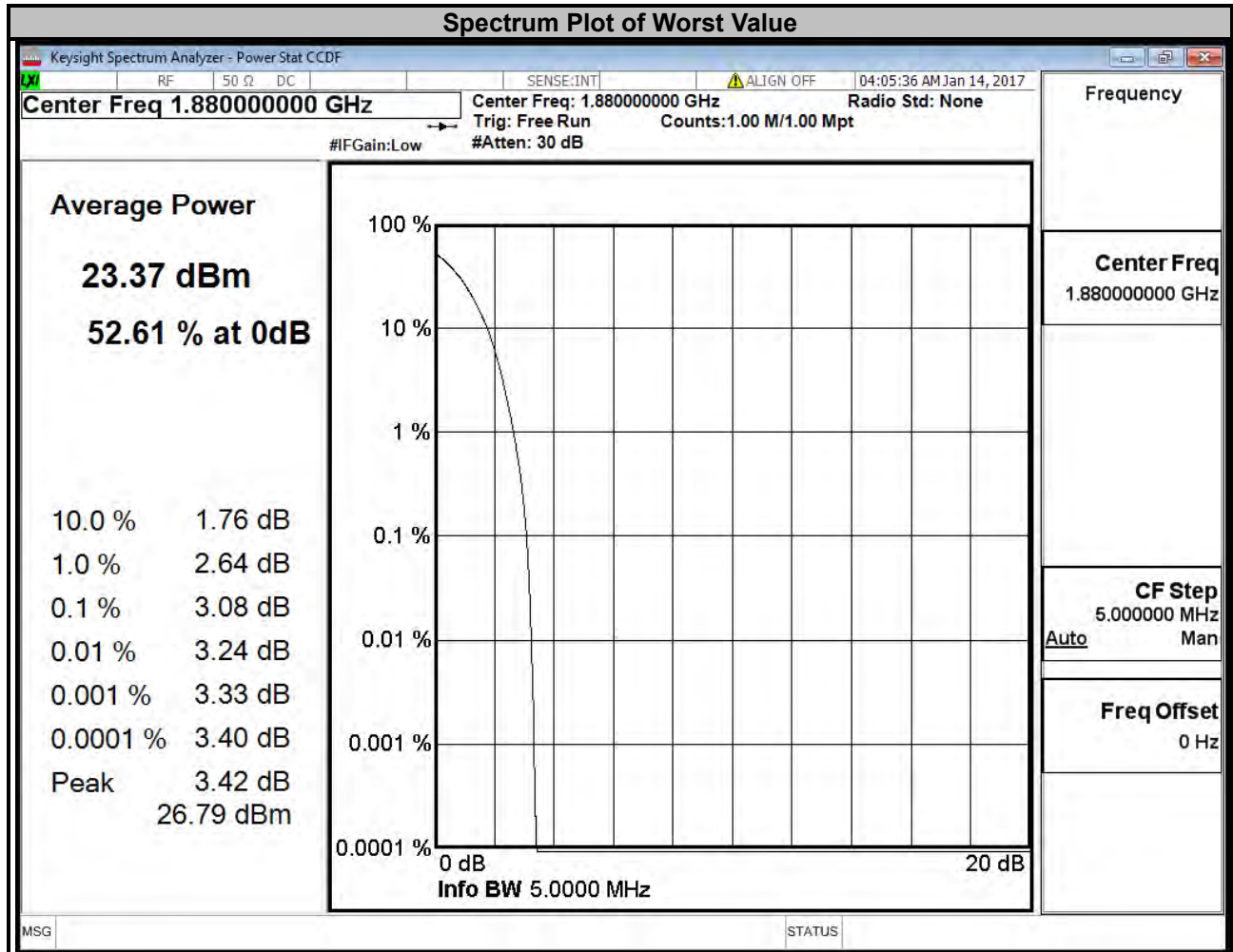

LTE Band 2

Channel Bandwidth: 1.4 MHz				Channel Bandwidth: 3 MHz			
Channel	Frequency (MHz)	Peak to Average Ratio (dB)		Channel	Frequency (MHz)	Peak to Average Ratio (dB)	
		QPSK	16QAM			QPSK	16QAM
18607	1850.7	5.43	5.09	18615	1851.5	5.51	5.06
18900	1880.0	5.97	5.84	18900	1880.0	6.09	5.92
19193	1909.3	4.63	5.23	19185	1908.5	5.11	5.77

Spectrum Plot of Worst Value

1.4 MHz / QPSK

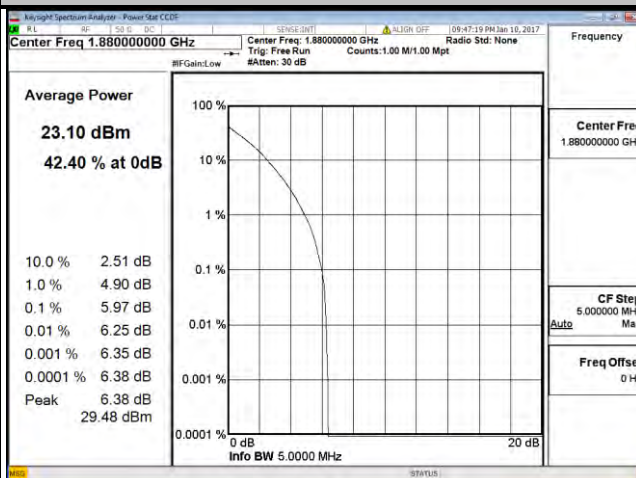

1.4 MHz / 16QAM

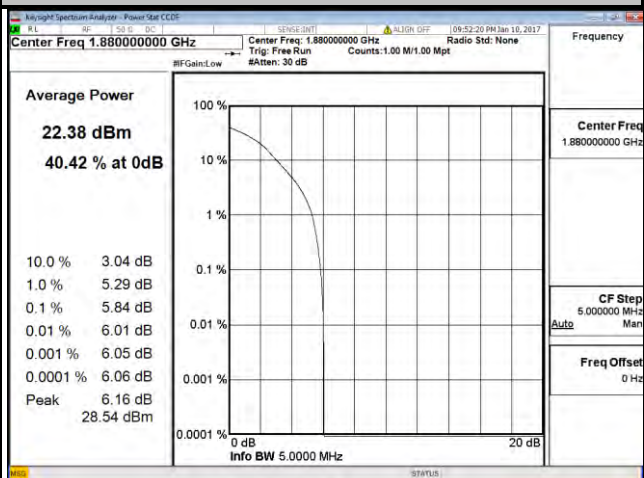

3 MHz / QPSK

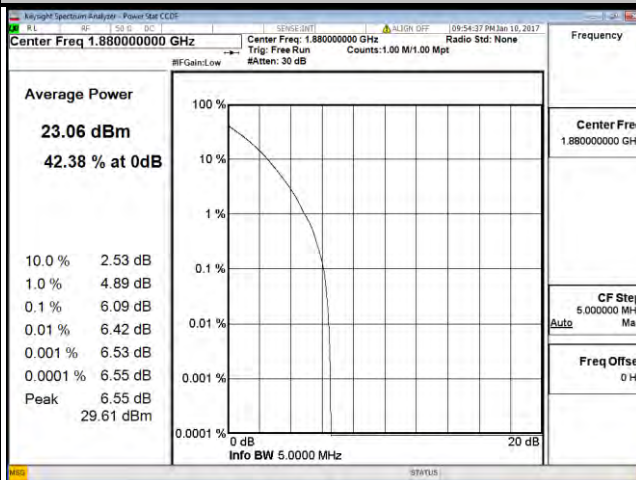

3 MHz / 16QAM

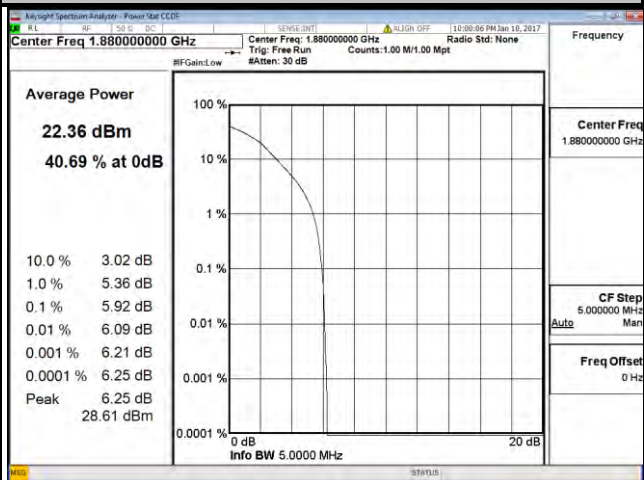

LTE Band 2

Channel Bandwidth: 5 MHz				Channel Bandwidth: 10 MHz			
Channel	Frequency (MHz)	Peak to Average Ratio (dB)		Channel	Frequency (MHz)	Peak to Average Ratio (dB)	
		QPSK	16QAM			QPSK	16QAM
18625	1852.5	5.46	5.09	18650	1855.0	5.53	5.10
18900	1880.0	6.06	5.95	18900	1880.0	6.11	6.05
19175	1907.5	5.76	6.48	19150	1905.0	6.52	7.14

Spectrum Plot of Worst Value

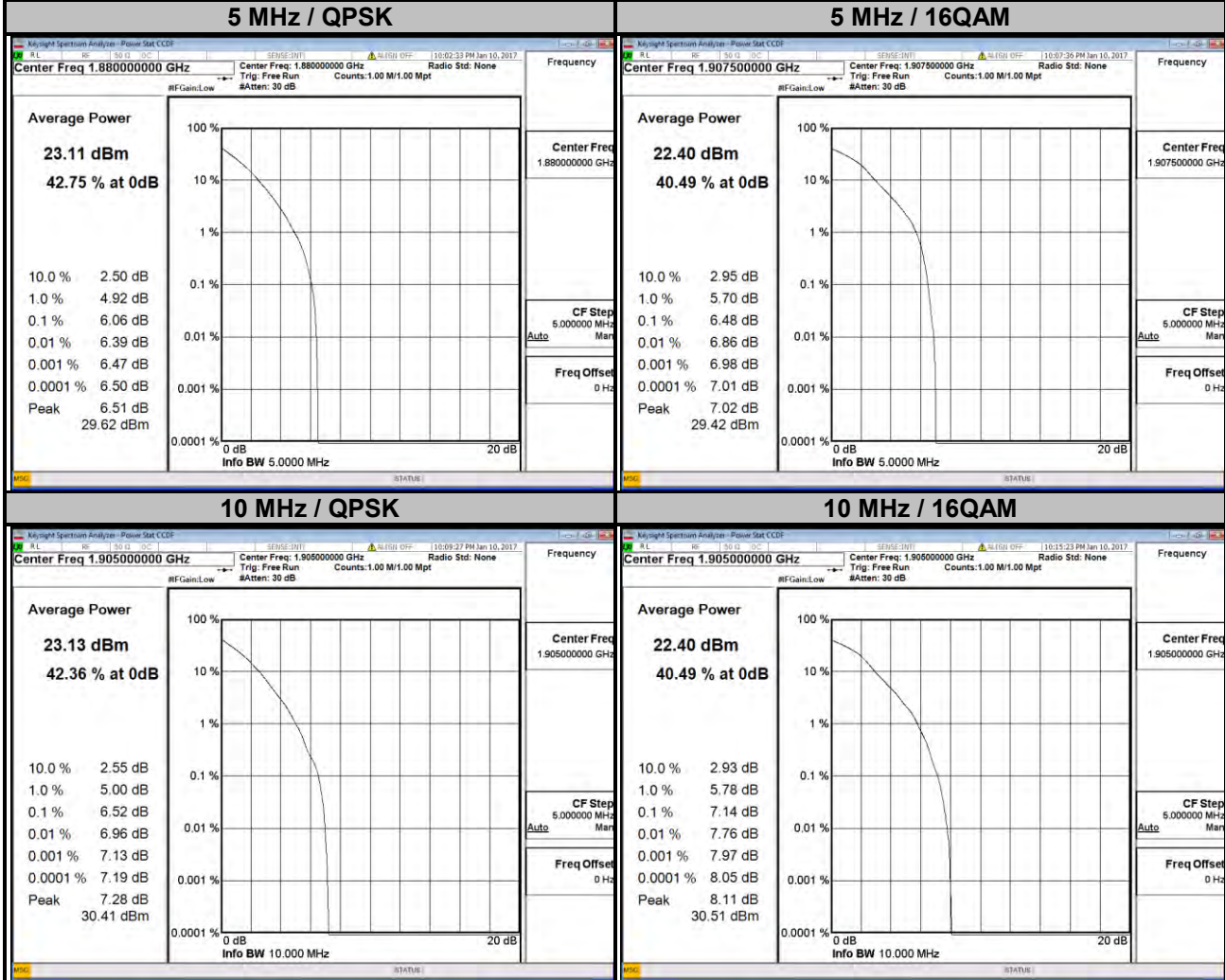

LTE Band 2

Channel Bandwidth: 15 MHz

Channel Bandwidth: 20 MHz

Channel	Frequency (MHz)	Peak to Average Ratio (dB)		Channel	Frequency (MHz)	Peak to Average Ratio (dB)	
		QPSK	16QAM			QPSK	16QAM
18675	1857.5	5.62	5.21	18700	1860.0	5.75	5.33
18900	1880.0	6.15	6.17	18900	1880.0	6.33	6.29
19125	1902.5	6.42	7.33	19100	1900.0	6.46	6.92

Spectrum Plot of Worst Value

15 MHz / QPSK

15 MHz / 16QAM

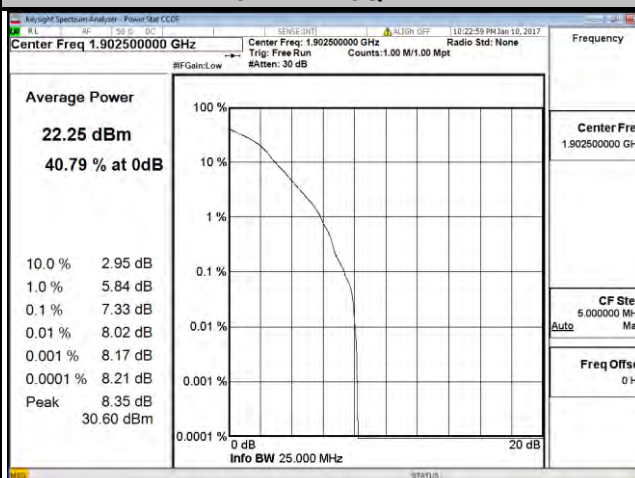
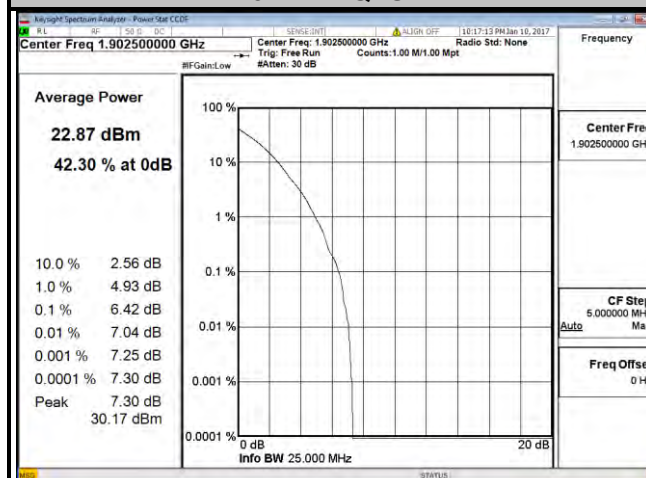

20 MHz / QPSK

20 MHz / 16QAM

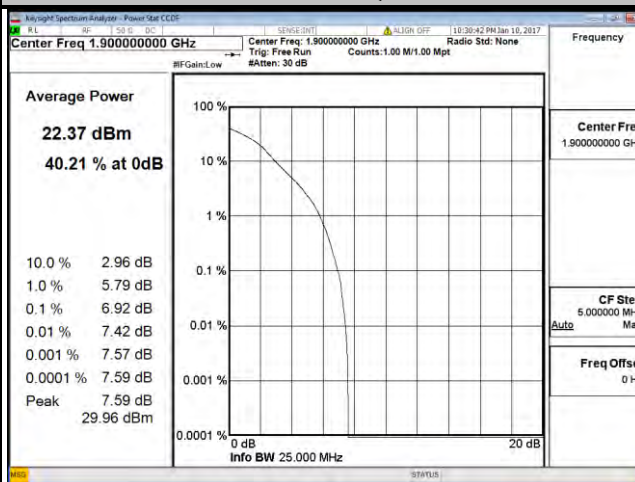
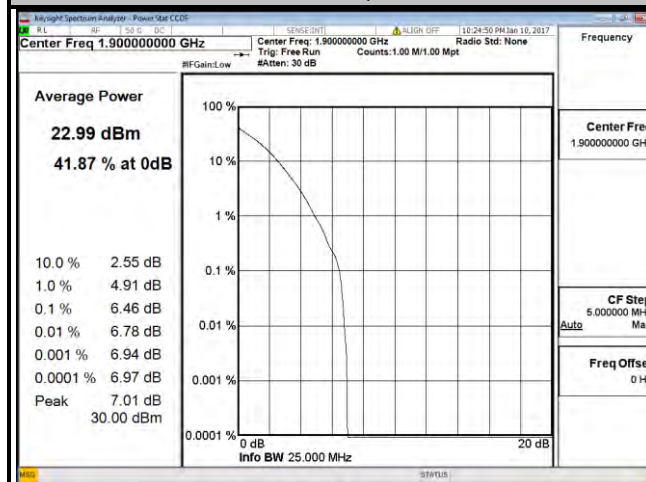

4.6 Conducted Spurious Emissions

4.6.1 Limits of Conducted Spurious Emissions Measurement

The power of any emission outside of the authorized operating frequency ranges must be attenuated below the transmitting power (P) by a factor of at least $43 + 10 \log(P)$ dB. The emission limit equal to -13 dBm.

4.6.2 Test Setup

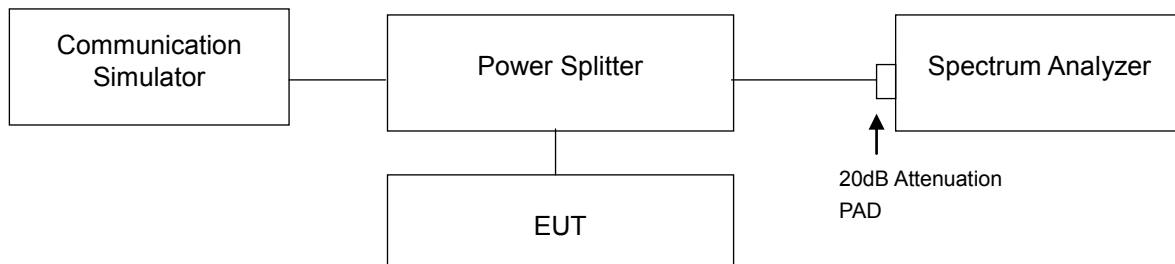

4.6.3 Test Procedure

- The EUT makes a phone call to the communication simulator. All measurements were done at low, middle and high operational frequency range.
- Measuring frequency range is from 9 kHz to 9 GHz. 20 dB attenuation pad is connected with spectrum. RBW=1 MHz and VBW=3 MHz is used for conducted emission measurement.

4.6.4 Test Results

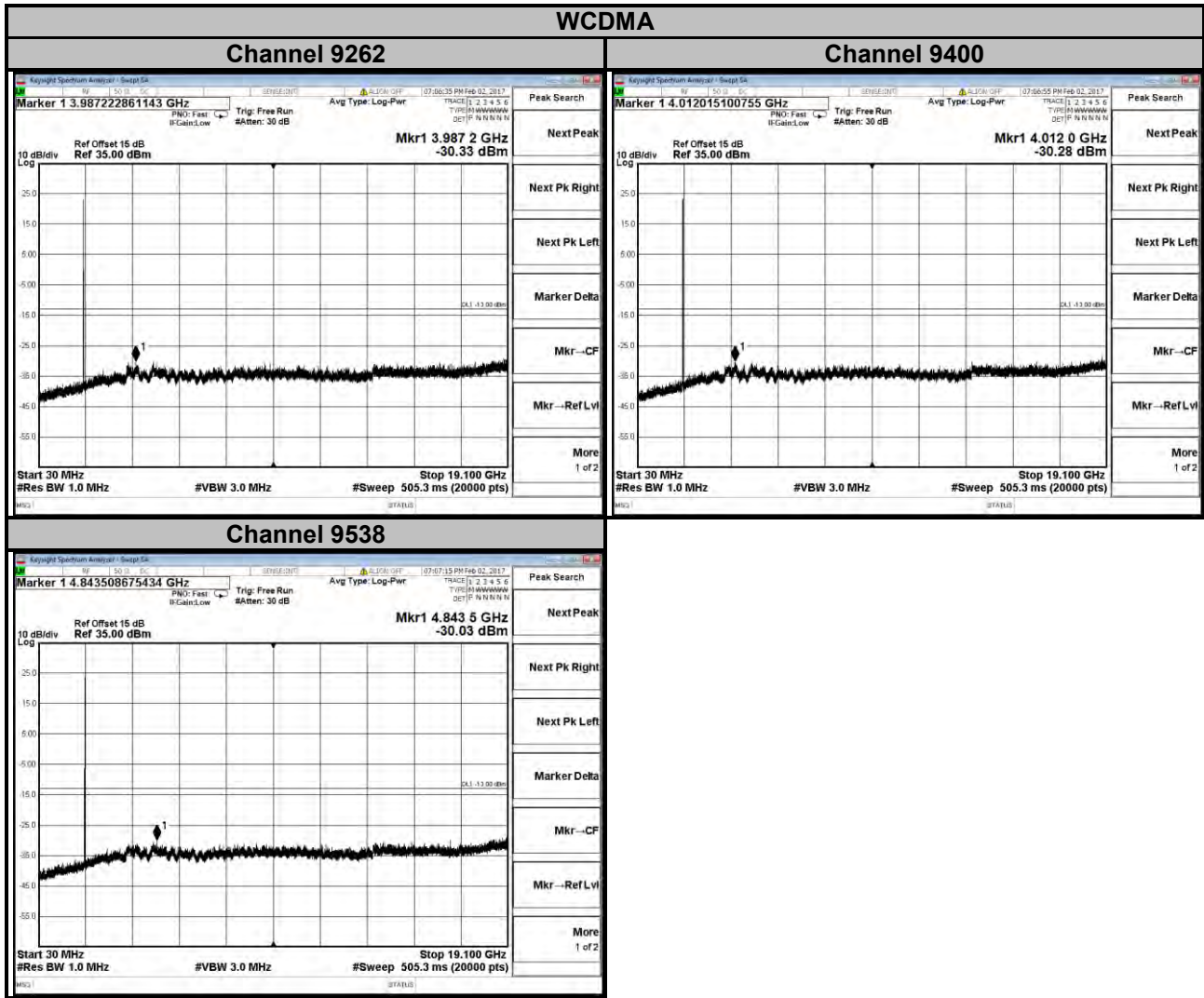

LTE Band 2

Channel Bandwidth: 1.4 MHz

Channel 18607

Channel 18900

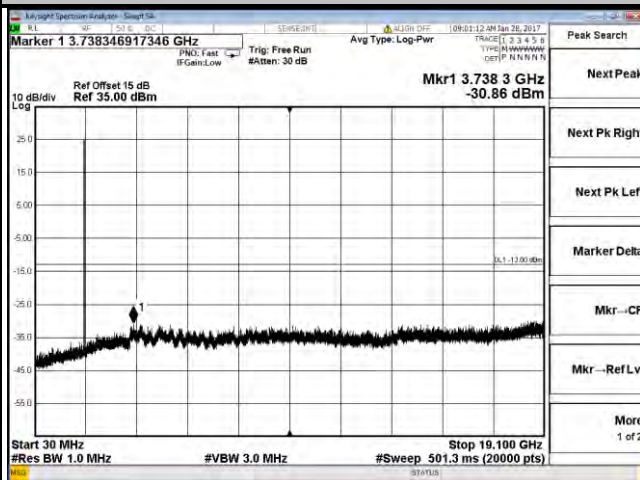
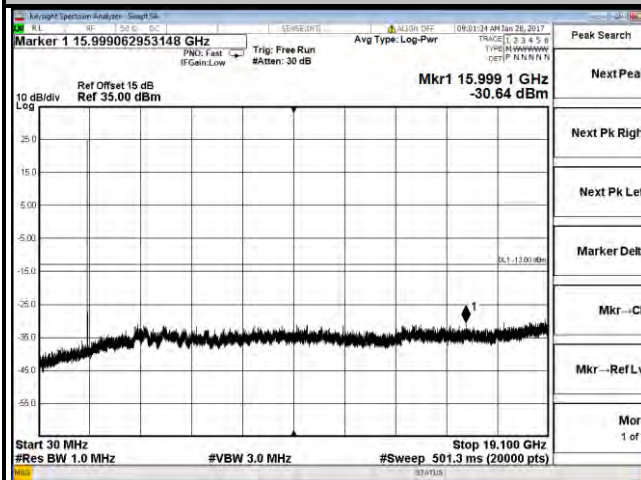

Channel 19193

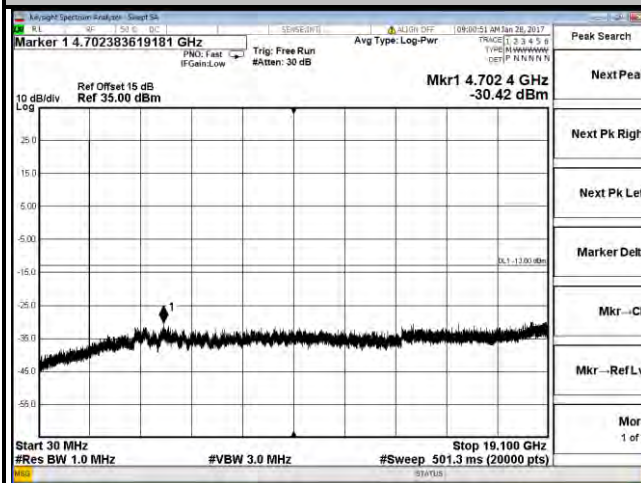

LTE Band 2

Channel Bandwidth: 3 MHz

Channel 18615

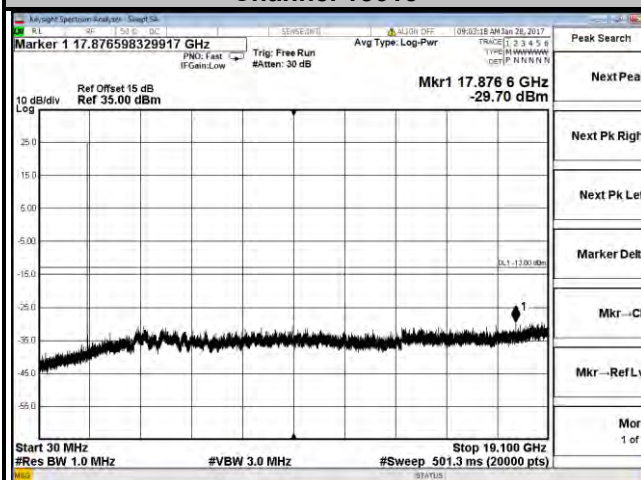

Channel 18900

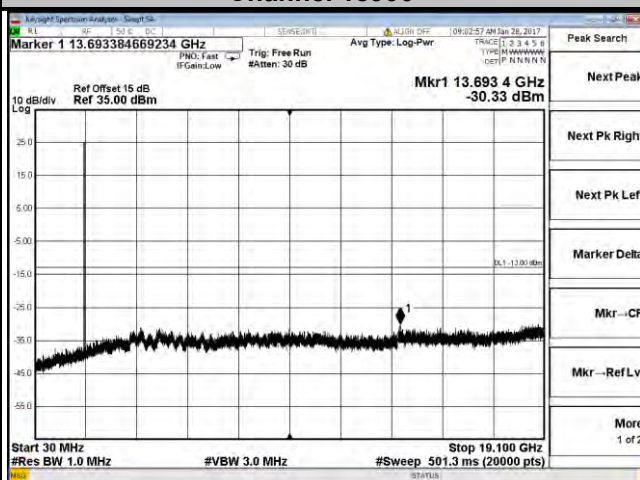

Channel 19185

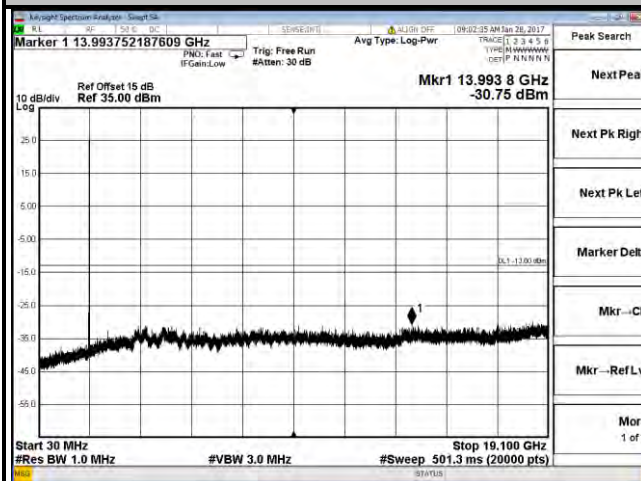

LTE Band 2

Channel Bandwidth: 5 MHz

Channel 18625

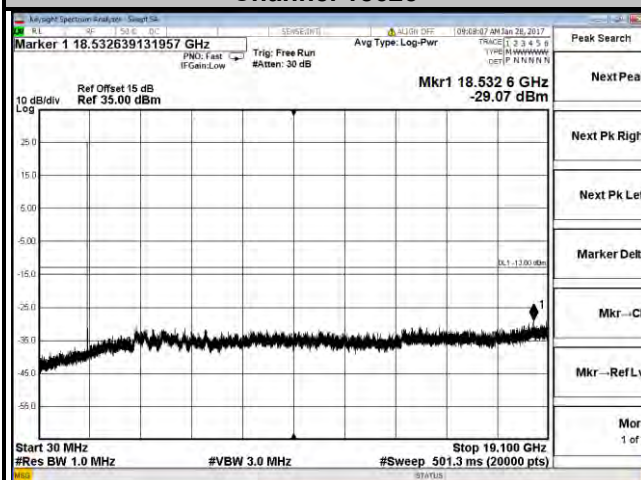

Channel 18900

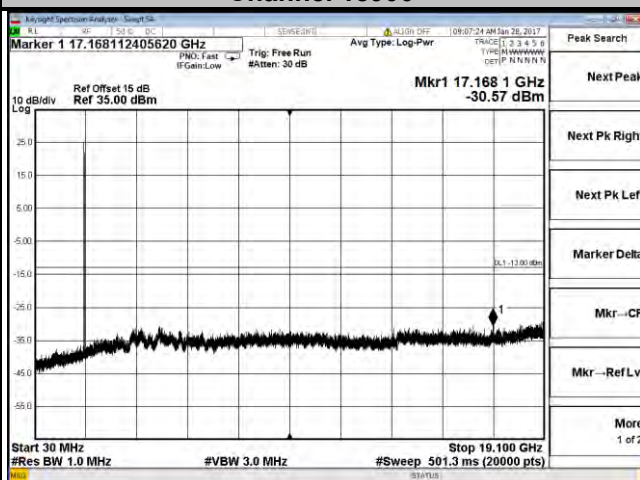

Channel 19175

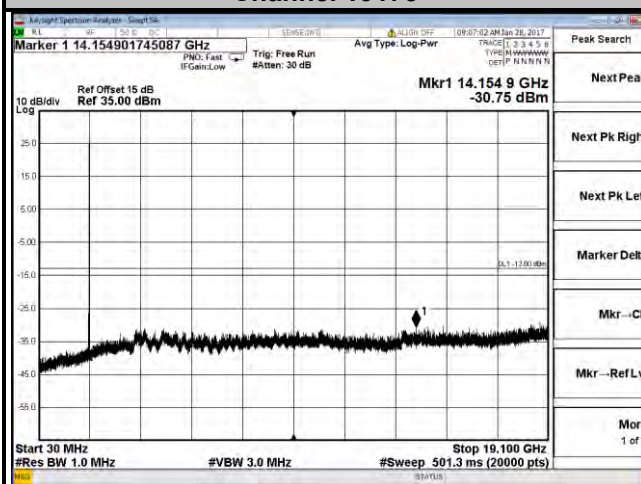

LTE Band 2

Channel Bandwidth: 10 MHz

Channel 18650

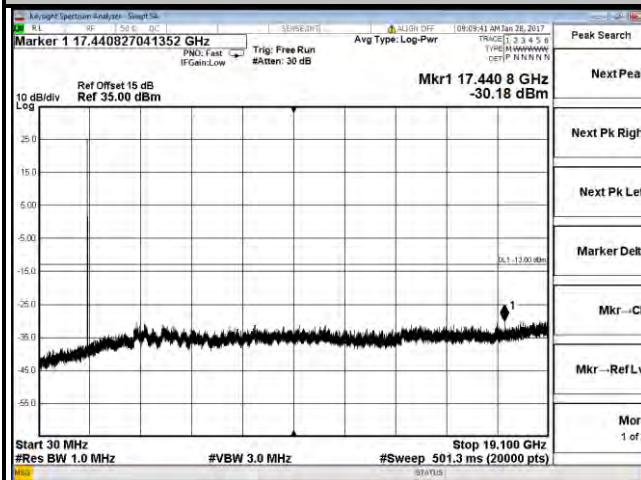

Channel 18900

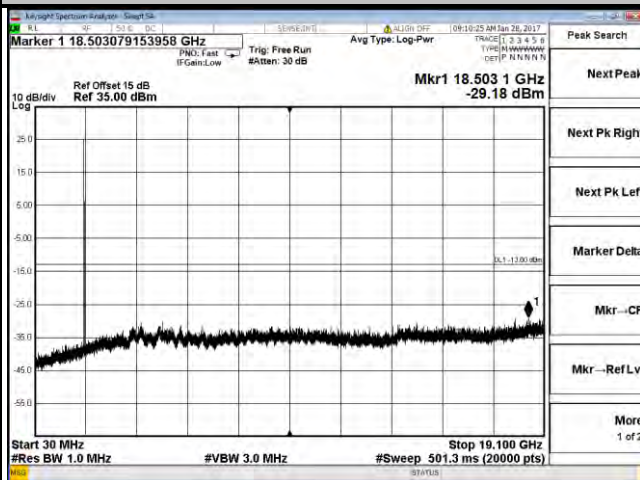

Channel 19150

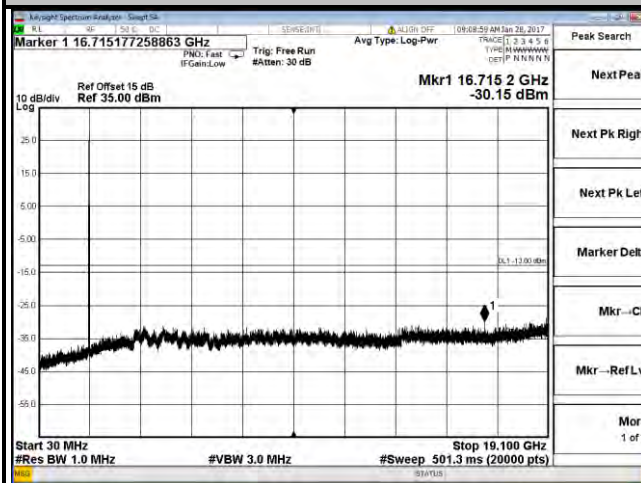

LTE Band 2

Channel Bandwidth: 15 MHz

Channel 18675

Channel 18900

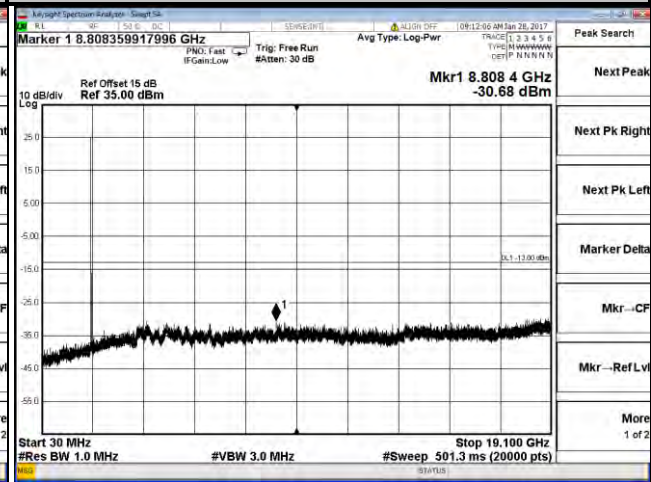
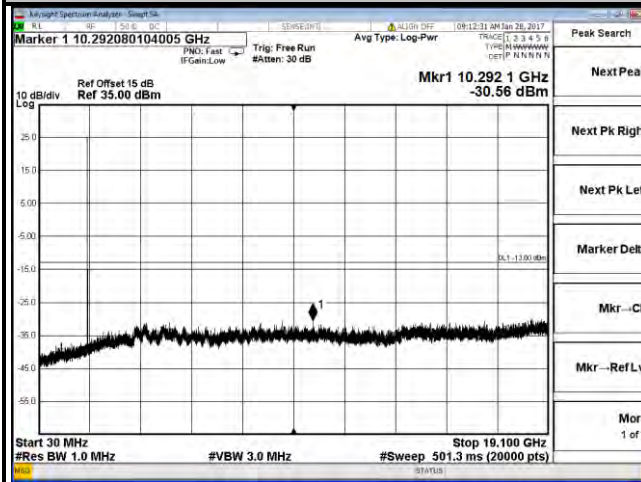

Channel 19125

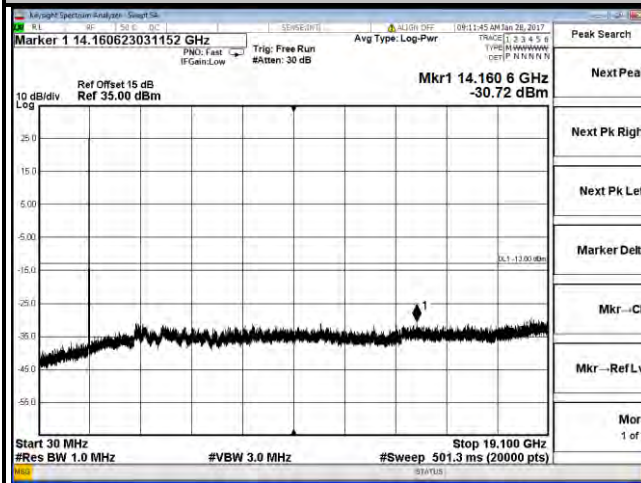

LTE Band 2

Channel Bandwidth: 20 MHz

Channel 18700

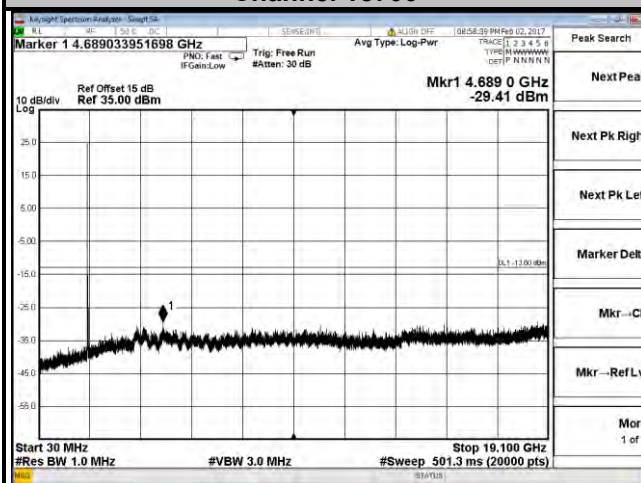

Channel 18900

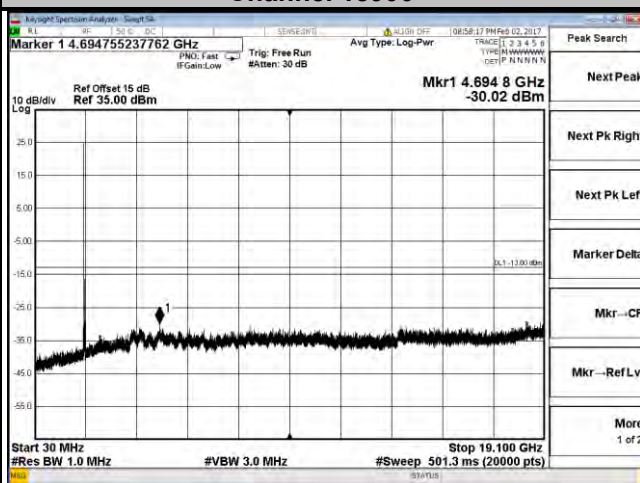

Channel 19100

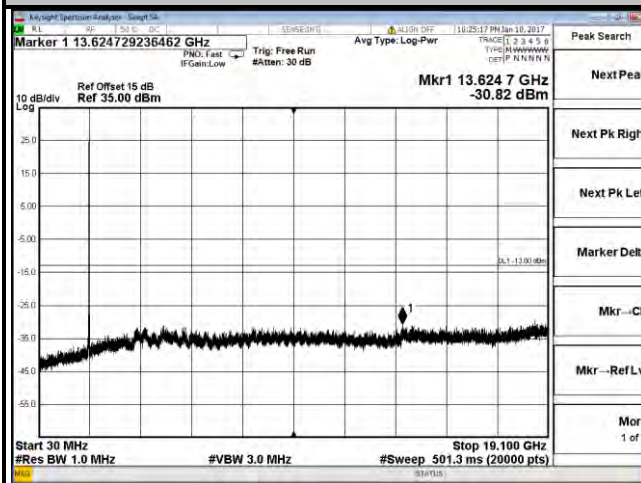

4.7 Radiated Emission Measurement

4.7.1 Limits of Radiated Emission Measurement

The power of any emission outside of the authorized operating frequency ranges must be attenuated below the transmitting power (P) by a factor of at least $43 + 10 \log(P)$ dB. The emission limit is equal to -13 dBm.

4.7.2 Test Procedure

- Substitution method is used for E.I.R.P measurement. In the semi-anechoic chamber, EUT placed on the 0.8 m height of Turn Table, rotated the table around 360 degrees to search the maximum radiation power and receiver antenna shall be rotated vertical and horizontal polarization and moved height from 1 m to 4 m to find the maximum polar radiated power. The "Read Value" is the spectrum reading the maximum power value.
- The substitution horn antenna is substituted for EUT at the same position and signals generator export the CW signal to the substitution antenna via a TX cable. Rotated the Turn Table and moved receiving antenna to find the maximum radiation power. Adjust output power level of S.G to get a Value of spectrum reading equal to "Read Value" of step a. Record the power level of S.G.
- $EIRP = \text{Output power level of S.G} - \text{TX cable loss} + \text{Antenna gain of substitution horn}$.
- E.R.P power can be calculated form E.I.R.P power by subtracting the gain of dipole, $E.R.P \text{ power} = E.I.P.R \text{ power} - 2.15 \text{ dBi}$.

NOTE: The resolution bandwidth and video bandwidth of test receiver/spectrum analyzer is 1 MHz/3 MHz.

4.7.3 Deviation from Test Standard

No deviation.

4.7.4 Test Setup

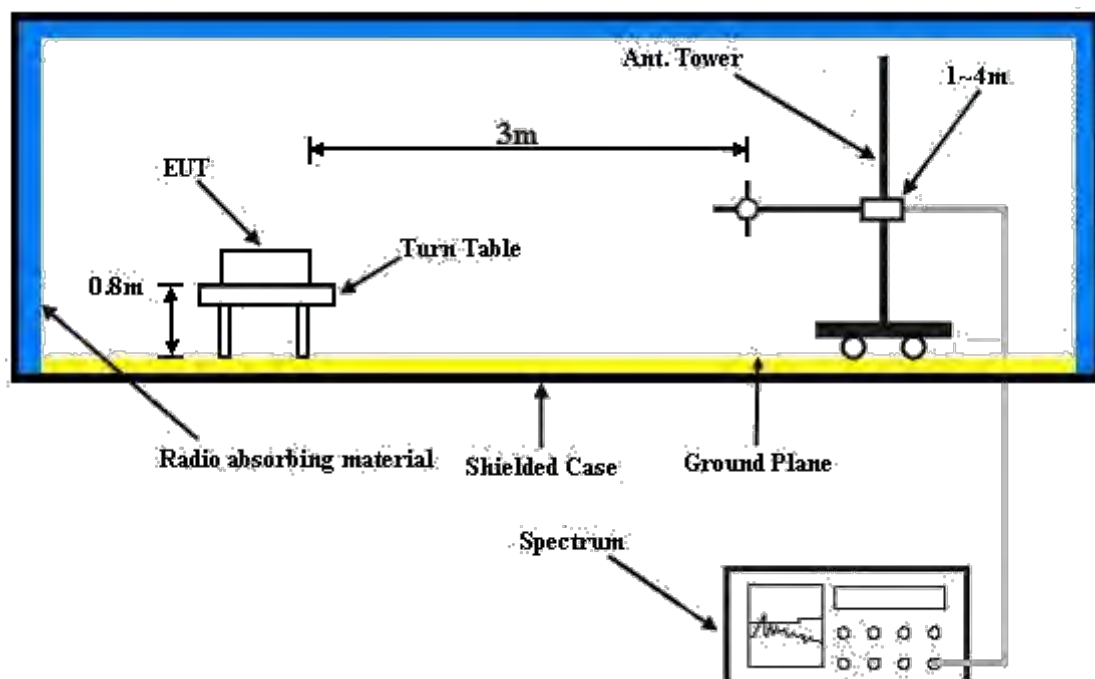

For the actual test configuration, please refer to the attached file (Test Setup Photo).

4.7.5 Test Results

WCDMA:

Low Channel



Bureau Veritas Consumer Products Services Ltd., Taoyuan Branch

A D T

Data: 5

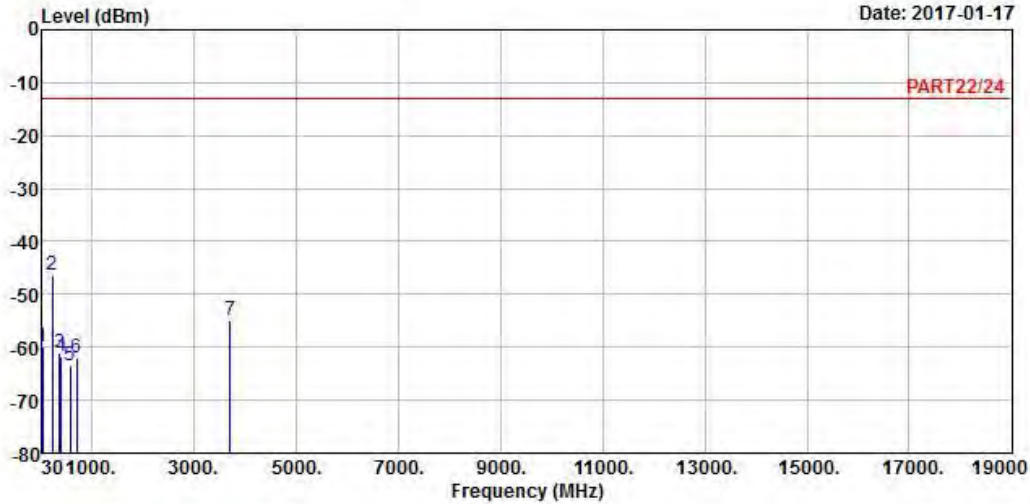

Site : 966 Chamber 5
 Condition: PART22/24 HORIZONTAL
 Remak : WCDMA Band II_L-CH Link
 Tested by: Gavin Wu

	Freq	Level	Read Level	Limit Line	Over Limit	Factor	Remark
	MHz	dBm	dBm	dBm	dB	dB	
1	40.67	-59.83	-59.95	-13.00	-46.83	0.12	Peak
2 pp	222.06	-46.43	-39.31	-13.00	-33.43	-7.12	Peak
3	364.65	-61.10	-54.95	-13.00	-48.10	-6.15	Peak
4	401.51	-61.81	-55.88	-13.00	-48.81	-5.93	Peak
5	567.38	-63.40	-61.28	-13.00	-50.40	-2.12	Peak
6	709.00	-62.10	-62.17	-13.00	-49.10	0.07	Peak
7	3704.80	-55.05	-46.88	-13.00	-42.05	-8.17	Peak



A D T

Data: 6

Date: 2017-01-17

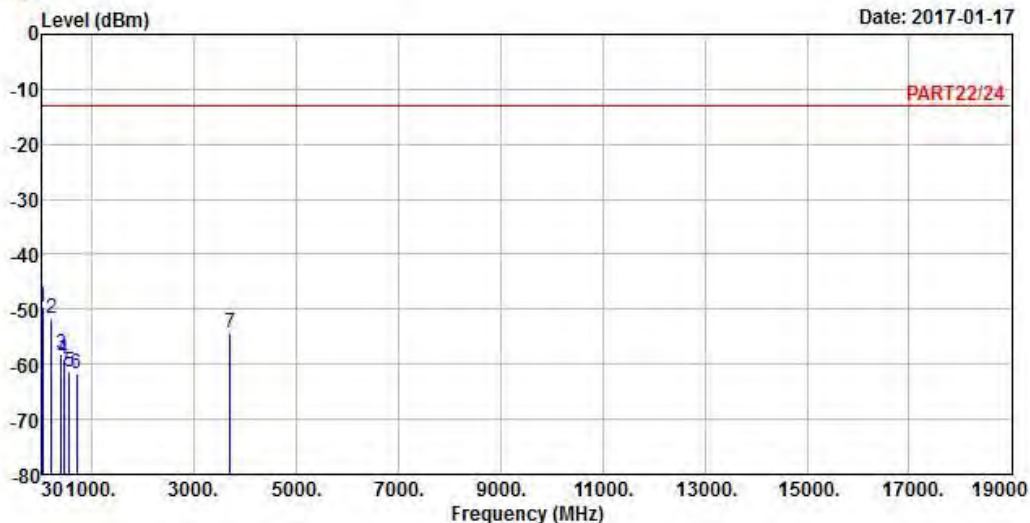

Site : 966 Chamber 5
 Condition: PART22/24 VERTICAL
 Remak : WCDMA Band II_L-CH Link
 Tested by: Gavin Wu

	Freq	Level	Read Level	Limit Line	Over Limit	Factor	Remark
	MHz	dBm	dBm	dBm	dB	dB	
1 pp	41.64	-49.66	-49.25	-13.00	-36.66	-0.41	Peak
2	207.51	-51.67	-43.96	-13.00	-38.67	-7.71	Peak
3	400.54	-58.28	-52.34	-13.00	-45.28	-5.94	Peak
4	453.89	-59.13	-53.65	-13.00	-46.13	-5.48	Peak
5	554.77	-61.42	-58.77	-13.00	-48.42	-2.65	Peak
6	701.24	-61.59	-61.51	-13.00	-48.59	-0.08	Peak
7	3704.80	-54.33	-46.16	-13.00	-41.33	-8.17	Peak

Middle Channel



Bureau Veritas Consumer Products Services Ltd., Taoyuan Branch

A D T

Data: 3

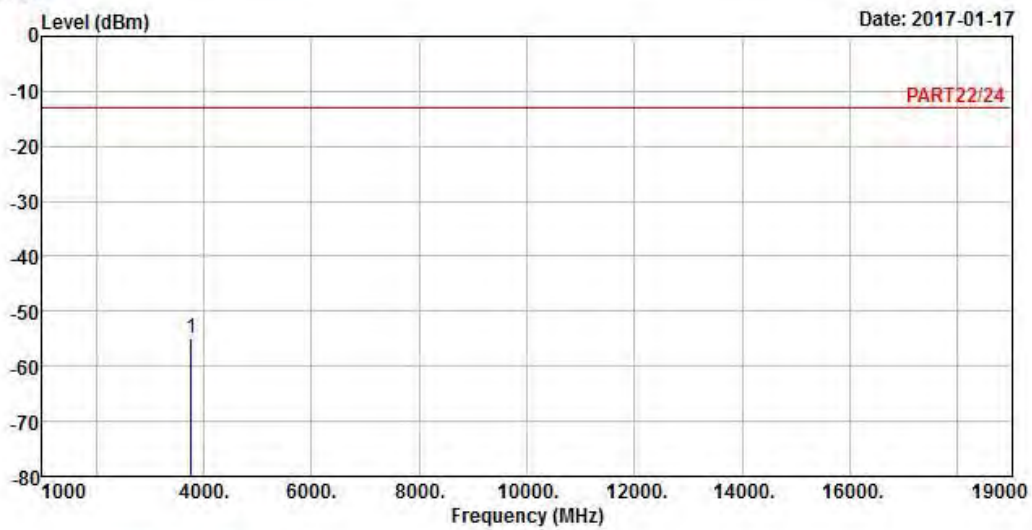

Site : 966 Chamber 5
 Condition: PART22/24 HORIZONTAL
 Remak : WCDMA Band II_M-CH Link
 Tested by: Gavin Wu

Freq	Level	Read Level	Limit	Over	Factor	Remark
MHz	dBm	dBm	dBm	dB	dB	
1 pp 3760.00	-54.91	-46.85	-13.00	-41.91	-8.06	Peak



Bureau Veritas Consumer Products Services Ltd., Taoyuan Branch

A D T

Data: 4

Date: 2017-01-17

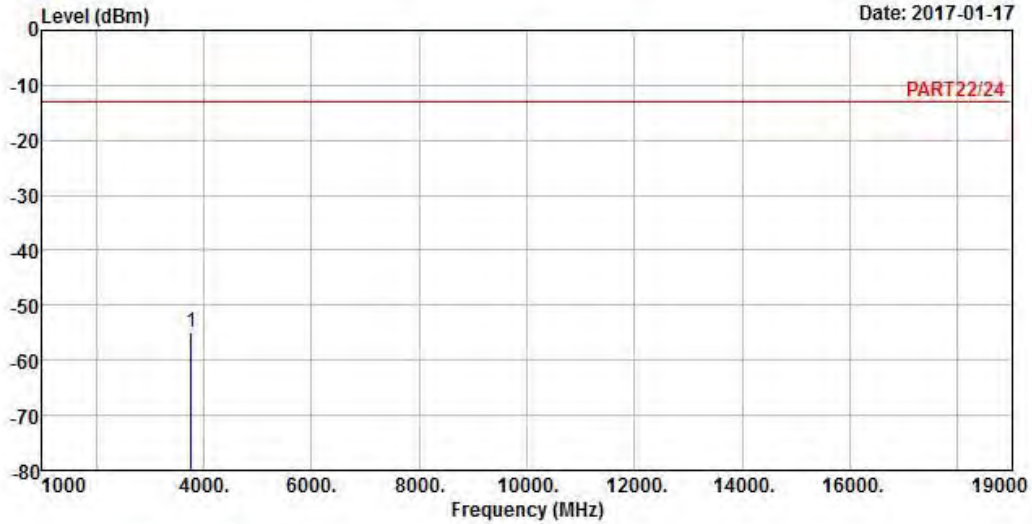

Site : 966 Chamber 5
 Condition: PART22/24 VERTICAL
 Remak : WCDMA Band II_M-CH Link
 Tested by: Gavin Wu

Freq	Level	Read Level	Limit Line	Over Limit	Factor	Remark
MHz	dBm	dBm	dBm	dB	dB	
1 pp 3760.00	-54.90	-46.84	-13.00	-41.90	-8.06	Peak

High Channel



Bureau Veritas Consumer Products Services Ltd., Taoyuan Branch

A D T

Data: 5

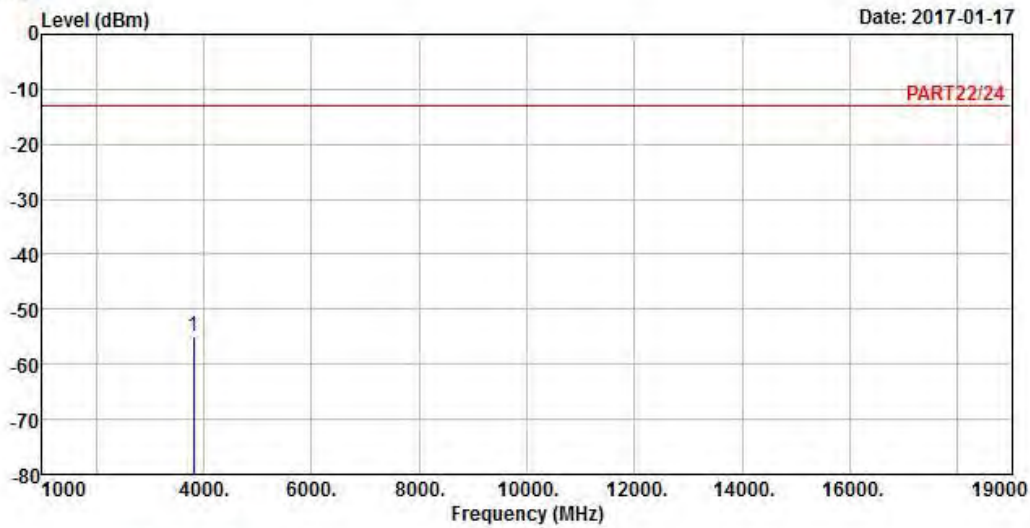

Site : 966 Chamber 5
 Condition: PART22/24 HORIZONTAL
 Remak : WCDMA Band II_H-CH Link
 Tested by: Gavin Wu

Freq	Level	Read Level	Limit	Over	Factor	Remark
MHz	dBm	dBm	dBm	dB	dB	
1 pp 3815.20	-54.84	-47.06	-13.00	-41.84	-7.78	Peak



A D T

Data: 6

Date: 2017-01-17

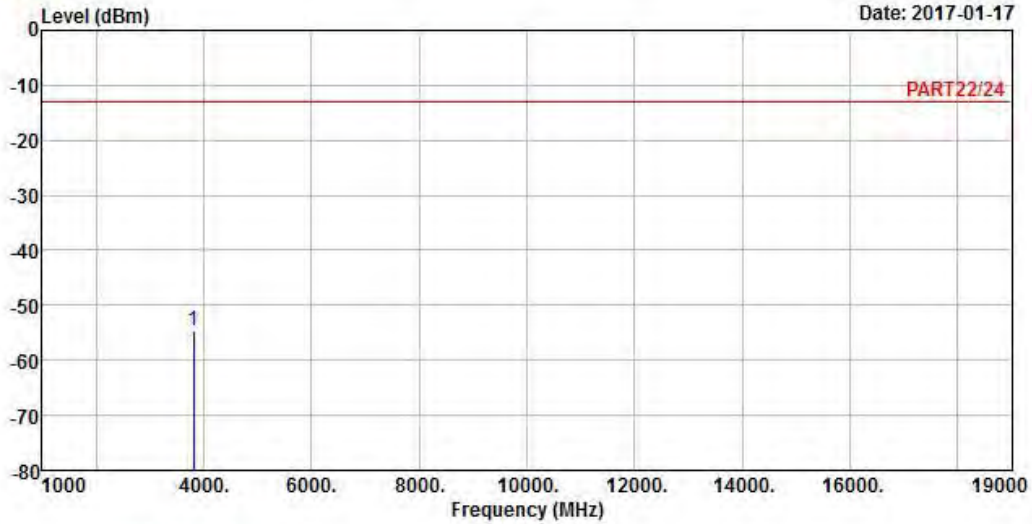

Site : 966 Chamber 5
 Condition: PART22/24 VERTICAL
 Remak : WCDMA Band II_H-CH Link
 Tested by: Gavin Wu

Freq	Level	Read Level	Limit Line	Over Limit	Factor	Remark
MHz	dBm	dBm	dBm	dB	dB	
1 pp 3815.20	-54.69	-46.91	-13.00	-41.69	-7.78	Peak

LTE Band 2
Channel Bandwidth: 20 MHz / QPSK
Low Channel



Bureau Veritas Consumer Products Services Ltd., Taoyuan Branch

A D T

Data: 3

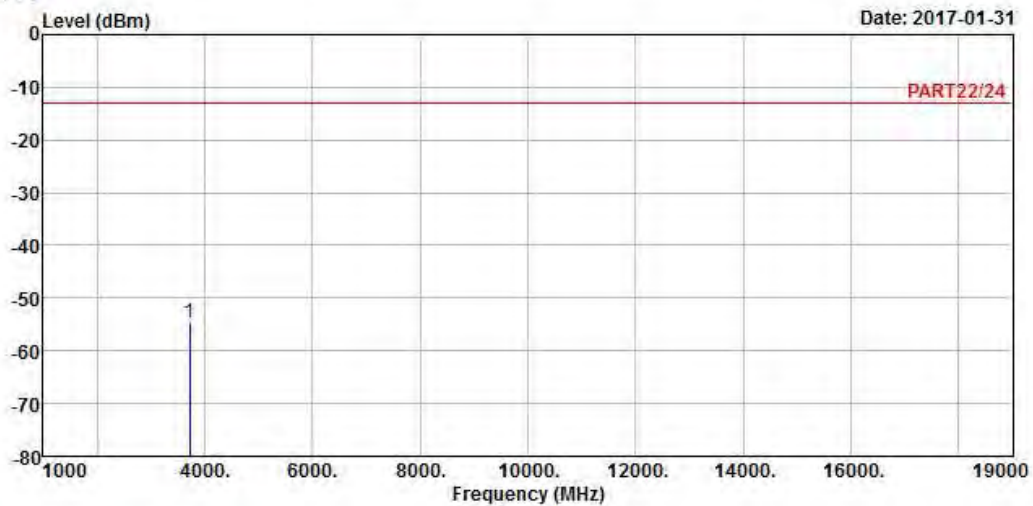

Site : 966 Chamber 5
Condition: PART22/24 HORIZONTAL
Remak : LTE Band II_QPSK_20M_L-CH Link
Tested by: Geetaz Yang

Freq	Level	Read Level	Limit Line	Over Limit	Factor	Remark
MHz	dBm	dBm	dBm	dB	dB	
1 pp 3720.00	-54.53	-46.40	-13.00	-41.53	-8.13	Peak



Bureau Veritas Consumer Products Services Ltd., Taoyuan Branch

A D T

Data: 3

Date: 2017-01-31

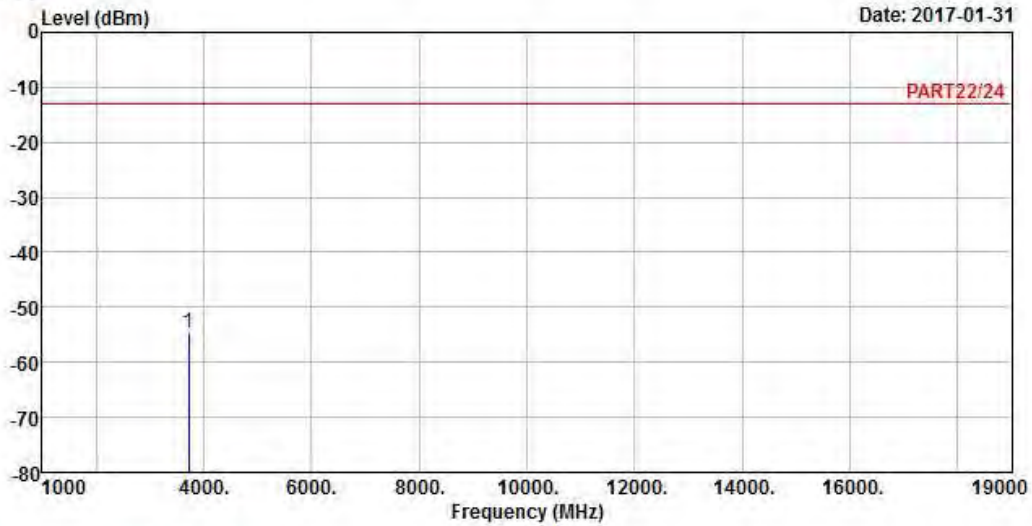

Site : 966 Chamber 5
 Condition: PART22/24 HORIZONTAL
 Remak : LTE Band II_QPSK_20M_L-CH Link
 Tested by: Geetaz Yang

Freq	Level	Read Level	Limit Line	Over Limit	Factor	Remark
MHz	dBm	dBm	dBm	dB	dB	
1 pp 3720.00	-54.53	-46.40	-13.00	-41.53	-8.13	Peak

Middle Channel



Bureau Veritas Consumer Products Services Ltd., Taoyuan Branch

A D T

Data: 5

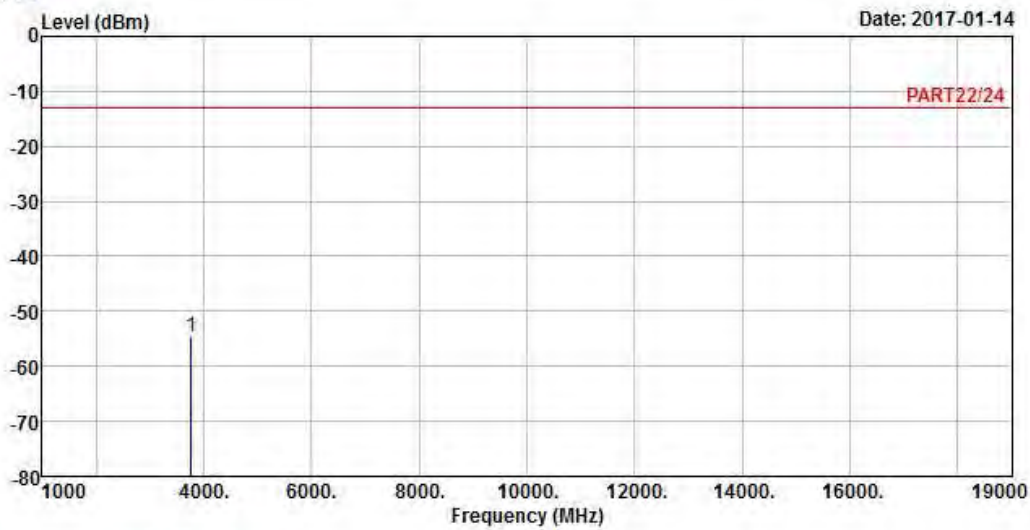

Site : 966 Chamber 5
 Condition: PART22/24 HORIZONTAL
 Remak : LTE Band II_QPSK_20M_M-CH Link
 Tested by: Geetaz Yang

Freq	Level	Read Level	Limit Line	Over Limit	Factor	Remark
MHz	dBm	dBm	dBm	dB	dB	
1 pp 3760.00	-54.61	-46.55	-13.00	-41.61	-8.06	Peak



Bureau Veritas Consumer Products Services Ltd., Taoyuan Branch

A D T

Data: 6

Date: 2017-01-14

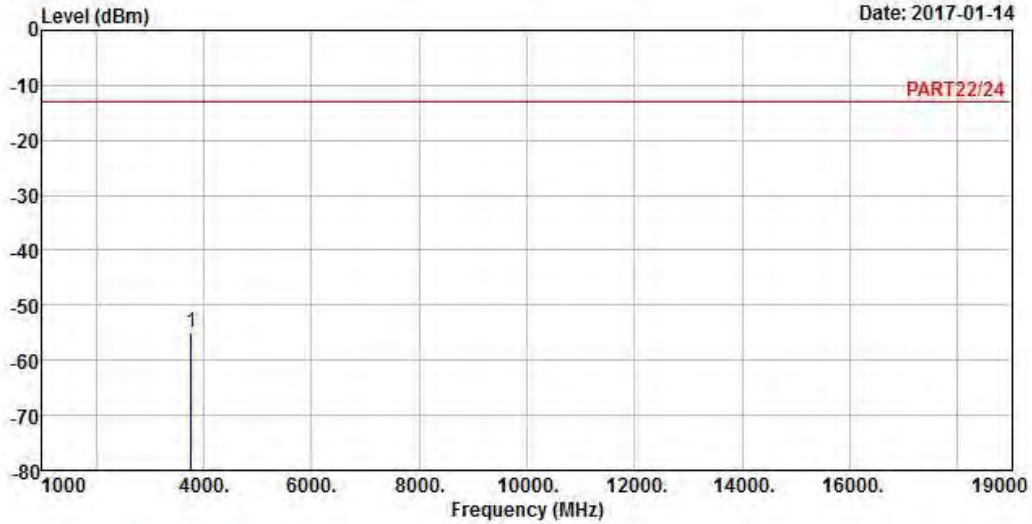

Site : 966 Chamber 5
 Condition: PART22/24 VERTICAL
 Remak : LTE Band II_QPSK_20M_M-CH Link
 Tested by: Geetaz Yang

Freq	Level	Read Level	Limit Line	Over Limit	Factor	Remark
MHz	dBm	dBm	dBm	dB	dB	
1 pp 3760.00	-54.96	-46.90	-13.00	-41.96	-8.06	Peak

High Channel



Bureau Veritas Consumer Products Services Ltd., Taoyuan Branch

A D T

Data: 5

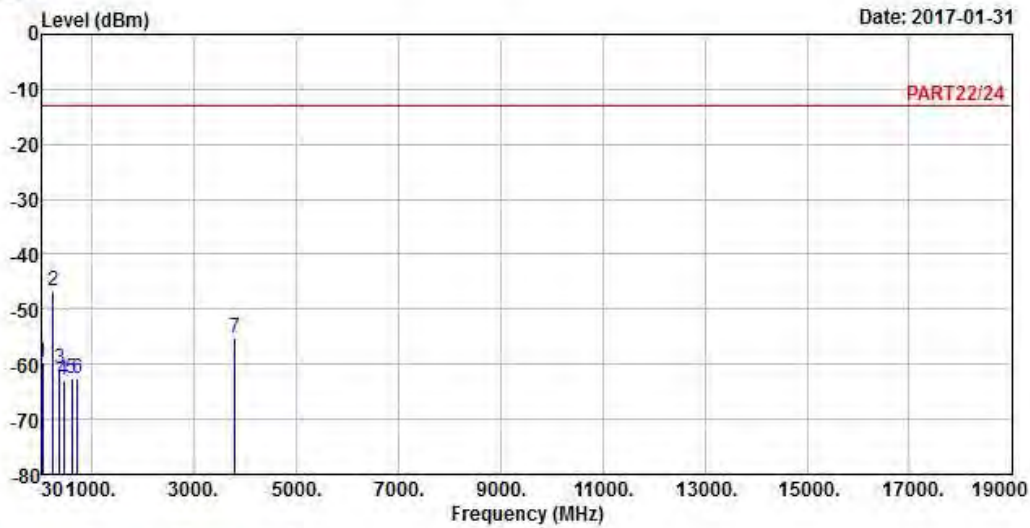

Site : 966 Chamber 5
 Condition: PART22/24 HORIZONTAL
 Remak : LTE Band II_QPSK_20M_H-CH Link
 Tested by: Geetaz Yang

	Freq	Level	Read Level	Limit	Over	Factor	Remark
	MHz	dBm	dBm	dBm	dB	dB	
1	41.64	-59.62	-59.21	-13.00	-46.62	-0.41	Peak
2 pp	236.61	-46.52	-39.98	-13.00	-33.52	-6.54	Peak
3	366.59	-60.92	-54.78	-13.00	-47.92	-6.14	Peak
4	446.13	-62.74	-57.16	-13.00	-49.74	-5.58	Peak
5	606.18	-62.48	-61.71	-13.00	-49.48	-0.77	Peak
6	724.52	-62.56	-62.94	-13.00	-49.56	0.38	Peak
7	3800.00	-55.11	-47.33	-13.00	-42.11	-7.78	Peak



A D T

Data: 6

Date: 2017-01-31

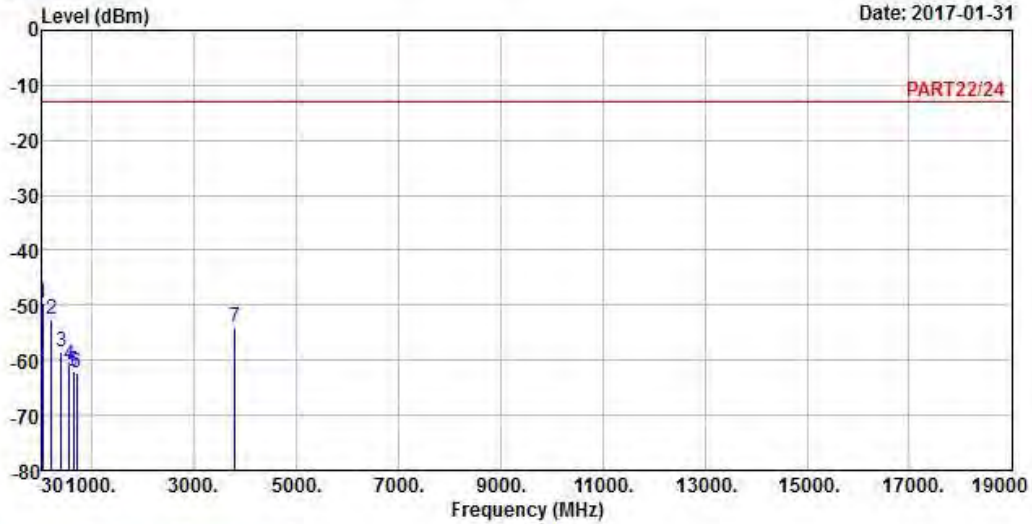

Site : 966 Chamber 5
 Condition: PART22/24 VERTICAL
 Remak : LTE Band II_QPSK_20M_H-CH Link
 Tested by: Geetaz Yang

	Freq	Level	Read Level	Limit Line	Over Limit	Factor	Remark
	MHz	dBm	dBm	dBm	dB	dB	
1 pp	41.64	-49.51	-49.10	-13.00	-36.51	-0.41	Peak
2	208.48	-52.40	-44.73	-13.00	-39.40	-7.67	Peak
3	398.60	-58.51	-52.56	-13.00	-45.51	-5.95	Peak
4	551.86	-60.71	-57.94	-13.00	-47.71	-2.77	Peak
5	634.31	-61.86	-61.02	-13.00	-48.86	-0.84	Peak
6	705.12	-62.38	-62.38	-13.00	-49.38	0.00	Peak
7	3800.00	-54.14	-46.36	-13.00	-41.14	-7.78	Peak

5 Pictures of Test Arrangements

Please refer to the attached file (Test Setup Photo).

Appendix – Information on the Testing Laboratories

We, Bureau Veritas Consumer Products Services (H.K.) Ltd., Taoyuan Branch, were founded in 1988 to provide our best service in EMC, Radio, Telecom and Safety consultation. Our laboratories are accredited and approved according to ISO/IEC 17025.

If you have any comments, please feel free to contact us at the following:

Linko EMC/RF Lab

Tel: 886-2-26052180

Fax: 886-2-26051924

Hsin Chu EMC/RF/Telecom Lab

Tel: 886-3-6668565

Fax: 886-3-6668323

Hwa Ya EMC/RF/Safety

Tel: 886-3-3183232

Fax: 886-3-3270892

Email: service.adt@tw.bureauveritas.com

Web Site: www.bureauveritas-adt.com

The address and road map of all our labs can be found in our web site also.

--- END ---