



FCC RF Test Report

APPLICANT : LC Future Center
EQUIPMENT : Tablet PC
BRAND NAME : Lenovo
MODEL NAME : TP00089A
FCC ID : 2AJN7-TP00089ASI
STANDARD : FCC Part 15 Subpart C §15.247
CLASSIFICATION : (DSS) Spread Spectrum Transmitter

The product were integrated the WWAN module (Model Name: EM7455, FCC ID: N7NEM7455) and the BT/WLAN module: 2x2 PCIe M.2 1216 SD adapter card (Brand Name: Intel, Model Name: 8265D2W, FCC ID: PD98265D2) during the test.

The product was received on Sep. 08, 2017 and testing was completed on Nov. 21, 2017. We, Sporton International (Kunshan) Inc., would like to declare that the tested sample has been evaluated in accordance with the test procedures and has been in compliance with the applicable technical standards.

The test results in this report apply exclusively to the tested model / sample. Without written approval of Sporton International (Kunshan) Inc., the test report shall not be reproduced except in full.



Approved by: James Huang / Manager

Sporton International (Kunshan) Inc.

**No.3-2 Ping-Xiang Rd, Kunshan Development Zone Kunshan City Jiangsu Province 215335
China**



TABLE OF CONTENTS

REVISION HISTORY..... 3

SUMMARY OF TEST RESULT 4

1 GENERAL DESCRIPTION..... 5

 1.1 Applicant 5

 1.2 Manufacturer..... 5

 1.3 Product Feature of Equipment Under Test..... 5

 1.4 Product Specification of Equipment Under Test..... 6

 1.5 Modification of EUT 6

 1.6 Testing Location 6

 1.7 Applicable Standards..... 7

2 TEST CONFIGURATION OF EQUIPMENT UNDER TEST..... 8

 2.1 Descriptions of Test Mode 8

 2.2 Test Mode..... 9

 2.3 Connection Diagram of Test System..... 10

 2.4 Support Unit used in test configuration and system 11

 2.5 EUT Operation Test Setup 11

3 TEST RESULT 12

 3.1 Peak and Average Output Power Measurement..... 12

 3.2 Radiated Band Edges and Spurious Emission Measurement 15

 3.3 AC Conducted Emission Measurement..... 21

 3.4 Antenna Requirements 25

4 LIST OF MEASURING EQUIPMENT..... 26

5 UNCERTAINTY OF EVALUATION..... 27

APPENDIX A. RADIATED SPURIOUS EMISSION

APPENDIX B. RADIATED SPURIOUS EMISSION PLOTS

APPENDIX C. SETUP PHOTOGRAPHS



SUMMARY OF TEST RESULT

Report Section	FCC Rule	Description	Limit	Result	Remark
-	15.247(a)(1)	Number of Channels	≥ 15Chs	Pass	1
-	15.247(a)(1)	Hopping Channel Separation	≥ 2/3 of 20dB BW	Pass	1
-	15.247(a)(1)	Dwell Time of Each Channel	≤ 0.4sec in 31.6sec period	Pass	1
-	15.247(a)(1)	20dB Bandwidth	NA	Pass	1
-	-	99% Bandwidth	-	Pass	1
3.1	15.247(b)(1)	Peak and Average Output Power	≤ 125 mW	Pass	-
-	15.247(d)	Conducted Band Edges	≤ 20dBc	Pass	1
-	15.247(d)	Conducted Spurious Emission	≤ 20dBc	Pass	1
3.2	15.247(d)	Radiated Band Edges and Radiated Spurious Emission	15.209(a) & 15.247(d)	Pass	Under limit 6.47 dB at 30.000 MHz
3.3	15.207	AC Conducted Emission	15.207(a)	Pass	Under limit 12.73 dB at 15.635 MHz
3.4	15.203 & 15.247(b)	Antenna Requirement	N/A	Pass	-

Remark:

- All conducted test items were leverage from module RF report which can refer to Report No. "160321-02.TR05".



1 General Description

1.1 Applicant

LC Future Center
7F., No.780,Beian Rd., Zhongshan Dist.,Taipei. Taiwan

1.2 Manufacturer

Lenovo PC HK Limited
23/F, Lincoln House, Taikoo Place 979 King's Road, Quarry Bay, HongKong

1.3 Product Feature of Equipment Under Test

Product Feature	
Equipment	Tablet PC
Brand Name	Lenovo
Model Name	TP00089A
FCC ID	2AJN7-TP00089ASI
EUT supports Radios application	WCDMA/HSPA/ DC-HSDPA/ HSPA+ (16QAM uplink is not supported)/LTE WLAN 2.4GHz 802.11b/g/n HT20/HT40 WLAN 5GHz 802.11a/n HT20/HT40 WLAN 5GHz 802.11ac VHT20/VHT40/VHT80 Bluetooth v3.0+EDR/ Bluetooth v4.0 LE/ Bluetooth v4.1 LE
IMEI Code	Conducted/ Conduction: N/A Radiation: 014583000471168 for Sample 1 014583000471168 for Sample 2
HW Version	1.0
SW Version	Win 10 Pro 10.0.15063
EUT Stage	Identical Prototype

Remark:

1. The above EUT's information was declared by manufacturer. Please refer to the specifications or user's manual for more detailed description.
2. There are two samples of EUT, the only difference between two samples are just for the WWAN antenna and WLAN/BT antenna with different suppliers, they are equivalent-type antennas , antenna type and gain are all the same between sample 1 and sample 2 . According to the difference, we evaluate sample 1 for full test, sample 2 only verified the worst cases of sample 1 for RSE test item.



1.4 Product Specification of Equipment Under Test

Standards-related Product Specification	
Tx/Rx Frequency Range	2402 MHz ~ 2480 MHz
Number of Channels	79
Carrier Frequency of Each Channel	2402+n*1 MHz; n=0~78
Maximum (Peak) Output Power to Antenna	Bluetooth BR(1Mbps) : 9.78 dBm (0.0095 W) Bluetooth EDR (2Mbps) : 8.59 dBm (0.0072 W) Bluetooth EDR (3Mbps) : 8.08 dBm (0.0064 W)
Antenna Type / Gain	PCB Antenna type with gain 0.50 dBi
Type of Modulation	Bluetooth BR (1Mbps) : GFSK Bluetooth EDR (2Mbps) : $\pi/4$ -DQPSK Bluetooth EDR (3Mbps) : 8-DPSK

1.5 Modification of EUT

No modifications are made to the EUT during all test items.

1.6 Testing Location

Sporton Lab is accredited to ISO 17025 by National Voluntary Laboratory Accreditation Program (NVLAP code: 600155-0) and the FCC designation No. is CN5013.

Test Site	Sporton International (Kunshan) Inc.			
Test Site Location	No.3-2 Ping-Xiang Rd, Kunshan Development Zone Kunshan City Jiangsu Province 215335 China TEL : +86-512-57900158 FAX : +86-512-57900958			
Test Site No.	Sporton Site No.			FCC Test Firm Registration No.
	TH01-KS	03CH03-KS	CO01-KS	630927

Note: The test site complies with ANSI C63.4 2014 requirement.



1.7 Applicable Standards

According to the specifications of the manufacturer, the EUT must comply with the requirements of the following standards:

- ♦ FCC Part 15 Subpart C §15.247
- ♦ ANSI C63.10-2013

Remark: All test items were verified and recorded according to the standards and without any deviation during the test.

2 Test Configuration of Equipment Under Test

2.1 Descriptions of Test Mode

Preliminary tests were performed in different data rates and recorded the RF output power in the following table:

Channel	Frequency	Bluetooth RF Peak Output Power		
		Data Rate / Modulation		
		GFSK	$\pi/4$ -DQPSK	8-DPSK
		1Mbps	2Mbps	3Mbps
Ch00	2402MHz	9.51 dBm	8.33 dBm	7.74 dBm
Ch39	2441MHz	9.78 dBm	8.59 dBm	8.08 dBm
Ch78	2480MHz	9.29 dBm	8.01 dBm	7.44 dBm

Channel	Frequency	Bluetooth RF Average Output Power		
		Data Rate / Modulation		
		GFSK	$\pi/4$ -DQPSK	8-DPSK
		1Mbps	2Mbps	3Mbps
Ch00	2402MHz	8.92 dBm	6.46 dBm	5.77 dBm
Ch39	2441MHz	9.50 dBm	6.56 dBm	6.21 dBm
Ch78	2480MHz	8.80 dBm	6.26 dBm	5.59 dBm

The EUT has been associated with peripherals and configuration operated in a manner tended to maximize its emission characteristics in a typical application. Frequency range investigated: conduction (150 kHz to 30 MHz), radiation (9 kHz to the 10th harmonic of the highest fundamental frequency or to 40 GHz, whichever is lower). the worst mode of radiated spurious emissions is Bluetooth 1Mbps mode, and recorded in this report.



2.2 Test Mode

The following summary table is showing all test modes to demonstrate in compliance with the standard.

Summary table of Test Cases			
Test Item	Data Rate / Modulation		
	Bluetooth BR 1Mbps GFSK	Bluetooth EDR 2Mbps $\pi/4$ -DQPSK	Bluetooth EDR 3Mbps 8-DPSK
Radiated Test Cases	Bluetooth EDR 3Mbps 8-DPSK		
	Mode 1: CH00_2402 MHz		
	Mode 2: CH39_2441 MHz		
	Mode 3: CH78_2480 MHz		
AC Conducted Emission	Mode 1 : WCDMA Band II Idle + Bluetooth Link + WLAN Link (2.4G) + Adaptor + display with type C cable + Earphone		
Remark: For Radiated Test Cases, The tests were performed with Adapter and Earphone.			

2.3 Connection Diagram of Test System

<Bluetooth Tx Mode>

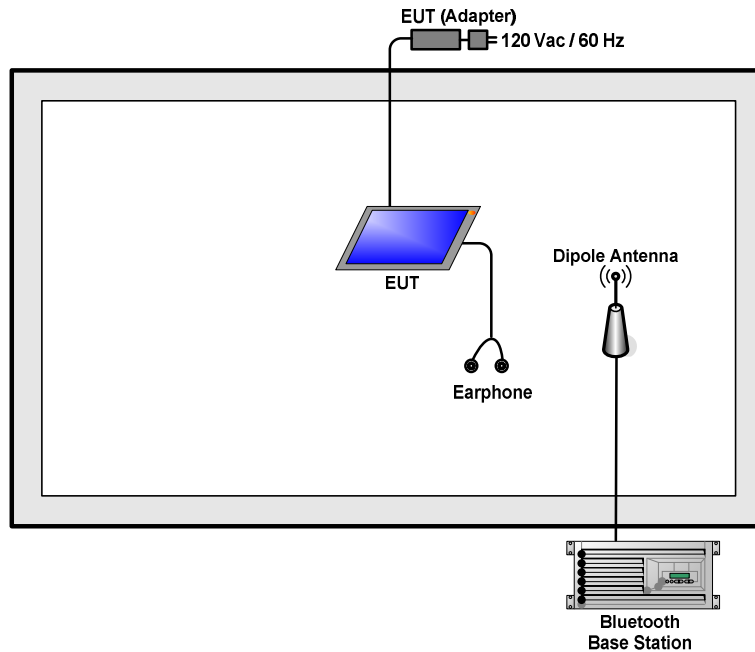

<AC Conducted Emission Mode>

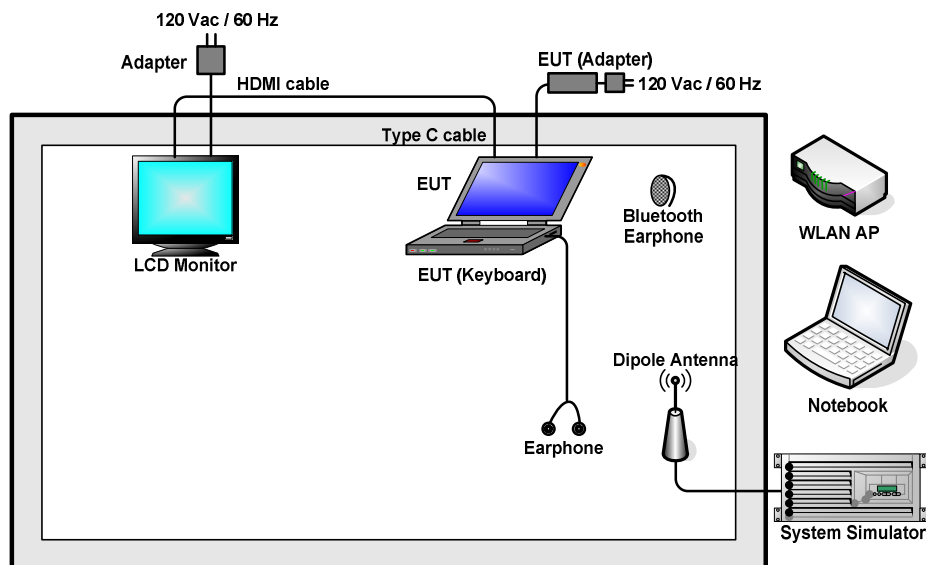

2.4 Support Unit used in test configuration and system

Item	Equipment	Trade Name	Model Name	FCC ID	Data Cable	Power Cord
1.	System Simulator	R&S	CMU 200	N/A	N/A	Unshielded, 1.8 m
2.	BT Base Station	R&S	CBT	N/A	N/A	Unshielded, 1.8 m
3.	WLAN AP	LINKSYS	WRT600N	Q87-WRT600NV11	N/A	Unshielded, 1.8 m
4.	Notebook	Lenovo	G480	N/A	N/A	Shielded cable DC O/P 1.8m , Unshielded AC I/P cable 1.8m
5.	Bluetooth Earphone	Lenovo	LBH308	NA	N/A	N/A
6.	Earphone	Lenovo	LH102	N/A	Unshielded, 1.2 m	N/A
7.	Type C cable	N/A	N/A	N/A	Unshielded, 0.2 m	N/A
8.	HDMI cable	N/A	N/A	N/A	Shielded, 1.0 m	N/A
9.	LCD Monitor	Lenovo	6135-AB1	FCC DoC	N/A	Unshielded, 1.8 m

2.5 EUT Operation Test Setup

For Bluetooth function, the engineering test program was provided and enabled to make EUT connect with Bluetooth base station to continuous transmit/receive.

For AC power line conducted emissions, the EUT was set to connect with the WLAN AP under large package sizes transmission.

3 Test Result

3.1 Peak and Average Output Power Measurement

3.1.1 Limit of Peak and Average Output Power

Section 15.247 (b) The maximum peak conducted output power of the intentional radiator shall not exceed the following: (1) For frequency hopping systems operating in the 2400-2483.5 MHz band employing at least 75 non-overlapping hopping channels, and all frequency hopping systems in the 5725-5850 MHz band: 1 watt. For all other frequency hopping systems in the 2400-2483.5 MHz band 0.125 watts.

3.1.2 Measuring Instruments

The measuring equipment is listed in the section 4 of this test report.

3.1.3 Test Procedures

1. The testing follows ANSI C63.10-2013 clause 7.8.5.
2. The RF output of EUT was connected to the power meter by RF cable and attenuator. The path loss was compensated to the results for each measurement.
3. Set to the maximum power setting and enable the EUT transmit continuously.
4. Measure the conducted output power with cable loss and record the results in the test report.
5. Measure and record the results in the test report.

3.1.4 Test Setup

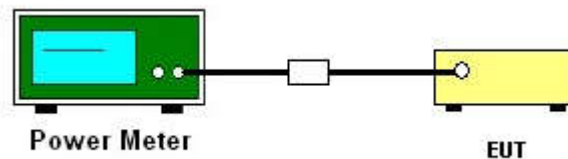



3.1.5 Test Result of Peak Output Power

Test Mode :	1Mbps	Temperature :	21~25°C
Test Engineer :	Silent Hai	Relative Humidity :	51~55%

Channel	Frequency (MHz)	RF Power (dBm)		
		GFSK	Max. Limits (dBm)	Pass/Fail
		1 Mbps		
00	2402	9.51	20.97	Pass
39	2441	9.78	20.97	Pass
78	2480	9.29	20.97	Pass

Test Mode :	2Mbps	Temperature :	21~25°C
Test Engineer :	Silent Hai	Relative Humidity :	51~55%

Channel	Frequency (MHz)	RF Power (dBm)		
		$\pi/4$ -DQPSK	Max. Limits (dBm)	Pass/Fail
		2 Mbps		
00	2402	8.33	20.97	Pass
39	2441	8.59	20.97	Pass
78	2480	8.01	20.97	Pass

Test Mode :	3Mbps	Temperature :	21~25°C
Test Engineer :	Silent Hai	Relative Humidity :	51~55%

Channel	Frequency (MHz)	RF Power (dBm)		
		8-DPSK	Max. Limits (dBm)	Pass/Fail
		3 Mbps		
00	2402	7.74	20.97	Pass
39	2441	8.08	20.97	Pass
78	2480	7.44	20.97	Pass



3.1.6 Test Result of Average Output Power (Report Only)

Test Mode :	1Mbps	Temperature :	21~25°C
Test Engineer :	Silent Hai	Relative Humidity :	51~55%

Channel	Frequency (MHz)	RF Power (dBm)		
		GFSK	Max. Limits (dBm)	Pass/Fail
		1 Mbps		
00	2402	8.92	-	-
39	2441	9.50	-	-
78	2480	8.80	-	-

Test Mode :	2Mbps	Temperature :	21~25°C
Test Engineer :	Silent Hai	Relative Humidity :	51~55%

Channel	Frequency (MHz)	RF Power (dBm)		
		$\pi/4$ -DQPSK	Max. Limits (dBm)	Pass/Fail
		2 Mbps		
00	2402	6.46	-	-
39	2441	6.56	-	-
78	2480	6.26	-	-

Test Mode :	3Mbps	Temperature :	21~25°C
Test Engineer :	Silent Hai	Relative Humidity :	51~55%

Channel	Frequency (MHz)	RF Power (dBm)		
		8-DPSK	Max. Limits (dBm)	Pass/Fail
		3 Mbps		
00	2402	5.77	-	-
39	2441	6.21	-	-
78	2480	5.59	-	-



3.2 Radiated Band Edges and Spurious Emission Measurement

3.2.1 Limit of Radiated Band Edges and Spurious Emission

In any 100 kHz bandwidth outside the intentional radiator frequency band, all harmonics/spurious must be at least 20 dB below the highest emission level within the authorized band. In addition, radiated emissions which fall in the restricted bands must also comply with the limits as below.

Frequency (MHz)	Field Strength (microvolts/meter)	Measurement Distance (meters)
0.009 – 0.490	2400/F(kHz)	300
0.490 – 1.705	24000/F(kHz)	30
1.705 – 30.0	30	30
30 – 88	100	3
88 – 216	150	3
216 - 960	200	3
Above 960	500	3

3.2.2 Measuring Instruments

The measuring equipment is listed in the section 4 of this test report.



3.2.3 Test Procedures

1. The EUT was placed on a turntable with 0.8 meter for frequency below 1GHz and 1.5 meter for frequency above 1GHz respectively above ground.
2. The EUT was set 3 meters from the interference receiving antenna, which was mounted on the top of a variable height antenna tower.
3. For each suspected emission, the EUT was arranged to its worst case and then tune the Antenna tower (from 1 m to 4 m) and turntable (from 0 degree to 360 degrees) to find the maximum reading. A pre-amp and a high pass filter are used for the test in order to get better signal level to comply with the guidelines.
4. Set to the maximum power setting and enable the EUT transmit continuously.
5. Use the following spectrum analyzer settings:
 - (1) Span shall wide enough to fully capture the emission being measured;
 - (2) Set RBW=100 kHz for $f < 1 \text{ GHz}$, RBW=1MHz for $f > 1\text{GHz}$; VBW \geq RBW; Sweep = auto; Detector function = peak; Trace = max hold for peak
 - (3) For average measurement: use duty cycle correction factor method per 15.35(c).
Duty cycle = On time/100 milliseconds
On time = $N_1 * L_1 + N_2 * L_2 + \dots + N_{n-1} * L_{n-1} + N_n * L_n$
Where N_1 is number of type 1 pulses, L_1 is length of type 1 pulses, etc.
Average Emission Level = Peak Emission Level + $20 * \log(\text{Duty cycle})$
6. Corrected Reading: Antenna Factor + Cable Loss + Read Level - Preamp Factor = Level

Note: The average levels were calculated from the peak level corrected with duty cycle correction factor (-24.79dB) derived from $20 \log(\text{dwell time}/100\text{ms})$. This correction is only for signals that hop with the fundamental signal, such as band-edge and harmonic. Other spurious signals that are independent of the hopping signal would not use this correction.

3.2.4 Test Setup

For radiated emissions below 30MHz

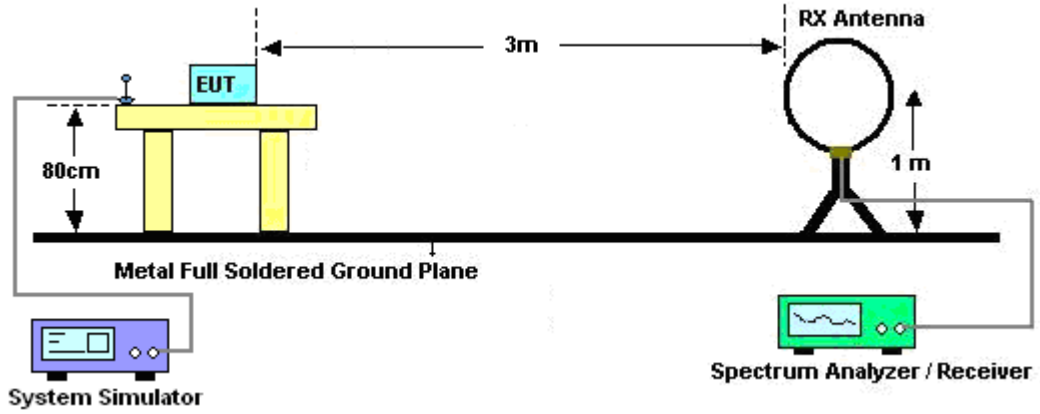

For radiated emissions from 30MHz to 1GHz

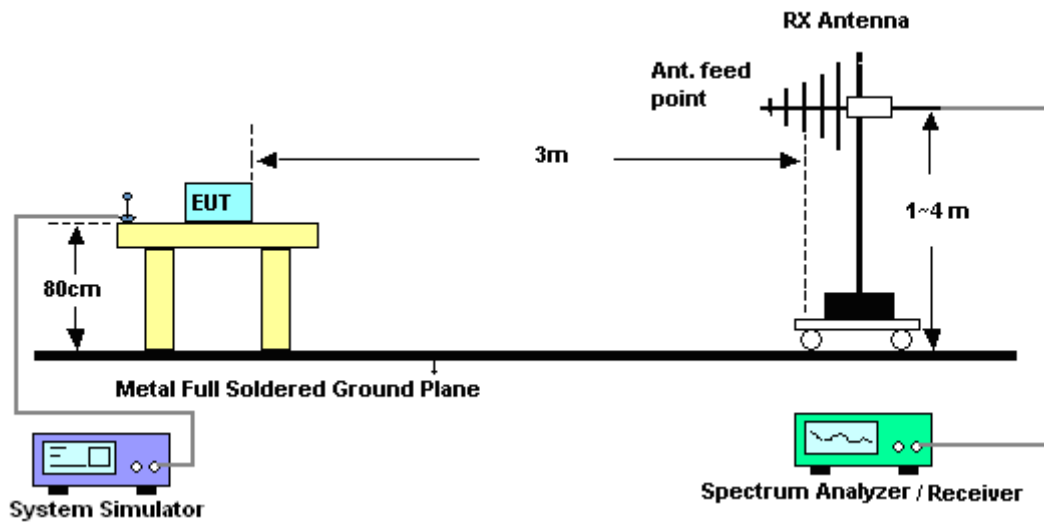

For radiated emissions above 1GHz

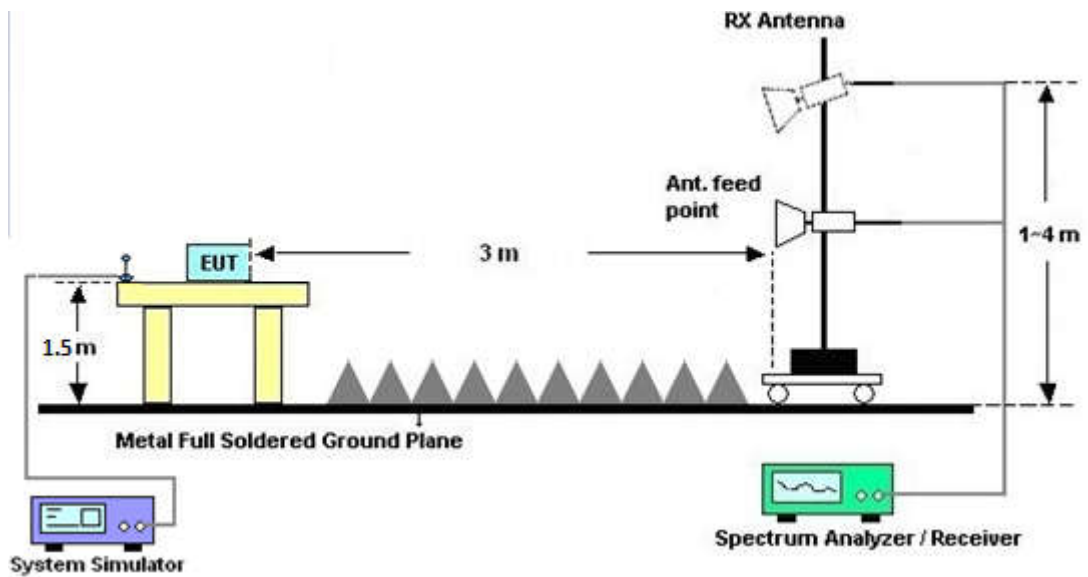

3.2.5 Test Results of Radiated Spurious Emissions (9 kHz ~ 30 MHz)

The low frequency, which started from 9 kHz to 30MHz, was pre-scanned and the result which was 20dB lower than the limit line was not reported.

3.2.6 Duty cycle correction factor for average measurement

DH5 on time (One Pulse) Plot on Channel 39

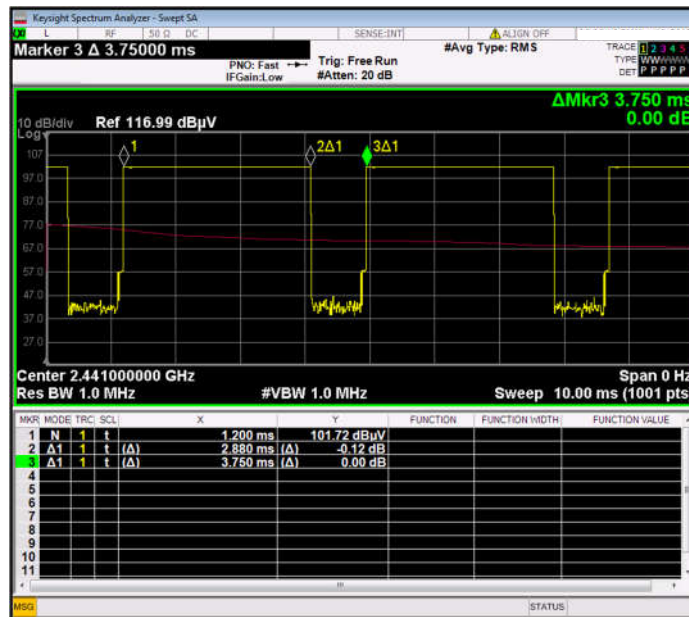

DH5 on time (Count Pulses) Plot on Channel 39

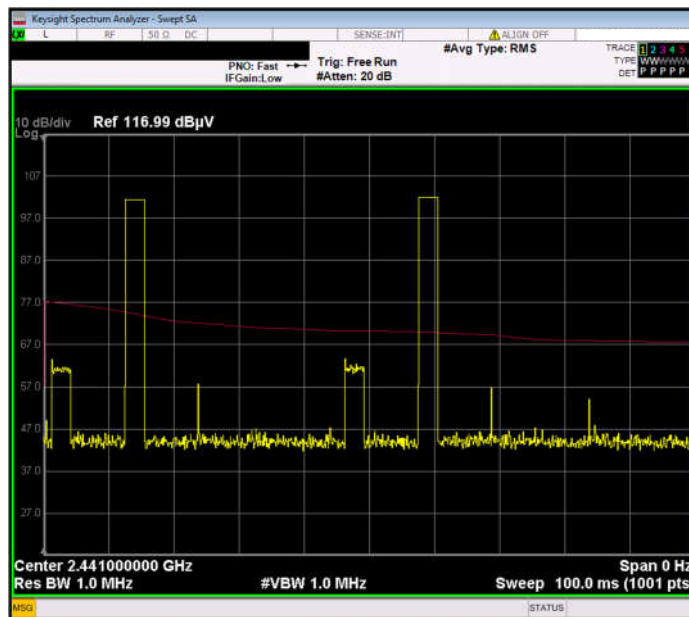

Note:

1. Worst case Duty cycle = on time/100 milliseconds = 2 * 2.88 / 100 = 5.76 %
2. Worst case Duty cycle correction factor = 20*log(Duty cycle) = -24.79 dB
3. DH5 has the highest duty cycle worst case and is reported.



Duty Cycle Correction Factor Consideration for AFH mode:

Bluetooth normal hopping rate is 1600Hz and reduced to 800Hz in AFH mode; due to the reduced number of hopping frequencies, with the same packet configuration the dwell time in each channel frequency within 100msec period is longer in AFH mode than normal mode.

In AFH mode, the minimum hopping frequencies are 20, to get the longest dwell time DH5 packet is observed; the period to have DH5 packet completing one hopping sequence is

$$2.88 \text{ ms} \times 20 \text{ channels} = 57.6 \text{ ms}$$

There cannot be 2 complete hopping sequences within 100ms period, considering the random hopping behavior, maximum 2 hops can be possibly observed within the period. $[100\text{ms} / 57.6\text{ms}] = 2 \text{ hops}$

Thus, the maximum possible ON time:

$$2.88 \text{ ms} \times 2 = 5.76 \text{ ms}$$

Worst case Duty Cycle Correction factor, which is derived from the maximum possible ON time,

$$20 \times \log(5.76 \text{ ms}/100\text{ms}) = -24.79 \text{ dB}$$

3.2.7 Test Result of Radiated Spurious at Band Edges

Please refer to Appendix A and B.

3.2.8 Test Result of Radiated Spurious Emission (30MHz ~ 10th Harmonic)

Please refer to Appendix A and B.



3.3 AC Conducted Emission Measurement

3.3.1 Limit of AC Conducted Emission

For equipment that is designed to be connected to the public utility (AC) power line, the radio frequency voltage that is conducted back onto the AC power line on any frequency or frequencies within the band 150 kHz to 30 MHz shall not exceed the limits in the following table.

Frequency of emission (MHz)	Conducted limit (dBµV)	
	Quasi-peak	Average
0.15-0.5	66 to 56*	56 to 46*
0.5-5	56	46
5-30	60	50

*Decreases with the logarithm of the frequency.

3.3.2 Measuring Instruments

The measuring equipment is listed in the section 4 of this test report.

3.3.3 Test Procedures

1. The EUT was placed 0.4 meter from the conducting wall of the shielding room was kept at least 80 centimeters from any other grounded conducting surface.
2. Connect EUT to the power mains through a line impedance stabilization network (LISN).
3. All the support units are connecting to the other LISN.
4. The LISN provides 50 ohm coupling impedance for the measuring instrument.
5. The FCC states that a 50 ohm, 50 microhenry LISN should be used.
6. Both sides of AC line were checked for maximum conducted interference.
7. The frequency range from 150 kHz to 30 MHz was searched.
8. Set the test-receiver system to Peak Detect Function and specified bandwidth (IF Bandwidth = 9kHz) with Maximum Hold Mode. Then measurement is also conducted by Average Detector and Quasi-Peak Detector Function respectively.

3.3.4 Test Setup

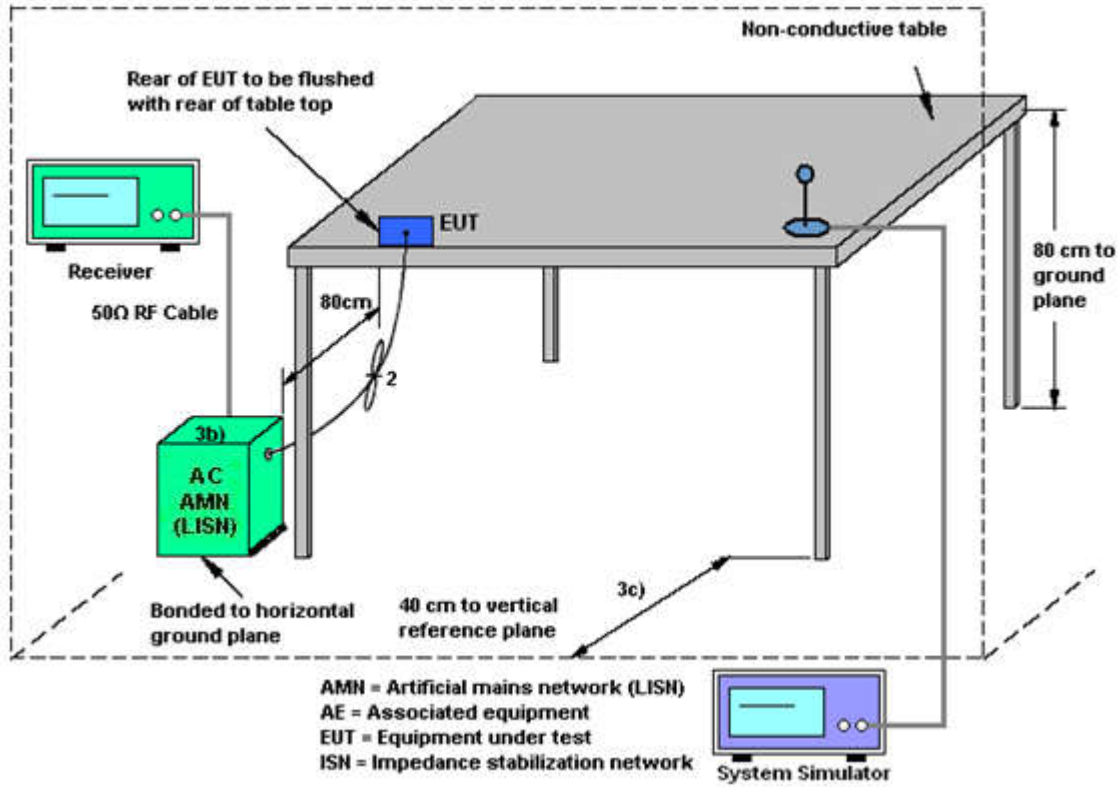



3.3.5 Test Result of AC Conducted Emission

Test Mode :	Mode 1	Temperature :	22~24°C
Test Engineer :	Amos Zhang	Relative Humidity :	42~46%
Test Voltage :	120Vac / 60Hz	Phase :	Line
Function Type :	WCDMA Band II Idle + Bluetooth Link + WLAN Link (2.4G) + Adaptor + display with type C cable + Earphone		

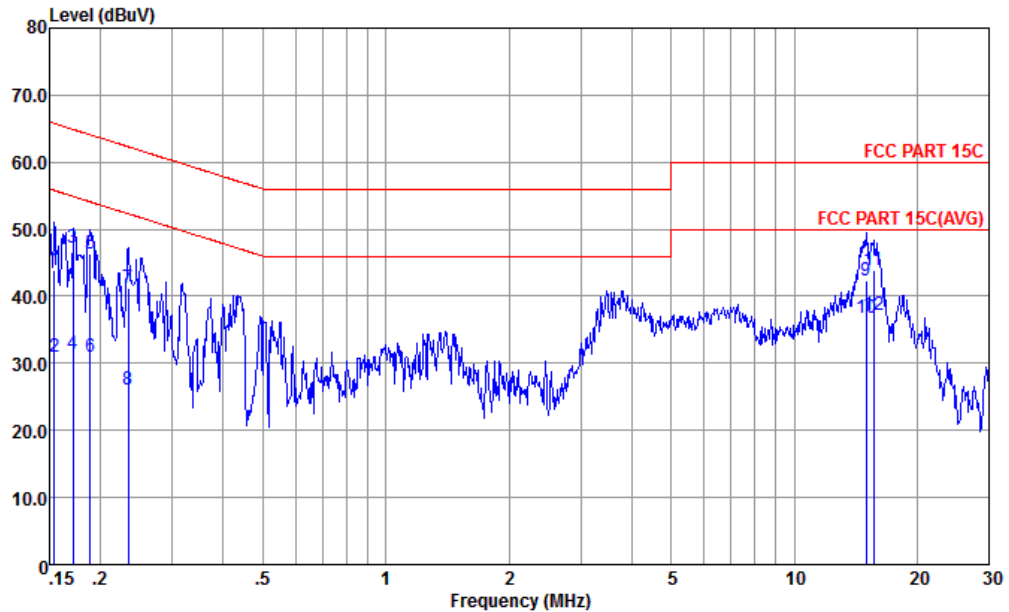

Site : CO01-KS
 Condition : FCC PART 15C LISN-L-171013-060103 LINE

	Freq	Level	Over Limit	Limit Line	Read Level	LISN Factor	Cable Loss	Remark
	MHz	dBuV	dB	dBuV	dBuV	dB	dB	
1	0.154	43.97	-21.81	65.78	33.21	0.16	10.60	QP
2	0.154	30.97	-24.81	55.78	20.21	0.16	10.60	Average
3	0.171	47.32	-17.58	64.90	36.59	0.18	10.55	QP
4	0.171	31.32	-23.58	54.90	20.59	0.18	10.55	Average
5	0.188	46.28	-17.83	64.11	35.60	0.19	10.49	QP
6	0.188	30.88	-23.23	54.11	20.20	0.19	10.49	Average
7	0.234	41.25	-21.05	62.30	30.60	0.21	10.44	QP
8	0.234	26.15	-26.15	52.30	15.50	0.21	10.44	Average
9	14.986	42.27	-17.73	60.00	31.60	0.26	10.41	QP
10	14.986	36.87	-13.13	50.00	26.20	0.26	10.41	Average
11	15.635	43.87	-16.13	60.00	33.20	0.25	10.42	QP
12 *	15.635	37.27	-12.73	50.00	26.60	0.25	10.42	Average



Test Mode :	Mode 1	Temperature :	22~24°C
Test Engineer :	Amos Zhang	Relative Humidity :	42~46%
Test Voltage :	120Vac / 60Hz	Phase :	Neutral
Function Type :	WCDMA Band II Idle + Bluetooth Link + WLAN Link (2.4G) + Adaptor + display with type C cable + Earphone		

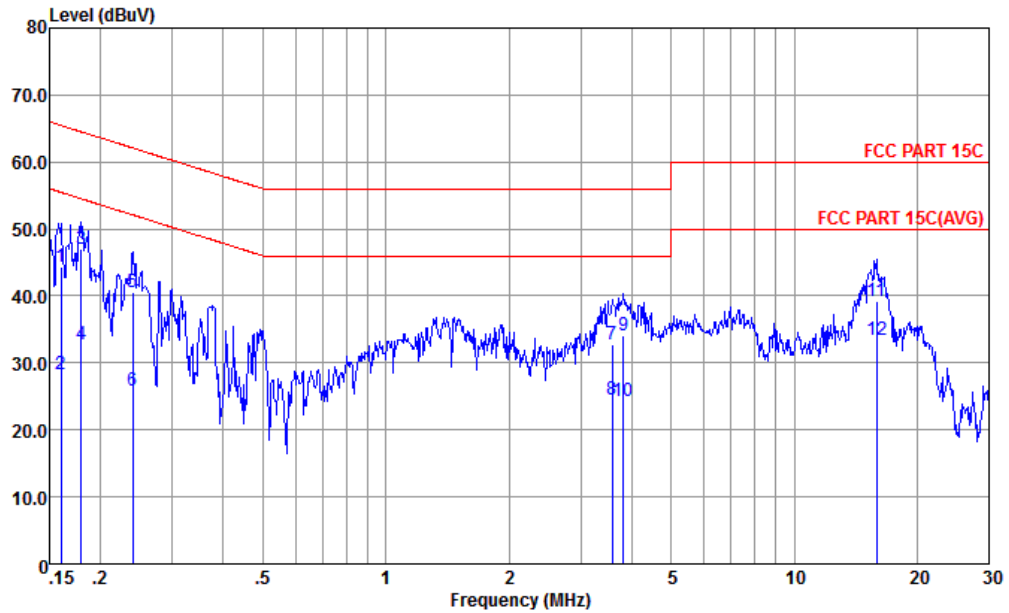

Site : CO01-KS
 Condition : FCC PART 15C LISN-N-171013-060103 NEUTRAL

	Freq	Level	Over Limit	Limit Line	Read Level	LISN Factor	Cable Loss	Remark
	MHz	dBuV	dB	dBuV	dBuV	dB	dB	
1	0.160	44.36	-21.11	65.47	33.50	0.28	10.58	QP
2	0.160	28.36	-27.11	55.47	17.50	0.28	10.58	Average
3	0.180	47.00	-17.50	64.50	36.20	0.28	10.52	QP
4	0.180	32.70	-21.80	54.50	21.90	0.28	10.52	Average
5	0.240	40.52	-21.56	62.08	29.80	0.28	10.44	QP
6	0.240	25.92	-26.16	52.08	15.20	0.28	10.44	Average
7	3.584	32.81	-23.19	56.00	22.31	0.33	10.17	QP
8	3.584	24.41	-21.59	46.00	13.91	0.33	10.17	Average
9	3.820	34.10	-21.90	56.00	23.60	0.33	10.17	QP
10	3.820	24.30	-21.70	46.00	13.80	0.33	10.17	Average
11	15.885	39.22	-20.78	60.00	28.60	0.19	10.43	QP
12 *	15.885	33.52	-16.48	50.00	22.90	0.19	10.43	Average



3.4 Antenna Requirements

3.4.1 Standard Applicable

If directional gain of transmitting antennas is greater than 6dBi, the power shall be reduced by the same level in dB comparing to gain minus 6dBi. The use of a permanently attached antenna or of an antenna that uses a unique coupling to the intentional radiator shall be considered sufficient to comply with the rule.

3.4.2 Antenna Anti-Replacement Construction

An embedded-in antenna design is used.

3.4.3 Antenna Gain

The antenna peak gain of EUT is less than 6 dBi. Therefore, it is not necessary to reduce maximum peak output power limit.



4 List of Measuring Equipment

Instrument	Manufacturer	Model No.	Serial No.	Characteristics	Calibration Date	Test Date	Due Date	Remark
Pulse Power Sensor	Anritsu	MA2411B	0917070	300MHz~40GHz	Jan. 19, 2017	Nov. 20, 2017~ Nov. 21, 2017	Jan. 18, 2018	Conducted (TH01-KS)
Power Meter	Anritsu	ML2495A	1005002	50MHz Bandwidth	Jan. 19, 2017	Nov. 20, 2017~ Nov. 21, 2017	Jan. 18, 2018	Conducted (TH01-KS)
EMI Test Receiver	Keysight	N9038A	MY56400004	3Hz~8.5GHz; Max 30dBm	Oct. 19, 2017	Nov. 20, 2017	Oct. 18, 2018	Radiation (03CH03-KS)
EXA Spectrum Analyzer	Keysight	N9010A	MY55150244	10Hz-44GHz	Apr. 18, 2017	Nov. 20, 2017	Apr. 17, 2018	Radiation (03CH03-KS)
Loop Antenna	R&S	HFH2-Z2	100321	9kHz~30MHz	Nov. 23, 2016	Nov. 20, 2017	Nov. 22, 2017	Radiation (03CH03-KS)
Bilog Antenna	TeseQ	CBL6112D	35406	25MHz-2GHz	Apr. 22, 2017	Nov. 20, 2017	Apr. 21, 2018	Radiation (03CH03-KS)
Horn Antenna	Schwarzbeck	BBHA9120D	9120D-1356	1GHz~18GHz	Apr. 22, 2017	Nov. 20, 2017	Apr. 21, 2018	Radiation (03CH03-KS)
SHF-EHF Horn	Schwarzbeck	BBHA 9170	BBHA170249	15GHz~40GHz	Feb. 15, 2017	Nov. 20, 2017	Feb. 14, 2018	Radiation (03CH03-KS)
Amplifier	com-power	PA-103A	161069	1MHz ~1000MHz / 32 dB	Apr. 18, 2017	Nov. 20, 2017	Apr. 17, 2018	Radiation (03CH03-KS)
Amplifier	MITEQ	TTA1840-35-HG	1887435	18GHz~40GHz	Oct. 12, 2017	Nov. 20, 2017	Oct. 11, 2018	Radiation (03CH03-KS)
high gain Amplifier	MITEQ	AMF-7D-0010 1800-30-10P	2025788	1Ghz-18Ghz	Apr. 18, 2017	Nov. 20, 2017	Apr. 17, 2018	Radiation (03CH03-KS)
AC Power Source	Chroma	61601	F104090004	N/A	NCR	Nov. 20, 2017	NCR	Radiation (03CH03-KS)
Turn Table	ChamPro	EM 1000-T	060762-T	0~360 degree	NCR	Nov. 20, 2017	NCR	Radiation (03CH03-KS)
Antenna Mast	ChamPro	EM 1000-A	060762-A	1 m~4 m	NCR	Nov. 20, 2017	NCR	Radiation (03CH03-KS)
EMI Receiver	R&S	ESC17	100768	9kHz~7GHz;	Apr. 20, 2017	Nov. 16, 2017	Apr. 19, 2018	Conduction (CO01-KS)
AC LISN	MessTec	AN3016	060103	9kHz~30MHz	Oct. 13, 2017	Nov. 16, 2017	Oct. 12, 2018	Conduction (CO01-KS)
AC LISN (for auxiliary equipment)	MessTec	AN3016	060105	9kHz~30MHz	Oct. 13, 2017	Nov. 16, 2017	Oct. 12, 2018	Conduction (CO01-KS)
AC Power Source	Chroma	61602	ABP00000811	AC 0V~300V, 45Hz~1000Hz	Oct. 12, 2017	Nov. 16, 2017	Oct. 11, 2018	Conduction (CO01-KS)

NCR: No Calibration Required



5 Uncertainty of Evaluation

Uncertainty of Conducted Emission Measurement (150 kHz ~ 30 MHz)

Measuring Uncertainty for a Level of Confidence of 95% ($U = 2Uc(y)$)	2.3dB
---	-------

Uncertainty of Radiated Emission Measurement (30 MHz ~ 1000 MHz)

Measuring Uncertainty for a Level of Confidence of 95% ($U = 2Uc(y)$)	4.6dB
---	-------

Uncertainty of Radiated Emission Measurement (1000 MHz ~ 18000 MHz)

Measuring Uncertainty for a Level of Confidence of 95% ($U = 2Uc(y)$)	4.5dB
---	-------

Uncertainty of Radiated Emission Measurement (18000 MHz ~ 40000 MHz)

Measuring Uncertainty for a Level of Confidence of 95% ($U = 2Uc(y)$)	4.7dB
---	-------



Appendix A. Radiated Spurious Emission

Sample 1

2.4GHz 2400~2483.5MHz

BT (Band Edge @ 3m)

BT	Note	Frequency	Level	Over Limit	Limit Line	Read Level	Antenna Factor	Cable Loss	Preamp Factor	Ant Pos	Table Pos	Peak Avg.	Pol.
		(MHz)	(dBμV/m)	(dB)	(dBμV/m)	(dBμV)	(dB/m)	(dB)	(dB)	(cm)	(deg)	(P/A)	(H/V)
BT CH00 2402MHz		2313.77	40.24	-33.76	74	41.77	25.13	5.55	32.21	113	308	P	H
		2313.77	15.45	-38.55	54	-	-	-	-	-	-	A	H
	*	2402	97.16	-	-	98.41	25.4	5.65	32.3	113	308	P	H
	*	2402	72.37	-	-	-	-	-	-	-	-	A	H
		2372.53	39.89	-34.11	74	41.19	25.35	5.63	32.28	227	276	P	V
		2372.53	15.1	-38.9	54	-	-	-	-	-	-	A	V
	*	2402	98.52	-	-	99.77	25.4	5.65	32.3	227	276	P	V
	*	2402	73.73	-	-	-	-	-	-	-	-	A	V
BT CH 39 2441MHz		2356.8	39.61	-34.39	74	40.97	25.29	5.61	32.26	102	308	P	H
		2356.8	14.82	-39.18	54	-	-	-	-	-	-	A	H
	*	2442	99.83	-	-	100.63	25.83	5.71	32.34	102	308	P	H
	*	2442	75.04	-	-	-	-	-	-	-	-	A	H
		2499.72	41.16	-32.84	74	41.52	26.26	5.77	32.39	102	308	P	H
		2499.72	16.37	-37.63	54	-	-	-	-	-	-	A	H
		2368.63	39.92	-34.08	74	41.22	25.35	5.63	32.28	237	272	P	V
		2368.63	15.13	-38.87	54	-	-	-	-	-	-	A	V
	*	2442	100.35	-	-	101.15	25.83	5.71	32.34	237	272	P	V
	*	2442	75.56	-	-	-	-	-	-	-	-	A	V
		2498.88	41.04	-32.96	74	41.4	26.26	5.77	32.39	237	272	P	V
	2498.88	16.25	-37.75	54	-	-	-	-	-	-	A	V	



BT CH 78 2480MHz		2484.18	48.13	-25.87	74	48.64	26.11	5.75	32.37	106	305	P	H
		2484.18	23.34	-30.66	54	-	-	-	-	-	-	A	H
	*	2480	98.62	-	-	99.13	26.11	5.75	32.37	106	305	P	H
	*	2480	73.83	-	-	-	-	-	-	-	-	A	H
		2483.69	49.38	-24.62	74	49.89	26.11	5.75	32.37	220	266	P	V
		2483.69	24.59	-29.41	54	-	-	-	-	-	-	A	V
	*	2480	98.71	-	-	99.22	26.11	5.75	32.37	220	266	P	V
	*	2480	73.92	-	-	-	-	-	-	-	-	A	V
Remark	<ol style="list-style-type: none"> No other spurious found. All results are PASS against Peak and Average limit line. 												



2.4GHz 2400~2483.5MHz

BT (Harmonic @ 3m)

BT	Note	Frequency (MHz)	Level (dBμV/m)	Over Limit (dB)	Limit Line (dBμV/m)	Read Level (dBμV)	Antenna Factor (dB/m)	Cable Loss (dB)	Preamp Factor (dB)	Ant Pos (cm)	Table Pos (deg)	Peak Avg. (P/A)	Pol. (H/V)
BT CH 00 2402MHz		4806	39.29	-34.71	74	61.94	30.86	7.84	61.35	100	40	P	H
		4806	39.28	-34.72	74	61.93	30.86	7.84	61.35	100	8	P	V
BT CH 39 2441MHz		4884	38.12	-35.88	74	60.41	31.01	7.9	61.2	100	358	P	H
		7320	41.85	-32.15	74	60.06	35.39	9.51	63.11	100	358	P	H
		4884	38.68	-35.32	74	60.97	31.01	7.9	61.2	100	341	P	V
		7320	40.9	-33.1	74	59.11	35.39	9.51	63.11	100	341	P	V
BT CH 78 2480MHz		4962	40.11	-33.89	74	61.96	31.19	7.97	61.01	100	0	P	H
		7440	41.22	-32.78	74	59.19	35.68	9.57	63.22	100	0	P	H
		4962	39.19	-34.81	74	61.04	31.19	7.97	61.01	100	0	P	V
		7440	41.34	-32.66	74	59.31	35.68	9.57	63.22	100	0	P	V
Remark	1. No other spurious found. 2. All results are PASS against Peak and Average limit line.												



Sample 2

2.4GHz 2400~2483.5MHz

BT (Band Edge @ 3m)

BT	Note	Frequency	Level	Over	Limit	Read	Antenna	Cable	Preamp	Ant	Table	Peak	Pol.
		(MHz)	(dBμV/m)	(dB)	(dBμV/m)	(dBμV)	(dB/m)	(dB)	(dB)	(cm)	(deg)	(P/A)	(H/V)
BT CH 78 2480MHz		2483.76	50.47	-23.53	74	50.98	26.11	5.75	32.37	130	299	P	H
		2483.76	25.68	-28.32	54	-	-	-	-	-	-	A	H
	*	2480	98.32	-	-	98.83	26.11	5.75	32.37	130	299	P	H
	*	2480	73.53	-	-	-	-	-	-	-	-	A	H
		2483.69	49.89	-24.11	74	50.4	26.11	5.75	32.37	376	129	P	V
		2483.69	25.1	-28.9	54	-	-	-	-	-	-	A	V
	*	2480	96.61	-	-	97.12	26.11	5.75	32.37	376	129	P	V
	*	2480	71.82	-	-	-	-	-	-	-	-	A	V
Remark	3. No other spurious found. 4. All results are PASS against Peak and Average limit line.												

2.4GHz 2400~2483.5MHz

BT (Harmonic @ 3m)

BT	Note	Frequency	Level	Over	Limit	Read	Antenna	Cable	Preamp	Ant	Table	Peak	Pol.
		(MHz)	(dBμV/m)	(dB)	(dBμV/m)	(dBμV)	(dB/m)	(dB)	(dB)	(cm)	(deg)	(P/A)	(H/V)
BT CH 78 2480MHz		4962	37.53	-36.47	74	59.38	31.19	7.97	61.01	100	360	P	H
		7440	41.15	-32.85	74	59.12	35.68	9.57	63.22	100	360	P	H
		4962	37.77	-36.23	74	59.62	31.19	7.97	61.01	100	360	P	V
		7440	39.96	-34.04	74	57.93	35.68	9.57	63.22	100	360	P	V
Remark	3. No other spurious found. 4. All results are PASS against Peak and Average limit line.												



Emission below 1GHz

2.4GHz BT (LF)

BT	Note	Frequency	Level	Over	Limit	Read	Antenna	Cable	Preamp	Ant	Table	Peak	Pol.
		(MHz)	(dBμV/m)	(dB)	(dBμV/m)	(dBμV)	(dB/m)	(dB)	(dB)	(cm)	(deg)	(P/A)	(H/V)
2.4GHz BT LF		30	26.46	-13.54	40	30.69	26.3	0.57	31.1	100	214	P	H
		92.08	26.3	-17.2	43.5	38.87	17.06	1.05	30.68	-	-	P	H
		183.26	25.78	-17.72	43.5	39.12	16.23	1.46	31.03	-	-	P	H
		223.03	28.56	-17.44	46	41.38	16.72	1.61	31.15	-	-	P	H
		251.16	25.82	-20.18	46	37.38	17.93	1.72	31.21	-	-	P	H
		474.26	25.05	-20.95	46	30.55	23.68	2.42	31.6	-	-	P	H
		30	33.53	-6.47	40	37.76	26.3	0.57	31.1	100	214	P	V
		59.1	30.36	-9.64	40	48.73	12.38	0.83	31.58	-	-	P	V
		74.62	30.24	-9.76	40	46.12	14.6	0.92	31.4	-	-	P	V
		362.71	21	-25	46	28.86	21.56	2.08	31.5	-	-	P	V
		540.22	24.21	-21.79	46	28.5	24.66	2.57	31.52	-	-	P	V
		799.21	29.15	-16.85	46	28.91	27.79	3.15	30.7	-	-	P	V
Remark	1. No other spurious found. 2. All results are PASS against limit line.												



Note symbol

*	Fundamental Frequency which can be ignored. However, the level of any unwanted emissions shall not exceed the level of the fundamental frequency.
!	Test result is over limit line.
P/A	Peak or Average
H/V	Horizontal or Vertical



A calculation example for radiated spurious emission is shown as below:

WIFI	Note	Frequency	Level	Over	Limit	Read	Antenna	Cable	Preamp	Ant	Table	Peak	Pol.
Ant.				Limit	Line	Level	Factor	Loss	Factor	Pos	Pos	Avg.	
1+2		(MHz)	(dBμV/m)	(dB)	(dBμV/m)	(dBμV)	(dB/m)	(dB)	(dB)	(cm)	(deg)	(P/A)	(H/V)
802.11b		2390	55.45	-18.55	74	54.51	32.22	4.58	35.86	103	308	P	H
CH 01													
2412MHz		2390	43.54	-10.46	54	42.6	32.22	4.58	35.86	103	308	A	H

- Level(dBμV/m) =
Antenna Factor(dB/m) + Cable Loss(dB) + Read Level(dBμV) - Preamp Factor(dB)
- Over Limit(dB) = Level(dBμV/m) – Limit Line(dBμV/m)

For Peak Limit @ 2390MHz:

- Level(dBμV/m)
= Antenna Factor(dB/m) + Cable Loss(dB) + Read Level(dBμV) - Preamp Factor(dB)
= 32.22(dB/m) + 4.58(dB) + 54.51(dBμV) – 35.86 (dB)
= 55.45 (dBμV/m)
- Over Limit(dB)
= Level(dBμV/m) – Limit Line(dBμV/m)
= 55.45(dBμV/m) – 74(dBμV/m)
= -18.55(dB)

For Average Limit @ 2390MHz:

- Level(dBμV/m)
= Antenna Factor(dB/m) + Cable Loss(dB) + Read Level(dBμV) - Preamp Factor(dB)
= 32.22(dB/m) + 4.58(dB) + 42.6(dBμV) – 35.86 (dB)
= 43.54 (dBμV/m)
- Over Limit(dB)
= Level(dBμV/m) – Limit Line(dBμV/m)
= 43.54(dBμV/m) – 54(dBμV/m)
= -10.46(dB)

Both peak and average measured complies with the limit line, so test result is “PASS”.



Appendix B. Radiated Spurious Emission Plots

Sample 1

2.4GHz 2400~2483.5MHz

BT (Band Edge @ 3m)

BT	2.4GHz 2400~2483.5MHz Band Edge @ 3m	
ANT	BT CH00 2402MHz	
1	Horizontal	Fundamental
Peak	<p>Site : 03CWB3-KS Condition : FCC PART 15C 3m 966-04 HF ANT HORIZONTAL</p>	<p>Site : 03CWB3-KS Condition : FCC PART 15C 3m 966-04 HF ANT HORIZONTAL</p>



BT	2.4GHz 2400~2483.5MHz Band Edge @ 3m	
ANT	BT CH00 2402MHZ	
1	Vertical	Fundamental
Peak	<p>Site : 03CH3-KS Condition : FCC PART 15C 3m 066-04 HF ANT VERTICAL</p>	<p>Site : 03CH3-KS Condition : FCC PART 15C 3m 966-04 HF ANT VERTICAL</p>



BT	2.4GHz 2400~2483.5MHz Band Edge @ 3m	
ANT	BT CH39 2441MHz	
1	Horizontal	Fundamental
Peak	<p>Site : 03CH83-KS Condition : FCC PART 15C 3m 966-04 HF ANT HORIZONTAL</p>	<p>Site : 03CH83-KS Condition : FCC PART 15C 3m 966-04 HF ANT HORIZONTAL</p>
Peak	<p>Site : 03CH83-KS Condition : FCC PART 15C 3m 966-04 HF ANT HORIZONTAL</p>	

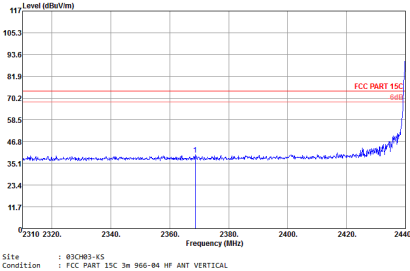
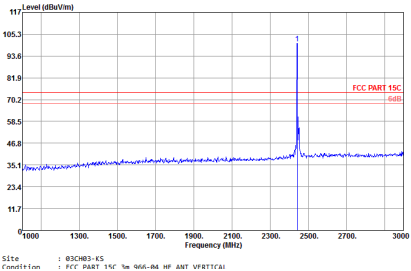
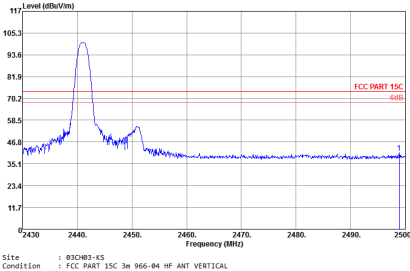

BT	2.4GHz 2400~2483.5MHz Band Edge @ 3m	
ANT	BT CH39 2441MHz	
1	Vertical	Fundamental
Peak		
Peak		



BT	2.4GHz 2400~2483.5MHz Band Edge @ 3m	
ANT	BT CH78 2480MHz	
1	Fundamental	Horizontal
Peak	<p>Site : 03CH03-KS Condition : FCC PART 15C 3m 966-04 HF ANT HORIZONTAL</p>	<p>Site : 03CH03-KS Condition : FCC PART 15C 3m 966-04 HF ANT HORIZONTAL</p>

BT	2.4GHz 2400~2483.5MHz Band Edge @ 3m	
ANT	BT CH78 2480MHz	
1	Fundamental	Vertical
Peak	<p>Site : 03CH03-KS Condition : FCC PART 15C 3m 966-04 HF ANT VERTICAL</p>	<p>Site : 03CH03-KS Condition : FCC PART 15C 3m 966-04 HF ANT VERTICAL</p>



2.4GHz 2400~2483.5MHz

BT (Harmonic @ 3m)

BT	2.4GHz 2400~2483.5MHz Harmonic @ 3m	
ANT	BT CH00 2402MHz	
1	Horizontal	Vertical
Peak Avg.	<p>Site : 603083-KS Condition : FCC PART 15C 3m 966-84 HF ANT HORIZONTAL</p>	<p>Site : 603083-KS Condition : FCC PART 15C 3m 966-84 HF ANT VERTICAL</p>



BT	2.4GHz 2400~2483.5MHz Harmonic @ 3m	
ANT	BT CH39 2441MHz	
1	Horizontal	Vertical
Peak Avg.	<p>Site : 03CH03-KS Condition : FCC PART 15C 3m 966-04 HF ANT HORIZONTAL</p>	<p>Site : 03CH03-KS Condition : FCC PART 15C 3m 966-04 HF ANT VERTICAL</p>

BT	2.4GHz 2400~2483.5MHz Harmonic @ 3m	
ANT	BT CH78 2480MHz	
1	Horizontal	Vertical
Peak Avg.	<p>Site : 03CH03-KS Condition : FCC PART 15C 3m 966-04 HF ANT HORIZONTAL</p>	<p>Site : 03CH03-KS Condition : FCC PART 15C 3m 966-04 HF ANT VERTICAL</p>



Emission below 1GHz

2.4GHz BT (LF)

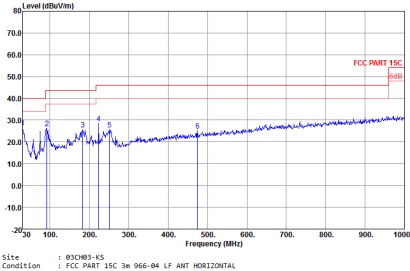
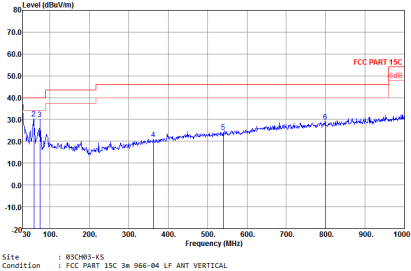
BT	2.4GHz 2400~2483.5MHz	
ANT	BT LF	
1	Horizontal	Vertical
QP / Peak	 <p>Site : 030M03-KS Condition : FCC PART 15C 3m 966-04 LF ANT HORIZONTAL</p>	 <p>Site : 030M03-KS Condition : FCC PART 15C 3m 966-04 LF ANT VERTICAL</p>



Sample 2

2.4GHz 2400~2483.5MHz

BT (Band Edge @ 3m)

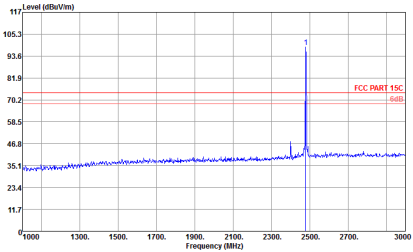
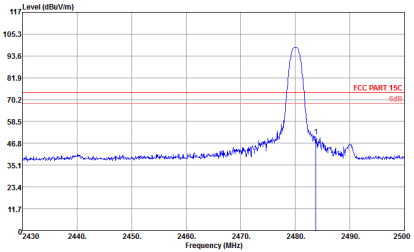
BT	2.4GHz 2400~2483.5MHz Band Edge @ 3m	
ANT	BT CH78 2480MHz	
1	Fundamental	Horizontal
Peak	 <p>Site : 83CH83-K5 Condition : FCC PART 15C 3m 966-04 HF ANT HORIZONTAL</p>	 <p>Site : 83CH83-K5 Condition : FCC PART 15C 3m 966-04 HF ANT HORIZONTAL</p>



BT	2.4GHz 2400~2483.5MHz Band Edge @ 3m	
ANT	BT CH78 2480MHz	
1	Fundamental	Vertical
Peak	<p>Site : 03C103-K5 Condition : FCC PART 15C 3m 966-04 HF ANT VERTICAL</p>	<p>Site : 03C103-K5 Condition : FCC PART 15C 3m 966-04 HF ANT VERTICAL</p>

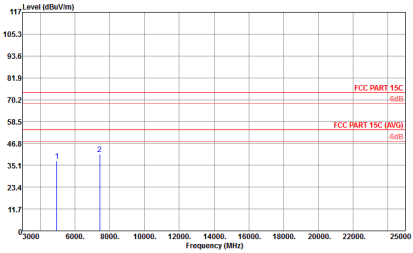
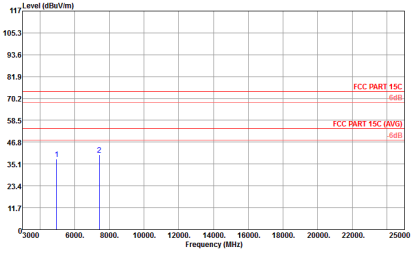

BT	2.4GHz 2400~2483.5MHz Harmonic @ 3m	
ANT	BT CH78 2480MHz	
1	Horizontal	Vertical
Peak Avg.	 <p>Site : 03CH83-K5 Condition : FCC PART 15C 3m 966-04 HF ANT HORIZONTAL</p>	 <p>Site : 03CH83-K5 Condition : FCC PART 15C 3m 966-04 HF ANT VERTICAL</p>



Emission below 1GHz

2.4GHz BT (LF)

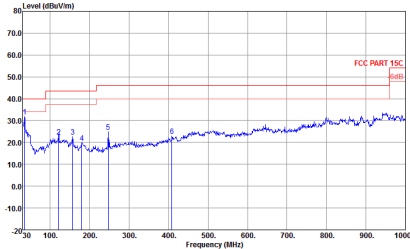
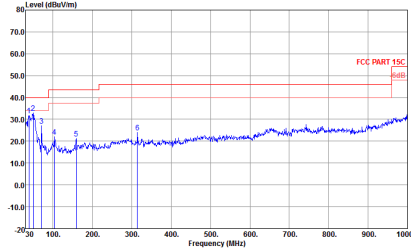
BT	2.4GHz 2400~2483.5MHz	
ANT	BT LF	
1	Horizontal	Vertical
QP / Peak	 <p>Site : 83CH3-K5 Condition : FCC PART 15C 3n 966-04 LF ANT HORIZONTAL</p>	 <p>Site : 83CH3-K5 Condition : FCC PART 15C 3n 966-04 LF ANT VERTICAL</p>