



中认信通
CHINA CERTIFICATION ICT CO., LTD. (DONGGUAN)



TEST REPORT

Applicant: Edco Electronics Inc.

Address: FCC:8484 Avenue de l'Esplanade Montreal, Quebec Montreal, H2P
2R7 Canada
ISED: 8484 Avenue de l'Esplanade Montréal QC H2P 2R7 Canada

FCC ID: 2AJMW-BTSPK84

IC: 20174-BTSPK84

HVIN: BTSPK84

Product Name: PORTABLE WIRELESS SPEAKER

Model Number: BTSPK84

Standard(s): 47 CFR Part 15, Subpart C(15.247)
RSS-247 Issue 2, February 2017
RSS-Gen, Issue 5, February 2021 Amendment 2
ANSI C63.10-2013
KDB 558074 D01 15.247 Meas Guidance v05r02

The above equipment has been tested and found compliance with the requirement of the relative standards by China Certification ICT Co., Ltd (Dongguan)

Report Number: CR21090047-08B

Date Of Issue: 2021-11-22

Reviewed By: Sun Zhong

Sun Zhong

Title: Manager

Test Laboratory: China Certification ICT Co., Ltd (Dongguan)

No. 113, Pingkang Road, Dalang Town, Dongguan,
Guangdong, China
Tel: +86-769-82016888

Test Facility

The Test site used by China Certification ICT Co., Ltd (Dongguan) to collect test data is located on the No. 113, Pingkang Road, Dalang Town, Dongguan, Guangdong, China.

The lab has been recognized as the FCC accredited lab under the KDB 974614 D01 and is listed in the FCC Public Access Link (PAL) database, FCC Registration No. : 442868, the FCC Designation No. : CN1314.

The lab has been recognized by Innovation, Science and Economic Development Canada to test to Canadian radio equipment requirements, the CAB identifier: CN0123.

Declarations

China Certification ICT Co., Ltd (Dongguan) is not responsible for the authenticity of any test data provided by the applicant. Data included from the applicant that may affect test results are marked with a triangle symbol “▲”. Customer model name, addresses, names, trademarks etc. are not considered data.

Unless otherwise stated the results shown in this test report refer only to the sample(s) tested.

This report cannot be reproduced except in full, without prior written approval of the Company.

This report is valid only with a valid digital signature. The digital signature may be available only under the Adobe software above version 7.0.

This report may contain data that are not covered by the accreditation scope and shall be marked with an asterisk “★”.

CONTENTS

TEST FACILITY	2
DECLARATIONS.....	2
1. GENERAL INFORMATION	5
1.1 PRODUCT DESCRIPTION FOR EQUIPMENT UNDER TEST (EUT)	5
1.2 DESCRIPTION OF TEST CONFIGURATION.....	7
1.2.2 Support Equipment List and Details	7
1.2.3 Support Cable List and Details	7
1.2.4 Block Diagram of Test Setup.....	8
1.3 MEASUREMENT UNCERTAINTY	10
2. SUMMARY OF TEST RESULTS	11
3. REQUIREMENTS AND TEST PROCEDURES	12
3.1 AC LINE CONDUCTED EMISSIONS.....	12
3.1.1 Applicable Standard.....	12
3.1.2 EUT Setup.....	14
3.1.3 EMI Test Receiver Setup	14
3.1.4 Test Procedure	15
3.1.5 Corrected Amplitude & Margin Calculation.....	15
3.2 RADIATION SPURIOUS EMISSIONS.....	16
3.2.1 Applicable Standard.....	16
3.2.2 EUT Setup.....	16
3.2.3 EMI Test Receiver & Spectrum Analyzer Setup	17
3.2.4 Test Procedure	18
3.2.5 Corrected Amplitude & Margin Calculation.....	18
3.3 6 dB EMISSION BANDWIDTH:.....	19
3.3.1 Applicable Standard.....	19
3.3.2 EUT Setup.....	19
3.3.3 Test Procedure	19
3.4 99% OCCUPIED BANDWIDTH:	20
3.4.1 Applicable Standard.....	20
3.4.2 EUT Setup.....	20
3.4.3 Test Procedure	20
3.5 MAXIMUM PEAK CONDUCTED OUTPUT POWER:.....	21
3.5.1 Applicable Standard.....	21
3.5.2 EUT Setup.....	21
3.5.3 Test Procedure	21
3.6 MAXIMUM POWER SPECTRAL DENSITY:	22
3.6.1 Applicable Standard.....	22
3.6.2 EUT Setup.....	22
3.6.3 Test Procedure	22
3.7 100 KHZ BANDWIDTH OF FREQUENCY BAND EDGE:	23
3.7.1 Applicable Standard.....	23

3.7.2 EUT Setup.....23
3.7.3 Test Procedure23
3.8 DUTY CYCLE:.....24
3.8.1 EUT Setup.....24
3.8.2 Test Procedure24
3.9 ANTENNA REQUIREMENT.....25
3.9.1 Applicable Standard.....25
3.9.2 Judgment.....25
4. Test DATA AND RESULTS 26
4.1 AC LINE CONDUCTED EMISSIONS.....26
4.2 RADIATION SPURIOUS EMISSIONS29
4.3 6 DB EMISSION BANDWIDTH:36
4.5 99% OCCUPIED BANDWIDTH:39
4.5 MAXIMUM PEAK CONDUCTED OUTPUT POWER:.....42
4.6 MAXIMUM POWER SPECTRAL DENSITY:43
4.7 100 KHZ BANDWIDTH OF FREQUENCY BAND EDGE:46
4.8 DUTY CYCLE:.....49
5. RF EXPOSURE EVALUATION 51
5.1 MAXIMUM PERMISSIBLE EXPOSURE (MPE)51
5.1.1 APPLICABLE STANDARD.....51
5.1.2 PROCEDURE.....51
5.1.3 CALCULATED RESULT51
5.2 EXEMPTION LIMITS FOR ROUTINE EVALUATION – RF EXPOSURE EVALUATION 52
5.2.1 APPLICABLE STANDARD.....52
5.2.2 CALCULATED RESULT52

1. GENERAL INFORMATION

1.1 Product Description for Equipment under Test (EUT)

EUT Name:	PORTABLE WIRELESS SPEAKER
EUT Model:	BTSPK84
Operation Frequency:	2402-2480MHz
Maximum Peak Output Power (Conducted):	-1.98dBm
Modulation Type:	GFSK
Rated Input Voltage:	DC 3.7V from Battery or DC 5V from USB port
Serial Number:	CR21090047-RF-S1
EUT Received Date:	2021.9.29
EUT Received Status:	Good

Operation Frequency Detail:

Channel	Frequency (MHz)	Channel	Frequency (MHz)
0	2402	20	2442
1	2404
...
...
..	...	38	2478
19	2440	39	2480

Per section 15.31(m)/RSS-Gen, the lowest frequency, middle frequency, and highest frequency were performed the test as below:

Test Channel	Frequency (MHz)
Lowest	2402
Middle	2440
Highest	2480

Antenna Information Detail▲:

Antenna Manufacturer	Antenna Type	input impedance (Ohm)	Antenna Gain /Frequency Range	§15.203 RSS-GEN Requirement
Edco Electronics Inc.	PCB	50	4 dBi/ 2.4~2.5GHz	Compliance

The Method of §15.203 Compliance:

- Antenna must be permanently attached to the unit.
- Antenna must use a unique type of connector to attach to the EUT.
- Unit must be professionally installed, and installer shall be responsible for verifying that the correct antenna is employed with the unit.

Accessory Information:

Accessory Description	Manufacturer	Model	Parameters
IR Remote	Edco Electronics Inc.	Unknown	10 keys
Microphone	Edco Electronics Inc.	Unknown	2m unshielding

1.2 Description of Test Configuration

1.2.1 EUT Operation Condition:

EUT Operation Mode:	The system was configured for testing in Engineering Mode, which was provided by the manufacturer.	
Equipment Modifications:	No	
EUT Exercise Software:	FCC_assist_1.0.2.2.exe	
The software "FCC_assist_1.0.2.2.exe "was provided by manufacturer. The maximum power was configured as below, that was provided by the manufacturer ▲ :		
Test Channel	Frequency (MHz)	Power Level Setting
Lowest	2402	Default
Middle	2440	Default
Highest	2480	Default

1.2.2 Support Equipment List and Details

Manufacturer	Description	Model	Serial Number
SanDisk	SD Card	UHS-I-128G	9292DVDSV0XZ
Kingston	USB Flash Disk	Z3	Z3-20182547
MASS POWER	AC/DC Adapter	MAPS01-0500100	PS2025

1.2.3 Support Cable List and Details

Cable Description	Shielding Type	Ferrite Core	Length (m)	From Port	To
Microphone Cable	Yes	No	3.5	EUT	Microphone
USB Cable	Yes	No	0.5	Adapter	EUT

1.2.4 Block Diagram of Test Setup

AC line conducted emissions:

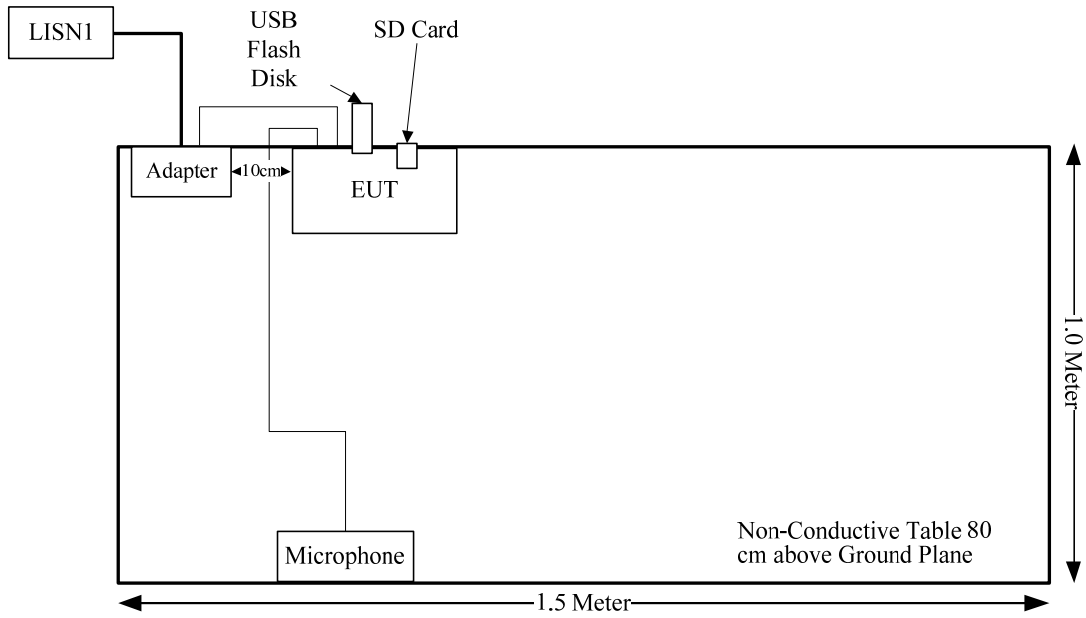

Spurious Emissions:
Below 1GHz:

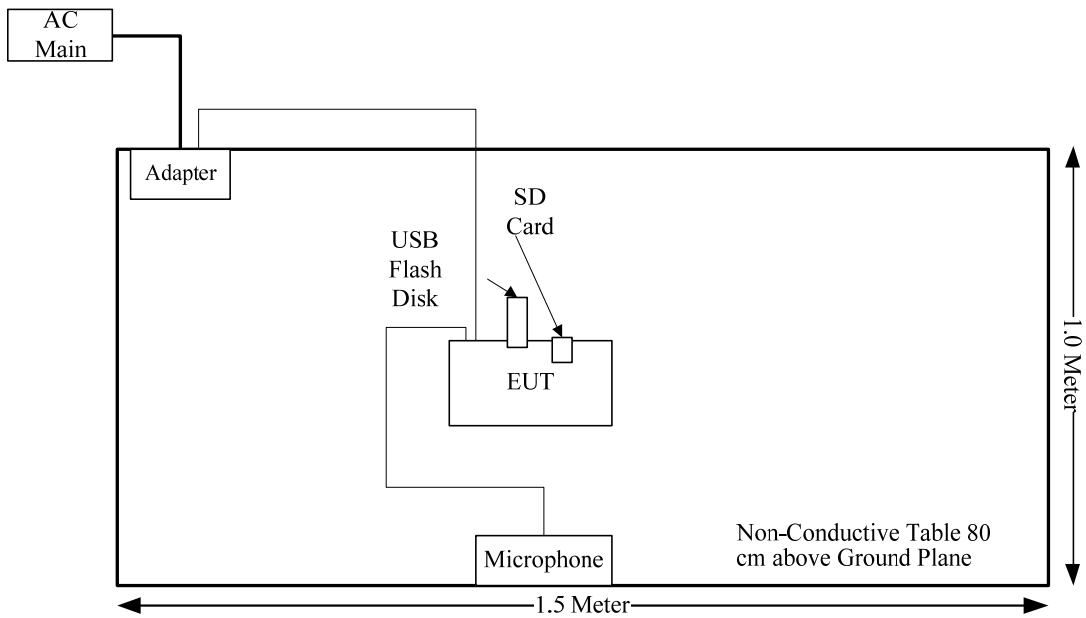

Above 1GHz:

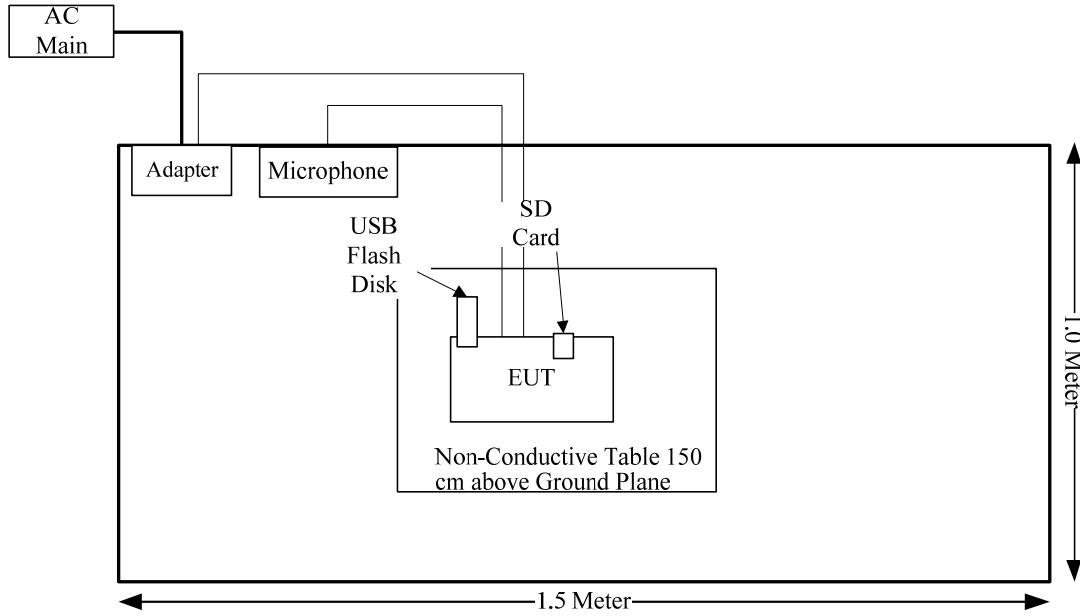

1.3 Measurement Uncertainty

Otherwise required by the applicant or Product Regulations, Decision Rule in this report did not consider the uncertainty. The extended uncertainty given in this report is obtained by combining the standard uncertainty times the coverage factor K with the 95% confidence interval.

Parameter	Measurement Uncertainty
Occupied Channel Bandwidth	±5 %
RF output power, conducted	±0.61dB
Power Spectral Density, conducted	±0.61 dB
Unwanted Emissions, radiated	30M~200MHz: 4.15 dB,200M~1GHz: 5.61 dB,1G~6GHz: 5.14 dB, 6G~18GHz: 5.93 dB,18G~26.5G:5.47 dB,26.5G~40G:5.63 dB
Unwanted Emissions, conducted	±1.26 dB
Temperature	±1 °C
Humidity	±5%
DC and low frequency voltages	±0.4%
Duty Cycle	1%
AC Power Lines Conducted Emission	2.8 dB (150 kHz to 30 MHz)

2. SUMMARY OF TEST RESULTS

Standard(s) Section	Test Items	Result
§15.207(a) RSS-Gen Clause 8.8	AC line conducted emissions	Compliance
§15.205, §15.209, §15.247(d) RSS-Gen Clause 8.10	Spurious Emissions	Compliance
§15.247 (a)(2) RSS-247 Clause 5.2 a)	6 dB Bandwidth	Compliance
RSS-Gen Clause 6.7	99% Occupied Bandwidth	Compliance
§15.247(b)(3) RSS-247 Clause 5.4 d)	Maximum Conducted Output Power	Compliance
§15.247(d) RSS-247 Clause 5.5	100 kHz Bandwidth of Frequency Band Edge	Compliance
§15.247(e) RSS-247 Clause 5.2 b)	Power Spectral Density	Compliance
§15.203 RSS-GEN Clause 6.8	Antenna Requirement	Compliance
§15.247 (i) & §1.1310 & §2.1091	Maximum Permissible Exposure (MPE)	Compliance
RSS-102 Clause 2.5.2	Exemption Limits For Routine Evaluation-RF Exposure Evaluation	Compliance

3. REQUIREMENTS AND TEST PROCEDURES

3.1 AC Line Conducted Emissions

3.1.1 Applicable Standard

FCC§15.207(a).

(a) Except as shown in paragraphs (b) and (c) of this section, for an intentional radiator that is designed to be connected to the public utility (AC) power line, the radio frequency voltage that is conducted back onto the AC power line on any frequency or frequencies, within the band 150 kHz to 30 MHz, shall not exceed the limits in the following table, as measured using a 50 μ H/50 ohms line impedance stabilization network (LISN). Compliance with the provisions of this paragraph shall be based on the measurement of the radio frequency voltage between each power line and ground at the power terminal. The lower limit applies at the boundary between the frequency ranges.

Frequency of emission (MHz)	Conducted limit (dB μ V)	
	Quasi-peak	Average
0.15-0.5	66 to 56*	56 to 46*
0.5-5	56	46
5-30	60	50

*Decreases with the logarithm of the frequency.

(b) The limit shown in paragraph (a) of this section shall not apply to carrier current systems operating as intentional radiators on frequencies below 30 MHz. In lieu thereof, these carrier current systems shall be subject to the following standards:

(1) For carrier current system containing their fundamental emission within the frequency band 535-1705 kHz and intended to be received using a standard AM broadcast receiver: no limit on conducted emissions.

(2) For all other carrier current systems: 1000 μ V within the frequency band 535-1705 kHz, as measured using a 50 μ H/50 ohms LISN.

(3) Carrier current systems operating below 30 MHz are also subject to the radiated emission limits in §15.205, §15.209, §15.221, §15.223, or §15.227, as appropriate.

(c) Measurements to demonstrate compliance with the conducted limits are not required for devices which only employ battery power for operation and which do not operate from the AC power lines or contain provisions for operation while connected to the AC power lines. Devices that include, or make provisions for, the use of battery chargers which permit operating while charging, AC adapters or battery eliminators or that connect to the AC power lines indirectly, obtaining their power through another device which is connected to the AC power lines, shall be tested to demonstrate compliance with the conducted limits.

RSS-Gen Clause 8.8

Unless stated otherwise in the applicable RSS, for radio apparatus that are designed to be connected to the public utility AC power network, the radio frequency voltage that is conducted back onto the AC power line on any frequency or frequencies within the range 150 kHz to 30 MHz shall not exceed the limits in table 4, as measured using a 50 μ H / 50 Ω line impedance stabilization network. This requirement applies for the radio frequency voltage measured between each power line and the ground terminal of each AC power-line mains cable of the EUT.

For an EUT that connects to the AC power lines indirectly, through another device, the requirement for compliance with the limits in table 4 shall apply at the terminals of the AC power-line mains cable of a representative support device, while it provides power to the EUT. The lower limit applies at the boundary between the frequency ranges. The device used to power the EUT shall be representative of typical applications.

Table 4 – AC power-line conducted emissions limits

Frequency (MHz)	Conducted limit (dB μ V)	
	Quasi-peak	Average
0.15 - 0.5	66 to 56 ¹	56 to 46 ¹
0.5 – 5	56	46
5 – 30	60	50

Note 1: The level decreases linearly with the logarithm of the frequency.

For an EUT with a permanent or detachable antenna operating between 150 kHz and 30 MHz, the AC power-line conducted emissions must be measured using the following configurations:

(a) Perform the AC power-line conducted emissions test with the antenna connected to determine compliance with the limits of table 4 outside the transmitter's fundamental emission band.

(b) Retest with a dummy load instead of the antenna to determine compliance with the limits of table 4 within the transmitter's fundamental emission band. For a detachable antenna, remove the antenna and connect a suitable dummy load to the antenna connector. For a permanent antenna, remove the antenna and terminate the RF output with a dummy load or network that simulates the antenna in the fundamental frequency band.

3.1.2 EUT Setup



- Note: 1. Support units were connected to second LISN.
 2. Both of LISNs (AMN) 80 cm from EUT and at the least 80 cm from other units and other metal planes support units.

The setup of EUT is according with per ANSI C63.10-2013 measurement procedure. The specification used was with the FCC Part 15.207,RSS-Gen limits.

The spacing between the peripherals was 10 cm.

The adapter or EUT was connected to the main LISN with a 120 V/60 Hz AC power source.

3.1.3 EMI Test Receiver Setup

The EMI test receiver was set to investigate the spectrum from 150 kHz to 30 MHz.

During the conducted emission test, the EMI test receiver was set with the following configurations:

Frequency Range	IF B/W
150 kHz – 30 MHz	9 kHz

3.1.4 Test Procedure

The frequency and amplitude of the six highest ac power-line conducted emissions relative to the limit, measured over all the current-carrying conductors of the EUT power cords, and the operating frequency or frequency to which the EUT is tuned (if appropriate), should be reported, unless such emissions are more than 20 dB below the limit. AC power-line conducted emissions measurements are to be separately carried out only on each of the phase (“hot”) line(s) and (if used) on the neutral line(s), but not on the ground [protective earth] line(s). If less than six emission frequencies are within 20 dB of the limit, then the noise level of the measuring instrument at representative frequencies should be reported. The specific conductor of the power-line cord for each of the reported emissions should be identified. Measure the six highest emissions with respect to the limit on each current-carrying conductor of each power cord associated with the EUT (but not the power cords of associated or peripheral equipment that are part of the test configuration). Then, report the six highest emissions with respect to the limit from among all the measurements identifying the frequency and specific current-carrying conductor identified with the emission. The six highest emissions should be reported for each of the current-carrying conductors, or the six highest emissions may be reported over all the current-carrying conductors.

3.1.5 Corrected Amplitude & Margin Calculation

The basic equation is as follows:

Result = Reading + Factor

Factor = attenuation caused by cable loss + voltage division factor of AMN

The “**Margin**” column of the following data tables indicates the degree of compliance within the applicable limit. The equation for margin calculation is as follows:

Margin = Limit – Result

3.2 Radiation Spurious Emissions

3.2.1 Applicable Standard

FCC §15.247 (d);

In any 100 kHz bandwidth outside the frequency band in which the spread spectrum or digitally modulated intentional radiator is operating, the radio frequency power that is produced by the intentional radiator shall be at least 20 dB below that in the 100 kHz bandwidth within the band that contains the highest level of the desired power, based on either an RF conducted or a radiated measurement, provided the transmitter demonstrates compliance with the peak conducted power limits. If the transmitter complies with the conducted power limits based on the use of RMS averaging over a time interval, as permitted under paragraph (b)(3) of this section, the attenuation required under this paragraph shall be 30 dB instead of 20 dB. Attenuation below the general limits specified in §15.209(a) is not required. In addition, radiated emissions which fall in the restricted bands, as defined in §15.205(a), must also comply with the radiated emission limits specified in §15.209(a) (see §15.205(c)).

RSS-247 Clause 5.5

In any 100 kHz bandwidth outside the frequency band in which the spread spectrum or digitally modulated device is operating, the RF power that is produced shall be at least 20 dB below that in the 100 kHz bandwidth within the band that contains the highest level of the desired power, based on either an RF conducted or a radiated measurement, provided that the transmitter demonstrates compliance with the peak conducted power limits. If the transmitter complies with the conducted power limits based on the use of root-mean-square averaging over a time interval, as permitted under section 5.4(d), the attenuation required shall be 30 dB instead of 20 dB. Attenuation below the general field strength limits specified in RSS-Gen is not required

3.2.2 EUT Setup

Below 1GHz:

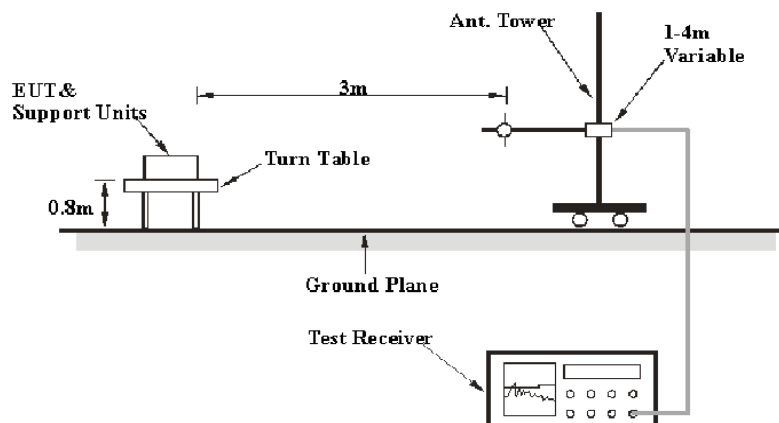

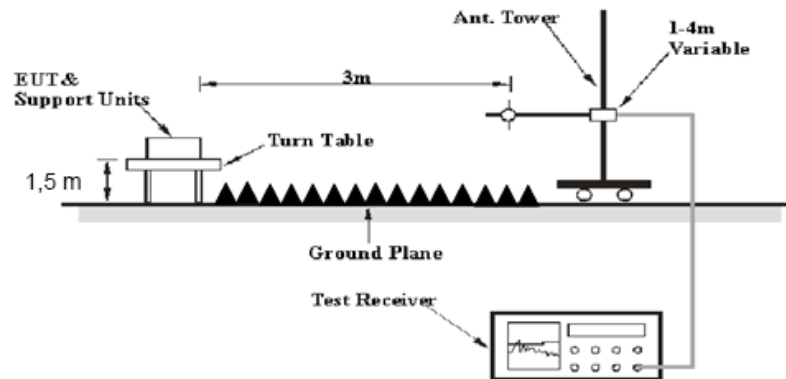
Above 1GHz:

The radiated emissions were performed in the 3 meters distance, using the setup accordance with the ANSI C63.10-2013. The specification used was the FCC 15.209, and FCC 15.247, RSS-247, RSS-Gen limits.

The external I/O cables were draped along the test table and formed a bundle 30 to 40 cm long in the middle.

The spacing between the peripherals was 10 cm.

3.2.3 EMI Test Receiver & Spectrum Analyzer Setup

The system was investigated from 30 MHz to 25 GHz.

During the radiated emission test, the EMI test receiver & Spectrum Analyzer Setup were set with the following configurations:

30MHz-1000MHz:

Measurement	RBW	Video B/W	IF B/W
QP	120 kHz	300 kHz	120kHz

1GHz- 25GHz:

Measurement	Duty cycle	RBW	Video B/W
PK	Any	1MHz	3 MHz
AV	>98%	1MHz	10 Hz
	<98%	1MHz	1/T

Note: T is minimum transmission duration

If the maximized peak measured value complies with under the QP/Average limit more than 6dB, then it is unnecessary to perform an QP/Average measurement.

3.2.4 Test Procedure

Maximizing procedure was performed on the highest emissions to ensure that the EUT complied with all installation combinations.

Data was recorded in Quasi-peak detection mode for frequency range of 30 MHz-1 GHz, peak and Average detection modes for frequencies above 1 GHz.

3.2.5 Corrected Amplitude & Margin Calculation

The basic equation is as follows:

Result = Reading + Factor

Factor = Antenna Factor + Cable Loss- Amplifier Gain

The “**Margin**” column of the following data tables indicates the degree of compliance within the applicable limit. The equation for margin calculation is as follows:

Margin = Limit – Result

3.3 6 dB Emission Bandwidth:

3.3.1 Applicable Standard

FCC §15.247 (a)(2)

Systems using digital modulation techniques may operate in the 902-928 MHz, 2400-2483.5 MHz, and 5725-5850 MHz bands. The minimum 6 dB bandwidth shall be at least 500 kHz.

RSS-247 Clause 5.2 a

The minimum 6 dB bandwidth shall be 500 kHz.

3.3.2 EUT Setup

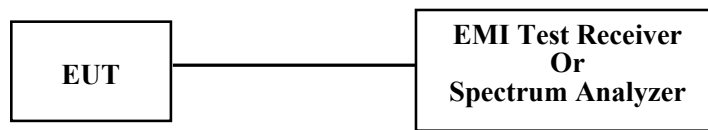

3.3.3 Test Procedure

According to ANSI C63.10-2013 Section 11.8

- a) Set RBW = 100 kHz.
- b) Set the video bandwidth (VBW) $\geq 3 \times$ RBW.
- c) Detector = Peak.
- d) Trace mode = max hold.
- e) Sweep = auto couple.
- f) Allow the trace to stabilize.
- g) Measure the maximum width of the emission that is constrained by the frequencies associated with the two outermost amplitude points (upper and lower frequencies) that are attenuated by 6 dB relative to the maximum level measured in the fundamental emission.

3.4 99% Occupied Bandwidth:

3.4.1 Applicable Standard

RSS-Gen Clause 5.2 a

The occupied bandwidth or the “99% emission bandwidth” is defined as the frequency range between two points, one above and the other below the carrier frequency, within which 99% of the total transmitted power of the fundamental transmitted emission is contained. The occupied bandwidth shall be reported for all equipment in addition to the specified bandwidth required in the applicable RSSs.

In some cases, the “x dB bandwidth” is required, which is defined as the frequency range between two points, one at the lowest frequency below and one at the highest frequency above the carrier frequency, at which the maximum power level of the transmitted emission is attenuated x dB below the maximum in-band power level of the modulated signal, where the two points are on the outskirts of the in-band emission.

3.4.2 EUT Setup

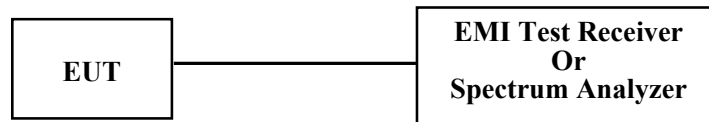

3.4.3 Test Procedure

RSS-Gen Clause 5.2 a

The following conditions shall be observed for measuring the occupied bandwidth and x dB bandwidth:

- The transmitter shall be operated at its maximum carrier power measured under normal test conditions.
- The span of the spectrum analyzer shall be set large enough to capture all products of the modulation process, including the emission skirts, around the carrier frequency, but small enough to avoid having other emissions (e.g. on adjacent channels) within the span.
- The detector of the spectrum analyzer shall be set to “Sample”. However, a peak, or peak hold, may be used in place of the sampling detector since this usually produces a wider bandwidth than the actual bandwidth (worst-case measurement). Use of a peak hold (or “Max Hold”) may be necessary to determine the occupied / x dB bandwidth if the device is not transmitting continuously.
- The resolution bandwidth (RBW) shall be in the range of 1% to 5% of the actual occupied / x dB bandwidth and the video bandwidth (VBW) shall not be smaller than three times the RBW value. Video averaging is not permitted.

Note: It may be necessary to repeat the measurement a few times until the RBW and VBW are in compliance with the above requirement.

For the 99% emission bandwidth, the trace data points are recovered and directly summed in linear power level terms. The recovered amplitude data points, beginning at the lowest frequency, are placed in a running sum until 0.5% of the total is reached, and that frequency recorded. The process is repeated for the highest frequency data points (starting at the highest frequency, at the right side of the span, and going down in frequency). This frequency is then recorded. The difference between the two recorded frequencies is the occupied bandwidth (or the 99% emission bandwidth).

3.5 Maximum peak conducted output power:

3.5.1 Applicable Standard

FCC §15.247 (b)(3)

For systems using digital modulation in the 902-928 MHz, 2400-2483.5 MHz, and 5725-5850 MHz bands: 1 Watt. As an alternative to a peak power measurement, compliance with the one Watt limit can be based on a measurement of the maximum conducted output power. Maximum Conducted Output Power is defined as the total transmit power delivered to all antennas and antenna elements averaged across all symbols in the signaling alphabet when the transmitter is operating at its maximum power control level. Power must be summed across all antennas and antenna elements. The average must not include any time intervals during which the transmitter is off or is transmitting at a reduced power level. If multiple modes of operation are possible (e.g., alternative modulation methods), the maximum conducted output power is the highest total transmit power occurring in any mode.

RSS-247 Clause 5.4 d

For DTSs employing digital modulation techniques operating in the bands 902-928 MHz and 2400-2483.5 MHz, the maximum peak conducted output power shall not exceed 1W. The e.i.r.p. shall not exceed 4 W, except as provided in section 5.4(e).

3.5.2 EUT Setup

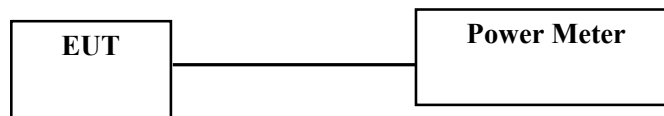

3.5.3 Test Procedure

According to ANSI C63.10-2013 Section 11.9.1.3

The maximum peak conducted output power may be measured using a broadband peak RF power meter. The power meter shall have a video bandwidth that is greater than or equal to the DTS bandwidth and shall use a fast-responding diode detector.

- a) Set the EUT in transmitting mode.
- b) Remove the antenna from the EUT and then connect a low loss RF cable from the antenna port to test equipment.
- c) Add a correction factor to the display.
- d) Set the power meter to test peak output power, record the result.

3.6 Maximum power spectral density:

3.6.1 Applicable Standard

FCC §15.247 (e)

For digitally modulated systems, the power spectral density conducted from the intentional radiator to the antenna shall not be greater than 8 dBm in any 3 kHz band during any time interval of continuous transmission. This power spectral density shall be determined in accordance with the provisions of paragraph (b) of this section. The same method of determining the conducted output power shall be used to determine the power spectral density.

RSS-247 Clause5.2 b

The transmitter power spectral density conducted from the transmitter to the antenna shall not be greater than 8 dBm in any 3 kHz band during any time interval of continuous transmission. This power spectral density shall be determined in accordance with the provisions of section 5.4(d), (i.e. the power spectral density shall be determined using the same method as is used to determine the conducted output power).

3.6.2 EUT Setup

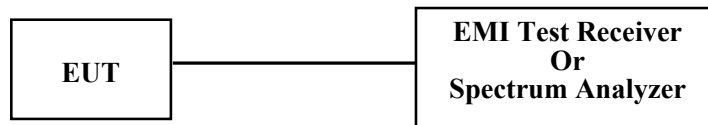

3.6.3 Test Procedure

According to ANSI C63.10-2013 Section 11.10.2

- a) Set analyzer center frequency to DTS channel center frequency.
- b) Set the span to 1.5 times the DTS bandwidth.
- c) Set the RBW to $3 \text{ kHz} \leq \text{RBW} \leq 100 \text{ kHz}$.
- d) Set the VBW $\geq [3 \cdot \text{RBW}]$.
- e) Detector = peak.
- f) Sweep time = auto couple.
- g) Trace mode = max hold.
- h) Allow trace to fully stabilize.
- i) Use the peak marker function to determine the maximum amplitude level within the RBW.
- j) If measured value exceeds requirement, then reduce RBW (but no less than 3 kHz) and repeat.

3.7 100 kHz Bandwidth of Frequency Band Edge:

3.7.1 Applicable Standard

FCC §15.247 (d);

In any 100 kHz bandwidth outside the frequency band in which the spread spectrum or digitally modulated intentional radiator is operating, the radio frequency power that is produced by the intentional radiator shall be at least 20 dB below that in the 100 kHz bandwidth within the band that contains the highest level of the desired power, based on either an RF conducted or a radiated measurement, provided the transmitter demonstrates compliance with the peak conducted power limits. If the transmitter complies with the conducted power limits based on the use of RMS averaging over a time interval, as permitted under paragraph (b)(3) of this section, the attenuation required under this paragraph shall be 30 dB instead of 20 dB. Attenuation below the general limits specified in §15.209(a) is not required. In addition, radiated emissions which fall in the restricted bands, as defined in §15.205(a), must also comply with the radiated emission limits specified in §15.209(a) (see §15.205(c)).

RSS-247 Clause 5.5

In any 100 kHz bandwidth outside the frequency band in which the spread spectrum or digitally modulated device is operating, the RF power that is produced shall be at least 20 dB below that in the 100 kHz bandwidth within the band that contains the highest level of the desired power, based on either an RF conducted or a radiated measurement, provided that the transmitter demonstrates compliance with the peak conducted power limits. If the transmitter complies with the conducted power limits based on the use of root-mean-square averaging over a time interval, as permitted under section 5.4(d), the attenuation required shall be 30 dB instead of 20 dB. Attenuation below the general field strength limits specified in RSS-Gen is not required

3.7.2 EUT Setup



3.7.3 Test Procedure

According to ANSI C63.10-2013 Section 11.11

- a) Set the center frequency and span to encompass frequency range to be measured.
- b) Set the RBW = 100 kHz.
- c) Set the VBW $\geq [3 \times \text{RBW}]$.
- d) Detector = peak.
- e) Sweep time = auto couple.
- f) Trace mode = max hold.
- g) Allow trace to fully stabilize.
- h) Use the peak marker function to determine the maximum amplitude level.

Ensure that the amplitude of all unwanted emissions outside of the authorized frequency band (excluding restricted frequency bands) is attenuated by at least the minimum requirements specified in 11.11. Report the three highest emissions relative to the limit.

3.8 Duty Cycle:

3.8.1 EUT Setup

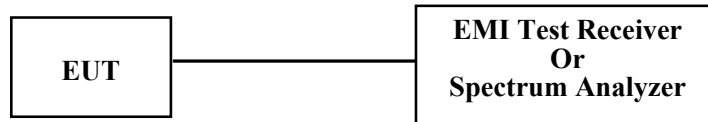

3.8.2 Test Procedure

According to ANSI C63.10-2013 Section 11.6

The zero-span mode on a spectrum analyzer or EMI receiver if the response time and spacing between bins on the sweep are sufficient to permit accurate measurements of the ON and OFF times of the transmitted signal:

- 1) Set the center frequency of the instrument to the center frequency of the transmission.
- 2) Set $RBW \geq OBW$ if possible; otherwise, set RBW to the largest available value.
- 3) Set $VBW \geq RBW$. Set detector = peak or average.
- 4) The zero-span measurement method shall not be used unless both RBW and VBW are $> 50/T$ and the number of sweep points across duration T exceeds 100. (For example, if VBW and/or RBW are limited to 3 MHz, then the zero-span method of measuring the duty cycle shall not be used if $T \leq 16.7 \mu s$.)

3.9 Antenna Requirement

3.9.1 Applicable Standard

FCC §15.203

An intentional radiator shall be designed to ensure that no antenna other than that furnished by the responsible party shall be used with the device. The use of a permanently attached antenna or of an antenna that uses a unique coupling to the intentional radiator shall be considered sufficient to comply with the provisions of this section. The manufacturer may design the unit so that a broken antenna can be replaced by the user, but the use of a standard antenna jack or electrical connector is prohibited. This requirement does not apply to carrier current devices or to devices operated under the provisions of §§15.211, 15.213, 15.217, 15.219, 15.221, or §15.236. Further, this requirement does not apply to intentional radiators that must be professionally installed, such as perimeter protection systems and some field disturbance sensors, or to other intentional radiators which, in accordance with §15.31(d), must be measured at the installation site. However, the installer shall be responsible for ensuring that the proper antenna is employed so that the limits in this part are not exceeded.

RSS-GEN Clause 6.8

The applicant for equipment certification shall provide a list of all antenna types that may be used with the transmitter, where applicable (i.e. for transmitters with detachable antenna), indicating the maximum permissible antenna gain (in dBi) and the required impedance for each antenna. The test report shall demonstrate the compliance of the transmitter with the limit for maximum equivalent isotropically radiated power (e.i.r.p.) specified in the applicable RSS, when the transmitter is equipped with any antenna type, selected from this list.

For expediting the testing, measurements may be performed using only the antenna with highest gain of each combination of transmitter and antenna type, with the transmitter output power set at the maximum level. However, the transmitter shall comply with the applicable requirements under all operational conditions and when in combination with any type of antenna from the list provided in the test report (and in the notice to be included in the user manual, provided below).

When measurements at the antenna port are used to determine the RF output power, the effective gain of the device's antenna shall be stated, based on a measurement or on data from the antenna's manufacturer.

The test report shall state the RF power, output power setting and spurious emission measurements with each antenna type that is used with the transmitter being tested.

For licence-exempt equipment with detachable antennas, the user manual shall also contain the following notice in a conspicuous location:

This radio transmitter [enter the device's ISED certification number] has been approved by Innovation, Science and Economic Development Canada to operate with the antenna types listed below, with the maximum permissible gain indicated. Antenna types not included in this list that have a gain greater than the maximum gain indicated for any type listed are strictly prohibited for use with this device.

Immediately following the above notice, the manufacturer shall provide a list of all antenna types which can be used with the transmitter, indicating the maximum permissible antenna gain (in dBi) and the required impedance for each antenna type.

3.9.2 Judgment

Please refer to the Antenna Information detail in Section 1.

4. Test DATA AND RESULTS

4.1 AC Line Conducted Emissions

Serial Number:	CR21090047-RF-S1	Test Date:	2021-11-20
Test Site:	CE	Test Mode:	Transmitting
Tester:	Nick Tang	Test Result:	Pass

Environmental Conditions:

Temperature: (°C)	23.5	Relative Humidity: (%)	70	ATM Pressure: (kPa)	100.7
----------------------	------	------------------------------	----	------------------------	-------

Test Equipment List and Details:

Manufacturer	Description	Model	Serial Number	Calibration Date	Calibration Due Date
R&S	LISN	ENV216	101132	2021-04-25	2022-04-24
R&S	EMI Test Receiver	ESR3	102726	2021-07-22	2022-07-21
MICRO-COAX	Coaxial Cable	UTIFLEX	C-0200-01	2021-08-08	2022-08-07
Audix	Test Software	E3	190306 (V9)	N/A	N/A

* Statement of Traceability: China Certification ICT Co., Ltd (Dongguan) attests that all calibrations have been performed, traceable to National Primary Standards and International System of Units (SI).

Line

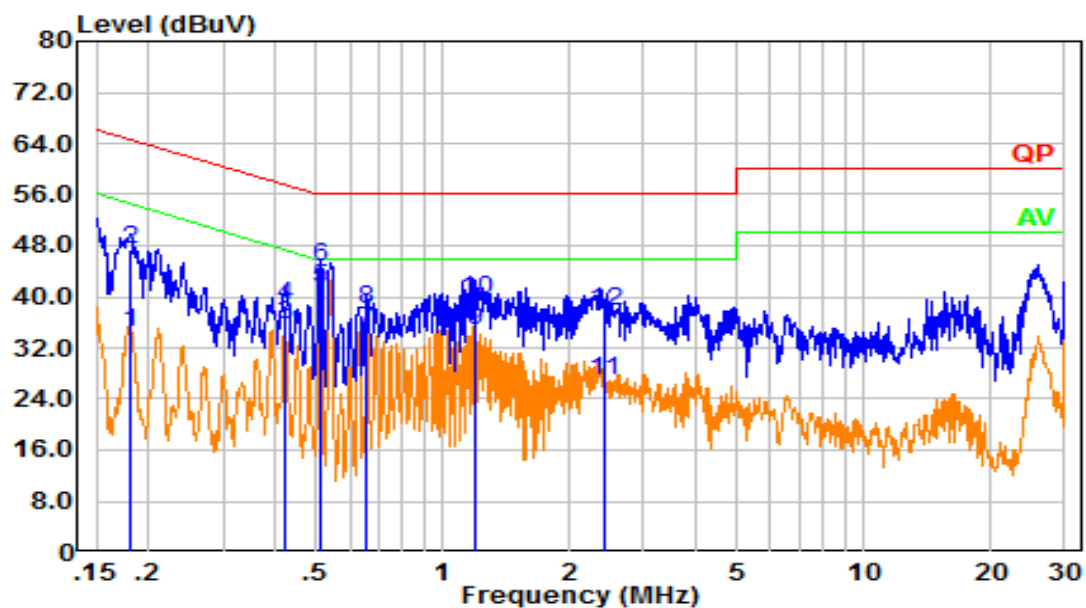

No.	Frequency (MHz)	Reading (dB μ V)	Factor (dB)	Result (dB μ V)	Limit (dB μ V)	Margin (dB)	Detector
1	0.180	24.92	9.61	34.53	54.47	19.94	Average
2	0.180	37.69	9.61	47.30	64.47	17.17	QP
3	0.421	25.92	9.61	35.53	47.43	11.90	Average
4	0.421	29.08	9.61	38.69	57.43	18.75	QP
5	0.512	31.76	9.61	41.37	46.00	4.63	Average
6	0.512	34.92	9.61	44.53	56.00	11.47	QP
7	0.657	25.20	9.62	34.82	46.00	11.18	Average
8	0.657	28.50	9.62	38.12	56.00	17.88	QP
9	1.195	25.02	9.62	34.65	46.00	11.35	Average
10	1.195	30.07	9.62	39.69	56.00	16.31	QP
11	2.409	17.24	9.64	26.88	46.00	19.12	Average
12	2.409	28.07	9.64	37.71	56.00	18.29	QP

Neutral

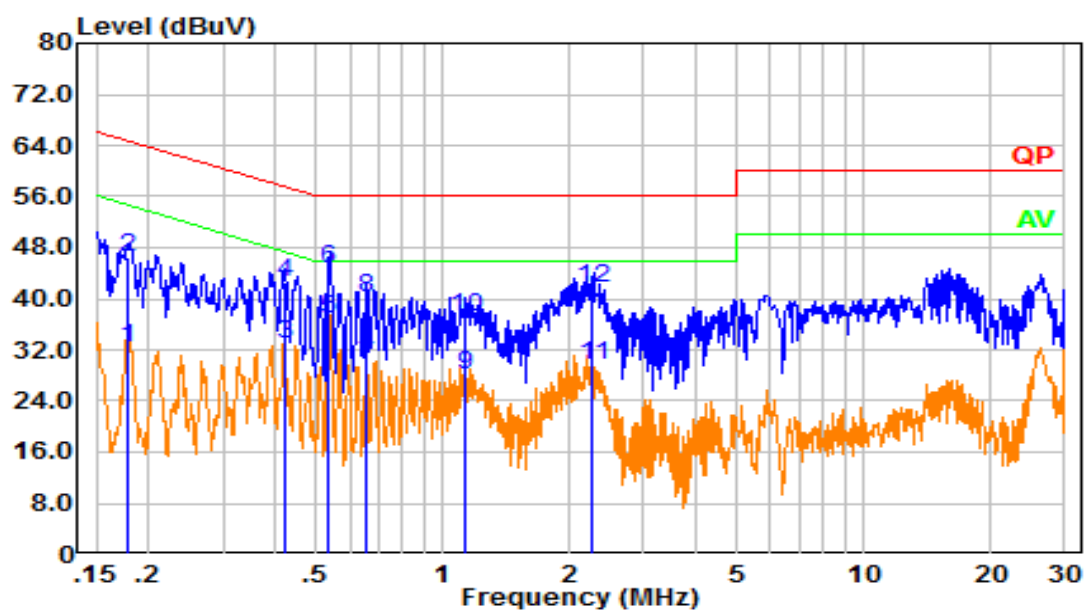

No.	Frequency (MHz)	Reading (dB μ V)	Factor (dB)	Result (dB μ V)	Limit (dB μ V)	Margin (dB)	Detector
1	0.179	22.65	9.61	32.26	54.53	22.28	Average
2	0.179	36.88	9.61	46.49	64.53	18.04	QP
3	0.420	23.26	9.61	32.87	47.45	14.58	Average
4	0.420	32.97	9.61	42.58	57.45	14.87	QP
5	0.537	27.29	9.61	36.91	46.00	9.09	Average
6	0.537	34.98	9.61	44.59	56.00	11.41	QP
7	0.660	19.85	9.62	29.47	46.00	16.53	Average
8	0.660	30.53	9.62	40.15	56.00	15.85	QP
9	1.132	18.47	9.62	28.09	46.00	17.91	Average
10	1.132	27.65	9.62	37.28	56.00	18.73	QP
11	2.263	19.91	9.64	29.55	46.00	16.45	Average
12	2.263	32.16	9.64	41.79	56.00	14.21	QP

4.2 Radiation Spurious Emissions

Serial Number:	CR21090047-RF-S1	Test Date:	2021-10-18~2021-11-17
Test Site:	966-1/966-2	Test Mode:	Transmitting
Tester:	Tommy Luo, Great Qiao	Test Result:	Pass

Environmental Conditions:

Temperature: (°C)	23.5~25.5	Relative Humidity: (%)	56~64	ATM Pressure: (kPa)	101.5~101.6
----------------------	-----------	------------------------------	-------	------------------------	-------------

Test Equipment List and Details:

Manufacturer	Description	Model	Serial Number	Calibration Date	Calibration Due Date
Sunol Sciences	Antenna	JB6	A082520-5	2020-10-19	2023-10-18
R&S	EMI Test Receiver	ESR3	102724	2021-07-22	2022-07-21
TIMES MICROWAVE	Coaxial Cable	LMR-600-UltraFlex	C-0470-02	2021-07-18	2022-07-17
TIMES MICROWAVE	Coaxial Cable	LMR-600-UltraFlex	C-0780-01	2021-07-18	2022-07-17
Sonoma	Amplifier	310N	186165	2021-07-18	2022-07-17
Audix	Test Software	E3	201021 (V9)	N/A	N/A
ETS-Lindgren	Horn Antenna	3115	9912-5985	2020-10-13	2023-10-12
PASTERNAK	Horn Antenna	PE9852/2F-20	112002	2021-02-05	2023-02-04
R&S	Spectrum Analyzer	FSV40	101591	2021-07-22	2022-07-21
MICRO-COAX	Coaxial Cable	UFA210A-1-1200-70U300	217423-008	2021-08-08	2022-08-07
MICRO-COAX	Coaxial Cable	UFA210A-1-2362-300300	235780-001	2021-08-08	2022-08-07
MICRO-COAX	Coaxial Cable	UFB142A-1-2362-200200	235772-001	2021-08-08	2022-08-07
Mini	Pre-amplifier	ZVA-183-S+	5969001149	2021-11-10	2022-11-09
AH	Preamplifier	PAM-1840VH	190	2020-11-20	2021-11-19
E-Microwave	Band Rejection Filter	2400-2483.5MHz	OE01902424	2021-08-08	2022-08-07
Mini Circuits	High Pass Filter	VHF-6010+	31119	2021-08-08	2022-08-07

* Statement of Traceability: China Certification ICT Co., Ltd (Dongguan) attests that all calibrations have been performed, traceable to National Primary Standards and International System of Units (SI).

1) 30MHz-1GHz(LE 1Mbps Low channel was the worst)

Horizontal:

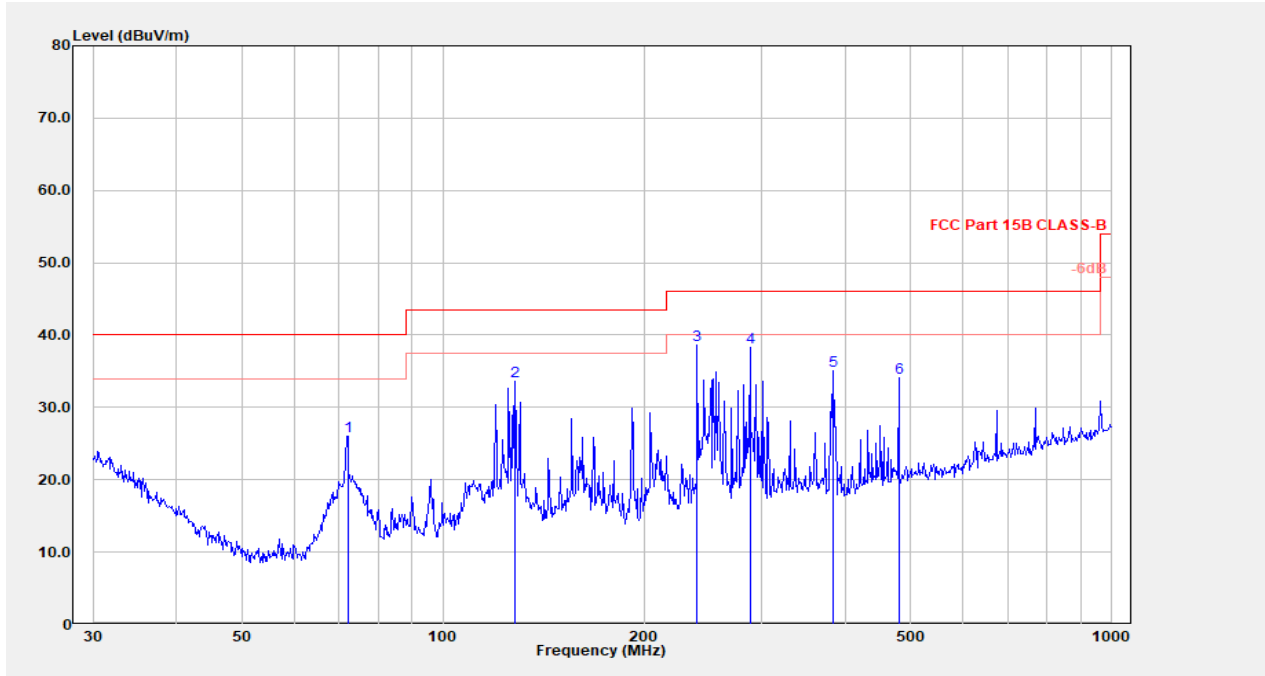

No.	Frequency (MHz)	Reading (dBμV)	Factor (dB/m)	Result (dBμV/m)	Limit (dBμV/m)	Margin (dB)	Detector
1	72.084	43.02	-16.93	26.09	40.00	13.91	Peak
2	128.113	45.15	-11.52	33.63	43.50	9.87	Peak
3	239.987	51.81	-13.17	38.64	46.00	7.36	Peak
4	287.990	49.69	-11.34	38.34	46.00	7.66	Peak
5	383.932	44.27	-9.26	35.01	46.00	10.99	Peak
6	480.528	40.63	-6.49	34.14	46.00	11.86	Peak

Vertical:

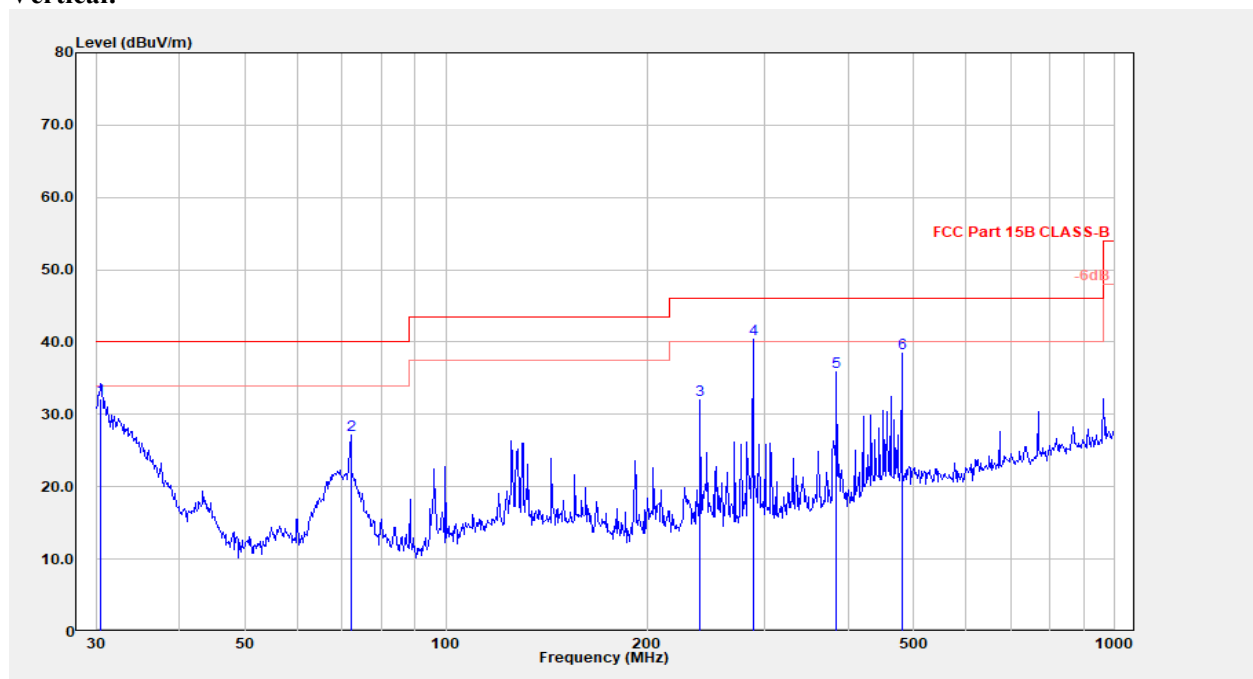

No.	Frequency (MHz)	Reading (dBμV)	Factor (dB/m)	Result (dBμV/m)	Limit (dBμV/m)	Margin (dB)	Detector
1	30.531	36.41	-4.20	32.21	40.00	7.79	QP
2	72.084	44.12	-16.93	27.19	40.00	12.81	Peak
3	239.987	45.23	-13.17	32.06	46.00	13.94	Peak
4	287.990	51.79	-11.34	40.45	46.00	5.55	QP
5	383.932	45.09	-9.26	35.83	46.00	10.17	Peak
6	480.528	44.96	-6.49	38.47	46.00	7.53	Peak

**2) 1-25GHz:
LE 1 Mbps**

Frequency (MHz)	Receiver		Polar (H/V)	Factor (dB/m)	Result (dB μ V/m)	Limit (dB μ V/m)	Margin (dB)
	Reading (dB μ V)	Detector					
Low Channel: 2402 MHz							
2402.00	55.84	PK	H	31.51	87.35	N/A	N/A
2402.00	55.63	AV	H	31.51	87.14	N/A	N/A
2402.00	48.90	PK	V	31.51	80.41	N/A	N/A
2402.00	48.63	AV	V	31.51	80.14	N/A	N/A
2390.00	27.49	PK	H	31.46	58.95	74.00	15.05
2390.00	13.87	AV	H	31.46	45.33	54.00	8.67
4804.00	35.67	PK	H	10.91	46.58	74.00	27.42
4804.00	23.54	AV	H	10.91	34.45	54.00	19.55
7206.00	34.52	PK	H	14.22	48.74	74.00	25.26
7206.00	22.47	AV	H	14.22	36.69	54.00	17.31
Middle Channel: 2440 MHz							
2440.00	54.99	PK	H	31.60	86.59	N/A	N/A
2440.00	54.72	AV	H	31.60	86.32	N/A	N/A
2440.00	48.61	PK	V	31.60	80.21	N/A	N/A
2440.00	48.13	AV	V	31.60	79.73	N/A	N/A
4880.00	34.36	PK	H	11.07	45.43	74.00	28.57
4880.00	22.20	AV	H	11.07	33.27	54.00	20.73
7320.00	34.54	PK	H	14.80	49.34	74.00	24.66
7320.00	22.63	AV	H	14.80	37.43	54.00	16.57
High Channel: 2480 MHz							
2480.00	54.62	PK	H	31.64	86.26	N/A	N/A
2480.00	54.30	AV	H	31.64	85.94	N/A	N/A
2480.00	46.80	PK	V	31.64	78.44	N/A	N/A
2480.00	46.43	AV	V	31.64	78.07	N/A	N/A
2483.50	28.92	PK	H	31.64	60.56	74.00	13.44
2483.50	14.27	AV	H	31.64	45.91	54.00	8.09
4960.00	35.73	PK	H	11.23	46.96	74.00	27.04
4960.00	23.67	AV	H	11.23	34.90	54.00	19.10
7440.00	34.62	PK	H	15.26	49.88	74.00	24.12
7440.00	22.40	AV	H	15.26	37.66	54.00	16.34

LE 2 Mbps

Frequency (MHz)	Receiver		Polar (H/V)	Factor (dB/m)	Result (dB μ V/m)	Limit (dB μ V/m)	Margin (dB)
	Reading (dB μ V)	Detector					
Low Channel: 2402 MHz							
2402.00	55.85	PK	H	31.51	87.36	N/A	N/A
2402.00	55.62	AV	H	31.51	87.13	N/A	N/A
2402.00	48.99	PK	V	31.51	80.50	N/A	N/A
2402.00	48.48	AV	V	31.51	79.99	N/A	N/A
2390.00	27.41	PK	H	31.46	58.87	74.00	15.13
2390.00	13.87	AV	H	31.46	45.33	54.00	8.67
4804.00	35.49	PK	H	10.91	46.40	74.00	27.60
4804.00	23.62	AV	H	10.91	34.53	54.00	19.47
7206.00	33.99	PK	H	14.22	48.21	74.00	25.79
7206.00	21.75	AV	H	14.22	35.97	54.00	18.03
Middle Channel: 2440 MHz							
2440.00	55.05	PK	H	31.60	86.65	N/A	N/A
2440.00	54.79	AV	H	31.60	86.39	N/A	N/A
2440.00	48.18	PK	V	31.60	79.78	N/A	N/A
2440.00	47.85	AV	V	31.60	79.45	N/A	N/A
4880.00	35.11	PK	H	11.07	46.18	74.00	27.82
4880.00	23.24	AV	H	11.07	34.31	54.00	19.69
7320.00	34.74	PK	H	14.80	49.54	74.00	24.46
7320.00	22.35	AV	H	14.80	37.15	54.00	16.85
High Channel: 2480 MHz							
2480.00	54.33	PK	H	31.64	85.97	N/A	N/A
2480.00	54.02	AV	H	31.64	85.66	N/A	N/A
2480.00	46.87	PK	V	31.64	78.51	N/A	N/A
2480.00	46.41	AV	V	31.64	78.05	N/A	N/A
2483.50	29.43	PK	H	31.64	61.07	74.00	12.93
2483.50	14.25	AV	H	31.64	45.89	54.00	8.11
4960.00	36.48	PK	H	11.23	47.71	74.00	26.29
4960.00	24.30	AV	H	11.23	35.53	54.00	18.47
7440.00	34.65	PK	H	15.26	49.91	74.00	24.09
7440.00	22.57	AV	H	15.26	37.83	54.00	16.17

Worst Test plots(LE 2Mbps High channel was the worst)
Horizontal:

Fundamental
Test with Band
Rejection Filter

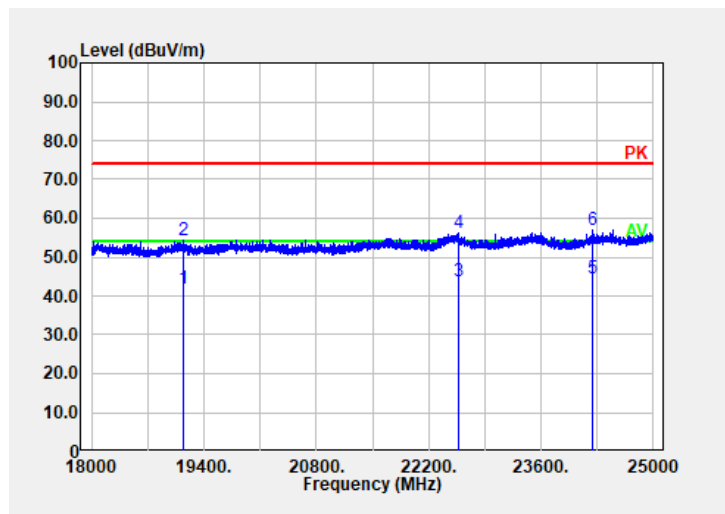
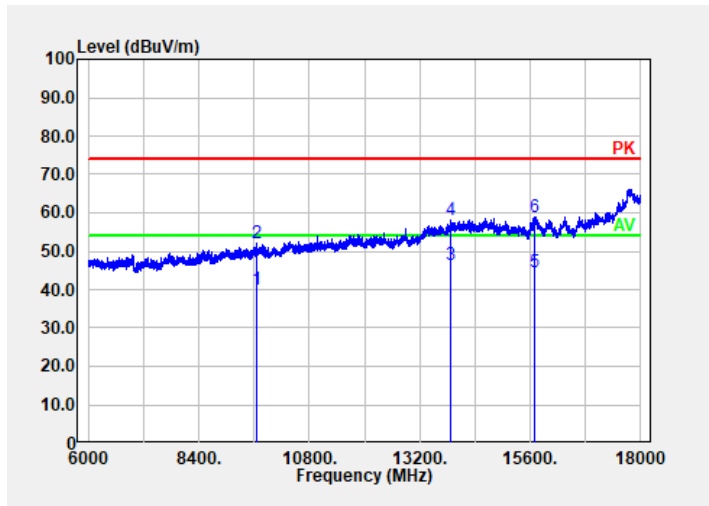
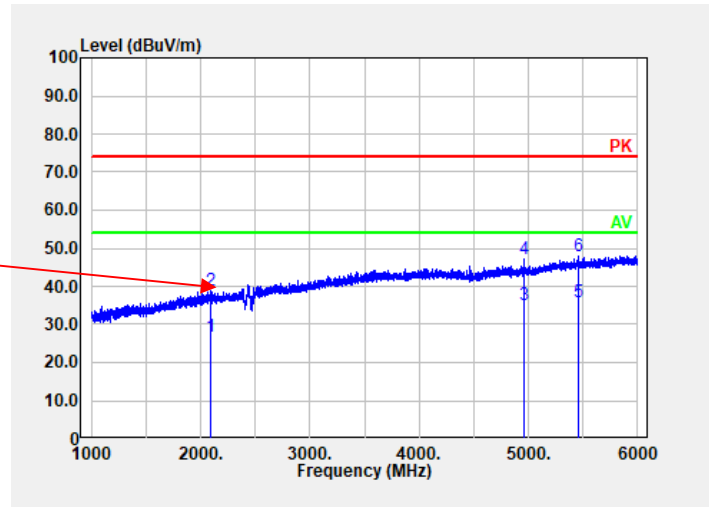

Vertical:

Fundamental Test with Band Rejection Filter

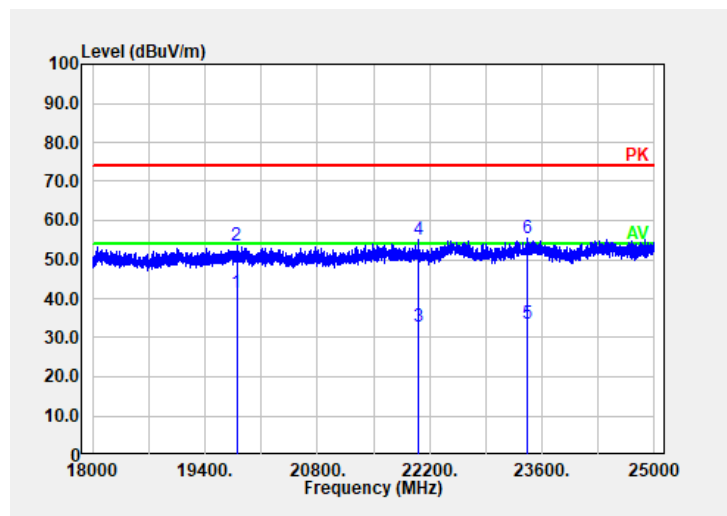
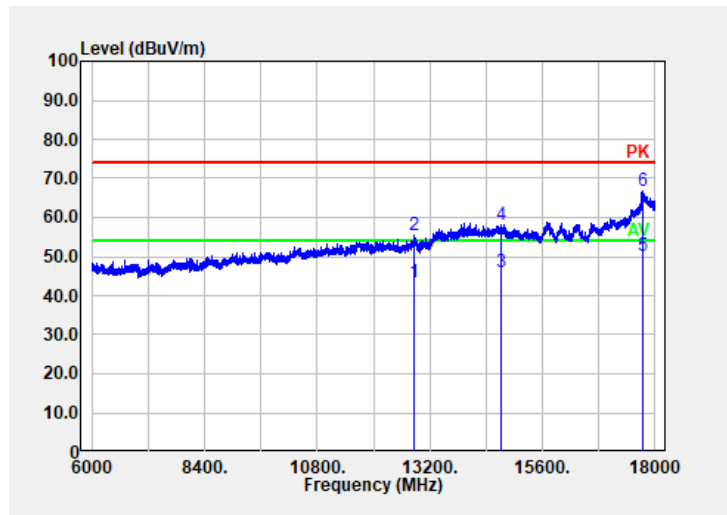
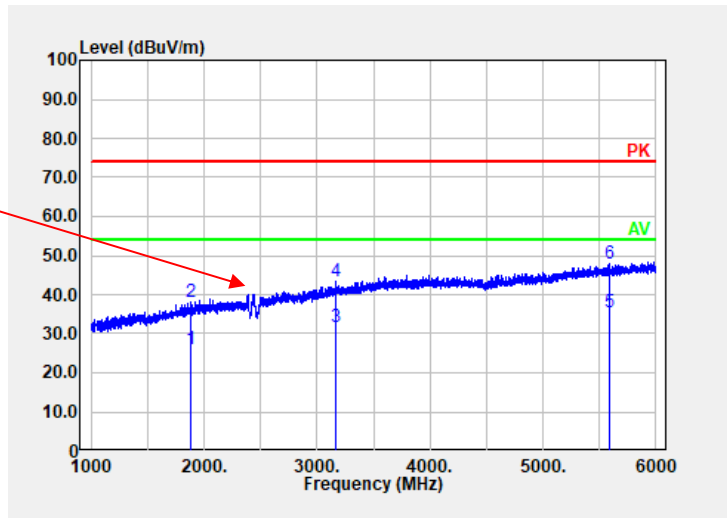

4.3 6 dB Emission Bandwidth:

Serial Number:	CR21090047-RF-S1	Test Date:	2021-10-11
Test Site:	RF	Test Mode:	Transmitting
Tester:	Le Qiao	Test Result:	Pass

Environmental Conditions:

Temperature: (°C)	27.6	Relative Humidity: (%)	68	ATM Pressure: (kPa)	100.5
----------------------	------	------------------------------	----	------------------------	-------

Test Equipment List and Details:

Manufacturer	Description	Model	Serial Number	Calibration Date	Calibration Due Date
R&S	Spectrum Analyzer	FSU 26	200160/026	2021-04-25	2022-04-24
Unknown	Coaxial Cable	C0010	C0010/04	Each time	N/A

* Statement of Traceability: China Certification ICT Co., Ltd (Dongguan) attests that all calibrations have been performed, traceable to National Primary Standards and International System of Units (SI).

Test Data:

Mode	Channel	Frequency (MHz)	6 dB Bandwidth (MHz)	Limit (MHz)
LE 1M	Lowest	2402	0.668	≥0.5
	Middle	2440	0.656	≥0.5
	Highest	2480	0.660	≥0.5
LE 2M	Lowest	2402	1.168	≥0.5
	Middle	2440	1.232	≥0.5
	Highest	2480	1.224	≥0.5

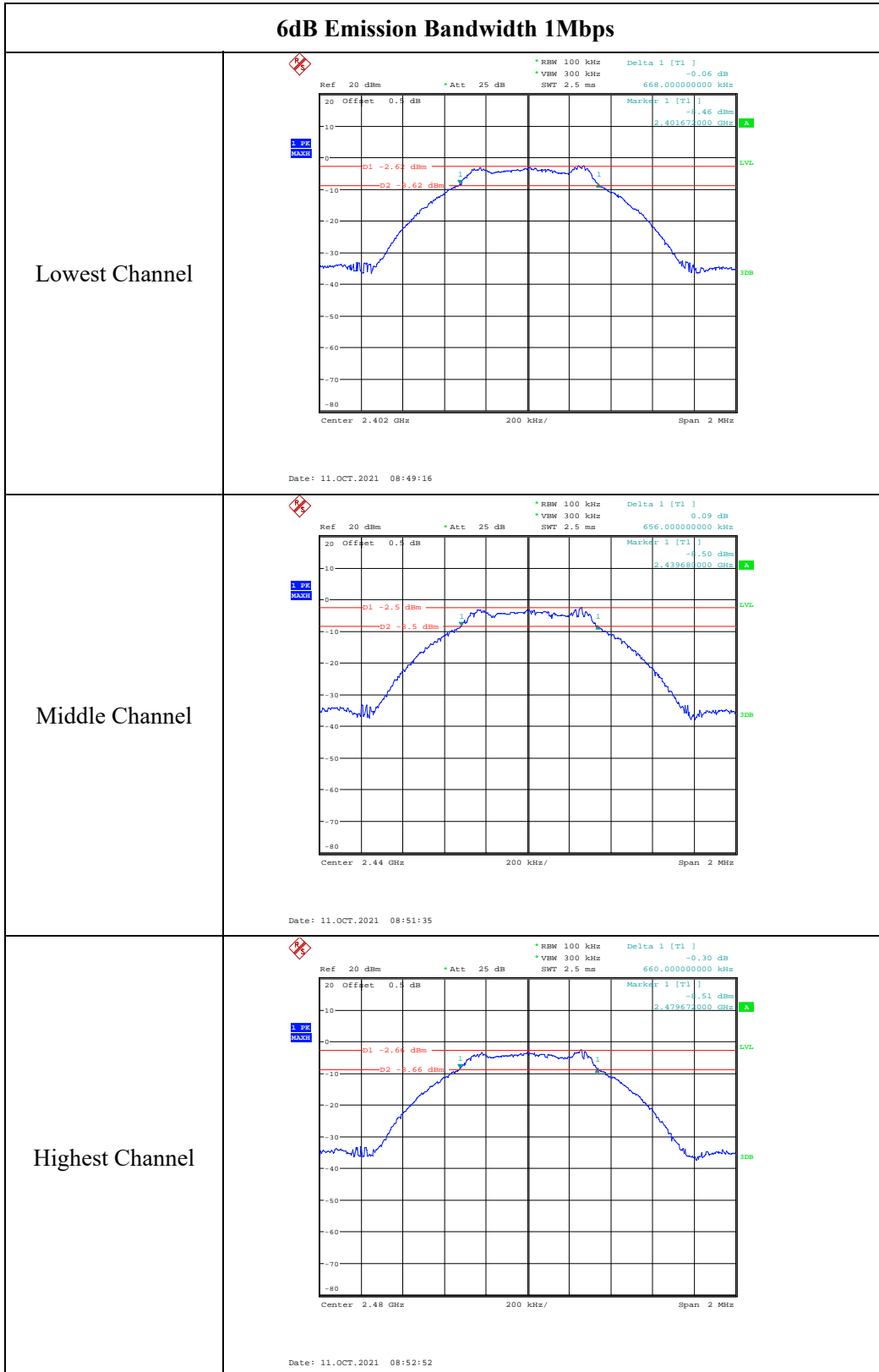

6dB Emission Bandwidth 2Mbps

<p>Lowest Channel</p>	<p>Ref: 20 dBm *Att: 25 dB *RBW: 100 kHz Delta 1 [T1]: -0.56 dB *VBW: 300 kHz *SWT: 2.5 ms 1.168000000 MHz</p> <p>Marker 1 [T1]: -4.61 dBm 2.401420000 GHz</p> <p>Center: 2.402 GHz 400 kHz/ Span: 4 MHz</p> <p>Date: 11.OCT.2021 08:57:28</p>
<p>Middle Channel</p>	<p>Ref: 20 dBm *Att: 25 dB *RBW: 100 kHz Delta 1 [T1]: 0.03 dB *VBW: 300 kHz *SWT: 2.5 ms 1.232000000 MHz</p> <p>Marker 1 [T1]: -0.29 dBm 2.439360000 GHz</p> <p>Center: 2.44 GHz 400 kHz/ Span: 4 MHz</p> <p>Date: 11.OCT.2021 08:56:11</p>
<p>Highest Channel</p>	<p>Ref: 20 dBm *Att: 25 dB *RBW: 100 kHz Delta 1 [T1]: 0.00 dB *VBW: 300 kHz *SWT: 2.5 ms 1.224000000 MHz</p> <p>Marker 1 [T1]: -0.49 dBm 2.429360000 GHz</p> <p>Center: 2.48 GHz 400 kHz/ Span: 4 MHz</p> <p>Date: 11.OCT.2021 08:54:33</p>

4.5 99% Occupied Bandwidth:

Serial Number:	CR21090047-RF-S1	Test Date:	2021-10-11
Test Site:	RF	Test Mode:	Transmitting
Tester:	Le Qiao	Test Result:	N/A

Environmental Conditions:

Temperature: (°C)	27.6	Relative Humidity: (%)	68	ATM Pressure: (kPa)	100.5
----------------------	------	---------------------------	----	------------------------	-------

Test Equipment List and Details:

Manufacturer	Description	Model	Serial Number	Calibration Date	Calibration Due Date
Unknown	Coaxial Cable	C0010	C0010/04	Each time	N/A
Agilent	USB Wideband Power Sensor	U2022XA	MY5315004	2021-09-12	2022-09-12

* Statement of Traceability: China Certification ICT Co., Ltd (Dongguan) attests that all calibrations have been performed, traceable to National Primary Standards and International System of Units (SI).

Test Data:

Mode	Channel	Frequency (MHz)	99% Bandwidth (MHz)	Limit (MHz)
LE 1M	Lowest	2402	1.028	≥0.5
	Middle	2440	1.028	≥0.5
	Highest	2480	1.028	≥0.5
LE 2M	Lowest	2402	2.056	≥0.5
	Middle	2440	2.056	≥0.5
	Highest	2480	2.056	≥0.5

99% Occupied Bandwidth 1Mbps

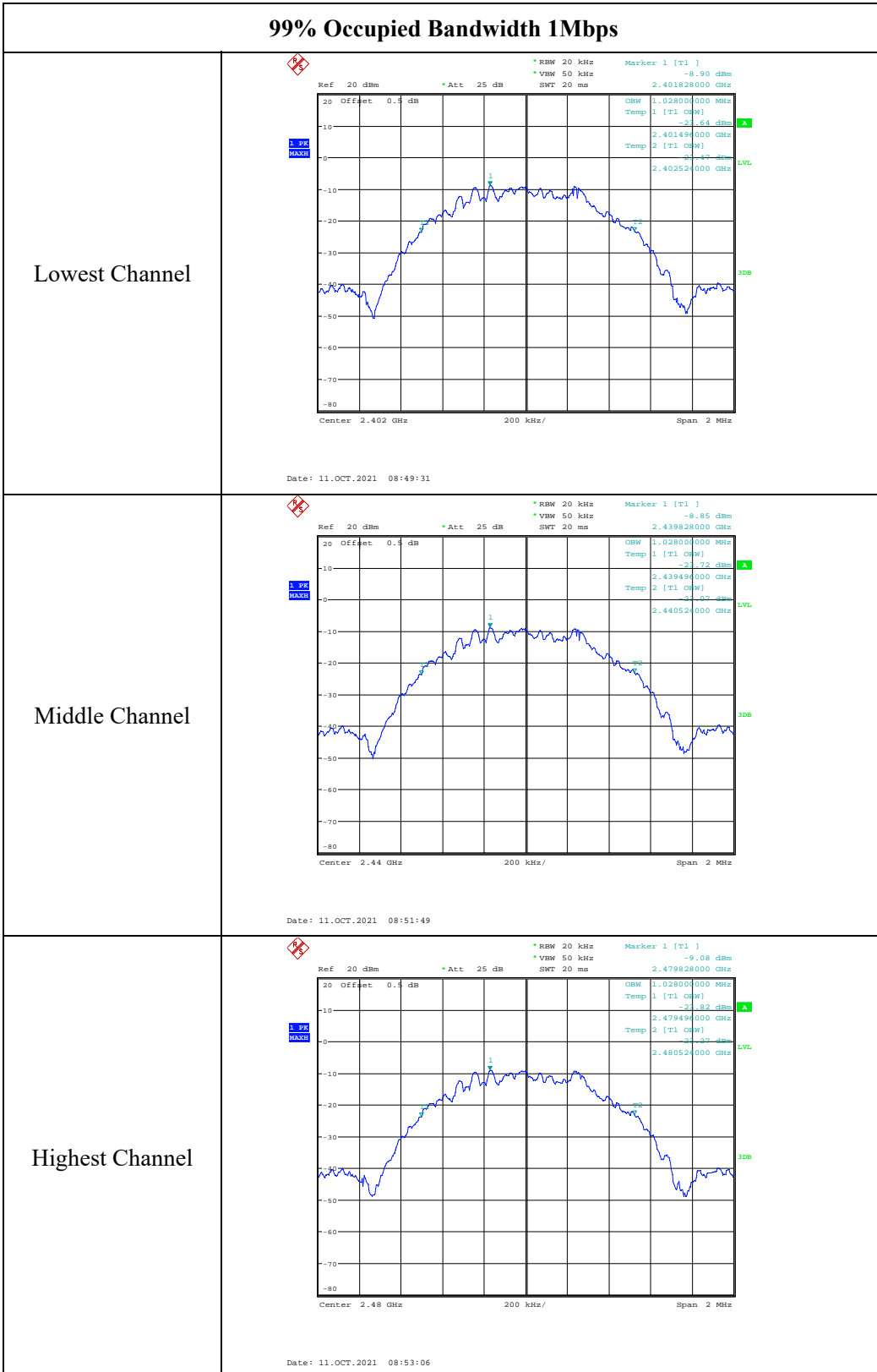

99% Occupied Bandwidth 2Mbps

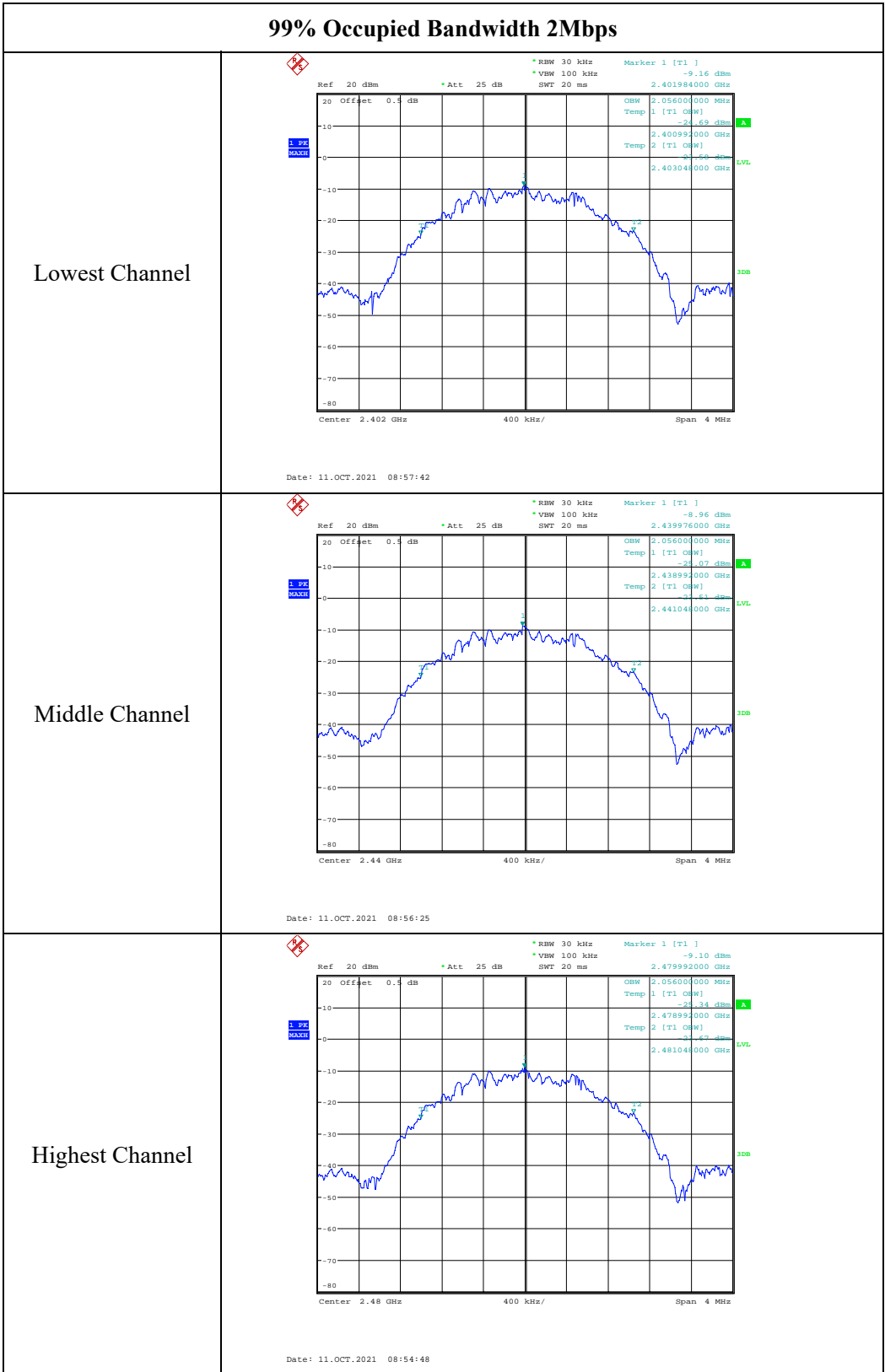

4.5 Maximum peak conducted output power:

Serial Number:	CR21090047-RF-S1	Test Date:	2021-10-11
Test Site:	RF	Test Mode:	Transmitting
Tester:	Le Qiao	Test Result:	Pass

Environmental Conditions:

Temperature: (°C)	27.6	Relative Humidity: (%)	68	ATM Pressure: (kPa)	100.5
----------------------	------	------------------------------	----	------------------------	-------

Test Equipment List and Details:

Manufacturer	Description	Model	Serial Number	Calibration Date	Calibration Due Date
Unknown	Coaxial Cable	C0010	C0010/04	Each time	N/A
Agilent	USB Wideband Power Sensor	U2022XA	MY5315004	2021-09-12	2022-09-12

* Statement of Traceability: China Certification ICT Co., Ltd (Dongguan) attests that all calibrations have been performed, traceable to National Primary Standards and International System of Units (SI).

Test Data:

Mode	Frequency (MHz)	Peak Conducted Output power (dBm)	Peak Conducted Output power Limit (dBm)
LE 1M	2402	-2.08	30
	2440	-2.10	30
	2480	-2.26	30
LE 2M	2402	-1.92	30
	2440	-2.05	30
	2480	-2.17	30

4.6 Maximum power spectral density:

Serial Number:	CR21090047-RF-S1	Test Date:	2021-10-11
Test Site:	RF	Test Mode:	Transmitting
Tester:	Le Qiao	Test Result:	Pass

Environmental Conditions:

Temperature: (°C)	27.6	Relative Humidity: (%)	68	ATM Pressure: (kPa)	100.5
----------------------	------	---------------------------	----	------------------------	-------

Test Equipment List and Details:

Manufacturer	Description	Model	Serial Number	Calibration Date	Calibration Due Date
R&S	Spectrum Analyzer	FSU 26	200160/026	2021-04-25	2022-04-24
Unknown	Coaxial Cable	C0010	C0010/04	Each time	N/A

* Statement of Traceability: China Certification ICT Co., Ltd (Dongguan) attests that all calibrations have been performed, traceable to National Primary Standards and International System of Units (SI).

Test Data:

Mode	Channel	Frequency (MHz)	PSD (dBm/3kHz)	Limit (dBm/3kHz)
LE 1M	Low	2402	-18.70	≤8
	Middle	2440	-18.74	≤8
	High	2480	-18.77	≤8
LE 2M	Low	2402	-22.44	≤8
	Middle	2440	-21.82	≤8
	High	2480	-22.13	≤8

Maximum power spectral density 1Mbps

<p>Lowest Channel</p>	<p>Date: 11.OCT.2021 08:49:58</p>
<p>Middle Channel</p>	<p>Date: 11.OCT.2021 08:52:18</p>
<p>Highest Channel</p>	<p>Date: 11.OCT.2021 08:53:33</p>

Maximum power spectral density 2Mbps

<p>Lowest Channel</p>	<p>Ref 20 dBm * Att 25 dB * RBW 3 kHz Marker 1 [T1] -22.44 dBm * VBW 10 kHz * SWT 195 ms 2.401992992 GHz</p> <p>Center 2.402 GHz 175.2 kHz/ Span 1.752 MHz</p> <p>Date: 11.OCT.2021 08:58:11</p>
<p>Middle Channel</p>	<p>Ref 20 dBm * Att 25 dB * RBW 3 kHz Marker 1 [T1] -21.82 dBm * VBW 10 kHz * SWT 210 ms 2.439974128 GHz</p> <p>Center 2.44 GHz 184.8 kHz/ Span 1.848 MHz</p> <p>Date: 11.OCT.2021 08:56:55</p>
<p>Highest Channel</p>	<p>Ref 20 dBm * Att 25 dB * RBW 3 kHz Marker 1 [T1] -22.13 dBm * VBW 10 kHz * SWT 205 ms 2.479970624 GHz</p> <p>Center 2.48 GHz 183.6 kHz/ Span 1.836 MHz</p> <p>Date: 11.OCT.2021 08:55:17</p>

4.7 100 kHz Bandwidth of Frequency Band Edge:

Serial Number:	CR21090047-RF-S1	Test Date:	2021-10-11
Test Site:	RF	Test Mode:	Transmitting
Tester:	Le Qiao	Test Result:	Pass

Environmental Conditions:

Temperature: (°C)	27.6	Relative Humidity: (%)	68	ATM Pressure: (kPa)	100.5
----------------------	------	------------------------------	----	------------------------	-------

Test Equipment List and Details:

Manufacturer	Description	Model	Serial Number	Calibration Date	Calibration Due Date
R&S	Spectrum Analyzer	FSU 26	200160/026	2021-04-25	2022-04-24
Unknown	Coaxial Cable	C0010	C0010/04	Each time	N/A

** Statement of Traceability: China Certification ICT Co., Ltd (Dongguan) attests that all calibrations have been performed, traceable to National Primary Standards and International System of Units (SI).*

Test Data:

100 kHz Bandwidth of Frequency Band Edge 1Mbps

Lowest Band edge

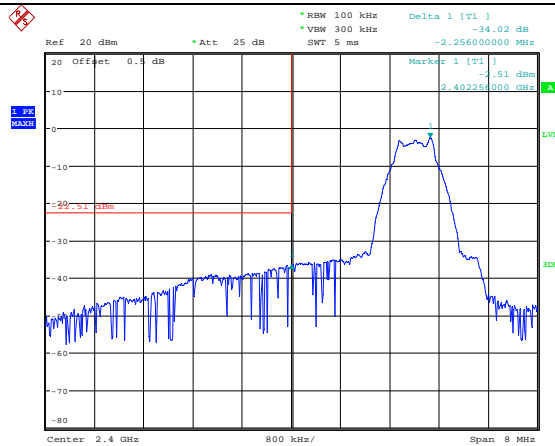

Date: 11.OCT.2021 08:50:29

Highest Band edge

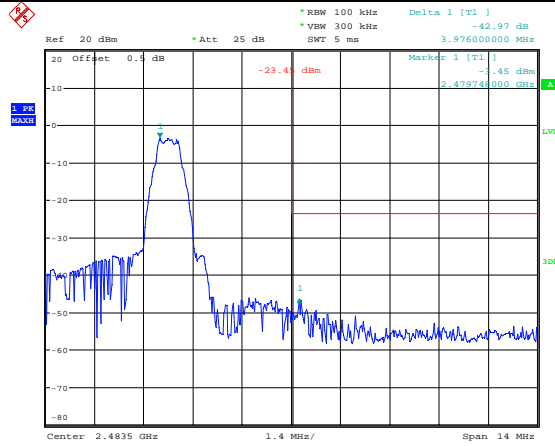

Date: 11.OCT.2021 08:53:57

100 kHz Bandwidth of Frequency Band Edge 2Mbps

Lowest Band edge

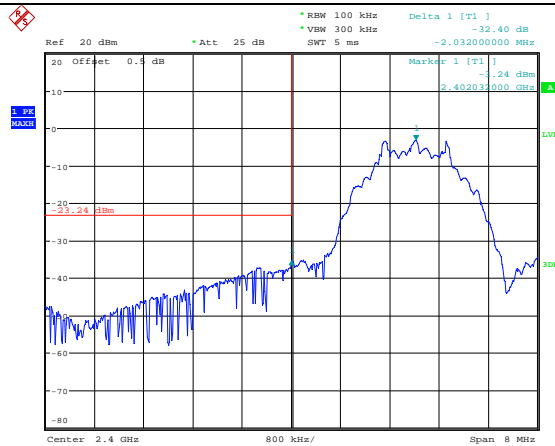

Date: 11.OCT.2021 08:58:35

Highest Band edge

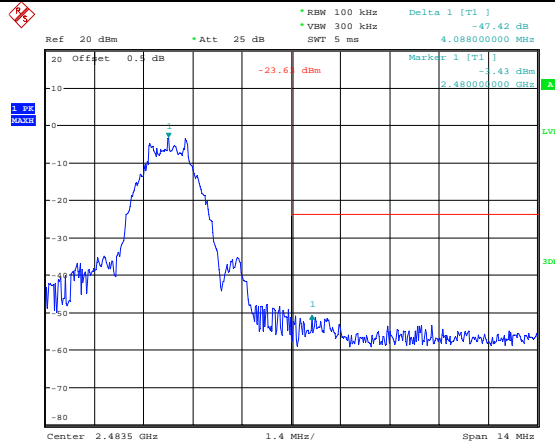

Date: 11.OCT.2021 08:55:35

4.8 Duty Cycle:

Serial Number:	CR21090047-RF-S1	Test Date:	2021-10-11
Test Site:	RF	Test Mode:	Transmitting
Tester:	Le Qiao	Test Result:	N/A

Environmental Conditions:

Temperature: (°C)	27.6	Relative Humidity: (%)	68	ATM Pressure: (kPa)	100.5
----------------------	------	------------------------------	----	------------------------	-------

Test Equipment List and Details:

Manufacturer	Description	Model	Serial Number	Calibration Date	Calibration Due Date
R&S	Spectrum Analyzer	FSU 26	200160/026	2021-04-25	2022-04-24
Unknown	Coaxial Cable	C0010	C0010/04	Each time	N/A

** Statement of Traceability: China Certification ICT Co., Ltd (Dongguan) attests that all calibrations have been performed, traceable to National Primary Standards and International System of Units (SI).*

Test Data:

Test Modes	Ton (ms)	Ton+off (ms)	Duty cycle (%)
BLE 1Mbps	2.170	2.504	86.66
BLE 2Mbps	1.106	2.503	44.19

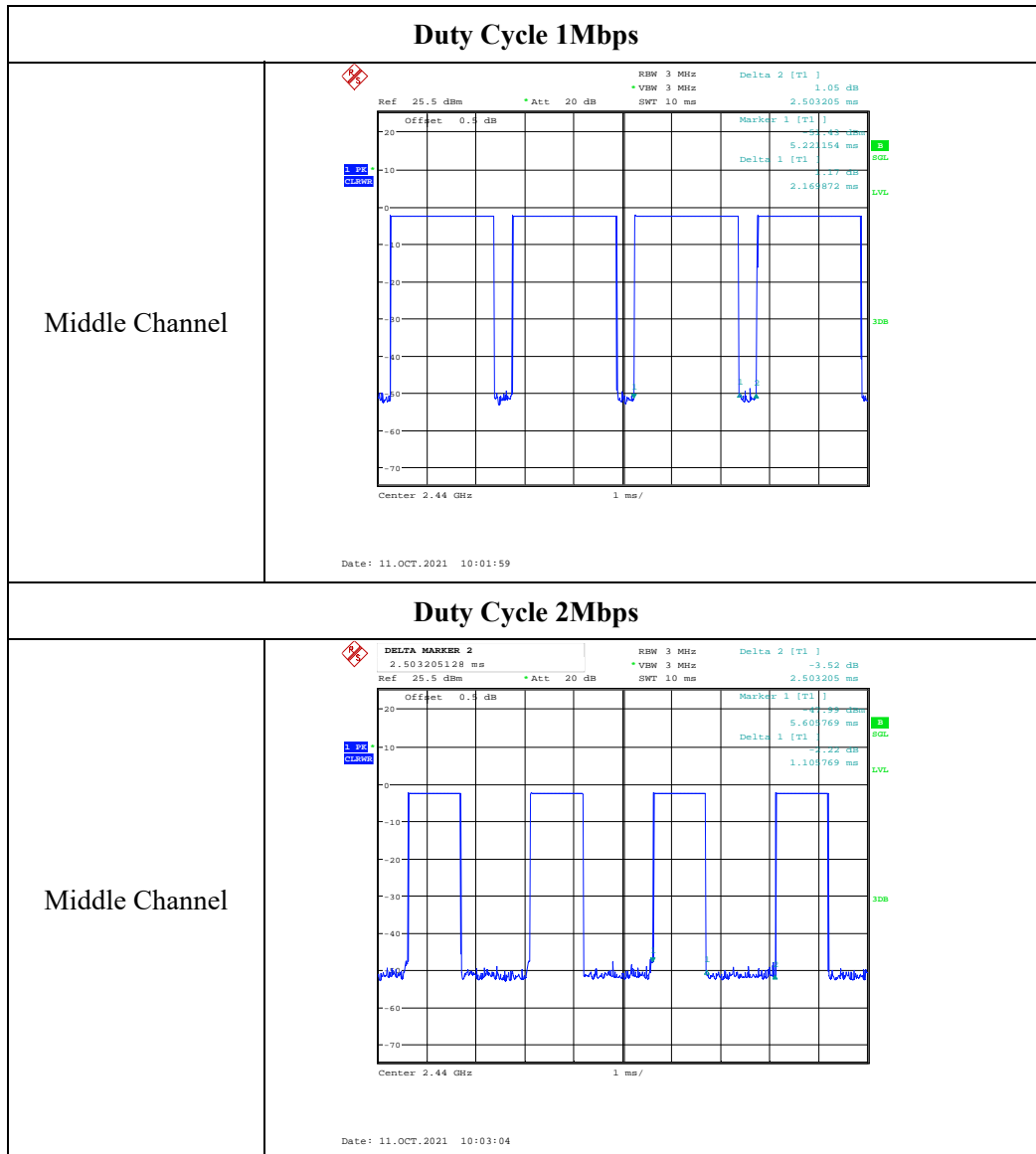

5. RF EXPOSURE EVALUATION

5.1 MAXIMUM PERMISSIBLE EXPOSURE (MPE)

5.1.1 Applicable Standard

FCC §15.247 (i) & §1.1310 & §2.1091

Systems operating under the provisions of this section shall be operated in a manner that ensures that the public is not exposed to radio frequency energy levels in excess of the Commission's guidelines. See §1.1307(b)(1) of this chapter.

Limits for Maximum Permissible Exposure (MPE) (§1.1310, §2.1091)

(B) Limits for General Population/Uncontrolled Exposure				
Frequency Range (MHz)	Electric Field Strength (V/m)	Magnetic Field Strength (A/m)	Power Density (mW/cm ²)	Averaging Time (minutes)
0.3–1.34	614	1.63	*(100)	30
1.34–30	824/f	2.19/f	*(180/f ²)	30
30–300	27.5	0.073	0.2	30
300–1500	/	/	f/1500	30
1500–100,000	/	/	1.0	30

f = frequency in MHz; * = Plane-wave equivalent power density;

According to §1.1310 and §2.1091 RF exposure is calculated.

5.1.2 Procedure

Prediction of power density at the distance of the applicable MPE limit

$S = PG/4\pi R^2$ = power density (in appropriate units, e.g. mW/cm²);

P = power input to the antenna (in appropriate units, e.g., mW);

G = power gain of the antenna in the direction of interest relative to an isotropic radiator, the power gain factor, is normally numeric gain;

R = distance to the center of radiation of the antenna (appropriate units, e.g., cm);

5.1.3 Calculated Result

Operation Modes	Frequency (MHz)	Antenna Gain		Conducted output power including Tune-up Tolerance		Evaluation Distance (cm)	Power Density (mW/cm ²)	MPE Limit (mW/cm ²)
		(dBi)	(numeric)	(dBm)	(mW)			
BLE	2402-2480	4	2.51	-1	0.79	20.00	0.0004	1.0

Result: The device meet FCC MPE at 20 cm distance

5.2 EXEMPTION LIMITS FOR ROUTINE EVALUATION – RF EXPOSURE EVALUATION

5.2.1 Applicable Standard

RSS-102 § (2.5.2):

RF exposure evaluation is required if the separation distance between the user and/or bystander and the device's radiating element is greater than 20 cm, except when the device operates as follows:

- below 20 MHz and the source-based, time-averaged maximum e.i.r.p. of the device is equal to or less than 1 W (adjusted for tune-up tolerance);
- at or above 20 MHz and below 48 MHz and the source-based, time-averaged maximum e.i.r.p. of the device is equal to or less than $4.49/f^{0.5}$ W (adjusted for tune-up tolerance), where f is in MHz;
- at or above 48 MHz and below 300 MHz and the source-based, time-averaged maximum e.i.r.p. of the device is equal to or less than 0.6 W (adjusted for tune-up tolerance);
- at or above 300 MHz and below 6 GHz and the source-based, time-averaged maximum e.i.r.p. of the device is equal to or less than $1.31 \times 10^{-2} f^{0.6834}$ W (adjusted for tune-up tolerance), where f is in MHz;
- at or above 6 GHz and the source-based, time-averaged maximum e.i.r.p. of the device is equal to or less than 5 W (adjusted for tune-up tolerance).

In these cases, the information contained in the RF exposure technical brief may be limited to information that demonstrates how the e.i.r.p. was derived.

5.2.2 Calculated Result

Mode	Frequency (MHz)	Antenna Gain	Conducted output power including Tune-up Tolerance	EIRP		Exemption limits (mW)	Exemption
		(dBi)	(dBm)	(dBm)	(mW)		
BLE	2402-2480	4	-1	3.0	2.0	2676	Yes

Result: Compliance. The device is compliance exemption from Routine Evaluation Limits –RF exposure Evaluation.

***** END OF REPORT *****