



**中认信通**  
CHINA CERTIFICATION ICT CO., LTD (DONGGUAN)



## TEST REPORT

**Applicant: Edco Electronics Inc.**

Address: FCC:8484 Avenue de l'Esplanade Montreal, Quebec Montreal, H2P 2R7 Canada  
ISED: 8484 Avenue de l'Esplanade Montréal QC H2P 2R7 Canada

**FCC ID: 2AJMW-BTSPK84**

**IC: 20174-BTSPK84**

**HVIN: BTSPK84**

**Product Name: PORTABLE WIRELESS SPEAKER**

**Model Number: BTSPK84**

**Standard(s): 47 CFR Part 15, Subpart C(15.247)**  
**RSS-247 Issue 2, February 2017**  
**RSS-Gen, Issue 5, February 2021 Amendment 2**  
**ANSI C63.10-2013**  
**KDB 558074 D01 15.247 Meas Guidance v05r02**

The above equipment has been tested and found compliance with the requirement of the relative standards by China Certification ICT Co., Ltd (Dongguan)

**Report Number: CR21090047-00A**

**Date Of Issue: 2021-11-22**

**Reviewed By: Sun Zhong**

*Sun Zhong*

Title: Manager

**Test Laboratory: China Certification ICT Co., Ltd (Dongguan)**  
No. 113, Pingkang Road, Dalang Town, Dongguan,  
Guangdong, China  
Tel: +86-769-82016888

## Test Facility

The Test site used by China Certification ICT Co., Ltd (Dongguan) to collect test data is located on the No. 113, Pingkang Road, Dalang Town, Dongguan, Guangdong, China.

The lab has been recognized as the FCC accredited lab under the KDB 974614 D01 and is listed in the FCC Public Access Link (PAL) database, FCC Registration No. : 442868, the FCC Designation No. : CN1314.

The lab has been recognized by Innovation, Science and Economic Development Canada to test to Canadian radio equipment requirements, the CAB identifier: CN0123.

## Declarations

China Certification ICT Co., Ltd (Dongguan) is not responsible for the authenticity of any test data provided by the applicant. Data included from the applicant that may affect test results are marked with a triangle symbol “▲”. Customer model name, addresses, names, trademarks etc. are not considered data.

Unless otherwise stated the results shown in this test report refer only to the sample(s) tested.

This report cannot be reproduced except in full, without prior written approval of the Company.

This report is valid only with a valid digital signature. The digital signature may be available only under the Adobe software above version 7.0.

This report may contain data that are not covered by the accreditation scope and shall be marked with an asterisk “★”.

## CONTENTS

<b>TEST FACILITY .....</b>	<b>2</b>
<b>DECLARATIONS.....</b>	<b>2</b>
<b>1. GENERAL INFORMATION .....</b>	<b>5</b>
<b>1.1 PRODUCT DESCRIPTION FOR EQUIPMENT UNDER TEST (EUT) .....</b>	<b>5</b>
<b>1.2 DESCRIPTION OF TEST CONFIGURATION.....</b>	<b>6</b>
1.2.2 Support Equipment List and Details .....	6
1.2.3 Support Cable List and Details .....	6
1.2.4 Block Diagram of Test Setup.....	7
<b>1.3 MEASUREMENT UNCERTAINTY .....</b>	<b>9</b>
<b>2. SUMMARY OF TEST RESULTS .....</b>	<b>10</b>
<b>3. REQUIREMENTS AND TEST PROCEDURES .....</b>	<b>11</b>
<b>3.1 AC LINE CONDUCTED EMISSIONS.....</b>	<b>11</b>
3.1.1 Applicable Standard.....	11
3.1.2 EUT Setup.....	12
3.1.3 EMI Test Receiver Setup .....	13
3.1.4 Test Procedure .....	13
3.1.5 Corrected Amplitude & Margin Calculation.....	13
<b>3.2 RADIATION SPURIOUS EMISSIONS .....</b>	<b>14</b>
3.2.1 Applicable Standard.....	14
3.2.2 EUT Setup.....	14
3.2.3 EMI Test Receiver & Spectrum Analyzer Setup .....	15
3.2.4 Test Procedure .....	15
3.2.5 Corrected Amplitude & Margin Calculation.....	15
<b>3.3 20 DB BANDWIDTH.....</b>	<b>17</b>
3.3.1 Applicable Standard.....	17
3.3.2 EUT Setup.....	17
3.3.3 Test Procedure .....	17
<b>3.4 99% OCCUPIED BANDWIDTH: .....</b>	<b>18</b>
3.4.1 Applicable Standard.....	18
3.4.2 EUT Setup.....	18
3.4.3 Test Procedure .....	19
<b>3.5 CHANNEL SEPARATION .....</b>	<b>20</b>
3.5.1 Applicable Standard.....	20
3.5.2 EUT Setup.....	20
3.5.3 Test Procedure .....	20
<b>3.6 NUMBER OF HOPPING FREQUENCY .....</b>	<b>21</b>
3.6.1 Applicable Standard.....	21
3.6.2 EUT Setup.....	21
3.6.3 Test Procedure .....	21
<b>3.7 TIME OF OCCUPANCY(DWELL TIME).....</b>	<b>22</b>
3.7.1 Applicable Standard.....	22

3.7.2 EUT Setup.....22

3.7.3 Test Procedure .....22

**3.8 PEAK OUTPUT POWER.....23**

3.8.1 Applicable Standard.....23

3.8.2 EUT Setup.....23

3.8.3 Test Procedure .....23

**3.9 100 KHZ BANDWIDTH OF FREQUENCY BAND EDGE.....24**

3.9.1 Applicable Standard.....24

3.9.2 EUT Setup.....24

3.9.3 Test Procedure .....24

**3.10 ANTENNA REQUIREMENT.....25**

3.10.1 Applicable Standard.....25

3.10.2 Judgment.....25

**4. TEST DATA AND RESULTS ..... 26**

**4.1 AC LINE CONDUCTED EMISSIONS.....26**

**4.2 RADIATION SPURIOUS EMISSIONS .....29**

**4.3 20 dB EMISSION BANDWIDTH: .....35**

**4.4 99% OCCUPIED BANDWIDTH: .....39**

**4.5 CHANNEL SEPARATION: .....43**

**4.6 NUMBER OF HOPPING FREQUENCY: .....47**

**4.7 TIME OF OCCUPANCY(DWELL TIME):.....49**

**4.8 PEAK CONDUCTED OUTPUT POWER: .....53**

**4.9 100 KHZ BANDWIDTH OF FREQUENCY BAND EDGE: .....54**

**5. RF EXPOSURE EVALUATION ..... 61**

**5.1 APPLICABLE STANDARD.....61**

**5.2 PROCEDURE.....61**

**5.3 MEASUREMENT RESULT .....61**

**5.2 EXEMPTION LIMITS FOR ROUTINE EVALUATION – SAR EVALUATION .....62**

**5.2.1 APPLICABLE STANDARD.....62**

## 1. GENERAL INFORMATION

### 1.1 Product Description for Equipment under Test (EUT)

<b>EUT Name:</b>	PORTABLE WIRELESS SPEAKER
<b>EUT Model:</b>	BTSPK84
<b>Operation Frequency:</b>	2402-2480 MHz
<b>Maximum Peak Output Power (Conducted):</b>	-1.73dBm
<b>Modulation Type:</b>	GFSK, $\pi/4$ -DQPSK, 8DPSK
<b>Rated Input Voltage:</b>	DC 3.7V from Battery or DC 5V from USB port
<b>Serial Number:</b>	CR21090047-RF-S1
<b>EUT Received Date:</b>	2021.9.29
<b>EUT Received Status:</b>	Good

#### Operation Frequency Detail:

Channel	Frequency (MHz)	Channel	Frequency (MHz)
0	2402	40	2442
1	2403	41	2443
...	...	...	...
...	...	...	...
..	...	78	2480
39	2441	/	/

Per section 15.31(m)/RSS-Gen, the lowest frequency, middle frequency, and highest frequency were performed the test as below:

Test Channel	Frequency (MHz)
Lowest	2402
Middle	2441
Highest	2480

#### Antenna Information Detail▲:

Antenna Manufacturer	Antenna Type	input impedance (Ohm)	Antenna Gain /Frequency Range	§15.203 RSS-GEN Requirement
Edco Electronics Inc.	PCB	50	4 dBi/ 2.4~2.5GHz	Compliance

The Method of §15.203 Compliance:

- Antenna must be permanently attached to the unit.
- Antenna must use a unique type of connector to attach to the EUT.
- Unit must be professionally installed, and installer shall be responsible for verifying that the correct antenna is employed with the unit.

#### Accessory Information:

Accessory Description	Manufacturer	Model	Parameters
IR Remote	Edco Electronics Inc.	Unknown	10 keys
Microphone	Edco Electronics Inc.	Unknown	2m unshielding

## 1.2 Description of Test Configuration

### 1.2.1 EUT Operation Condition:

<b>EUT Operation Mode:</b>	The system was configured for testing in Engineering Mode, which was provided by the manufacturer.		
<b>Equipment Modifications:</b>	No		
<b>EUT Exercise Software:</b>	FCC_assist_1.0.2.2		
The software " FCC_assist_1.0.2.2 "was provided by manufacturer. The maximum power was configured as below, that was provided by the manufacturer ▲ :			
Test Modes	Power Level Setting		
	Lowest	Middle	Highest
GFSK	10	10	10
$\pi/4$ -DQPSK	10	10	10
8DPSK	10	10	10

### 1.2.2 Support Equipment List and Details

Manufacturer	Description	Model	Serial Number
SanDisk	SD Card	UHS-I-128G	9292DVDSV0XZ
Kingston	USB Flash Disk	Z3	Z3-20182547
MASS POWER	AC/DC Adapter	MAPS01-0500100	PS2025

### 1.2.3 Support Cable List and Details

Cable Description	Shielding Type	Ferrite Core	Length (m)	From Port	To
Microphone Cable	Yes	No	3.5	EUT	Microphone
USB Cable	Yes	No	0.5	Adapter	EUT

### .2.4 Block Diagram of Test Setup

AC line conducted emissions:

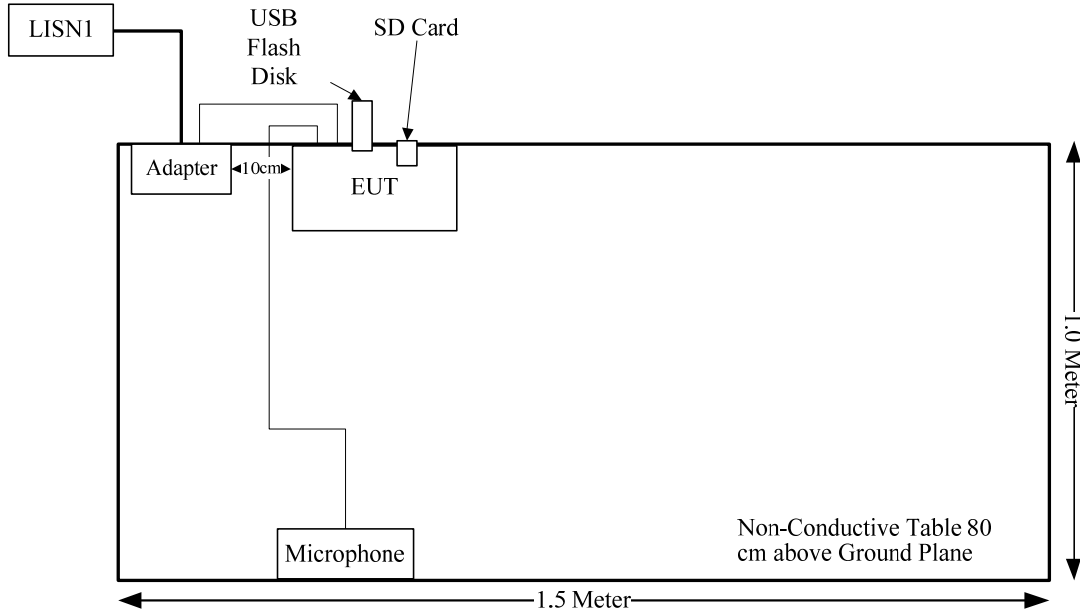

Spurious Emissions:  
Below 1GHz:

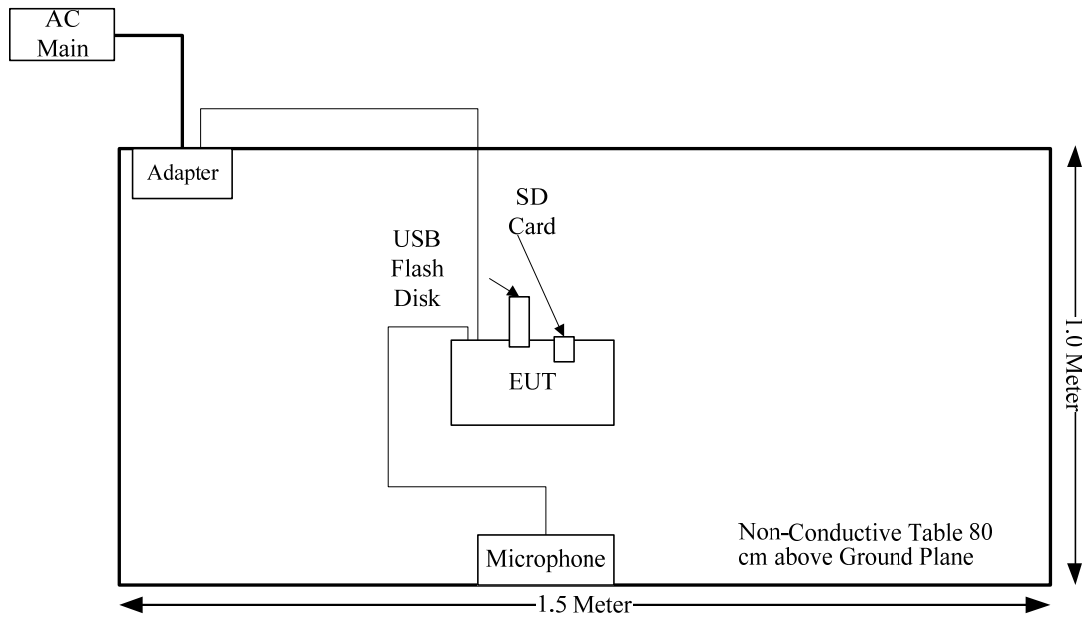

Above 1GHz:

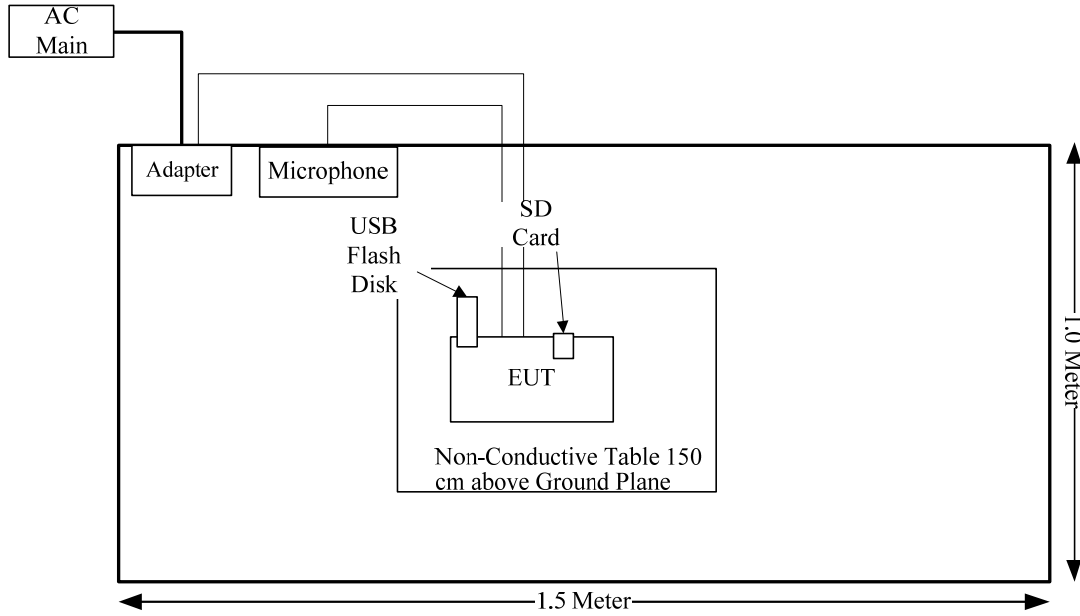



### 1.3 Measurement Uncertainty

Otherwise required by the applicant or Product Regulations, Decision Rule in this report did not consider the uncertainty. The extended uncertainty given in this report is obtained by combining the standard uncertainty times the coverage factor K with the 95% confidence interval.

Parameter	Measurement Uncertainty
Occupied Channel Bandwidth	±5 %
RF output power, conducted	±0.61dB
Power Spectral Density, conducted	±0.61 dB
Unwanted Emissions, radiated	30M~200MHz: 4.15 dB,200M~1GHz: 5.61 dB,1G~6GHz: 5.14 dB, 6G~18GHz: 5.93 dB,18G~26.5G:5.47 dB,26.5G~40G:5.63 dB
Unwanted Emissions, conducted	±1.26 dB
Temperature	±1 °C
Humidity	±5%
DC and low frequency voltages	±0.4%
Duty Cycle	1%
AC Power Lines Conducted Emission	2.8 dB (150 kHz to 30 MHz)

## 2. SUMMARY OF TEST RESULTS

FCC Rules	Description of Test	Result
FCC §15.207(a) RSS-Gen Clause 8.8	AC line conducted emissions	Compliance
FCC §15.205, §15.209, §15.247(d) RSS-Gen Clause 8.10	Spurious emissions	Compliance
FCC §15.247(a)(1) RSS-247 Clause 5.1 b)	20 dB bandwidth	Compliance
RSS-Gen Clause 6.7	99% Occupied Bandwidth	Compliance
FCC §15.247(a)(1) RSS-247 Clause 5.1 b)	Channel separation	Compliance
FCC §15.247(a)(1)(iii) RSS-247 Clause 5.1 d)	Number of hopping Frequency	Compliance
FCC §15.247(a)(1)(iii) RSS-247 Clause 5.1 d)	Time of occupancy (dwell time)	Compliance
FCC §15.247(b)(1) RSS-247 Clause 5.4 b)	Peak output power measurement	Compliance
FCC §15.247(d) RSS-247 Clause 5.5	Band edges	Compliance
FCC §15.203 RSS-GEN Clause 6.8	Antenna requirement	Compliance
FCC§15.247 (i) & §1.1310 & §2.1093	RF Exposure	Compliance
RSS-102 Clause 2.5.1	Exemption Limits For Routine Evaluation- SAR Evaluation	Compliance

### 3. REQUIREMENTS AND TEST PROCEDURES

#### 3.1 AC Line Conducted Emissions

##### 3.1.1 Applicable Standard

FCC§15.207(a).

(a) Except as shown in paragraphs (b) and (c) of this section, for an intentional radiator that is designed to be connected to the public utility (AC) power line, the radio frequency voltage that is conducted back onto the AC power line on any frequency or frequencies, within the band 150 kHz to 30 MHz, shall not exceed the limits in the following table, as measured using a 50  $\mu$ H/50 ohms line impedance stabilization network (LISN). Compliance with the provisions of this paragraph shall be based on the measurement of the radio frequency voltage between each power line and ground at the power terminal. The lower limit applies at the boundary between the frequency ranges.

Frequency of emission (MHz)	Conducted limit (dB $\mu$ V)	
	Quasi-peak	Average
0.15-0.5	66 to 56*	56 to 46*
0.5-5	56	46
5-30	60	50

\*Decreases with the logarithm of the frequency.

(b) The limit shown in paragraph (a) of this section shall not apply to carrier current systems operating as intentional radiators on frequencies below 30 MHz. In lieu thereof, these carrier current systems shall be subject to the following standards:

(1) For carrier current system containing their fundamental emission within the frequency band 535-1705 kHz and intended to be received using a standard AM broadcast receiver: no limit on conducted emissions.

(2) For all other carrier current systems: 1000  $\mu$ V within the frequency band 535-1705 kHz, as measured using a 50  $\mu$ H/50 ohms LISN.

(3) Carrier current systems operating below 30 MHz are also subject to the radiated emission limits in §15.205, §15.209, §15.221, §15.223, or §15.227, as appropriate.

(c) Measurements to demonstrate compliance with the conducted limits are not required for devices which only employ battery power for operation and which do not operate from the AC power lines or contain provisions for operation while connected to the AC power lines. Devices that include, or make provisions for, the use of battery chargers which permit operating while charging, AC adapters or battery eliminators or that connect to the AC power lines indirectly, obtaining their power through another device which is connected to the AC power lines, shall be tested to demonstrate compliance with the conducted limits.

RSS-Gen Clause 8.8

Unless stated otherwise in the applicable RSS, for radio apparatus that are designed to be connected to the public utility AC power network, the radio frequency voltage that is conducted back onto the AC power line on any frequency or frequencies within the range 150 kHz to 30 MHz shall not exceed the limits in table 4, as measured using a 50  $\mu$ H / 50  $\Omega$  line impedance stabilization network. This requirement applies for the radio frequency voltage measured between each power line and the ground terminal of each AC power-line mains cable of the EUT.

For an EUT that connects to the AC power lines indirectly, through another device, the requirement for compliance with the limits in table 4 shall apply at the terminals of the AC power-line mains cable of a representative support device, while it provides power to the EUT. The lower limit applies at the

boundary between the frequency ranges. The device used to power the EUT shall be representative of typical applications.

**Table 4 – AC power-line conducted emissions limits**

Frequency (MHz)	Conducted limit (dB $\mu$ V)	
	Quasi-peak	Average
0.15 - 0.5	66 to 56 <sup>1</sup>	56 to 46 <sup>1</sup>
0.5 – 5	56	46
5 – 30	60	50

**Note 1:** The level decreases linearly with the logarithm of the frequency.

For an EUT with a permanent or detachable antenna operating between 150 kHz and 30 MHz, the AC power-line conducted emissions must be measured using the following configurations:

(a) Perform the AC power-line conducted emissions test with the antenna connected to determine compliance with the limits of table 4 outside the transmitter's fundamental emission band.

(b) Retest with a dummy load instead of the antenna to determine compliance with the limits of table 4 within the transmitter's fundamental emission band. For a detachable antenna, remove the antenna and connect a suitable dummy load to the antenna connector. For a permanent antenna, remove the antenna and terminate the RF output with a dummy load or network that simulates the antenna in the fundamental frequency band.

### 3.1.2 EUT Setup

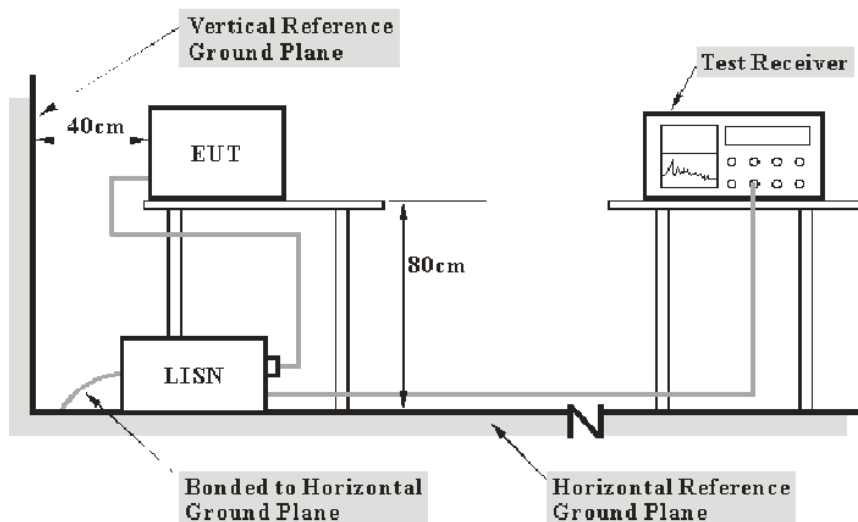

Note: 1. Support units were connected to second LISN.  
2. Both of LISNs (AMN) 80 cm from EUT and at the least 80 cm from other units and other metal planes support units.

The setup of EUT is according with per ANSI C63.10-2013 measurement procedure. The specification used was with the FCC Part 15.207,RSS-Gen limits.

The spacing between the peripherals was 10 cm.

The adapter or EUT was connected to the main LISN with a 120 V/60 Hz AC power source.

### 3.1.3 EMI Test Receiver Setup

The EMI test receiver was set to investigate the spectrum from 150 kHz to 30 MHz.

During the conducted emission test, the EMI test receiver was set with the following configurations:

Frequency Range	IF B/W
150 kHz – 30 MHz	9 kHz

### 3.1.4 Test Procedure

The frequency and amplitude of the six highest ac power-line conducted emissions relative to the limit, measured over all the current-carrying conductors of the EUT power cords, and the operating frequency or frequency to which the EUT is tuned (if appropriate), should be reported, unless such emissions are more than 20 dB below the limit. AC power-line conducted emissions measurements are to be separately carried out only on each of the phase (“hot”) line(s) and (if used) on the neutral line(s), but not on the ground [protective earth] line(s). If less than six emission frequencies are within 20 dB of the limit, then the noise level of the measuring instrument at representative frequencies should be reported. The specific conductor of the power-line cord for each of the reported emissions should be identified. Measure the six highest emissions with respect to the limit on each current-carrying conductor of each power cord associated with the EUT (but not the power cords of associated or peripheral equipment that are part of the test configuration). Then, report the six highest emissions with respect to the limit from among all the measurements identifying the frequency and specific current-carrying conductor identified with the emission. The six highest emissions should be reported for each of the current-carrying conductors, or the six highest emissions may be reported over all the current-carrying conductors.

### 3.1.5 Corrected Amplitude & Margin Calculation

The basic equation is as follows:

Result = Reading + Factor

Factor = attenuation caused by cable loss + voltage division factor of AMN

The “**Margin**” column of the following data tables indicates the degree of compliance within the applicable limit. The equation for margin calculation is as follows:

Margin = Limit – Result

## 3.2 Radiation Spurious Emissions

### 3.2.1 Applicable Standard

FCC §15.247 (d);

In any 100 kHz bandwidth outside the frequency band in which the spread spectrum or digitally modulated intentional radiator is operating, the radio frequency power that is produced by the intentional radiator shall be at least 20 dB below that in the 100 kHz bandwidth within the band that contains the highest level of the desired power, based on either an RF conducted or a radiated measurement, provided the transmitter demonstrates compliance with the peak conducted power limits. If the transmitter complies with the conducted power limits based on the use of RMS averaging over a time interval, as permitted under paragraph (b)(3) of this section, the attenuation required under this paragraph shall be 30 dB instead of 20 dB. Attenuation below the general limits specified in §15.209(a) is not required. In addition, radiated emissions which fall in the restricted bands, as defined in §15.205(a), must also comply with the radiated emission limits specified in §15.209(a) (see §15.205(c)).

RSS-247 Clause 5.5

In any 100 kHz bandwidth outside the frequency band in which the spread spectrum or digitally modulated device is operating, the RF power that is produced shall be at least 20 dB below that in the 100 kHz bandwidth within the band that contains the highest level of the desired power, based on either an RF conducted or a radiated measurement, provided that the transmitter demonstrates compliance with the peak conducted power limits. If the transmitter complies with the conducted power limits based on the use of root-mean-square averaging over a time interval, as permitted under section 5.4(d), the attenuation required shall be 30 dB instead of 20 dB. Attenuation below the general field strength limits specified in RSS-Gen is not required

### 3.2.2 EUT Setup

Below 1GHz:

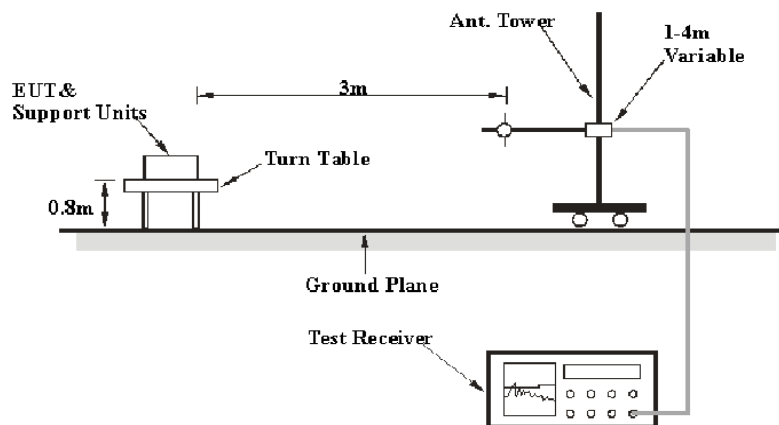

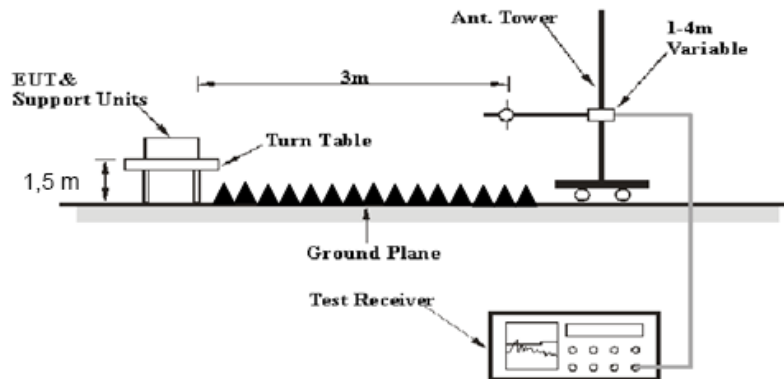
**Above 1GHz:**

The radiated emissions were performed in the 3 meters distance, using the setup accordance with the ANSI C63.10-2013. The specification used was the FCC 15.209, and FCC 15.247, RSS-247, RSS-Gen limits.

The external I/O cables were draped along the test table and formed a bundle 30 to 40 cm long in the middle.

The spacing between the peripherals was 10 cm.

**3.2.3 EMI Test Receiver & Spectrum Analyzer Setup**

During the radiated emission test, the EMI test receiver & Spectrum Analyzer Setup were set with the following configurations:

Frequency Range	RBW	Video B/W	IF B/W	Measurement
30 MHz – 1000 MHz	120 kHz	300 kHz	120 kHz	QP
Above 1 GHz	1MHz	3 MHz	/	PK
	1MHz	10 Hz	/	AV

If the maximized peak measured value complies with under the QP/Average limit more than 6dB, then it is unnecessary to perform an QP/Average measurement.

**3.2.4 Test Procedure**

Maximizing procedure was performed on the highest emissions to ensure that the EUT complied with all installation combinations.

Data was recorded in Quasi-peak detection mode for frequency range of 30 MHz-1 GHz, peak and Average detection modes for frequencies above 1 GHz.

**3.2.5 Corrected Amplitude & Margin Calculation**

The basic equation is as follows:

Result = Reading + Factor

Factor = Antenna Factor + Cable Loss- Amplifier Gain

The “**Margin**” column of the following data tables indicates the degree of compliance within the applicable limit. The equation for margin calculation is as follows:

$$\text{Margin} = \text{Limit} - \text{Result}$$



### 3.3 20 dB Bandwidth

#### 3.3.1 Applicable Standard

FCC §15.247 (a)(1)

Frequency hopping systems shall have hopping channel carrier frequencies separated by a minimum of 25 kHz or the 20 dB bandwidth of the hopping channel, whichever is greater. Alternatively, frequency hopping systems operating in the 2400-2483.5 MHz band may have hopping channel carrier frequencies that are separated by 25 kHz or two-thirds of the 20 dB bandwidth of the hopping channel, whichever is greater, provided the systems operate with an output power no greater than 125 mW. The system shall hop to channel frequencies that are selected at the system hopping rate from a pseudo randomly ordered list of hopping frequencies. Each frequency must be used equally on the average by each transmitter. The system receivers shall have input bandwidths that match the hopping channel bandwidths of their corresponding transmitters and shall shift frequencies in synchronization with the transmitted signals.

RSS-247 Clause 5.1 b)

- b) FHSs shall have hopping channel carrier frequencies separated by a minimum of 25 kHz or the 20 dB bandwidth of the hopping channel, whichever is greater. Alternatively, FHSs operating in the band 2400-2483.5 MHz may have hopping channel carrier frequencies that are separated by 25 kHz or two thirds of the 20 dB bandwidth of the hopping channel, whichever is greater, provided that the systems operate with an output power no greater than 0.125 W.

#### 3.3.2 EUT Setup

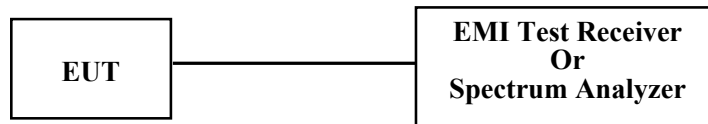

#### 3.3.3 Test Procedure

Check the calibration of the measuring instrument using either an internal calibrator or a known signal from an external generator.

Position the EUT on the test table without connection to measurement instrument. Turn on the EUT. Then set it to any one convenient frequency within its operating range. Set a reference level on the measuring instrument equal to the highest peak value.

Measure the frequency difference of two frequencies that were attenuated 20 dB from the reference level.

Record the frequency difference as the emission bandwidth.

Repeat above procedures until all frequencies measured were complete.

### 3.4 99% Occupied Bandwidth:

#### 3.4.1 Applicable Standard

RSS-Gen Clause 6.7

The occupied bandwidth or the “99% emission bandwidth” is defined as the frequency range between two points, one above and the other below the carrier frequency, within which 99% of the total transmitted power of the fundamental transmitted emission is contained. The occupied bandwidth shall be reported for all equipment in addition to the specified bandwidth required in the applicable RSSs.

In some cases, the “x dB bandwidth” is required, which is defined as the frequency range between two points, one at the lowest frequency below and one at the highest frequency above the carrier frequency, at which the maximum power level of the transmitted emission is attenuated x dB below the maximum in-band power level of the modulated signal, where the two points are on the outskirts of the in-band emission.

The following conditions shall be observed for measuring the occupied bandwidth and x dB bandwidth:

- The transmitter shall be operated at its maximum carrier power measured under normal test conditions.
- The span of the spectrum analyzer shall be set large enough to capture all products of the modulation process, including the emission skirts, around the carrier frequency, but small enough to avoid having other emissions (e.g. on adjacent channels) within the span.
- The detector of the spectrum analyzer shall be set to “Sample”. However, a peak, or peak hold, may be used in place of the sampling detector since this usually produces a wider bandwidth than the actual bandwidth (worst-case measurement). Use of a peak hold (or “Max Hold”) may be necessary to determine the occupied / x dB bandwidth if the device is not transmitting continuously.
- The resolution bandwidth (RBW) shall be in the range of 1% to 5% of the actual occupied / x dB bandwidth and the video bandwidth (VBW) shall not be smaller than three times the RBW value. Video averaging is not permitted.

Note: It may be necessary to repeat the measurement a few times until the RBW and VBW are in compliance with the above requirement.

For the 99% emission bandwidth, the trace data points are recovered and directly summed in linear power level terms. The recovered amplitude data points, beginning at the lowest frequency, are placed in a running sum until 0.5% of the total is reached, and that frequency recorded. The process is repeated for the highest frequency data points (starting at the highest frequency, at the right side of the span, and going down in frequency). This frequency is then recorded. The difference between the two recorded frequencies is the occupied bandwidth (or the 99% emission bandwidth).

#### 3.4.2 EUT Setup



### 3.4.3 Test Procedure

Check the calibration of the measuring instrument using either an internal calibrator or a known signal from an external generator.

Position the EUT on the test table without connection to measurement instrument. Turn on the EUT. Then set it to any one convenient frequency within its operating range. Set a reference level on the measuring instrument equal to the highest peak value.

Measure the frequency difference of two frequencies that were attenuated 20 dB from the reference level.

Record the frequency difference as the emission bandwidth.

Use Occupied bandwidth test function, measure the 99% Occupied bandwidth.

Repeat above procedures until all frequencies measured were complete.

### 3.5 Channel Separation

#### 3.5.1 Applicable Standard

FCC §15.247 (a)(1)

Frequency hopping systems shall have hopping channel carrier frequencies separated by a minimum of 25 kHz or the 20 dB bandwidth of the hopping channel, whichever is greater. Alternatively, frequency hopping systems operating in the 2400-2483.5 MHz band may have hopping channel carrier frequencies that are separated by 25 kHz or two-thirds of the 20 dB bandwidth of the hopping channel, whichever is greater, provided the systems operate with an output power no greater than 125 mW. The system shall hop to channel frequencies that are selected at the system hopping rate from a pseudo randomly ordered list of hopping frequencies. Each frequency must be used equally on the average by each transmitter. The system receivers shall have input bandwidths that match the hopping channel bandwidths of their corresponding transmitters and shall shift frequencies in synchronization with the transmitted signals.

RSS-247 Clause 5.1 b)

Frequency hopping systems shall have hopping channel carrier frequencies separated by a minimum of 25 kHz or the 20dB bandwidth of the hopping channel, whichever is greater. Alternatively, frequency hopping systems operating in the 2400-2483.50 MHz band may have hopping channel carrier frequencies that are separated by 25 kHz or two-thirds of the 20dB bandwidth of the hopping channel, whichever is greater provided the systems operate with an output power no greater than 125 mW.

#### 3.5.2 EUT Setup



#### 3.5.3 Test Procedure

According to ANSI C63.10-2013 Section 7.8.2

The EUT shall have its hopping function enabled. Use the following spectrum analyzer settings:

- a) Span: Wide enough to capture the peaks of two adjacent channels.
- b) RBW: Start with the RBW set to approximately 30% of the channel spacing; adjust as necessary to best identify the center of each individual channel.
- c) Video (or average) bandwidth (VBW)  $\geq$  RBW.
- d) Sweep: Auto.
- e) Detector function: Peak.
- f) Trace: Max hold.
- g) Allow the trace to stabilize.

Use the marker-delta function to determine the separation between the peaks of the adjacent channels. Compliance of an EUT with the appropriate regulatory limit shall be determined. A plot of the data shall be included in the test report.

### 3.6 Number Of Hopping Frequency

#### 3.6.1 Applicable Standard

FCC §15.247 (a)(1)(iii)

Frequency hopping systems in the 2400–2483.5 MHz band shall use at least 15 channels. The average time of occupancy on any channel shall not be greater than 0.4 seconds within a period of 0.4 seconds multiplied by the number of hopping channels employed. Frequency hopping systems may avoid or suppress transmissions on a particular hopping frequency provided that a minimum of 15 channels are used.

RSS-247 Clause 5.1 d)

Frequency hopping systems in the 2400–2483.5 MHz band shall use at least 15 channels. The average time of occupancy on any channel shall not be greater than 0.4 seconds within a period of 0.4 seconds multiplied by the number of hopping channels employed. Frequency hopping systems may avoid or suppress transmissions on a particular hopping frequency provided that a minimum of 15 channels are used.

#### 3.6.2 EUT Setup

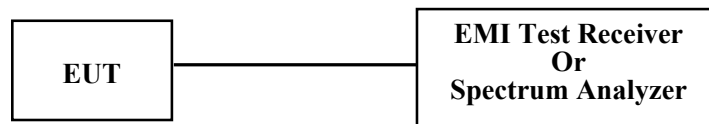

#### 3.6.3 Test Procedure

According to ANSI C63.10-2013 Section 7.8.3

The EUT shall have its hopping function enabled. Use the following spectrum analyzer settings:

- a) Span: The frequency band of operation. Depending on the number of channels the device supports, it may be necessary to divide the frequency range of operation across multiple spans, to allow the individual channels to be clearly seen.
- b) RBW: To identify clearly the individual channels, set the RBW to less than 30% of the channel spacing or the 20 dB bandwidth, whichever is smaller.
- c) VBW  $\geq$  RBW.
- d) Sweep: Auto.
- e) Detector function: Peak.
- f) Trace: Max hold.
- g) Allow the trace to stabilize

It might prove necessary to break the span up into subranges to show clearly all of the hopping frequencies. Compliance of an EUT with the appropriate regulatory limit shall be determined for the number of hopping channels. A plot of the data shall be included in the test report.

### 3.7 Time Of Occupancy(Dwell Time)

#### 3.7.1 Applicable Standard

FCC §15.247 (a)(1)(iii)

Frequency hopping systems in the 2400-2483.5 MHz shall use at least 15 channels. The average time of occupancy on any channel shall not be greater than 0.4 seconds within a period of 0.4 seconds multiplied by the number of hopping channels employed. Frequency hopping systems may avoid or suppress transmissions on a particular hopping frequency provided that a minimum of 15 channels are used.

RSS-247 Clause 5.1 d)

Frequency hopping systems in the 2400–2483.5 MHz band shall use at least 15 channels. The average time of occupancy on any channel shall not be greater than 0.4 seconds within a period of 0.4 seconds multiplied by the number of hopping channels employed. Frequency hopping systems may avoid or suppress transmissions on a particular hopping frequency provided that a minimum of 15 channels are used.

#### 3.7.2 EUT Setup

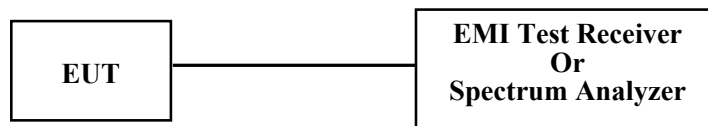

#### 3.7.3 Test Procedure

The EUT was worked in channel hopping; the time of single pulses was tested.

### 3.8 Peak Output Power

#### 3.8.1 Applicable Standard

FCC §15.247 (b)(1)

For frequency hopping systems operating in the 2400–2483.5 MHz band employing at least 75 non-overlapping hopping channels, and all frequency hopping systems in the 5725-5850 MHz band: 1 watt. For all other frequency hopping systems in the 2400–2483.5 MHz band: 0.125 watts

According to RSS-247 Clause 5.4 b)

- b) For FHSs operating in the band 2400-2483.5 MHz, the maximum peak conducted output power shall not exceed 1.0 W if the hopset uses 75 or more hopping channels; the maximum peak conducted output power shall not exceed 0.125 W if the hopset uses less than 75 hopping channels. The e.i.r.p. shall not exceed 4 W, except as provided in section 5.4(e).

#### 3.8.2 EUT Setup

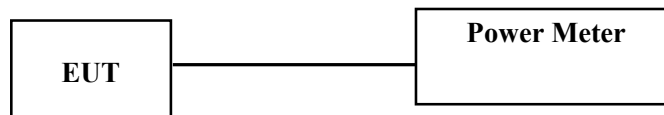

#### 3.8.3 Test Procedure

1. Remove the antenna from the EUT and then connect a low loss RF cable from the antenna port to one test equipment.
2. Add a correction factor to the display.

### 3.9 100 kHz Bandwidth of Frequency Band Edge

#### 3.9.1 Applicable Standard

FCC §15.247 (d);

In any 100 kHz bandwidth outside the frequency band in which the spread spectrum or digitally modulated intentional radiator is operating, the radio frequency power that is produced by the intentional radiator shall be at least 20 dB below that in the 100 kHz bandwidth within the band that contains the highest level of the desired power, based on either an RF conducted or a radiated measurement, provided the transmitter demonstrates compliance with the peak conducted power limits. If the transmitter complies with the conducted power limits based on the use of RMS averaging over a time interval, as permitted under paragraph (b)(3) of this section, the attenuation required under this paragraph shall be 30 dB instead of 20 dB. Attenuation below the general limits specified in §15.209(a) is not required. In addition, radiated emissions which fall in the restricted bands, as defined in §15.205(a), must also comply with the radiated emission limits specified in §15.209(a) (see §15.205(c)).

According to RSS-247 Clause 5.5

In any 100 kHz bandwidth outside the frequency band in which the spread spectrum or digitally modulated device is operating, the RF power that is produced shall be at least 20 dB below that in the 100 kHz bandwidth within the band that contains the highest level of the desired power, based on either an RF conducted or a radiated measurement, provided that the transmitter demonstrates compliance with the peak conducted power limits. If the transmitter complies with the conducted power limits based on the use of root-mean-square averaging over a time interval, as permitted under section 5.4(d), the attenuation required shall be 30 dB instead of 20 dB. Attenuation below the general field strength limits specified in RSS-Gen is not required.

#### 3.9.2 EUT Setup

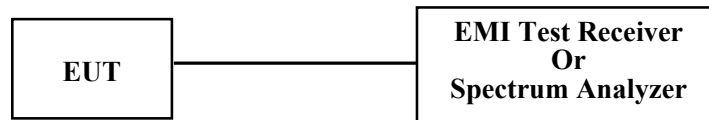

#### 3.9.3 Test Procedure

- a) Set the center frequency and span to encompass frequency range to be measured.
- b) Set the RBW = 100 kHz.
- c) Set the VBW  $\geq [3 \times \text{RBW}]$ .
- d) Detector = peak.
- e) Sweep time = auto couple.
- f) Trace mode = max hold.
- g) Allow trace to fully stabilize.
- h) Use the peak marker function to determine the maximum amplitude level.

Ensure that the amplitude of all unwanted emissions outside of the authorized frequency band (excluding restricted frequency bands) is attenuated by at least the minimum requirements specified in 11.11. Report the three highest emissions relative to the limit.



### 3.10 Antenna Requirement

#### 3.10.1 Applicable Standard

FCC §15.203

An intentional radiator shall be designed to ensure that no antenna other than that furnished by the responsible party shall be used with the device. The use of a permanently attached antenna or of an antenna that uses a unique coupling to the intentional radiator shall be considered sufficient to comply with the provisions of this section. The manufacturer may design the unit so that a broken antenna can be replaced by the user, but the use of a standard antenna jack or electrical connector is prohibited. This requirement does not apply to carrier current devices or to devices operated under the provisions of §§15.211, 15.213, 15.217, 15.219, 15.221, or §15.236. Further, this requirement does not apply to intentional radiators that must be professionally installed, such as perimeter protection systems and some field disturbance sensors, or to other intentional radiators which, in accordance with §15.31(d), must be measured at the installation site. However, the installer shall be responsible for ensuring that the proper antenna is employed so that the limits in this part are not exceeded.

RSS-Gen §6.8

The applicant for equipment certification shall provide a list of all antenna types that may be used with the transmitter, where applicable (i.e. for transmitters with detachable antenna), indicating the maximum permissible antenna gain (in dBi) and the required impedance for each antenna. The test report shall demonstrate the compliance of the transmitter with the limit for maximum equivalent isotropically radiated power (e.i.r.p.) specified in the applicable RSS, when the transmitter is equipped with any antenna type, selected from this list.

For expediting the testing, measurements may be performed using only the antenna with highest gain of each combination of transmitter and antenna type, with the transmitter output power set at the maximum level. However, the transmitter shall comply with the applicable requirements under all operational conditions and when in combination with any type of antenna from the list provided in the test report (and in the notice to be included in the user manual, provided below).

When measurements at the antenna port are used to determine the RF output power, the effective gain of the device's antenna shall be stated, based on a measurement or on data from the antenna's manufacturer. The test report shall state the RF power, output power setting and spurious emission measurements with each antenna type that is used with the transmitter being tested.

For licence-exempt equipment with detachable antennas, the user manual shall also contain the following notice in a conspicuous location:

*This radio transmitter [enter the device's ISED certification number] has been approved by Innovation, Science and Economic Development Canada to operate with the antenna types listed below, with the maximum permissible gain indicated. Antenna types not included in this list that have a gain greater than the maximum gain indicated for any type listed are strictly prohibited for use with this device.*

Immediately following the above notice, the manufacturer shall provide a list of all antenna types which can be used with the transmitter, indicating the maximum permissible antenna gain (in dBi) and the required impedance for each antenna type.

#### 3.10.2 Judgment

Please refer to the Antenna Information detail in Section 1.

## 4. TEST DATA AND RESULTS

### 4.1 AC Line Conducted Emissions

Serial Number:	CR21090048-RF-S2	Test Date:	2021-11-20
Test Site:	CE	Test Mode:	Transmitting
Tester:	Nick Tang	Test Result:	Pass

Environmental Conditions:					
Temperature: (°C)	23.5	Relative Humidity: (%)	70	ATM Pressure: (kPa)	100.7

#### Test Equipment List and Details:

Manufacturer	Description	Model	Serial Number	Calibration Date	Calibration Due Date
R&S	LISN	ENV216	101132	2021-04-25	2022-04-24
R&S	EMI Test Receiver	ESR3	102726	2021-07-22	2022-07-21
MICRO-COAX	Coaxial Cable	UTIFLEX	C-0200-01	2021-08-08	2022-08-07
Audix	Test Software	E3	190306 (V9)	N/A	N/A

\* Statement of Traceability: China Certification ICT Co., Ltd (Dongguan) attests that all calibrations have been performed, traceable to National Primary Standards and International System of Units (SI).

Line:

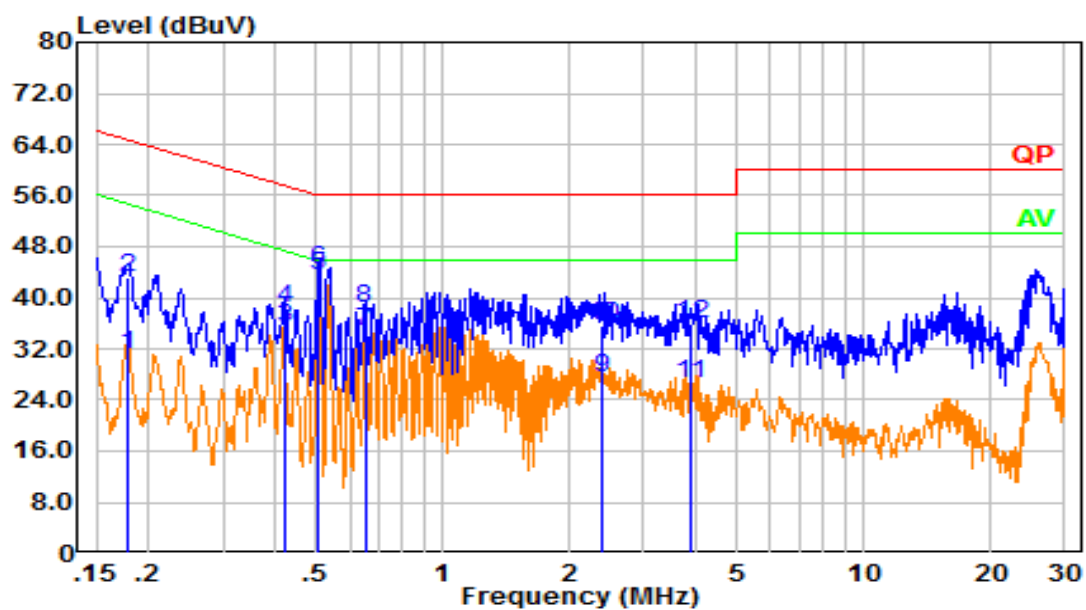

No.	Frequency (MHz)	Reading (dB $\mu$ V)	Factor (dB)	Result (dB $\mu$ V)	Limit (dB $\mu$ V)	Margin (dB)	Detector
1	0.179	21.51	9.61	31.12	54.53	23.41	Average
2	0.179	33.50	9.61	43.11	64.53	21.41	QP
3	0.419	25.65	9.61	35.26	47.46	12.20	Average
4	0.419	28.60	9.61	38.21	57.46	19.25	QP
5	0.506	33.75	9.61	43.36	46.00	2.64	Average
6	0.506	34.64	9.61	44.25	56.00	11.75	QP
7	0.652	25.02	9.62	34.64	46.00	11.36	Average
8	0.652	28.60	9.62	38.22	56.00	17.78	QP
9	2.396	17.92	9.64	27.56	46.00	18.44	Average
10	2.396	25.99	9.64	35.63	56.00	20.37	QP
11	3.863	16.89	9.65	26.54	46.00	19.46	Average
12	3.863	26.32	9.65	35.97	56.00	20.03	QP

Neutral:

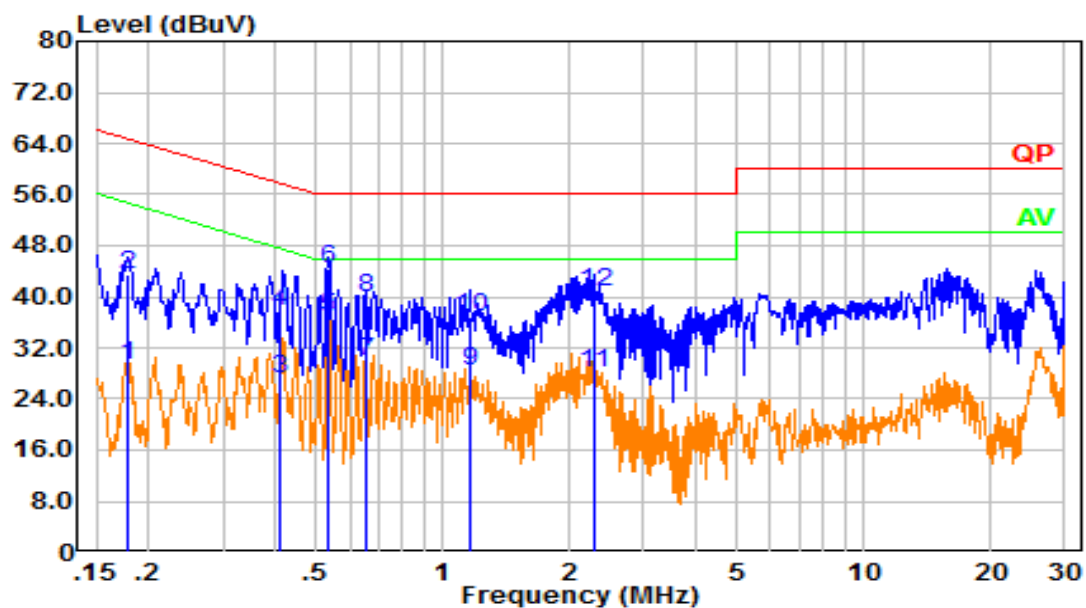

No.	Frequency (MHz)	Reading (dB $\mu$ V)	Factor (dB)	Result (dB $\mu$ V)	Limit (dB $\mu$ V)	Margin (dB)	Detector
1	0.178	19.65	9.61	29.26	54.56	25.30	Average
2	0.178	33.98	9.61	43.59	64.56	20.97	QP
3	0.409	17.57	9.61	27.18	47.67	20.49	Average
4	0.409	27.99	9.61	37.60	57.67	20.07	QP
5	0.535	27.16	9.61	36.78	46.00	9.22	Average
6	0.535	34.86	9.61	44.47	56.00	11.53	QP
7	0.657	20.19	9.62	29.81	46.00	16.19	Average
8	0.657	30.22	9.62	39.84	56.00	16.16	QP
9	1.157	18.84	9.62	28.46	46.00	17.54	Average
10	1.157	27.20	9.62	36.83	56.00	19.17	QP
11	2.284	18.45	9.64	28.08	46.00	17.92	Average
12	2.284	31.18	9.64	40.82	56.00	15.18	QP

## 4.2 Radiation Spurious Emissions

Serial Number:	CR21090047-RF-S1	Test Date:	2021-10-18~2021-11-17
Test Site:	966-1/966-2	Test Mode:	Transmitting
Tester:	Tommy Luo, Great Qiao	Test Result:	Pass

### Environmental Conditions:

Temperature: (°C)	23.5~25.5	Relative Humidity: (%)	56~64	ATM Pressure: (kPa)	101.5~101.6
----------------------	-----------	------------------------------	-------	------------------------	-------------

### Test Equipment List and Details:

Manufacturer	Description	Model	Serial Number	Calibration Date	Calibration Due Date
Sunol Sciences	Antenna	JB6	A082520-5	2020-10-19	2023-10-18
R&S	EMI Test Receiver	ESR3	102724	2021-07-22	2022-07-21
TIMES MICROWAVE	Coaxial Cable	LMR-600-UltraFlex	C-0470-02	2021-07-18	2022-07-17
TIMES MICROWAVE	Coaxial Cable	LMR-600-UltraFlex	C-0780-01	2021-07-18	2022-07-17
Sonoma	Amplifier	310N	186165	2021-07-18	2022-07-17
Audix	Test Software	E3	201021 (V9)	N/A	N/A
ETS-Lindgren	Horn Antenna	3115	9912-5985	2020-10-13	2023-10-12
PASTERNAK	Horn Antenna	PE9852/2F-20	112002	2021-02-05	2023-02-04
R&S	Spectrum Analyzer	FSV40	101591	2021-07-22	2022-07-21
MICRO-COAX	Coaxial Cable	UFA210A-1-1200-70U300	217423-008	2021-08-08	2022-08-07
MICRO-COAX	Coaxial Cable	UFA210A-1-2362-300300	235780-001	2021-08-08	2022-08-07
MICRO-COAX	Coaxial Cable	UFB142A-1-2362-200200	235772-001	2021-08-08	2022-08-07
Mini	Pre-amplifier	ZVA-183-S+	5969001149	2021-11-10	2022-11-09
AH	Preamplifier	PAM-1840VH	190	2020-11-20	2021-11-19
E-Microwave	Band Rejection Filter	2400-2483.5MHz	OE01902424	2021-08-08	2022-08-07
Mini Circuits	High Pass Filter	VHF-6010+	31119	2021-08-08	2022-08-07

\* Statement of Traceability: China Certification ICT Co., Ltd (Dongguan) attests that all calibrations have been performed, traceable to National Primary Standards and International System of Units (SI).

1) 30MHz-1GHz(Low channel was the worst)

Horizontal:

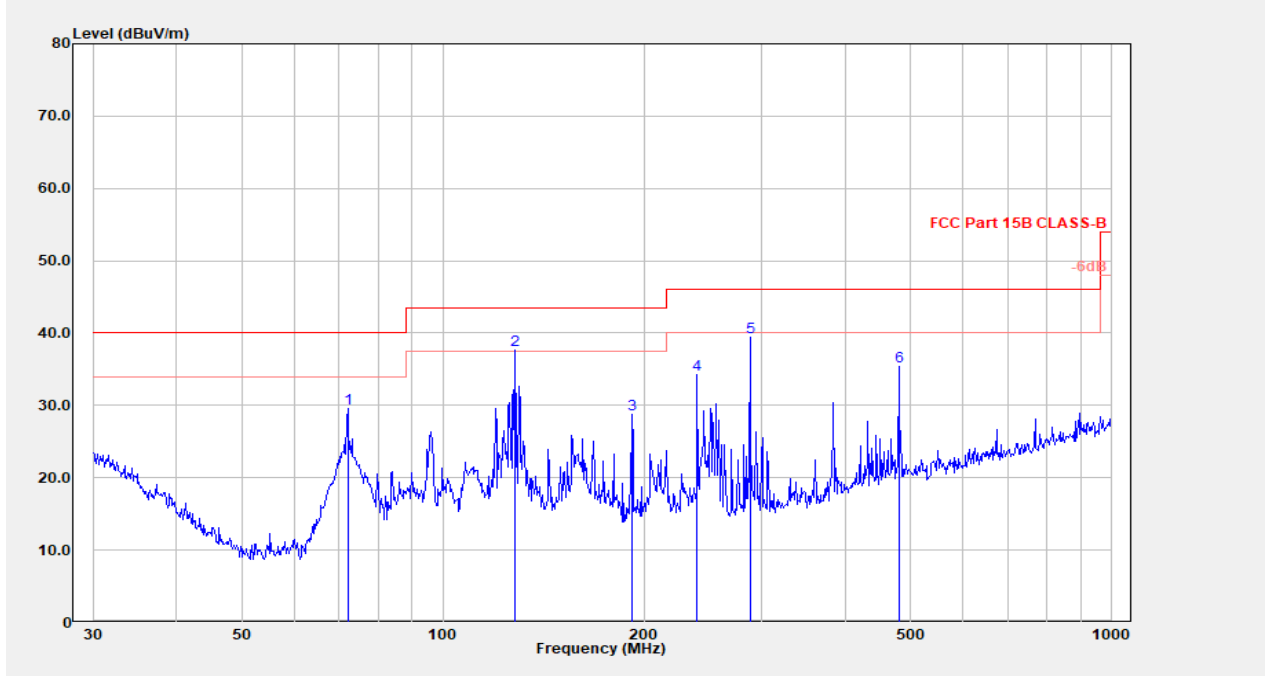

No.	Frequency (MHz)	Reading (dBμV)	Factor (dB/m)	Result (dBμV/m)	Limit (dBμV/m)	Margin (dB)	Detector
1	72.084	46.44	-16.93	29.51	40.00	10.49	Peak
2	128.113	49.12	-11.52	37.60	43.50	5.90	QP
3	191.745	42.18	-13.38	28.80	43.50	14.70	Peak
4	239.987	47.48	-13.17	34.31	46.00	11.69	Peak
5	287.990	50.74	-11.34	39.40	46.00	6.60	Peak
6	480.528	41.82	-6.49	35.33	46.00	10.67	Peak

**Vertical:**

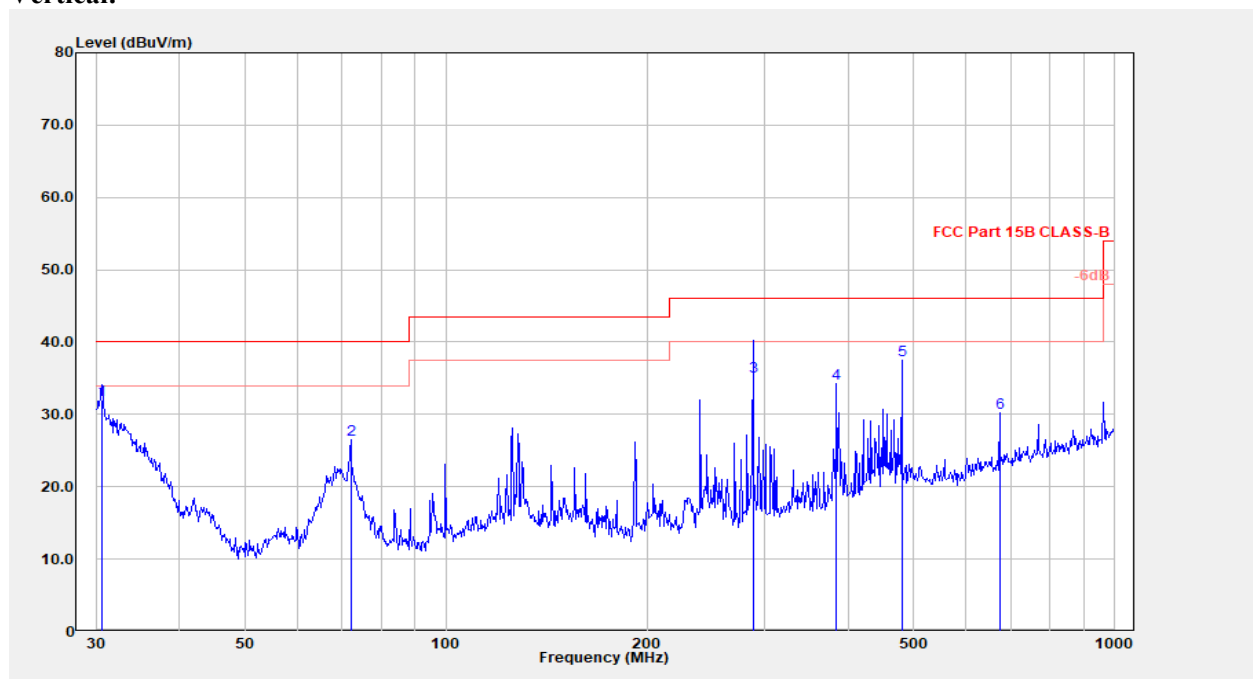

No.	Frequency (MHz)	Reading (dBμV)	Factor (dB/m)	Result (dBμV/m)	Limit (dBμV/m)	Margin (dB)	Detector
1	30.638	36.32	-4.28	32.04	40.00	7.96	QP
2	72.084	43.36	-16.93	26.43	40.00	13.57	Peak
3	287.990	46.63	-11.34	35.29	46.00	10.71	QP
4	383.932	43.46	-9.26	34.20	46.00	11.80	Peak
5	480.528	43.96	-6.49	37.47	46.00	8.53	Peak
6	672.845	34.55	-4.28	30.27	46.00	15.73	Peak

**2) 1-25GHz:***BDR Mode(GFSK) was the worst:*

Frequency (MHz)	Receiver		Polar (H/V)	Factor (dB/m)	Result (dBµV/m)	Limit (dBµV/m)	Margin (dB)
	Reading (dBµV)	Detector					
Low Channel: 2402 MHz							
2402.00	55.94	PK	H	31.51	87.45	N/A	N/A
2402.00	49.96	AV	H	31.51	81.47	N/A	N/A
2402.00	49.52	PK	V	31.51	81.03	N/A	N/A
2402.00	43.78	AV	V	31.51	75.29	N/A	N/A
2390.00	27.72	PK	H	31.46	59.18	74.00	14.82
2390.00	13.89	AV	H	31.46	45.35	54.00	8.65
4804.00	34.85	PK	H	10.91	45.76	74.00	28.24
4804.00	22.64	AV	H	10.91	33.55	54.00	20.45
7206.00	34.43	PK	H	14.22	48.65	74.00	25.35
7206.00	22.17	AV	H	14.22	36.39	54.00	17.61
Middle Channel: 2441 MHz							
2441.00	55.33	PK	H	31.61	86.94	N/A	N/A
2441.00	49.52	AV	H	31.61	81.13	N/A	N/A
2441.00	49.15	PK	V	31.61	80.76	N/A	N/A
2441.00	43.47	AV	V	31.61	75.08	N/A	N/A
4882.00	34.64	PK	H	11.07	45.71	74.00	28.29
4882.00	22.37	AV	H	11.07	33.44	54.00	20.56
7323.00	35.02	PK	H	14.80	49.82	74.00	24.18
7323.00	23.14	AV	H	14.80	37.94	54.00	16.06
High Channel: 2480 MHz							
2480.00	53.57	PK	H	31.64	85.21	N/A	N/A
2480.00	47.93	AV	H	31.64	79.57	N/A	N/A
2480.00	48.20	PK	V	31.64	79.84	N/A	N/A
2480.00	42.59	AV	V	31.64	74.23	N/A	N/A
2483.50	28.04	PK	H	31.64	59.68	74.00	14.32
2483.50	14.30	AV	H	31.64	45.94	54.00	8.06
4960.00	36.29	PK	H	11.23	47.52	74.00	26.48
4960.00	24.55	AV	H	11.23	35.78	54.00	18.22
7440.00	33.80	PK	H	15.26	49.06	74.00	24.94
7440.00	21.69	AV	H	15.26	36.95	54.00	17.05



**Worst Test plots(GFSK Middle channel was the worst)**  
**Horizontal:**

Fundamental  
 Test with Band  
 Rejection Filter

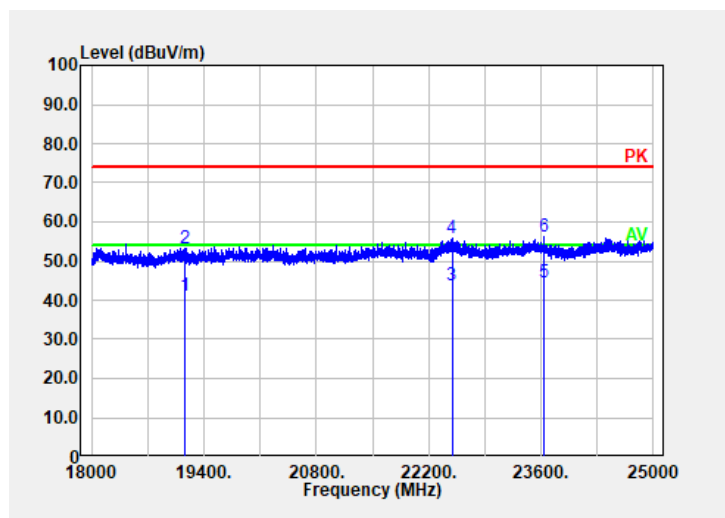
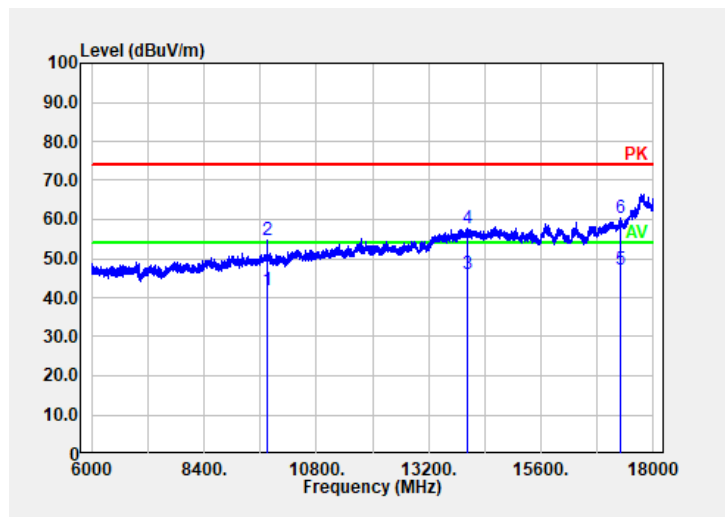
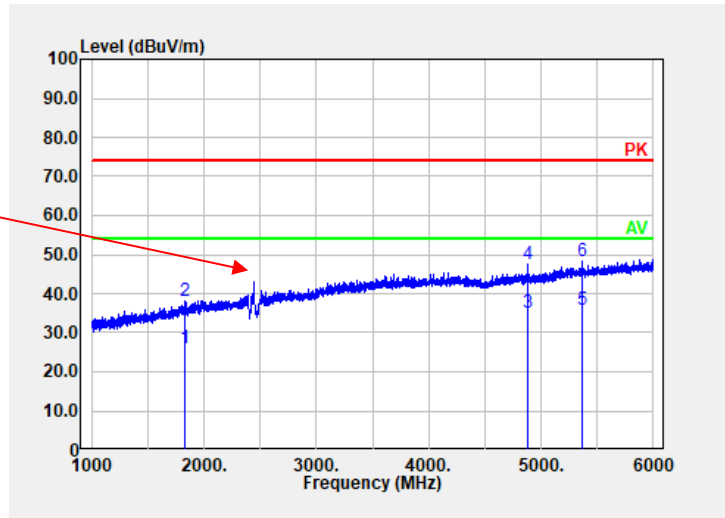

Vertical:

Fundamental  
Test with Band  
Rejection Filter

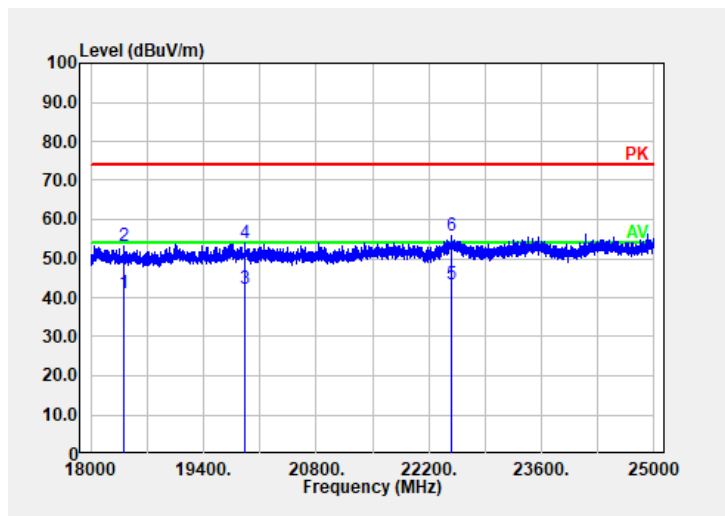
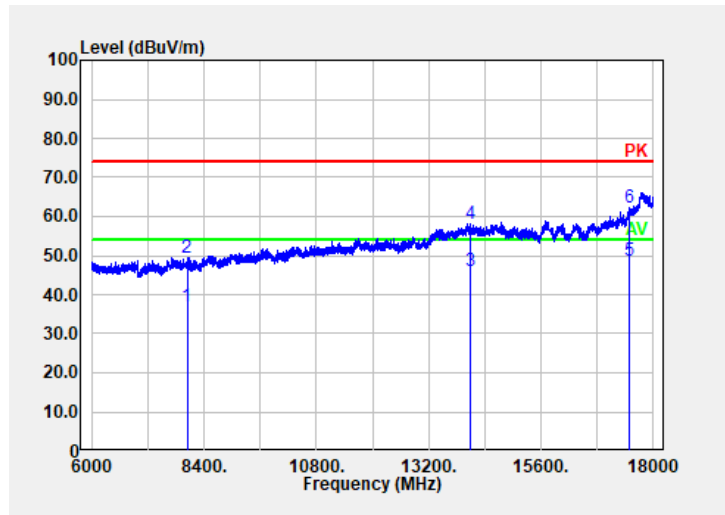
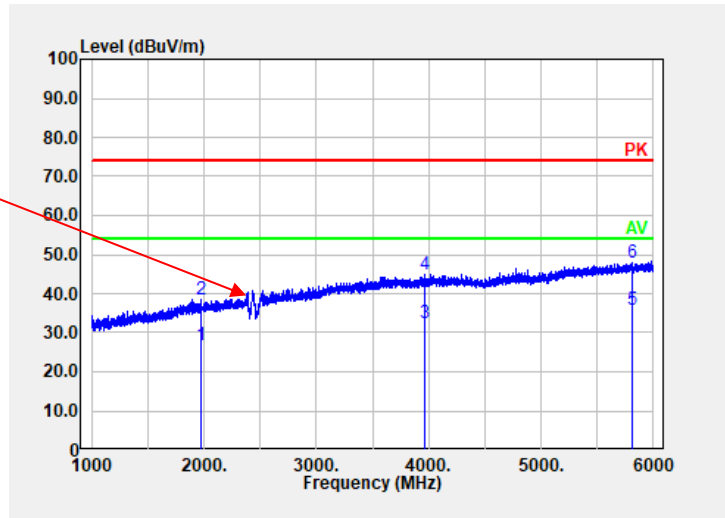

**4.3 20 dB Emission Bandwidth:**

Serial Number:	CR21090047-RF-S1	Test Date:	2021/9/30
Test Site:	RF	Test Mode:	Transmitting
Tester:	Le Qiao	Test Result:	Pass

**Environmental Conditions:**

Temperature: (°C)	28.1	Relative Humidity: (%)	52	ATM Pressure: (kPa)	100.1
----------------------	------	------------------------------	----	------------------------	-------

**Test Equipment List and Details:**

Manufacturer	Description	Model	Serial Number	Calibration Date	Calibration Due Date
R&S	Spectrum Analyzer	FSV40	101474	2021-07-22	2022-07-21
Mini-Circuits	DC Block	BLK-18-S+	1554403	Each time	N/A
zhuoxiang	Coaxial Cable	SMA-178	211001	Each time	N/A

\* Statement of Traceability: China Certification ICT Co., Ltd (Dongguan) attests that all calibrations have been performed, traceable to National Primary Standards and International System of Units (SI).

**Test Data:**

Test Modes	Test Channel	Test Frequency (MHz)	20 dB Bandwidth (MHz)
BDR Mode (GFSK)	Lowest	2402	0.884
	Middle	2441	0.884
	Highest	2480	0.888
EDR Mode ( $\pi/4$ -DQPSK)	Lowest	2402	1.248
	Middle	2441	1.248
	Highest	2480	1.252
EDR Mode (8DPSK)	Lowest	2402	1.220
	Middle	2441	1.220
	Highest	2480	1.220

**BDR Mode (GFSK)**

<p>Lowest Channel</p>	<p>CF 2.402 GHz 501 pts Span 2.0 MHz</p> <p>Date: 30.SEP.2021 18:43:49</p>
<p>Middle Channel</p>	<p>CF 2.441 GHz 501 pts Span 2.0 MHz</p> <p>Date: 30.SEP.2021 18:46:15</p>
<p>Highest Channel</p>	<p>CF 2.48 GHz 501 pts Span 2.0 MHz</p> <p>Date: 30.SEP.2021 18:48:25</p>

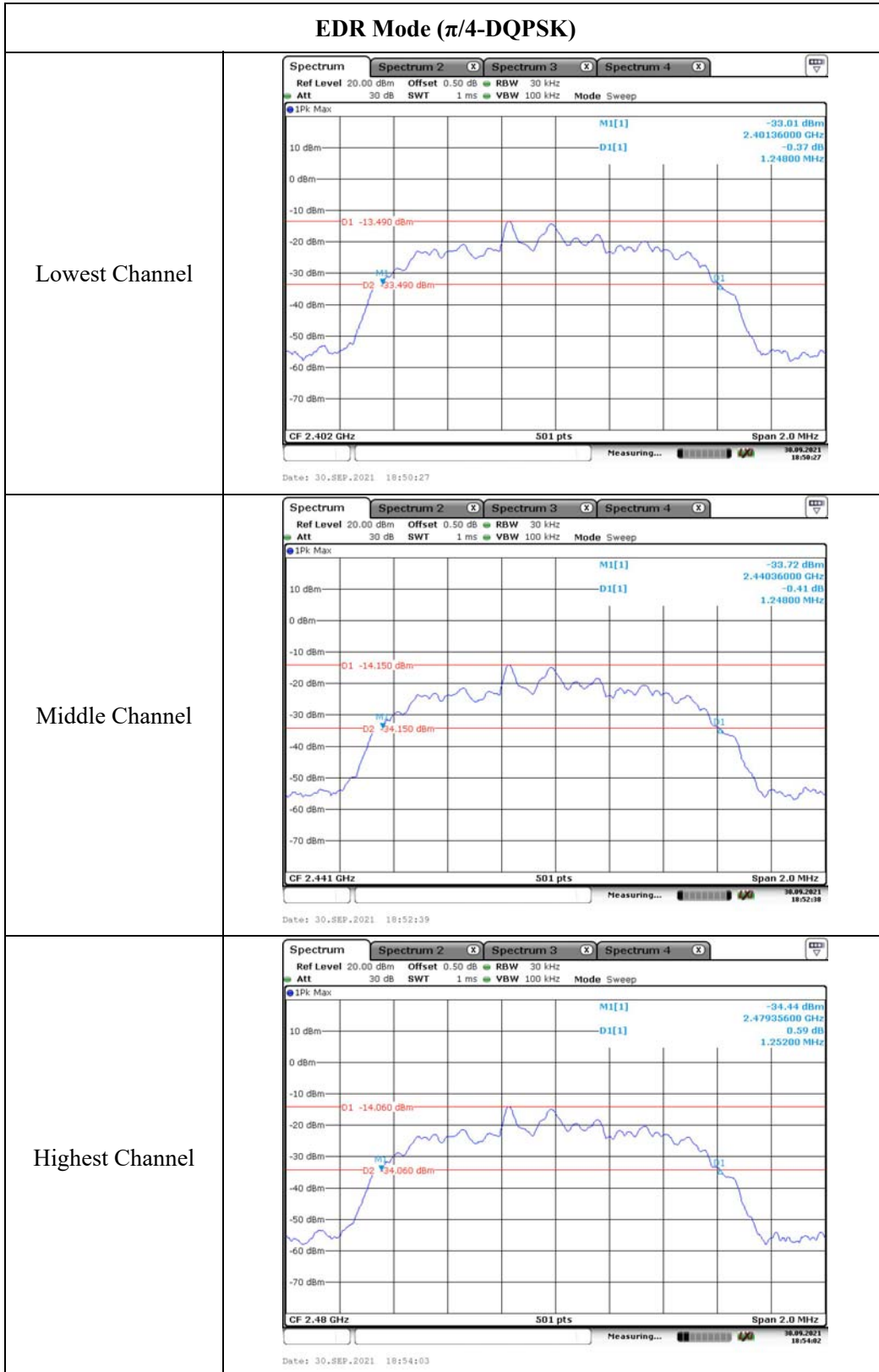

**EDR Mode (8DPSK)**

<p>Lowest Channel</p>	<p>Spectrum 2 Spectrum 3 Spectrum 4</p> <p>Ref Level 20.00 dBm Offset 0.50 dB RBW 30 kHz Att 30 dB SWT 1 ms VBW 100 kHz Mode Sweep</p> <p>1Pk Max</p> <p>M1[1] -33.50 dBm D1[1] 2.40139200 GHz 0.19 dB 1.22000 MHz</p> <p>D1 -13.390 dBm D2 -33.390 dBm</p> <p>CF 2.402 GHz 501 pts Span 2.0 MHz</p> <p>Date: 30.SEP.2021 18:55:52</p>
<p>Middle Channel</p>	<p>Spectrum 2 Spectrum 3 Spectrum 4</p> <p>Ref Level 20.00 dBm Offset 0.50 dB RBW 30 kHz Att 30 dB SWT 1 ms VBW 100 kHz Mode Sweep</p> <p>1Pk Max</p> <p>M1[1] -33.96 dBm D1[1] 2.44039200 GHz 0.08 dB 1.22000 MHz</p> <p>D1 -14.080 dBm D2 -33.080 dBm</p> <p>CF 2.441 GHz 501 pts Span 2.0 MHz</p> <p>Date: 30.SEP.2021 18:57:36</p>
<p>Highest Channel</p>	<p>Spectrum 2 Spectrum 3 Spectrum 4</p> <p>Ref Level 20.00 dBm Offset 0.50 dB RBW 30 kHz Att 30 dB SWT 1 ms VBW 100 kHz Mode Sweep</p> <p>1Pk Max</p> <p>M1[1] -33.75 dBm D1[1] 2.47939200 GHz -0.33 dB 1.22000 MHz</p> <p>D1 -14.010 dBm D2 -33.010 dBm</p> <p>CF 2.48 GHz 501 pts Span 2.0 MHz</p> <p>Date: 30.SEP.2021 18:59:23</p>

**4.4 99% Occupied Bandwidth:**

Serial Number:	CR21090047-RF-S1	Test Date:	2021/9/30
Test Site:	RF	Test Mode:	Transmitting
Tester:	Le Qiao	Test Result:	Pass

**Environmental Conditions:**

Temperature: (°C)	28.1	Relative Humidity: (%)	52	ATM Pressure: (kPa)	100.1
----------------------	------	------------------------------	----	------------------------	-------

**Test Equipment List and Details:**

Manufacturer	Description	Model	Serial Number	Calibration Date	Calibration Due Date
R&S	Spectrum Analyzer	FSV40	101474	2021-07-22	2022-07-21
Mini-Circuits	DC Block	BLK-18-S+	1554403	Each time	N/A
zhuoxiang	Coaxial Cable	SMA-178	211001	Each time	N/A

\* Statement of Traceability: China Certification ICT Co., Ltd (Dongguan) attests that all calibrations have been performed, traceable to National Primary Standards and International System of Units (SI).

**Test Data:**

Test Modes	Test Channel	Test Frequency (MHz)	99% Bandwidth (MHz)
BDR Mode (GFSK)	Lowest	2402	0.826
	Middle	2441	0.830
	Highest	2480	0.834
EDR Mode ( $\pi/4$ -DQPSK)	Lowest	2402	1.166
	Middle	2441	1.170
	Highest	2480	1.166
EDR Mode (8DPSK)	Lowest	2402	1.154
	Middle	2441	1.162
	Highest	2480	1.162

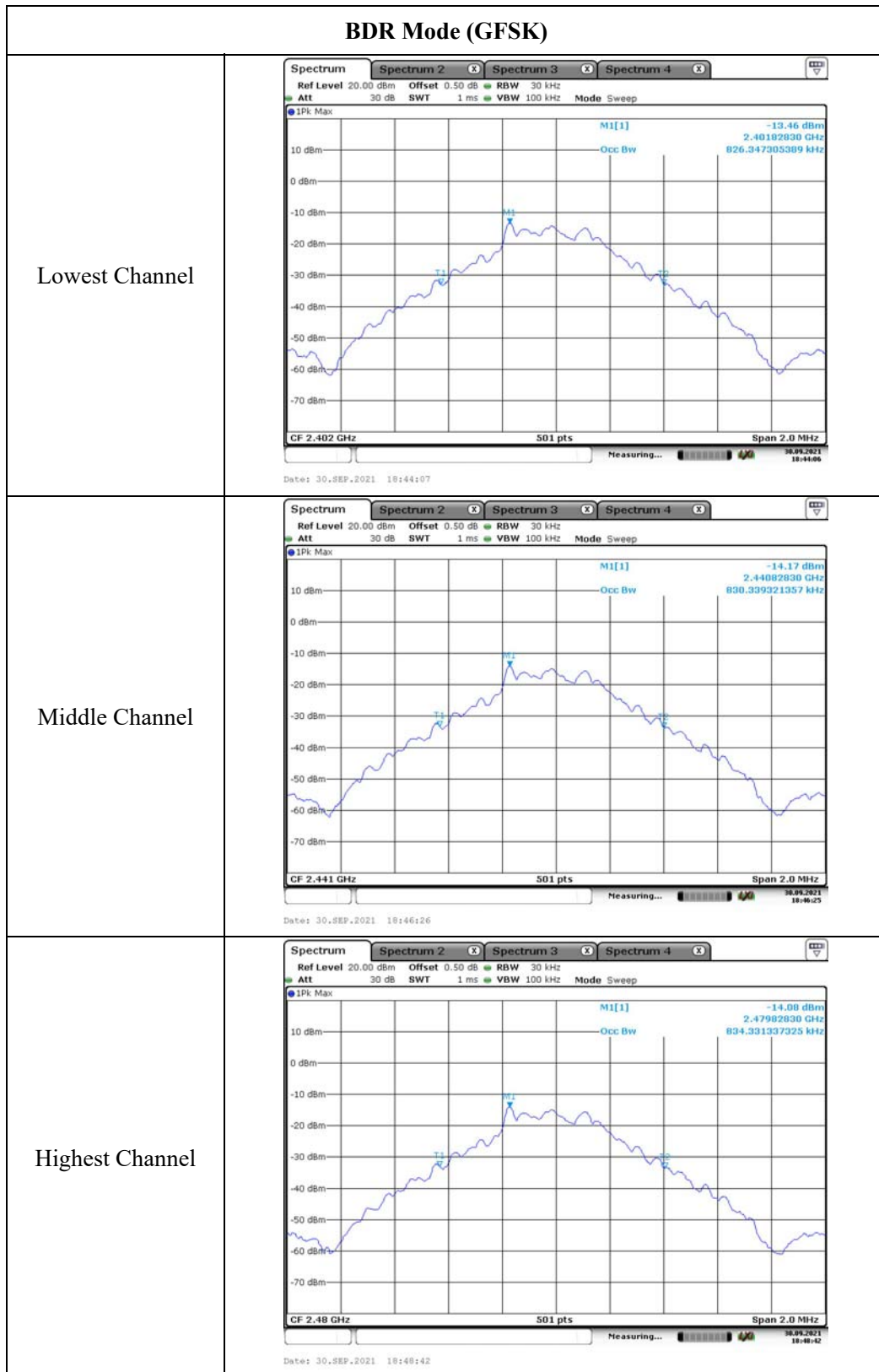

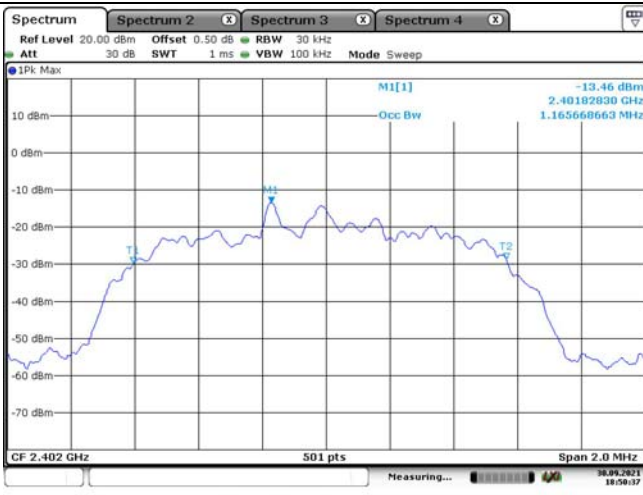
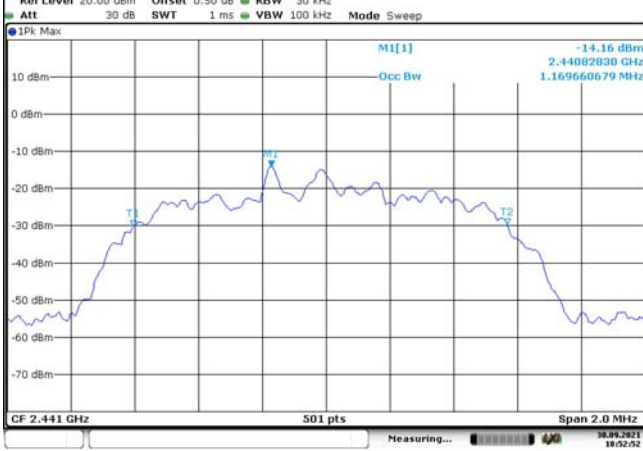
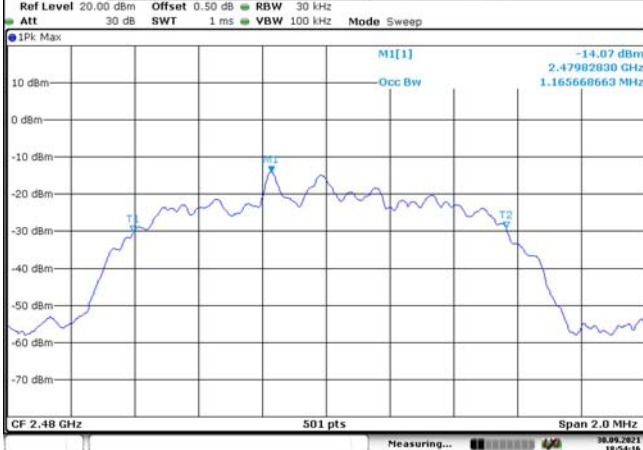

### EDR Mode ( $\pi/4$ -DQPSK)

Lowest Channel	 <p>Spectrum plot for the lowest channel. The plot shows a signal with a peak level of -13.46 dBm. The carrier frequency is 2.40182830 GHz and the span is 2.0 MHz. The plot includes markers for T1, M1, and T2, and a legend for M1[1] and Occ Bw.</p>
Middle Channel	 <p>Spectrum plot for the middle channel. The plot shows a signal with a peak level of -14.16 dBm. The carrier frequency is 2.44082830 GHz and the span is 2.0 MHz. The plot includes markers for T1, M1, and T2, and a legend for M1[1] and Occ Bw.</p>
Highest Channel	 <p>Spectrum plot for the highest channel. The plot shows a signal with a peak level of -14.07 dBm. The carrier frequency is 2.47982830 GHz and the span is 2.0 MHz. The plot includes markers for T1, M1, and T2, and a legend for M1[1] and Occ Bw.</p>

**EDR Mode (8DPSK)**

<p>Lowest Channel</p>	<p>Spectrum 2 Spectrum 3 Spectrum 4</p> <p>Ref Level 20.00 dBm Offset 0.50 dB RBW 30 kHz</p> <p>Att 30 dB SWT 1 ms VBW 100 kHz Mode Sweep</p> <p>1Pk Max</p> <p>MI[1] -13.40 dBm</p> <p>2.40182830 GHz</p> <p>1.153692615 MHz</p> <p>CF 2.402 GHz 501 pts Span 2.0 MHz</p> <p>Date: 30.SEP.2021 18:56:09</p>
<p>Middle Channel</p>	<p>Spectrum 2 Spectrum 3 Spectrum 4</p> <p>Ref Level 20.00 dBm Offset 0.50 dB RBW 30 kHz</p> <p>Att 30 dB SWT 1 ms VBW 100 kHz Mode Sweep</p> <p>1Pk Max</p> <p>MI[1] -14.06 dBm</p> <p>2.44082830 GHz</p> <p>1.161676647 MHz</p> <p>CF 2.441 GHz 501 pts Span 2.0 MHz</p> <p>Date: 30.SEP.2021 18:57:49</p>
<p>Highest Channel</p>	<p>Spectrum 2 Spectrum 3 Spectrum 4</p> <p>Ref Level 20.00 dBm Offset 0.50 dB RBW 30 kHz</p> <p>Att 30 dB SWT 1 ms VBW 100 kHz Mode Sweep</p> <p>1Pk Max</p> <p>MI[1] -14.02 dBm</p> <p>2.47982830 GHz</p> <p>1.161676647 MHz</p> <p>CF 2.48 GHz 501 pts Span 2.0 MHz</p> <p>Date: 30.SEP.2021 18:59:40</p>

**4.5 Channel Separation:**

Serial Number:	CR21090047-RF-S1	Test Date:	2021/9/30
Test Site:	RF	Test Mode:	Transmitting
Tester:	Le Qiao	Test Result:	Pass

**Environmental Conditions:**

Temperature: (°C)	28.1	Relative Humidity: (%)	52	ATM Pressure: (kPa)	100.1
----------------------	------	------------------------------	----	------------------------	-------

**Test Equipment List and Details:**

Manufacturer	Description	Model	Serial Number	Calibration Date	Calibration Due Date
R&S	Spectrum Analyzer	FSV40	101474	2021/7/22	2022/7/21
Mini-Circuits	DC Block	BLK-18-S+	1554403	Each time	N/A
zhuoxiang	Coaxial Cable	SMA-178	211001	Each time	N/A

\* Statement of Traceability: China Certification ICT Co., Ltd (Dongguan) attests that all calibrations have been performed, traceable to National Primary Standards and International System of Units (SI).

**Test Data:**

Test Modes	Test Frequency (MHz)	Channel Separation (MHz)	Limits (MHz)
BDR Mode (GFSK)	2402	1.000	0.59
	2441	1.000	0.59
	2480	1.000	0.59
EDR Mode ( $\pi/4$ -DQPSK)	2402	1.000	0.83
	2441	1.000	0.83
	2480	1.000	0.83
EDR Mode (8DPSK)	2402	1.000	0.81
	2441	1.000	0.81
	2480	1.000	0.81



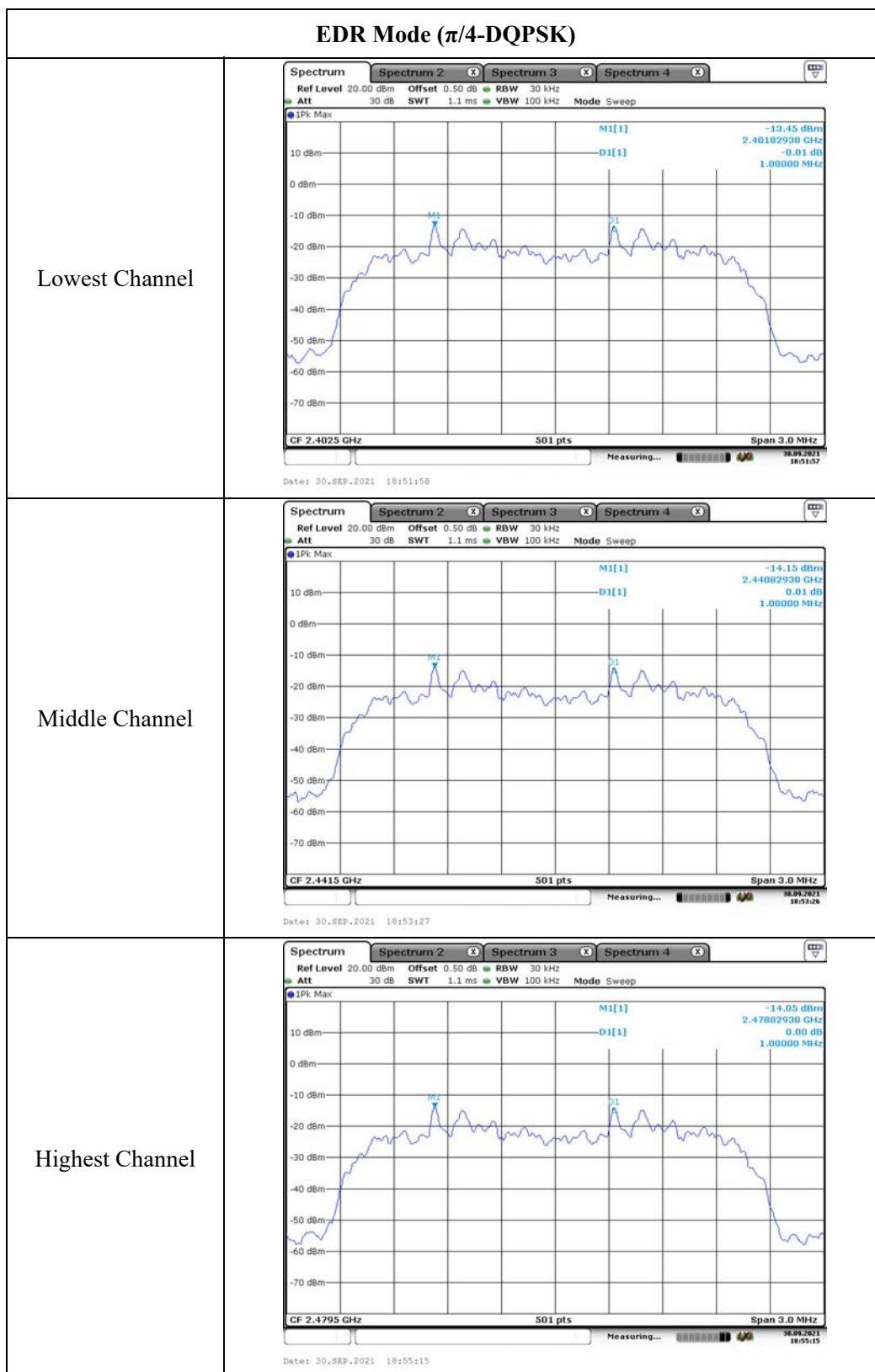

### EDR Mode (8DPSK)

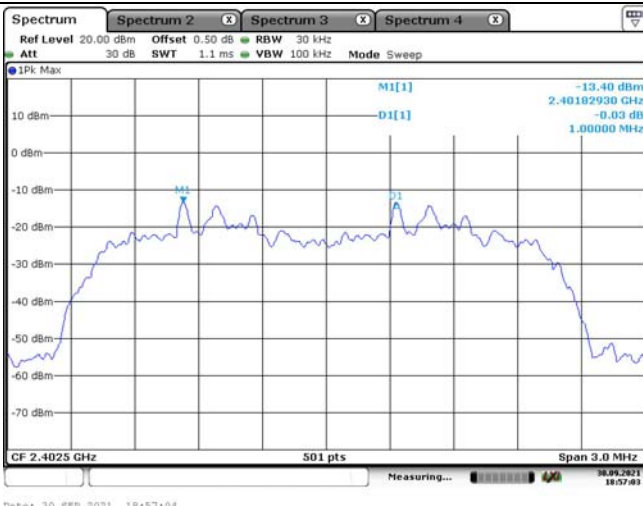
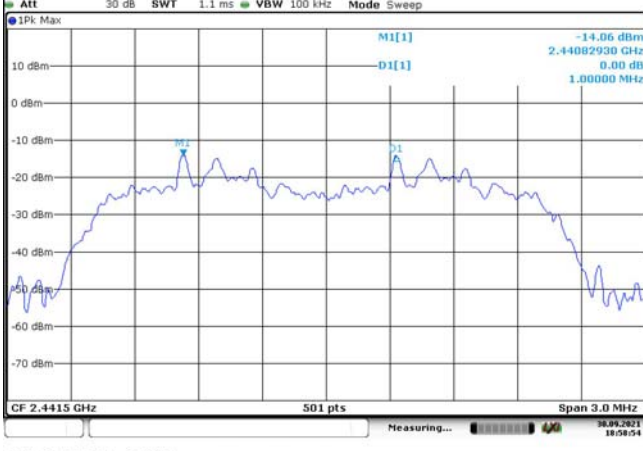
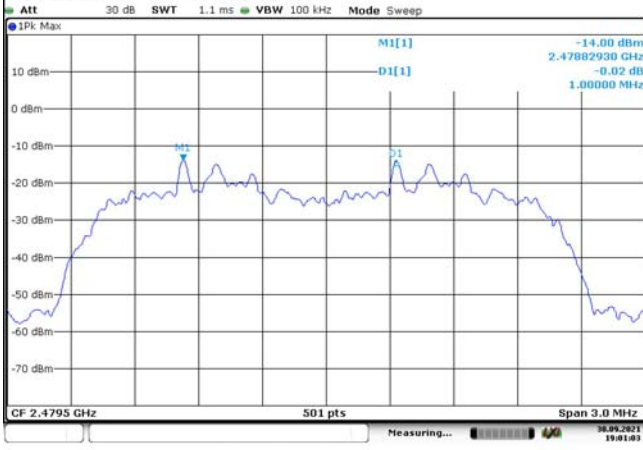
Lowest Channel	 <p>Spectrum 2 Spectrum 3 Spectrum 4</p> <p>Ref Level 20.00 dBm Offset 0.50 dB RBW 30 kHz Att 30 dB SWT 1.1 ms VBW 100 kHz Mode Sweep</p> <p>1Pk Max</p> <p>M1[1] -13.40 dBm D1[1] 2.40182930 GHz -0.03 dB 1.00000 MHz</p> <p>CF 2.4025 GHz 501 pts Span 3.0 MHz</p> <p>Date: 30.SEP.2021 18:57:04</p>
Middle Channel	 <p>Spectrum 2 Spectrum 3 Spectrum 4</p> <p>Ref Level 20.00 dBm Offset 0.50 dB RBW 30 kHz Att 30 dB SWT 1.1 ms VBW 100 kHz Mode Sweep</p> <p>1Pk Max</p> <p>M1[1] -14.06 dBm D1[1] 2.44082930 GHz 0.00 dB 1.00000 MHz</p> <p>CF 2.4415 GHz 501 pts Span 3.0 MHz</p> <p>Date: 30.SEP.2021 18:58:54</p>
Highest Channel	 <p>Spectrum 2 Spectrum 3 Spectrum 4</p> <p>Ref Level 20.00 dBm Offset 0.50 dB RBW 30 kHz Att 30 dB SWT 1.1 ms VBW 100 kHz Mode Sweep</p> <p>1Pk Max</p> <p>M1[1] -14.00 dBm D1[1] 2.47882930 GHz -0.02 dB 1.00000 MHz</p> <p>CF 2.4795 GHz 501 pts Span 3.0 MHz</p> <p>Date: 30.SEP.2021 19:01:04</p>

**4.6 Number Of Hopping Frequency:**

Serial Number:	CR21090047-RF-S1	Test Date:	2021/9/30
Test Site:	RF	Test Mode:	Transmitting
Tester:	Le Qiao	Test Result:	Pass

**Environmental Conditions:**

Temperature: (°C)	28.1	Relative Humidity: (%)	52	ATM Pressure: (kPa)	100.1
----------------------	------	------------------------------	----	------------------------	-------

**Test Equipment List and Details:**

Manufacturer	Description	Model	Serial Number	Calibration Date	Calibration Due Date
R&S	Spectrum Analyzer	FSV40	101474	2021/7/22	2022/7/21
Mini-Circuits	DC Block	BLK-18-S+	1554403	Each time	N/A
zhuoxiang	Coaxial Cable	SMA-178	211001	Each time	N/A

\* Statement of Traceability: China Certification ICT Co., Ltd (Dongguan) attests that all calibrations have been performed, traceable to National Primary Standards and International System of Units (SI).

**Test Data:**

Test Modes	Frequency Range (MHz)	Number of Hopping Channel	Limits
GFSK	2400-2483.5	79	≥15
$\pi/4$ -DQPSK	2400-2483.5	79	≥15
8DPSK	2400-2483.5	79	≥15

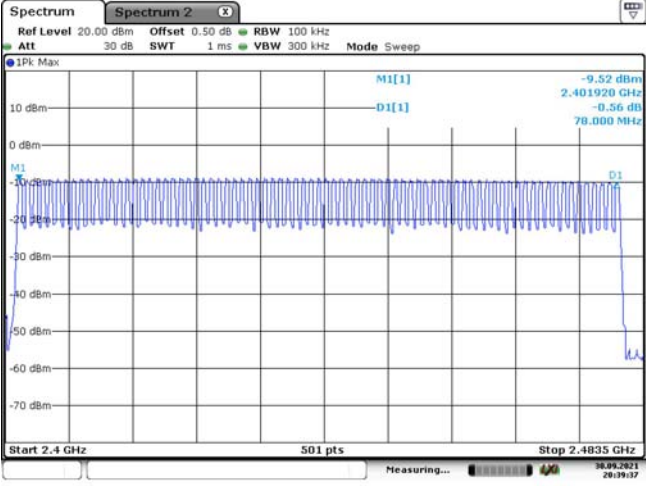
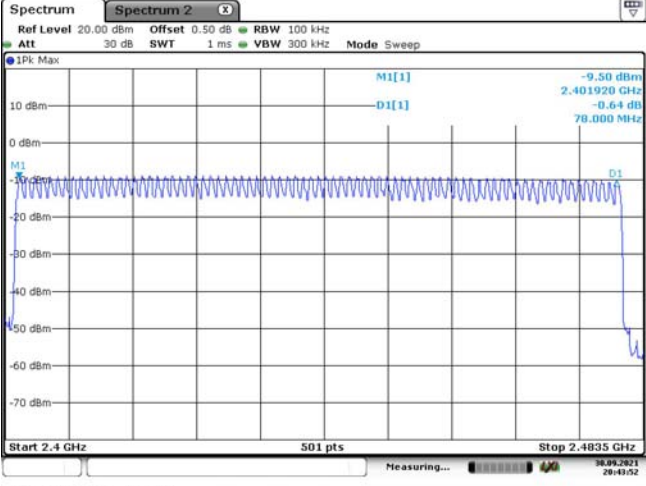
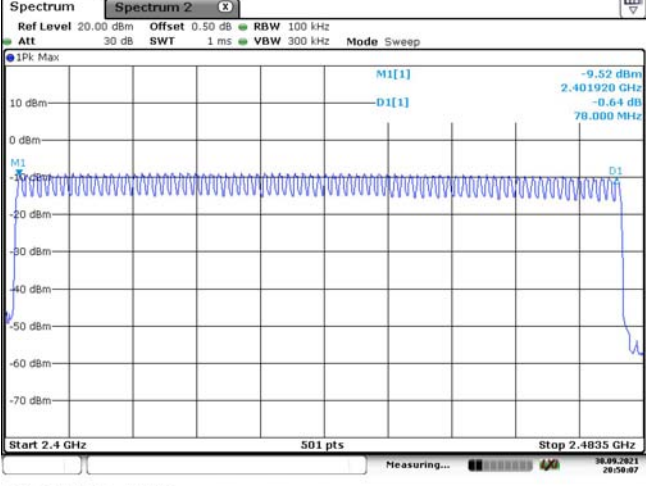
<p><b>BDR Mode (GFSK)</b></p>	 <p>Spectrum 2</p> <p>Ref Level 20.00 dBm Offset 0.50 dB RBW 100 kHz Att 30 dB SWT 1 ms VBW 300 kHz Mode Sweep</p> <p>IPk Max</p> <p>M1[1] -9.52 dBm 2.401920 GHz D1[1] -0.56 dB 78.000 MHz</p> <p>M1</p> <p>D1</p> <p>Start 2.4 GHz 501 pts Stop 2.4835 GHz</p> <p>Date: 30.SEP.2021 20:39:37</p>
<p><b>EDR Mode (<math>\pi/4</math>-DQPSK)</b></p>	 <p>Spectrum 2</p> <p>Ref Level 20.00 dBm Offset 0.50 dB RBW 100 kHz Att 30 dB SWT 1 ms VBW 300 kHz Mode Sweep</p> <p>IPk Max</p> <p>M1[1] -9.50 dBm 2.401920 GHz D1[1] -0.64 dB 78.000 MHz</p> <p>M1</p> <p>D1</p> <p>Start 2.4 GHz 501 pts Stop 2.4835 GHz</p> <p>Date: 30.SEP.2021 20:43:53</p>
<p><b>EDR Mode (8DPSK)</b></p>	 <p>Spectrum 2</p> <p>Ref Level 20.00 dBm Offset 0.50 dB RBW 100 kHz Att 30 dB SWT 1 ms VBW 300 kHz Mode Sweep</p> <p>IPk Max</p> <p>M1[1] -9.52 dBm 2.401920 GHz D1[1] -0.64 dB 78.000 MHz</p> <p>M1</p> <p>D1</p> <p>Start 2.4 GHz 501 pts Stop 2.4835 GHz</p> <p>Date: 30.SEP.2021 20:50:07</p>



**4.7 Time Of Occupancy(Dwell Time):**

Serial Number:	CR21090047-RF-S1	Test Date:	2021/9/30
Test Site:	RF	Test Mode:	Transmitting
Tester:	Le Qiao	Test Result:	Pass

**Environmental Conditions:**

Temperature: (°C)	28.1	Relative Humidity: (%)	52	ATM Pressure: (kPa)	100.1
----------------------	------	------------------------------	----	------------------------	-------

**Test Equipment List and Details:**

Manufacturer	Description	Model	Serial Number	Calibration Date	Calibration Due Date
R&S	Spectrum Analyzer	FSV40	101474	2021/7/22	2022/7/21
Mini-Circuits	DC Block	BLK-18-S+	1554403	Each time	N/A
zhuoxiang	Coaxial Cable	SMA-178	211001	Each time	N/A

\* Statement of Traceability: China Certification ICT Co., Ltd (Dongguan) attests that all calibrations have been performed, traceable to National Primary Standards and International System of Units (SI).

**Test Data:**

Test Modes	Packet Type	Test Frequency (MHz)	Pulse width (ms)	Result (s)	Limit (s)
BDR Mode (GFSK)	DH1	2441	0.383	0.123	0.400
	DH3	2441	1.649	0.264	0.400
	DH5	2441	2.916	0.311	0.400
EDR Mode ( $\pi/4$ -DQPSK)	2DH1	2441	0.391	0.125	0.400
	2DH3	2441	1.662	0.266	0.400
	2DH5	2441	2.916	0.311	0.400
EDR Mode (8DPSK)	3DH1	2441	0.394	0.126	0.400
	3DH3	2441	1.654	0.265	0.400
	3DH5	2441	2.916	0.311	0.400

Note:

DH1:Dwell time=Pulse time (ms)  $\times$  (1600/2/79)  $\times$  31.6 s

DH3:Dwell time=Pulse time (ms)  $\times$  (1600/4/79)  $\times$  31.6 s

DH5:Dwell time=Pulse time (ms)  $\times$  (1600/6/79)  $\times$  31.6 s

<b>BDR Mode (GFSK)</b>	
<b>DH1: Middle Channel</b>	<p>CF 2.441 GHz 691 pts 100.0 μs/</p> <p>Date: 9.OCT.2021 13:18:06</p>
<b>DH3: Middle Channel</b>	<p>CF 2.441 GHz 691 pts 300.0 μs/</p> <p>Date: 9.OCT.2021 13:16:14</p>
<b>DH5: Middle Channel</b>	<p>CF 2.441 GHz 691 pts 400.0 μs/</p> <p>Date: 9.OCT.2021 13:15:27</p>

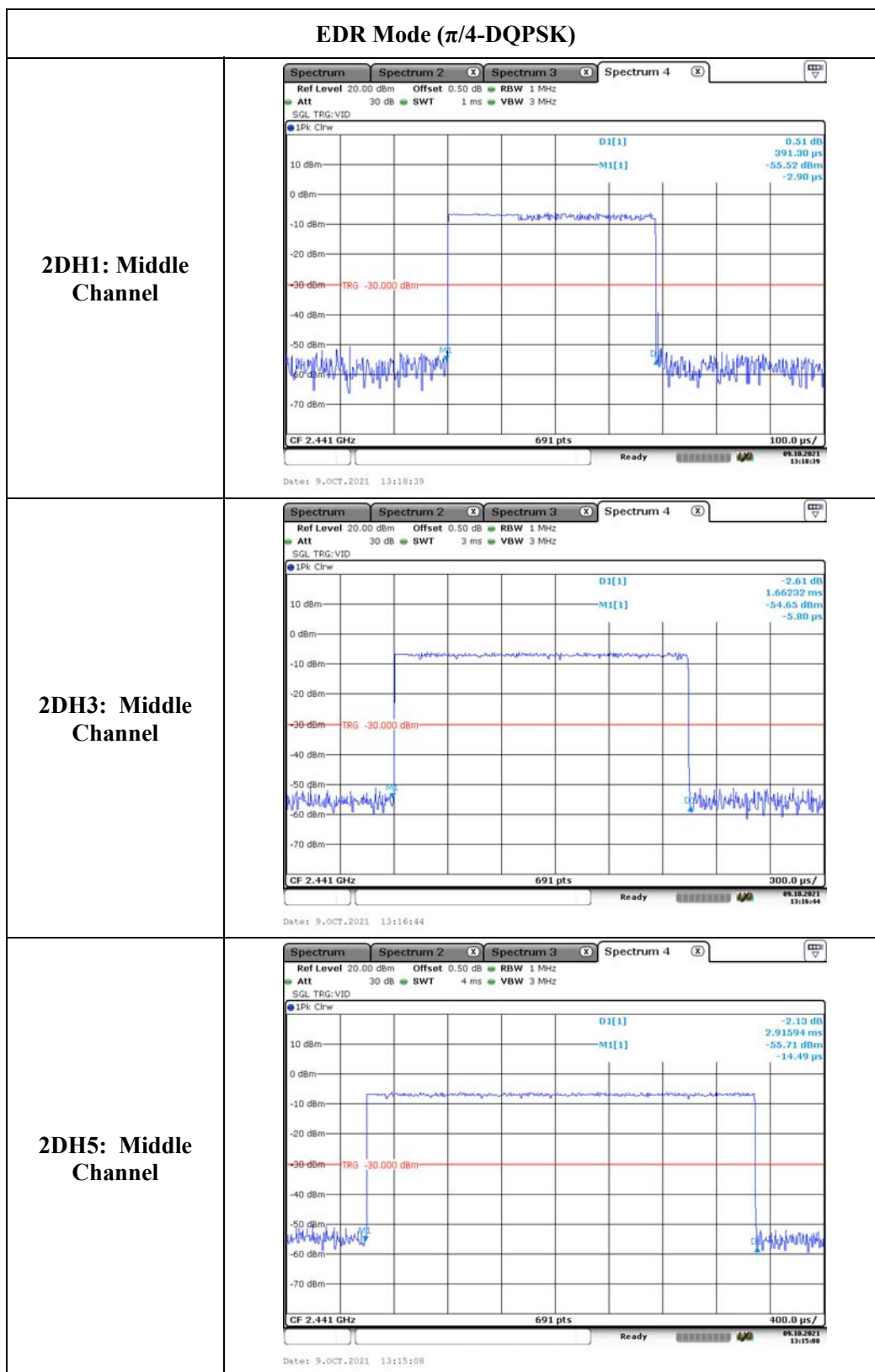

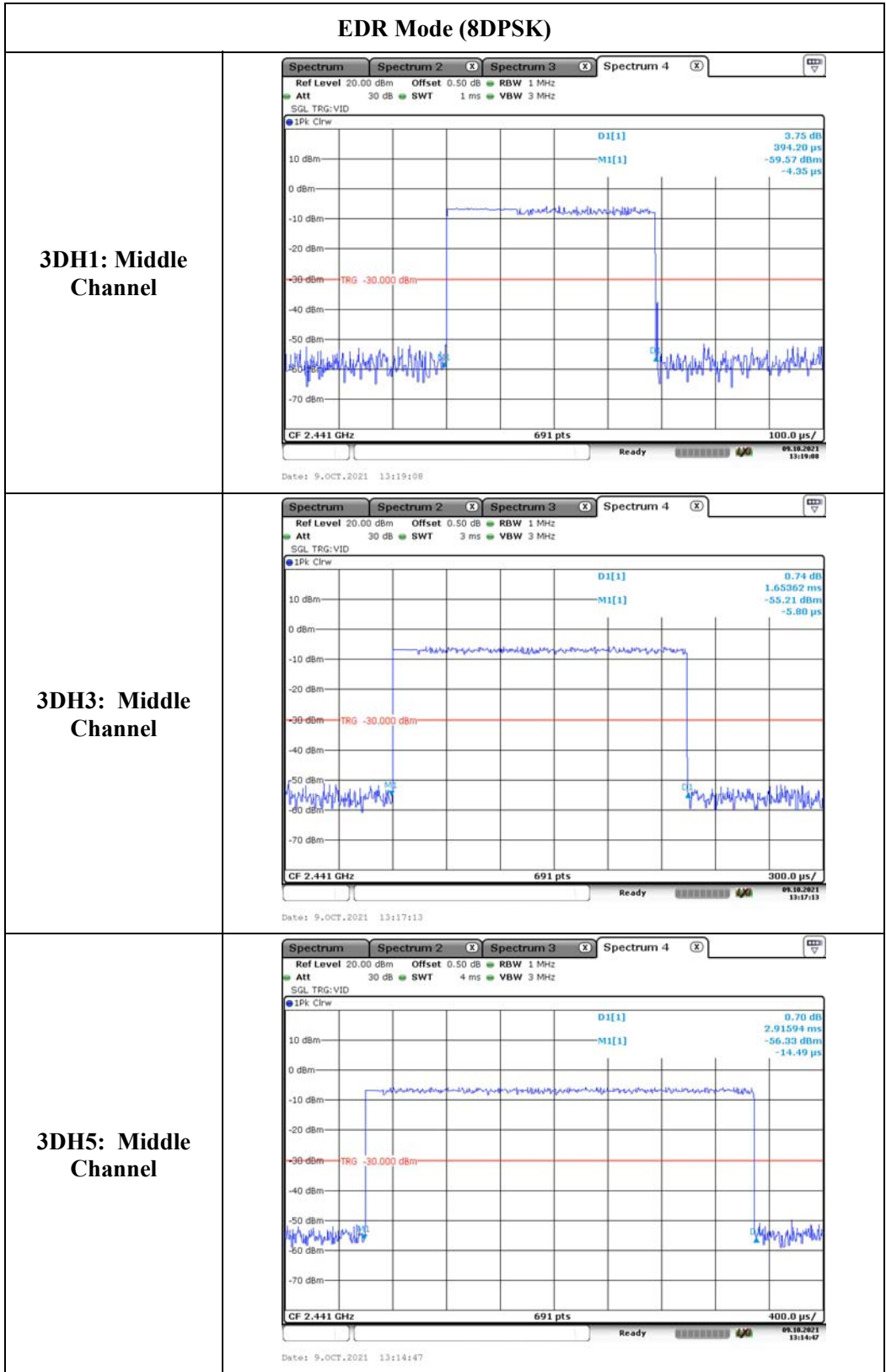

**4.8 Peak Conducted Output Power:**

Serial Number:	CR21090047-RF-S1	Test Date:	2021/9/30
Test Site:	RF	Test Mode:	Transmitting
Tester:	Le Qiao	Test Result:	Pass

**Environmental Conditions:**

Temperature: (°C)	28.1	Relative Humidity: (%)	52	ATM Pressure: (kPa)	100.1
----------------------	------	------------------------------	----	------------------------	-------

**Test Equipment List and Details:**

Manufacturer	Description	Model	Serial Number	Calibration Date	Calibration Due Date
eastsheep	Coaxial Attenuator	2W-SMA-JK-18G	21060301	Each time	N/A
zhuoxiang	Coaxial Cable	SMA-178	211001	Each time	N/A
Agilent	USB Wideband Power Sensor	U2021XA	MY54080015	2021-07-22	2022-07-21

\* Statement of Traceability: China Certification ICT Co., Ltd (Dongguan) attests that all calibrations have been performed, traceable to National Primary Standards and International System of Units (SI).

**Test Data:**

Test Modes	Test Frequency (MHz)	Peak Conducted Output Power (dBm)	Limits (dBm)
BDR Mode (GFSK)	2402	-3.59	21
	2441	-3.07	21
	2480	-3.09	21
EDR Mode ( $\pi/4$ -DQPSK)	2402	-2.82	21
	2441	-2.24	21
	2480	-2.26	21
EDR Mode (8DPSK)	2402	-2.28	21
	2441	-1.77	21
	2480	-1.73	21

**4.9 100 kHz Bandwidth of Frequency Band Edge:**

Serial Number:	CR21090047-RF-S1	Test Date:	2021/9/30
Test Site:	RF	Test Mode:	Transmitting
Tester:	Le Qiao	Test Result:	Pass

**Environmental Conditions:**

Temperature: (°C)	28.1	Relative Humidity: (%)	52	ATM Pressure: (kPa)	100.1
----------------------	------	------------------------------	----	------------------------	-------

**Test Equipment List and Details:**

Manufacturer	Description	Model	Serial Number	Calibration Date	Calibration Due Date
R&S	Spectrum Analyzer	FSV40	101474	2021/7/22	2022/7/21
Mini-Circuits	DC Block	BLK-18-S+	1554403	Each time	N/A
zhuoxiang	Coaxial Cable	SMA-178	211001	Each time	N/A

\* Statement of Traceability: China Certification ICT Co., Ltd (Dongguan) attests that all calibrations have been performed, traceable to National Primary Standards and International System of Units (SI).

**BDR Mode (GFSK)**

**Band Edge,  
Left Side**

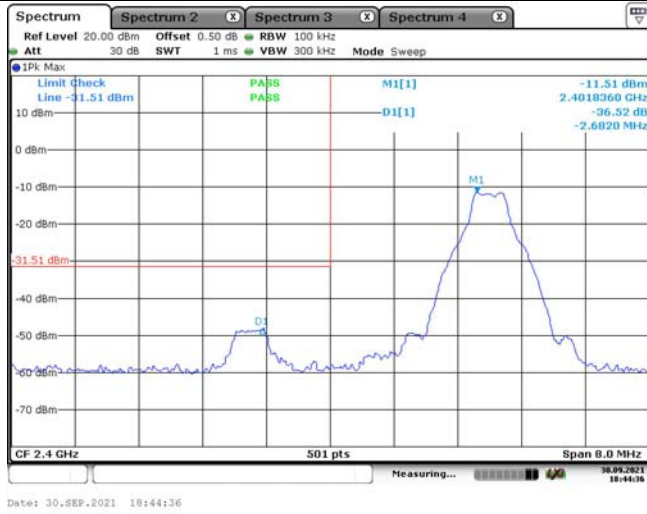

**Band Edge,  
Right Side**

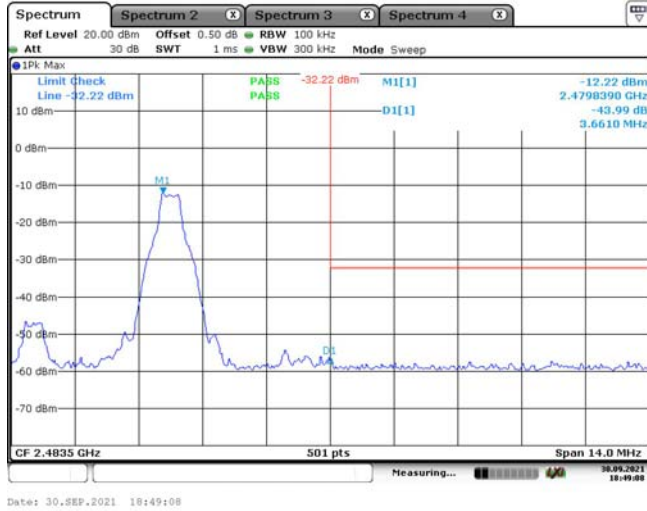

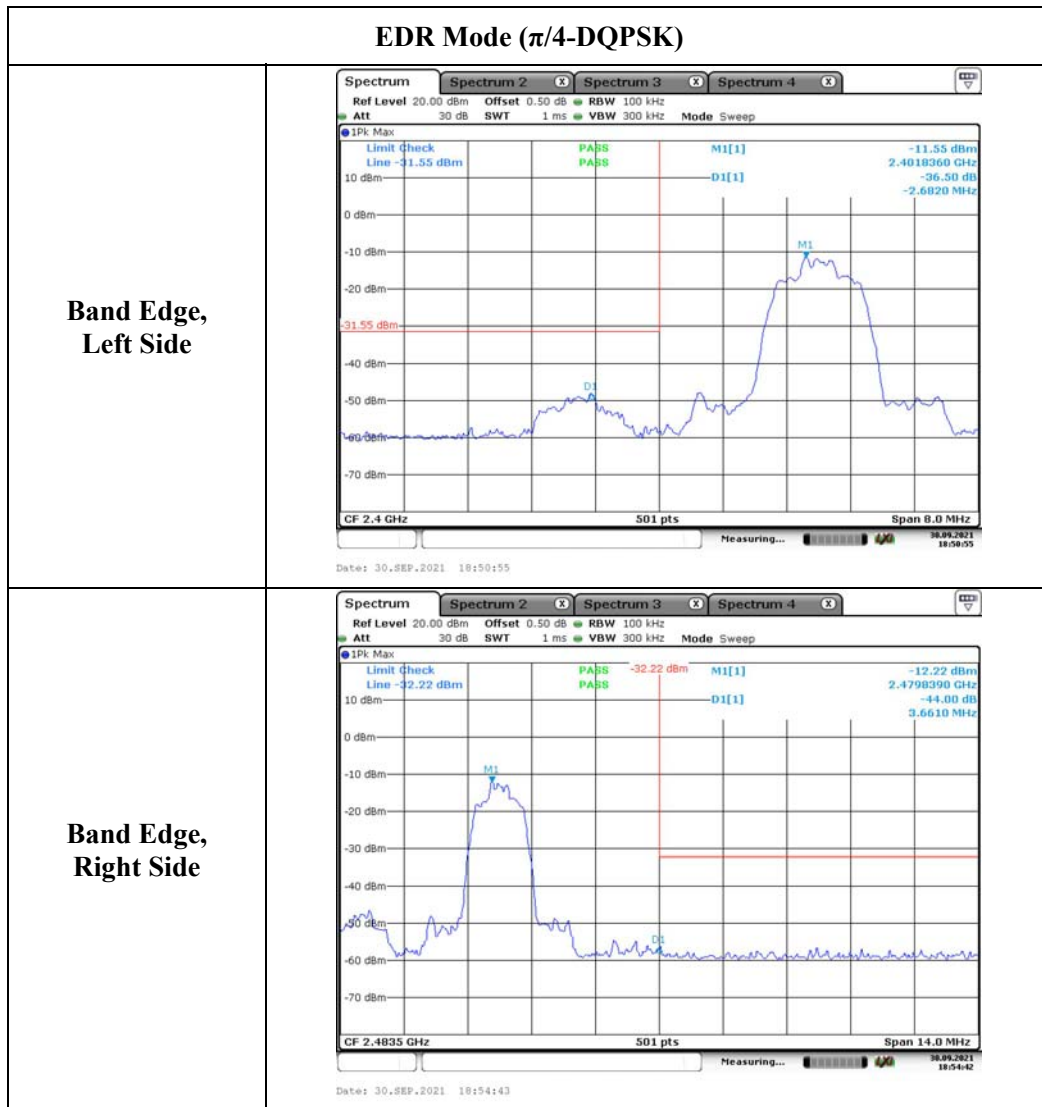



### EDR Mode (8DPSK)

Band Edge,  
Left Side

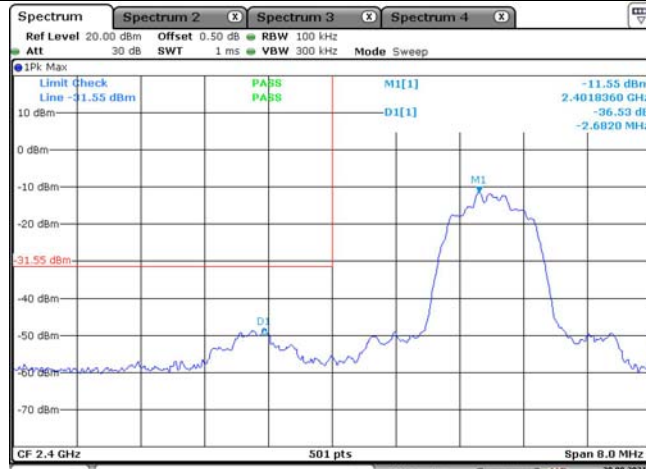

Date: 30.SEP.2021 18:56:38

Band Edge,  
Right Side

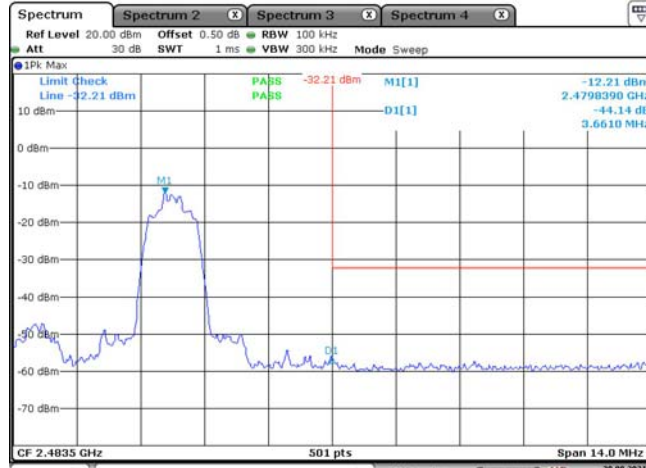

Date: 30.SEP.2021 19:00:00

### Hopping Mode, BDR Mode (GFSK)

**Band Edge,  
Left Side**



**Band Edge,  
Right Side**

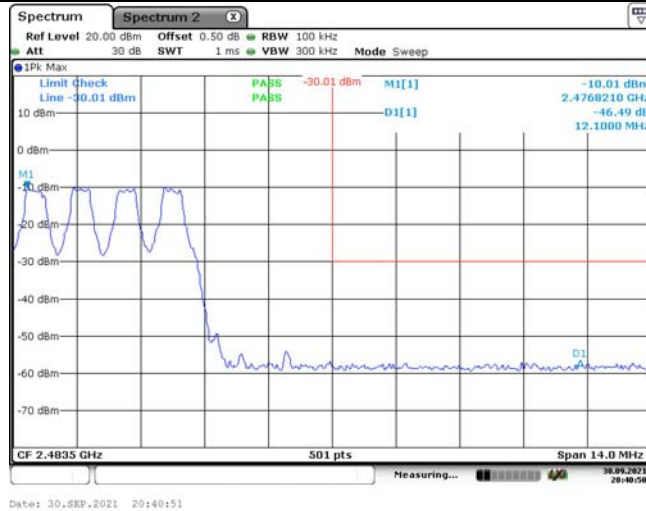

### Hopping Mode, EDR Mode ( $\pi/4$ -DQPSK)

Band Edge,  
Left Side



Band Edge,  
Right Side



### Hopping Mode, EDR Mode (8DPSK)

**Band Edge,  
Left Side**

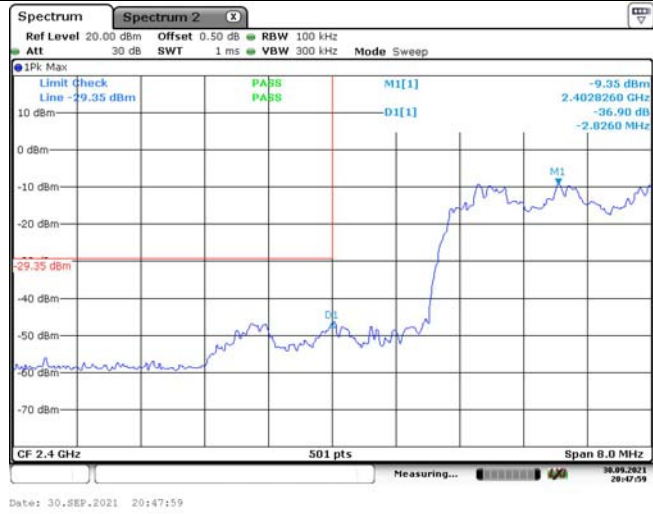

**Band Edge,  
Right Side**

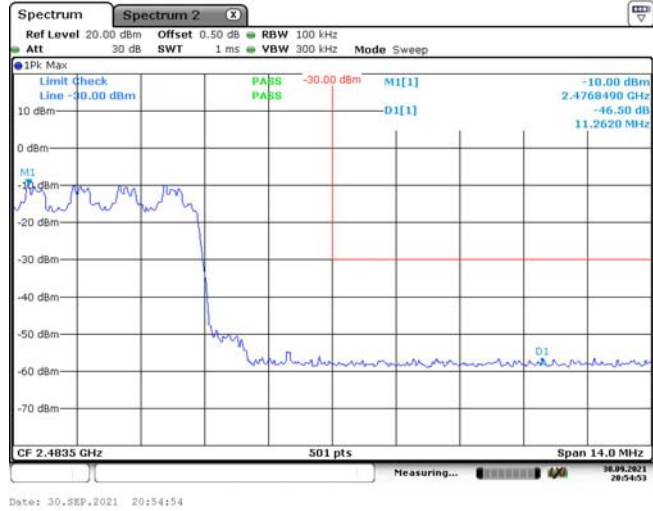

## 5. RF EXPOSURE EVALUATION

### 5.1 Applicable Standard

FCC §15.247 (i)

Systems operating under the provisions of this section shall be operated in a manner that ensures that the public is not exposed to radio frequency energy levels in excess of the Commission's guidelines. See §1.1307(b)(1) of this chapter.

### 5.2 Procedure

According to KDB447498 D01 General RF Exposure Guidance v06:

The 1-g and 10-g SAR test exclusion thresholds for 100 MHz to 6 GHz at test separation distances  $\leq 50$  mm are determined by:

$[(\text{max. power of channel, including tune-up tolerance, mW})/(\text{min. test separation distance, mm})] \cdot [\sqrt{f(\text{GHz})}] \leq 3.0$  for 1-g SAR and  $\leq 7.5$  for 10-g extremity SAR, where

- $f(\text{GHz})$  is the RF channel transmit frequency in GHz
- Power and distance are rounded to the nearest mW and mm before calculation
- The result is rounded to one decimal place for comparison
- 3.0 and 7.5 are referred to as the numeric thresholds in the step 2 below

The test exclusions are applicable only when the minimum test separation distance is  $\leq 50$  mm and for transmission frequencies between 100 MHz and 6 GHz. When the minimum test separation distance is  $< 5$  mm, a distance of 5 mm according to 5) in section 4.1 is applied to determine SAR test exclusion.

### 5.3 Measurement Result

The max conducted power including tune-up tolerance is -1.0 dBm (0.79 mW).

$[(\text{max. power of channel, mW})/(\text{min. test separation distance, mm})][\sqrt{f(\text{GHz})}]$   
 $= 0.79/5 \cdot (\sqrt{2.480}) = 0.3 < 3.0$

**Result: Compliance. The stand-alone SAR evaluation is not necessary.**

## 5.2 EXEMPTION LIMITS FOR ROUTINE EVALUATION – SAR EVALUATION

### 5.2.1 Applicable Standard

SAR evaluation is required if the separation distance between the user and/or bystander and the antenna and/or radiating element of the device is less than or equal to 20 cm, except when the device operates at or below the applicable output power level (adjusted for tune-up tolerance) for the specified separation distance defined in Table 1. For limb-worn devices where the 10 gram value applies, the exemption limits for routine evaluation in Table 1 are multiplied by a factor of 2.5.

**Table 1: SAR evaluation – Exemption limits for routine evaluation based on frequency and separation distance<sup>45</sup>**

Frequency (MHz)	Exemption Limits (mW)				
	At separation distance of $\leq 5$ mm	At separation distance of 10 mm	At separation distance of 15 mm	At separation distance of 20 mm	At separation distance of 25 mm
$\leq 300$	71 mW	101 mW	132 mW	162 mW	193 mW
450	52 mW	70 mW	88 mW	106 mW	123 mW
835	17 mW	30 mW	42 mW	55 mW	67 mW
1900	7 mW	10 mW	18 mW	34 mW	60 mW
2450	4 mW	7 mW	15 mW	30 mW	52 mW
3500	2 mW	6 mW	16 mW	32 mW	55 mW
5800	1 mW	6 mW	15 mW	27 mW	41 mW

Frequency (MHz)	Exemption Limits (mW)				
	At separation distance of 30 mm	At separation distance of 35 mm	At separation distance of 40 mm	At separation distance of 45 mm	At separation distance of $\geq 50$ mm
$\leq 300$	223 mW	254 mW	284 mW	315 mW	345 mW
450	141 mW	159 mW	177 mW	195 mW	213 mW
835	80 mW	92 mW	105 mW	117 mW	130 mW
1900	99 mW	153 mW	225 mW	316 mW	431 mW
2450	83 mW	123 mW	173 mW	235 mW	309 mW
3500	86 mW	124 mW	170 mW	225 mW	290 mW
5800	56 mW	71 mW	85 mW	97 mW	106 mW

### 5.2.2 Measurement Result:

The max tune-up conducted power is -1.0 dBm, Antenna Gain:4.0 dBi, the EIRP=3dBm(2mW)

The exemption power(P) limits for routine evaluation in 2402-2480MHz is:

$$(2480-2450)/(3500-2450)=(P-4)/(2-4)$$

$$\Rightarrow P=3.94 \text{ mW}@2480 \text{ MHz}$$

$$> 2\text{mW}$$

**So the stand-alone SAR evaluation can be exempted.**

**\*\*\*\*\* END OF REPORT \*\*\*\*\***