



中国认可
国际互认
检测
TESTING
CNAS L2264

RF TEST REPORT

Applicant	Shanghai SmartPeak Technology Co.,Ltd.
FCC ID	2AJMSC6000
Product	WCDMA Smart Handheld Terminal
Brand	SMARTPEAK
Model	C6000
Report No.	RXA1606-0101RF02
Issue Date	September 13, 2016

TA Technology (Shanghai) Co., Ltd. tested the above equipment in accordance with the requirements in **FCC CFR47 Part 15C (2015)**. The test results show that the equipment tested is capable of demonstrating compliance with the requirements as documented in this report.

Performed by: Xianqing Li

Approved by: Kai Xu

TA Technology (Shanghai) Co., Ltd.

No.145, Jintang Rd, Tangzhen Industry Park, Pudong Shanghai, China

TEL: +86-021-50791141/2/3

FAX: +86-021-50791141/2/3-8000



TABLE OF CONTENT

- 1. Test Laboratory 4
 - 1.1. Notes of the test report..... 4
 - 1.2. Test facility 4
 - 1.3. Testing Location 5
- 2. General Description of Equipment under Test..... 6
- 3. Applied Standards 8
- 4. Test Configuration 9
- 5. Test Case Results 10
 - 5.1. Peak Power Output –Conducted 10
 - 5.2. 6dB Bandwidth 12
 - 5.3. Band Edge 16
 - 5.4. Power Spectral Density 18
 - 5.5. Spurious RF Conducted Emissions..... 22
 - 5.6. Radiated Emissions in the Restricted Band 28
 - 5.7. Radiates Emission 33
 - 5.8. Conducted Emission 84
- 6. Main Test Instruments 93
- ANNEX A: EUT Appearance and Test Setup 94
 - A.1 EUT Appearance 94
 - A.2 Test Setup 98



Summary of measurement results

Number	Summary of measurements of results	Clause in FCC rules	Verdict
1	Maximum peak conducted output power	15.247(b)(3)	PASS
2	6 dB bandwidth	15.247(a)(2)	PASS
3	Maximum power spectral density	15.247(e)	PASS
4	Band Edge	15.247(d)	PASS
5	Spurious RF Conducted Emissions	15.247(d)	PASS
6	Radiated Emissions in restricted frequency bands	15.247(d),15.205,15.209	PASS
7	Radiated Emissions	15.247(d),15.205,15.209	PASS
8	Conducted Emissions	15.207	PASS
Date of Testing: August 25, 2016~ September 5, 2016			

1. Test Laboratory

1.1. Notes of the test report

This report shall not be reproduced in full or partial, without the written approval of TA technology (shanghai) co., Ltd. The results documented in this report apply only to the tested sample, under the conditions and modes of operation as described herein. Measurement Uncertainties were not taken into account and are published for informational purposes only. This report is written to support regulatory compliance of the applicable standards stated above. This report must not be used by the client to claim product certification, approval, or endorsement by CNAS or any government agencies.

1.2. Test facility

CNAS (accreditation number: L2264)

TA Technology (Shanghai) Co., Ltd. has obtained the accreditation of China National Accreditation Service for Conformity Assessment (CNAS).

FCC (recognition number is 428261)

TA Technology (Shanghai) Co., Ltd. has been listed on the US Federal Communications Commission list of test facilities recognized to perform electromagnetic emissions measurements.

IC (recognition number is 8510A)

TA Technology (Shanghai) Co., Ltd. has been listed by industry Canada to perform electromagnetic emission measurement.

VCCI (recognition number is C-4595, T-2154, R-4113, G-766)

TA Technology (Shanghai) Co., Ltd. has been listed by industry Japan to perform electromagnetic emission measurement.

A2LA (Certificate Number: 3857.01)

TA Technology (Shanghai) Co., Ltd. has been listed by American Association for Laboratory Accreditation to perform electromagnetic emission measurement.



1.3. Testing Location

Company: TA Technology (Shanghai) Co., Ltd.
Address: No.145, Jintang Rd, Tangzhen Industry Park, Pudong
City: Shanghai
Post code: 201201
Country: P. R. China
Contact: Xu Kai
Telephone: +86-021-50791141/2/3
Fax: +86-021-50791141/2/3-8000
Website: <http://www.ta-shanghai.com>
E-mail: xukai@ta-shanghai.com

2. General Description of Equipment under Test

Client Information

Applicant	Shanghai SmartPeak Technology Co.,Ltd.
Applicant address	Room 1,No.3 Building, NO.295, Qianqiao Road, Fengxian District, Shanghai, P.R.China
Manufacturer	Shanghai SmartPeak Technology Co.,Ltd.
Manufacturer address	Room 1,No.3 Building, NO.295, Qianqiao Road, Fengxian District, Shanghai, P.R.China

Accessory Equipment Details

Name	Model	Manufacturer	Capacity	S/N
Battery	BL-C60	Shenzhen MBELL ELECTRONICS CO., LTD.	2500mAh/ 9.5Wh	MB16030403944
Adapter 1	RCL-X055300C	SHENZHEN RICHLY TECHNOLOGIES CO., LTD.	/	/
Adapter 2	YLJXC-055100	DONGGUAN YINLI ELECTRONICS CO., LTD.	/	/
Charger pedestal holder	CRD-C60	Shanghai SmartPeak Technology Co., Ltd.	/	/

**General information**

Model:	C6000
IMEI:	868692020019704
Hardware Version:	P1
Software Version:	V1.41.4649
Power Supply:	Battery/AC adapter
Antenna Type:	Internal Antenna
Test Mode:	Bluetooth(Low Energy) 802.11b 802.11g, 802.11n HT20;
Modulation Type:	BLE :GFSK 802.11b: DSSS; 802.11g/n HT20: OFDM
Max. Conducted Power	Wi-Fi 2.4G : 15.134dBm BLE : 0.993 dBm
Operating Frequency Range(s)	2400 ~ 2483.5 MHz
Note: The information of the EUT is declared by the manufacturer. Please refer to the specifications or user manual for details.	



3. Applied Standards

According to the specifications of the manufacturer, it must comply with the requirements of the following standards:

Test standards

- **FCC CFR47 Part 15C (2015) Radio Frequency Devices**
- **ANSI C63.10 (2013)**
- **KDB 558074 D01 DTS Meas Guidance v03r05**

4. Test Configuration

Test Mode

The EUT was programmed to be in continuously transmitting mode and the transmit duty cycle is not less than 98%.

The EUT has been associated with peripherals and configuration operated in a manner tended to maximize its emission characteristics in a typical application.

The radiated emission was measured in the following position: EUT stand-up position (Z axis), lie-down position (X, Y axis). The worst emission was found in stand-up position (Z axis) and the worst case was recorded.

In order to find the worst case condition, Pre-tests are needed at the presence of different data rate. Preliminary tests have been done on all the configuration for confirming worst case. Data rate below means worst-case rate of each test item.

Worst-case data rates are shown as following table.

Band	Data Rate
Bluetooth(Low Energy)	1Mbps
802.11b	1 Mbps
802.11g	6 Mbps
802.11n HT20	MCS0

5. Test Case Results

5.1. Peak Power Output –Conducted

Ambient condition

Temperature	Relative humidity	Pressure
23°C ~25°C	45%~50%	101.5kPa

Methods of Measurement

During the process of the testing, The EUT was connected to peak power meter with a known loss. The EUT is max power transmission with proper modulation. The peak detector is used. We use Maximum Peak Conducted Output Power Level Method in KDB 558074 D01 for this test.

Test Setup

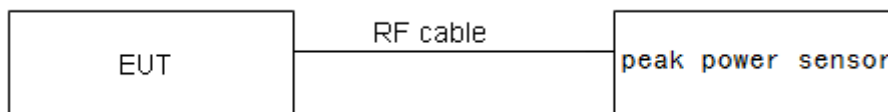

Limits

Rule Part 15.247 (b) (3) specifies that " For systems using digital modulation in the 902–928 MHz, 2400–2483.5 MHz: 1 Watt."

Peak Output Power	$\leq 1W$ (30dBm)
-------------------	-------------------

Measurement Uncertainty

The assessed measurement uncertainty to ensure 95% confidence level for the normal distribution is with the coverage factor $k = 2$, $U = 0.44$ dB.

Test Results

Network Standards	Carrier frequency (MHz)	Peak Output Power (dBm)	Limit (dBm)	Conclusion
802.11b	2412	14.030	30	PASS
	2437	14.625	30	PASS
	2462	15.134	30	PASS
802.11g	2412	12.545	30	PASS
	2437	14.019	30	PASS
	2462	13.065	30	PASS
802.11n HT20	2412	12.823	30	PASS
	2437	13.375	30	PASS
	2462	13.313	30	PASS
Bluetooth (Low Energy)	2402	0.085	30	PASS
	2440	0.993	30	PASS
	2480	-0.666	30	PASS

5.2. 6dB Bandwidth

Ambient condition

Temperature	Relative humidity	Pressure
23°C ~25°C	45%~50%	101.5kPa

Method of Measurement

The EUT was connected to the spectrum analyzer through an external attenuator (20dB) and a known loss cable. RBW is set to 100 kHz; VBW is set to 300 kHz on spectrum analyzer.

Test Setup

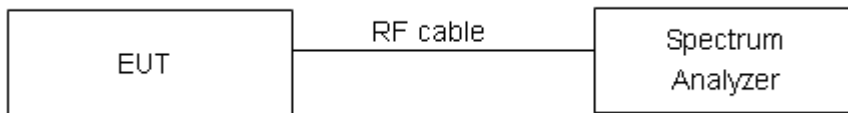

Limits

Rule Part 15.247 (a) (2) specifies that “Systems using digital modulation techniques may operate in the 902–928 MHz, 2400–2483.5 MHz bands. The minimum 6 dB bandwidth shall be at least 500 kHz.”

minimum 6 dB bandwidth	≥ 500 kHz
------------------------	-----------

Measurement Uncertainty

The assessed measurement uncertainty to ensure 95% confidence level for the normal distribution is with the coverage factor $k = 2$, $U = 936$ Hz.

Test Results:

Network Standards	Carrier frequency (MHz)	Minimum 6 dB bandwidth (MHz)	Limit(kHz)	Conclusion
802.11b	2412	13.486	500	PASS
	2437	13.405	500	PASS
	2462	13.226	500	PASS
802.11g	2412	16.506	500	PASS
	2437	16.511	500	PASS
	2462	16.462	500	PASS
802.11n HT20	2412	17.701	500	PASS
	2437	17.680	500	PASS
	2462	17.633	500	PASS
Bluetooth (Low Energy)	2402	1.0840	500	PASS
	2440	1.0837	500	PASS
	2480	1.0833	500	PASS

802.11b, Carrier frequency (MHz): 2412



802.11g, Carrier frequency (MHz): 2412



802.11b, Carrier frequency (MHz): 2437



802.11g, Carrier frequency (MHz): 2437

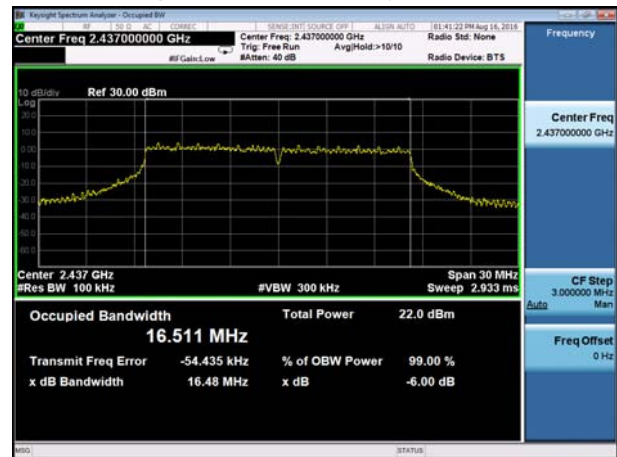

802.11b, Carrier frequency (MHz): 2462



802.11g, Carrier frequency (MHz): 2462

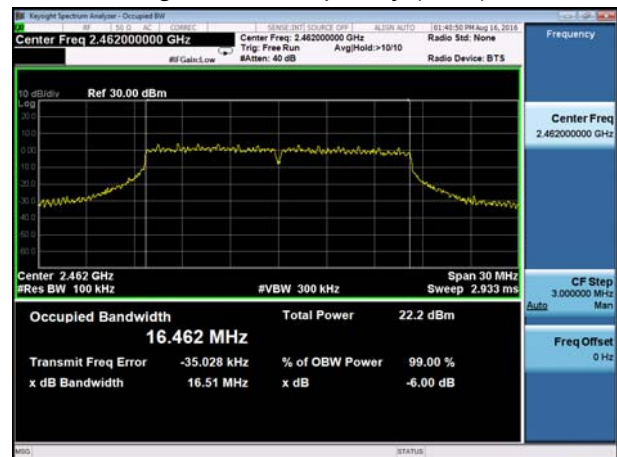



802.11n(HT20), Carrier frequency (MHz): 2412

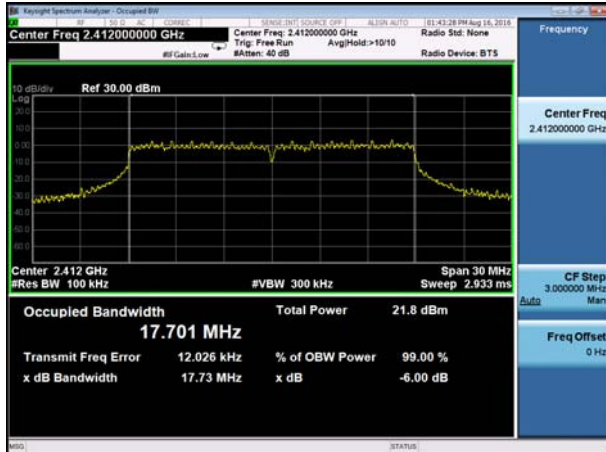

BLE Carrier frequency (MHz): 2402



802.11n(HT20), Carrier frequency (MHz): 2437



BLE Carrier frequency (MHz): 2440



802.11n(HT20), Carrier frequency (MHz):2462



BLE Carrier frequency (MHz): 2480



5.3. Band Edge

Ambient condition

Temperature	Relative humidity	Pressure
23°C ~25°C	45%~50%	101.5kPa

Method of Measurement

The EUT was connected to the spectrum analyzer through an external attenuator (20dB) and a known loss cable the band edge of the lowest and highest channels were measured. The peak detector is used and RBW is set to 100 kHz and VBW is set to 300 kHz on spectrum analyzer. Spectrum analyzer plots are included on the following pages.

Test Setup

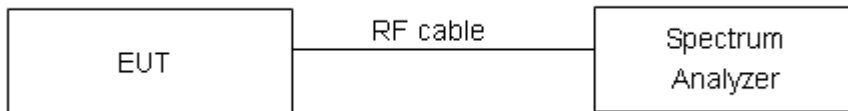

Limits

Rule Part 15.247(d) specifies that “In any 100 kHz bandwidth outside the frequency band in which the spread spectrum or digitally modulated intentional radiator is operating, the radio frequency power that is produced by the intentional radiator shall be at least 20 dB below that in the 100 kHz bandwidth within the band that contains the highest level of the desired power, based on either an RF conducted or a radiated measurement, provided the transmitter demonstrates compliance with the peak conducted power limits.”

Measurement Uncertainty

The assessed measurement uncertainty to ensure 95% confidence level for the normal distribution is with the coverage factor $k = 1.96$.

Frequency	Uncertainty
2GHz-3GHz	1.407 dB



Test Results: PASS



5.4. Power Spectral Density

Ambient condition

Temperature	Relative humidity	Pressure
23°C ~25°C	45%~50%	101.5kPa

Method of Measurement

The EUT was connected to the spectrum analyzer through an external attenuator (20dB) and a known loss cable.

RBW is set to 3 kHz and VBW is set to 10 kHz for BLE/ Wi-Fi 2.4G on spectrum analyzer.

Set the span to 1.5 times the DTS channel bandwidth. Sweep time = auto couple. Trace mode = max hold. The peak power spectral density is recorded.

Test setup

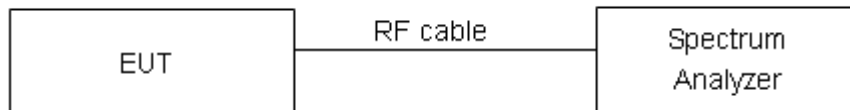

Limits

Rule Part 15.247(e) specifies that” For digitally modulated systems, the power spectral density conducted from the intentional radiator to the antenna shall not be greater than 8 dBm in any 3 kHz band during any time interval of continuous transmission. ”

Limits	≤ 8 dBm / 3kHz
--------	----------------

Measurement Uncertainty

The assessed measurement uncertainty to ensure 95% confidence level for the normal distribution is with the coverage factor $k = 2$, $U = 0.75\text{dB}$.

**Test Results:**

Network Standards	Channel Number	Power Spectral Density (dBm / 3kHz)	Limit (dBm / 3kHz)	Conclusion
802.11b	1	-7.582	8	PASS
	6	-7.862	8	PASS
	11	-7.482	8	PASS
802.11g	1	-13.491	8	PASS
	6	-11.962	8	PASS
	11	-11.436	8	PASS
802.11n HT20	1	-12.312	8	PASS
	6	-12.327	8	PASS
	11	-12.995	8	PASS
Bluetooth (Low Energy)	0	-15.379	8	PASS
	19	-14.351	8	PASS
	39	-16.173	8	PASS



802.11b, Channel No.: 1



802.11g, Channel No.: 1

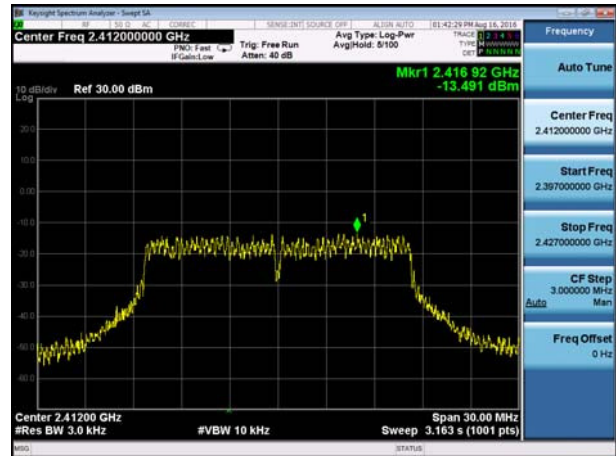

802.11b, Channel No.: 6



802.11g, Channel No.: 6

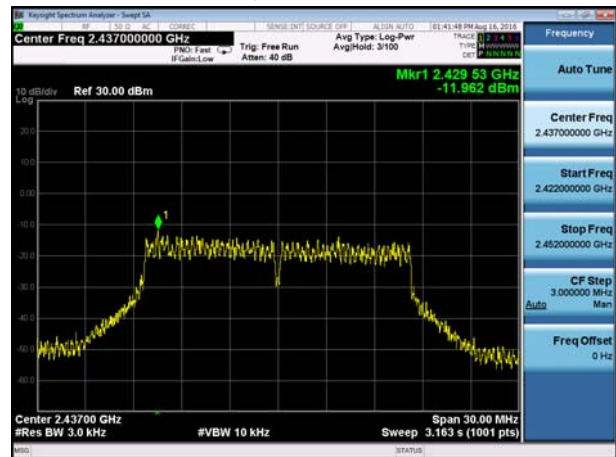

802.11b, Channel No.: 11



802.11g, Channel No.: 11

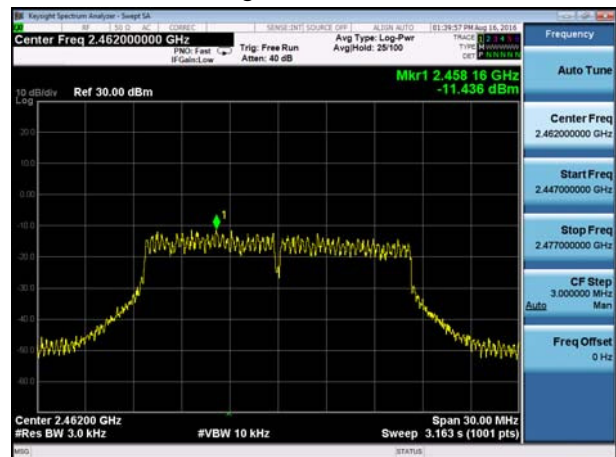



802.11n(HT20), Channel No. 1

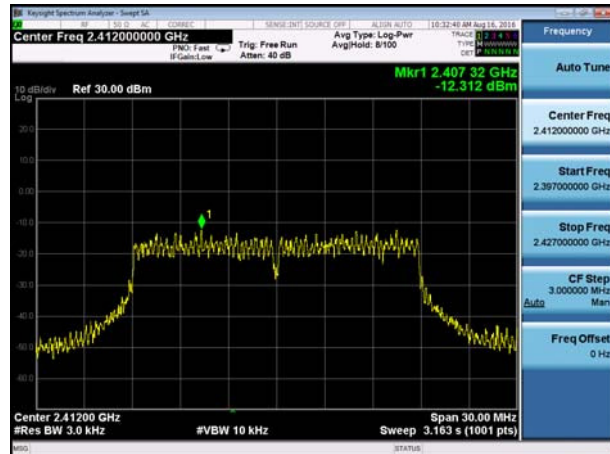

BLE, Channel No.: 0

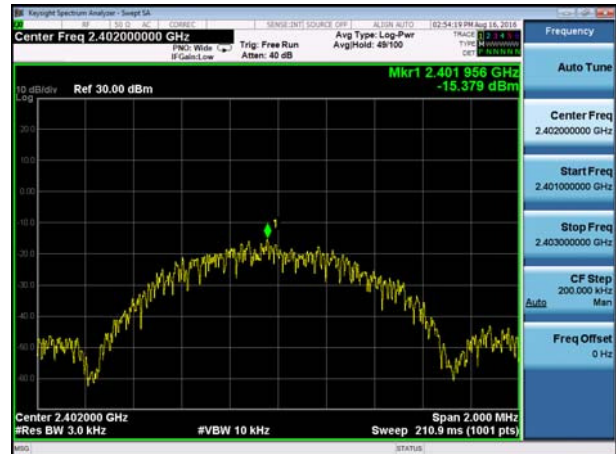

802.11n(HT20), Channel No. 6

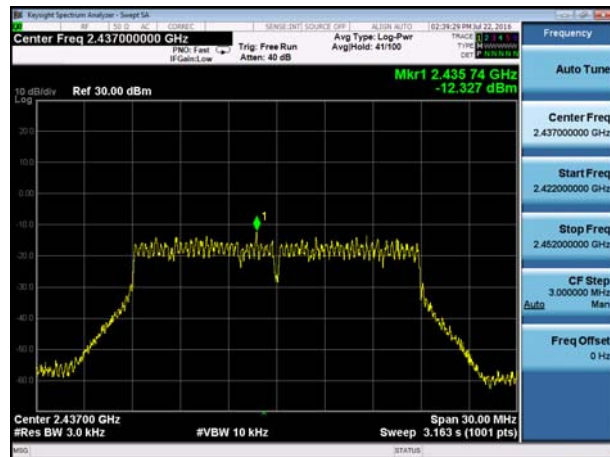

BLE, Channel No.: 19



802.11n(HT20), Channel No. 11

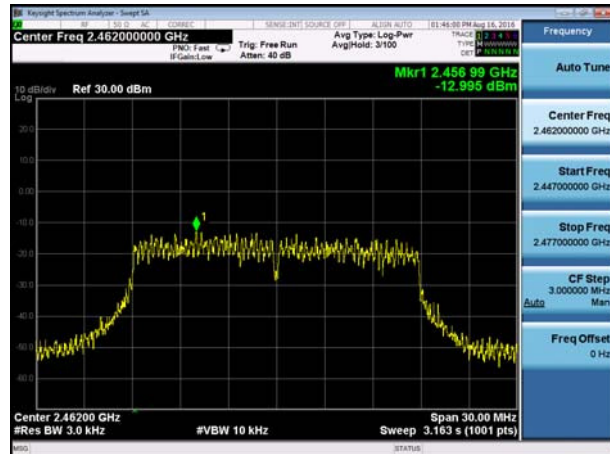

BLE, Channel No.: 39



5.5. Spurious RF Conducted Emissions

Ambient condition

Temperature	Relative humidity	Pressure
23°C ~25°C	45%~50%	101.5kPa

Method of Measurement

The EUT was connected to the spectrum analyzer with a known loss. The spectrum analyzer scans from 30MHz to the 10th harmonic of the carrier. The peak detector is used. RBW and VBW are set to 100 kHz, Sweep is set to ATUO.

The test is in transmitting mode.

Test setup



Limits

Rule Part 15.247(d) pacifies that “In any 100 kHz bandwidth outside the frequency band in which the spread spectrum intentional radiator is operating, the radio frequency power that is produced by the intentional radiator shall be at least 20 dB below that in the 100 kHz bandwidth within the band that contains the highest level of the desired power.”

Network Standards	Carrier frequency (MHz)	Reference value (dBm)	Limit
802.11b	2412	-17.853	-37.853
	2437	-20.047	-40.047
	2462	-24.355	-44.355
802.11g	2412	-23.308	-43.308
	2437	-24.802	-44.802
	2462	-24.204	-44.204
802.11n HT20	2412	-21.421	-41.421
	2437	-23.971	-43.971
	2462	-25.888	-45.888
Bluetooth (Low Energy)	2402	-29.082	-49.082
	2440	-27.716	-47.716
	2480	-28.350	-48.350



Measurement Uncertainty

The assessed measurement uncertainty to ensure 95% confidence level for the normal distribution is with the coverage factor $k = 1.96$.

Frequency	Uncertainty
100kHz-2GHz	0.684 dB
2GHz-26GHz	1.407 dB



Test Results:

If disturbances were found more than 20dB below limit line, the mark is not required for the EUT.
The signal beyond the limit is carrier.

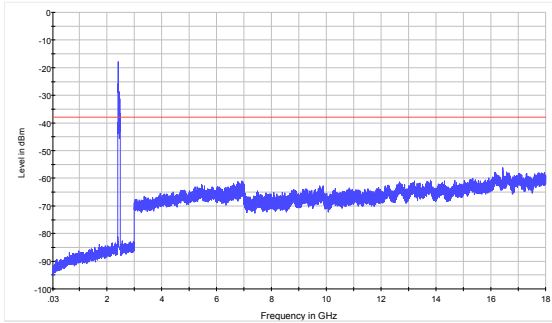

802.11b CH1 30MHz to 18GHz

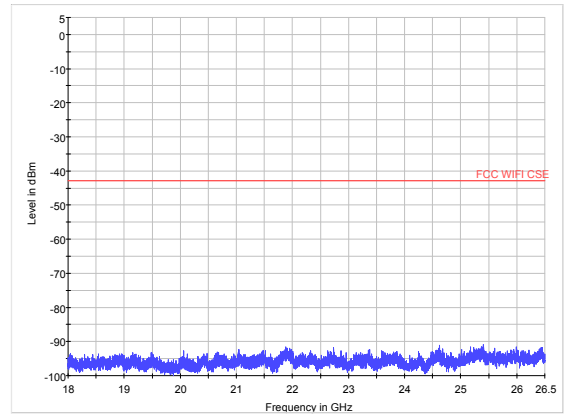

802.11b CH1 18GHz to 26.5GHz

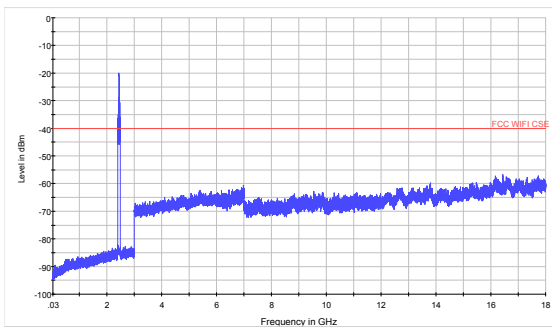

802.11b CH6 30MHz to 18GHz

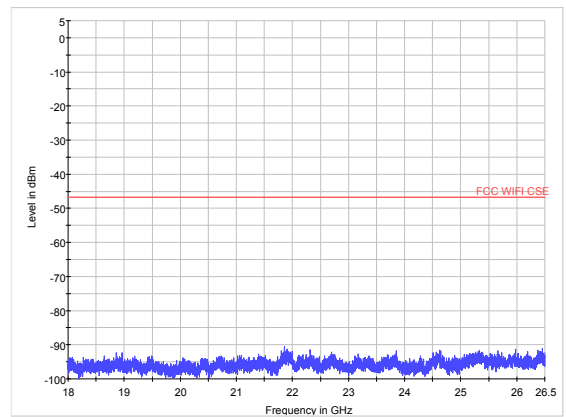

802.11b CH6 18GHz to 26.5GHz

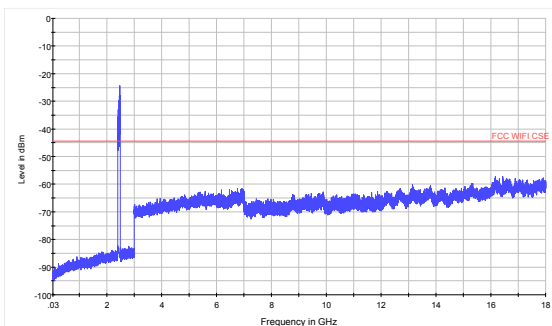

802.11b CH11 30MHz to 18GHz

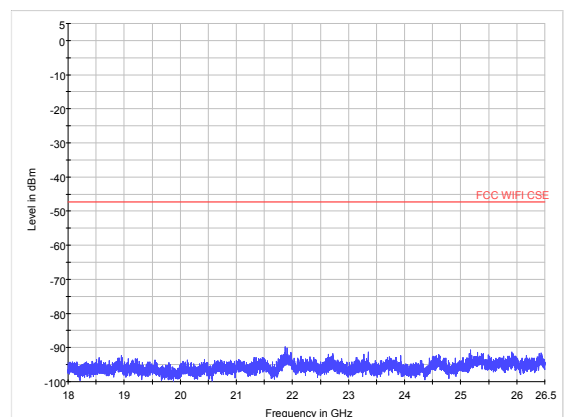

802.11b CH11 18GHz to 26.5GHz

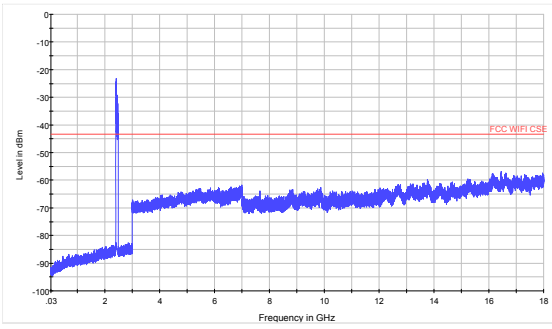

802.11g CH1 30MHz to 18GHz

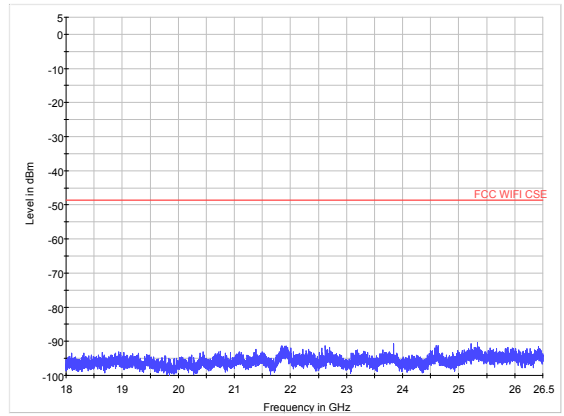

802.11g CH1 18GHz to 26.5GHz

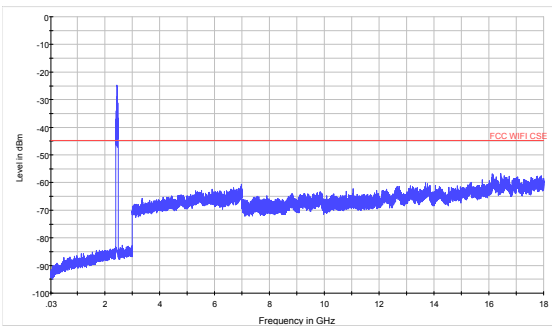

802.11g CH6 30MHz to 18GHz

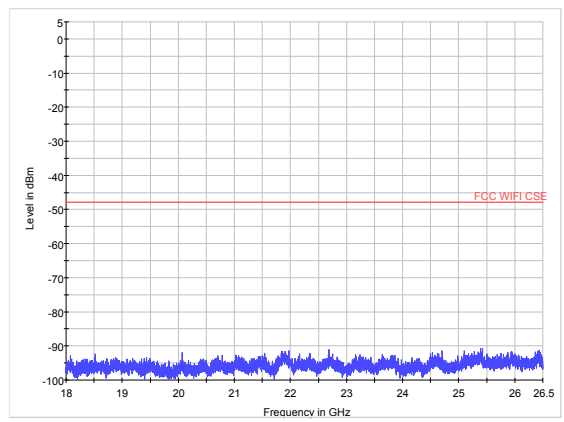

802.11g CH6 18GHz to 26.5GHz

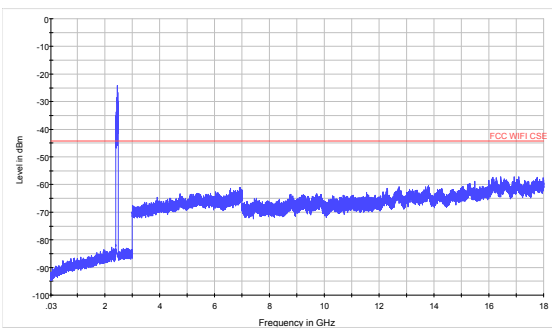

802.11g CH11 30MHz to 18GHz

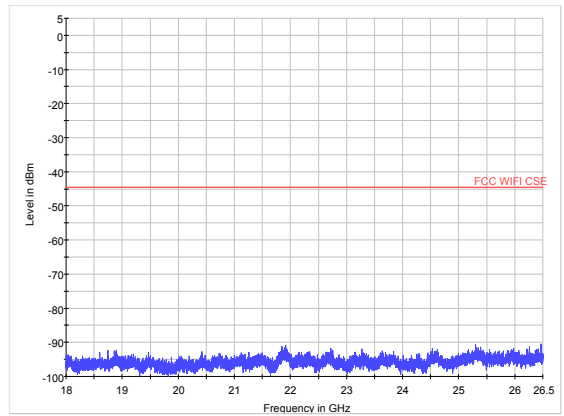

802.11g CH11 18GHz to 26.5GHz

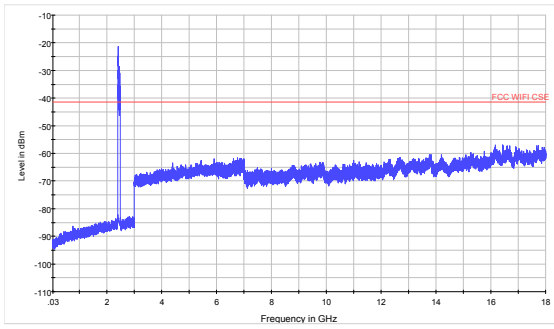

802.11n (HT20) CH1 30MHz to 18GHz

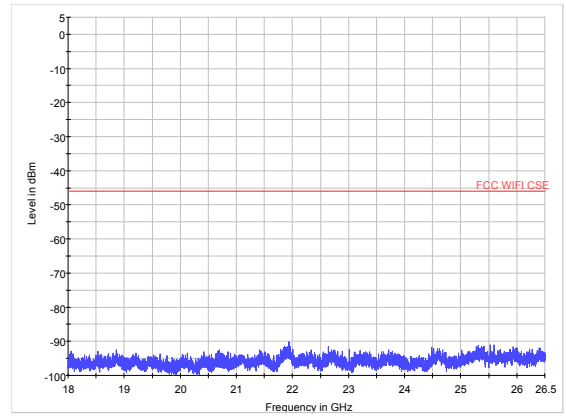

802.11n (HT20) CH1 18GHz to 26.5GHz

802.11n (HT20)

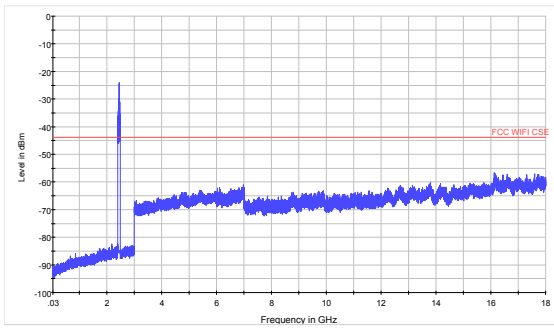

CH6 30MHz to 18GHz

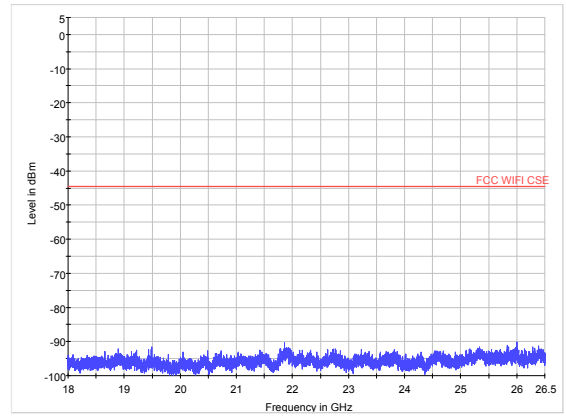

802.11n (HT20) CH6 18GHz to 26.5GHz

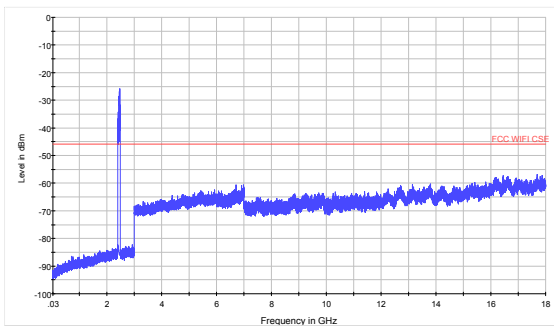

802.11n (HT20) CH11 30MHz to 18GHz

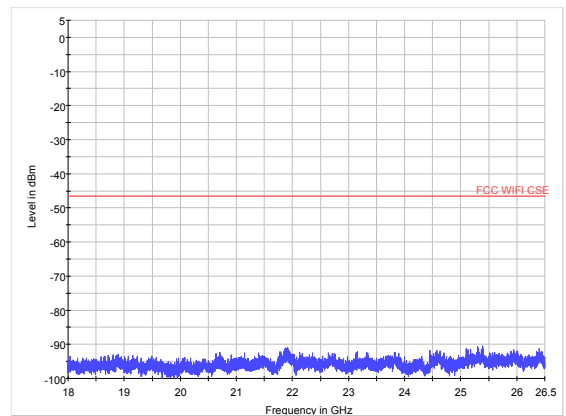

02.11n (HT20) CH11 18GHz to 26.5GHz

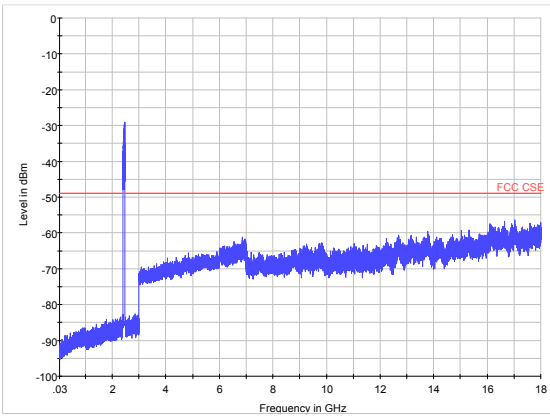

BLE CH0 30MHz to 18GHz

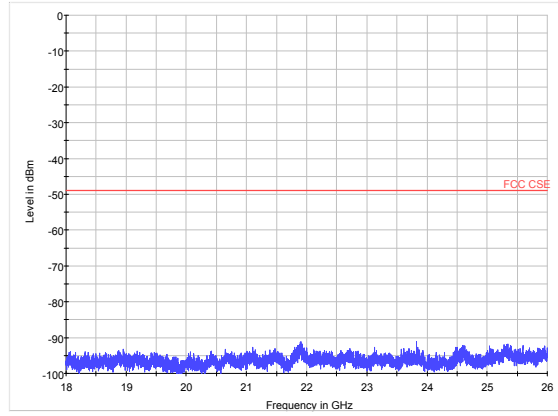

BLE CH0 18GHz to 26.5GHz

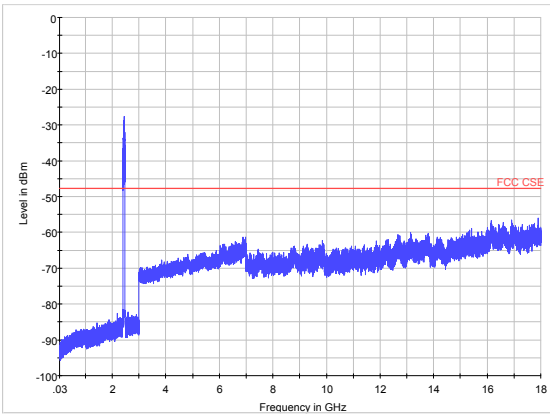

BLE CH19 30MHz to 18GHz

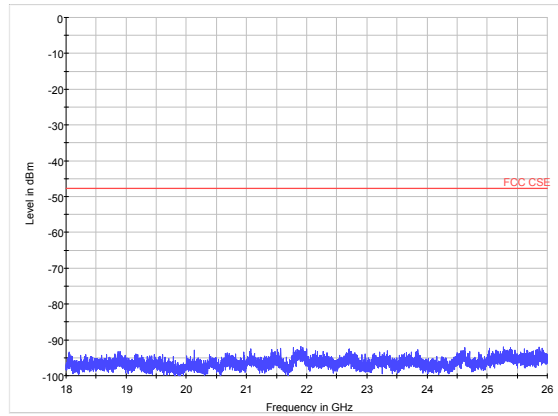

BLE CH19 18GHz to 26.5GHz

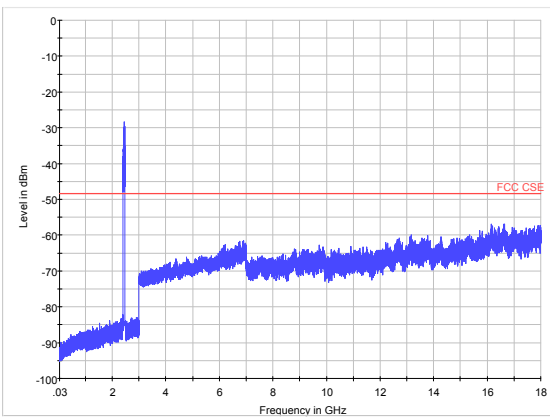

BLE CH39 30MHz to 18GHz

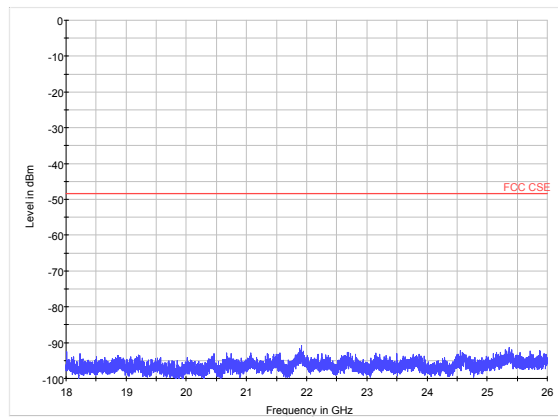

BLE CH39 18GHz to 26.5GHz

5.6. Radiated Emissions in the Restricted Band

Ambient condition

Temperature	Relative humidity	Pressure
23°C ~25°C	45%~50%	101.5kPa

Method of Measurement

The Equipment Under Test (EUT) was set up on a non-conductive table in the semi-anechoic chamber. The test was performed at the distance of 3 m between the EUT and the receiving antenna. The turntable shall be rotated from 0 to 360 degrees for detecting the maximum of radiated spurious signal level. The measurements shall be repeated with orthogonal polarization of the test antenna. RBW is set to 100kHz. The data of cable loss and antenna factor has been calibrated in full testing frequency range before the testing. Sweep the whole frequency band through the range from 9kHz to the 10th harmonic of the carrier, and the emissions less than 20 dB below the permissible value are reported.

Set the spectrum analyzer in the following:

- (a) PEAK: RBW=VBW=1MHz / Sweep=AUTO
- (b) AVERAGE: RBW=1MHz / VBW=1MHz / Sweep=AUTO

This setting method can refer to **KDB 558074**.

The field strength of spurious emission was measured in the following position: EUT stand-up position (Z axis), lie-down position (X, Y axis). The worst emission was found in stand-up position (Y axis) and the antenna is vertical.

The test is in transmitting mode.

Test setup

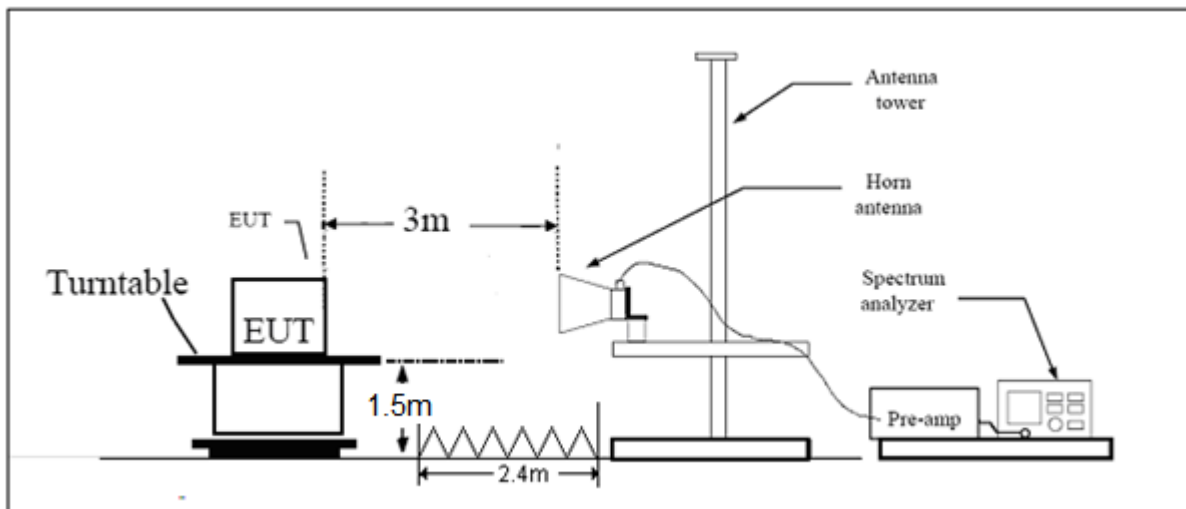

Note: Area side: 2.4mX3.6m

Limits

Spurious Radiated Emissions are permitted in any of the frequency bands listed below:

MHz	MHz	MHz	GHz
0.090 - 0.110	16.42 - 16.423	399.9 - 410	4.5 - 5.15
¹ 0.495 - 0.505	16.69475 - 16.69525	608 - 614	5.35 - 5.46
2.1735 - 2.1905	16.80425 - 16.80475	960 - 1240	7.25 - 7.75
4.125 - 4.128	25.5 - 25.67	1300 - 1427	8.025 - 8.5
4.17725 - 4.17775	37.5 - 38.25	1435 - 1626.5	9.0 - 9.2
4.20725 - 4.20775	73 - 74.6	1645.5 - 1646.5	9.3 - 9.5
6.215 - 6.218	74.8 - 75.2	1660 - 1710	10.6 - 12.7
6.26775 - 6.26825	108 - 121.94	1718.8 - 1722.2	13.25 - 13.4
6.31175 - 6.31225	123 - 138	2200 - 2300	14.47 - 14.5
8.291 - 8.294	149.9 - 150.05	2310 - 2390	15.35 - 16.2
8.362 - 8.366	156.52475 - 156.52525	2483.5 - 2500	17.7 - 21.4
8.37625 - 8.38675	156.7 - 156.9	2690 - 2900	22.01 - 23.12
8.41425 - 8.41475	162.0125 - 167.17	3260 - 3267	23.6 - 24.0
12.29 - 12.293	167.72 - 173.2	3332 - 3339	31.2 - 31.8
12.51975 - 12.52025	240 - 285	3345.8 - 3358	36.43 - 36.5
12.57675 - 12.57725	322 - 335.4	3600 - 4400	(²)
13.36 - 13.41			

Limit in restricted band

Frequency of emission (MHz)	Field strength(uV/m)	Field strength(dBuV/m)
30-88	100	40
88-216	150	43.5
216-960	200	46
Above960	500	54

§15.35(b)

There is also a limit on the radio frequency emissions, as measured using instrumentation with a peak detector function, corresponding to 20 dB above the maximum permitted average limit.

Peak Limit=74 dBuV/m

Average Limit=54 dBuV/m

Measurement Uncertainty

The assessed measurement uncertainty to ensure 95% confidence level for the normal distribution is with the coverage factor $k = 1.96$, $U = 3.55$ dB.



Test Results:

PASS

The signal beyond the limit is carrier.

802.11b-Channel 1: Peak

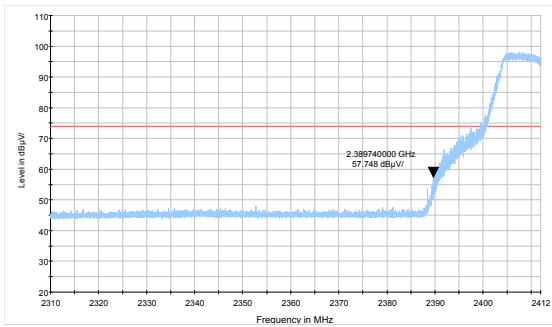

802.11b-Channel 1: Average

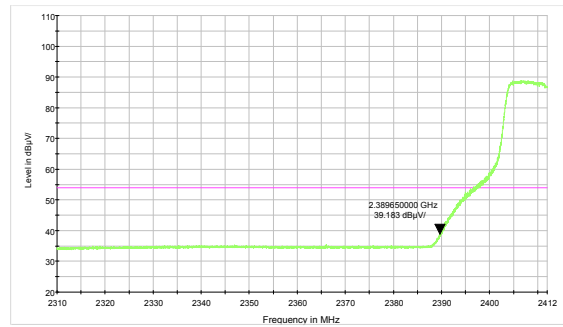

802.11b-Channel 11: Peak

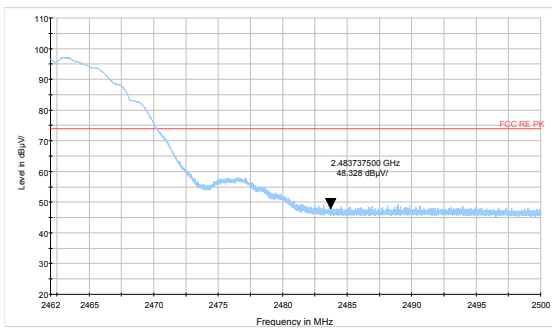

802.11b-Channel 11: Average

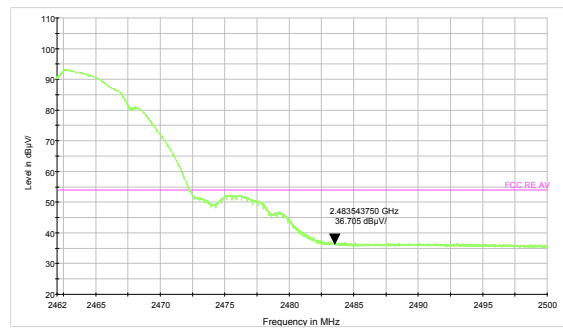

802.11g-Channel 1: Peak

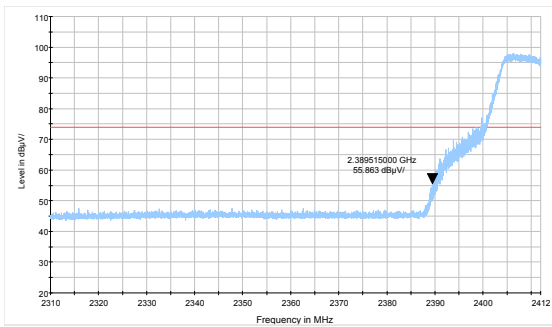

802.11g-Channel 1: Average

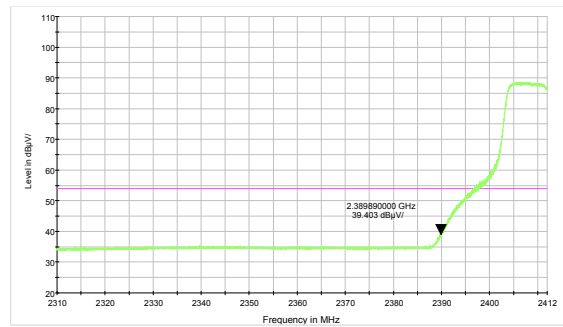

802.11g-Channel 11: Peak

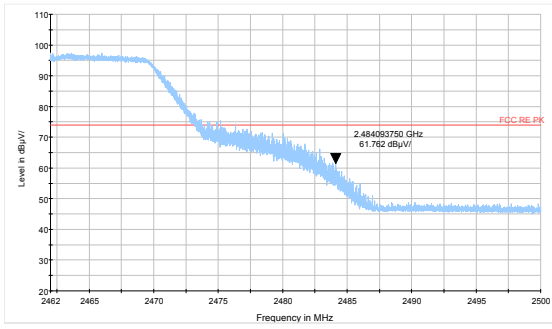

802.11g-Channel 11: Average

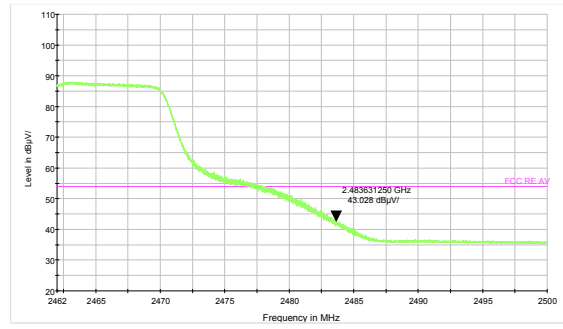

802.11n HT20 -Channel 1: Peak

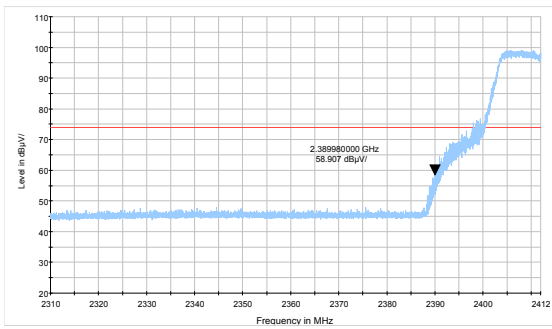

802.11n HT20-Channel 1: Average

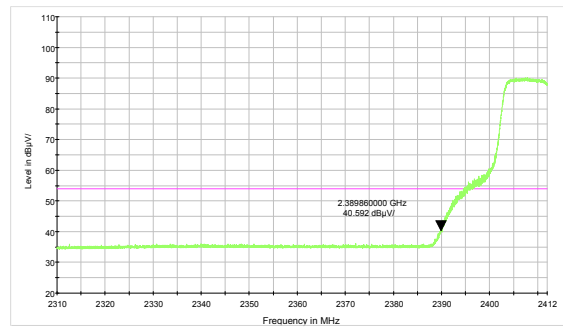

802.11n HT20-Channel 11: Peak

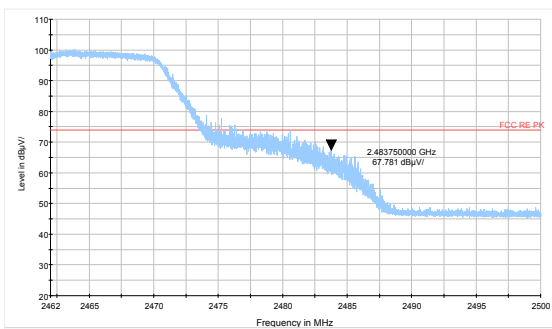

802.11n HT20-Channel 11: Average

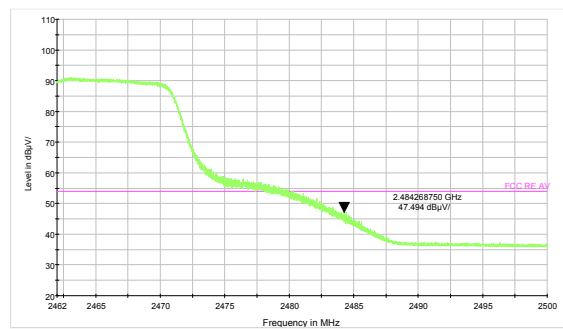

BLE -Channel 0: Peak

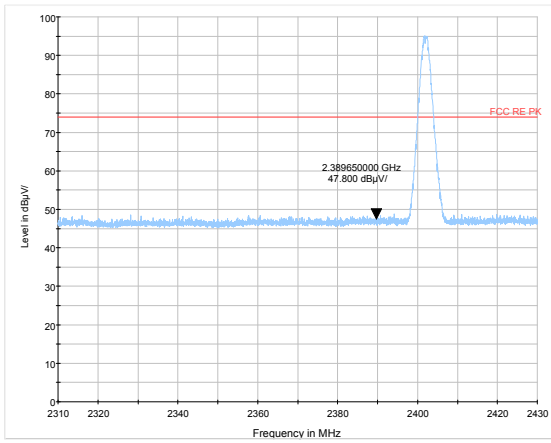

BLE -Channel 0: Average

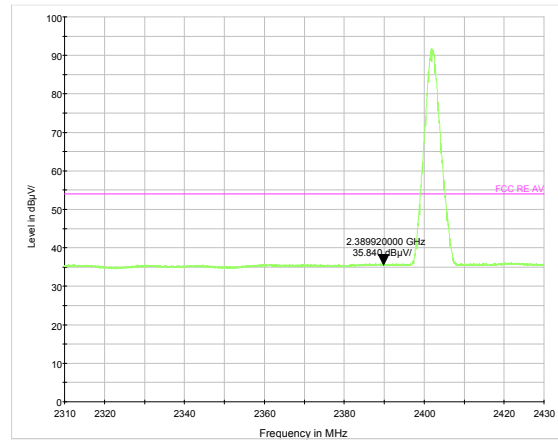

BLE -Channel 39: Peak

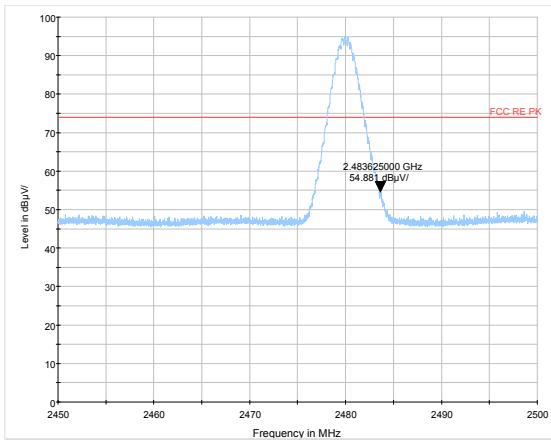

BLE -Channel 39: Average

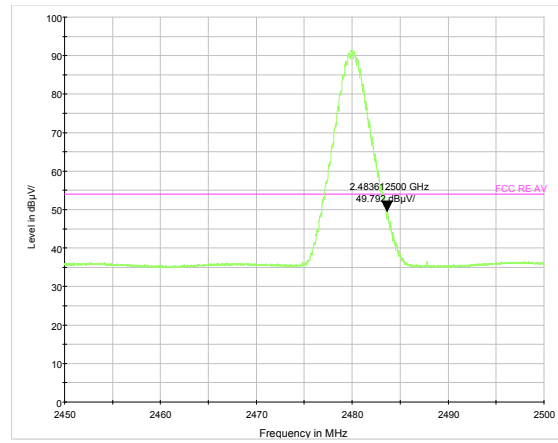

5.7. Radiates Emission

Ambient condition

Temperature	Relative humidity	Pressure
23°C ~25°C	45%~50%	102.5kPa

Method of Measurement

The test set-up was made in accordance to the general provisions of ANSI C63.10-2013. The Equipment Under Test (EUT) was set up on a non-conductive table in the semi-anechoic chamber. The test was performed at the distance of 3 m between the EUT and the receiving antenna. The radiated emissions measurements were made in a typical installation configuration.

Sweep the whole frequency band through the range from 9 kHz to the 10th harmonic of the carrier, and the emissions less than 20 dB below the permissible value are reported.

During the test, below 30MHz, the center of the loop shall be 1 meters; above 30MHz, the height of receive antenna shall be moved from 1 to 4 meters, and the antenna shall be performed under horizontal and vertical polarization. The turntable shall be rotated from 0 to 360 degrees for detecting the maximum of radiated spurious signal level. The measurements shall be repeated with orthogonal polarization of the test antenna. The data of cable loss and antenna factor has been calibrated in full testing frequency range before the testing.

Set the spectrum analyzer in the following:

Below 1GHz (detector: Peak and Quasi-Peak)

RBW=100 kHz / VBW=300 kHz / Sweep=AUTO

Above 1GHz (detector: Peak):

(a) PEAK: RBW=1MHz VBW=3MHz/ Sweep=AUTO

(b) AVERAGE: RBW=1MHz / VBW=3MHz / Sweep=AUTO

The radiated emission was measured in the following position: EUT stand-up position (Z axis), lie-down position (X, Y axis). The worst emission was found in stand-up position (Z axis) and the worst case was recorded.

The test is in transmitting mode.

Test setup

9KHz~~~ 30MHz

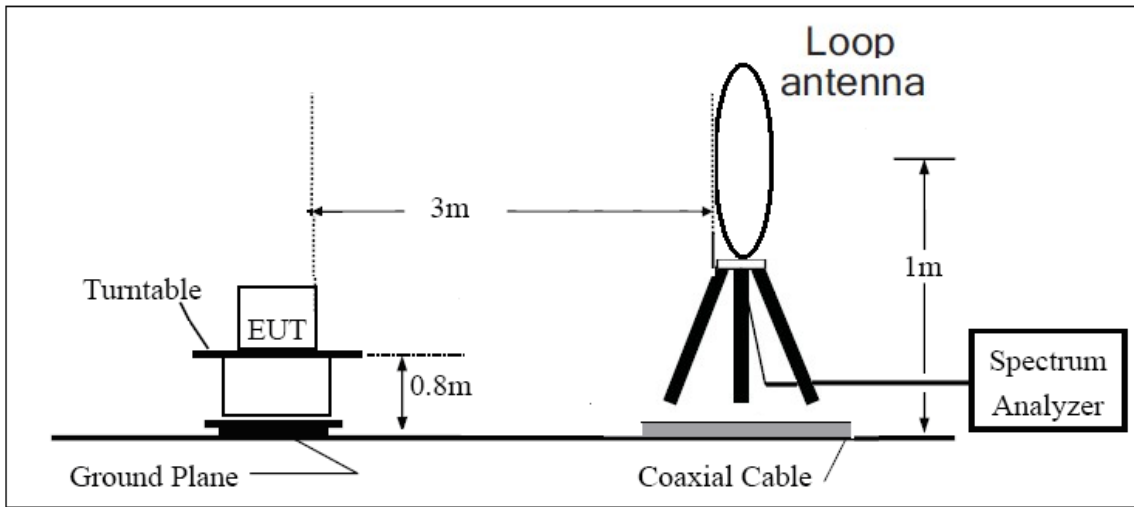

30MHz~~~ 1GHz

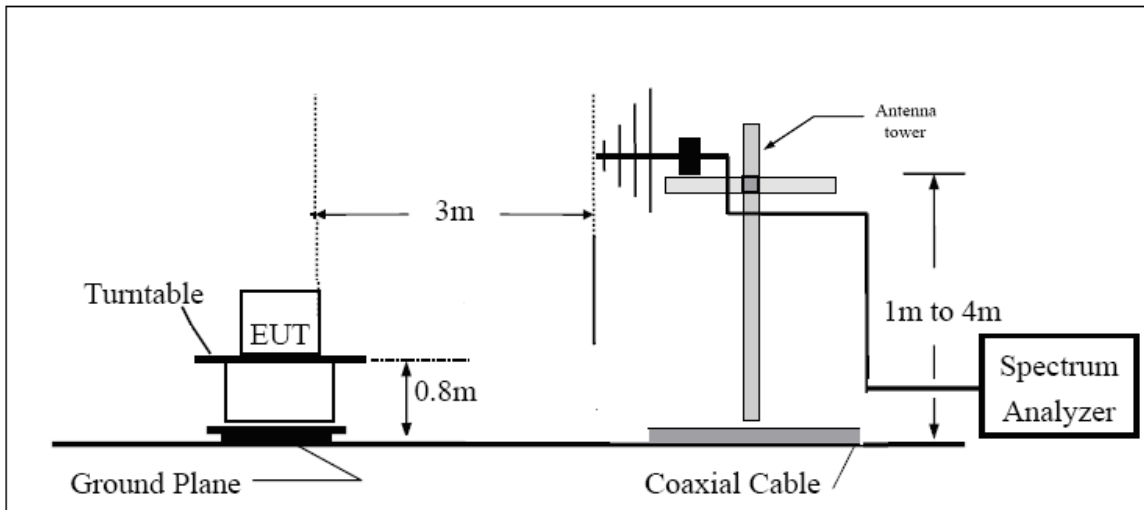

Above 1GHz

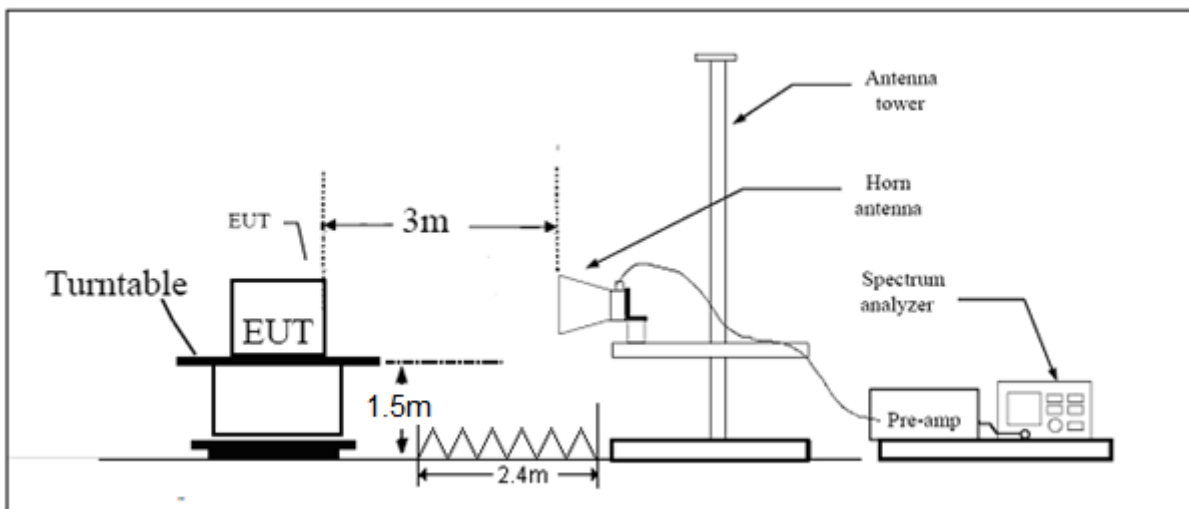

Note: Area side:2.4mX3.6m

Limits

Rule Part 15.247(d) specifies that “In addition, radiated emissions which fall in the restricted bands, as defined in § 15.205(a), must also comply with the radiated emission limits specified in § 15.209(a) (see § 15.205(c)).”

Limit in restricted band

Frequency of emission (MHz)	Field strength(uV/m)	Field strength(dBuV/m)
0.009–0.490	2400/F(kHz)	/
0.490–1.705	24000/F(kHz)	/
1.705–30.0	30	/
30-88	100	40
88-216	150	43.5
216-960	200	46
Above960	500	54

§15.35(b)

There is also a limit on the radio frequency emissions, as measured using instrumentation with a peak detector function, corresponding to 20 dB above the maximum permitted average limit.

Measurement Uncertainty

The assessed measurement uncertainty to ensure 95% confidence level for the normal distribution is with the coverage factor $k = 1.96$.

Frequency	Uncertainty
9KHz-30MHz	3.55 dB
30MHz-200MHz	4.19 dB
200MHz-1GHz	3.63 dB
Above 1GHz	3.68 dB

Test result

Sweep from 9 kHz to 30MHz, and the emissions more than 20 dB below the permissible value are not reported.

The following graphs display the maximum values of horizontal and vertical by software.

For above 1GHz, Blue trace uses the peak detection, Green trace uses the average detection.

802.11b CH1

FCC RE 0.03-1GHz QP Class C

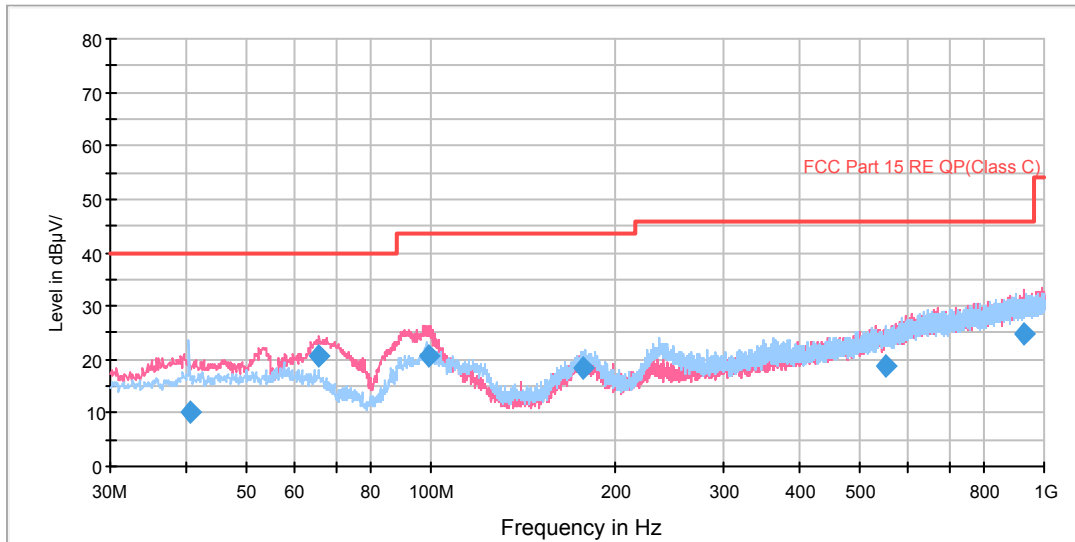

Radiates Emission from 30MHz to 1GHz

Frequency (MHz)	Quasi-Peak (dBuV/m)	Height (cm)	Polarization	Azimuth (deg)	Reading value (dBuV/m)	Correct Factor (dB)	Margin (dB)	Limit (dBuV/m)
40.466250	10.1	125.0	H	301.0	23.3	13.2	29.9	40.0
65.727500	20.5	100.0	V	213.0	30.7	10.2	19.5	40.0
98.993750	20.5	100.0	V	290.0	33.6	13.1	23.0	43.5
177.647500	18.4	125.0	H	277.0	29.1	10.7	25.1	43.5
553.672500	18.6	100.0	H	36.0	39.8	21.2	27.4	46.0
928.457500	25.0	125.0	V	267.0	50.9	25.9	21.0	46.0

- Remark:**
1. Quasi-Peak = Reading value + Correction factor
 2. Correction Factor = Antenna factor+ Insertion loss (cable loss+amplifier gain)
 3. Margin = Limit – Quasi-Peak

RE 1G-3GHz PK+AV

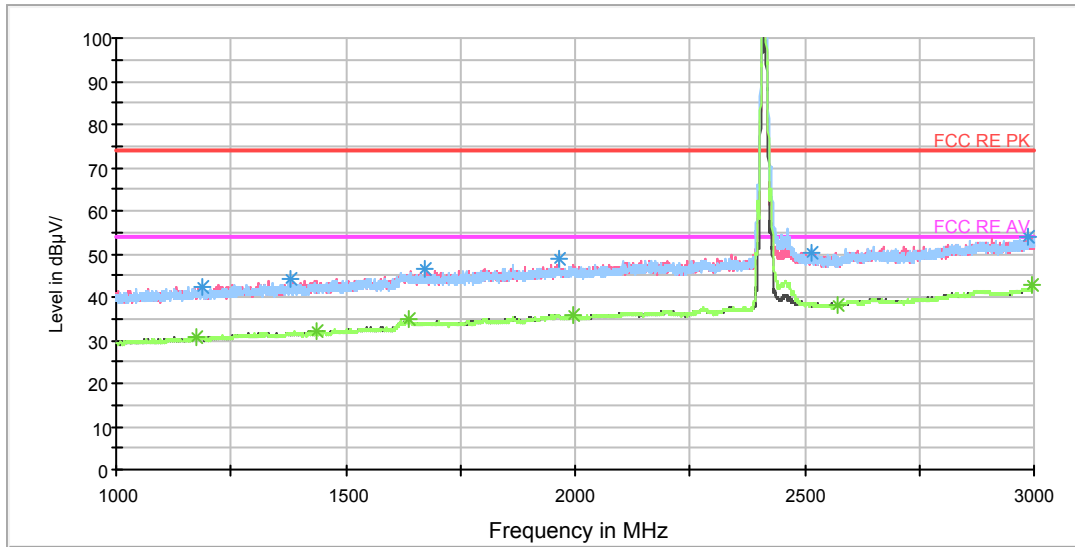

Note: The signal beyond the limit is carrier.
Radiates Emission from 1GHz to 3GHz

Frequency (MHz)	Peak (dBuV/m)	Height (cm)	Polarization	Azimuth (deg)	Reading value (dBuV/m)	Correct Factor (dB)	Margin (dB)	Limit (dBuV/m)
1186.500000	42.5	102.0	V	152.0	50.6	-8.1	31.5	74
1380.000000	44.1	102.0	H	0.0	51.1	-7.0	29.9	74
1673.750000	46.3	102.0	H	0.0	51.4	-5.1	27.7	74
1963.500000	48.8	102.0	H	0.0	52.1	-3.3	25.2	74
2516.500000	50.3	102.0	H	0.0	50.6	-0.3	23.7	74
2987.000000	54.0	102.0	H	2.0	56.2	2.2	20.0	74

Remark: 1. Correction Factor = Antenna factor+ Insertion loss (cable loss + amplifier gain)

Frequency (MHz)	Average (dBuV/m)	Height (cm)	Polarization	Azimuth (deg)	Reading value (dBuV/m)	Correct Factor (dB)	Margin (dB)	Limit (dBuV/m)
1174.000000	30.8	102.0	V	0.0	38.9	-8.1	23.2	54
1437.000000	31.9	102.0	H	34.0	38.8	-6.9	22.1	54
1638.500000	34.7	102.0	V	263.0	39.4	-4.7	19.3	54
1996.500000	36.0	102.0	V	0.0	39.3	-3.3	18.0	54
2571.250000	38.2	102.0	H	49.0	38.8	-0.6	15.8	54
2995.750000	42.6	102.0	V	0.0	44.9	2.3	11.4	54

Remark: 1. Correction Factor = Antenna factor+ Insertion loss (cable loss + amplifier gain)

RE 3-18GHz PK+AV

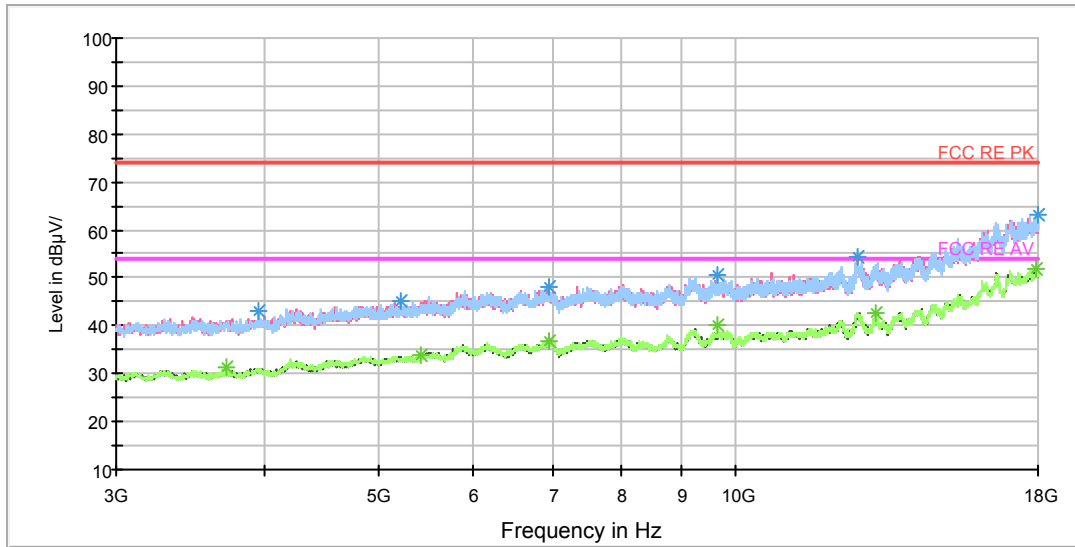

Radiates Emission from 3GHz to 18GHz

Frequency (MHz)	Peak (dBuV/m)	Height (cm)	Polarization	Azimuth (deg)	Reading value (dBuV/m)	Correct Factor (dB)	Margin (dB)	Limit (dBuV/m)
3960.000000	43.2	102.0	H	230.0	44.2	-1.0	30.8	74
5223.750000	45.1	102.0	V	197.0	47.2	2.1	28.9	74
6946.875000	48.1	102.0	H	0.0	54.3	6.2	25.9	74
9646.875000	50.7	102.0	H	166.0	60.5	9.8	23.3	74
12673.125000	54.3	102.0	V	307.0	68.4	14.1	19.7	74
17990.625000	63.0	102.0	H	247.0	88.2	25.2	11.0	74

Remark: 1. Correction Factor = Antenna factor+ Insertion loss (cable loss + amplifier gain)

Frequency (MHz)	Average (dBuV/m)	Height (cm)	Polarization	Azimuth (deg)	Reading value (dBuV/m)	Correct Factor (dB)	Margin (dB)	Limit (dBuV/m)
3723.750000	31.2	102.0	H	247.0	32.8	-1.6	22.8	54
5426.250000	34.1	102.0	H	135.0	36.9	2.8	19.9	54
6963.750000	36.7	102.0	H	151.0	42.9	6.2	17.3	54
9646.875000	40.2	102.0	H	166.0	50.0	9.8	13.8	54
13147.500000	42.7	102.0	H	1.0	57.0	14.3	11.3	54
17917.500000	51.8	102.0	H	0.0	77.5	25.7	2.2	54

Remark: 1. Correction Factor = Antenna factor+ Insertion loss (cable loss + amplifier gain)

RE 18-26.5GHz PK+AV

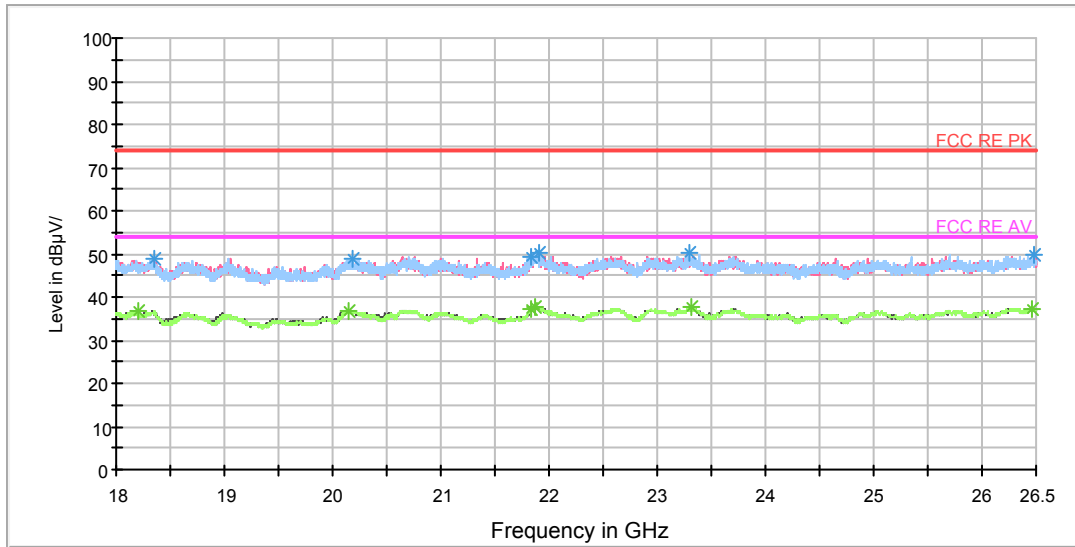

Radiates Emission from 18GHz to 26.5GHz

Frequency (MHz)	Peak (dBuV/m)	Polarization	Azimuth (deg)	Reading value (dBuV/m)	Correct Factor (dB)	Margin (dB)	Limit (dBuV/m)
18344.250000	48.8	V	353.0	52.1	-3.3	25.2	74
20176.000000	48.9	V	231.0	54.7	-5.8	25.1	74
21838.812500	49.3	H	18.0	57.3	-8.0	24.7	74
21901.500000	50.0	H	100.0	58.0	-8.0	24.0	74
23300.812500	50.1	H	0.0	56.1	-6.0	23.9	74
26480.875000	50.0	H	154.0	55.4	-5.4	24.0	74

Remark: 1. Correction Factor = Antenna factor+ Insertion loss (cable loss + amplifier gain)

Frequency (MHz)	Average (dBuV/m)	Polarization	Azimuth (deg)	Reading value (dBuV/m)	Correct Factor (dB)	Margin (dB)	Limit (dBuV/m)
18196.562500	36.6	H	46.0	39.2	-2.6	17.4	54
20147.312500	36.7	V	205.0	42.5	-5.8	17.3	54
21838.812500	37.2	V	326.0	45.2	-8.0	16.8	54
21866.437500	37.8	H	235.0	45.8	-8.0	16.2	54
23319.937500	37.5	V	326.0	43.5	-6.0	16.5	54
26457.500000	37.4	V	312.0	42.8	-5.4	16.6	54

Remark: 1. Correction Factor = Antenna factor+ Insertion loss (cable loss + amplifier gain)

802.11b CH6

FCC RE 0.03-1GHz QP Class C

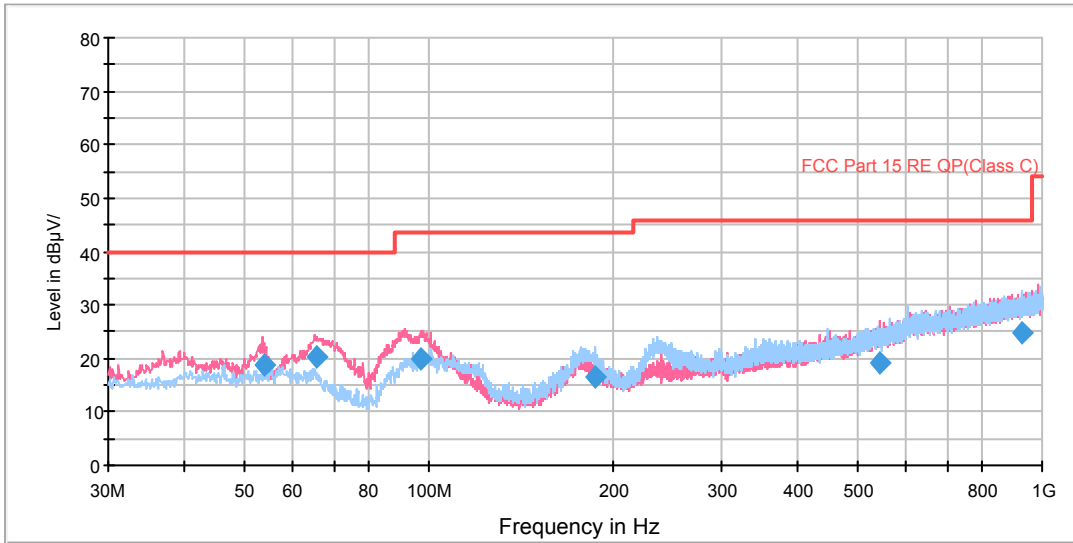

Radiates Emission from 30MHz to 1GHz

Frequency (MHz)	Quasi-Peak (dBuV/m)	Height (cm)	Polarization	Azimuth (deg)	Reading value (dBuV/m)	Correct Factor (dB)	Margin (dB)	Limit (dBuV/m)
53.762500	18.8	100.0	V	207.0	31.6	12.8	21.2	40.0
65.641250	20.4	100.0	V	212.0	30.7	10.3	19.6	40.0
97.370000	19.7	114.0	V	264.0	32.6	12.9	23.8	43.5
186.132500	16.7	125.0	H	255.0	27.9	11.2	26.8	43.5
541.716250	19.2	100.0	V	313.0	40.0	20.8	26.8	46.0
927.163750	24.9	100.0	H	356.0	50.7	25.8	21.1	46.0

- Remark:**
1. Quasi-Peak = Reading value + Correction factor
 2. Correction Factor = Antenna factor+ Insertion loss (cable loss+amplifier gain)
 3. Margin = Limit – Quasi-Peak

RE 1G-3GHz PK+AV

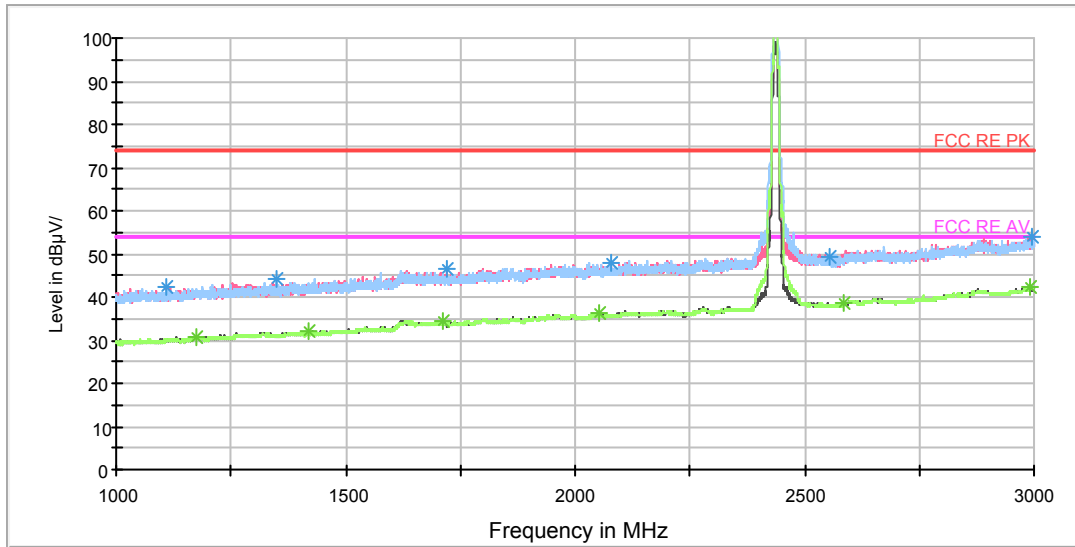

Note: The signal beyond the limit is carrier.

Radiates Emission from 1GHz to 3GHz

Frequency (MHz)	Peak (dBuV/m)	Height (cm)	Polarization	Azimuth (deg)	Reading value (dBuV/m)	Correct Factor (dB)	Margin (dB)	Limit (dBuV/m)
1108.250000	42.4	102.0	V	0.0	51.1	-8.7	31.6	74
1350.250000	44.2	102.0	H	0.0	51.8	-7.6	29.8	74
1718.750000	46.4	102.0	V	85.0	51.3	-4.9	27.6	74
2079.500000	48.1	102.0	H	0.0	51.1	-3.0	25.9	74
2555.000000	49.2	102.0	H	61.0	49.7	-0.5	24.8	74
2996.500000	54.1	102.0	V	167.0	56.4	2.3	19.9	74

Remark: 1. Correction Factor = Antenna factor+ Insertion loss (cable loss + amplifier gain)

Frequency (MHz)	Average (dBuV/m)	Height (cm)	Polarization	Azimuth (deg)	Reading value (dBuV/m)	Correct Factor (dB)	Margin (dB)	Limit (dBuV/m)
1174.750000	30.8	102.0	V	199.0	38.8	-8.0	23.2	54
1420.250000	32.0	102.0	V	300.0	38.9	-6.9	22	54
1711.750000	34.4	102.0	V	118.0	39.2	-4.8	19.6	54
2051.000000	36.1	102.0	H	0.0	39.3	-3.2	17.9	54
2587.000000	38.7	102.0	V	199.0	38.8	-0.1	15.3	54
2992.250000	42.4	102.0	V	0.0	44.6	2.2	11.6	54

Remark: 1. Correction Factor = Antenna factor+ Insertion loss (cable loss + amplifier gain)

RE 3-18GHz PK+AV

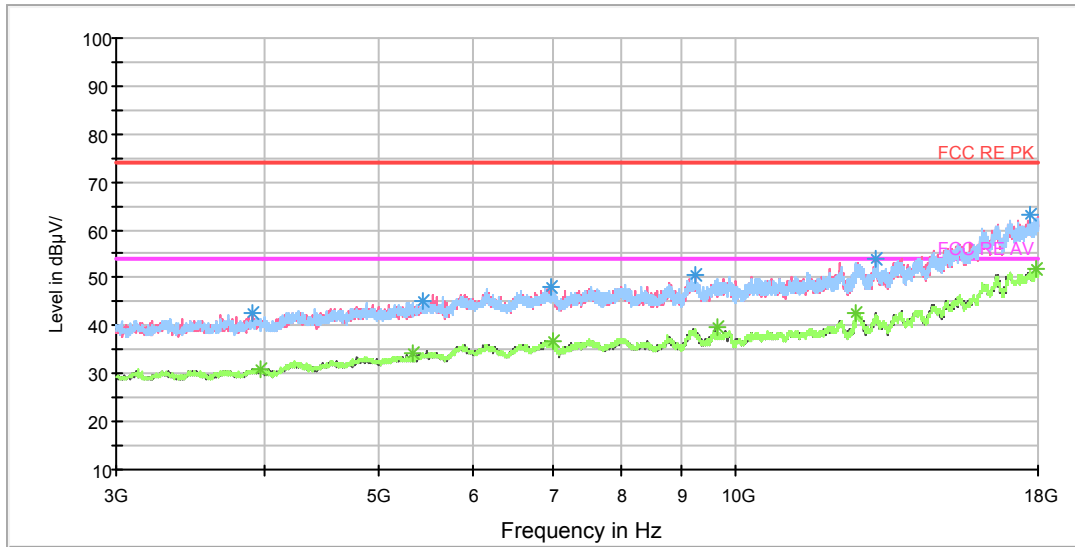

Radiates Emission from 3GHz to 18GHz

Frequency (MHz)	Peak (dBuV/m)	Height (cm)	Polarization	Azimuth (deg)	Reading value (dBuV/m)	Correct Factor (dB)	Margin (dB)	Limit (dBuV/m)
3915.000000	42.8	102.0	V	0.0	44.0	-1.2	31.2	74
5446.875000	45.1	102.0	V	305.0	47.9	2.8	28.9	74
6976.875000	48.0	102.0	V	352.0	54.3	6.3	26.0	74
9245.625000	50.6	102.0	V	116.0	60.4	9.8	23.4	74
13138.125000	54.1	102.0	V	0.0	68.4	14.3	19.9	74
17698.125000	63.0	102.0	H	115.0	87.7	24.7	11.0	74

Remark: 1. Correction Factor = Antenna factor+ Insertion loss (cable loss + amplifier gain)

Frequency (MHz)	Average (dBuV/m)	Height (cm)	Polarization	Azimuth (deg)	Reading value (dBuV/m)	Correct Factor (dB)	Margin (dB)	Limit (dBuV/m)
3963.750000	31.0	102.0	V	195.0	32.0	-1.0	23.0	54
5336.250000	34.1	102.0	V	322.0	36.4	2.3	19.9	54
6999.375000	36.8	102.0	H	0.0	43.3	6.5	17.2	54
9646.875000	39.8	102.0	H	193.0	49.6	9.8	14.2	54
12646.875000	42.8	102.0	H	0.0	57.1	14.3	11.2	54
17923.125000	52.1	102.0	V	305.0	77.8	25.7	1.9	54

Remark: 1. Correction Factor = Antenna factor+ Insertion loss (cable loss + amplifier gain)

RE 18-26.5GHz PK+AV

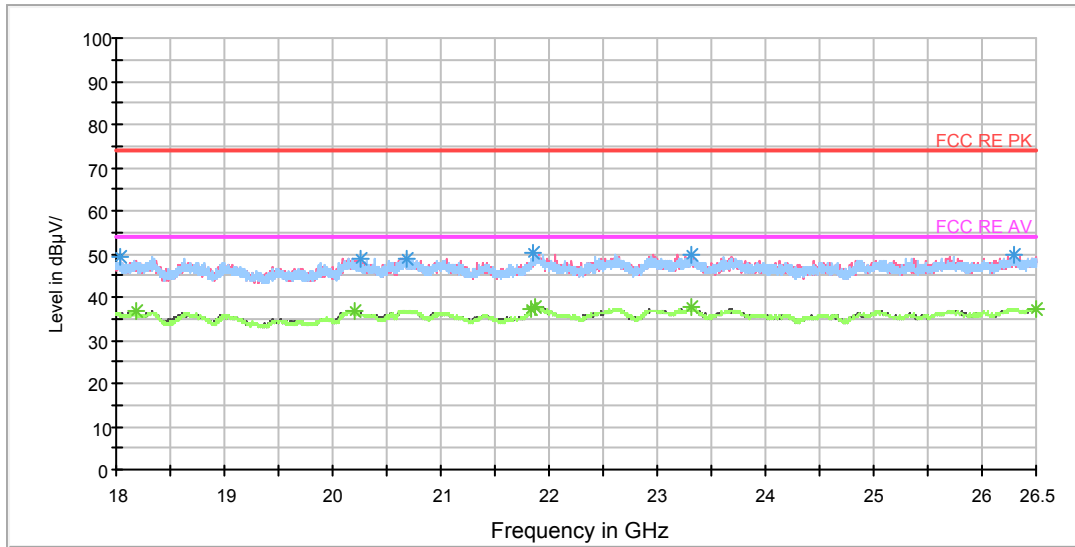

Radiates Emission from 18GHz to 26.5GHz

Frequency (MHz)	Peak (dBuV/m)	Polarization	Azimuth (deg)	Reading value (dBuV/m)	Correct Factor (dB)	Margin (dB)	Limit (dBuV/m)
18042.500000	49.5	V	124.0	51.5	-2.0	24.5	74
20253.562500	48.9	V	232.0	54.8	-5.9	25.1	74
20689.187500	49.1	V	353.0	55.8	-6.7	24.9	74
21846.250000	50.2	H	4.0	58.2	-8.0	23.8	74
23318.875000	49.7	H	140.0	55.7	-6.0	24.3	74
26296.000000	50.0	V	165.0	55.4	-5.4	24.0	74

Remark: 1. Correction Factor = Antenna factor+ Insertion loss (cable loss + amplifier gain)

Frequency (MHz)	Average (dBuV/m)	Polarization	Azimuth (deg)	Reading value (dBuV/m)	Correct Factor (dB)	Margin (dB)	Limit (dBuV/m)
18183.812500	36.7	V	286.0	39.3	-2.6	17.3	54
20196.187500	36.8	V	0.0	42.7	-5.9	17.2	54
21838.812500	37.2	V	138.0	45.2	-8.0	16.8	54
21876.000000	37.8	V	313.0	45.8	-8.0	16.2	54
23316.750000	37.4	H	0.0	43.4	-6.0	16.6	54
26497.875000	37.4	H	4.0	42.8	-5.4	16.6	54

Remark: 1. Correction Factor = Antenna factor+ Insertion loss (cable loss + amplifier gain)



802.11b CH11

FCC RE 0.03-1GHz QP Class C

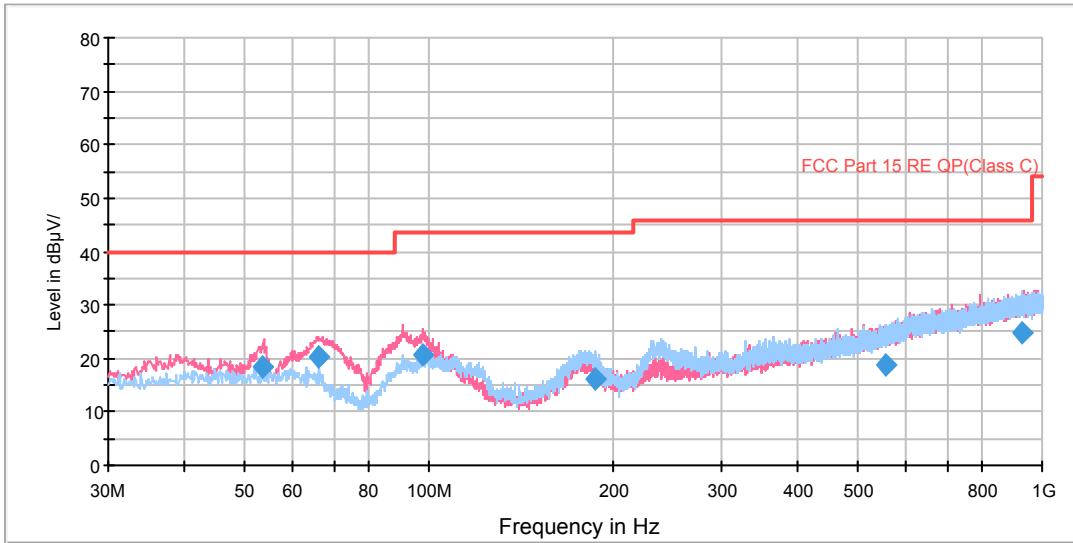

Radiates Emission from 30MHz to 1GHz

Frequency (MHz)	Quasi-Peak (dBuV/m)	Height (cm)	Polarization	Azimuth (deg)	Reading value (dBuV/m)	Correct Factor (dB)	Margin (dB)	Limit (dBuV/m)
53.445000	18.3	100.0	V	220.0	31.1	12.8	21.7	40.0
66.250000	20.4	100.0	V	202.0	30.4	10.0	19.6	40.0
97.820000	20.5	100.0	V	291.0	33.4	12.9	23.0	43.5
186.782500	16.0	114.0	H	269.0	27.2	11.2	27.5	43.5
555.656250	18.7	100.0	H	142.0	39.9	21.2	27.3	46.0
926.801250	24.9	125.0	H	63.0	50.7	25.8	21.1	46.0

- Remark: 1. Quasi-Peak = Reading value + Correction factor
- 2. Correction Factor = Antenna factor+ Insertion loss(cable loss+amplifier gain)
- 3. Margin = Limit – Quasi-Peak

RE 1G-3GHz PK+AV

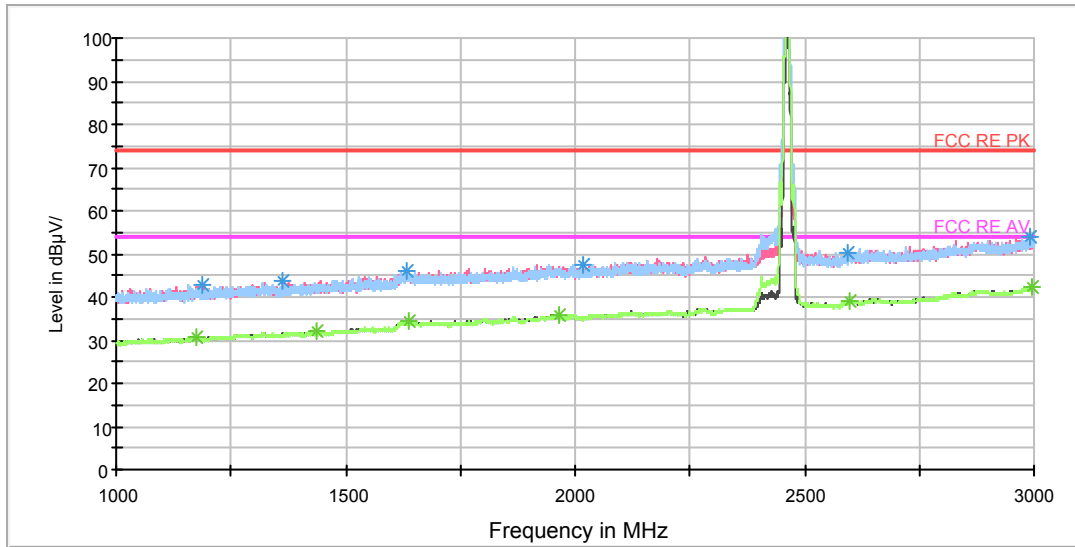

Note: The signal beyond the limit is carrier.
Radiates Emission from 1GHz to 3GHz

Frequency (MHz)	Peak (dBuV/m)	Height (cm)	Polarization	Azimuth (deg)	Reading value (dBuV/m)	Correct Factor (dB)	Margin (dB)	Limit (dBuV/m)
1187.500000	42.9	102.0	V	217.0	51.0	-8.1	31.1	74
1362.000000	43.6	102.0	V	217.0	51.0	-7.4	30.4	74
1634.750000	45.9	102.0	V	169.0	50.6	-4.7	28.1	74
2019.500000	47.5	102.0	H	145.0	51.1	-3.6	26.5	74
2592.750000	50.2	102.0	H	63.0	50.3	0.1	23.8	74
2990.750000	54.1	102.0	H	0.0	56.3	2.2	19.9	74

Remark: 1. Correction Factor = Antenna factor+ Insertion loss (cable loss + amplifier gain)

Frequency (MHz)	Average (dBuV/m)	Height (cm)	Polarization	Azimuth (deg)	Reading value (dBuV/m)	Correct Factor (dB)	Margin (dB)	Limit (dBuV/m)
1176.750000	30.8	102.0	V	135.0	38.8	-8.0	23.2	54
1437.750000	32.0	102.0	H	0.0	38.9	-6.9	22	54
1637.250000	34.5	102.0	V	233.0	39.2	-4.7	19.5	54
1963.250000	35.9	102.0	H	0.0	39.2	-3.3	18.1	54
2596.750000	39.1	102.0	V	298.0	39.4	0.3	14.9	54
2997.250000	42.5	102.0	V	282.0	44.8	2.3	11.5	54

Remark: 1. Correction Factor = Antenna factor+ Insertion loss (cable loss + amplifier gain)

RE 3-18GHz PK+AV

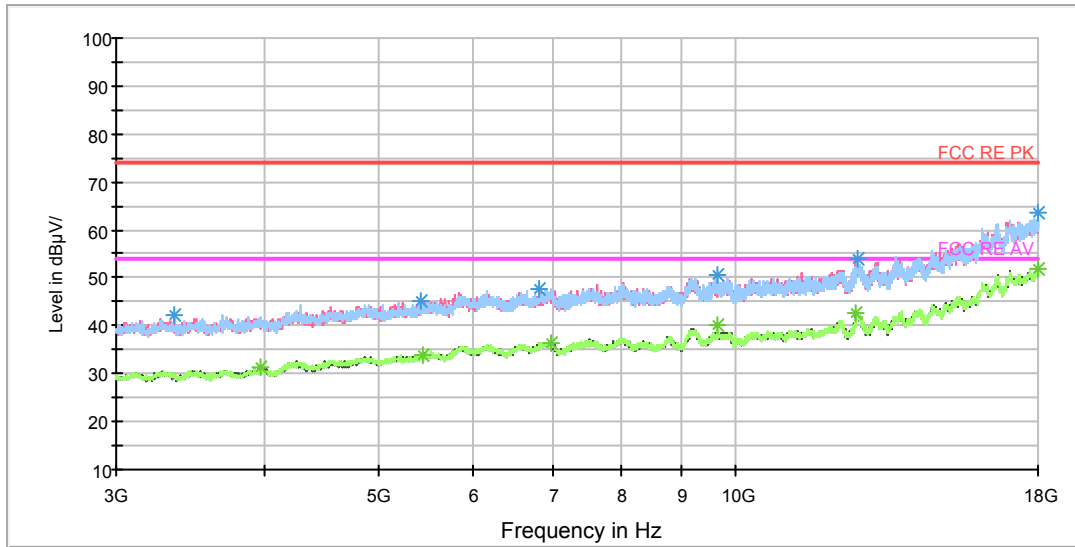

Radiates Emission from 3GHz to 18GHz

Frequency (MHz)	Peak (dBuV/m)	Height (cm)	Polarization	Azimuth (deg)	Reading value (dBuV/m)	Correct Factor (dB)	Margin (dB)	Limit (dBuV/m)
3356.250000	42.3	102.0	V	213.0	44.6	-2.3	31.7	74
5415.000000	45.4	102.0	H	166.0	48.0	2.6	28.6	74
6828.750000	47.7	102.0	H	81.0	53.5	5.8	26.3	74
9646.875000	50.7	102.0	H	166.0	60.5	9.8	23.3	74
12665.625000	53.9	102.0	V	46.0	67.8	13.9	20.1	74
17985.000000	63.7	102.0	V	29.0	88.8	25.1	10.3	74

Remark: 1. Correction Factor = Antenna factor+ Insertion loss (cable loss + amplifier gain)

Frequency (MHz)	Average (dBuV/m)	Height (cm)	Polarization	Azimuth (deg)	Reading value (dBuV/m)	Correct Factor (dB)	Margin (dB)	Limit (dBuV/m)
3971.250000	31.4	102.0	V	351.0	32.3	-0.9	22.6	54
5448.750000	33.9	102.0	V	321.0	36.7	2.8	20.1	54
6976.875000	36.5	102.0	V	321.0	42.8	6.3	17.5	54
9648.750000	40.1	102.0	H	166.0	49.9	9.8	13.9	54
12650.625000	42.7	102.0	H	313.0	56.8	14.1	11.3	54
18000.000000	52.0	102.0	H	0.0	77.5	25.5	2.0	54

Remark: 1. Correction Factor = Antenna factor+ Insertion loss (cable loss + amplifier gain)

RE 18-26.5GHz PK+AV

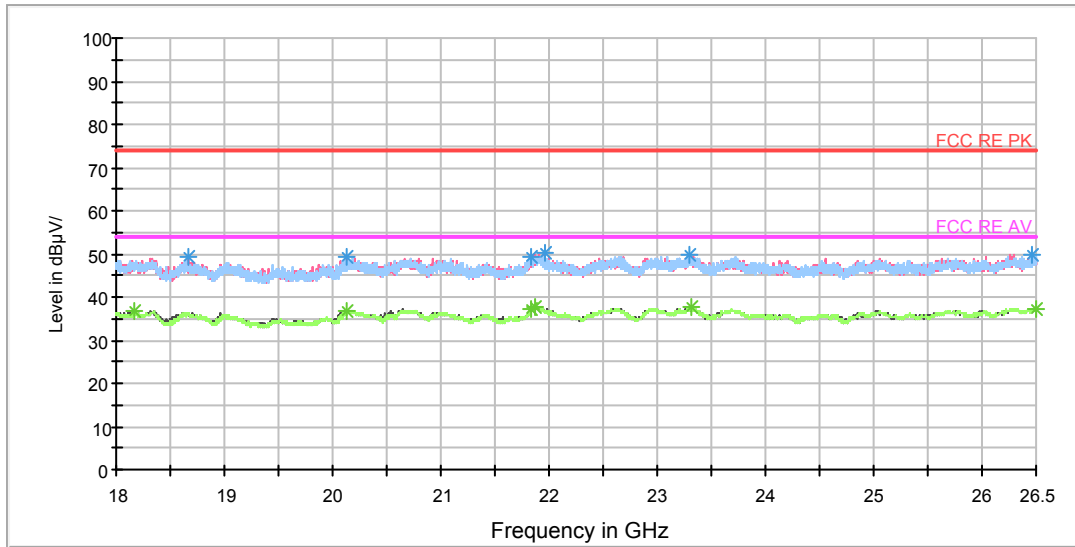

Radiates Emission from 18GHz to 26.5GHz

Frequency (MHz)	Peak (dBuV/m)	Polarization	Azimuth (deg)	Reading value (dBuV/m)	Correct Factor (dB)	Margin (dB)	Limit (dBuV/m)
18671.500000	49.4	V	153.0	53.7	-4.3	24.6	74
20128.187500	49.1	V	261.0	54.9	-5.8	24.9	74
21835.625000	49.5	H	0.0	57.5	-8.0	24.5	74
21955.687500	50.2	H	0.0	58.2	-8.0	23.8	74
23298.687500	49.7	H	99.0	55.7	-6.0	24.3	74
26460.687500	49.9	V	110.0	55.3	-5.4	24.1	74

Remark: 1. Correction Factor = Antenna factor+ Insertion loss (cable loss + amplifier gain)

Frequency (MHz)	Average (dBuV/m)	Polarization	Azimuth (deg)	Reading value (dBuV/m)	Correct Factor (dB)	Margin (dB)	Limit (dBuV/m)
18173.187500	36.7	H	0.0	39.2	-2.5	17.3	54
20127.125000	36.9	V	180.0	42.7	-5.8	17.1	54
21838.812500	37.2	V	274.0	45.2	-8.0	16.8	54
21866.437500	37.9	V	341.0	45.9	-8.0	16.1	54
23314.625000	37.5	H	17.0	43.5	-6.0	16.5	54
26497.875000	37.3	V	301.0	42.7	-5.4	16.7	54

Remark: 1. Correction Factor = Antenna factor+ Insertion loss (cable loss + amplifier gain)

802.11g CH1

FCC RE 0.03-1GHz QP Class C

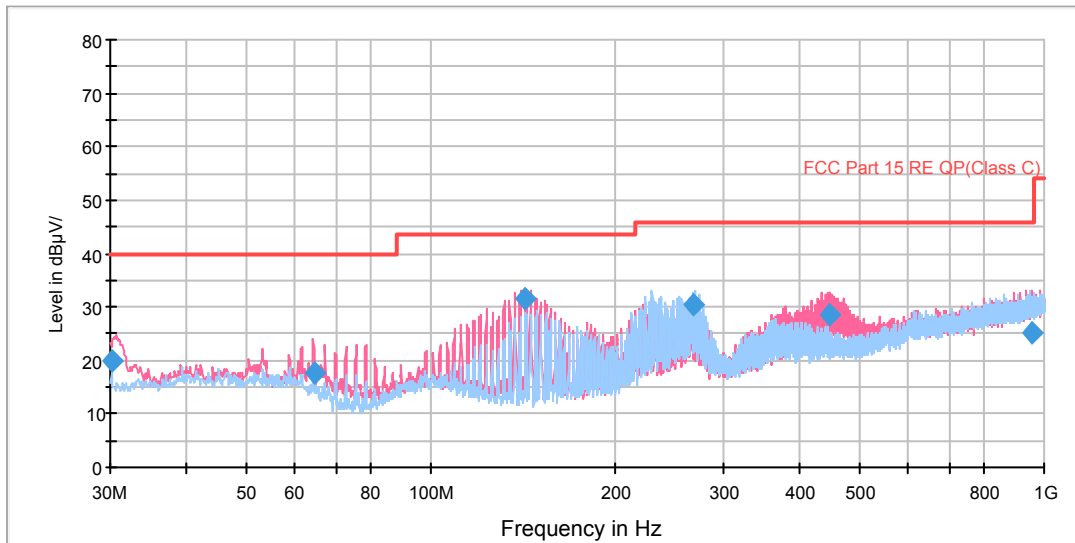

Radiates Emission from 30MHz to 1GHz

Frequency (MHz)	Quasi-Peak (dBuV/m)	Height (cm)	Polarization	Azimuth (deg)	Reading value (dBuV/m)	Correct Factor (dB)	Margin (dB)	Limit (dBuV/m)
30.127500	19.8	100.0	V	326.0	31.7	11.9	20.2	40.0
64.393750	17.7	100.0	V	354.0	28.5	10.8	22.3	40.0
142.842500	31.4	100.0	V	337.0	40.4	9.0	12.1	43.5
268.665000	30.3	100.0	H	236.0	44.9	14.6	15.7	46.0
447.750000	28.7	100.0	V	10.0	47.6	18.9	17.3	46.0
952.510000	25.3	125.0	V	289.0	51.3	26.0	20.7	46.0

- Remark:**
1. Quasi-Peak = Reading value + Correction factor
 2. Correction Factor = Antenna factor+ Insertion loss(cable loss+amplifier gain)
 3. Margin = Limit – Quasi-Peak

RE 1G-3GHz PK+AV

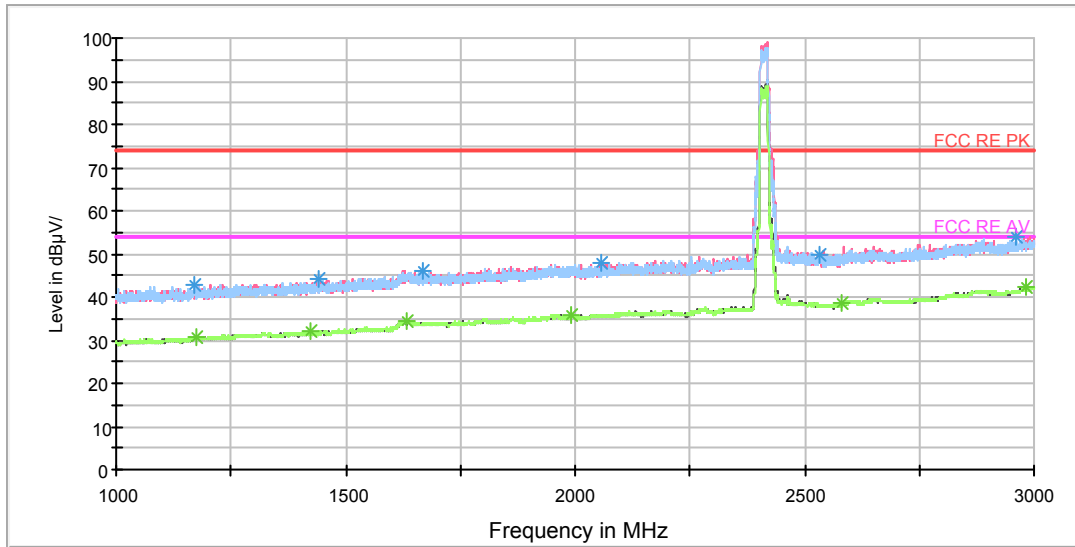

Note: The signal beyond the limit is carrier.
Radiates Emission from 1GHz to 3GHz

Frequency (MHz)	Peak (dBuV/m)	Height (cm)	Polarization	Azimuth (deg)	Reading value (dBuV/m)	Correct Factor (dB)	Margin (dB)	Limit (dBuV/m)
1172.000000	42.8	102.0	H	0.0	50.9	-8.1	31.2	74
1439.500000	44.4	102.0	H	0.0	51.3	-6.9	29.6	74
1669.000000	46.2	102.0	V	0.0	51.3	-5.1	27.8	74
2055.000000	47.7	102.0	V	0.0	50.9	-3.2	26.3	74
2533.750000	49.9	102.0	V	118.0	50.3	-0.4	24.1	74
2962.750000	54.1	102.0	H	62.0	56.2	2.1	19.9	74

Remark: 1. Correction Factor = Antenna factor+ Insertion loss (cable loss + amplifier gain)

Frequency (MHz)	Average (dBuV/m)	Height (cm)	Polarization	Azimuth (deg)	Reading value (dBuV/m)	Correct Factor (dB)	Margin (dB)	Limit (dBuV/m)
1175.500000	30.8	102.0	V	0.0	38.8	-8.0	23.2	54
1423.250000	31.9	102.0	H	175.0	38.8	-6.9	22.1	54
1633.750000	34.4	102.0	H	0.0	39.1	-4.7	19.6	54
1991.750000	36.0	102.0	H	13.0	39.3	-3.3	18.0	54
2579.000000	38.5	102.0	V	283.0	39.0	-0.5	15.5	54
2982.250000	42.4	102.0	V	346.0	44.6	2.2	11.6	54

Remark: 1. Correction Factor = Antenna factor+ Insertion loss (cable loss + amplifier gain)

RE 3-18GHz PK+AV

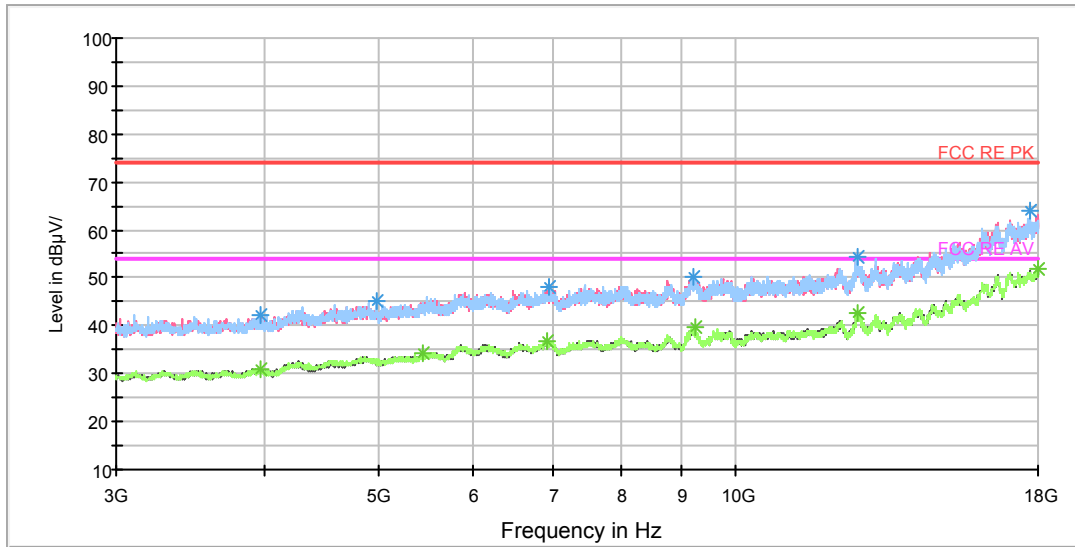

Radiates Emission from 3GHz to 18GHz

Frequency (MHz)	Peak (dBuV/m)	Height (cm)	Polarization	Azimuth (deg)	Reading value (dBuV/m)	Correct Factor (dB)	Margin (dB)	Limit (dBuV/m)
3969.375000	42.4	102.0	V	303.0	43.3	-0.9	31.6	74
4968.750000	45.0	102.0	H	60.0	46.7	1.7	29.0	74
6952.500000	47.9	102.0	V	0.0	54.1	6.2	26.1	74
9200.625000	50.1	102.0	V	334.0	60.4	10.3	23.9	74
12676.875000	54.5	102.0	H	235.0	68.7	14.2	19.5	74
17711.250000	63.8	102.0	H	44.0	88.5	24.7	10.2	74

Remark: 1. Correction Factor = Antenna factor+ Insertion loss (cable loss + amplifier gain)

Frequency (MHz)	Average (dBuV/m)	Height (cm)	Polarization	Azimuth (deg)	Reading value (dBuV/m)	Correct Factor (dB)	Margin (dB)	Limit (dBuV/m)
3963.750000	31.1	102.0	H	11.0	32.1	-1.0	22.9	54
5443.125000	34.3	102.0	V	47.0	37.2	2.9	19.7	54
6922.500000	36.8	102.0	V	0.0	43.0	6.2	17.2	54
9243.750000	39.5	102.0	H	0.0	49.3	9.8	14.5	54
12675.000000	42.7	102.0	H	218.0	56.8	14.1	11.3	54
17992.500000	51.7	102.0	V	270.0	77.0	25.3	2.3	54

Remark: 1. Correction Factor = Antenna factor+ Insertion loss (cable loss + amplifier gain)

RE 18-26.5GHz PK+AV

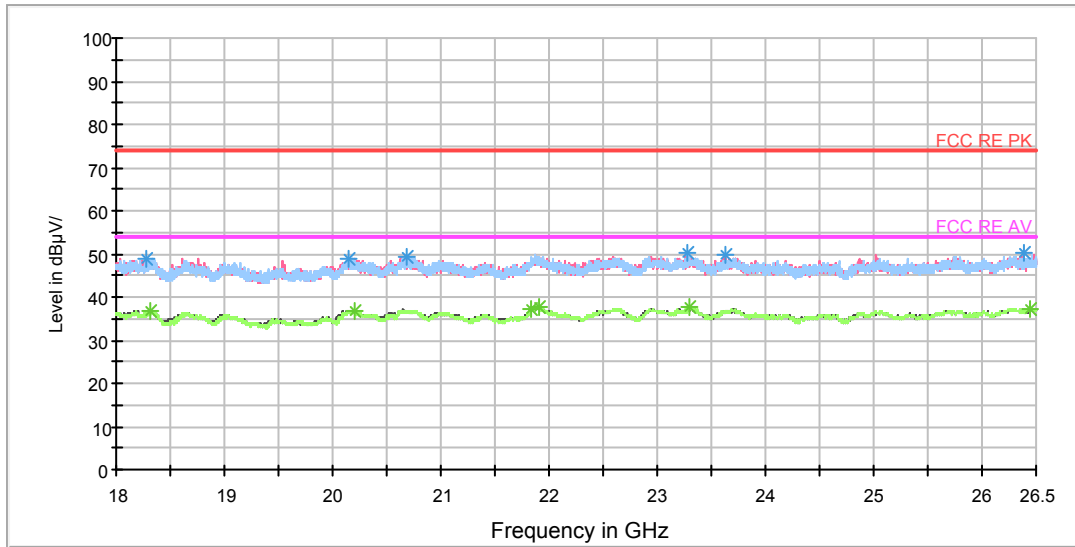

Radiates Emission from 18GHz to 26.5GHz

Frequency (MHz)	Peak (dBuV/m)	Polarization	Azimuth (deg)	Reading value (dBuV/m)	Correct Factor (dB)	Margin (dB)	Limit (dBuV/m)
18268.812500	49.0	H	236.0	51.9	-2.9	25.0	74
20156.875000	48.8	V	286.0	54.6	-5.8	25.2	74
20691.312500	49.4	V	232.0	56.1	-6.7	24.6	74
23274.250000	50.0	H	114.0	56	-6.0	24.0	74
23637.625000	49.7	V	165.0	55.6	-5.9	24.3	74
26381.000000	50.1	H	319.0	55.5	-5.4	23.9	74

Remark: 1. Correction Factor = Antenna factor+ Insertion loss (cable loss + amplifier gain)

Frequency (MHz)	Average (dBuV/m)	Polarization	Azimuth (deg)	Reading value (dBuV/m)	Correct Factor (dB)	Margin (dB)	Limit (dBuV/m)
18314.500000	36.7	V	340.0	39.8	-3.1	17.3	54
20206.812500	36.7	V	326.0	42.6	-5.9	17.3	54
21838.812500	37.2	V	313.0	45.2	-8.0	16.8	54
21905.750000	37.9	V	326.0	45.9	-8.0	16.1	54
23297.625000	37.4	V	0.0	43.4	-6.0	16.6	54
26452.187500	37.4	V	326.0	42.8	-5.4	16.6	54

Remark: 1. Correction Factor = Antenna factor+ Insertion loss (cable loss + amplifier gain)

802.11g CH6

FCC RE 0.03-1GHz QP Class C

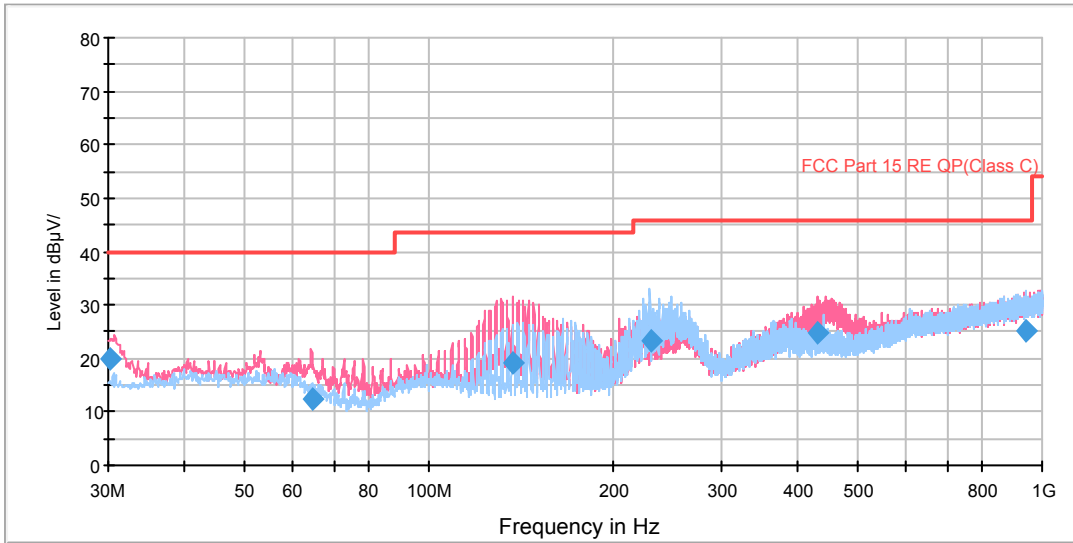

Radiates Emission from 30MHz to 1GHz

Frequency (MHz)	Quasi-Peak (dBuV/m)	Height (cm)	Polarization	Azimuth (deg)	Reading value (dBuV/m)	Correct Factor (dB)	Margin (dB)	Limit (dBuV/m)
30.127500	19.8	100.0	V	0.0	31.7	11.9	20.2	40.0
64.553750	12.3	100.0	V	100.0	23.0	10.7	27.7	40.0
137.663750	19.3	100.0	V	253.0	28.3	9.0	24.2	43.5
229.737500	23.2	114.0	H	299.0	36.4	13.2	22.8	46.0
431.616250	24.7	113.0	V	4.0	43.3	18.6	21.3	46.0
939.291250	25.2	100.0	H	278.0	51.1	25.9	20.8	46.0

- Remark:**
1. Quasi-Peak = Reading value + Correction factor
 2. Correction Factor = Antenna factor+ Insertion loss(cable loss+amplifier gain)
 3. Margin = Limit – Quasi-Peak

RE 1G-3GHz PK+AV

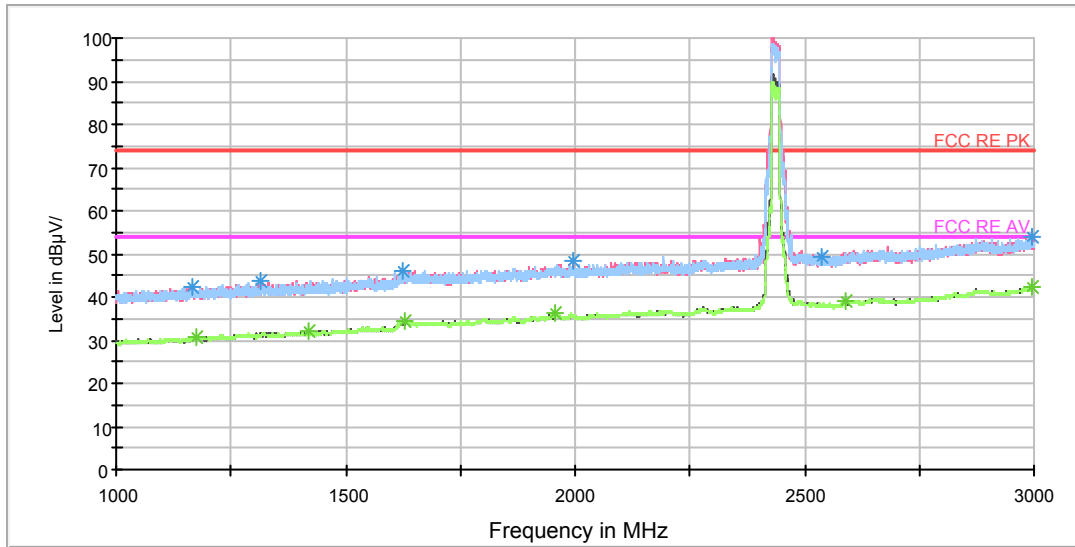

Note: The signal beyond the limit is carrier.
Radiates Emission from 1GHz to 3GHz

Frequency (MHz)	Peak (dBuV/m)	Height (cm)	Polarization	Azimuth (deg)	Reading value (dBuV/m)	Correct Factor (dB)	Margin (dB)	Limit (dBuV/m)
1167.500000	42.5	102.0	V	103.0	50.7	-8.2	31.5	74
1315.000000	43.7	102.0	H	243.0	51.2	-7.5	30.3	74
1623.250000	46.0	102.0	H	294.0	50.8	-4.8	28.0	74
1994.750000	48.2	102.0	V	153.0	51.4	-3.2	25.8	74
2537.000000	49.5	102.0	V	321.0	49.9	-0.4	24.5	74
2997.750000	54.0	102.0	V	0.0	56.3	2.3	20.0	74

Remark: 1. Correction Factor = Antenna factor+ Insertion loss (cable loss + amplifier gain)

Frequency (MHz)	Average (dBuV/m)	Height (cm)	Polarization	Azimuth (deg)	Reading value (dBuV/m)	Correct Factor (dB)	Margin (dB)	Limit (dBuV/m)
1173.250000	30.8	102.0	H	34.0	38.9	-8.1	23.2	54
1417.250000	32.0	102.0	V	0.0	38.9	-6.9	22.0	54
1628.250000	34.5	102.0	V	271.0	39.2	-4.7	19.5	54
1958.500000	36.2	102.0	V	351.0	39.4	-3.2	17.8	54
2590.500000	39.0	102.0	H	34.0	39.0	0.0	15.0	54
2995.500000	42.2	102.0	H	195.0	44.5	2.3	11.8	54

Remark: 1. Correction Factor = Antenna factor+ Insertion loss (cable loss + amplifier gain)

RE 3-18GHz PK+AV

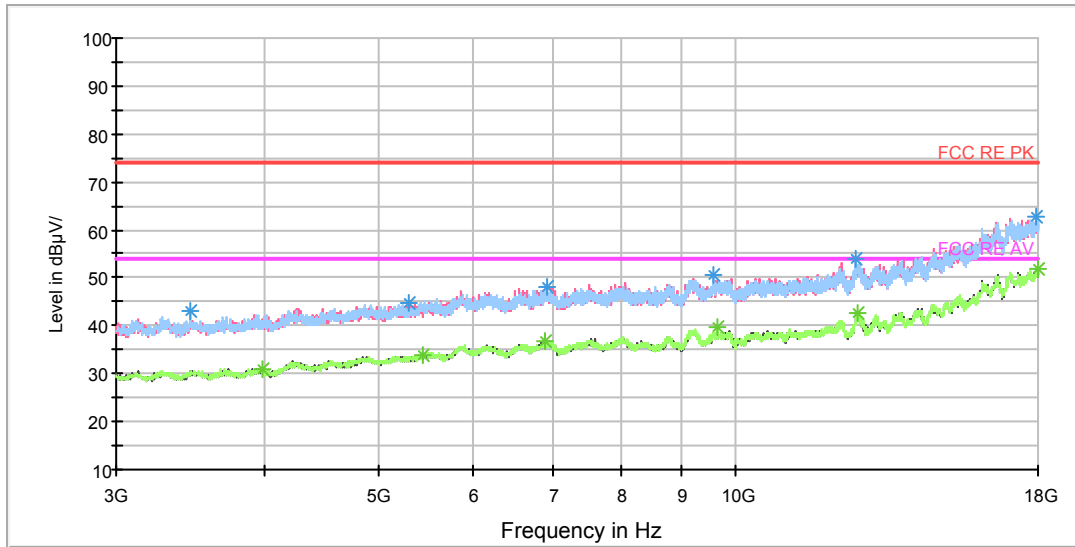

Radiates Emission from 3GHz to 18GHz

Frequency (MHz)	Peak (dBuV/m)	Height (cm)	Polarization	Azimuth (deg)	Reading value (dBuV/m)	Correct Factor (dB)	Margin (dB)	Limit (dBuV/m)
3463.125000	43.0	102.0	H	0.0	45.2	-2.2	31.0	74
5293.125000	44.8	102.0	V	242.0	47.1	2.3	29.2	74
6935.625000	48.1	102.0	H	8.0	54.2	6.1	25.9	74
9564.375000	50.8	102.0	H	152.0	60.7	9.9	23.2	74
12637.500000	53.9	102.0	V	164.0	68.2	14.3	20.1	74
17934.375000	62.6	102.0	H	152.0	87.8	25.2	11.4	74

Remark: 1. Correction Factor = Antenna factor+ Insertion loss (cable loss + amplifier gain)

Frequency (MHz)	Average (dBuV/m)	Height (cm)	Polarization	Azimuth (deg)	Reading value (dBuV/m)	Correct Factor (dB)	Margin (dB)	Limit (dBuV/m)
3982.500000	31.1	102.0	V	306.0	32.1	-1.0	22.9	54
5439.375000	34.0	102.0	H	121.0	36.9	2.9	20.0	54
6903.750000	36.9	102.0	H	8.0	43.2	6.3	17.1	54
9648.750000	39.6	102.0	H	74.0	49.4	9.8	14.4	54
12678.750000	42.5	102.0	V	0.0	56.7	14.2	11.5	54
18000.000000	52.0	102.0	V	100.0	77.5	25.5	2.0	54

Remark: 1. Correction Factor = Antenna factor+ Insertion loss (cable loss + amplifier gain)

RE 18-26.5GHz PK+AV

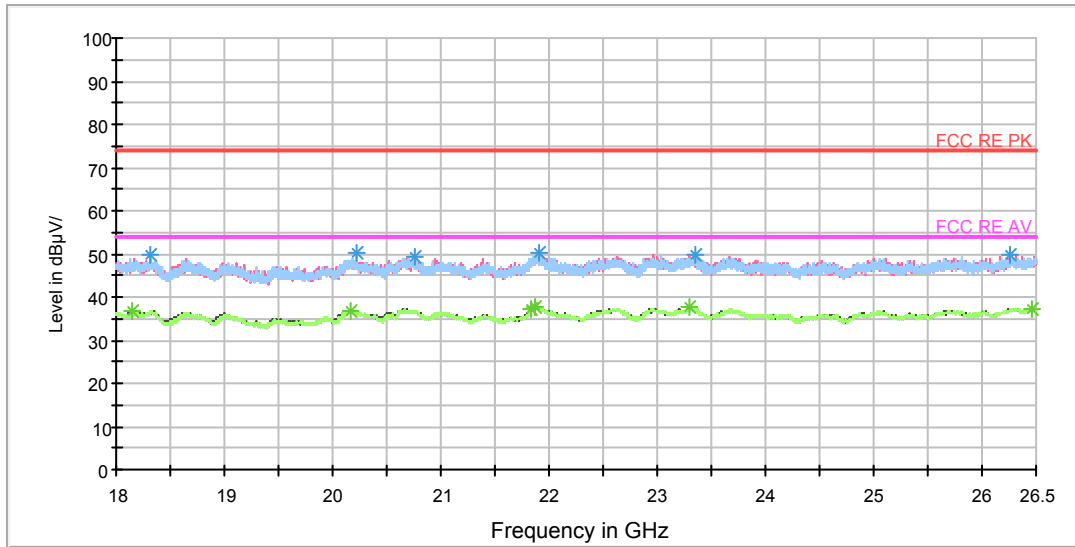

Radiates Emission from 18GHz to 26.5GHz

Frequency (MHz)	Peak (dBuV/m)	Polarization	Azimuth (deg)	Reading value (dBuV/m)	Correct Factor (dB)	Margin (dB)	Limit (dBuV/m)
18313.437500	49.8	V	0.0	52.9	-3.1	24.2	74
20225.937500	50.0	H	0.0	55.9	-5.9	24.0	74
20764.625000	49.2	H	155.0	56.0	-6.8	24.8	74
21905.750000	50.0	V	0.0	58.0	-8.0	24.0	74
23346.500000	49.9	V	311.0	55.8	-5.9	24.1	74
26251.375000	49.8	H	20.0	55.2	-5.4	24.2	74

Remark: 1. Correction Factor = Antenna factor+ Insertion loss (cable loss + amplifier gain)

Frequency (MHz)	Average (dBuV/m)	Polarization	Azimuth (deg)	Reading value (dBuV/m)	Correct Factor (dB)	Margin (dB)	Limit (dBuV/m)
18153.000000	36.7	V	337.0	39.1	-2.4	17.3	54
20157.937500	36.8	V	218.0	42.6	-5.8	17.2	54
21838.812500	37.2	H	7.0	45.2	-8.0	16.8	54
21879.187500	37.8	H	0.0	45.8	-8.0	16.2	54
23301.875000	37.5	V	337.0	43.5	-6.0	16.5	54
26463.875000	37.3	V	0.0	42.7	-5.4	16.7	54

Remark: 1. Correction Factor = Antenna factor+ Insertion loss (cable loss + amplifier gain)

802.11g CH11

FCC RE 0.03-1GHz QP Class C

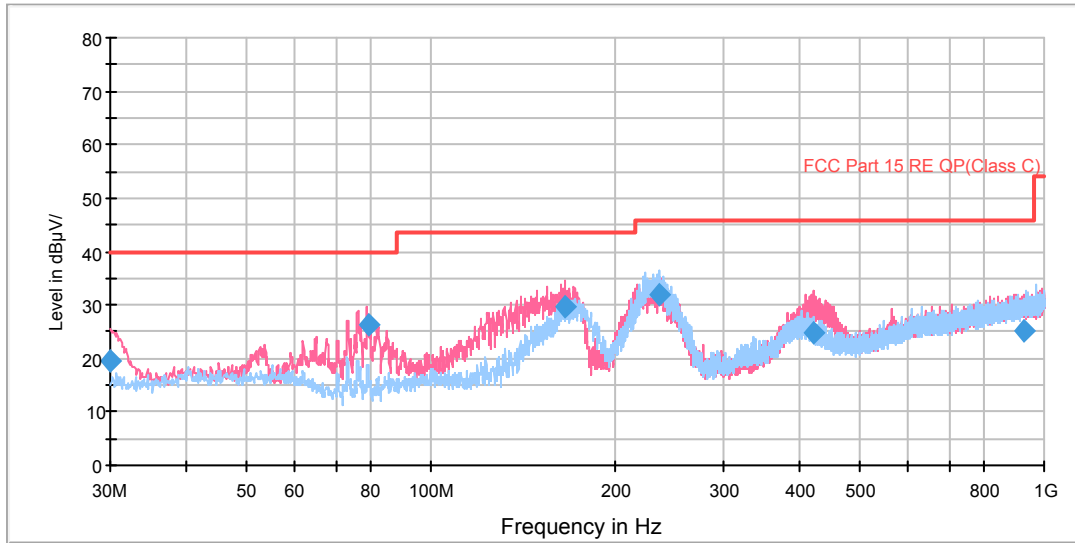

Radiates Emission from 30MHz to 1GHz

Frequency (MHz)	Quasi-Peak (dBuV/m)	Height (cm)	Polarization	Azimuth (deg)	Reading value (dBuV/m)	Correct Factor (dB)	Margin (dB)	Limit (dBuV/m)
30.080000	19.6	114.0	V	10.0	31.5	11.9	20.4	40.0
79.022500	26.3	125.0	V	22.0	34.8	8.5	13.7	40.0
165.678750	29.8	100.0	V	332.0	39.8	10.0	13.7	43.5
236.007500	31.8	114.0	H	271.0	45.4	13.6	14.2	46.0
420.225000	24.9	114.0	V	0.0	43.3	18.4	21.1	46.0
930.971250	25.1	100.0	H	0.0	51.0	25.9	20.9	46.0

- Remark: 1. Quasi-Peak = Reading value + Correction factor
 2. Correction Factor = Antenna factor+ Insertion loss(cable loss+amplifier gain)
 3. Margin = Limit – Quasi-Peak

RE 1G-3GHz PK+AV

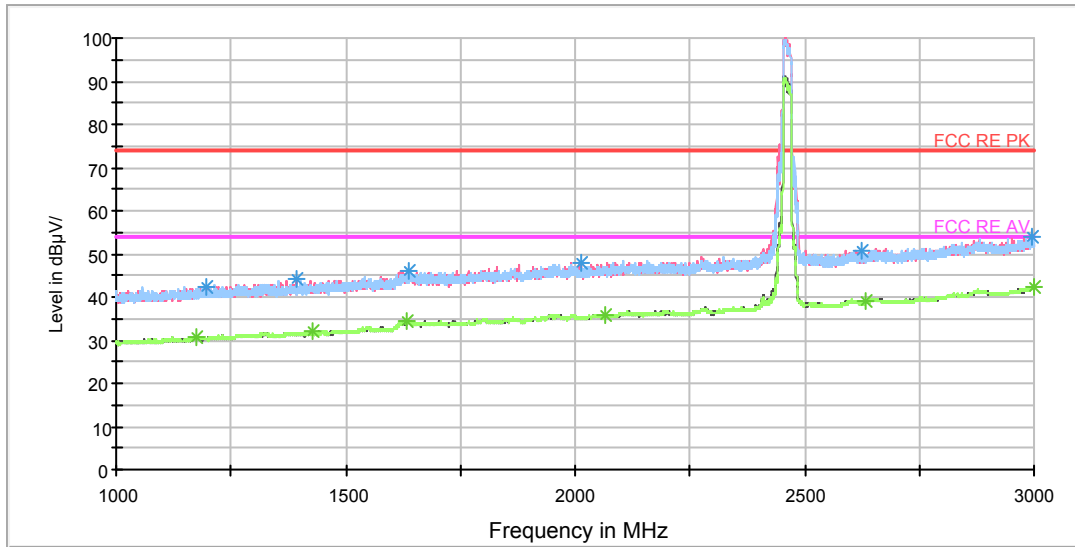

Note: The signal beyond the limit is carrier.
Radiates Emission from 1GHz to 3GHz

Frequency (MHz)	Peak (dBuV/m)	Height (cm)	Polarization	Azimuth (deg)	Reading value (dBuV/m)	Correct Factor (dB)	Margin (dB)	Limit (dBuV/m)
1196.000000	42.3	102.0	V	313.0	50.5	-8.2	31.7	74
1392.750000	44.0	102.0	V	119.0	51.0	-7.0	30.0	74
1639.250000	46.1	102.0	H	0.0	50.8	-4.7	27.9	74
2012.500000	48.0	102.0	V	151.0	51.5	-3.5	26.0	74
2622.750000	50.9	102.0	H	16.0	51.0	-0.1	23.1	74
2997.500000	54.1	102.0	H	95.0	56.4	2.3	19.9	74

Remark: 1. Correction Factor = Antenna factor+ Insertion loss (cable loss + amplifier gain)

Frequency (MHz)	Average (dBuV/m)	Height (cm)	Polarization	Azimuth (deg)	Reading value (dBuV/m)	Correct Factor (dB)	Margin (dB)	Limit (dBuV/m)
1174.500000	30.9	102.0	H	1.0	38.9	-8.0	23.1	54
1428.750000	31.9	102.0	V	151.0	38.8	-6.9	22.1	54
1633.500000	34.5	102.0	H	210.0	39.2	-4.7	19.5	54
2067.500000	35.9	102.0	H	95.0	39.0	-3.1	18.1	54
2633.250000	39.1	102.0	H	1.0	39.1	0.0	14.9	54
2998.500000	42.3	102.0	V	0.0	44.6	2.3	11.7	54

Remark: 1. Correction Factor = Antenna factor+ Insertion loss (cable loss + amplifier gain)

RE 3-18GHz PK+AV

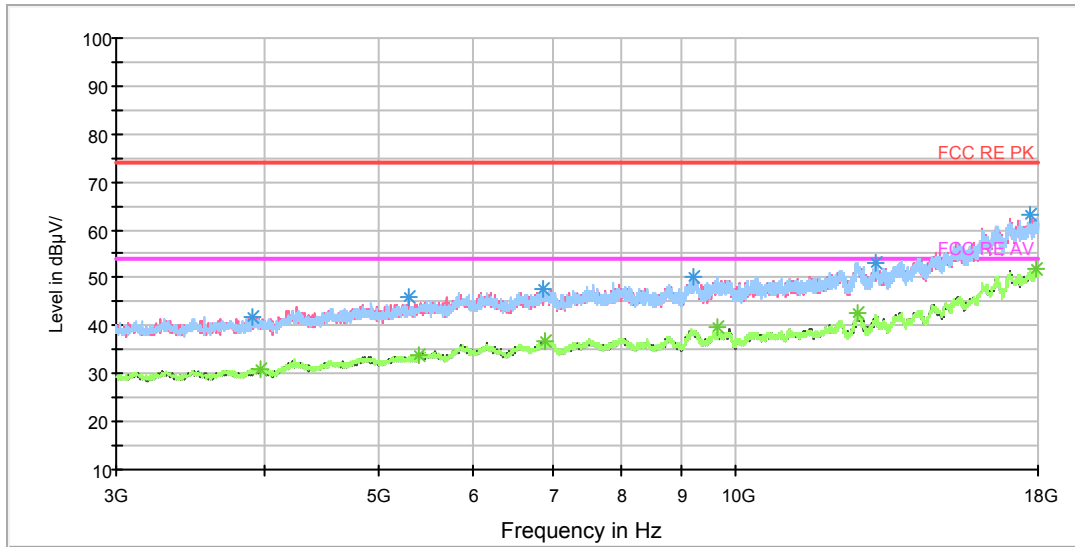

Radiates Emission from 3GHz to 18GHz

Frequency (MHz)	Peak (dBuV/m)	Height (cm)	Polarization	Azimuth (deg)	Reading value (dBuV/m)	Correct Factor (dB)	Margin (dB)	Limit (dBuV/m)
3911.250000	41.8	102.0	V	353.0	43.0	-1.2	32.2	74
5291.250000	45.8	102.0	V	0.0	48.1	2.3	28.2	74
6870.000000	47.7	102.0	H	129.0	53.6	5.9	26.3	74
9202.500000	50.2	102.0	H	20.0	60.4	10.2	23.8	74
13140.000000	53.1	102.0	H	66.0	67.5	14.4	20.9	74
17696.250000	63.0	102.0	V	0.0	87.7	24.7	11.0	74

Remark: 1. Correction Factor = Antenna factor+ Insertion loss (cable loss + amplifier gain)

Frequency (MHz)	Average (dBuV/m)	Height (cm)	Polarization	Azimuth (deg)	Reading value (dBuV/m)	Correct Factor (dB)	Margin (dB)	Limit (dBuV/m)
3963.750000	31.0	102.0	V	337.0	32	-1.0	23.0	54
5407.500000	34.0	102.0	H	66.0	36.6	2.6	20.0	54
6916.875000	36.6	102.0	V	181.0	42.8	6.2	17.4	54
9646.875000	39.7	102.0	H	191.0	49.5	9.8	14.3	54
12676.875000	42.6	102.0	H	0.0	56.8	14.2	11.4	54
17915.625000	51.9	102.0	H	0.0	77.5	25.6	2.1	54

Remark: 1. Correction Factor = Antenna factor+ Insertion loss (cable loss + amplifier gain)

RE 18-26.5GHz PK+AV

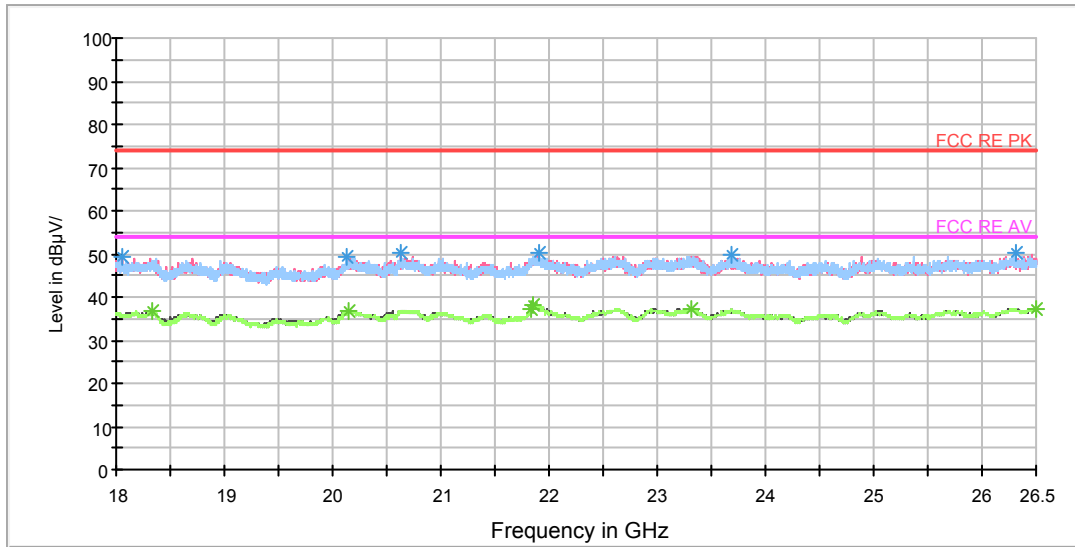

Radiates Emission from 18GHz to 26.5GHz

Frequency (MHz)	Peak (dBuV/m)	Polarization	Azimuth (deg)	Reading value (dBuV/m)	Correct Factor (dB)	Margin (dB)	Limit (dBuV/m)
18047.812500	49.3	V	0.0	51.3	-2.0	24.7	74
20138.812500	49.3	H	221.0	55.1	-5.8	24.7	74
20632.875000	50.1	V	110.0	56.6	-6.5	23.9	74
21903.625000	50.2	H	44.0	58.2	-8.0	23.8	74
23678.000000	49.6	H	0.0	55.5	-5.9	24.4	74
26321.500000	50.2	V	338.0	55.6	-5.4	23.8	74

Remark: 1. Correction Factor = Antenna factor+ Insertion loss (cable loss + amplifier gain)

Frequency (MHz)	Average (dBuV/m)	Polarization	Azimuth (deg)	Reading value (dBuV/m)	Correct Factor (dB)	Margin (dB)	Limit (dBuV/m)
18330.437500	36.7	H	126.0	39.9	-3.2	17.3	54
20139.875000	36.8	V	298.0	42.6	-5.8	17.2	54
21839.875000	37.3	H	0.0	45.3	-8.0	16.7	54
21860.062500	38.0	V	0.0	46.0	-8.0	16.0	54
23322.062500	37.4	V	191.0	43.4	-6.0	16.6	54
26498.937500	37.3	H	44.0	42.7	-5.4	16.7	54

Remark: 1. Correction Factor = Antenna factor+ Insertion loss (cable loss + amplifier gain)

802.11n (HT20) CH1

FCC RE 0.03-1GHz QP Class C

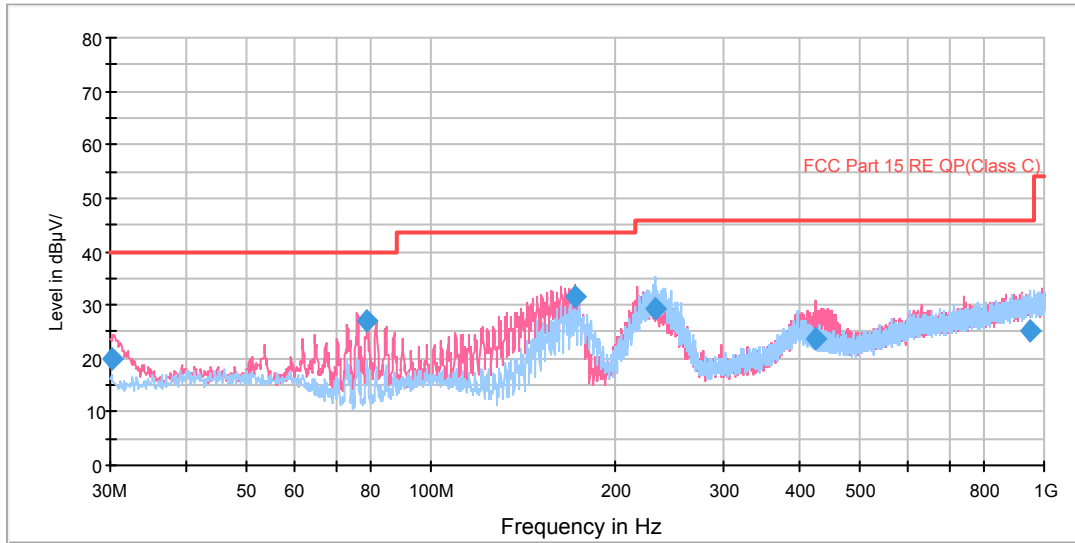

Radiates Emission from 30MHz to 1GHz

Frequency (MHz)	Quasi-Peak (dBuV/m)	Height (cm)	Polarization	Azimuth (deg)	Reading value (dBuV/m)	Correct Factor (dB)	Margin (dB)	Limit (dBuV/m)
30.240000	19.9	100.0	V	354.0	31.8	11.9	20.1	40.0
78.702500	26.9	125.0	V	0.0	35.4	8.5	13.1	40.0
171.418750	31.4	100.0	V	31.0	41.7	10.3	12.1	43.5
232.648750	29.4	125.0	H	72.0	42.8	13.4	16.6	46.0
425.315000	23.8	114.0	V	0.0	42.3	18.5	22.2	46.0
950.570000	25.3	100.0	V	0.0	51.3	26.0	20.7	46.0

- Remark: 1. Quasi-Peak = Reading value + Correction factor
 2. Correction Factor = Antenna factor+ Insertion loss(cable loss+amplifier gain)
 3. Margin = Limit – Quasi-Peak

RE 1G-3GHz PK+AV

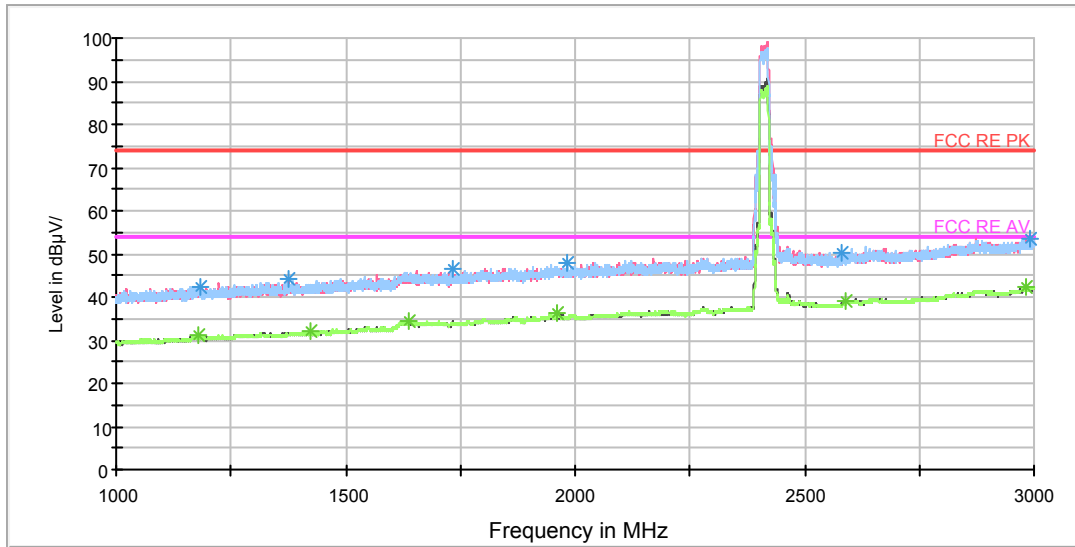

Note: The signal beyond the limit is carrier.
Radiates Emission from 1GHz to 3GHz

Frequency (MHz)	Peak (dBuV/m)	Height (cm)	Polarization	Azimuth (deg)	Reading value (dBuV/m)	Correct Factor (dB)	Margin (dB)	Limit (dBuV/m)
1185.500000	42.5	102.0	V	0.0	50.6	-8.1	31.5	74
1376.000000	44.4	102.0	V	0.0	51.5	-7.1	29.6	74
1732.000000	46.4	102.0	H	49.0	51.2	-4.8	27.6	74
1984.500000	47.9	102.0	H	310.0	51.7	-3.8	26.1	74
2580.750000	50.2	102.0	H	129.0	50.6	-0.4	23.8	74
2991.750000	53.7	102.0	H	65.0	55.9	2.2	20.3	74

Remark: 1. Correction Factor = Antenna factor+ Insertion loss (cable loss + amplifier gain)

Frequency (MHz)	Average (dBuV/m)	Height (cm)	Polarization	Azimuth (deg)	Reading value (dBuV/m)	Correct Factor (dB)	Margin (dB)	Limit (dBuV/m)
1180.750000	31.1	102.0	H	0.0	39.1	-8.0	22.9	54
1423.250000	31.9	102.0	V	138.0	38.8	-6.9	22.1	54
1638.000000	34.4	102.0	H	192.0	39.1	-4.7	19.6	54
1959.750000	36.1	102.0	V	0.0	39.3	-3.2	17.9	54
2590.500000	38.9	102.0	H	160.0	38.9	0.0	15.1	54
2984.000000	42.3	102.0	H	80.0	44.5	2.2	11.7	54

Remark: 1. Correction Factor = Antenna factor+ Insertion loss (cable loss + amplifier gain)

RE 3-18GHz PK+AV

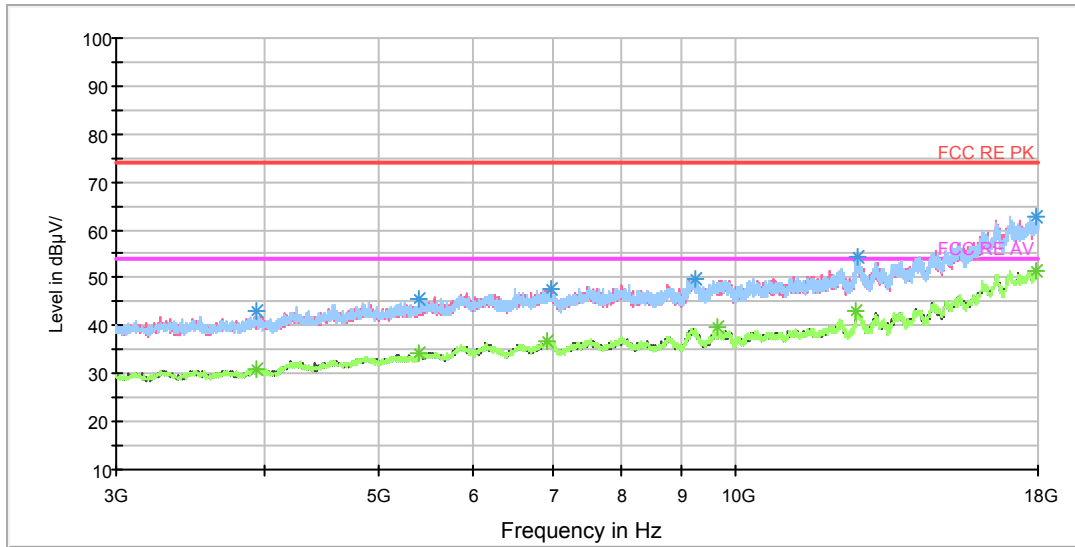

Radiates Emission from 3GHz to 18GHz

Frequency (MHz)	Peak (dBuV/m)	Height (cm)	Polarization	Azimuth (deg)	Reading value (dBuV/m)	Correct Factor (dB)	Margin (dB)	Limit (dBuV/m)
3933.750000	43.1	102.0	H	0.0	44.2	-1.1	30.9	74
5411.250000	45.7	102.0	H	11.0	48.3	2.6	28.3	74
6973.125000	47.8	102.0	V	359.0	54.1	6.3	26.2	74
9243.750000	49.8	102.0	V	0.0	59.6	9.8	24.2	74
12691.875000	54.3	102.0	H	165.0	68.5	14.2	19.7	74
17919.375000	62.7	102.0	V	0.0	88.5	25.8	11.3	74

Remark: 1. Correction Factor = Antenna factor+ Insertion loss (cable loss + amplifier gain)

Frequency (MHz)	Average (dBuV/m)	Height (cm)	Polarization	Azimuth (deg)	Reading value (dBuV/m)	Correct Factor (dB)	Margin (dB)	Limit (dBuV/m)
3941.250000	31.0	102.0	H	279.0	32.1	-1.1	23.0	54
5409.375000	34.4	102.0	V	171.0	37.0	2.6	19.6	54
6924.375000	36.9	102.0	V	188.0	43.1	6.2	17.1	54
9648.750000	39.7	102.0	H	119.0	49.5	9.8	14.3	54
12648.750000	42.9	102.0	H	0.0	57.1	14.2	11.1	54
17919.375000	51.6	102.0	H	199.0	77.4	25.8	2.4	54

Remark: 1. Correction Factor = Antenna factor+ Insertion loss (cable loss + amplifier gain)

RE 18-26.5GHz PK+AV

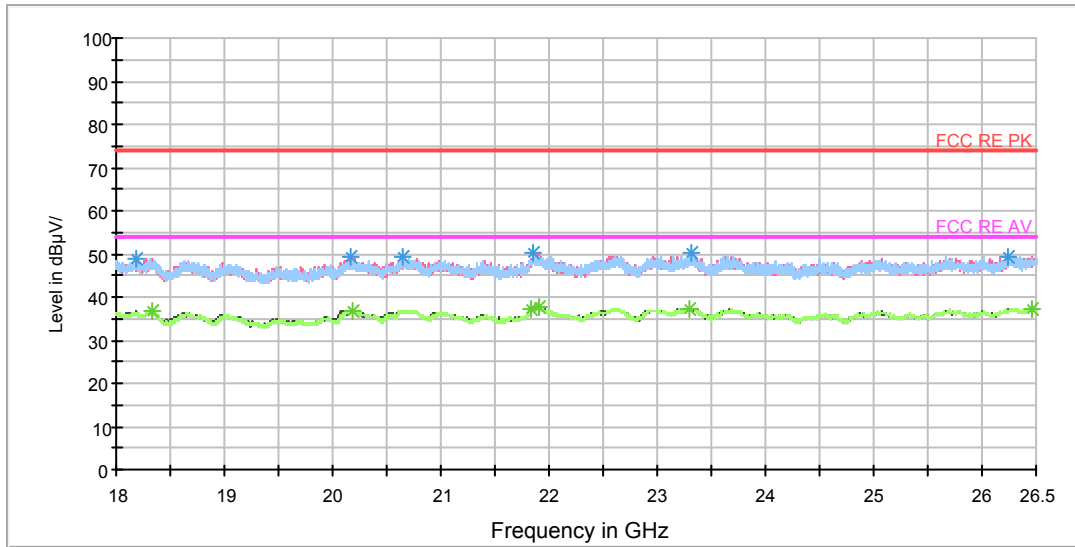

Radiates Emission from 18GHz to 26.5GHz

Frequency (MHz)	Peak (dBuV/m)	Polarization	Azimuth (deg)	Reading value (dBuV/m)	Correct Factor (dB)	Margin (dB)	Limit (dBuV/m)
18183.812500	48.8	V	0.0	51.4	-2.6	25.2	74
20161.125000	49.4	V	137.0	55.2	-5.8	24.6	74
20642.437500	49.3	V	0.0	55.8	-6.5	24.7	74
21852.625000	50.1	H	116.0	58.1	-8.0	23.9	74
23323.125000	50.0	V	353.0	56	-6.0	24.0	74
26241.812500	49.4	H	48.0	54.8	-5.4	24.6	74

Remark: 1. Correction Factor = Antenna factor+ Insertion loss (cable loss + amplifier gain)

Frequency (MHz)	Average (dBuV/m)	Polarization	Azimuth (deg)	Reading value (dBuV/m)	Correct Factor (dB)	Margin (dB)	Limit (dBuV/m)
18330.437500	36.6	V	69.0	39.8	-3.2	17.4	54
20185.562500	36.9	H	291.0	42.8	-5.9	17.1	54
21835.625000	37.2	H	89.0	45.2	-8.0	16.8	54
21904.687500	37.9	H	9.0	45.9	-8.0	16.1	54
23300.812500	37.4	V	0.0	43.4	-6.0	16.6	54
26463.875000	37.4	H	183.0	42.8	-5.4	16.6	54

Remark: 1. Correction Factor = Antenna factor+ Insertion loss (cable loss + amplifier gain)

802.11n (HT20) CH6

FCC RE 0.03-1GHz QP Class C

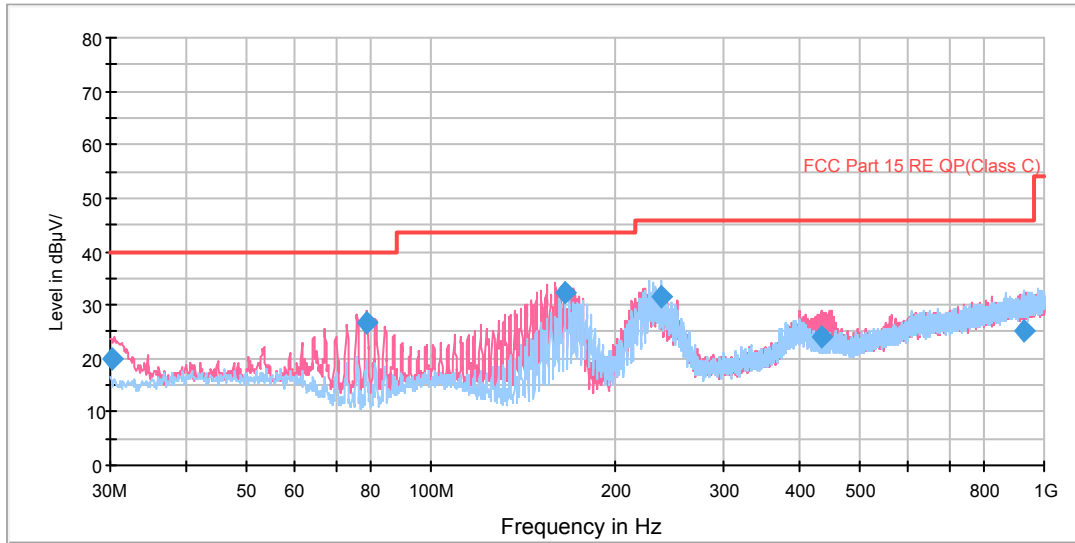

Radiates Emission from 30MHz to 1GHz

Frequency (MHz)	Quasi-Peak (dBuV/m)	Height (cm)	Polarization	Azimuth (deg)	Reading value (dBuV/m)	Correct Factor (dB)	Margin (dB)	Limit (dBuV/m)
30.240000	19.8	100.0	V	290.0	31.7	11.9	20.2	40.0
78.660000	26.6	125.0	V	0.0	35.1	8.5	13.4	40.0
165.315000	32.4	100.0	V	244.0	42.4	10.0	11.1	43.5
238.105000	31.5	125.0	H	271.0	45.2	13.7	14.5	46.0
433.075000	23.9	114.0	V	0.0	42.5	18.6	22.1	46.0
928.133750	25.0	100.0	H	30.0	50.9	25.9	21.0	46.0

- Remark: 1. Quasi-Peak = Reading value + Correction factor
 2. Correction Factor = Antenna factor+ Insertion loss(cable loss+amplifier gain)
 3. Margin = Limit – Quasi-Peak

RE 1G-3GHz PK+AV

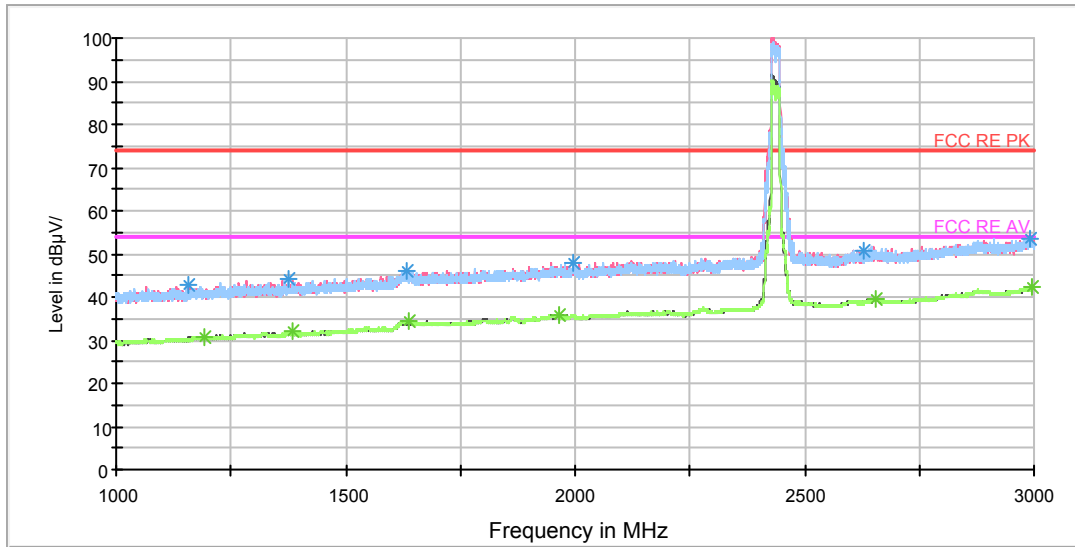

Note: The signal beyond the limit is carrier.
Radiates Emission from 1GHz to 3GHz

Frequency (MHz)	Peak (dBuV/m)	Height (cm)	Polarization	Azimuth (deg)	Reading value (dBuV/m)	Correct Factor (dB)	Margin (dB)	Limit (dBuV/m)
1156.750000	42.7	102.0	V	330.0	51.1	-8.4	31.3	74
1375.750000	44.2	102.0	H	309.0	51.3	-7.1	29.8	74
1634.500000	46.0	102.0	V	282.0	50.7	-4.7	28.0	74
1994.500000	48.1	102.0	H	326.0	51.3	-3.2	25.9	74
2629.750000	50.8	102.0	V	69.0	50.9	-0.1	23.2	74
2991.000000	53.6	102.0	H	0.0	55.8	2.2	20.4	74

Remark: 1. Correction Factor = Antenna factor+ Insertion loss (cable loss + amplifier gain)

Frequency (MHz)	Average (dBuV/m)	Height (cm)	Polarization	Azimuth (deg)	Reading value (dBuV/m)	Correct Factor (dB)	Margin (dB)	Limit (dBuV/m)
1193.000000	30.8	102.0	H	0.0	39.0	-8.2	23.2	54
1383.750000	32.0	102.0	H	0.0	39.0	-7.0	22.0	54
1637.750000	34.5	102.0	V	0.0	39.2	-4.7	19.5	54
1967.000000	35.9	102.0	V	314.0	39.4	-3.5	18.1	54
2655.750000	39.7	102.0	V	135.0	40.1	0.4	14.3	54
2996.500000	42.5	102.0	H	142.0	44.8	2.3	11.5	54

Remark: 1. Correction Factor = Antenna factor+ Insertion loss (cable loss + amplifier gain)

RE 3-18GHz PK+AV

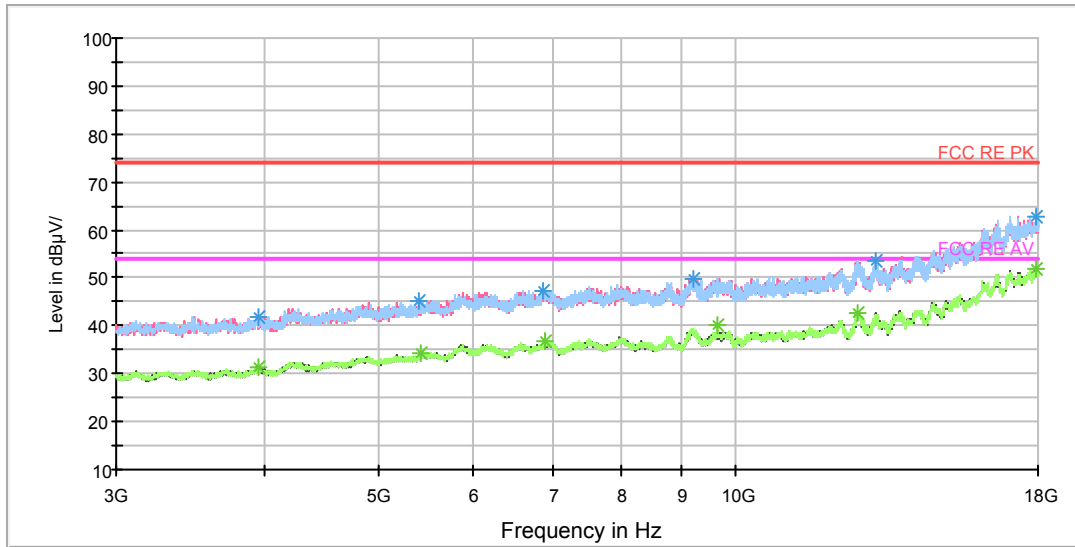

Radiates Emission from 3GHz to 18GHz

Frequency (MHz)	Peak (dBuV/m)	Height (cm)	Polarization	Azimuth (deg)	Reading value (dBuV/m)	Correct Factor (dB)	Margin (dB)	Limit (dBuV/m)
3948.750000	42.0	102.0	H	279.0	43.1	-1.1	32.0	74
5409.375000	45.2	102.0	H	133.0	47.8	2.6	28.8	74
6871.875000	47.3	102.0	H	0.0	53.2	5.9	26.7	74
9215.625000	50.0	102.0	H	85.0	60.0	10.0	24.0	74
13149.375000	53.7	102.0	H	133.0	67.9	14.2	20.3	74
17921.250000	62.9	102.0	V	0.0	88.6	25.7	11.1	74

Remark: 1. Correction Factor = Antenna factor+ Insertion loss (cable loss + amplifier gain)

Frequency (MHz)	Average (dBuV/m)	Height (cm)	Polarization	Azimuth (deg)	Reading value (dBuV/m)	Correct Factor (dB)	Margin (dB)	Limit (dBuV/m)
3961.875000	31.3	102.0	H	0.0	32.3	-1.0	22.7	54
5420.625000	34.2	102.0	H	25.0	36.9	2.7	19.8	54
6894.375000	36.7	102.0	V	289.0	42.9	6.2	17.3	54
9646.875000	40.1	102.0	H	163.0	49.9	9.8	13.9	54
12673.125000	42.7	102.0	H	40.0	56.8	14.1	11.3	54
17906.250000	51.9	102.0	V	227.0	77.2	25.3	2.1	54

Remark: 1. Correction Factor = Antenna factor+ Insertion loss (cable loss + amplifier gain)

RE 18-26.5GHz PK+AV

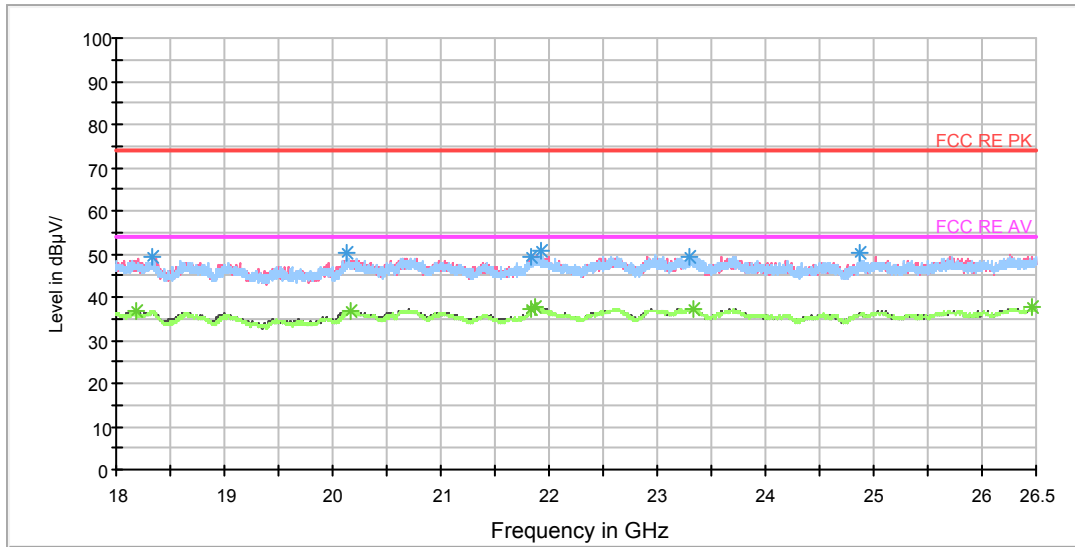

Radiates Emission from 18GHz to 26.5GHz

Frequency (MHz)	Peak (dBuV/m)	Polarization	Azimuth (deg)	Reading value (dBuV/m)	Correct Factor (dB)	Margin (dB)	Limit (dBuV/m)
18340.000000	49.1	V	194.0	52.3	-3.2	24.9	74
20132.437500	50.2	H	99.0	56.0	-5.8	23.8	74
21836.687500	49.2	H	180.0	57.2	-8.0	24.8	74
21921.687500	50.6	H	2.0	58.6	-8.0	23.4	74
23301.875000	49.4	V	167.0	55.4	-6.0	24.6	74
24871.187500	50.3	H	166.0	56.2	-5.9	23.7	74

Remark: 1. Correction Factor = Antenna factor+ Insertion loss (cable loss + amplifier gain)

Frequency (MHz)	Average (dBuV/m)	Polarization	Azimuth (deg)	Reading value (dBuV/m)	Correct Factor (dB)	Margin (dB)	Limit (dBuV/m)
18185.937500	36.7	V	275.0	39.3	-2.6	17.3	54
20172.812500	36.9	H	194.0	42.7	-5.8	17.1	54
21838.812500	37.2	H	44.0	45.2	-8.0	16.8	54
21866.437500	37.9	V	248.0	45.9	-8.0	16.1	54
23327.375000	37.4	H	318.0	43.4	-6.0	16.6	54
26455.375000	37.5	H	235.0	42.9	-5.4	16.5	54

Remark: 1. Correction Factor = Antenna factor+ Insertion loss (cable loss + amplifier gain)

802.11n (HT20) CH11

FCC RE 0.03-1GHz QP Class C

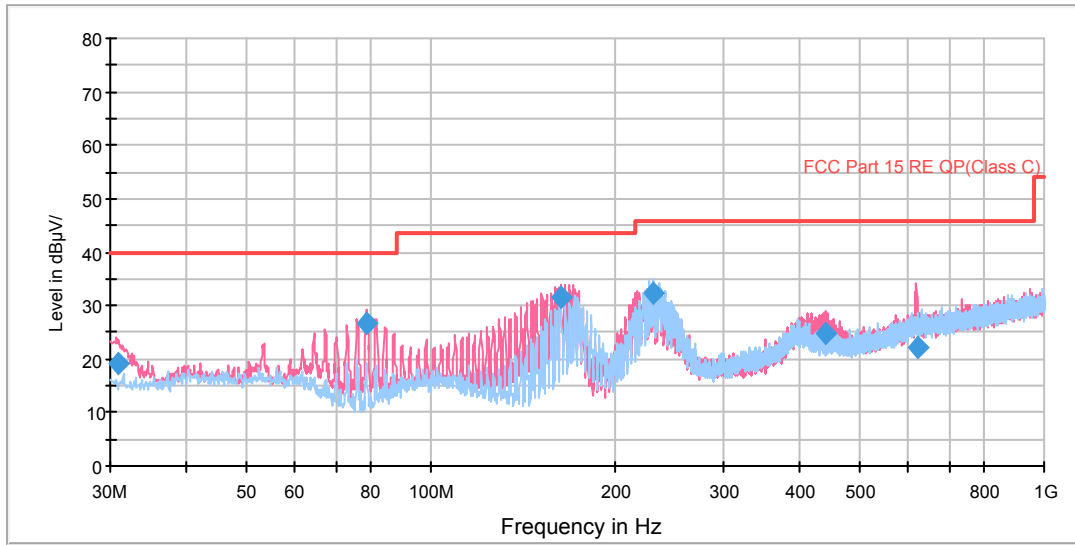

Radiates Emission from 30MHz to 1GHz

Frequency (MHz)	Quasi-Peak (dBuV/m)	Height (cm)	Polarization	Azimuth (deg)	Reading value (dBuV/m)	Correct Factor (dB)	Margin (dB)	Limit (dBuV/m)
30.967500	19.1	100.0	V	359.0	31.0	11.9	20.9	40.0
78.498750	26.7	125.0	V	0.0	35.2	8.5	13.3	40.0
162.810000	31.6	111.0	V	231.0	41.5	9.9	11.9	43.5
230.061250	32.3	125.0	H	266.0	45.5	13.2	13.7	46.0
439.987500	24.9	100.0	V	17.0	43.7	18.8	21.1	46.0
620.283750	22.2	100.0	V	16.0	44.4	22.2	23.8	46.0

- Remark: 1. Quasi-Peak = Reading value + Correction factor
 2. Correction Factor = Antenna factor+ Insertion loss(cable loss+amplifier gain)
 3. Margin = Limit – Quasi-Peak

RE 1G-3GHz PK+AV

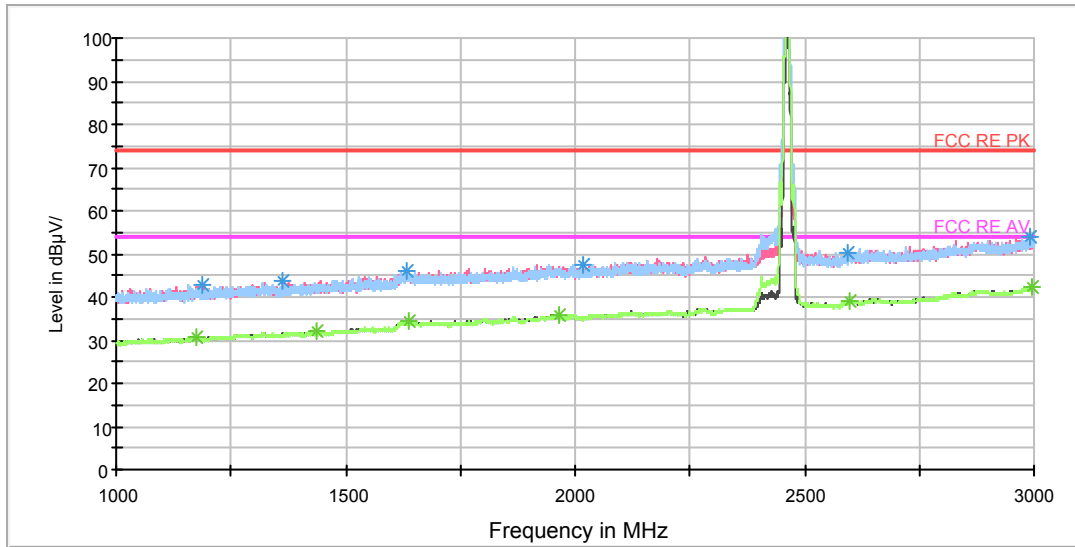

Note: The signal beyond the limit is carrier.
Radiates Emission from 1GHz to 3GHz

Frequency (MHz)	Peak (dBuV/m)	Height (cm)	Polarization	Azimuth (deg)	Reading value (dBuV/m)	Correct Factor (dB)	Margin (dB)	Limit (dBuV/m)
1187.500000	42.9	102.0	V	217.0	51.0	-8.1	31.1	74
1362.000000	43.6	102.0	V	217.0	51.0	-7.4	30.4	74
1634.750000	45.9	102.0	V	169.0	50.6	-4.7	28.1	74
2019.500000	47.5	102.0	H	145.0	51.1	-3.6	26.5	74
2592.750000	50.2	102.0	H	63.0	50.3	0.1	23.8	74
2990.750000	54.1	102.0	H	0.0	56.3	2.2	19.9	74

Remark: 1. Correction Factor = Antenna factor+ Insertion loss (cable loss + amplifier gain)

Frequency (MHz)	Average (dBuV/m)	Height (cm)	Polarization	Azimuth (deg)	Reading value (dBuV/m)	Correct Factor (dB)	Margin (dB)	Limit (dBuV/m)
1176.750000	30.8	102.0	V	135.0	38.8	-8.0	23.2	54
1437.750000	32.0	102.0	H	0.0	38.9	-6.9	22.0	54
1637.250000	34.5	102.0	V	233.0	39.2	-4.7	19.5	54
1963.250000	35.9	102.0	H	0.0	39.2	-3.3	18.1	54
2596.750000	39.1	102.0	V	298.0	39.4	0.3	14.9	54
2997.250000	42.5	102.0	V	282.0	44.8	2.3	11.5	54

Remark: 1. Correction Factor = Antenna factor+ Insertion loss (cable loss + amplifier gain)

RE 3-18GHz PK+AV

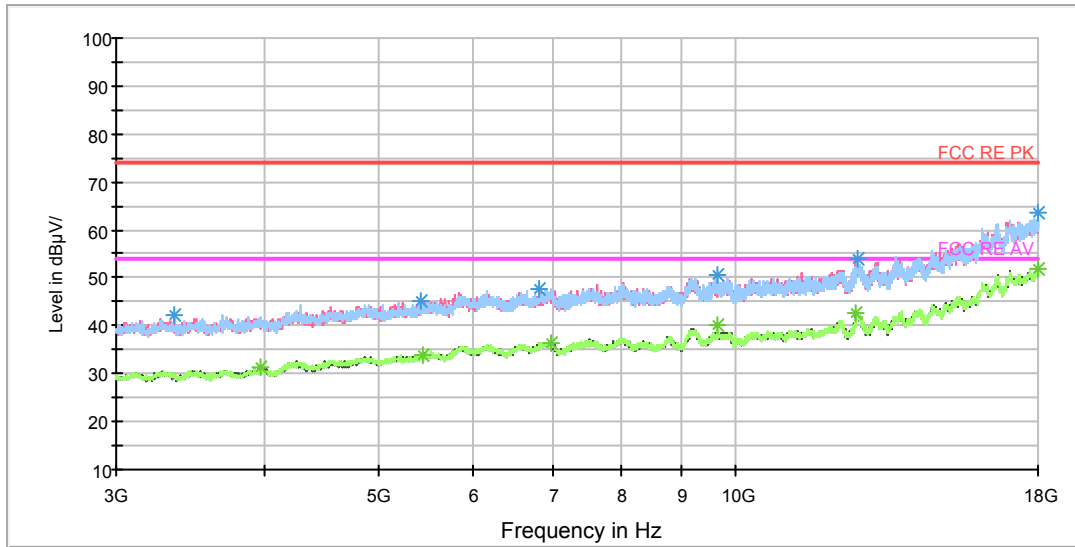

Radiates Emission from 3GHz to 18GHz

Frequency (MHz)	Peak (dBuV/m)	Height (cm)	Polarization	Azimuth (deg)	Reading value (dBuV/m)	Correct Factor (dB)	Margin (dB)	Limit (dBuV/m)
3356.250000	42.3	102.0	V	213.0	44.6	-2.3	31.7	74
5415.000000	45.4	102.0	H	166.0	48.0	2.6	28.6	74
6828.750000	47.7	102.0	H	81.0	53.5	5.8	26.3	74
9646.875000	50.7	102.0	H	166.0	60.5	9.8	23.3	74
12665.625000	53.9	102.0	V	46.0	67.8	13.9	20.1	74
17985.000000	63.7	102.0	V	29.0	88.8	25.1	10.3	74

Remark: 1. Correction Factor = Antenna factor+ Insertion loss (cable loss + amplifier gain)

Frequency (MHz)	Average (dBuV/m)	Height (cm)	Polarization	Azimuth (deg)	Reading value (dBuV/m)	Correct Factor (dB)	Margin (dB)	Limit (dBuV/m)
3971.250000	31.4	102.0	V	351.0	32.3	-0.9	22.6	54
5448.750000	33.9	102.0	V	321.0	36.7	2.8	20.1	54
6976.875000	36.5	102.0	V	321.0	42.8	6.3	17.5	54
9648.750000	40.1	102.0	H	166.0	49.9	9.8	13.9	54
12650.625000	42.7	102.0	H	313.0	56.8	14.1	11.3	54
18000.000000	52.0	102.0	H	0.0	77.5	25.5	2.0	54

Remark: 1. Correction Factor = Antenna factor+ Insertion loss (cable loss + amplifier gain)

RE 18-26.5GHz PK+AV

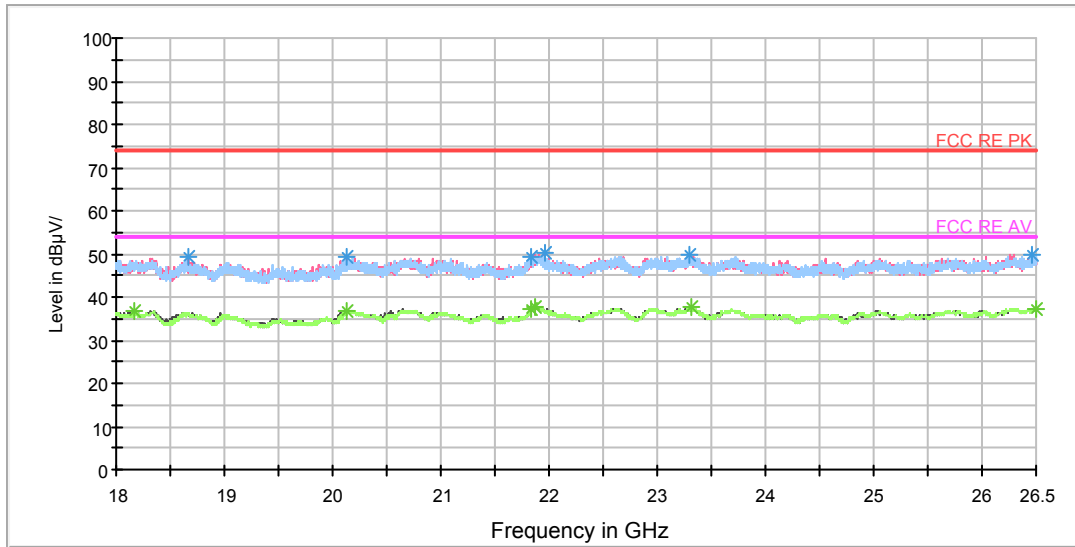

Radiates Emission from 18GHz to 26.5GHz

Frequency (MHz)	Peak (dBuV/m)	Polarization	Azimuth (deg)	Reading value (dBuV/m)	Correct Factor (dB)	Margin (dB)	Limit (dBuV/m)
18671.500000	49.4	V	153.0	53.7	-4.3	24.6	74
20128.187500	49.1	V	261.0	54.9	-5.8	24.9	74
21835.625000	49.5	H	0.0	57.5	-8.0	24.5	74
21955.687500	50.2	H	0.0	58.2	-8.0	23.8	74
23298.687500	49.7	H	99.0	55.7	-6.0	24.3	74
26460.687500	49.9	V	110.0	55.3	-5.4	24.1	74

Remark: 1. Correction Factor = Antenna factor+ Insertion loss (cable loss + amplifier gain)

Frequency (MHz)	Average (dBuV/m)	Polarization	Azimuth (deg)	Reading value (dBuV/m)	Correct Factor (dB)	Margin (dB)	Limit (dBuV/m)
18173.187500	36.7	H	0.0	39.2	-2.5	17.3	54
20127.125000	36.9	V	180.0	42.7	-5.8	17.1	54
21838.812500	37.2	V	274.0	45.2	-8.0	16.8	54
21866.437500	37.9	V	341.0	45.9	-8.0	16.1	54
23314.625000	37.5	H	17.0	43.5	-6.0	16.5	54
26497.875000	37.3	V	301.0	42.7	-5.4	16.7	54

Remark: 1. Correction Factor = Antenna factor+ Insertion loss (cable loss + amplifier gain)

BLE-Channel 0

FCC RE 0.03-1GHz QP Class C

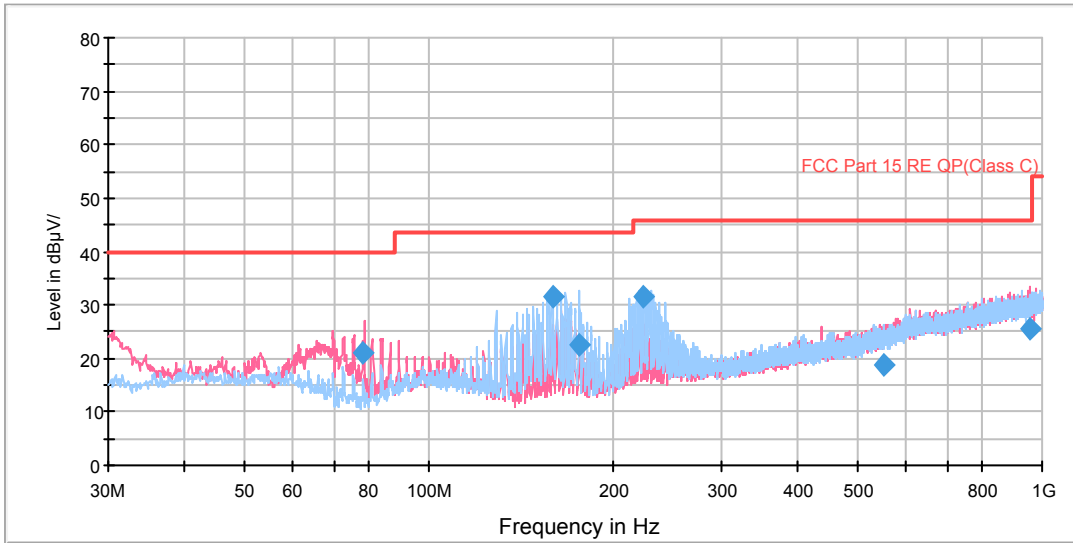

Radiates Emission from 30MHz to 1GHz

Frequency (MHz)	Quasi-Peak (dBuV/m)	Height (cm)	Polarization	Azimuth (deg)	Reading value (dBuV/m)	Correct Factor (dB)	Margin (dB)	Limit (dBuV/m)
78.100000	20.9	100.0	V	58.0	29.4	8.5	19.1	40.0
158.890000	31.5	125.0	H	325.0	41.1	9.6	12.0	43.5
176.185000	22.6	113.0	H	291.0	33.2	10.6	20.9	43.5
223.228750	31.6	125.0	H	315.0	44.6	13.0	14.4	46.0
551.211250	18.7	125.0	H	166.0	39.7	21.0	27.3	46.0
955.738750	25.4	100.0	V	271.0	51.5	26.1	20.6	46.0

- Remark:**
1. Quasi-Peak = Reading value + Correction factor
 2. Correction Factor = Antenna factor+ Insertion loss(cable loss+amplifier gain)
 3. Margin = Limit – Quasi-Peak

RE 1G-3GHz PK+AV

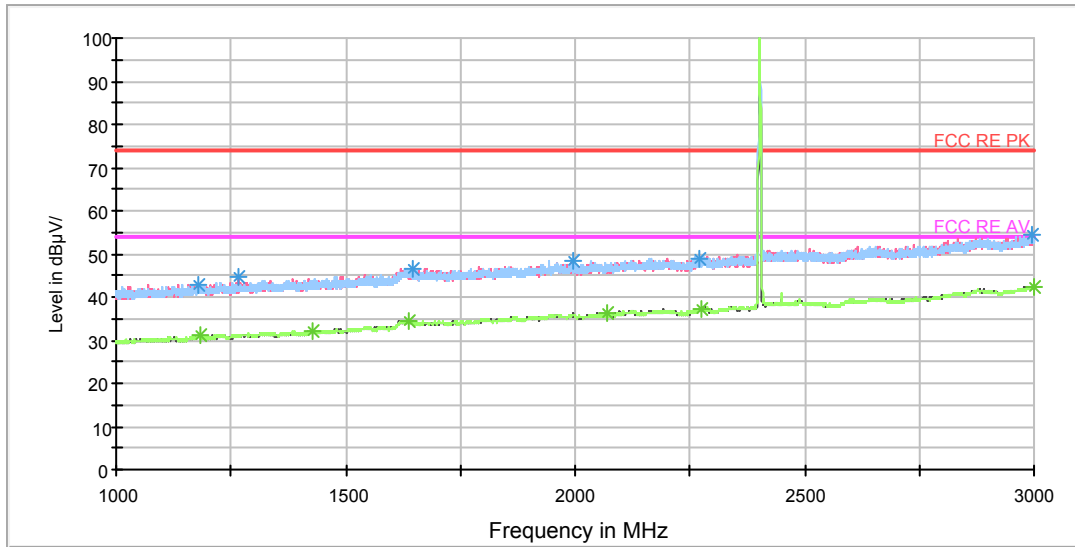

Note: The signal beyond the limit is carrier.
Radiates Emission from 1GHz to 3GHz

Frequency (MHz)	Peak (dBuV/m)	Height (cm)	Polarization	Azimuth (deg)	Reading value (dBuV/m)	Correct Factor (dB)	Margin (dB)	Limit (dBuV/m)
1178.750000	42.9	101.0	V	298.0	50.9	-8.0	31.1	74
1265.500000	44.7	400.0	V	20.0	52.4	-7.7	29.3	74
1644.500000	46.7	201.0	V	137.0	51.6	-4.9	27.3	74
1995.000000	48.5	400.0	H	176.0	51.7	-3.2	25.5	74
2993.500000	54.5	101.0	H	0.0	56.7	2.2	19.5	74
2271.500000	48.9	101.0	H	2.0	50.5	-1.6	25.1	74

Remark: 1. Correction Factor = Antenna factor+ Insertion loss (cable loss + amplifier gain)

Frequency (MHz)	Average (dBuV/m)	Height (cm)	Polarization	Azimuth (deg)	Reading value (dBuV/m)	Correct Factor (dB)	Margin (dB)	Limit (dBuV/m)
1181.250000	31.0	201.0	H	0.0	39.0	-8.0	23.0	54
1428.750000	32.2	400.0	H	119.0	39.1	-6.9	21.8	54
1637.500000	34.5	201.0	V	17.0	39.2	-4.7	19.5	54
2072.000000	36.2	301.0	H	130.0	39.3	-3.1	17.8	54
2998.000000	42.3	301.0	H	309.0	44.6	2.3	11.7	54
2274.250000	37.2	201.0	V	329.0	38.7	-1.5	16.8	54

Remark: 1. Correction Factor = Antenna factor+ Insertion loss (cable loss + amplifier gain)

RE 3-18GHz PK+AV

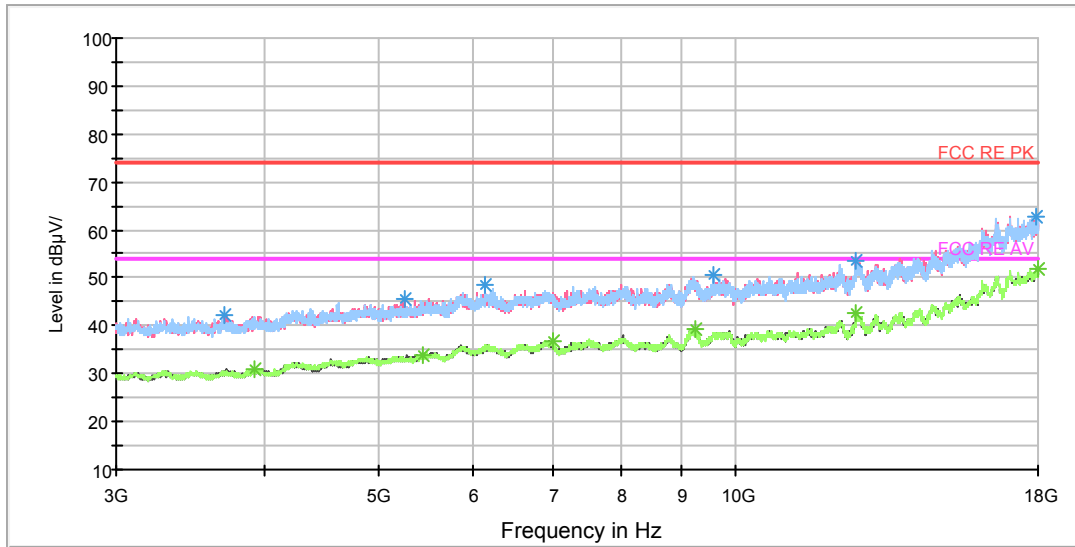

Radiates Emission from 3GHz to 18GHz

Frequency (MHz)	Peak (dBuV/m)	Height (cm)	Polarization	Azimuth (deg)	Reading value (dBuV/m)	Correct Factor (dB)	Margin (dB)	Limit (dBuV/m)
3706.875000	42.2	102.0	V	0.0	43.8	-1.6	31.8	74
5250.000000	45.5	102.0	V	0.0	47.6	2.1	28.5	74
6144.375000	48.6	102.0	H	0.0	54	5.4	25.4	74
9590.625000	50.5	102.0	H	197.0	60.4	9.9	23.5	74
12633.750000	53.7	102.0	V	321.0	67.6	13.9	20.3	74
17910.000000	62.8	102.0	H	0.0	88.3	25.5	11.2	74

Remark: 1. Correction Factor = Antenna factor+ Insertion loss (cable loss + amplifier gain)

Frequency (MHz)	Average (dBuV/m)	Height (cm)	Polarization	Azimuth (deg)	Reading value (dBuV/m)	Correct Factor (dB)	Margin (dB)	Limit (dBuV/m)
3930.000000	31.0	102.0	V	101.0	32.2	-1.2	23.0	54
5437.500000	34.0	102.0	V	0.0	36.9	2.9	20.0	54
7008.750000	36.9	102.0	V	352.0	43.4	6.5	17.1	54
9240.000000	39.3	102.0	V	195.0	49.2	9.9	14.7	54
12646.875000	42.7	102.0	H	132.0	57.0	14.3	11.3	54
18000.000000	52.0	102.0	H	0.0	77.5	25.5	2.0	54

Remark: 1. Correction Factor = Antenna factor+ Insertion loss (cable loss + amplifier gain)

RE 18-26.5GHz PK+AV

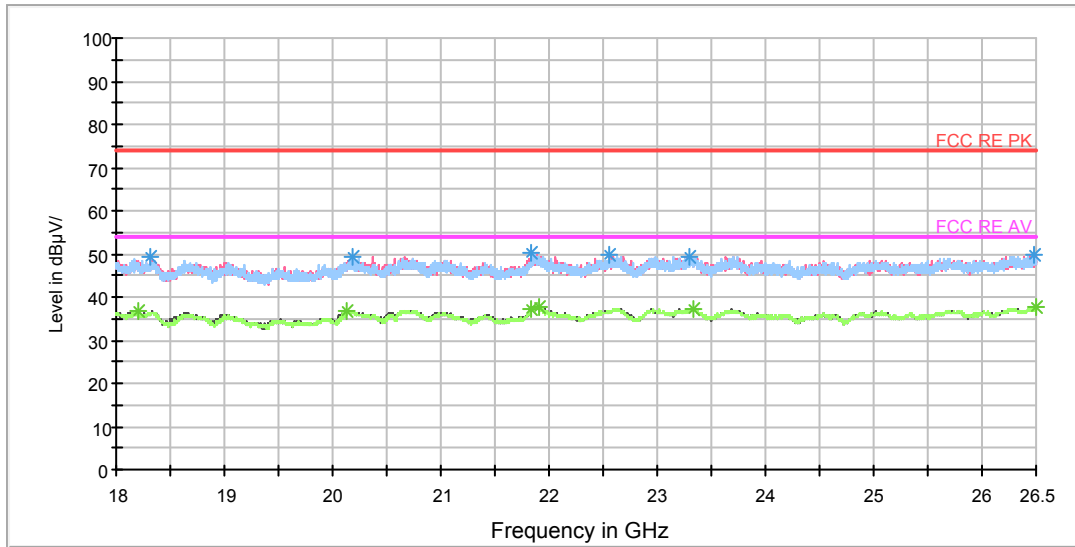

Radiates Emission from 18GHz to 26.5GHz

Frequency (MHz)	Peak (dBuV/m)	Polarization	Azimuth (deg)	Reading value (dBuV/m)	Correct Factor (dB)	Margin (dB)	Limit (dBuV/m)
18320.875000	49.2	V	263.0	52.4	-3.2	24.8	74
20178.125000	49.4	H	45.0	55.2	-5.8	24.6	74
21826.062500	50.3	H	58.0	58.3	-8.0	23.7	74
22547.500000	49.9	V	330.0	56.7	-6.8	24.1	74
23299.750000	49.4	V	357.0	55.4	-6.0	24.6	74
26474.500000	50.0	H	167.0	55.4	-5.4	24.0	74

Remark: 1. Correction Factor = Antenna factor+ Insertion loss (cable loss + amplifier gain)

Frequency (MHz)	Average (dBuV/m)	Polarization	Azimuth (deg)	Reading value (dBuV/m)	Correct Factor (dB)	Margin (dB)	Limit (dBuV/m)
18196.562500	36.7	V	0.0	39.3	-2.6	17.3	54
20137.750000	36.8	V	0.0	42.6	-5.8	17.2	54
21838.812500	37.3	V	0.0	45.3	-8.0	16.7	54
21906.812500	37.7	V	195.0	45.7	-8.0	16.3	54
23324.187500	37.4	V	276.0	43.4	-6.0	16.6	54
26498.937500	37.5	V	0.0	42.9	-5.4	16.5	54

Remark: 1. Correction Factor = Antenna factor+ Insertion loss (cable loss + amplifier gain)

BLE-Channel 19

FCC RE 0.03-1GHz QP Class C

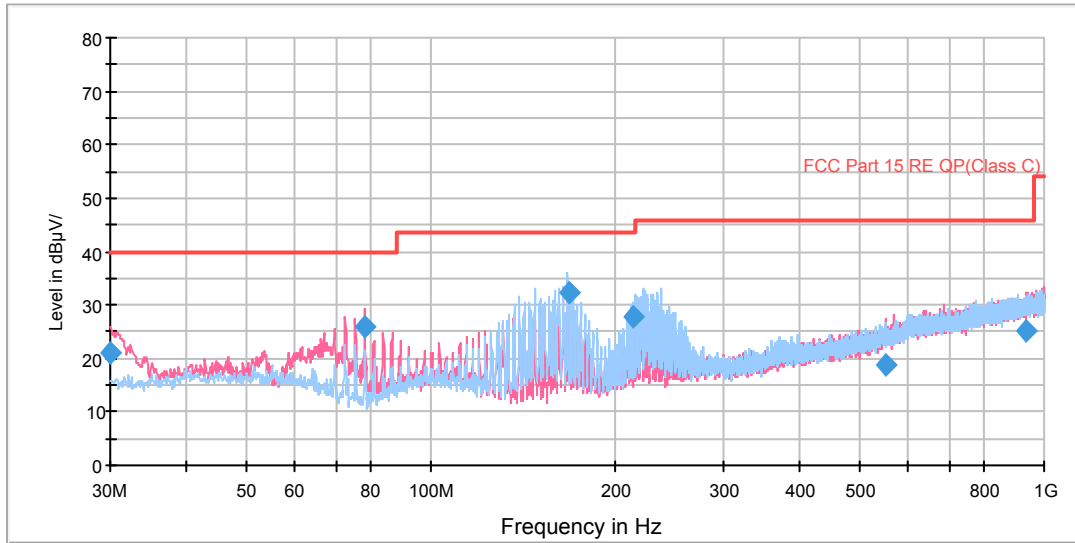

Radiates Emission from 30MHz to 1GHz

Frequency (MHz)	Quasi-Peak (dBuV/m)	Height (cm)	Polarization	Azimuth (deg)	Reading value (dBuV/m)	Correct Factor (dB)	Margin (dB)	Limit (dBuV/m)
30.000000	21.1	100.0	V	212.0	33.0	11.9	18.9	40.0
78.096250	25.8	125.0	V	99.0	34.3	8.5	14.2	40.0
167.496250	32.2	125.0	H	317.0	42.3	10.1	11.4	43.5
214.425000	27.8	100.0	H	317.0	40.4	12.6	15.7	43.5
551.290000	18.7	100.0	V	170.0	39.7	21.0	27.3	46.0
935.622500	25.1	100.0	V	353.0	51.0	25.9	20.9	46.0

- Remark:**
1. Quasi-Peak = Reading value + Correction factor
 2. Correction Factor = Antenna factor+ Insertion loss(cable loss+amplifier gain)
 3. Margin = Limit – Quasi-Peak

RE 1G-3GHz PK+AV

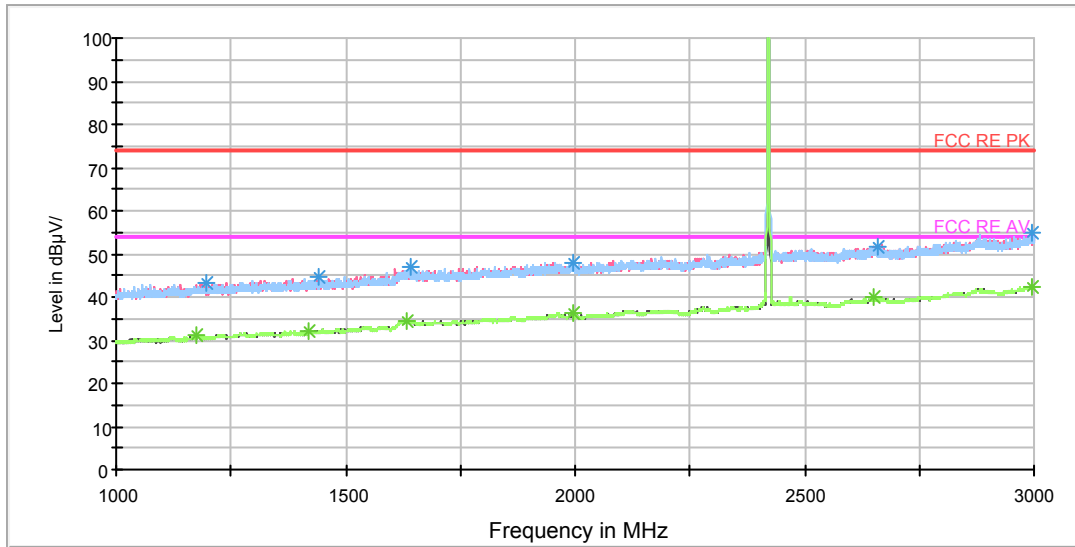

Note: The signal beyond the limit is carrier.
Radiates Emission from 1GHz to 3GHz

Frequency (MHz)	Peak (dBuV/m)	Height (cm)	Polarization	Azimuth (deg)	Reading value (dBuV/m)	Correct Factor (dB)	Margin (dB)	Limit (dBuV/m)
1197.250000	43.1	301.0	V	62.0	51.3	-8.2	30.9	74
1441.500000	44.5	301.0	V	315.0	51.4	-6.9	29.5	74
1643.250000	47.0	201.0	H	166.0	51.8	-4.8	27.0	74
1996.750000	48.0	400.0	V	109.0	51.3	-3.3	26.0	74
2995.000000	54.7	301.0	H	72.0	57	2.3	19.3	74
2660.000000	51.6	301.0	H	8.0	52	0.4	22.4	74

Remark: 1. Correction Factor = Antenna factor+ Insertion loss (cable loss + amplifier gain)

Frequency (MHz)	Average (dBuV/m)	Height (cm)	Polarization	Azimuth (deg)	Reading value (dBuV/m)	Correct Factor (dB)	Margin (dB)	Limit (dBuV/m)
1175.750000	31.2	201.0	V	0.0	39.2	-8.0	22.8	54
1417.250000	32.1	301.0	V	324.0	39.0	-6.9	21.9	54
1634.250000	34.5	201.0	H	268.0	39.2	-4.7	19.5	54
1996.500000	36.3	101.0	V	192.0	39.6	-3.3	17.7	54
2995.750000	42.4	301.0	H	175.0	44.7	2.3	11.6	54
2649.250000	39.8	201.0	V	157.0	40.2	0.4	14.2	54

Remark: 1. Correction Factor = Antenna factor+ Insertion loss (cable loss + amplifier gain)

RE 3-18GHz PK+AV

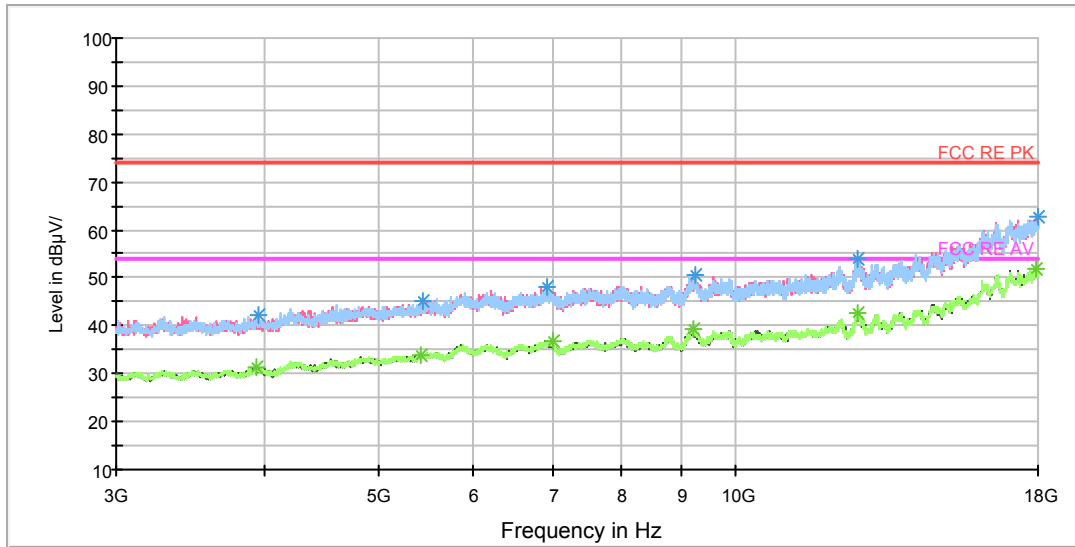

Radiates Emission from 3GHz to 18GHz

Frequency (MHz)	Peak (dBuV/m)	Height (cm)	Polarization	Azimuth (deg)	Reading value (dBuV/m)	Correct Factor (dB)	Margin (dB)	Limit (dBuV/m)
3960.000000	42.3	102.0	H	0.0	43.3	-1.0	31.7	74
5443.125000	45.2	102.0	V	254.0	48.1	2.9	28.8	74
6941.250000	48.0	102.0	V	0.0	54.1	6.1	26.0	74
9240.000000	50.6	102.0	H	45.0	60.5	9.9	23.4	74
12680.625000	53.9	102.0	V	269.0	68.2	14.3	20.1	74
17986.875000	62.8	102.0	H	0.0	87.9	25.1	11.2	74

Remark: 1. Correction Factor = Antenna factor+ Insertion loss (cable loss + amplifier gain)

Frequency (MHz)	Average (dBuV/m)	Height (cm)	Polarization	Azimuth (deg)	Reading value (dBuV/m)	Correct Factor (dB)	Margin (dB)	Limit (dBuV/m)
3945.000000	31.2	102.0	H	123.0	32.3	-1.1	22.8	54
5426.250000	34.0	102.0	H	13.0	36.8	2.8	20.0	54
7001.250000	36.7	102.0	V	237.0	43.3	6.6	17.3	54
9228.750000	39.4	102.0	V	331.0	49.3	9.9	14.6	54
12676.875000	42.6	102.0	H	91.0	56.8	14.2	11.4	54
17919.375000	51.8	102.0	V	128.0	77.6	25.8	2.2	54

Remark: 1. Correction Factor = Antenna factor+ Insertion loss (cable loss + amplifier gain)

RE 18-26.5GHz PK+AV

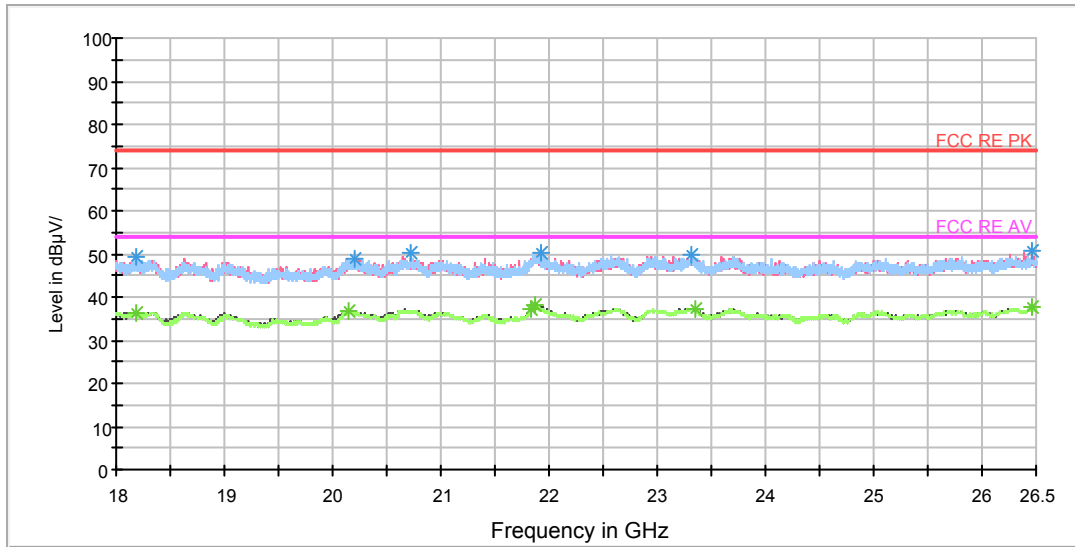

Radiates Emission from 18GHz to 26.5GHz

Frequency (MHz)	Peak (dBuV/m)	Polarization	Azimuth (deg)	Reading value (dBuV/m)	Correct Factor (dB)	Margin (dB)	Limit (dBuV/m)
18190.187500	49.3	H	58.0	51.9	-2.6	24.7	74
20212.125000	48.9	H	0.0	54.8	-5.9	25.1	74
20720.000000	50.2	H	0.0	56.9	-6.7	23.8	74
21933.375000	50.1	V	327.0	58.1	-8.0	23.9	74
23307.187500	49.8	H	140.0	55.8	-6.0	24.2	74
26464.937500	50.5	V	300.0	55.9	-5.4	23.5	74

Remark: 1. Correction Factor = Antenna factor+ Insertion loss (cable loss + amplifier gain)

Frequency (MHz)	Average (dBuV/m)	Polarization	Azimuth (deg)	Reading value (dBuV/m)	Correct Factor (dB)	Margin (dB)	Limit (dBuV/m)
18185.937500	36.5	V	193.0	39.1	-2.6	17.5	54
20142.000000	36.8	V	340.0	42.6	-5.8	17.2	54
21838.812500	37.2	V	152.0	45.2	-8.0	16.8	54
21865.375000	38.0	H	71.0	46.0	-8.0	16.0	54
23348.625000	37.4	H	209.0	43.3	-5.9	16.6	54
26460.687500	37.5	V	314.0	42.9	-5.4	16.5	54

Remark: 1. Correction Factor = Antenna factor+ Insertion loss (cable loss + amplifier gain)

BLE-Channel 39

FCC RE 0.03-1GHz QP Class C

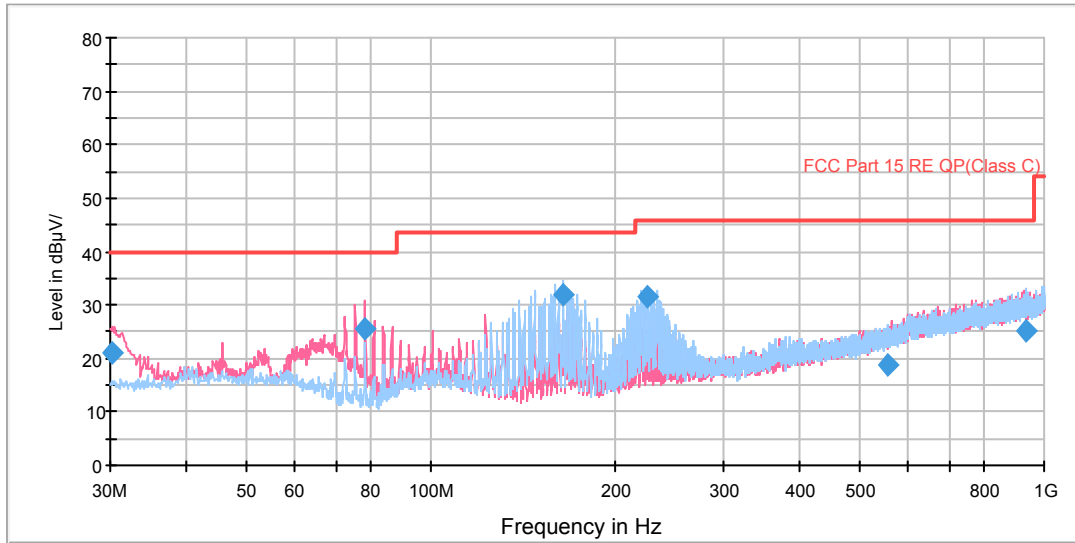

Radiates Emission from 30MHz to 1GHz

Frequency (MHz)	Quasi-Peak (dBuV/m)	Height (cm)	Polarization	Azimuth (deg)	Reading value (dBuV/m)	Correct Factor (dB)	Margin (dB)	Limit (dBuV/m)
30.240000	21.1	100.0	V	250.0	33.0	11.9	18.9	40.0
78.136250	25.4	100.0	V	289.0	33.9	8.5	14.6	40.0
164.388750	31.8	100.0	H	323.0	41.7	9.9	11.7	43.5
225.821250	31.7	125.0	H	323.0	44.8	13.1	14.3	46.0
556.268750	18.9	125.0	H	38.0	40.1	21.2	27.1	46.0
937.310000	25.1	100.0	H	0.0	51.0	25.9	20.9	46.0

- Remark:**
1. Quasi-Peak = Reading value + Correction factor
 2. Correction Factor = Antenna factor+ Insertion loss(cable loss+amplifier gain)
 3. Margin = Limit – Quasi-Peak

RE 1G-3GHz PK+AV

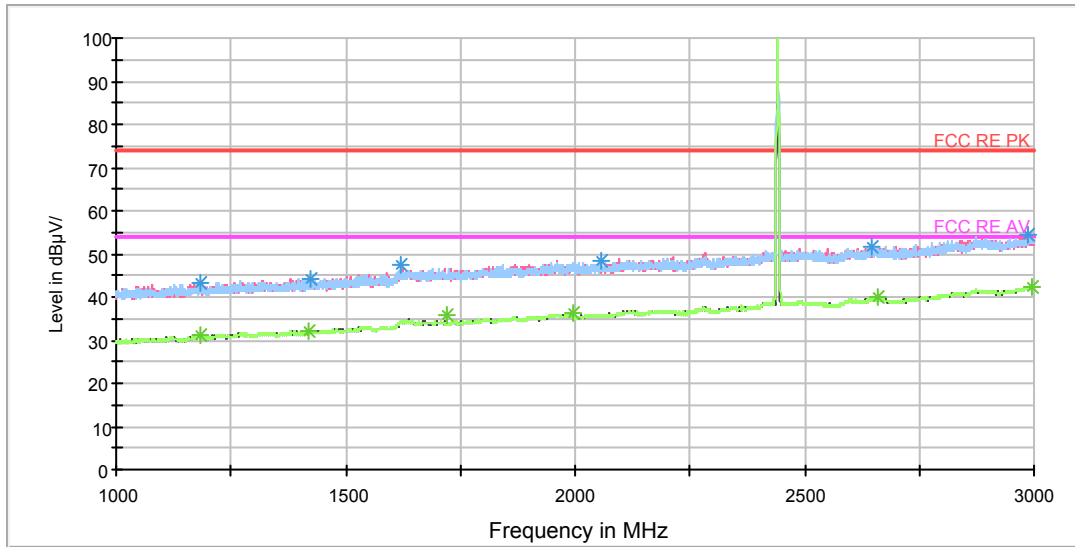

Note: The signal beyond the limit is carrier.
Radiates Emission from 1GHz to 3GHz

Frequency (MHz)	Peak (dBuV/m)	Height (cm)	Polarization	Azimuth (deg)	Reading value (dBuV/m)	Correct Factor (dB)	Margin (dB)	Limit (dBuV/m)
1182.250000	43.1	400.0	H	61.0	51.1	-8.0	30.9	74
1424.750000	44.3	400.0	H	176.0	51.2	-6.9	29.7	74
1619.000000	47.2	301.0	H	127.0	52.1	-4.9	26.8	74
2058.000000	48.4	201.0	H	0.0	51.6	-3.2	25.6	74
2988.250000	54.5	400.0	H	204.0	56.7	2.2	19.5	74
2644.750000	51.4	302.0	V	0.0	51.7	0.3	22.6	74

Remark: 1. Correction Factor = Antenna factor+ Insertion loss (cable loss + amplifier gain)

Frequency (MHz)	Average (dBuV/m)	Height (cm)	Polarization	Azimuth (deg)	Reading value (dBuV/m)	Correct Factor (dB)	Margin (dB)	Limit (dBuV/m)
1182.750000	31.1	201.0	V	29.0	39.1	-8.0	22.9	54
1420.250000	32.3	201.0	H	0.0	39.2	-6.9	21.7	54
1719.250000	36.0	201.0	H	287.0	40.9	-4.9	18.0	54
1997.000000	36.1	101.0	H	63.0	39.4	-3.3	17.9	54
2996.750000	42.5	400.0	V	0.0	44.8	2.3	11.5	54
2660.250000	40.0	301.0	H	0.0	40.4	0.4	14.0	54

Remark: 1. Correction Factor = Antenna factor+ Insertion loss (cable loss + amplifier gain)

RE 3-18GHz PK+AV

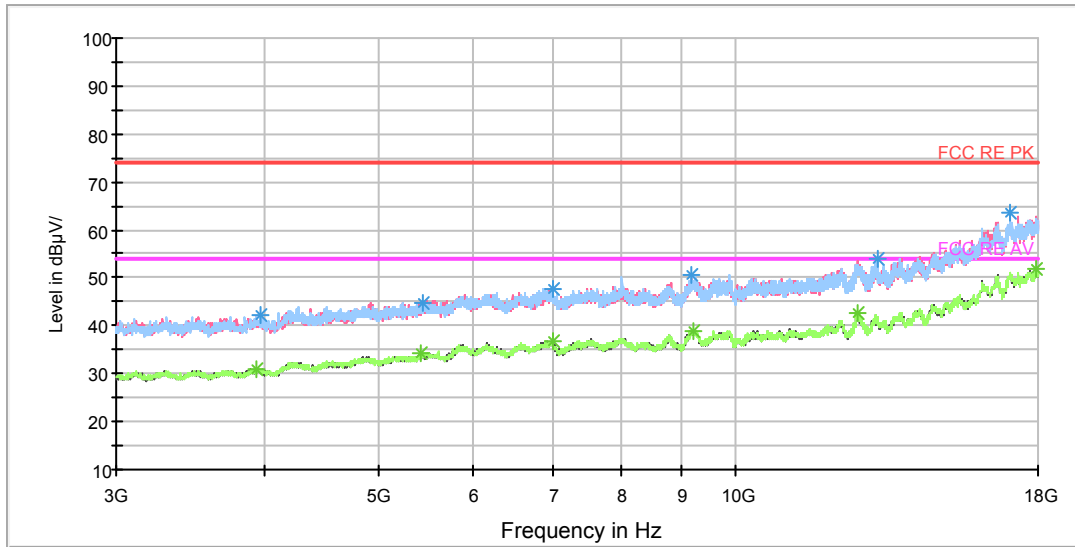

Radiates Emission from 3GHz to 18GHz

Frequency (MHz)	Peak (dBuV/m)	Height (cm)	Polarization	Azimuth (deg)	Reading value (dBuV/m)	Correct Factor (dB)	Margin (dB)	Limit (dBuV/m)
3971.250000	42.3	102.0	H	0.0	43.2	-0.9	31.7	74
5439.375000	44.9	102.0	H	0.0	47.8	2.9	29.1	74
7003.125000	47.9	102.0	V	0.0	54.4	6.5	26.1	74
9172.500000	50.6	102.0	V	207.0	60.7	10.1	23.4	74
13168.125000	53.8	102.0	H	250.0	67.8	14.0	20.2	74
17019.375000	63.8	102.0	H	124.0	88.3	24.5	10.2	74

Remark: 1. Correction Factor = Antenna factor+ Insertion loss (cable loss + amplifier gain)

Frequency (MHz)	Average (dBuV/m)	Height (cm)	Polarization	Azimuth (deg)	Reading value (dBuV/m)	Correct Factor (dB)	Margin (dB)	Limit (dBuV/m)
3946.875000	31.0	102.0	H	202.0	32.1	-1.1	23.0	54
5426.250000	34.4	102.0	H	140.0	37.2	2.8	19.6	54
6999.375000	36.8	102.0	H	0.0	43.3	6.5	17.2	54
9204.375000	39.1	102.0	H	124.0	49.3	10.2	14.9	54
12675.000000	42.6	102.0	V	0.0	56.7	14.1	11.4	54
17926.875000	51.8	102.0	H	18.0	77.3	25.5	2.2	54

Remark: 1. Correction Factor = Antenna factor+ Insertion loss (cable loss + amplifier gain)

RE 18-26.5GHz PK+AV

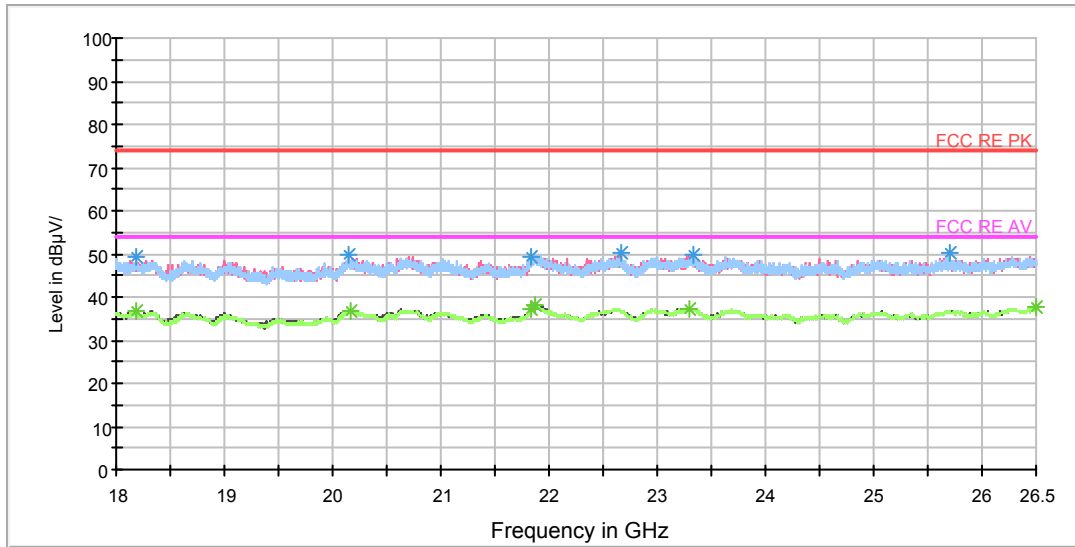

Radiates Emission from 18GHz to 26.5GHz

Frequency (MHz)	Peak (dBuV/m)	Polarization	Azimuth (deg)	Reading value (dBuV/m)	Correct Factor (dB)	Margin (dB)	Limit (dBuV/m)
18181.687500	49.5	H	3.0	52.1	-2.6	24.5	74
20145.187500	49.8	H	0.0	55.6	-5.8	24.2	74
21831.375000	49.4	H	124.0	57.4	-8.0	24.6	74
22660.125000	50.2	V	138.0	56.8	-6.6	23.8	74
23331.625000	49.7	V	125.0	55.7	-6.0	24.3	74
25706.312500	50.2	H	207.0	55.8	-5.6	23.8	74

Remark: 1. Correction Factor = Antenna factor+ Insertion loss (cable loss + amplifier gain)

Frequency (MHz)	Average (dBuV/m)	Polarization	Azimuth (deg)	Reading value (dBuV/m)	Correct Factor (dB)	Margin (dB)	Limit (dBuV/m)
18193.375000	36.7	V	207.0	39.3	-2.6	17.3	54
20171.750000	36.7	V	291.0	42.5	-5.8	17.3	54
21837.750000	37.3	H	56.0	45.3	-8.0	16.7	54
21863.250000	37.9	V	0.0	45.9	-8.0	16.1	54
23300.812500	37.4	H	137.0	43.4	-6.0	16.6	54
26497.875000	37.5	H	124.0	42.9	-5.4	16.5	54

Remark: 1. Correction Factor = Antenna factor+ Insertion loss (cable loss + amplifier gain)

5.8. Conducted Emission

Ambient condition

Temperature	Relative humidity	Pressure
23°C ~25°C	45%~50%	101.5kPa

Methods of Measurement

The EUT is placed on a non-metallic table of 80cm height above the horizontal metal reference ground plane. During the test, the EUT was operating in its typical mode. The test method is according to ANSI C63.10-2013. Connect the AC power line of the EUT to the L.I.S.N. Use EMI receiver to detect the average and Quasi-peak value. RBW is set to 9 kHz, VBW is set to 30kHz. The measurement result should include both L line and N line.

The test is in transmitting mode.

Test Setup

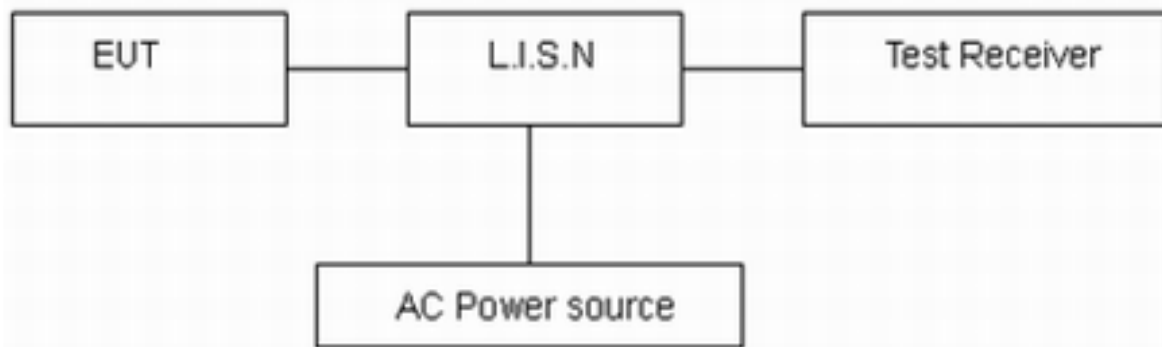

Note: AC Power source is used to change the voltage 110V/60Hz.

Limits

Frequency (MHz)	Conducted Limits(dBμV)	
	Quasi-peak	Average
0.15 - 0.5	66 to 56 *	56 to 46*
0.5 - 5	56	46
5 - 30	60	50

*: Decreases with the logarithm of the frequency.

Measurement Uncertainty

The assessed measurement uncertainty to ensure 95% confidence level for the normal distribution is with the coverage factor $k = 1.96$, $U = 2.69$ dB.



Test Results:

Following plots, Blue trace uses the peak detection and Green trace uses the average detection.

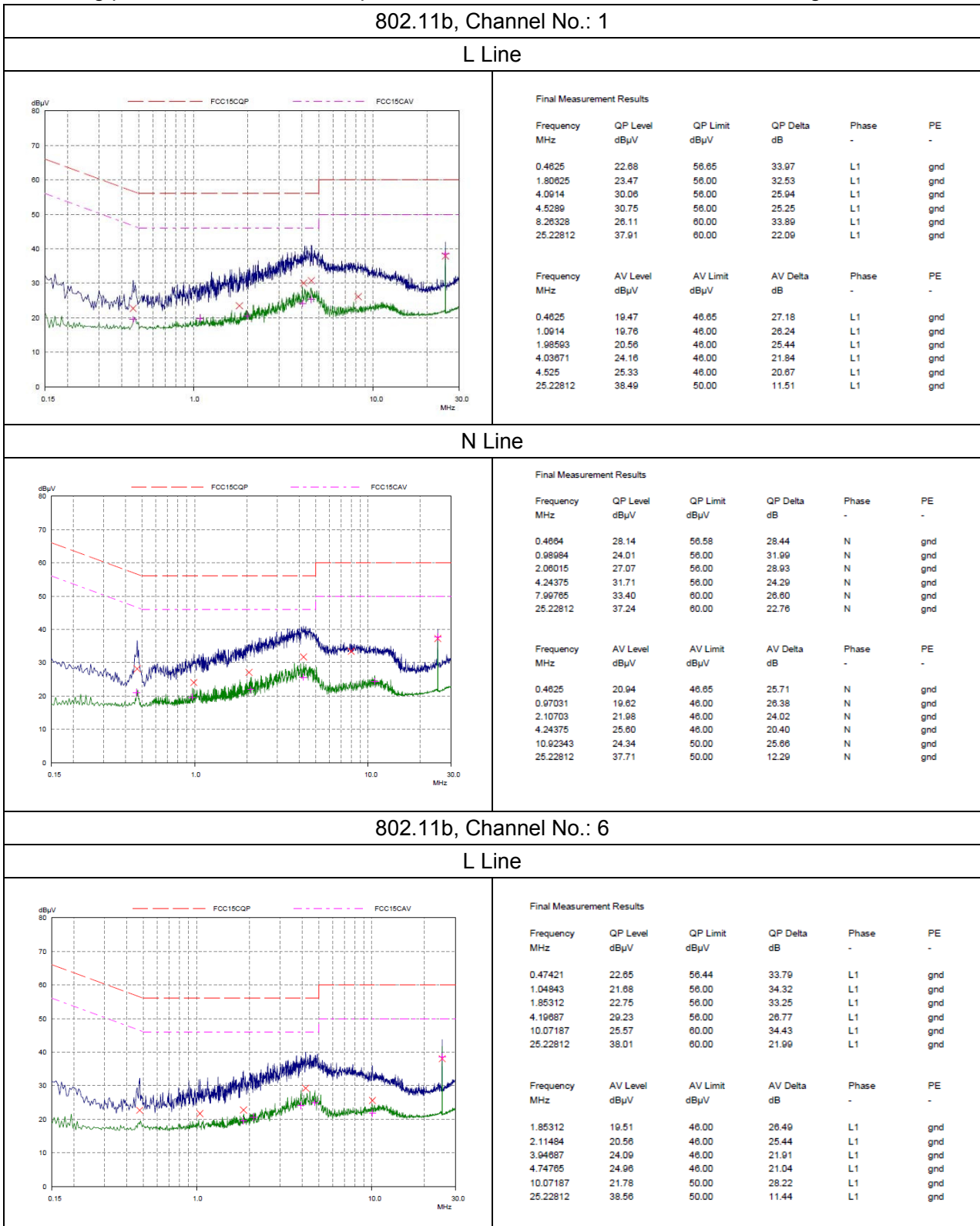



N Line

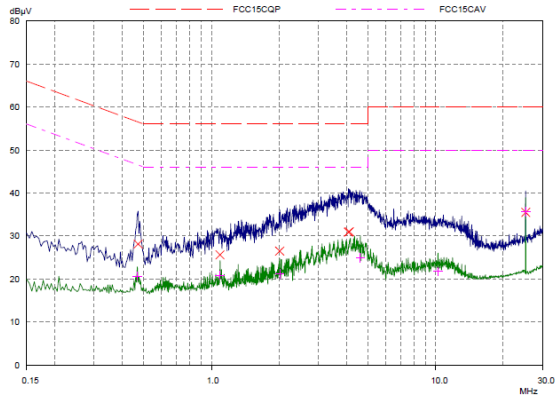

Final Measurement Results

Frequency MHz	QP Level dBµV	QP Limit dBµV	QP Delta dB	Phase	PE
0.47031	28.11	56.51	28.40	N	gnd
1.0914	25.80	56.00	30.40	N	gnd
2.01718	26.50	56.00	29.50	N	gnd
4.07967	30.89	56.00	25.11	N	gnd
4.11484	31.01	56.00	24.99	N	gnd
25.22812	35.48	60.00	24.52	N	gnd

Frequency MHz	AV Level dBµV	AV Limit dBµV	AV Delta dB	Phase	PE
0.4664	20.71	46.58	25.87	N	gnd
1.0914	20.83	46.00	25.17	N	gnd
2.01718	21.24	46.00	24.76	N	gnd
4.61093	24.94	46.00	21.06	N	gnd
10.25937	21.73	50.00	28.27	N	gnd
25.22812	35.62	50.00	14.38	N	gnd

802.11b, Channel No.: 11

L Line

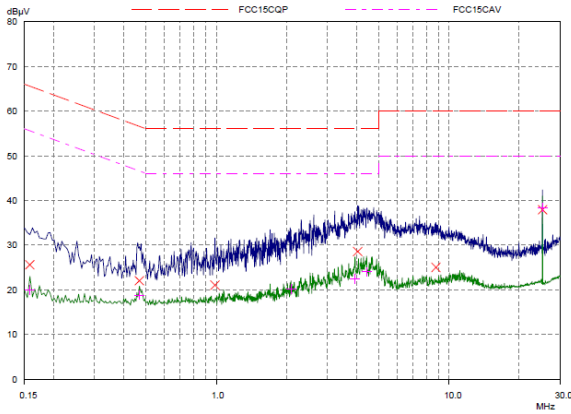

Final Measurement Results

Frequency MHz	QP Level dBµV	QP Limit dBµV	QP Delta dB	Phase	PE
0.15781	25.59	65.58	39.99	L1	gnd
0.4664	22.01	56.58	34.57	L1	gnd
0.98593	21.06	56.00	34.94	L1	gnd
4.05625	28.58	56.00	27.44	L1	gnd
8.7789	25.01	60.00	34.99	L1	gnd
25.22812	37.91	60.00	22.09	L1	gnd

Frequency MHz	AV Level dBµV	AV Limit dBµV	AV Delta dB	Phase	PE
0.15781	19.93	55.58	35.65	L1	gnd
0.4664	18.74	46.58	27.84	L1	gnd
2.09531	20.11	46.00	25.89	L1	gnd
3.94296	22.40	46.00	23.60	L1	gnd
4.42343	24.01	46.00	21.99	L1	gnd
25.22812	38.41	50.00	11.59	L1	gnd

N Line

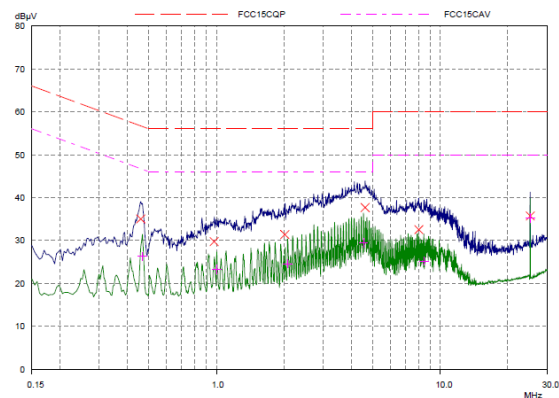

Final Measurement Results

Frequency MHz	QP Level dBµV	QP Limit dBµV	QP Delta dB	Phase	PE
0.45859	34.99	56.72	21.73	N	gnd
0.97812	29.76	56.00	26.24	N	gnd
2.02109	31.39	56.00	24.61	N	gnd
4.61875	37.67	56.00	18.33	N	gnd
8.00937	32.48	60.00	27.52	N	gnd
25.22812	35.72	60.00	24.28	N	gnd

Frequency MHz	AV Level dBµV	AV Limit dBµV	AV Delta dB	Phase	PE
0.4664	26.32	46.58	20.26	N	gnd
1.00156	23.26	46.00	22.74	N	gnd
2.07968	24.59	46.00	21.41	N	gnd
4.54453	29.51	46.00	16.49	N	gnd
8.45468	25.15	50.00	24.85	N	gnd
25.22812	35.21	50.00	14.79	N	gnd



802.11g, Channel No.: 1

L Line

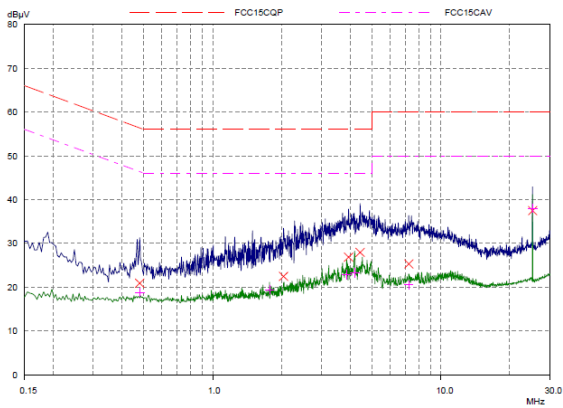

Final Measurement Results

Frequency MHz	QP Level dBuV	QP Limit dBuV	QP Delta dB	Phase	PE
0.47812	20.88	56.37	35.49	L1	gnd
2.04062	22.46	56.00	33.54	L1	gnd
3.93006	26.87	56.00	29.13	L1	gnd
4.43125	27.92	56.00	28.08	L1	gnd
7.23593	25.31	60.00	34.69	L1	gnd
25.22812	37.47	60.00	22.53	L1	gnd

Frequency MHz	AV Level dBuV	AV Limit dBuV	AV Delta dB	Phase	PE
0.47812	18.80	46.37	27.57	L1	gnd
1.775	19.38	46.00	26.62	L1	gnd
3.86484	22.81	46.00	23.19	L1	gnd
4.18515	23.31	46.00	22.69	L1	gnd
7.23593	20.51	50.00	29.49	L1	gnd
25.22812	37.95	50.00	12.05	L1	gnd

N Line

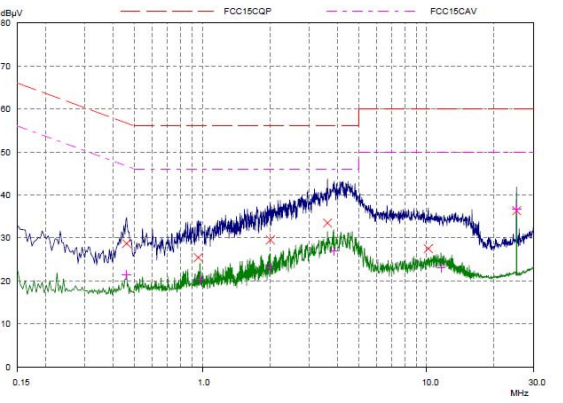

Final Measurement Results

Frequency MHz	QP Level dBuV	QP Limit dBuV	QP Delta dB	Phase	PE
0.45859	28.65	56.72	28.07	N	gnd
0.95859	25.43	56.00	30.57	N	gnd
2.00937	29.62	56.00	26.48	N	gnd
3.01875	33.46	56.00	22.54	N	gnd
10.20078	27.49	60.00	32.51	N	gnd
25.22812	36.31	60.00	23.69	N	gnd

Frequency MHz	AV Level dBuV	AV Limit dBuV	AV Delta dB	Phase	PE
0.45859	21.42	46.72	25.30	N	gnd
0.97421	20.35	46.00	25.65	N	gnd
2.00937	23.03	46.00	22.97	N	gnd
3.85312	26.89	46.00	19.11	N	gnd
11.62656	23.01	50.00	26.99	N	gnd
25.22812	36.64	50.00	13.36	N	gnd

802.11g, Channel No.: 6

L Line

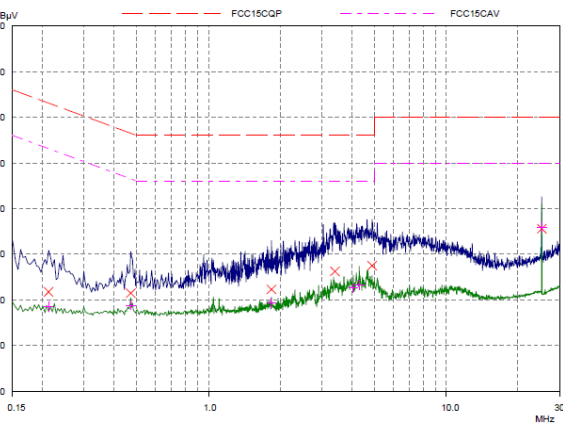

Final Measurement Results

Frequency MHz	QP Level dBuV	QP Limit dBuV	QP Delta dB	Phase	PE
0.2125	21.74	63.11	41.37	L1	gnd
0.47031	21.47	56.51	35.04	L1	gnd
1.8414	22.27	56.00	33.73	L1	gnd
3.4039	26.22	56.00	29.78	L1	gnd
4.88437	27.47	56.00	28.53	L1	gnd
25.22812	35.60	60.00	24.40	L1	gnd

Frequency MHz	AV Level dBuV	AV Limit dBuV	AV Delta dB	Phase	PE
0.2125	18.49	53.11	34.62	L1	gnd
0.47031	18.80	46.51	27.71	L1	gnd
1.8414	19.29	46.00	26.71	L1	gnd
4.06796	22.55	46.00	23.45	L1	gnd
4.31015	23.23	46.00	22.77	L1	gnd
25.22812	35.93	50.00	14.07	L1	gnd



N Line

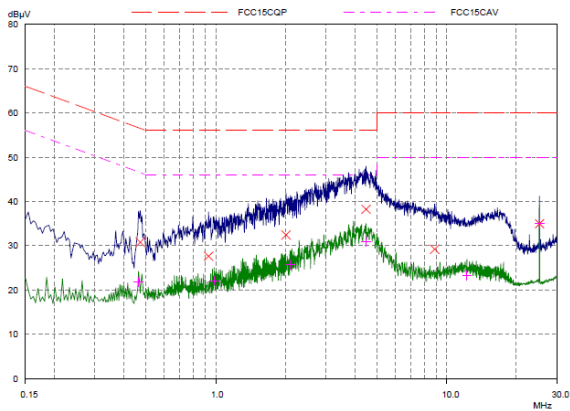

Final Measurement Results

Frequency MHz	QP Level dBµV	QP Limit dBµV	QP Delta dB	Phase	PE
0.47031	30.79	56.51	25.72	N	gnd
0.93125	27.60	56.00	28.40	N	gnd
2.01328	32.41	56.00	23.59	N	gnd
4.47812	38.24	56.00	17.76	N	gnd
8.86484	29.22	60.00	30.78	N	gnd
25.22812	34.95	60.00	25.05	N	gnd

Frequency MHz	AV Level dBµV	AV Limit dBµV	AV Delta dB	Phase	PE
0.4625	21.74	46.85	24.91	N	gnd
0.98203	22.06	46.00	23.94	N	gnd
2.10312	25.76	46.00	20.24	N	gnd
4.47812	30.96	46.00	15.04	N	gnd
12.22421	23.20	50.00	26.80	N	gnd
25.22812	35.09	50.00	14.91	N	gnd

802.11g, Channel No.: 11

L Line

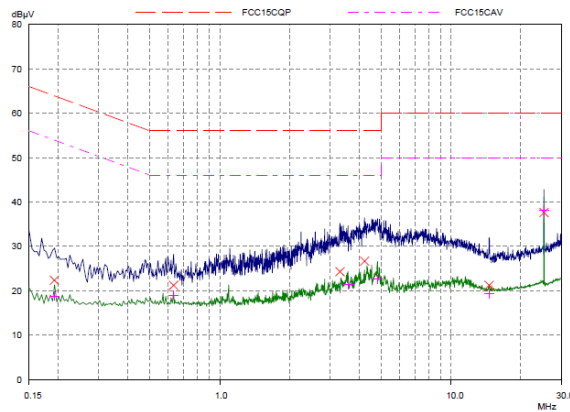

Final Measurement Results

Frequency MHz	QP Level dBµV	QP Limit dBµV	QP Delta dB	Phase	PE
0.19296	22.33	63.91	41.58	L1	gnd
0.63046	21.21	56.00	34.79	L1	gnd
3.31015	24.27	56.00	31.73	L1	gnd
4.22031	26.65	56.00	29.35	L1	gnd
14.62656	21.21	60.00	38.79	L1	gnd
25.22812	37.57	60.00	22.43	L1	gnd

Frequency MHz	AV Level dBµV	AV Limit dBµV	AV Delta dB	Phase	PE
0.19296	18.78	53.91	35.13	L1	gnd
0.63046	19.01	46.00	26.99	L1	gnd
3.5875	21.31	46.00	24.69	L1	gnd
4.81015	22.57	46.00	23.43	L1	gnd
14.62656	19.28	50.00	30.72	L1	gnd
25.22812	38.03	50.00	11.97	L1	gnd

N Line

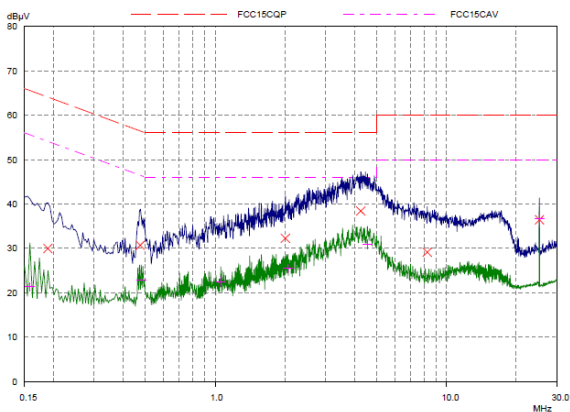

Final Measurement Results

Frequency MHz	QP Level dBµV	QP Limit dBµV	QP Delta dB	Phase	PE
0.18906	29.96	64.08	34.12	N	gnd
0.47421	30.67	56.44	25.77	N	gnd
2.00937	32.27	56.00	23.73	N	gnd
4.26328	38.41	56.00	17.59	N	gnd
8.26718	29.11	60.00	30.89	N	gnd
25.22812	36.43	60.00	23.57	N	gnd

Frequency MHz	AV Level dBµV	AV Limit dBµV	AV Delta dB	Phase	PE
0.15781	21.35	55.58	34.23	N	gnd
0.47812	22.80	46.37	23.57	N	gnd
1.05625	22.36	46.00	23.64	N	gnd
2.06015	25.48	46.00	20.52	N	gnd
4.55625	30.84	46.00	15.16	N	gnd
25.22812	36.73	50.00	13.27	N	gnd



802.11n(HT20), Channel No.: 1

L Line

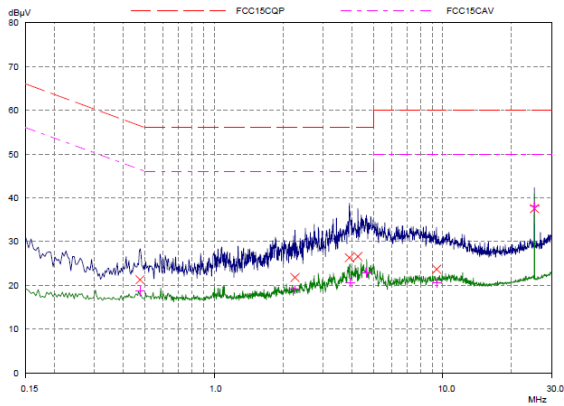

Final Measurement Results

Frequency MHz	QP Level dBμV	QP Limit dBμV	QP Delta dB	Phase	PE
0.47421	21.27	56.44	35.17	L1	gnd
2.25937	21.77	56.00	34.23	L1	gnd
3.91171	26.31	56.00	29.69	L1	gnd
4.25937	26.58	56.00	29.42	L1	gnd
9.4039	23.85	60.00	36.35	L1	gnd
25.22812	37.51	60.00	22.49	L1	gnd

Frequency MHz	AV Level dBμV	AV Limit dBμV	AV Delta dB	Phase	PE
0.47421	18.73	46.44	27.71	L1	gnd
2.25937	19.09	46.00	26.91	L1	gnd
3.93515	20.88	46.00	25.32	L1	gnd
4.8539	22.95	46.00	23.15	L1	gnd
9.4039	20.49	50.00	29.51	L1	gnd
25.22812	38.03	50.00	11.97	L1	gnd

N Line

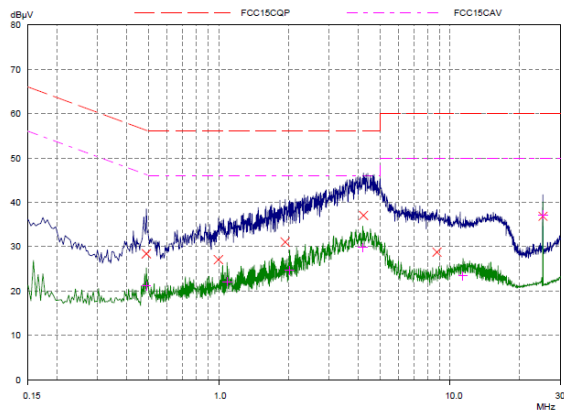

Final Measurement Results

Frequency MHz	QP Level dBμV	QP Limit dBμV	QP Delta dB	Phase	PE
0.48593	28.39	56.24	27.85	N	gnd
0.99765	27.05	56.00	28.95	N	gnd
1.93906	31.03	56.00	24.97	N	gnd
4.22421	37.02	56.00	18.98	N	gnd
8.78281	28.75	60.00	31.25	N	gnd
25.22812	36.84	60.00	23.16	N	gnd

Frequency MHz	AV Level dBμV	AV Limit dBμV	AV Delta dB	Phase	PE
0.48593	21.11	46.24	25.13	N	gnd
1.0875	22.15	46.00	23.85	N	gnd
2.0289	24.66	46.00	21.34	N	gnd
4.20468	29.80	46.00	16.20	N	gnd
11.4039	23.37	50.00	26.63	N	gnd
25.22812	37.12	50.00	12.88	N	gnd

802.11n(HT20), Channel No.: 6

L Line

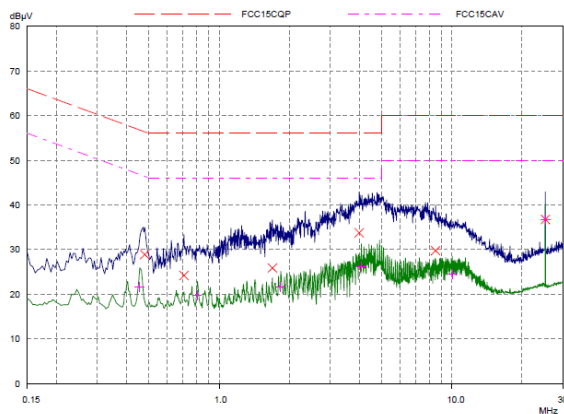

Final Measurement Results

Frequency MHz	QP Level dBμV	QP Limit dBμV	QP Delta dB	Phase	PE
0.47812	28.88	56.37	27.49	L1	gnd
0.70468	24.20	56.00	31.80	L1	gnd
1.69296	25.85	56.00	30.15	L1	gnd
3.99765	33.73	56.00	22.27	L1	gnd
8.51718	29.74	60.00	30.26	L1	gnd
25.22812	36.74	60.00	23.26	L1	gnd

Frequency MHz	AV Level dBμV	AV Limit dBμV	AV Delta dB	Phase	PE
0.45468	21.85	46.79	25.14	L1	gnd
0.80625	19.79	46.00	26.21	L1	gnd
1.8414	21.85	46.00	24.35	L1	gnd
4.08359	26.18	46.00	19.82	L1	gnd
10.04843	24.46	50.00	25.54	L1	gnd
25.22812	36.73	50.00	13.27	L1	gnd



N Line

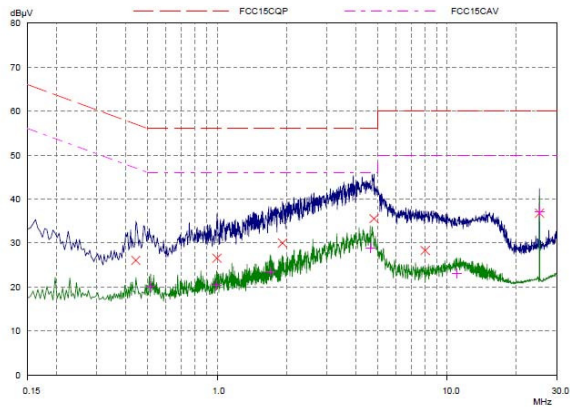

Final Measurement Results

Frequency MHz	QP Level dBµV	QP Limit dBµV	QP Delta dB	Phase	PE
0.44296	26.04	57.01	30.97	N	gnd
0.99765	26.55	56.00	29.45	N	gnd
1.92343	29.98	56.00	26.04	N	gnd
4.80625	35.52	56.00	20.48	N	gnd
8.025	28.30	60.00	31.70	N	gnd
25.22812	36.78	60.00	23.22	N	gnd

Frequency MHz	AV Level dBµV	AV Limit dBµV	AV Delta dB	Phase	PE
0.51327	20.22	46.00	25.78	N	gnd
0.99375	20.41	46.00	25.59	N	gnd
1.66987	23.52	46.00	22.48	N	gnd
4.62656	28.88	46.00	17.12	N	gnd
11.0289	23.11	50.00	26.89	N	gnd
25.22812	37.12	50.00	12.88	N	gnd

802.11n(HT20), Channel No.: 11

L Line

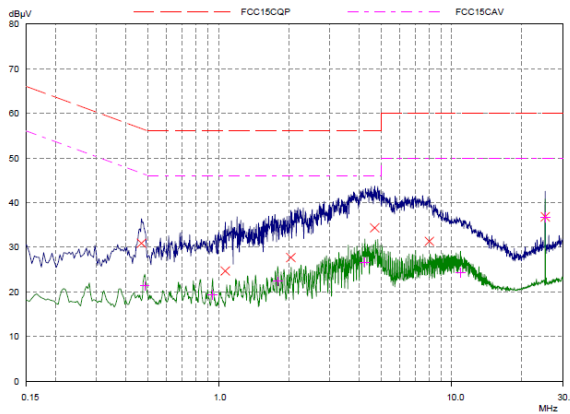

Final Measurement Results

Frequency MHz	QP Level dBµV	QP Limit dBµV	QP Delta dB	Phase	PE
0.4664	30.86	56.58	25.72	L1	gnd
1.06796	24.67	56.00	31.33	L1	gnd
2.04453	27.69	56.00	28.31	L1	gnd
4.67734	34.33	56.00	21.67	L1	gnd
8.0367	31.31	60.00	28.69	L1	gnd
25.22812	36.80	60.00	23.20	L1	gnd

Frequency MHz	AV Level dBµV	AV Limit dBµV	AV Delta dB	Phase	PE
0.48203	21.28	46.30	25.02	L1	gnd
0.94296	19.29	46.00	26.71	L1	gnd
1.79453	22.35	46.00	23.65	L1	gnd
4.24375	26.65	46.00	19.35	L1	gnd
10.91562	24.26	50.00	25.74	L1	gnd
25.22812	36.73	50.00	13.27	L1	gnd

N Line

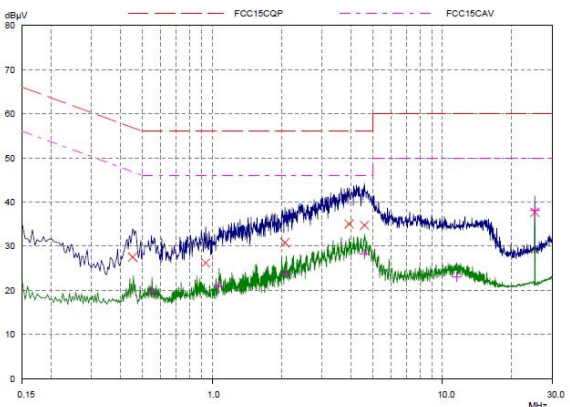

Final Measurement Results

Frequency MHz	QP Level dBµV	QP Limit dBµV	QP Delta dB	Phase	PE
0.45078	27.52	56.80	29.34	N	gnd
0.93906	26.17	56.00	29.83	N	gnd
2.07187	30.77	56.00	25.23	N	gnd
3.93125	35.02	56.00	20.98	N	gnd
4.59531	34.71	56.00	21.29	N	gnd
25.22812	37.69	60.00	22.31	N	gnd

Frequency MHz	AV Level dBµV	AV Limit dBµV	AV Delta dB	Phase	PE
0.54843	19.77	46.00	26.23	N	gnd
1.07187	20.95	46.00	25.05	N	gnd
2.09921	23.78	46.00	22.22	N	gnd
4.59531	28.18	46.00	17.82	N	gnd
11.53281	23.00	50.00	27.00	N	gnd
25.22812	38.18	50.00	11.82	N	gnd



BLE, Channel No.: 0

L Line

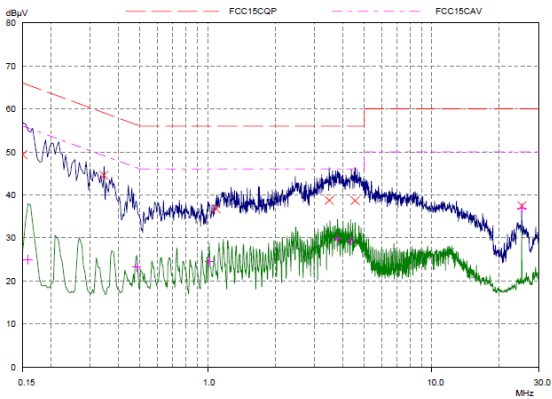

Final Measurement Results

Frequency MHz	QP Level dBµV	QP Limit dBµV	QP Delta dB	Phase	PE
0.15	49.34	66.00	16.66	L1	gnd
0.34531	44.53	59.07	14.54	L1	gnd
1.0914	38.74	56.00	19.26	L1	gnd
3.48984	38.71	56.00	17.29	L1	gnd
4.54843	38.85	56.00	17.35	L1	gnd
25.22812	37.46	60.00	22.54	L1	gnd

Frequency MHz	AV Level dBµV	AV Limit dBµV	AV Delta dB	Phase	PE
0.15781	24.91	55.58	30.67	L1	gnd
0.48203	23.19	46.30	23.11	L1	gnd
1.01718	24.54	46.00	21.46	L1	gnd
3.80625	29.80	46.00	16.20	L1	gnd
4.3375	29.39	46.00	16.61	L1	gnd
25.22812	36.93	50.00	13.07	L1	gnd

N Line

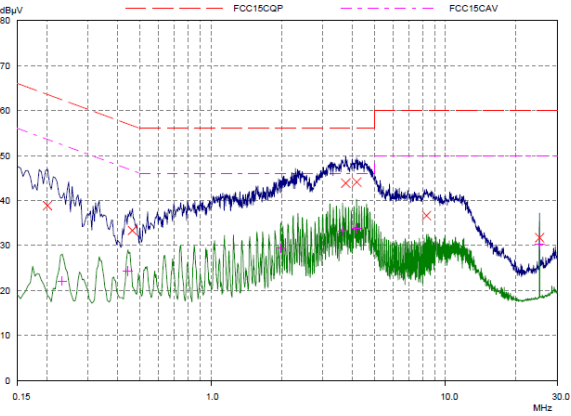

Final Measurement Results

Frequency MHz	QP Level dBµV	QP Limit dBµV	QP Delta dB	Phase	PE
0.20078	38.82	63.58	24.76	N	gnd
0.4625	33.31	56.65	23.34	N	gnd
3.76328	43.83	56.00	12.17	N	gnd
4.18515	44.08	56.00	11.92	N	gnd
8.30625	36.81	60.00	23.39	N	gnd
25.22812	31.72	60.00	28.28	N	gnd

Frequency MHz	AV Level dBµV	AV Limit dBµV	AV Delta dB	Phase	PE
0.23203	22.07	52.38	30.31	N	gnd
0.44296	24.26	47.01	22.75	N	gnd
1.98984	29.37	46.00	16.63	N	gnd
3.65	33.15	46.00	12.85	N	gnd
4.18125	33.72	46.00	12.28	N	gnd
25.22812	30.33	50.00	19.67	N	gnd

BLE, Channel No.: 19

L Line

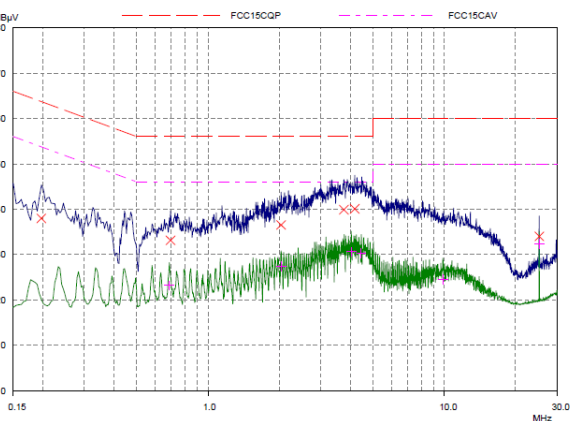

Final Measurement Results

Frequency MHz	QP Level dBµV	QP Limit dBµV	QP Delta dB	Phase	PE
0.19687	37.98	63.74	25.76	L1	gnd
0.69296	33.15	56.00	22.85	L1	gnd
2.0367	36.54	56.00	19.46	L1	gnd
3.76328	39.87	56.00	16.13	L1	gnd
4.17734	40.06	56.00	15.94	L1	gnd
25.22812	34.00	60.00	26.00	L1	gnd

Frequency MHz	AV Level dBµV	AV Limit dBµV	AV Delta dB	Phase	PE
0.68515	23.17	46.00	22.83	L1	gnd
2.0367	27.33	46.00	18.67	L1	gnd
4.03671	30.62	46.00	15.38	L1	gnd
4.45078	30.24	46.00	15.76	L1	gnd
9.87285	24.44	50.00	25.56	L1	gnd
25.22812	32.33	50.00	17.67	L1	gnd



N Line

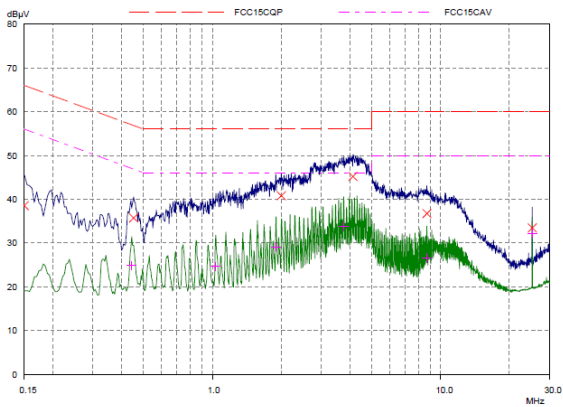

Final Measurement Results

Frequency MHz	QP Level dBμV	QP Limit dBμV	QP Delta dB	Phase	PE
-	-	-	-	-	-
0.15	38.52	66.00	27.48	N	gnd
0.45078	35.71	56.86	21.15	N	gnd
2.00166	40.77	56.00	15.23	N	gnd
4.13436	45.16	56.00	10.84	N	gnd
8.7164	38.70	60.00	23.30	N	gnd
25.22812	33.46	60.00	26.54	N	gnd

Frequency MHz	AV Level dBμV	AV Limit dBμV	AV Delta dB	Phase	PE
-	-	-	-	-	-
0.44266	24.80	47.01	22.21	N	gnd
1.03281	24.62	46.00	21.38	N	gnd
1.9	29.10	46.00	16.90	N	gnd
3.78328	33.82	46.00	12.18	N	gnd
8.7164	26.54	50.00	23.46	N	gnd
25.22812	32.18	50.00	17.82	N	gnd

BLE, Channel No.: 39

L Line

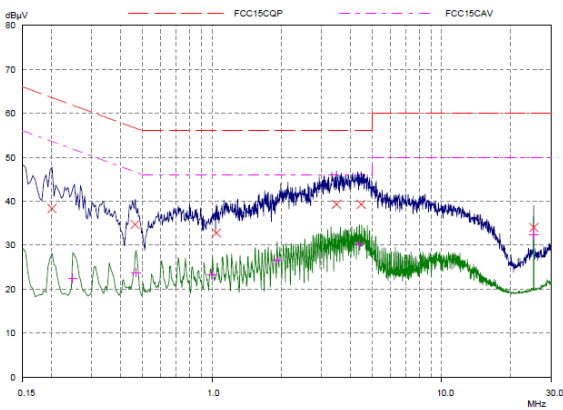

Final Measurement Results

Frequency MHz	QP Level dBμV	QP Limit dBμV	QP Delta dB	Phase	PE
-	-	-	-	-	-
0.20078	38.30	63.58	25.28	L1	gnd
0.4625	34.69	56.65	21.96	L1	gnd
1.04453	32.76	56.00	23.24	L1	gnd
3.48593	39.27	56.00	16.73	L1	gnd
4.45859	39.27	56.00	16.73	L1	gnd
25.22812	34.02	60.00	25.98	L1	gnd

Frequency MHz	AV Level dBμV	AV Limit dBμV	AV Delta dB	Phase	PE
-	-	-	-	-	-
0.24765	22.48	51.84	29.36	L1	gnd
0.4664	23.76	46.58	22.82	L1	gnd
1.00546	23.30	46.00	22.70	L1	gnd
1.92343	26.62	46.00	19.38	L1	gnd
4.38828	30.24	46.00	15.76	L1	gnd
25.22812	32.33	50.00	17.67	L1	gnd

N Line

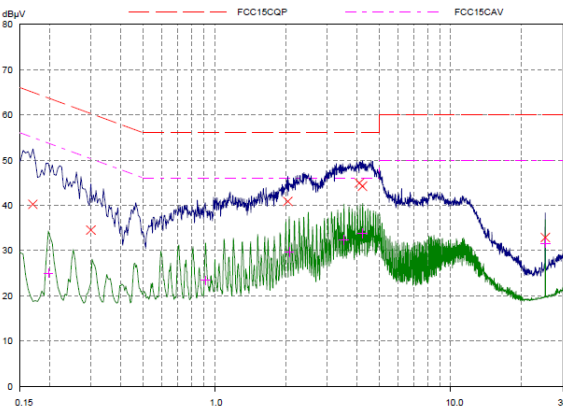

Final Measurement Results

Frequency MHz	QP Level dBμV	QP Limit dBμV	QP Delta dB	Phase	PE
-	-	-	-	-	-
0.16953	40.22	64.98	24.76	N	gnd
0.29843	34.52	60.29	25.77	N	gnd
2.04062	40.86	56.00	15.14	N	gnd
4.11062	44.94	56.00	11.06	N	gnd
4.23964	44.21	56.00	11.79	N	gnd
25.22812	32.88	60.00	27.12	N	gnd

Frequency MHz	AV Level dBμV	AV Limit dBμV	AV Delta dB	Phase	PE
-	-	-	-	-	-
0.16687	24.95	53.74	28.79	N	gnd
0.91562	23.40	46.00	22.60	N	gnd
2.07187	29.69	46.00	16.31	N	gnd
3.53671	32.36	46.00	13.64	N	gnd
4.24765	33.73	46.00	12.27	N	gnd
25.22812	31.57	50.00	18.43	N	gnd



6. Main Test Instruments

Name	Type/ Model	Manufacturer	Serial Number	Calibration Date	Expiration Time
Spectrum Analyzer	FSV30	R&S	100815	2015-12-17	2016-12-16
EMI Test Receiver	ESCI	R&S	100948	2016-06-01	2017-05-31
TRILOG Broadband Antenna	VULB 9163	Schwarzbeck	9163-201	2014-12-06	2017-12-05
Double Ridged Waveguide Horn Antenna	HF907	R&S	100126	2014-12-06	2017-12-05
Loop Antenna	FMZB1519	SCHWARZBE CK	1519-047	2014-02-19	2017-02-18
Standard Gain Horn	3160-09	ETS-Lindgren	00102644	2015-01-30	2018-01-29
EMI Test Receiver	ESCS30	R&S	100138	2015-12-17	2016-12-16
LISN	ENV216	R&S	101171	2013-12-18	2016-12-17
Spectrum Analyzer	N9010A	Agilent	MY47191109	2016-05-21	2017-05-20
MOB COMMS DC SUPPLY	66319D	Agilent	MY43004105	2016-05-21	2017-05-20
Peak Power Meter	U2021XA	Keysight	MY55240003	2016-06-26	2017-06-25
RF Cable	SMA 15cm	Agilent	0001	2016-08-05	2017-08-04

*****END OF REPORT *****