



TEST REPORT

FCC ID: 2AJMN-A667LP

Product: Mobile Phone

Model No.: A667LP

Additional Model No.: N/A

Trade Mark: itel

Report No.: WSCT-A2LA-R&E240200007A-RF

Issued Date: 12 March 2024

Issued for:

ITEL MOBILE LIMITED

FLAT N 16/F BLOCK B UNIVERSAL INDUSTRIAL CENTRE 19-25 SHAN MEI
STREET FOTAN NT HONGKONG

Issued By:

World Standardization Certification & Testing Group(Shenzhen) Co.,Ltd.

Building A-B, Baoshi Science & Technology Park, Baoshi Road,
Bao'an District, Shenzhen, Guangdong, China

TEL: +86-755-26996192

FAX: +86-755-86376605



Note: The results contained in this report pertain only to the tested sample. This report shall not be reproduced, except in full, without written approval of World Standardization Certification & Testing Group(Shenzhen) Co., Ltd. This report must not be used by the client to claim product certification, approval, or any agency of the U.S. Government.





TABLE OF CONTENTS

1. Test Certification	3
2. GENERAL DESCRIPTION OF EUT	4
3. FACILITIES AND ACCREDITATIONS.....	5
3.1. TEST FACILITY	5
3.2. ACCREDITATIONS	5
3.3. DESCRIPTION OF TEST CHANNELS AND TEST MODES	6
3.4. EQUIPMENT MODIFICATIONS	11
4. SUMMARY OF TEST REQUIREMENTS AND RESULTS	12
5. MEASUREMENT INSTRUMENTS.....	14
6. EFFECTIVE (ISOTROPIC) RADIATED POWER	15
7. SPURIOUS EMISSION (Conducted and Radiated)	26
7.1. MEASUREMENT RESULT (PRE-MEASUREMENT).....	26
8. OCCUPIED BANDWIDTH& Emission Bandwidth	58
9. BAND EDGE.....	78
10. FREQUENCY STABILITY.....	85
10.1. MEASUREMENT RESULT (WORST).....	86





1. Test Certification

Product: Mobile Phone
Model No.: A667LP
Trade Mark: itel
Applicant: ITEL MOBILE LIMITED
Address: FLAT N 16/F BLOCK B UNIVERSAL INDUSTRIAL CENTRE 19-25
 SHAN MEI STREET FOTAN NT HONGKONG
Manufacturer: ITEL MOBILE LIMITED
Address: FLAT N 16/F BLOCK B UNIVERSAL INDUSTRIAL CENTRE 19-25
 SHAN MEI STREET FOTAN NT HONGKONG
Date of Test: 06 February 2024 ~ 11 March 2024
Applicable Standards: FCC Rules Part 2 and 22H and 24E and 27 and 90

The above equipment has been tested by World Standardization Certification & Testing Group(Shenzhen) Co., Ltd. and found compliance with the requirements set forth in the technical standards mentioned above. The results of testing in this report apply only to the product/system, which was tested. Other similar equipment will not necessarily produce the same results due to production tolerance and measurement uncertainties.

Tested By: Wang Xiang
(Wang Xiang)

Checked By: Mo Peiyun
(Mo Peiyun)

Approved By: Liu Fuxin
(Liu Fuxin)

Date: 12 March 2024





2. GENERAL DESCRIPTION OF EUT

Equipment Type:	Mobile Phone
Test Model:	A667LP
Trade Mark:	itel
Frequency Bands:	<input checked="" type="checkbox"/> GSM 850 <input checked="" type="checkbox"/> PCS 1900 (U.S. Bands) UTRA Bands: <input checked="" type="checkbox"/> UTRA Band 2 <input checked="" type="checkbox"/> UTRA Band 4 <input checked="" type="checkbox"/> UTRA Band 5 E-UTRA Bands: <input checked="" type="checkbox"/> E-UTRA Band 2 <input checked="" type="checkbox"/> E-UTRA Band 4 <input checked="" type="checkbox"/> E-UTRA Band 5 <input checked="" type="checkbox"/> E-UTRA Band 7 <input checked="" type="checkbox"/> E-UTRA Band 12 <input checked="" type="checkbox"/> E-UTRA Band 17 <input checked="" type="checkbox"/> E-UTRA Band 26 <input checked="" type="checkbox"/> E-UTRA Band 38 <input checked="" type="checkbox"/> E-UTRA Band 41 <input checked="" type="checkbox"/> E-UTRA Band 66
Frequency Range	GSM 850: 824-849MHz(TX), 869-894MHz(RX); PCS 1900: 1850-1910MHz(TX), 1930-1990MHz(RX); WCDMA Band 2: 1850-1930MHz(TX), 1930-1990MHz(RX); WCDMA Band 4: 1710-1755MHz(TX), 2110-2155MHz(RX); WCDMA Band 5: 824-849MHz(TX), 869-894MHz(RX); LTE Band 2: 1850-1910MHz(TX), 1930~1990MHz(RX) LTE Band 4: 1710-1755MHz(TX), 2110~2155MHz(RX); LTE Band 5: 824-849MHz(TX), 869~894MHz(RX); LTE Band 7: 2500-2570 MHz(TX), 2620-2690MHz(RX); LTE Band 12: 699-716MHz(TX), 729~749MHz(RX); LTE Band 17: 704-716MHz(TX), 734~746MHz(RX); LTE Band 26: 814MHz-849MHz(TX), 859MHz-894MHz(RX); LTE Band 38: 2570-2620MHz(TX), 2570-2620MHz(RX); LTE Band 41: 2535-2655MHz(TX/RX); LTE Band 66: 1710-1780MHz(TX), 2110~2200MHz(RX);
Antenna Type:	PIFA Antenna
Antenna gain:	PCS 1900: 1.54dBi GSM850: -2.45dBi UTRA Band 2: 1.54dBi UTRA Band 4: 1.62dBi UTRA Band 5: -2.45dBi E-UTRA Band 2: 1.54dBi E-UTRA Band 4: 1.62dBi E-UTRA Band 5: -2.45dBi E-UTRA Band 7: 1.32dBi E-UTRA Band 12: -2.58dBi E-UTRA Band 17: -2.58dBi E-UTRA Band 26: -2.45dBi E-UTRA Band 38: 0.52dBi E-UTRA Band 41: 0.32dBi E-UTRA Band 66: 1.62dBi
Battery information:	Li-ion Battery: BL-49NI Rated Voltage: 3.85V



	Rated Capacity: 4900mAh/18.86Wh Limited Capacity: 5000mAh/19.25Wh Limited Charge Voltage: 4.4V
Adapter Information:	Adapter: U100ISB Input: 100-240V~50/60Hz 0.3A Output: 5.0V--2.0A
Card(S):	Card 1: E-UTRA Card Slot Card 2: GSM Card Slot
Max power:	See Table 2.1.2
Extreme Vol. Limits:	DC 3.00V to 4.4V (Normal: DC 3.85V)

3. FACILITIES AND ACCREDITATIONS

3.1. Test Facility

All measurement facilities used to collect the measurement data are located at Building A-B, Baoshi Science & Technology Park, Baoshi Road, Bao'an District, Shenzhen, Guangdong, China of the WORLD STANDARDIZATION CERTIFICATION & TESTING GROUP (SHENZHEN) CO., LTD.

The sites are constructed in conformance with the requirements of ANSI C63.4 and CISPR Publication 32. All receiving equipment conforms to CISPR Publication 16-1, "Radio Interference Measuring Apparatus and Measurement Methods."

3.2. ACCREDITATIONS

China National Accreditation Service for Conformity Assessment (CNAS)

Registration number NO: L3732

American Association for Laboratory Accreditation(A2LA)

Registration NO : 5768.01

Copies of granted accreditation certificates are available for downloading from our web site, <http://www.wsct-cert.com>





3.3. Description Of Test Channels And Test Modes

Test channels:

GSM 850			
Test Channel	BW(MHz)	UL Channel	Frequency(MHz)
Low Range	0.2	128	824.2
Mid Range	0.2	190	836.6
High Range	0.2	251	848.8

PCS 1900			
Test Channel	BW(MHz)	UL Channel	Frequency(MHz)
Low Range	0.2	512	1850.2
Mid Range	0.2	661	1880
High Range	0.2	810	1909.8

URTA BAND 2			
Test Channel	BW(MHz)	UL Channel	Frequency(MHz)
Low Range	5	9262	1852.4
Mid Range	5	9400	1880
High Range	5	9538	1907.6

URTA BAND 4			
Test Channel	BW(MHz)	UL Channel	Frequency(MHz)
Low Range	5	1312	1712.4
Mid Range	5	1413	1732.6
High Range	5	1513	1752.6

URTA BAND 5			
Test Channel	BW(MHz)	UL Channel	Frequency(MHz)
Low Range	5	4132	826.4
Mid Range	5	4182	836.4
High Range	5	4233	846.6





LTE BAND 2			
Test Channel	BW(MHz)	UL Channel	Frequency(MHz)
Low Range	1.4	18607	1850.7
	3	18615	1851.5
	5	18625	1852.5
	10	18650	1855
	15	18675	1857.5
	20	18700	1860
Mid Range	1.4/3/5/10 15 /20	18900	1880
High Range	1.4	19193	1909.3
	3	19185	1908.5
	5	19175	1907.5
	10	19150	1905
	15	19125	1902.5
	20	19100	1900

LTE BAND 4			
Test Channel	BW(MHz)	UL Channel	Frequency(MHz)
Low Range	1.4	19957	1710.7
	3	19965	1711.5
	5	19975	1712.5
	10	20000	1715
	15	20025	1717.5
	20	20050	1720
Mid Range	1.4/3/5/10/15/20	20175	1732.5
High Range	1.4	20393	1754.3
	3	20385	1753.5
	5	20375	1752.5
	10	20350	1750
	15	20325	1747.5
	20	20300	1745





LTE BAND 5			
Test Channel	BW(MHz)	UL Channel	Frequency(MHz)
Low Range	1.4	20470	824.7
	3	20415	825.5
	5	20425	826.5
	10	20450	829
Mid Range	1.4/3/5/10	20525	836.5
High Range	1.4	20643	848.3
	3	20635	847.5
	5	20625	846.5
	10	20600	844

LTE BAND 7			
Test Channel	BW(MHz)	UL Channel	Frequency(MHz)
Low Range	5	20775	2502.5
	10	20800	2505
	15	20825	2507.5
	20	20850	2510
Mid Range	5/10/15/20	21100	2535
High Range	5	21425	2567.5
	10	21400	2565
	15	21375	2562.5
	20	21350	2560

LTE BAND 12			
Test Channel	BW(MHz)	UL Channel	Frequency(MHz)
Low Range	1.4	23017	699.7
	3	23025	700.5
	5	23035	701.5
	10	23060	704
Mid Range	1.4/3/5/10	23095	707.5
High Range	1.4	23173	715.3
	3	23165	714.5
	5	23155	713.5
	10	23130	711





LTE BAND 17			
Test Channel	BW(MHz)	UL Channel	Frequency(MHz)
Low Range	5	23755	706.5
	10	23780	709
Mid Range	5/10	23790	710
High Range	5	23825	713.5
	10	23800	711

LTE BAND 26			
Test Channel	BW(MHz)	UL Channel	Frequency(MHz)
Low Range	1.4	26697	814.7
	3	26705	815.5
	5	26715	816.5
	10	26740	819
	15	26765	821.5
Mid Range	1.4/3/5/10/15	26865	831.5
High Range	1.4	27033	848.3
	3	27025	847.5
	5	27015	846.5
	10	26990	844
	15	26965	841.5

LTE BAND 38			
Test Channel	BW(MHz)	UL Channel	Frequency(MHz)
Low Range	5	37775	2572.5
	10	37800	2575
	15	37825	2577.5
	20	37850	2580
Mid Range	5/10/15/20	38000	2595
High Range	5	38225	2517.5
	10	38200	2515
	15	38175	2512.5
	20	38150	2610





LTE BAND 41			
Test Channel	BW(MHz)	UL Channel	Frequency(MHz)
Low Range	5	40265	2557.5
	10	40290	2560.0
	15	40315	2562.5
	20	40340	2565.0
Mid Range	5/10/15/20	40740	2605.0
High Range	5	41215	2652.5
	10	41190	2650.0
	15	41165	2647.5
	20	41140	2645.0

LTE BAND 66			
Test Channel	BW(MHz)	UL Channel	Frequency(MHz)
Low Range	1.4	131979	1710.7
	3	131987	1711.5
	5	131997	1712.5
	10	132022	1715
	15	132047	1717.5
	20	132072	1720
Mid Range	1.4/3/5/10/15/20	132422	1755
High Range	1.4	132665	1779.3
	3	132657	1778.5
	5	132647	1777.5
	10	132622	1775
	15	132597	1772.5
	20	132572	1770

Note 1: both QPSK&16QAM modulation has been measured;

Note 2: The worst condition was recorded in the test report if no other modes test data.





Report No.: WSCT-A2LA-R&E24020007A-RF

Certificate #5768.01

For Question,
Please Contact with WSCT
www.wsct-cert.com

3.4. Equipment Modifications

Not available for this EUT intended for grant.





4. SUMMARY OF TEST REQUIREMENTS AND RESULTS

BAND 2(PCS 1900/ UTRA Band 2):

Test Item	FCC Rule No.	Requirements	Judgement
Effective (Isotropic) Radiated Power	§2.1046, §24.232(c)	EIRP ≤ 2W(33dBm)	Pass
Bandwidth	§2.1049 §24.238(a)	OBW: No limit. EBW: No limit.	Pass
Band Edges	§2.1051, §24.238(a)	-13dBm	Pass
Spurious Emission at Antenna Terminals	§2.1051, §24.238(a)	-13dBm	Pass
Field Strength of Spurious Radiation	§2.1053, §24.238(a)	-13dBm	Pass
Frequency Stability	§2.1055, §24.235	the fundamental emission stays within the authorized frequency block.	Pass
Peak to average ratio	§24.232(d)	<13dB	Pass

BAND 4(UTRA Band 4):

Test Item	FCC Rule No.	Requirements	Judgement
Effective (Isotropic) Radiated Power	§2.1046, §27.50(d)	EIRP ≤ 1W(30dBm)	Pass
Bandwidth	§2.1049	OBW: No limit. EBW: No limit.	Pass
Band Edges	§2.1051, §27.53(h)	-13dBm	Pass
Spurious Emission at Antenna Terminals	§2.1051, §27.53(h)	-13dBm	Pass
Field Strength of Spurious Radiation	§2.1053, §27.53(h)	-13dBm	Pass
Frequency Stability	§2.1055, §27.54	the fundamental emissions stay within the authorized bands of operation. (2.5ppm)	Pass
Peak to average ratio	§27.50(d)	<13dB	Pass

BAND 5(GSM850/ UTRA Band 5):

Test Item	FCC Rule No.	Requirements	Judgement
Effective (Isotropic) Radiated Power	§2.1046, §2.913(a)	EIRP ≤ 7W(38.5dBm)	Pass
Occupied Bandwidth	§2.1049	OBW: No limit.	Pass
Emission Bandwidth	22.917(b)	EBW: No limit.	Pass
Band Edges Compliance	§2.1051, §22.917(a)(b)	KDB 971 168 D02 971168 D02 Misc OOB License Digital Systems v01 &27.53(m) for detail the limit is upon different OBW	Pass
Spurious Emission at Antenna Terminals	§2.1051, §22.917	-13dBm	Pass
Field Strength of Spurious Radiation	§2.1053, §22.917	-13dBm	Pass
Frequency Stability	§2.1055, §22.355	the fundamental emissions stay within the authorized bands of operation. (2.5ppm)	Pass

E-UTRA Band 2/4/5/7/12/17/26/38/66:

Test Item	FCC Rule No.	Requirements	Judgement
Effective (Isotropic) Radiated Power	§2.1046, §27.50(h)	EIRP ≤ 2W(33dBm)	Pass
Bandwidth	§2.1049	OBW: No limit. EBW: No limit.	Pass
Band Edges	§2.1051, §27.53(m)	KDB 971 168 D02 971168 D02 Misc OOB License Digital Systems v01 &27.53(m) for detail the limit is upon different OBW	Pass
Spurious Emission at Antenna Terminals	§2.1051, §27.53(m)	-25dBm	Pass
Field Strength of Spurious Radiation	§2.1053, §27.53(m)	-25dBm	Pass
Frequency Stability	§2.1055, §27.54	the fundamental emissions stay within the authorized bands of operation. (2.5ppm)	Pass



5. MEASUREMENT INSTRUMENTS

NAME OF EQUIPMENT	MANUFACTURER	MODEL	SERIAL NUMBER	Calibration Date	Calibration Due.
Test software	--	MT8200	2.0.0.0	--	--
EMI Test Receiver	R&S	ESCI	100005	2023-11-05	2024-11-04
LISN	AFJ	LS16	16010222119	2023-11-05	2024-11-04
LISN(EUT)	Mestec	AN3016	04/10040	2023-11-05	2024-11-04
Universal Radio Communication Tester	R&S	CMU 200	1100.0008.02	2023-11-05	2024-11-04
Coaxial cable	Megalon	LMR400	N/A	2023-11-05	2024-11-04
GPIB cable	Megalon	GPIB	N/A	2023-11-05	2024-11-04
Spectrum Analyzer	R&S	FSU	100114	2023-11-05	2024-11-04
Pre Amplifier	H.P.	HP8447E	2945A02715	2023-11-05	2024-11-04
Pre-Amplifier	CDSI	PAP-1G18-38	--	2023-11-05	2024-11-04
Loop Antenna	R&S	HFH2-Z2	100296	2023-11-05	2024-11-04
Bi-log Antenna	SCHWARZBECK	VULB9168	01488	2023-07-29	2024-07-28
9*6*6 Anechoic	--	--	--	2023-11-05	2024-11-04
Horn Antenna	COMPLIANCE ENGINEERING	CE18000	--	2023-11-05	2024-11-04
Horn Antenna	SCHWARZBECK	BBHA9120D	9120D-631	2023-11-05	2024-11-04
Power meter	Anritsu	ML2487A	6K00003613	2023-11-05	2024-11-04
Power meter	Anritsu	MA2491A	32263	2023-11-05	2024-11-04
Cable	TIME MICROWAVE	LMR-400	N-TYPE04	2023-11-05	2024-11-04
System-Controller	CCS	N/A	N/A	N.C.R	N.C.R
Turn Table	CCS	N/A	N/A	N.C.R	N.C.R
Antenna Tower	CCS	N/A	N/A	N.C.R	N.C.R
RF cable	Murata	MXHQ87WA3000	-	2023-11-05	2024-11-04
Loop Antenna	EMCO	6502	00042960	2023-11-05	2024-11-04
Wideband Radio Communication Tester	R&S	CMW 500	103974	2023-11-05	2024-11-04
Horn Antenna	SCHWARZBECK	BBHA 9170	1123	2023-11-05	2024-11-04
H & T Chamber	Guangzhou gongwen	GDJS-500-40	0329	2023-11-05	2024-11-04



6. EFFECTIVE (ISOTROPIC) RADIATED POWER

Test limit:

According to §22.913, The ERP of mobile transmitters and auxiliary test transmitters must not exceed 7 Watts.

According to §24.232, Mobile and portable stations are limited to 2 watts EIRP and the equipment must employ a means for limiting power to the minimum necessary for successful communications.

According to §27.50 (d), Fixed, mobile, and portable (hand-held) stations operating in the 1710-1755 MHz band and mobile and portable stations operating in the 1695-1710 MHz and 1755-1780 MHz bands are limited to 1 watt EIRP. Fixed stations operating in the 1710-1755 MHz band are limited to a maximum antenna height of 10 meters above ground. Mobile and portable stations operating in these bands must employ a means for limiting power to the minimum necessary for successful communications. According to §27.50 (h), Mobile and other user stations. Mobile stations are limited to 2.0 watts EIRP. All user stations are limited to 2.0 watts transmitter output power.

See section 4.

Test procedure:

1. The setup of EUT is according with per TIA/EIA Standard 603 D:2010 or KDB971168 D01 v02r02.

2. The measurement antenna was placed at a distance of 3 meters from the EUT. During the tests, the antenna height and polarization as well as EUT azimuth were varied in order to identify the maximum level of emissions from the EUT. The test was performed by placing the EUT on 3-orthogonal axis.

3. The frequency range up to tenth harmonic of the fundamental frequency was investigated.

4. Remove the EUT and replace it with substitution antenna. A signal generator was connected to the substitution antenna by a non-radiating cable. The absolute levels of the spurious emissions were measured by the substitution.

5. $ERP/EIRP = P_{Meas} + GT - LC$

where:

ERP/EIRP = effective or equivalent radiated power

P_{Meas} = measured transmitter output power from SG

GT = gain of the substitution antenna

LC = cable loss between SG and substitution antenna.

GSM850 BAND:

Mode	Frequency (MHz)	Peak Power(dBm)	Avg.Burst Power(dBm)	PAP	Duty cycle Factor(dB)	Frame Power(dBm)	
GSM850	824.2	33.34	32.94	0.40	-9.03	23.91	
	836.6	33.27	32.55	0.72	-9.03	23.52	
	848.8	32.60	32.05	0.55	-9.03	23.02	
GPRS850	1 Tx Slots	824.2	30.35	29.89	0.46	-9.03	20.86
		836.6	30.15	29.59	0.56	-9.03	20.56
		848.8	29.58	29.11	0.47	-9.03	20.08
	2 Tx Slots	824.2	30.02	29.34	0.68	-6.02	23.32
		836.6	30.55	29.93	0.62	-6.02	23.91
		848.8	29.75	29.02	0.73	-6.02	23.00
	3 Tx Slots	824.2	30.25	29.35	0.90	-4.26	25.09
		836.6	30.49	29.63	0.86	-4.26	25.37
		848.8	31.07	30.48	0.59	-4.26	26.22
	4 Tx Slots	824.2	31.11	30.37	0.74	-3.01	27.36
		836.6	30.01	29.52	0.50	-3.01	26.51
		848.8	29.61	29.15	0.46	-3.01	26.14
EPRS850	1 Tx Slots	824.2	28.83	28.24	0.58	-9.03	19.21
		836.6	27.59	27.03	0.56	-9.03	18.00
		848.8	27.50	26.83	0.67	-9.03	17.80
	2 Tx Slots	824.2	28.50	27.73	0.78	-6.02	21.71
		836.6	28.67	28.05	0.62	-6.02	22.03
		848.8	27.95	27.36	0.59	-6.02	21.34
	3 Tx Slots	824.2	27.52	26.75	0.77	-4.26	22.49
		836.6	28.00	27.48	0.52	-4.26	23.22
		848.8	28.61	28.19	0.42	-4.26	23.93
	4 Tx Slots	824.2	27.78	27.00	0.78	-3.01	23.99
		836.6	28.56	27.73	0.83	-3.01	24.72
		848.8	27.49	27.04	0.45	-3.01	24.03

Duty cycle Factor = 1 Tx Slots, $10 \cdot \log(1/8) = -9.03\text{dB}$, 2 Tx Slots, $10 \cdot \log(2/8) = -6.02\text{dB}$,
 3Tx Slots, $10 \cdot \log(3/8) = -4.26\text{dB}$, 4 Tx Slots, $10 \cdot \log(4/8) = -3.01\text{dB}$



PCS1900 BAND:

Mode	Frequency (MHz)	Peak Power(dBm)	Avg.Burst Power(dBm)	PAP	Duty cycle Factor(dB)	Frame Power(dBm)	
GSM1900	1850.2	31.49	30.61	0.88	-9.03	21.58	
	1880	29.72	28.97	0.74	-9.03	19.94	
	1909.8	30.89	30.13	0.76	-9.03	21.10	
GPRS1900	1 Tx Slots	1850.2	28.10	27.35	0.75	-9.03	18.32
		1880	27.60	26.74	0.86	-9.03	17.71
		1909.8	28.40	27.75	0.66	-9.03	18.72
	2 Tx Slots	1850.2	28.93	28.48	0.44	-6.02	22.46
		1880	28.13	27.26	0.86	-6.02	21.24
		1909.8	28.52	27.87	0.66	-6.02	21.85
	3 Tx Slots	1850.2	28.59	27.95	0.64	-4.26	23.69
		1880	27.81	27.31	0.50	-4.26	23.05
		1909.8	27.54	26.85	0.69	-4.26	22.59
	4 Tx Slots	1850.2	28.38	27.94	0.44	-3.01	24.93
		1880	27.74	26.87	0.87	-3.01	23.86
		1909.8	28.79	28.12	0.67	-3.01	25.11
EGPRS1900	1 Tx Slots	1850.2	25.61	25.13	0.48	-9.03	16.10
		1880	25.75	24.96	0.79	-9.03	15.93
		1909.8	26.48	25.84	0.64	-9.03	16.81
	2 Tx Slots	1850.2	26.23	25.70	0.53	-6.02	19.68
		1880	26.29	25.73	0.56	-6.02	19.71
		1909.8	26.41	25.96	0.45	-6.02	19.94
	3 Tx Slots	1850.2	26.03	25.54	0.49	-4.26	21.28
		1880	26.99	26.33	0.65	-4.26	22.07
		1909.8	25.77	25.01	0.76	-4.26	20.75
	4 Tx Slots	1850.2	26.44	25.57	0.87	-3.01	22.56
		1880	25.90	25.28	0.62	-3.01	22.27
		1909.8	26.62	26.00	0.62	-3.01	22.99

Duty cycle Factor = 1 Tx Slots, $10 \cdot \log(1/8) = -9.03\text{dB}$, 2 Tx Slots, $10 \cdot \log(2/8) = -6.02\text{dB}$,
3Tx Slots, $10 \cdot \log(3/8) = -4.26\text{dB}$, 4 Tx Slots, $10 \cdot \log(4/8) = -3.01\text{dB}$





**ULTRA BANDS:
BAND 2:**

Mode	Frequency (MHz)	Peak Power(dBm)	Avg.Burst Power(dBm)	PAPR (dB)	
RMC 12.2K	1852.4	22.76	21.59	1.17	
	1880	23.48	22.14	1.34	
	1907.6	22.82	22.15	0.67	
HSDPA	1 Tx Slots	1852.4	23.14	21.92	1.22
		1880	22.36	22.34	0.02
		1907.6	21.98	21.69	0.29
	2 Tx Slots	1852.4	22.35	22.00	0.35
		1880	22.32	22.17	0.15
		1907.6	23.46	22.05	1.41
	3 Tx Slots	1852.4	23.45	22.26	1.19
		1880	22.78	22.01	0.77
		1907.6	23.22	22.38	0.84
	4 Tx Slots	1852.4	23.58	22.12	1.46
		1880	23.08	21.74	1.34
		1907.6	22.86	22.38	0.48
HSUPA	1 Tx Slots	1852.4	22.73	21.85	0.88
		1880	23.04	22.44	0.60
		1907.6	22.27	21.89	0.38
	2 Tx Slots	1852.4	22.97	22.24	0.73
		1880	22.26	21.97	0.29
		1907.6	23.20	21.80	1.40
	3 Tx Slots	1852.4	23.06	21.70	1.36
		1880	22.98	22.04	0.94
		1907.6	22.00	21.95	0.05
	4 Tx Slots	1852.4	23.20	21.61	1.59
		1880	21.66	21.67	-0.01
		1907.6	23.26	21.86	1.40
	5 Tx Slots	1852.4	22.85	22.04	0.81
		1880	22.25	21.96	0.29
		1907.6	22.67	22.23	0.44





BAND 4:

Mode		Frequency (MHz)	Peak Power(dBm)	Avg.Burst Power(dBm)	PAPR (dB)
RMC 12.2K		1712.4	23.04	22.14	0.90
		1732.6	22.38	22.14	0.24
		1752.6	23.37	22.27	1.10
HSDPA	1 Tx Slots	1712.4	21.85	21.72	0.13
		1732.6	22.70	22.33	0.37
		1752.6	23.47	21.59	1.88
	2 Tx Slots	1712.4	22.90	22.08	0.82
		1732.6	22.74	21.68	1.06
		1752.6	22.59	22.24	0.35
	3 Tx Slots	1712.4	21.84	21.80	0.04
		1732.6	22.58	22.37	0.21
		1752.6	22.90	22.44	0.46
	4 Tx Slots	1712.4	23.09	21.70	1.39
		1732.6	22.00	21.92	0.08
		1752.6	21.89	22.27	-0.38
HSUPA	1 Tx Slots	1712.4	22.29	22.46	-0.17
		1732.6	22.00	22.35	-0.35
		1752.6	22.82	22.29	0.53
	2 Tx Slots	1712.4	22.39	22.07	0.32
		1732.6	22.86	21.89	0.97
		1752.6	22.52	22.05	0.47
	3 Tx Slots	1712.4	23.37	21.94	1.43
		1732.6	22.82	21.76	1.06
		1752.6	21.98	22.14	-0.16
	4 Tx Slots	1712.4	22.63	21.60	1.03
		1732.6	21.93	21.60	0.33
		1752.6	22.60	22.17	0.43
	5 Tx Slots	1712.4	22.84	22.36	0.48
		1732.6	23.52	21.78	1.74
		1752.6	23.40	22.10	1.30



BAND 5:

Mode		Frequency (MHz)	Peak Power(dBm)	Avg.Burst Power(dBm)	PAPR (dB)
RMC 12.2K		826.4	23.15	21.76	1.39
		836.4	23.27	22.37	0.90
		846.6	23.29	21.58	1.71
HSDPA	1 Tx Slots	826.4	21.66	22.49	-0.83
		836.4	21.88	21.56	0.32
		846.6	21.71	22.34	-0.63
	2 Tx Slots	826.4	22.56	21.80	0.76
		836.4	21.75	22.50	-0.75
		846.6	22.33	21.92	0.41
	3 Tx Slots	826.4	22.74	21.91	0.83
		836.4	23.02	21.74	1.28
		846.6	23.51	21.86	1.65
	4 Tx Slots	826.4	23.21	21.95	1.26
		836.4	23.42	22.47	0.95
		846.6	22.13	22.08	0.05
HSUPA	1 Tx Slots	826.4	23.55	22.00	1.55
		836.4	22.19	22.17	0.02
		846.6	22.39	21.90	0.49
	2 Tx Slots	826.4	21.67	21.94	-0.27
		836.4	22.77	21.74	1.03
		846.6	23.28	22.26	1.02
	3 Tx Slots	826.4	23.05	21.71	1.34
		836.4	22.78	21.91	0.87
		846.6	21.81	21.97	-0.16
	4 Tx Slots	826.4	22.22	22.06	0.16
		836.4	23.19	21.62	1.57
		846.6	23.33	21.87	1.46
	5 Tx Slots	826.4	23.12	21.94	1.18
		836.4	23.36	22.02	1.34
		846.6	21.66	22.40	-0.74



Radiation power test

Note: Record the condition when max power has been detector for radiated method.(X axis)

Radiated Power (ERP) for GSM 850 MHZ

Mode	Frequency (MHz)	P _{Mea} (dBm)	Amplifier Gain (dBi)	Path Loss	Antenna Gain	Correcti on (dB)	ERP (Peak) (dBm)	Polarization
GSM850	824.2	7.34	31.23	1.02	-2.54	2.15	32.86	H
	836.6	6.80	31.23	1.02	-2.54	2.15	32.32	H
	848.8	6.85	31.23	1.02	-2.54	2.15	32.37	H

Radiated Power (ERP) for EGPRS850 MHZ

Mode	Frequency (MHz)	P _{Mea} (dBm)	Amplifier Gain (dBi)	Path Loss	Antenna Gain	Correcti on (dB)	ERP (Peak) (dBm)	Polarization
EGPRS 850	824.2	0.29	31.23	1.02	-2.54	2.15	25.81	H
	836.6	-0.24	31.23	1.02	-2.54	2.15	25.28	H
	848.8	0.50	31.23	1.02	-2.54	2.15	26.02	H

Radiated Power (EIRP) for PCS 1900 MHZ

Mode	Frequency (MHz)	P _{Mea} (dBm)	Amplifier Gain (dBi)	Path Loss (dB)	Antenna Gain (dB)	Correcti on (dB)	EIRP (Peak) (dBm)	Polarization
GSM 1900	1850.2	-2.97	31.23	1.02	1.54	0	28.78	H
	1880.0	-3.01	31.23	1.02	1.54	0	28.74	H
	1909.8	-2.73	31.23	1.02	1.54	0	29.02	H

Radiated Power (EIRP) for EGPRS 1900 MHZ

Mode	Frequency (MHz)	P _{Mea} (dBm)	Amplifier Gain (dBi)	Path Loss (dB)	Antenna Gain (dB)	Correcti on (dB)	EIRP (Peak) (dBm)	Polarization
EGPRS 1900	1850.2	-7.32	31.23	1.02	1.54	0	24.43	H
	1880.0	-7.30	31.23	1.02	1.54	0	24.45	H
	1909.8	-7.03	31.23	1.02	1.54	0	24.72	H

Radiated Power (EIRP) for UTRA Band 2

Mode	Frequency (MHz)	P _{Mea} (dBm)	Amplifier Gain (dBi)	Path Loss (dB)	Antenna Gain (dB)	Correcti on (dB)	EIRP (Peak) (dBm)	Polarization
UTRA Band 2	1852.4	-8.72	31.23	1.02	1.54	0	23.03	H
	1880	-8.86	31.23	1.02	1.54	0	22.89	H
	1907.6	-8.73	31.23	1.02	1.54	0	23.02	H

Radiated Power (EIRP) for UTRA Band 4

Mode	Frequency (MHz)	P _{Mea} (dBm)	Amplifier Gain (dBi)	Path Loss (dB)	Antenna Gain (dB)	Correcti on (dB)	EIRP (Peak) (dBm)	Polarization
UTRA Band 4	1712.4	-2.63	31.23	1.02	-2.45	2.15	22.98	H
	1732.6	-2.89	31.23	1.02	-2.45	2.15	22.72	H
	1752.6	-2.94	31.23	1.02	-2.45	2.15	22.67	H



Radiated Power (ERP) for UTRA Band 5

Mode	Frequency (MHz)	P _{Mea} (dBm)	Amplifier Gain (dBi)	Path Loss	Antenna Gain	Correcti on (dB)	ERP (Peak) (dBm)	Polarization
UTRA Band 5	826.4	-3.02	31.23	1.02	-2.45	2.15	22.59	H
	836.4	-3.29	31.23	1.02	-2.45	2.15	22.32	H
	846.6	-3.08	31.23	1.02	-2.45	2.15	22.53	H

ERP or EIRP = P_{Mea} + Amplifier Gain – Path Loss + Antenna Gain – Correction Factor

Note: Each channel is scanned 10 times, and the peak value of each channel is recorded.





LTE power is filtered as the worst mode data
Radiated Power (EIRP) for E-UTRA Band 2

Mode	Band width (MHz)	Modulation	Frequency (MHz)	P _{Mea} (dBm)	Amplifier Gain (dBi)	Path Loss (dB)	Antenna Gain (dB)	Correction (dB)	EIRP (Peak) (dBm)	Polarization
E-UTRA Band 2	1.4	QPSK	1880	-9.48	31.23	1.02	1.54	0	22.27	H
		Q16	1880	-8.71	31.23	1.02	1.54	0	23.04	H
	3	QPSK	1880	-10.21	31.23	1.02	1.54	0	21.54	H
		Q16	1880	-10.02	31.23	1.02	1.54	0	21.73	H
	5	QPSK	1880	-9.74	31.23	1.02	1.54	0	22.01	H
		Q16	1880	-9.05	31.23	1.02	1.54	0	22.70	H
	10	QPSK	1880	-9.89	31.23	1.02	1.54	0	21.86	H
		Q16	1880	-8.52	31.23	1.02	1.54	0	23.23	H
	15	QPSK	1880	-9.48	31.23	1.02	1.54	0	22.27	H
		Q16	1880	-8.71	31.23	1.02	1.54	0	23.04	H
	20	QPSK	1880	-10.21	31.23	1.02	1.54	0	21.54	H
		Q16	1880	-10.02	31.23	1.02	1.54	0	21.73	H

Radiated Power (EIRP) for E-UTRA Band 4

Mode	Band width (MHz)	Modulation	Frequency (MHz)	P _{Mea} (dBm)	Amplifier Gain (dBi)	Path Loss (dB)	Antenna Gain (dB)	Correction (dB)	EIRP (Peak) (dBm)	Polarization
E-UTRA Band 4	1.4	QPSK	1732.5	-9.13	31.23	1.02	1.62	0	22.70	H
		Q16	1732.5	-9.26	31.23	1.02	1.62	0	22.57	H
	3	QPSK	1732.5	-9.94	31.23	1.02	1.62	0	21.89	H
		Q16	1732.5	-10.18	31.23	1.02	1.62	0	21.65	H
	5	QPSK	1732.5	-9.17	31.23	1.02	1.62	0	22.66	H
		Q16	1732.5	-10.07	31.23	1.02	1.62	0	21.76	H
	10	QPSK	1732.5	-9.96	31.23	1.02	1.62	0	21.87	H
		Q16	1732.5	-9.02	31.23	1.02	1.62	0	22.81	H
	15	QPSK	1732.5	-9.13	31.23	1.02	1.62	0	22.70	H
		Q16	1732.5	-9.26	31.23	1.02	1.62	0	22.57	H
	20	QPSK	1732.5	-9.94	31.23	1.02	1.62	0	21.89	H
		Q16	1732.5	-10.18	31.23	1.02	1.62	0	21.65	H

Radiated Power (ERP) for E-UTRA Band 5

Mode	Band width (MHz)	Modulation	Frequency (MHz)	P _{Mea} (dBm)	Amplifier Gain (dBi)	Path Loss (dB)	Antenna Gain (dB)	Correction (dB)	ERP (Peak) (dBm)	Polarization
E-UTRA Band 5	1.4	QPSK	836.5	-5.50	31.23	1.02	-2.45	0	22.26	H
		Q16	836.5	-5.80	31.23	1.02	-2.45	0	21.96	H
	3	QPSK	836.5	-6.28	31.23	1.02	-2.45	0	21.48	H
		Q16	836.5	-5.95	31.23	1.02	-2.45	0	21.81	H
	5	QPSK	836.5	-5.18	31.23	1.02	-2.45	0	22.58	H
		Q16	836.5	-5.34	31.23	1.02	-2.45	0	22.42	H
	10	QPSK	836.5	-6.08	31.23	1.02	-2.45	0	21.68	H
		Q16	836.5	-4.81	31.23	1.02	-2.45	0	22.95	H



Radiated Power (EIRP) for E-UTRA Band 7

Mode	Band width (MHz)	Modulation	Frequency (MHz)	P _{Mea} (dBm)	Amplifier Gain (dBi)	Path Loss (dB)	Antenna Gain (dB)	Correction (dB)	EIRP.(Peak) (dBm)	Polarization
E-UTRA Band 7	5	QPSK	2535	-10.18	31.23	1.02	1.32	0	21.35	H
		Q16	2535	-9.83	31.23	1.02	1.32	0	21.70	H
	10	QPSK	2535	-9.58	31.23	1.02	1.32	0	21.95	H
		Q16	2535	-9.23	31.23	1.02	1.32	0	22.30	H
	15	QPSK	2535	-8.92	31.23	1.02	1.32	0	22.61	H
		Q16	2535	-8.28	31.23	1.02	1.32	0	23.25	H
	20	QPSK	2535	-10.04	31.23	1.02	1.32	0	21.49	H
		Q16	2535	-8.69	31.23	1.02	1.32	0	22.84	H

Radiated Power (ERP) for E-UTRA Band 12

Mode	Band width (MHz)	Modulation	Frequency (MHz)	P _{Mea} (dBm)	Amplifier Gain (dBi)	Path Loss (dB)	Antenna Gain (dB)	Correction (dB)	ERP (Peak) (dBm)	Polarization
E-UTRA Band 12	1.4	QPSK	707.5	-5.33	31.23	1.02	-2.58	0	22.30	H
		Q16	707.5	-6.02	31.23	1.02	-2.58	0	21.61	H
	3	QPSK	707.5	-5.39	31.23	1.02	-2.58	0	22.24	H
		Q16	707.5	-4.61	31.23	1.02	-2.58	0	23.02	H
	5	QPSK	707.5	-5.71	31.23	1.02	-2.58	0	21.92	H
		Q16	707.5	-6.17	31.23	1.02	-2.58	0	21.46	H
	10	QPSK	707.5	-5.60	31.23	1.02	-2.58	0	22.03	H
		Q16	707.5	-4.80	31.23	1.02	-2.58	0	22.83	H

Radiated Power (ERP) for E-UTRA Band 17

Mode	Band width (MHz)	Modulation	Frequency (MHz)	P _{Mea} (dBm)	Amplifier Gain (dBi)	Path Loss (dB)	Antenna Gain (dB)	Correction (dB)	ERP (Peak) (dBm)	Polarization
E-UTRA Band 17	5	QPSK	710	-6.16	31.23	1.02	-2.58	0	21.47	H
		Q16	710	-4.64	31.23	1.02	-2.58	0	22.99	H
	10	QPSK	710	-6.21	31.23	1.02	-2.58	0	21.42	H
		Q16	710	-4.47	31.23	1.02	-2.58	0	23.16	H

Radiated Power (ERP) for E-UTRA Band 26

Mode	Band width (MHz)	Modulation	Frequency (MHz)	P _{Mea} (dBm)	Amplifier Gain (dBi)	Path Loss (dB)	Antenna Gain (dB)	Correction (dB)	ERP (Peak) (dBm)	Polarization
E-UTRA Band 26	1.4	QPSK	831.5	-5.81	31.23	1.02	-2.45	0	21.95	H
		Q16	831.5	-6.06	31.23	1.02	-2.45	0	21.70	H
	3	QPSK	831.5	-6.07	31.23	1.02	-2.45	0	21.69	H
		Q16	831.5	-4.89	31.23	1.02	-2.45	0	22.87	H
	5	QPSK	831.5	-4.78	31.23	1.02	-2.45	0	22.98	H
		Q16	831.5	-6.40	31.23	1.02	-2.45	0	21.36	H
	10	QPSK	831.5	-4.97	31.23	1.02	-2.45	0	22.79	H
		Q16	831.5	-4.56	31.23	1.02	-2.45	0	23.20	H
	15	QPSK	831.5	-4.80	31.23	1.02	-2.45	0	22.96	H
		Q16	831.5	-5.08	31.23	1.02	-2.45	0	22.68	H





Radiated Power (EIRP) for E-UTRA Band 38

Mode	Band width (MHz)	Modulation	Frequency (MHz)	P _{Mea} (dBm)	Amplifier Gain (dBi)	Path Loss (dB)	Antenna Gain (dB)	Correction (dB)	EIRP (Peak) (dBm)	Polarization
E-UTRA Band 38	5	QPSK	2595	-9.08	31.23	1.02	0.52	0	21.65	H
		Q16	2595	-7.64	31.23	1.02	0.52	0	23.09	H
	10	QPSK	2595	-8.90	31.23	1.02	0.52	0	21.83	H
		Q16	2595	-8.37	31.23	1.02	0.52	0	22.36	H
	15	QPSK	2595	-8.82	31.23	1.02	0.52	0	21.91	H
		Q16	2595	-8.86	31.23	1.02	0.52	0	21.87	H
	20	QPSK	2595	-7.58	31.23	1.02	0.52	0	23.15	H
		Q16	2595	-7.66	31.23	1.02	0.52	0	23.07	H

Radiated Power (EIRP) for E-UTRA Band 41

Mode	Band width (MHz)	Modulation	Frequency (MHz)	P _{Mea} (dBm)	Amplifier Gain (dBi)	Path Loss (dB)	Antenna Gain (dB)	Correction (dB)	EIRP (Peak) (dBm)	Polarization
E-UTRA Band 41	5	QPSK	2605.0	-7.51	31.23	1.02	0.32	0	23.02	H
		Q16	2605.0	-8.48	31.23	1.02	0.32	0	22.05	H
	10	QPSK	2605.0	-7.92	31.23	1.02	0.32	0	22.61	H
		Q16	2605.0	-7.52	31.23	1.02	0.32	0	23.01	H
	15	QPSK	2605.0	-7.80	31.23	1.02	0.32	0	22.73	H
		Q16	2605.0	-8.88	31.23	1.02	0.32	0	21.65	H
	20	QPSK	2605.0	-7.57	31.23	1.02	0.32	0	22.96	H
		Q16	2605.0	-7.71	31.23	1.02	0.32	0	22.82	H

Radiated Power (EIRP) for E-UTRA Band 66

Mode	Band width (MHz)	Modulation	Frequency (MHz)	P _{Mea} (dBm)	Amplifier Gain (dBi)	Path Loss (dB)	Antenna Gain (dB)	Correction (dB)	EIRP (Peak) (dBm)	Polarization
E-UTRA Band 66	1.4	QPSK	1777.5	-9.49	31.23	1.02	1.62	0	22.34	H
		Q16	1777.5	-9.26	31.23	1.02	1.62	0	22.57	H
	3	QPSK	1777.5	-8.86	31.23	1.02	1.62	0	22.97	H
		Q16	1777.5	-9.63	31.23	1.02	1.62	0	22.20	H
	5	QPSK	1777.5	-10.01	31.23	1.02	1.62	0	21.82	H
		Q16	1777.5	-9.85	31.23	1.02	1.62	0	21.98	H
	10	QPSK	1777.5	-9.58	31.23	1.02	1.62	0	22.25	H
		Q16	1777.5	-10.39	31.23	1.02	1.62	0	21.44	H
	15	QPSK	1777.5	-9.32	31.23	1.02	1.62	2.15	22.51	H
		Q16	1777.5	-8.99	31.23	1.02	1.62	2.15	22.84	H
	20	QPSK	1777.5	-10.08	31.23	1.02	1.62	2.15	21.75	H
		Q16	1777.5	-9.76	31.23	1.02	1.62	2.15	22.07	H

ERP or EIRP = P_{Mea} + Amplifier Gain – Path Loss + Antenna Gain – Correction Factor

Note: Each channel is scanned 10 times, the worst data is recorded.





7. SPURIOUS EMISSION (Conducted and Radiated)

7.1. Measurement Result (Pre-measurement)





GSM850:

Test Channel	BW(MHz)	UL Channel	Frequency(MHz)	Judgment
Low Range	0.2	128	824.2	Pass
Middle Range	0.2	190	836.6	Pass
High Range	0.2	251	848.8	Pass

PCS 1900 :

Test Channel	BW(MHz)	UL Channel	Frequency(MHz)	Judgment
Low Range	0.2	512	1850.2	Pass
Middle Range	0.2	661	1880.0	Pass
High Range	0.2	810	1909.8	Pass

UTRA BANDS

BAND 2:

Test Channel	BW(MHz)	UL Channel	Frequency(MHz)	Judgment
Low Range	5	9262	1852.4	Pass
Middle Range	5	9400	1880.0	Pass
High Range	5	9538	1907.6	Pass

BAND 4:

Test Channel	BW(MHz)	UL Channel	Frequency(MHz)	Judgment
Low Range	5	1312	1712.4	Pass
Middle Range	5	1413	1732.6	Pass
High Range	5	1513	1752.6	Pass

BAND 5:

Test Channel	BW(MHz)	UL Channel	Frequency(MHz)	Judgment
Low Range	5	4132	826.4	Pass
Middle Range	5	4182	836.4	Pass
High Range	5	4233	846.6	Pass





Test Plot(s)
Conducted method

Test limit:

The spurious (unwanted) emission limits specified in the individual FCC rule parts applicable to licensed digital transmitters (typically referred to under the heading 'emission limits') normally apply to any and all emissions that are present outside of the authorized frequency band/block and apply to emissions in both the out-of-band and spurious domains. In some rule parts, the unwanted emission limits are specified by an emission mask that defines the applicable limit as a function of the frequency range relative to the authorized frequency block.

Typically, unwanted emissions are required by the licensed rule parts to be attenuated below the transmitter power by a factor of at least $X + 10\log(P)$ dB, where P represents the transmitter power expressed in watts and X is a specified scalar value (e.g., 43). This specification can be interpreted in one of two equivalent ways. First, the required attenuation can be construed to be relative to the mean carrier power, with the resultant of the equation $X + 10\log(P)$ being expressed in dB (dB relative to the maximum carrier power). Alternatively, the specification can be interpreted as an absolute limit when the specified attenuation is actually subtracted from the maximum permissible transmitter power [i.e., $10\log(P) - \{X + 10\log(P)\}$], resulting in an absolute level of -X dBW [or (-X + 30) dBm]. See section 4.

Test procedure:

The RF output of the transceiver was connected to a spectrum analyzer and simulator through appropriate attenuation. The resolution bandwidth of the spectrum analyzer was set at 100 kHz below 1 GHz and 1 MHz above 1 GHz. Sufficient scans were taken to show any out of band emissions up to 10th harmonics.

Conducted Emission Test-Up:

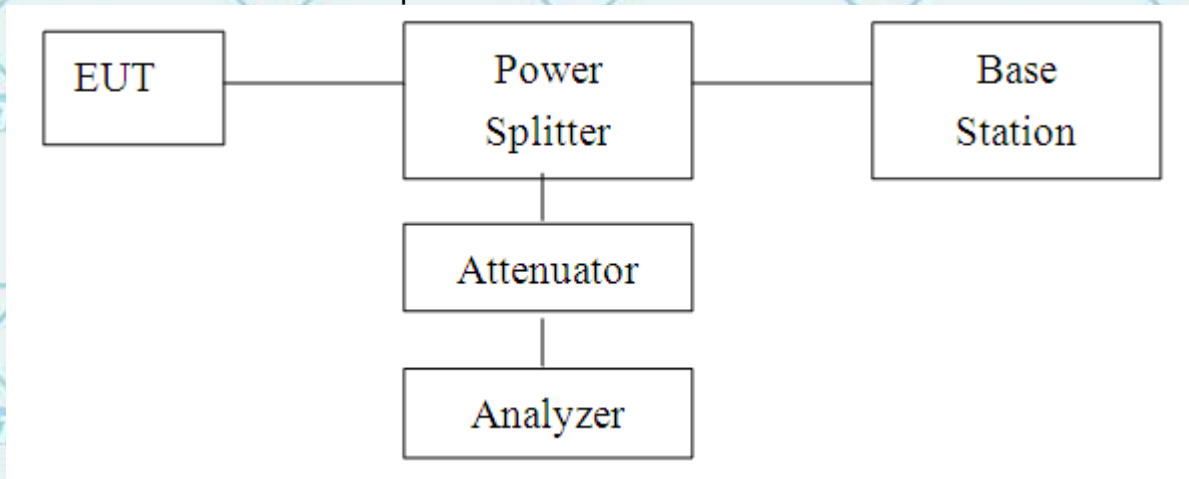



CONDUCTED EMISSION IN GSM850 BAND Conducted Emission Transmitting Mode CH 128 30MHz – 1GHz

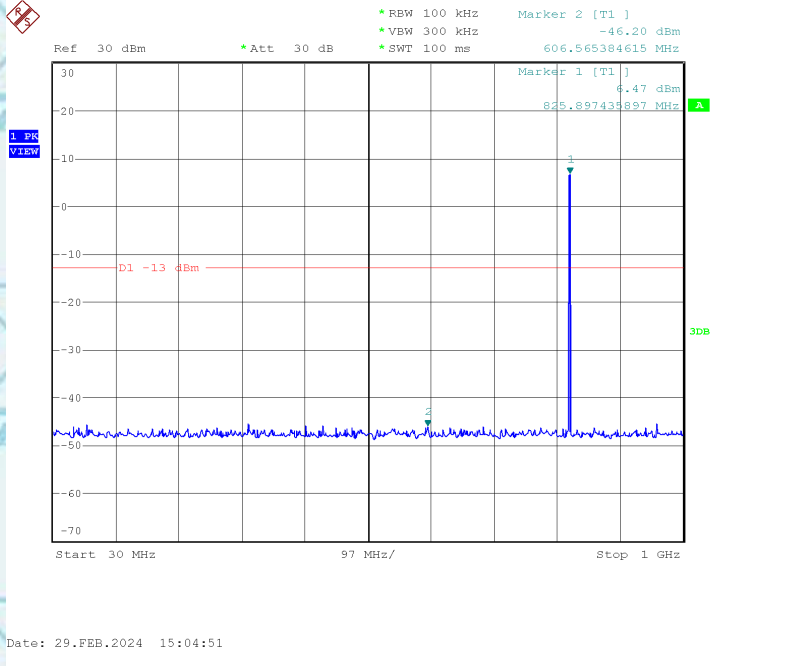



Conducted Emission Transmitting Mode CH 128 1GHz – 9GHz

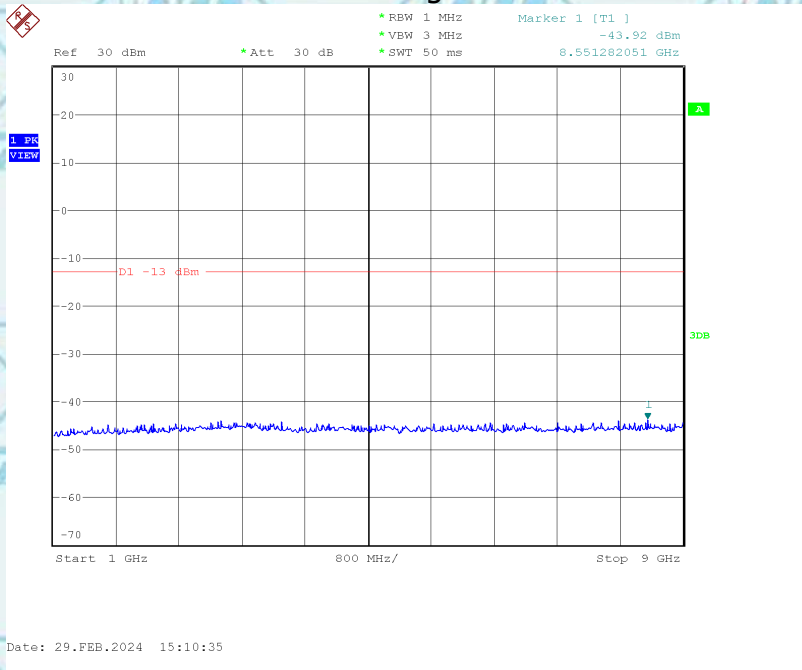



Conducted Emission Transmitting Mode CH 190 30MHz – 1GHz

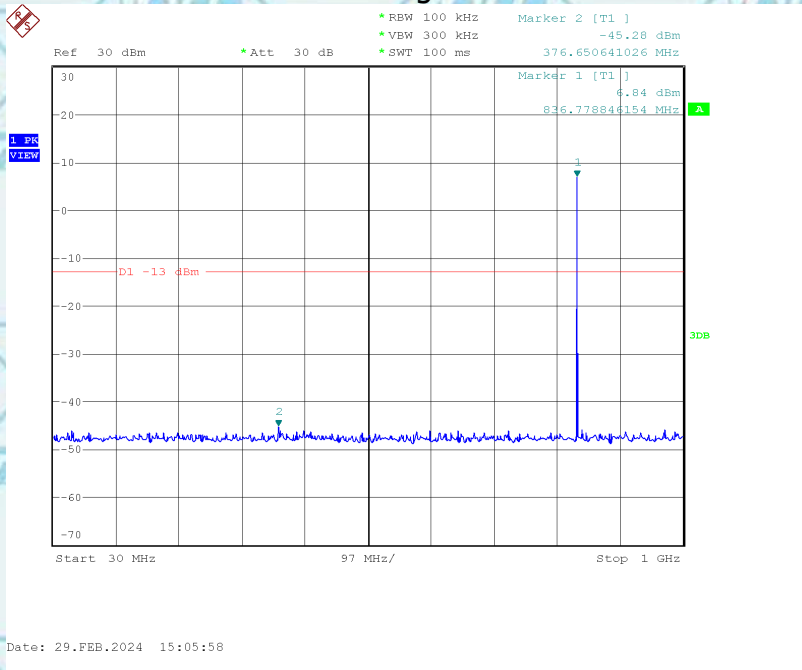

Conducted Emission Transmitting Mode CH 190 1GHz – 9GHz

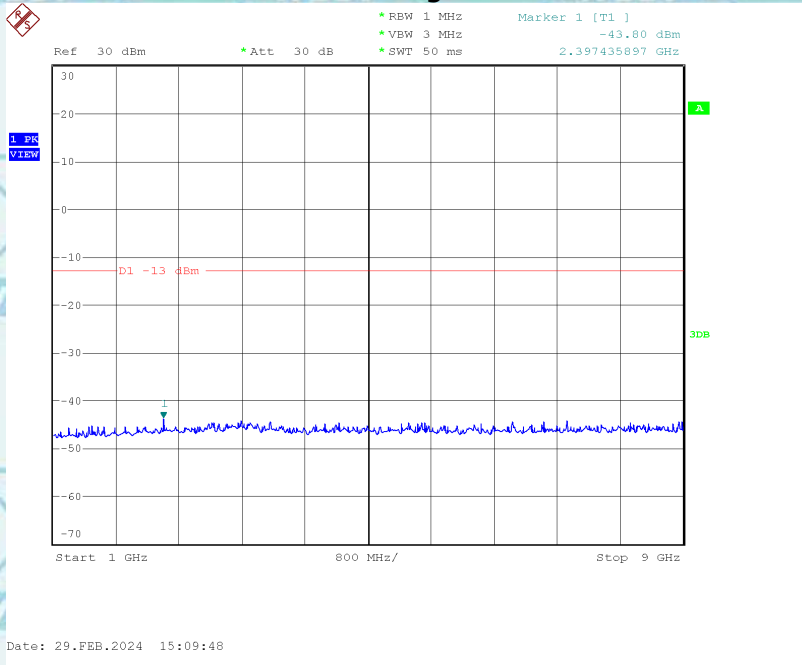



Conducted Emission Transmitting Mode CH 251 30MHz – 1GHz

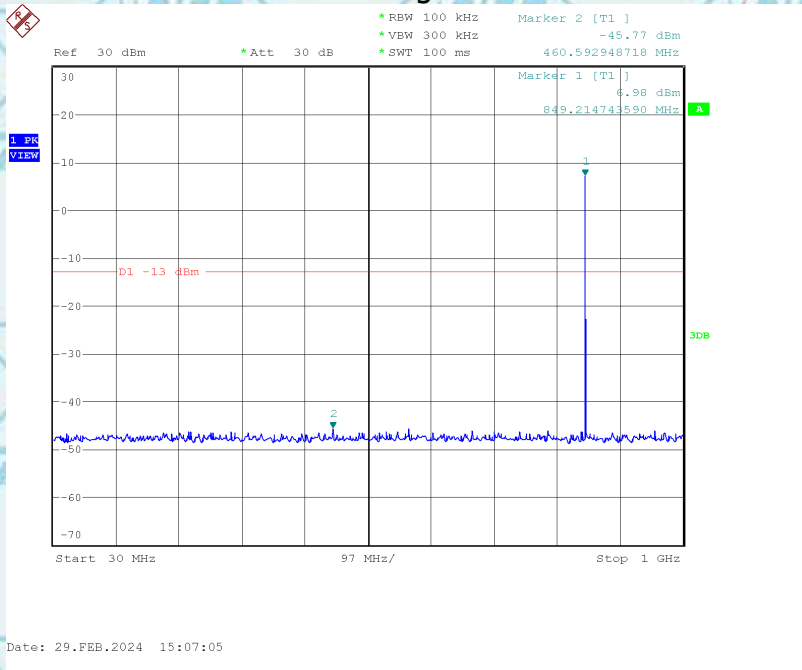

Conducted Emission Transmitting Mode CH 251 1GHz – 9GHz

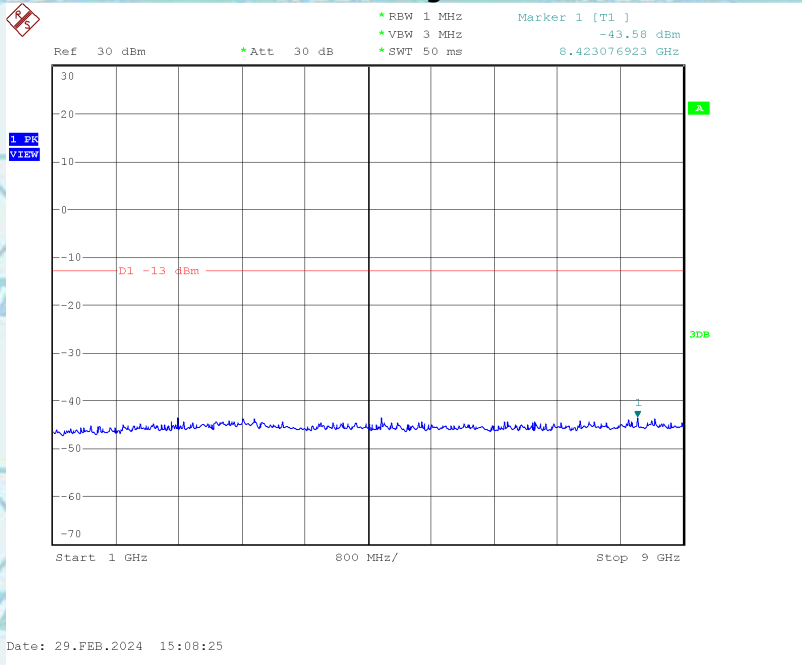



CONDUCTED EMISSION IN PCS1900 BAND Conducted Emission Transmitting Mode CH 512 30MHz – 1GHz

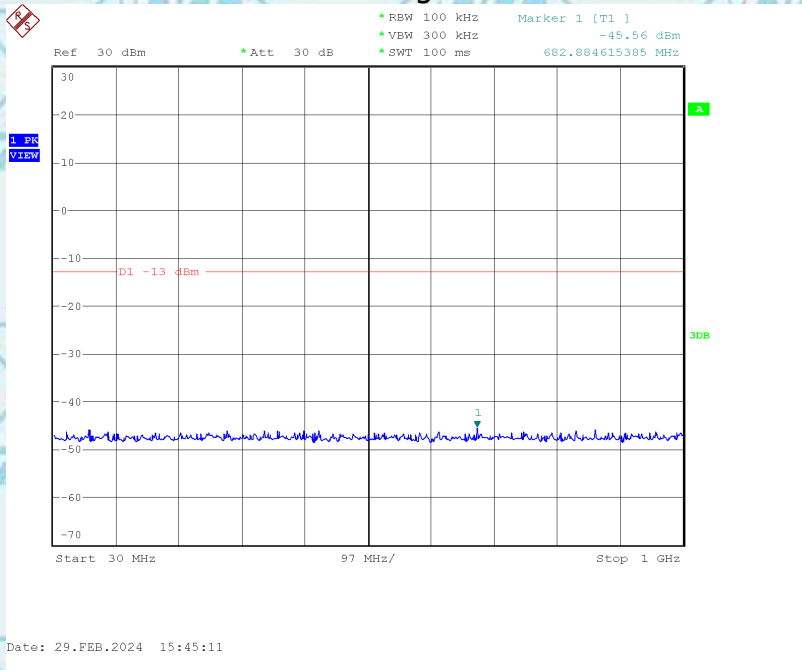



Conducted Emission Transmitting Mode CH 512 1GHz – 20GHz

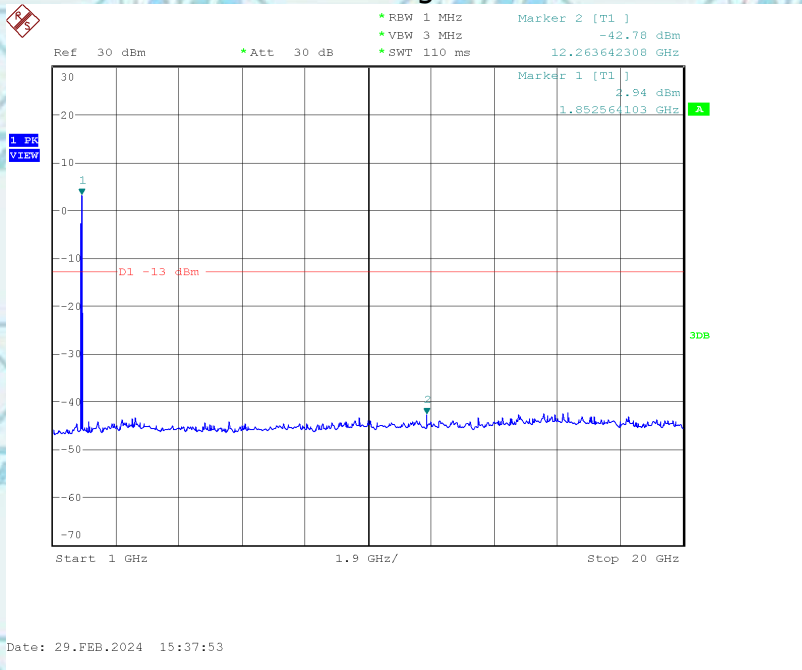

Conducted Emission Transmitting Mode CH 661 30MHz – 1GHz

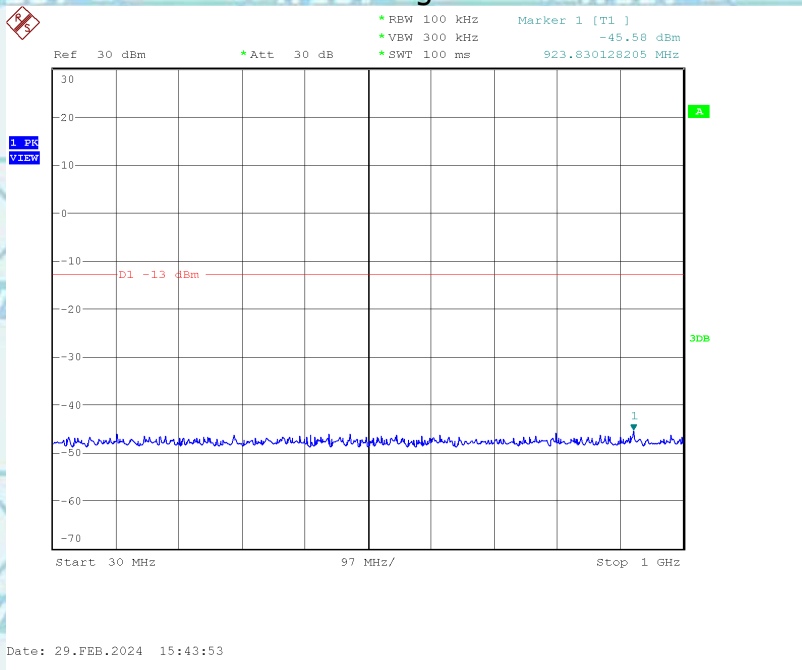



Conducted Emission Transmitting Mode CH 661 1GHz – 20GHz

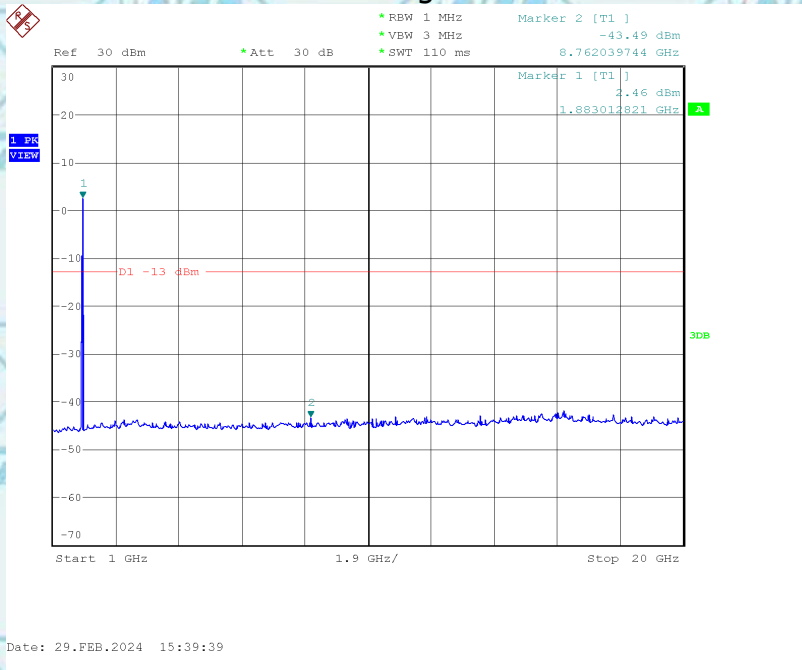

Conducted Emission Transmitting Mode CH 810 30MHz – 1GHz

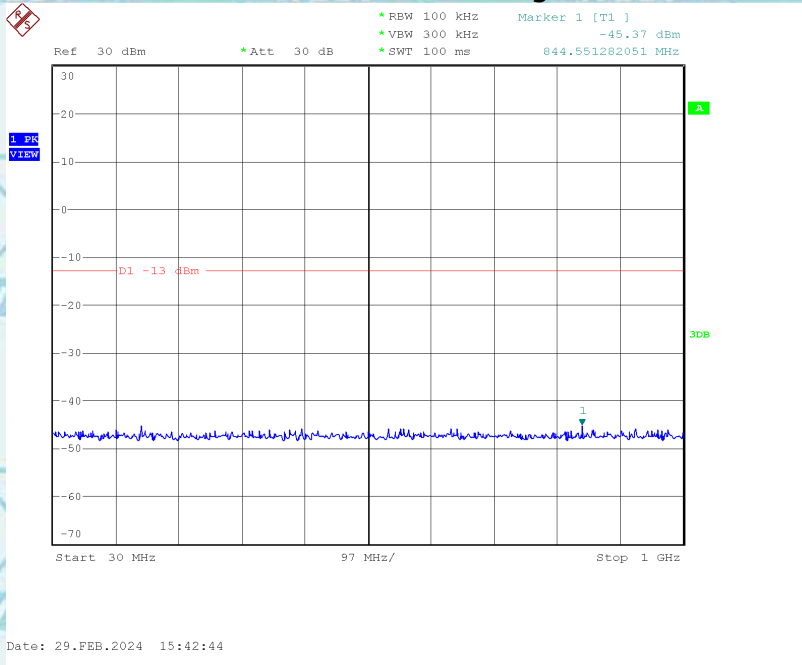



Conducted Emission Transmitting Mode CH 810 1GHz – 20GHz

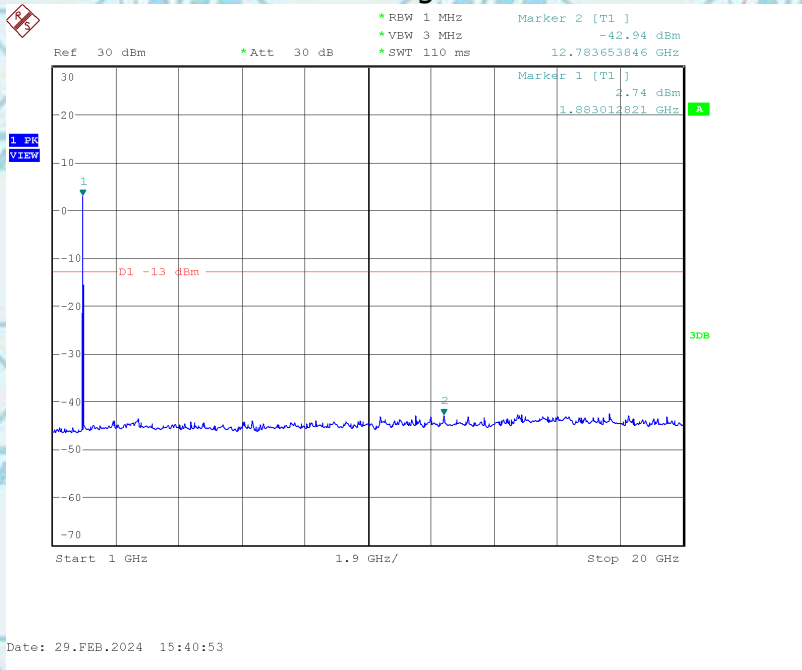

CONDUCTED EMISSION IN WCDMA Band II Conducted Emission Transmitting Mode CH 9262 30MHz – 1GHz

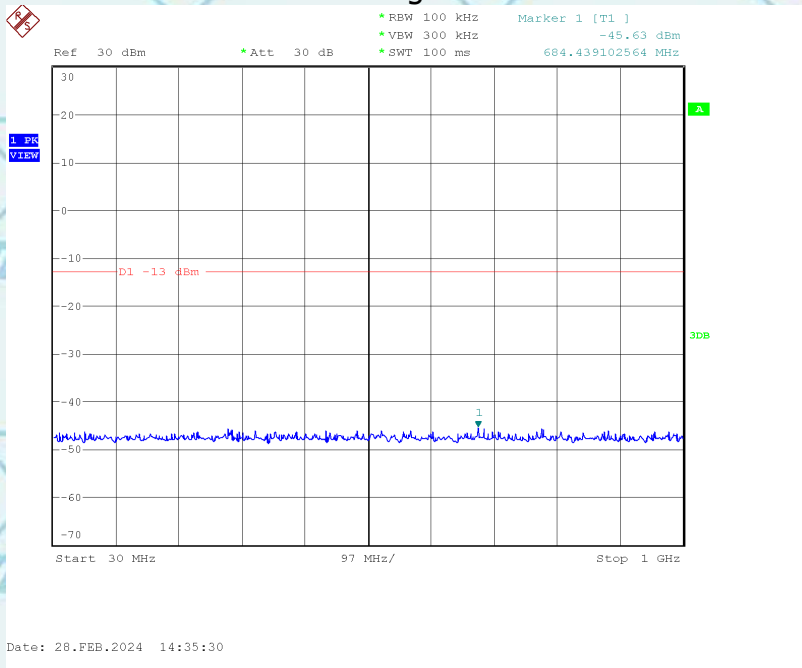



Conducted Emission Transmitting Mode CH 9262 1GHz – 20GHz

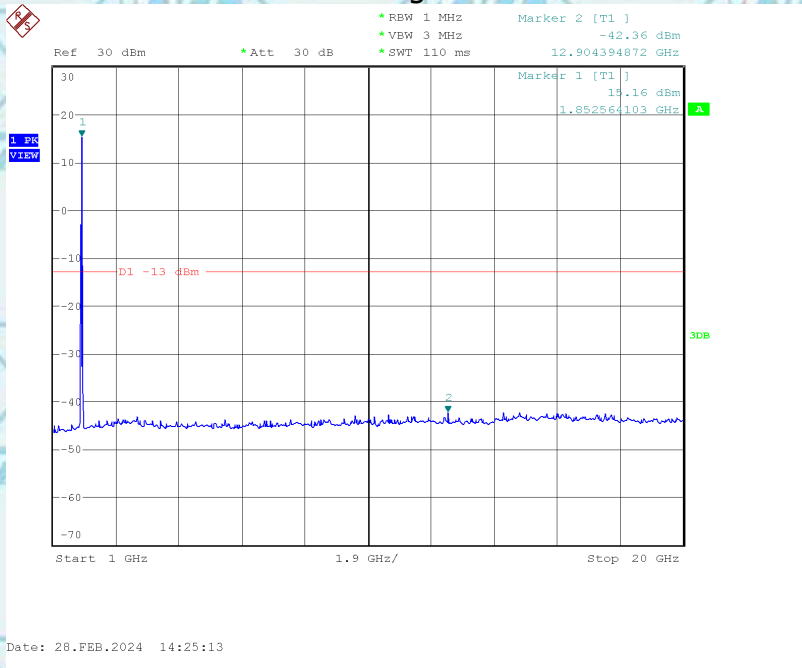

Conducted Emission Transmitting Mode CH 9400 30MHz – 1GHz

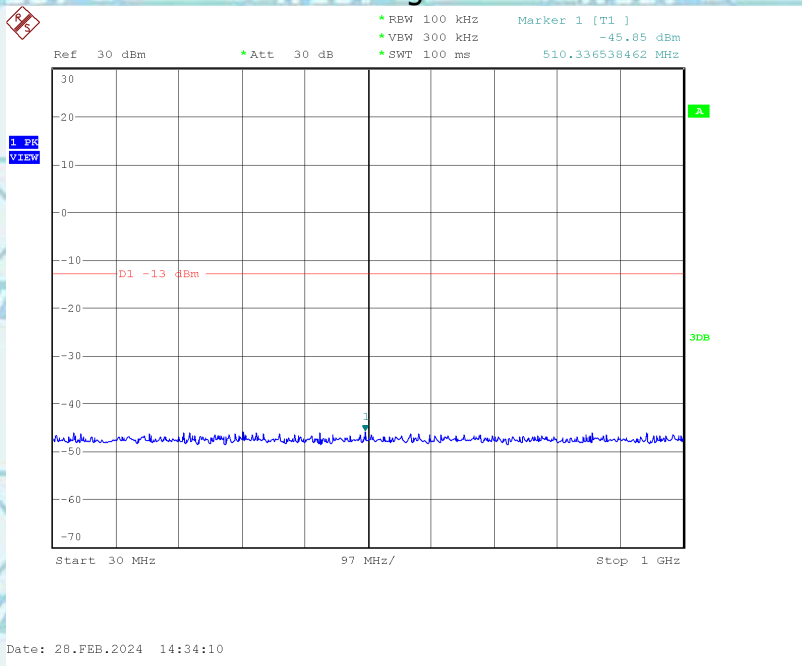



Conducted Emission Transmitting Mode CH 9400 1GHz – 20GHz

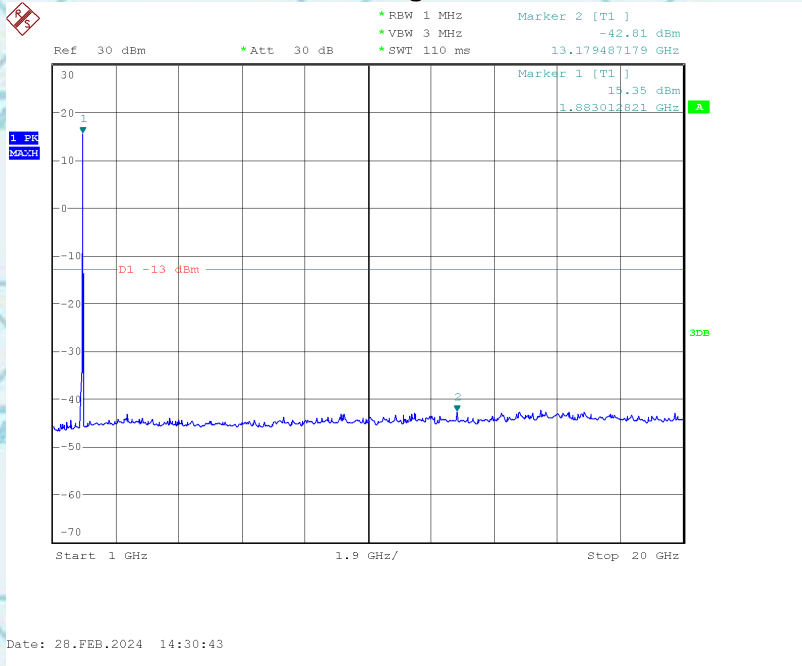

Conducted Emission Transmitting Mode CH 9538 30MHz – 1GHz

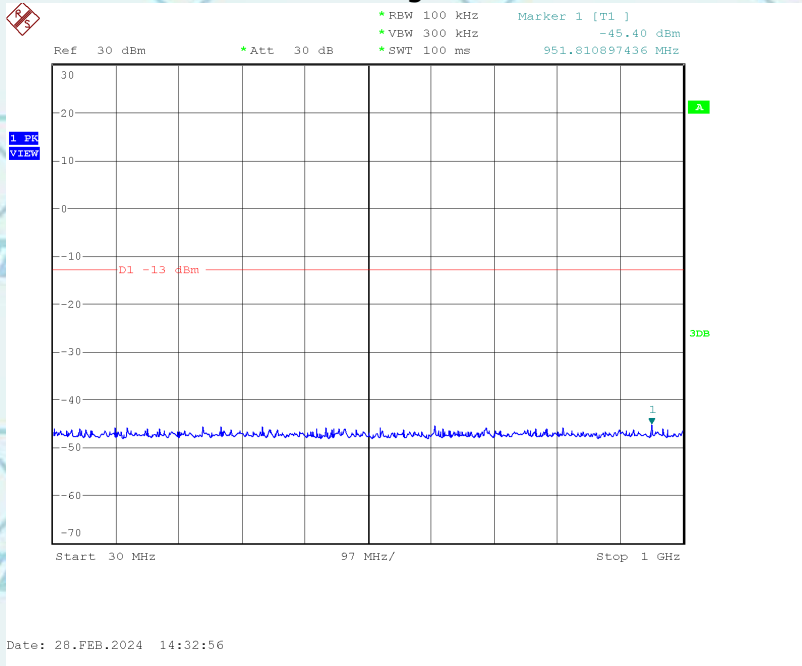



Conducted Emission Transmitting Mode CH 9538 1GHz – 20GHz

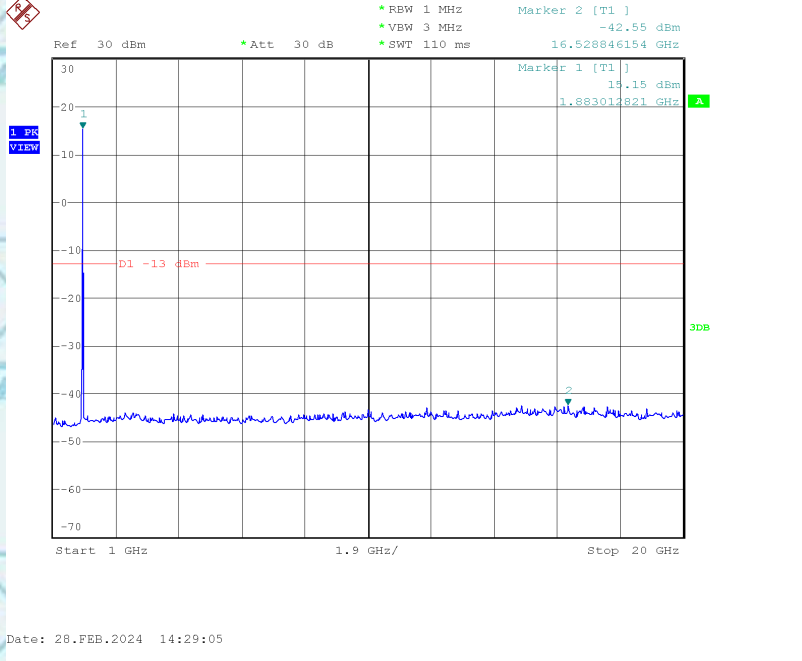

CONDUCTED EMISSION IN WCDMA Band IV Conducted Emission Transmitting Mode CH 1312 30MHz – 1GHz

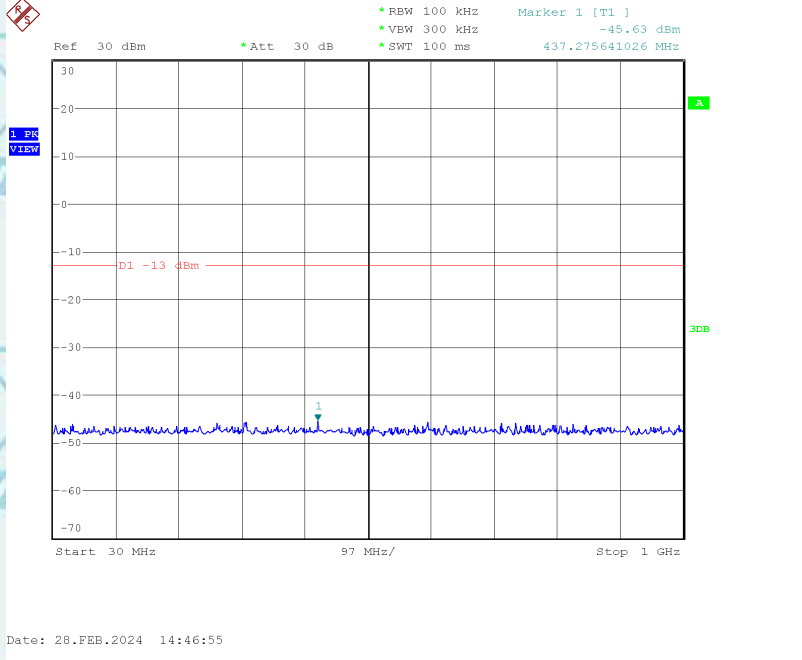



Conducted Emission Transmitting Mode CH 1312 1GHz – 20GHz

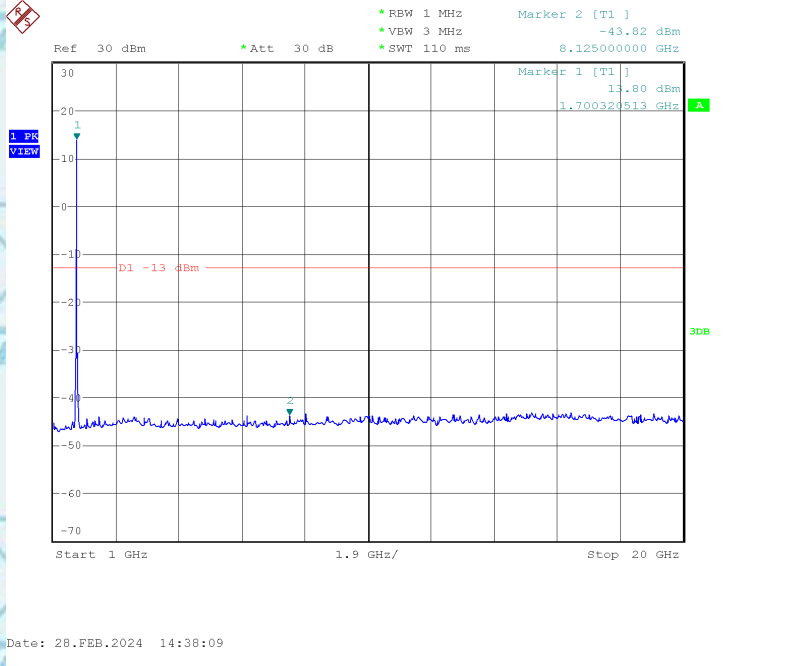

Conducted Emission Transmitting Mode CH 1413 30MHz – 1GHz

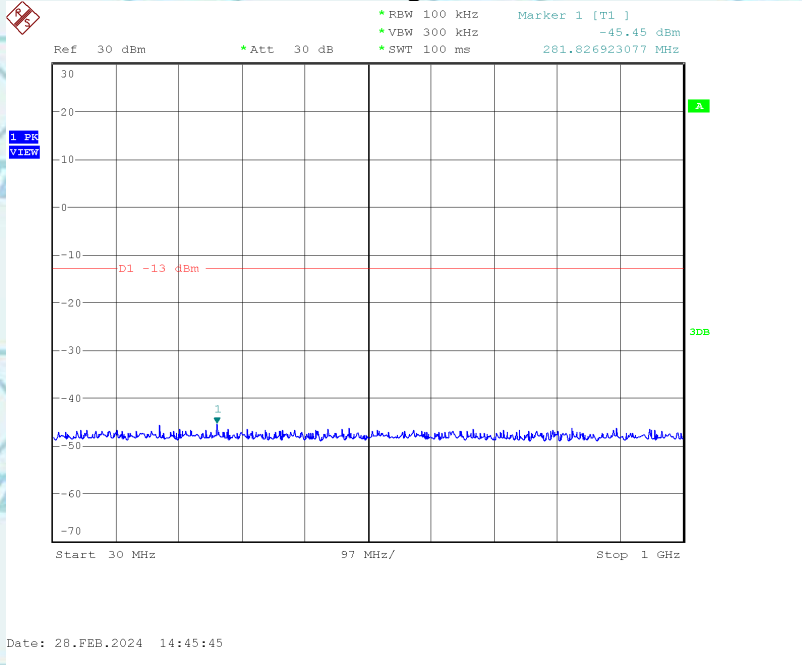



Conducted Emission Transmitting Mode CH 1413 1GHz – 20GHz

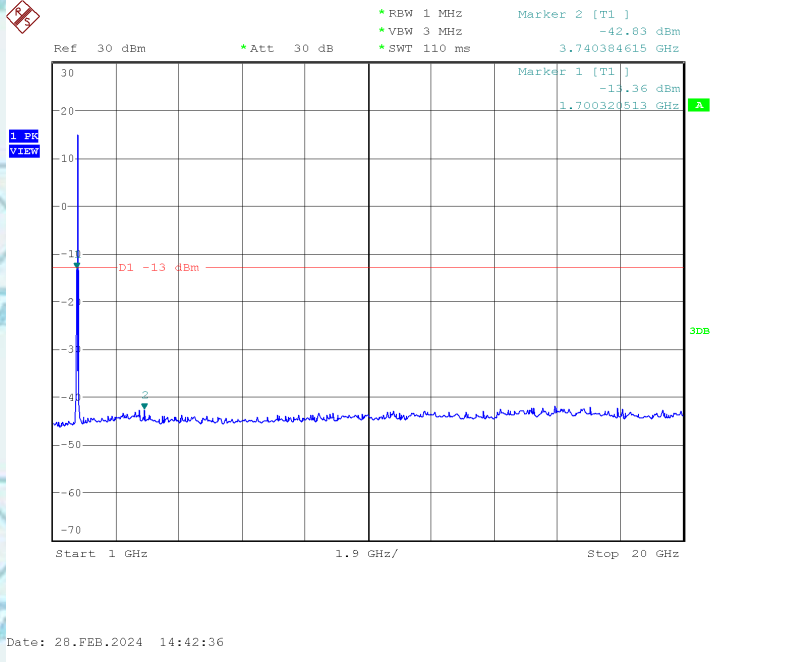

Conducted Emission Transmitting Mode CH 1513 30MHz – 1GHz

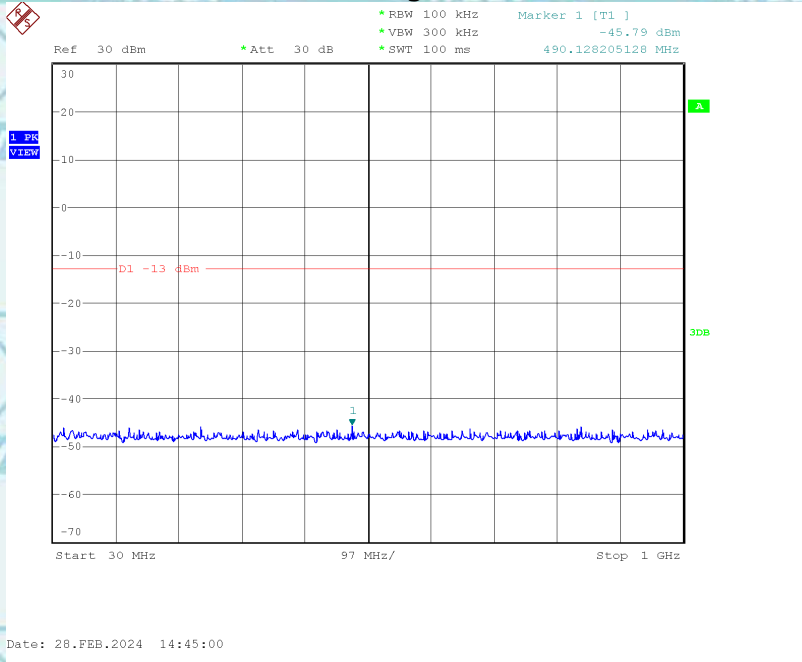



Conducted Emission Transmitting Mode CH 1513 1GHz – 20GHz

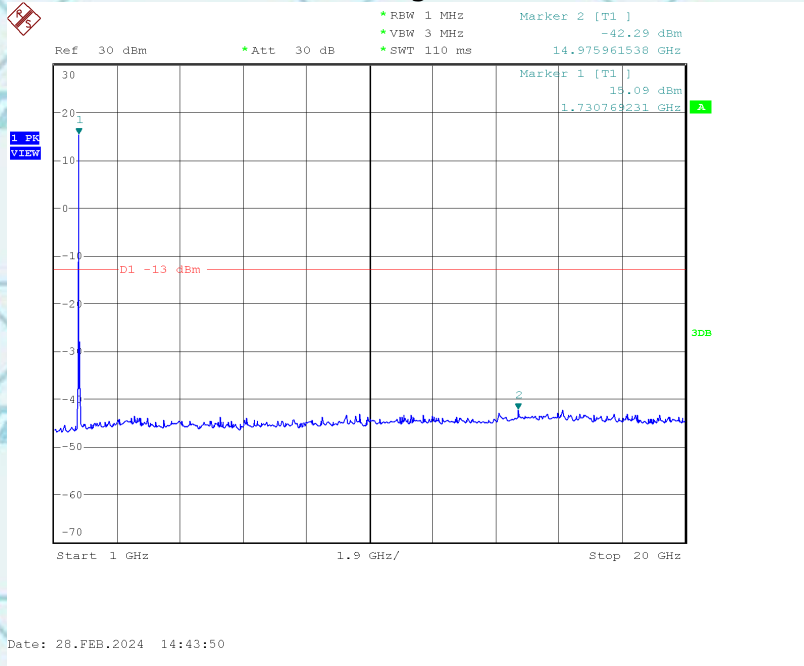

CONDUCTED EMISSION IN WCDMA Band V Conducted Emission Transmitting Mode CH 4132 30MHz – 1GHz

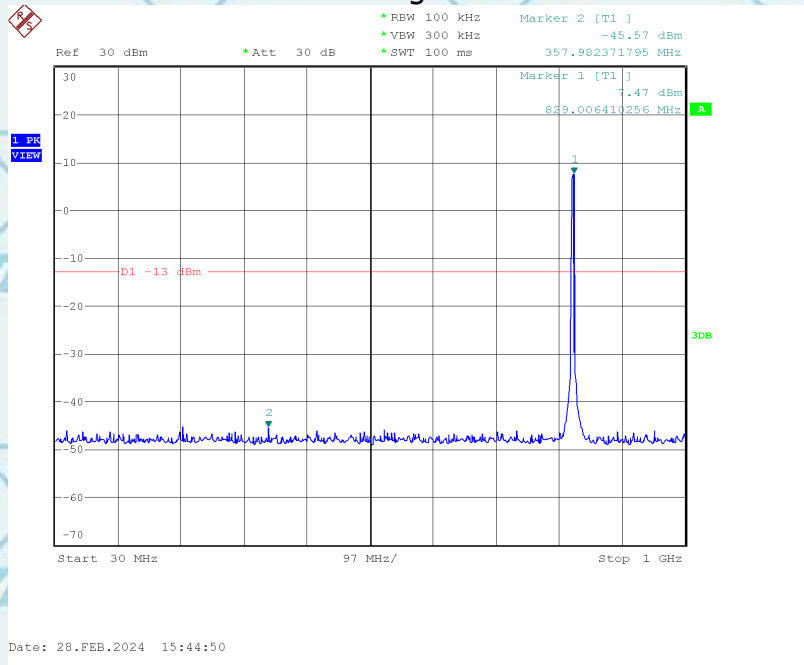



Report No.: WSCT-A2LA-R&E24020007A-RF

Certificate #5768.01

For Question,
Please Contact with WSCT
www.wsct-cert.com

Conducted Emission Transmitting Mode CH 4132 1GHz – 9GHz

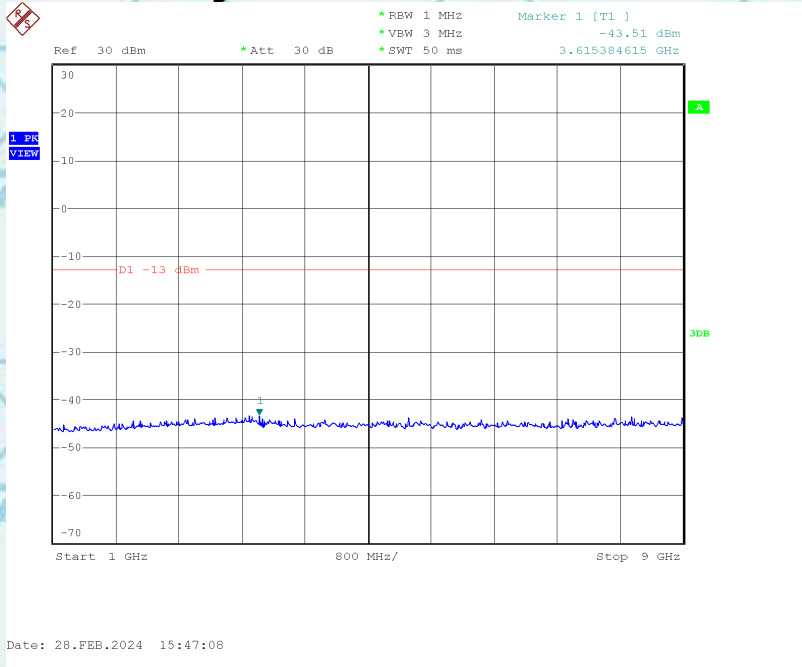

Conducted Emission Transmitting Mode CH 4182 30MHz – 1GHz

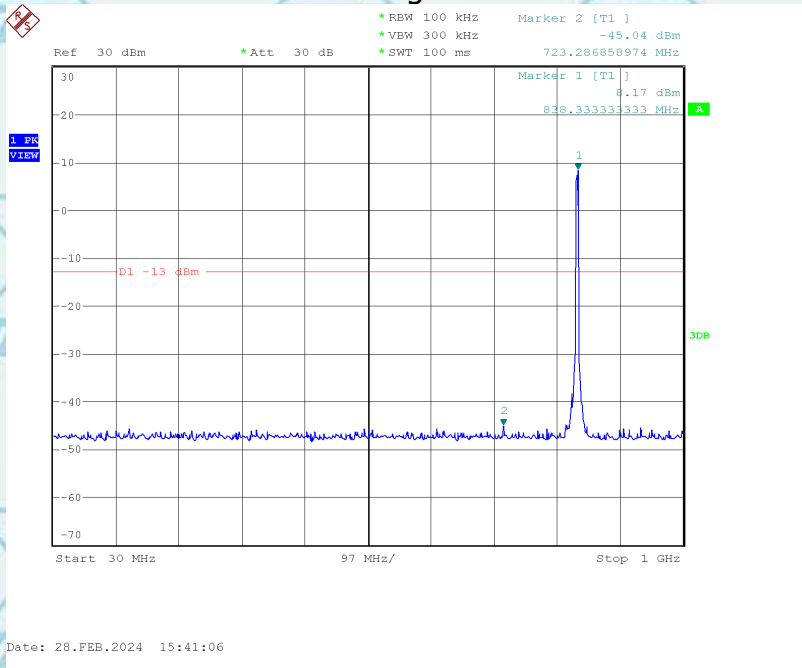



Conducted Emission Transmitting Mode CH 4182 1GHz – 9GHz

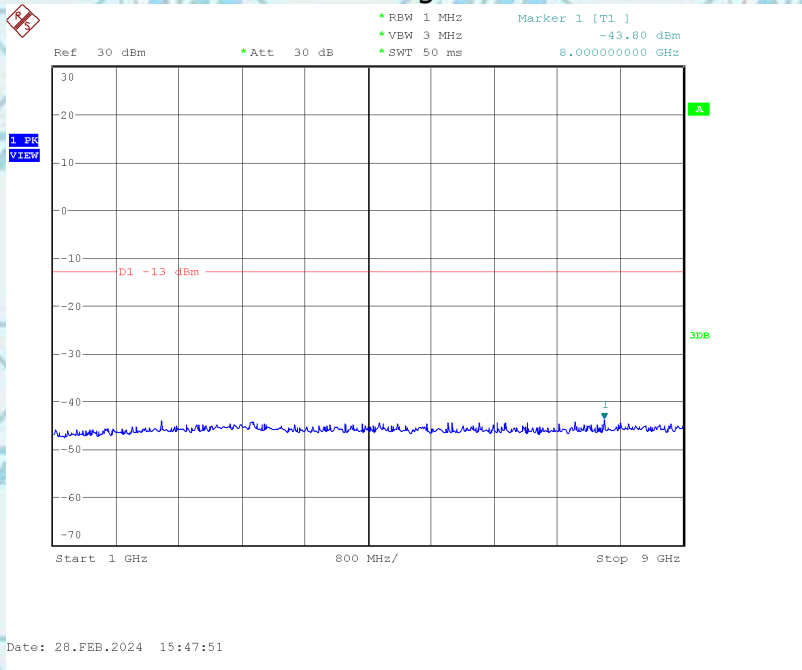

Conducted Emission Transmitting Mode CH 4233 30MHz – 1GHz

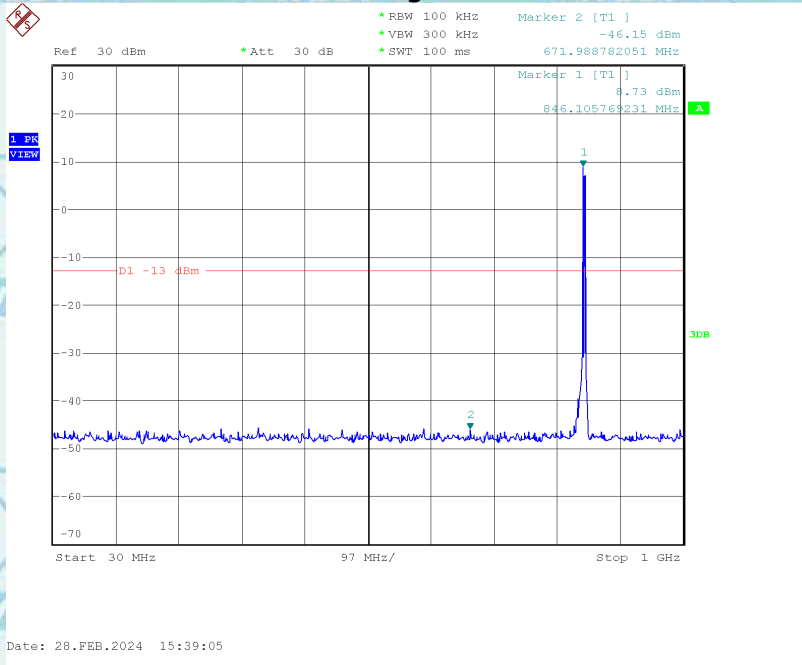



Conducted Emission Transmitting Mode CH 4233 1GHz – 9GHz

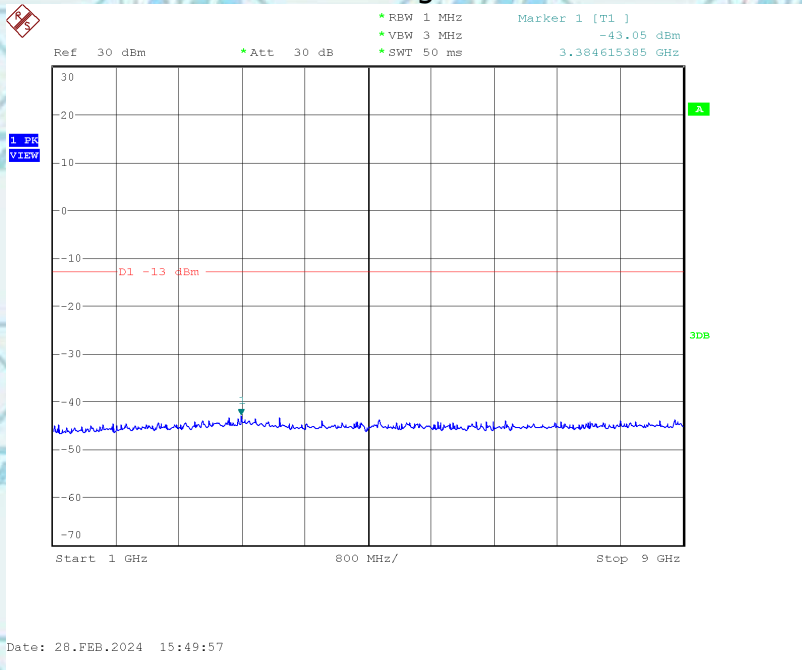

Refer to E-UTRA Annex for Band2, Band4, Band5, Band7, Band12, Band17, Band26, Band38, Band41, Band66.





Radiated method

Test limit:

The spurious (unwanted) emission limits specified in the individual FCC rule parts applicable to licensed digital transmitters (typically referred to under the heading 'emission limits') normally apply to any and all emissions that are present outside of the authorized frequency band/block and apply to emissions in both the out-of-band and spurious domains. In some rule parts, the unwanted emission limits are specified by an emission mask that defines the applicable limit as a function of the frequency range relative to the authorized frequency block.

Typically, unwanted emissions are required by the licensed rule parts to be attenuated below the transmitter power by a factor of at least $X + 10\log(P)$ dB, where P represents the transmitter power expressed in watts and X is a specified scalar value (e.g., 43). This specification can be interpreted in one of two equivalent ways. First, the required attenuation can be construed to be relative to the mean carrier power, with the resultant of the equation $X + 10\log(P)$ being expressed in dBc (dB relative to the maximum carrier power). Alternatively, the specification can be interpreted as an absolute limit when the specified attenuation is actually subtracted from the maximum permissible transmitter power [i.e., $10\log(P) - \{X + 10\log(P)\}$], resulting in an absolute level of -X dBW [or $(-X + 30)$ dBm]. See section 4.

Test procedure:

The radiated emission tests were performed in the 3m Semi- Anechoic Chamber test site. The resolution bandwidth of the spectrum analyzer was set at 100 kHz below 1 GHz and 1 MHz above 1 GHz. Sufficient scans were taken to show any out of band emissions up to 10th harmonics.

Test setup:

(A) Radiated Emission Test-Up Frequency 30MHz~1GHz

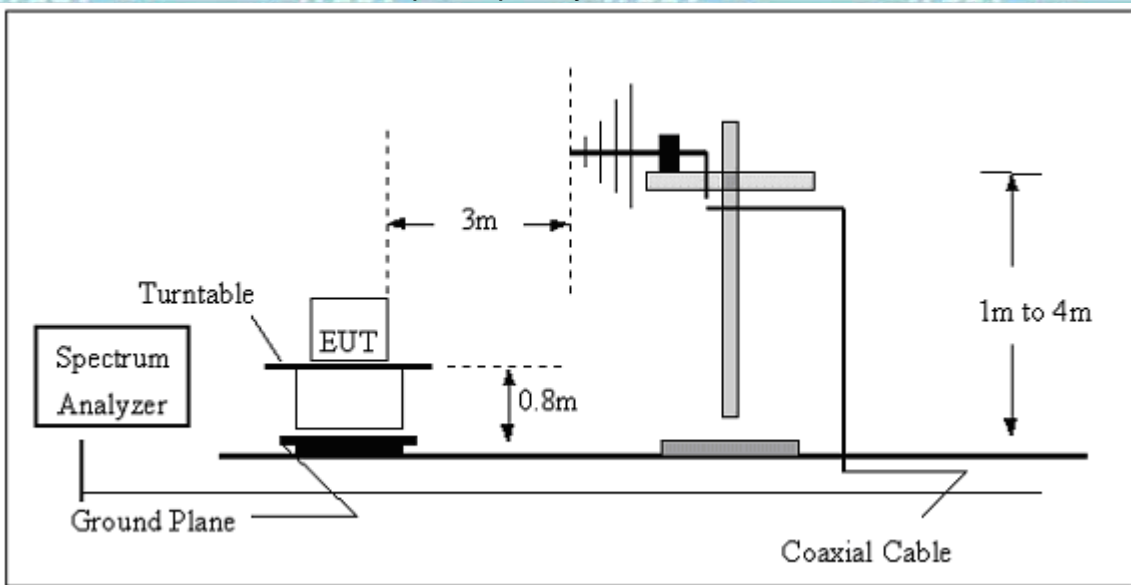



(B) Radiated Emission Test-Up Frequency Above 1GHz

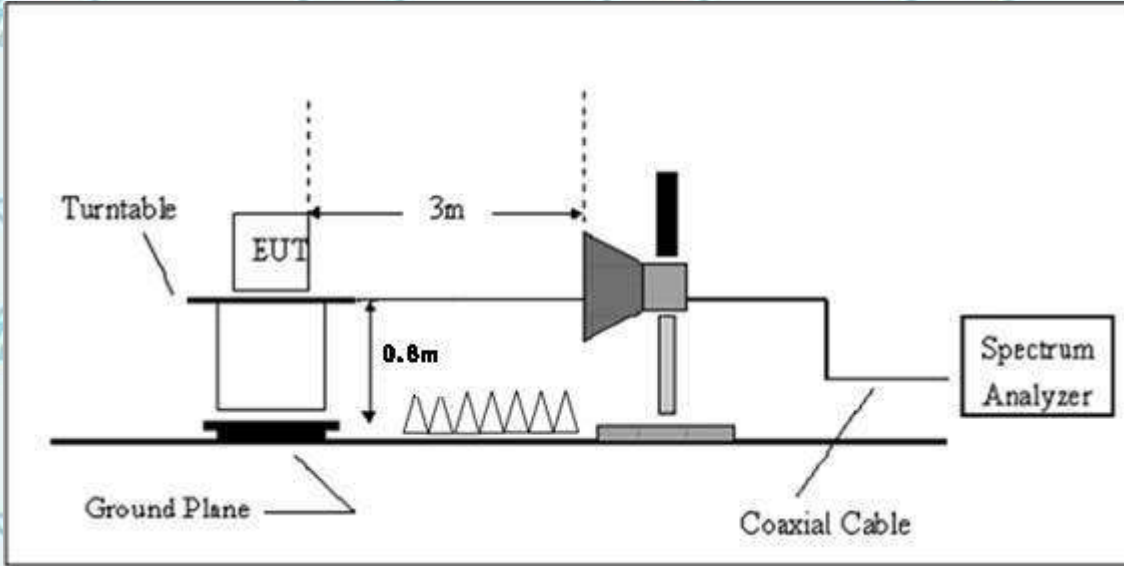

Note:

- 1, Below 30MHz no Spurious found.
- 2, UE is positioned at 3 axis at the pre-scan stage, and only the measurement of the worst case (bandwidth:20MHz /Full RB /QPSK) is reported in this part.





**List of final test modes:
GSM850:**

Mode	UL Channel	Frequency	Judgement
1	128	824.2	Pass
2	190	836.6	Pass
3	251	848.8	Pass

PCS1900

Mode	UL Channel	Frequency	Judgement
1	512	1850.2	Pass
2	661	1880	Pass
3	810	1909.8	Pass

**UTRA BANDS
BAND 2:**

Mode	UL Channel	Frequency	Judgement
1	9262	1852.4	Pass
2	9400	1880	Pass
3	9538	1907.6	Pass

BAND 4:

Mode	UL Channel	Frequency	Judgement
1	1312	1712.4	Pass
2	1413	1732.6	Pass
3	1513	1752.6	Pass

BAND 5:

Mode	UL Channel	Frequency	Judgement
1	4132	826.4	Pass
2	4182	836.4	Pass
3	4233	846.6	Pass



E-UTRA BANDS

This is the worst pattern data

BAND 2:

Mode	Bandwidth	UL Channel	Frequency	Modulation	RB Size	RB Offset	Judgement
1	20	18700	1860	QPSK	100	LOW	Pass
2	20	18900	1880	QPSK	100	LOW	Pass
3	20	19100	1900	QPSK	100	LOW	Pass

BAND 4:

Mode	Bandwidth	UL Channel	Frequency	Modulation	RB Size	RB Offset	Judgement
1	20	20050	1720	Q16	100	LOW	Pass
2	20	20300	1745	Q16	100	LOW	Pass
3	20	20175	1732.5	Q16	100	LOW	Pass

BAND 5:

Mode	Bandwidth	UL Channel	Frequency	Modulation	RB Size	RB Offset	Judgement
1	10	20450	829	QPSK	50	LOW	Pass
2	10	20525	836.5	QPSK	50	LOW	Pass
3	10	20600	844	QPSK	50	LOW	Pass

BAND 7:

Mode	Bandwidth	UL Channel	Frequency	Modulation	RB Size	RB Offset	Judgement
1	20	20850	2510	QPSK	100	LOW	Pass
2	20	21350	2560	QPSK	100	LOW	Pass
3	20	21100	2535	QPSK	100	LOW	Pass

BAND 12:

Mode	Bandwidth	UL Channel	Frequency	Modulation	RB Size	RB Offset	Judgement
1	10	23060	704	QPSK	100	LOW	Pass
2	10	23095	707.5	QPSK	100	LOW	Pass
3	10	23130	711	QPSK	100	LOW	Pass

BAND 17:

Mode	Bandwidth	UL Channel	Frequency	Modulation	RB Size	RB Offset	Judgement
1	10	23780	709	QPSK	100	LOW	Pass
2	10	23790	710	QPSK	100	LOW	Pass
3	10	23800	711	QPSK	100	LOW	Pass

BAND 26:

Mode	Bandwidth	UL Channel	Frequency	Modulation	RB Size	RB Offset	Judgement
1	15	26765	821.5	QPSK	100	LOW	Pass
2	15	26865	831.5	QPSK	100	LOW	Pass
3	15	26965	841.5	QPSK	100	LOW	Pass

BAND 38:

Mode	Bandwidth	UL Channel	Frequency	Modulation	RB Size	RB Offset	Judgement
1	20	37850	2580	QPSK	100	LOW	Pass
2	20	38000	2595	QPSK	100	LOW	Pass
3	20	38150	2610	QPSK	100	LOW	Pass



BAND 41:

Mode	Bandwidth	UL Channel	Frequency	Modulation	RB Size	RB Offset	Judgement
1	20	40340	2565.0	QPSK	100	LOW	Pass
2	20	40740	2605.0	QPSK	100	LOW	Pass
3	20	41140	2645.0	QPSK	100	LOW	Pass

BAND 66:

Mode	Bandwidth	UL Channel	Frequency	Modulation	RB Size	RB Offset	Judgement
1	20	132072	1720	QPSK	100	LOW	Pass
2	20	132422	1755	QPSK	100	LOW	Pass
3	20	132572	1770	QPSK	100	LOW	Pass

Test record:

Note:

- The substitution method is used. Substitution values at each frequency are measured before and saved to the test software. A "reference path loss" is established and the AR_{pl} is the attenuation of "reference path loss", and including the gain of receive antenna, the gain of the preamplifier, the cable loss and the air loss. The measurement results are obtained as described below:

$$\text{Power} = P_{\text{Mea}} + \text{AR}_{\text{pl}}$$

- AR_{pl} = Cable loss + Antenna gain

GSM850:

Mode 1					
Frequency(MHz)	Power(dBm)	AR _{pl} (dBm)	PMea(dBm)	Limit (dBm)	Polarity
1648.4	-53.85	0.50	-54.35	-13	Horizontal
1648.4	-54.16	0.50	-54.66	-13	Vertical
2472.6	-52.05	0.50	-52.55	-13	Horizontal
2472.6	-52.06	0.50	-52.56	-13	Vertical

Mode 2					
Frequency(MHz)	Power(dBm)	AR _{pl} (dBm)	PMea(dBm)	Limit (dBm)	Polarity
1673.2	-52.43	0.50	-52.93	-13	Horizontal
1673.2	-53.00	0.50	-53.50	-13	Vertical
2509.8	-54.60	0.50	-55.10	-13	Horizontal
2509.8	-53.05	0.50	-53.55	-13	Vertical

Mode 3					
Frequency(MHz)	Power(dBm)	AR _{pl} (dBm)	PMea(dBm)	Limit (dBm)	Polarity
1697.6	-54.17	0.50	-54.67	-13	Horizontal
1697.6	-52.59	0.50	-53.09	-13	Vertical
2546.4	-53.56	0.50	-54.06	-13	Horizontal
2546.4	-52.89	0.50	-53.39	-13	Vertical



PCS1900:

Mode 1					
Frequency(MHz)	Power(dBm)	ARpl (dBm)	PMea(dBm)	Limit (dBm)	Polarity
3700.4	-52.80	1.48	-54.28	-13	Horizontal
3700.4	-52.36	1.48	-53.84	-13	Vertical
5550.6	-54.24	1.48	-55.72	-13	Horizontal
5550.6	-53.56	1.48	-55.04	-13	Vertical

Mode 2					
Frequency(MHz)	Power(dBm)	ARpl (dBm)	PMea(dBm)	Limit (dBm)	Polarity
3760	-54.22	1.48	-55.70	-13	Horizontal
3760	-52.88	1.48	-54.36	-13	Vertical
5640	-54.56	1.48	-56.04	-13	Horizontal
5640	-54.86	1.48	-56.34	-13	Vertical

Mode 3					
Frequency(MHz)	Power(dBm)	ARpl (dBm)	PMea(dBm)	Limit (dBm)	Polarity
3819.6	-54.36	1.48	-55.84	-13	Horizontal
3819.6	-53.99	1.48	-55.47	-13	Vertical
5729.4	-52.75	1.48	-54.23	-13	Horizontal
5729.4	-52.54	1.48	-54.02	-13	Vertical

**UTRA BANDS
BAND 2:**

Mode 1					
Frequency(MHz)	Power(dBm)	ARpl (dBm)	PMea(dBm)	Limit (dBm)	Polarity
3704.8	-54.32	1.48	-55.80	-13	Horizontal
3704.8	-54.41	1.48	-55.89	-13	Vertical
5557.2	-52.28	1.48	-53.76	-13	Horizontal
5557.2	-54.17	1.48	-55.65	-13	Vertical

Mode 2					
Frequency(MHz)	Power(dBm)	ARpl (dBm)	PMea(dBm)	Limit (dBm)	Polarity
3760	-52.55	1.48	-54.03	-13	Horizontal
3760	-53.99	1.48	-55.47	-13	Vertical
5640	-54.15	1.48	-55.63	-13	Horizontal
5640	-52.26	1.48	-53.74	-13	Vertical

Mode 3					
Frequency(MHz)	Power(dBm)	ARpl (dBm)	PMea(dBm)	Limit (dBm)	Polarity
3815.2	-53.93	1.48	-55.41	-13	Horizontal
3815.2	-54.43	1.48	-55.91	-13	Vertical
5722.8	-52.52	1.48	-54.00	-13	Horizontal
5722.8	-53.03	1.48	-54.51	-13	Vertical



BAND 4:

Mode 1					
Frequency(MHz)	Power(dBm)	ARpl (dBm)	PMea(dBm)	Limit (dBm)	Polarity
3424.8	-54.01	1.47	-55.48	-13	Horizontal
3424.8	-53.75	1.47	-55.22	-13	Vertical
5137.2	-53.39	1.47	-54.86	-13	Horizontal
5137.2	-53.10	1.47	-54.57	-13	Vertical

Mode 2					
Frequency(MHz)	Power(dBm)	ARpl (dBm)	PMea(dBm)	Limit (dBm)	Polarity
3465.2	-52.01	1.47	-53.48	-13	Horizontal
3465.2	-53.43	1.47	-54.90	-13	Vertical
5197.8	-52.31	1.47	-53.78	-13	Horizontal
5197.8	-53.54	1.47	-55.01	-13	Vertical

Mode 3					
Frequency(MHz)	Power(dBm)	ARpl (dBm)	PMea(dBm)	Limit (dBm)	Polarity
3505.2	-54.74	1.47	-56.21	-13	Horizontal
3505.2	-53.57	1.47	-55.04	-13	Vertical
5257.8	-52.70	1.47	-54.17	-13	Horizontal
5257.8	-53.63	1.47	-55.10	-13	Vertical

BAND 5:

Mode 1					
Frequency(MHz)	Power(dBm)	ARpl (dBm)	PMea(dBm)	Limit (dBm)	Polarity
1652.8	-53.70	0.50	-54.20	-13	Horizontal
1652.8	-53.12	0.50	-53.62	-13	Vertical
2479.2	-54.08	0.50	-54.58	-13	Horizontal
2479.2	-53.08	0.50	-53.58	-13	Vertical

Mode 2					
Frequency(MHz)	Power(dBm)	ARpl (dBm)	PMea(dBm)	Limit (dBm)	Polarity
1672.8	-53.79	0.50	-54.29	-13	Horizontal
1672.8	-53.41	0.50	-53.91	-13	Vertical
2509.2	-53.79	0.50	-54.29	-13	Horizontal
2509.2	-52.47	0.50	-52.97	-13	Vertical

Mode 3					
Frequency(MHz)	Power(dBm)	ARpl (dBm)	PMea(dBm)	Limit (dBm)	Polarity
1693.2	-53.18	0.50	-53.68	-13	Horizontal
1693.2	-53.08	0.50	-53.58	-13	Vertical
2539.8	-53.73	0.50	-54.23	-13	Horizontal
2539.8	-52.75	0.50	-53.25	-13	Vertical





E-UTRA BANDS BAND 2:

Mode 1					
Frequency(MHz)	Power(dBm)	ARpl (dBm)	PMea(dBm)	Limit (dBm)	Polarity
3720	-60.16	1.51	-60.66	-13	Horizontal
3720	-53.51	1.51	-54.01	-13	Vertical
5580	-59.10	1.51	-59.60	-13	Horizontal
5580	-60.10	1.51	-60.60	-13	Vertical

Mode 2					
Frequency(MHz)	Power(dBm)	ARpl (dBm)	PMea(dBm)	Limit (dBm)	Polarity
3760	-59.74	1.51	-60.24	-13	Horizontal
3760	-54.23	1.51	-54.73	-13	Vertical
5640	-59.79	1.51	-60.29	-13	Horizontal
5640	-61.45	1.51	-61.95	-13	Vertical

Mode 3					
Frequency(MHz)	Power(dBm)	ARpl (dBm)	PMea(dBm)	Limit (dBm)	Polarity
3800	-61.81	1.51	-62.31	-13	Horizontal
3800	-54.50	1.51	-55.00	-13	Vertical
5700	-59.34	1.51	-59.84	-13	Horizontal
5700	-60.29	1.51	-60.79	-13	Vertical

BAND 4:

Mode 1					
Frequency(MHz)	Power(dBm)	ARpl (dBm)	PMea(dBm)	Limit (dBm)	Polarity
3440	-59.97	1.50	-60.47	-13	Horizontal
3440	-52.02	1.50	-52.52	-13	Vertical
5160	-61.55	1.50	-62.05	-13	Horizontal
5160	-60.03	1.50	-60.53	-13	Vertical

Mode 2					
Frequency(MHz)	Power(dBm)	ARpl (dBm)	PMea(dBm)	Limit (dBm)	Polarity
3465	-60.55	1.50	-61.45	-13	Horizontal
3465	-60.29	1.50	-59.73	-13	Vertical
5197.5	-60.46	1.50	-61.98	-13	Horizontal
5197.5	-61.32	1.50	-60.14	-13	Vertical

Mode 3					
Frequency(MHz)	Power(dBm)	ARpl (dBm)	PMea(dBm)	Limit (dBm)	Polarity
3490	-60.49	1.50	-60.52	-13	Horizontal
3490	-60.12	1.50	-61.97	-13	Vertical
5235	-61.28	1.50	-59.91	-13	Horizontal
5235	-61.69	1.50	-61.01	-13	Vertical



BAND 5:

Mode 1					
Frequency(MHz)	Power(dBm)	ARpl (dBm)	PMea(dBm)	Limit (dBm)	Polarity
1658	-54.89	0.50	-55.39	-13	Horizontal
1658	-52.68	0.50	-53.18	-13	Vertical
2487	-54.61	0.50	-55.11	-13	Horizontal
2487	-53.28	0.50	-53.78	-13	Vertical

Mode 2					
Frequency(MHz)	Power(dBm)	ARpl (dBm)	PMea(dBm)	Limit (dBm)	Polarity
1673	-53.95	0.50	-54.45	-13	Horizontal
1673	-54.69	0.50	-55.19	-13	Vertical
2509.5	-52.24	0.50	-52.74	-13	Horizontal
2509.5	-53.63	0.50	-54.13	-13	Vertical

Mode 3					
Frequency(MHz)	Power(dBm)	ARpl (dBm)	PMea(dBm)	Limit (dBm)	Polarity
1688	-54.11	0.50	-54.61	-13	Horizontal
1688	-54.58	0.50	-55.08	-13	Vertical
2532	-52.45	0.50	-52.95	-13	Horizontal
2532	-54.62	0.50	-55.12	-13	Vertical

BAND 7:

Mode 1					
Frequency(MHz)	Power(dBm)	ARpl(dBm)	PMea(dBm)	Limit (dBm)	Polarity
5020	-60.97	1.40	-61.47	-25	Horizontal
5020	-52.15	1.40	-52.65	-25	Vertical
7530	-60.20	1.40	-60.70	-25	Horizontal
7530	-60.48	1.40	-60.98	-25	Vertical

Mode 2					
Frequency(MHz)	Power(dBm)	ARpl(dBm)	PMea(dBm)	Limit (dBm)	Polarity
5070	-60.33	1.40	-60.83	-25	Horizontal
5070	-53.27	1.40	-53.77	-25	Vertical
7605	-59.81	1.40	-60.31	-25	Horizontal
7605	-59.26	1.40	-59.76	-25	Vertical

Mode 3					
Frequency(MHz)	Power(dBm)	ARpl(dBm)	PMea(dBm)	Limit (dBm)	Polarity
5120	-61.44	1.40	-61.94	-25	Horizontal
5120	-54.62	1.40	-55.12	-25	Vertical
7680	-60.28	1.40	-60.78	-25	Horizontal
7680	-61.81	1.40	-62.31	-25	Vertical



BAND 12:

Mode 1					
Frequency(MHz)	Power(dBm)	ARpl (dBm)	PMea(dBm)	Limit (dBm)	Polarity
1,408	-59.73	1.46	-60.23	-13	Horizontal
1,408	-54.35	1.46	-54.85	-13	Vertical
2,112	-59.21	1.46	-59.71	-13	Horizontal
2,112	-60.84	1.46	-61.34	-13	Vertical

Mode 2					
Frequency(MHz)	Power(dBm)	ARpl (dBm)	PMea(dBm)	Limit (dBm)	Polarity
1,415	-59.87	1.46	-60.37	-13	Horizontal
1,415	-54.28	1.46	-54.78	-13	Vertical
2,122.5	-59.79	1.46	-60.29	-13	Horizontal
2,122.5	-61.35	1.46	-61.85	-13	Vertical

Mode 3					
Frequency(MHz)	Power(dBm)	ARpl (dBm)	PMea(dBm)	Limit (dBm)	Polarity
1,422	-60.79	1.46	-61.29	-13	Horizontal
1,422	-54.95	1.46	-55.45	-13	Vertical
2,133	-60.10	1.46	-60.60	-13	Horizontal
2,133	-60.87	1.46	-61.37	-13	Vertical

BAND 17:

Mode 1					
Frequency(MHz)	Power(dBm)	ARpl (dBm)	PMea(dBm)	Limit (dBm)	Polarity
1,418	-59.01	1.45	-59.51	-13	Horizontal
1,418	-52.80	1.45	-53.30	-13	Vertical
2,127	-61.26	1.45	-61.76	-13	Horizontal
2,127	-61.89	1.45	-62.39	-13	Vertical

Mode 2					
Frequency(MHz)	Power(dBm)	ARpl (dBm)	PMea(dBm)	Limit (dBm)	Polarity
1,420	-59.63	1.45	-60.13	-13	Horizontal
1,420	-53.75	1.45	-54.25	-13	Vertical
2,130	-61.70	1.45	-62.20	-13	Horizontal
2,130	-60.60	1.45	-61.10	-13	Vertical

Mode 3					
Frequency(MHz)	Power(dBm)	ARpl (dBm)	PMea(dBm)	Limit (dBm)	Polarity
1,422	-59.61	1.45	-60.11	-13	Horizontal
1,422	-54.58	1.45	-55.08	-13	Vertical
2,133	-59.52	1.45	-60.02	-13	Horizontal
2,133	-60.27	1.45	-60.77	-13	Vertical



BAND 26:

Mode 1					
Frequency(MHz)	Power(dBm)	ARpl (dBm)	PMea(dBm)	Limit (dBm)	Polarity
1,643	-59.91	1.35	-60.41	-13	Horizontal
1,643	-53.39	1.35	-53.89	-13	Vertical
2,464.5	-60.15	1.35	-60.65	-13	Horizontal
2,464.5	-59.07	1.35	-59.57	-13	Vertical

Mode 2					
Frequency(MHz)	Power(dBm)	ARpl (dBm)	PMea(dBm)	Limit (dBm)	Polarity
1,663	-59.85	1.35	-60.35	-13	Horizontal
1,663	-54.80	1.35	-55.30	-13	Vertical
2,494.5	-61.78	1.35	-62.28	-13	Horizontal
2,494.5	-59.19	1.35	-59.69	-13	Vertical

Mode 3					
Frequency(MHz)	Power(dBm)	ARpl (dBm)	PMea(dBm)	Limit (dBm)	Polarity
1,683	-59.66	1.35	-60.16	-13	Horizontal
1,683	-54.10	1.35	-54.60	-13	Vertical
2,524.5	-60.24	1.35	-60.74	-13	Horizontal
2,524.5	-60.39	1.35	-60.89	-13	Vertical

BAND 38:

Mode 1					
Frequency(MHz)	Power(dBm)	ARpl(dBm)	PMea(dBm)	Limit (dBm)	Polarity
5160	-60.86	1.52	-61.36	-25	Horizontal
5160	-54.75	1.52	-55.25	-25	Vertical
7740	-59.92	1.52	-60.42	-25	Horizontal
7740	-59.02	1.52	-59.52	-25	Vertical

Mode 2					
Frequency(MHz)	Power(dBm)	ARpl(dBm)	PMea(dBm)	Limit (dBm)	Polarity
5190	-59.77	1.52	-60.27	-25	Horizontal
5190	-53.33	1.52	-53.83	-25	Vertical
7785	-61.89	1.52	-62.39	-25	Horizontal
7785	-60.44	1.52	-60.94	-25	Vertical

Mode 3					
Frequency(MHz)	Power(dBm)	ARpl(dBm)	PMea(dBm)	Limit (dBm)	Polarity
5220	-60.14	1.52	-60.64	-25	Horizontal
5220	-53.75	1.52	-54.25	-25	Vertical
7380	-59.15	1.52	-59.65	-25	Horizontal
7380	-59.79	1.52	-60.29	-25	Vertical



BAND 41:

Mode 1					
Frequency(MHz)	Power(dBm)	ARpl(dBm)	PMea(dBm)	Limit (dBm)	Polarity
5130	-61.28	1.32	-61.78	-25	Horizontal
5130	-53.12	1.32	-53.62	-25	Vertical
7695	-60.17	1.32	-60.67	-25	Horizontal
7695	-59.32	1.32	-59.82	-25	Vertical

Mode 2					
Frequency(MHz)	Power(dBm)	ARpl(dBm)	PMea(dBm)	Limit (dBm)	Polarity
5210	-61.28	1.32	-61.78	-25	Horizontal
5210	-53.12	1.32	-53.62	-25	Vertical
7815	-60.17	1.32	-60.67	-25	Horizontal
7815	-59.32	1.32	-59.82	-25	Vertical

Mode 3					
Frequency(MHz)	Power(dBm)	ARpl(dBm)	PMea(dBm)	Limit (dBm)	Polarity
5290	-61.89	1.32	-62.39	-25	Horizontal
5290	-52.29	1.32	-52.79	-25	Vertical
7935	-60.14	1.32	-60.64	-25	Horizontal
7935	-59.06	1.32	-59.56	-25	Vertical

BAND 66:

Mode 1					
Frequency(MHz)	Power(dBm)	ARpl (dBm)	PMea(dBm)	Limit (dBm)	Polarity
3,440	-59.29	1.25	-59.79	-13	Horizontal
3,440	-52.91	1.25	-53.41	-13	Vertical
5,160	-61.22	1.25	-61.72	-13	Horizontal
5,160	-59.95	1.25	-60.45	-13	Vertical

Mode 2					
Frequency(MHz)	Power(dBm)	ARpl (dBm)	PMea(dBm)	Limit (dBm)	Polarity
3,510	-61.53	1.25	-62.03	-13	Horizontal
3,510	-54.77	1.25	-55.27	-13	Vertical
5,265	-60.17	1.25	-60.67	-13	Horizontal
5,265	-59.28	1.25	-59.78	-13	Vertical

Mode 3					
Frequency(MHz)	Power(dBm)	ARpl (dBm)	PMea(dBm)	Limit (dBm)	Polarity
3,540	-59.09	1.25	-59.59	-13	Horizontal
3,540	-53.00	1.25	-53.50	-13	Vertical
5,310	-59.60	1.25	-60.10	-13	Horizontal
5,310	-59.30	1.25	-59.80	-13	Vertical





8. OCCUPIED BANDWIDTH & Emission Bandwidth

Test limit:

The occupied bandwidth (OBW), that is the frequency bandwidth such that, below its lower and above its upper frequency limits, the mean powers radiated are each equal to 0.5 percent of the total mean power radiated by a given emission, shall be measured when modulated by an input signal such that its amplitude and symbol rate represent the maximum rated conditions under which the equipment will be operated. The signal shall be applied through any filter networks, pseudo-random generators or other devices required in normal service. Additionally, the occupied bandwidth shall be shown for operation with any devices used for modifying the spectrum when such devices are optional at the discretion of the user. [i]2.1049(h)]

Many of the individual rule parts specify a relative OBW in lieu of the 99% OBW. In such cases, the OBW is defined as the width of the signal between two points, one below the carrier center frequency and one above the carrier center frequency, outside of which all emissions are attenuated by at least X dB below the transmitter power, where the value of X is typically specified as 26.

The relative OBW must be measured and reported when it is specified in the applicable rule part; otherwise, the 99% OBW shall be measured and reported. The test report shall specify which OBW is reported.

A spectrum/signal analyzer or other instrument providing a spectral display is recommended for these measurements and the video bandwidth shall be set to a value at least three times greater than the IF/resolution bandwidth to avoid any amplitude smoothing. Video filtering shall not be used during occupied bandwidth tests.

The OBW shall be measured for all operating conditions that will affect the bandwidth results (e.g. variable modulations, coding, or channel bandwidth settings). See section 4.

Test procedure:

Occupied bandwidth – relative measurement procedure

The reference value is the highest level of the spectral envelope of the modulated signal.

- a) The spectrum analyzer center frequency is set to the nominal EUT channel center frequency. The span range for the spectrum analyzer shall be between two and five times the anticipated OBW.
- b) The nominal resolution bandwidth (RBW) shall be in the range of 1 to 5 % of the anticipated OBW, and the VBW shall be at least 3 times the RBW.
- c) Set the reference level of the instrument as required to prevent the signal from exceeding the maximum input mixer level for linear operation. In general, the peak of the spectral envelope must be at least $10 \log (OBW / RBW)$ below the reference level.
- d) NOTE—Steps a) through c) may require iteration to adjust within the specified tolerances.
- e) The dynamic range of the spectrum analyzer at the selected RBW shall be at least 10 dB below the target “-X dB down” requirement (i.e., if the requirement calls for measuring the -26 dB OBW, the spectrum analyzer noise floor at the selected RBW shall be at least 36 dB below the reference value).
- f) Set the detection mode to peak, and the trace mode to max hold.
- g) Determine the reference value: Set the EUT to transmit a modulated signal. Allow the trace to stabilize. Set the spectrum analyzer marker to the highest level of the displayed trace (this is the reference value).
- h) Determine the “-X dB down amplitude” as equal to (Reference Value – X). Alternatively, this calculation can be performed by the analyzer by using the marker-delta function.



i) Place two markers, one at the lowest and the other at the highest frequency of the envelope of the spectral display such that each marker is at or slightly below the “-X dB down amplitude” determined in step g). If a marker is below this “-X dB down amplitude” value it shall be placed as close as possible to this value. The OBW is the positive frequency difference between the two markers.

j) The occupied bandwidth shall be reported by providing plot(s) of the measuring instrument display. The frequency and amplitude axes and scale shall be clearly labeled. Tabular data may be reported in addition to the plot(s).

Occupied bandwidth – power bandwidth (99%) measurement procedure

The following procedure shall be used for measuring (99 %) power bandwidth

a) The spectrum analyzer center frequency is set to the nominal EUT channel center frequency. The frequency span for the spectrum analyzer shall be set wide enough to capture all modulation products including the emission skirts (i.e., two to five times the OBW).

b) The nominal IF filter bandwidth (3 dB RBW) shall be in the range of 1 to 5 % of the anticipated OBW, and the VBW shall be at least 3 times the RBW.

c) Set the reference level of the instrument as required to keep the signal from exceeding the maximum input mixer level for linear operation. In general, the peak of the spectral envelope must be at least $10\log(OBW / RBW)$ below the reference level.

d) NOTE—Steps a) through c) may require iteration to adjust within the specified tolerances.

e) Set the detection mode to peak, and the trace mode to max hold..

f) Use the 99 % power bandwidth function of the spectrum analyzer (if available) and report the measured bandwidth.

g) If the instrument does not have a 99 % power bandwidth function, the trace data points are to be recovered and directly summed in linear power terms. The recovered amplitude data points, beginning at the lowest frequency, are placed in a running sum until 0.5 % of the total is reached; that frequency is recorded as the lower frequency. The process is repeated until 99.5 % of the total is reached; that frequency is recorded as the upper frequency. The 99 % power bandwidth is the difference between these two frequencies.

h) The OBW shall be reported by providing plot(s) of the measuring instrument display. The frequency and amplitude axes and scale shall be clearly labeled. Tabular data may be reported in addition to the plot(s).

Test setup:

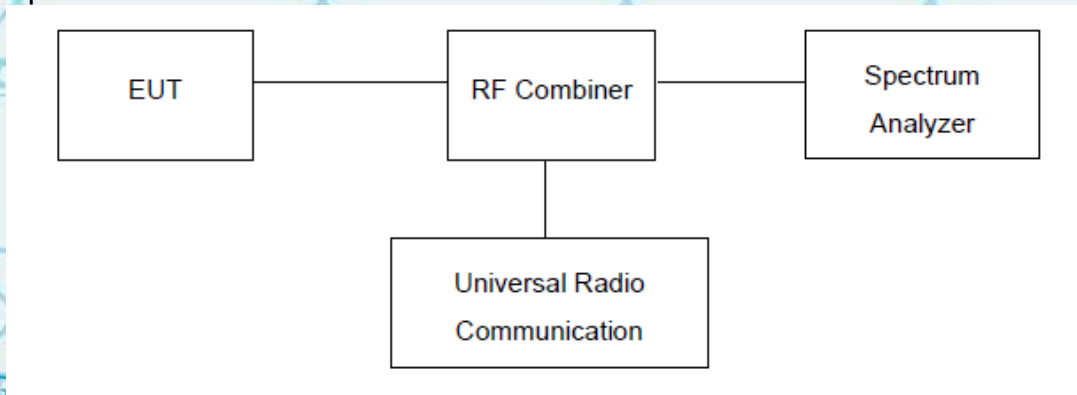



Measurement Result

850(GSM):

Frequency	OBW(99%)	26dB BW
824.2	241.987KHz	824.041MHz
836.6	241.987KHz	318.910KHz
848.8	243.590KHz	848.641MHz

850(GPRS):

Frequency	OBW(99%)	26dB BW
824.2	241.987KHz	824.041MHz
836.6	243.590KHz	318.910KHz
848.8	243.590KHz	315.705KHz

850(EGPRS):

Frequency	OBW(99%)	26dB BW
824.2	243.590KHz	824.040MHz
836.6	241.987KHz	836.453MHz
848.8	246.795KHz	315.705KHz





1900(PCS):

Frequency	OBW(99%)	26dB BW
1850.2	246.795KHz	1.850GHz
1880	245.192KHz	1.880GHz
1909.8	243.590KHz	315.705KHz

1900(GPRS):

Frequency	OBW(99%)	26dB BW
1850.2	243.590KHz	317.308KHz
1880	241.987KHz	1.880GHz
1909.8	245.192KHz	315.705KHz

1900(EGPRS):

Frequency	OBW(99%)	26dB BW
1850.2	243.590KHz	1.850GHz
1880	241.987KHz	320.512KHz
1909.8	243.590KHz	1.910GHz

WCDMA BAND II

Frequency	OBW(99%)	26dB BW
1852.6	4.167MHz	1.850GHz
1880	4.167MHz	4.679MHz
1909.8	4.167MHz	1.905GHz

WCDMA BAND IV

Frequency	OBW(99%)	26dB BW
1850.2	4.167MHz	1.710GHz
1880	4.167MHz	4.680MHz
1909.8	4.167MHz	1.750GHz





WCDMA BAND V

Frequency	OBW(99%)	26dB BW
1850.2	4.167MHz	4.760MHz
1880	4.151MHz	4.680MHz
1909.8	4.167MHz	824.061MHz





Report No.: WSCT-A2LA-R&E24020007A-RF

Certificate #5768.01

For Question, Please Contact with WSCT www.wsct-cert.com

Test Plot (Worst)

Occupied Bandwidth (99% and -26dBc) 850(GSM) BAND CH 128

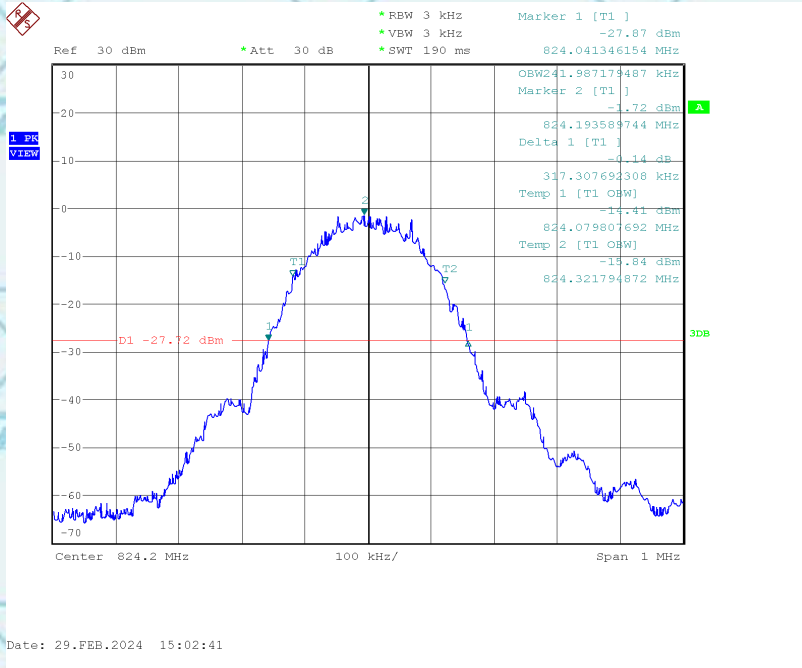



Report No.: WSCT-A2LA-R&E24020007A-RF

Certificate #5768.01

For Question,
Please Contact with WSCT
www.wsct-cert.com

Occupied Bandwidth (99% and -26dBc) 850(GSM) BAND CH 190

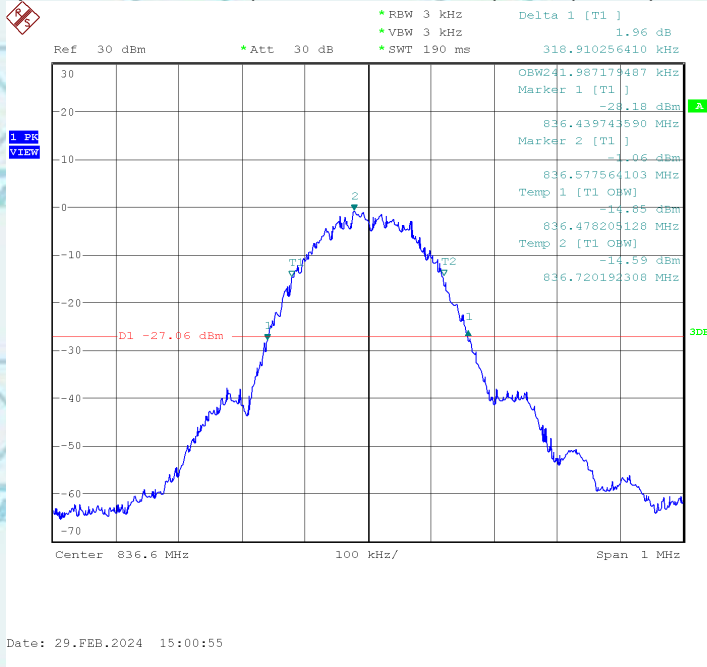

Occupied Bandwidth (99% and -26dBc) 850(GSM) BAND CH 251

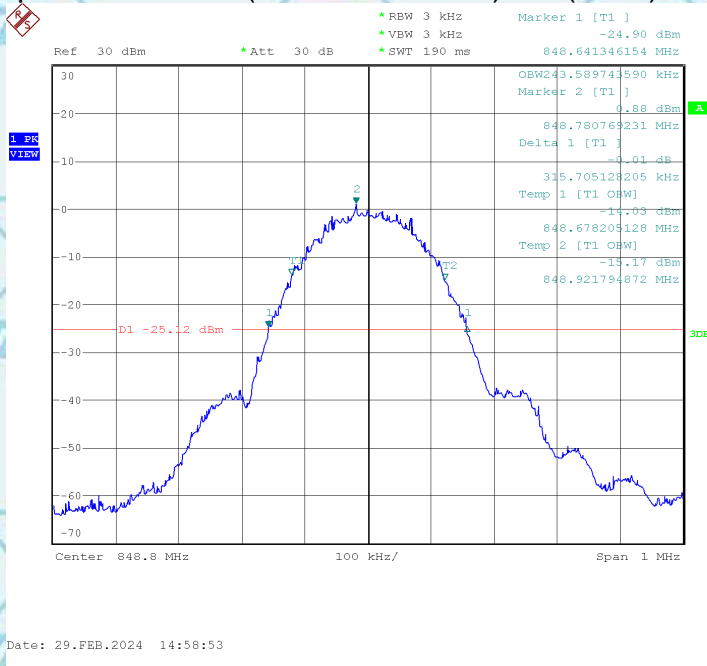



Occupied Bandwidth (99% and -26dBc) 850(GPRS) CH 128

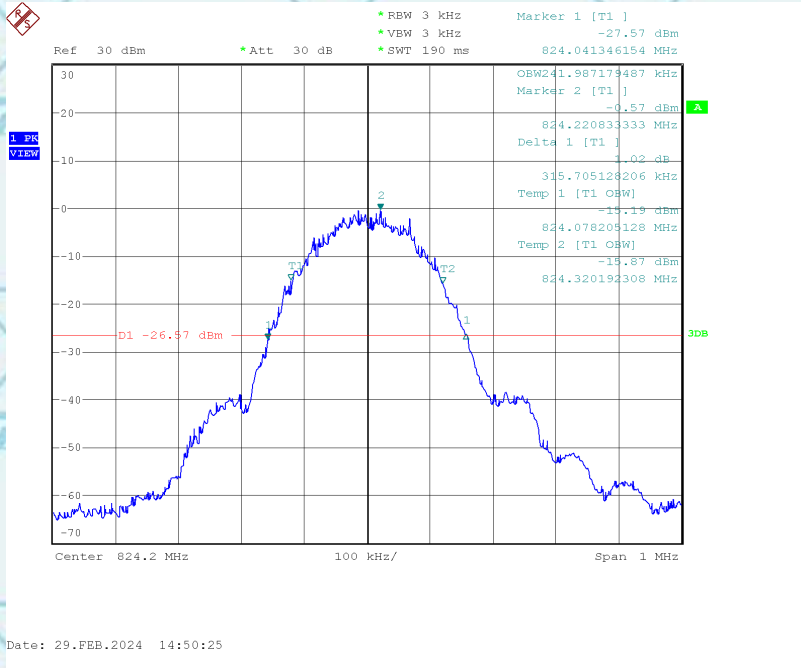



Report No.: WSCT-A2LA-R&E24020007A-RF

Certificate #5768.01

For Question, Please Contact with WSCT www.wsct-cert.com

Occupied Bandwidth (99% and -26dBc) 850(GPRS) CH 190

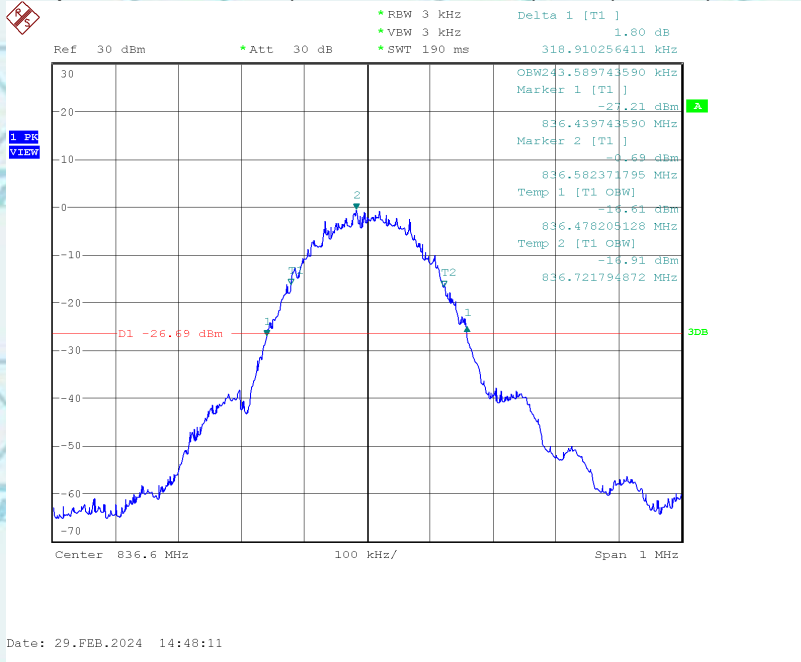

Occupied Bandwidth (99% and -26dBc) 850(GPRS) CH 251

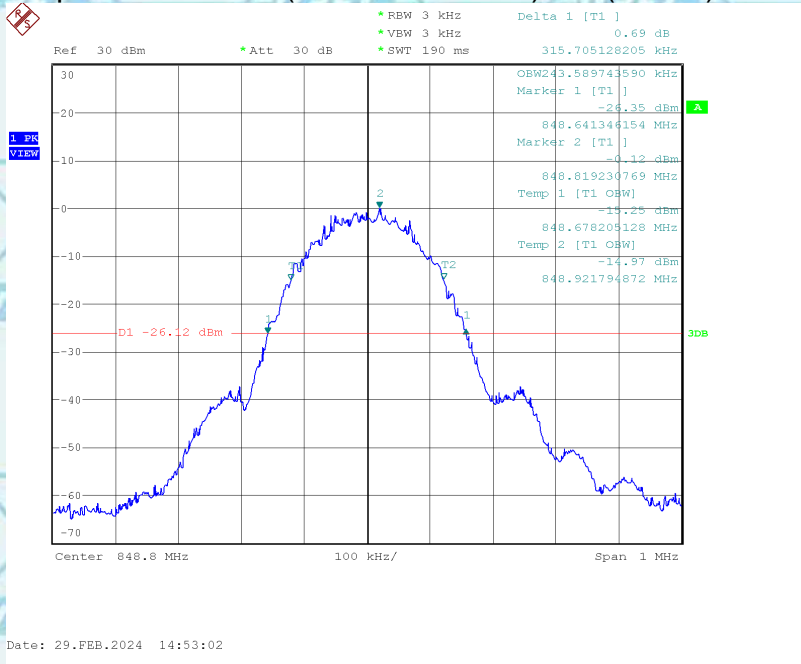



Report No.: WSCT-A2LA-R&E24020007A-RF

Certificate #5768.01

For Question, Please Contact with WSCT www.wsct-cert.com

Occupied Bandwidth (99% and -26dBc) 850(EGPRS) CH 128

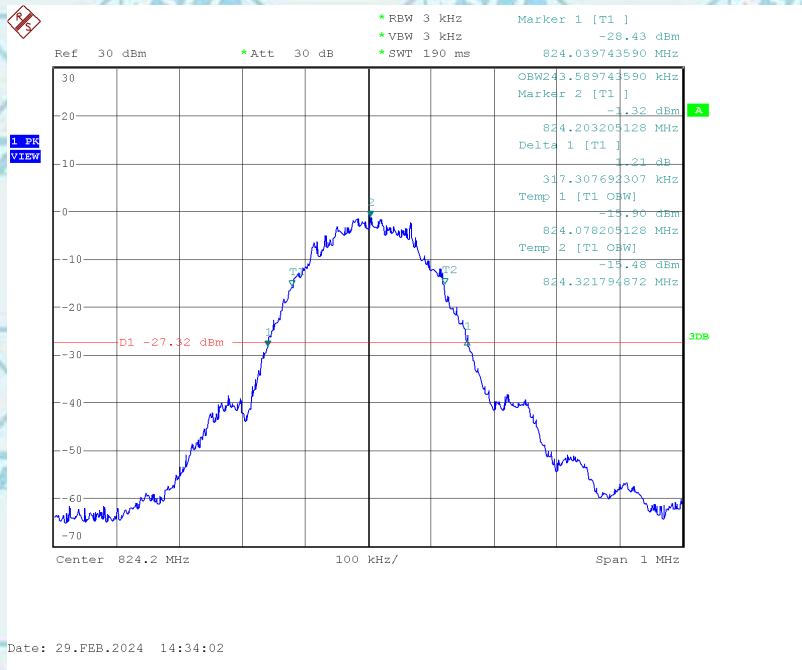

Occupied Bandwidth (99% and -26dBc) 850(EGPRS) CH 190

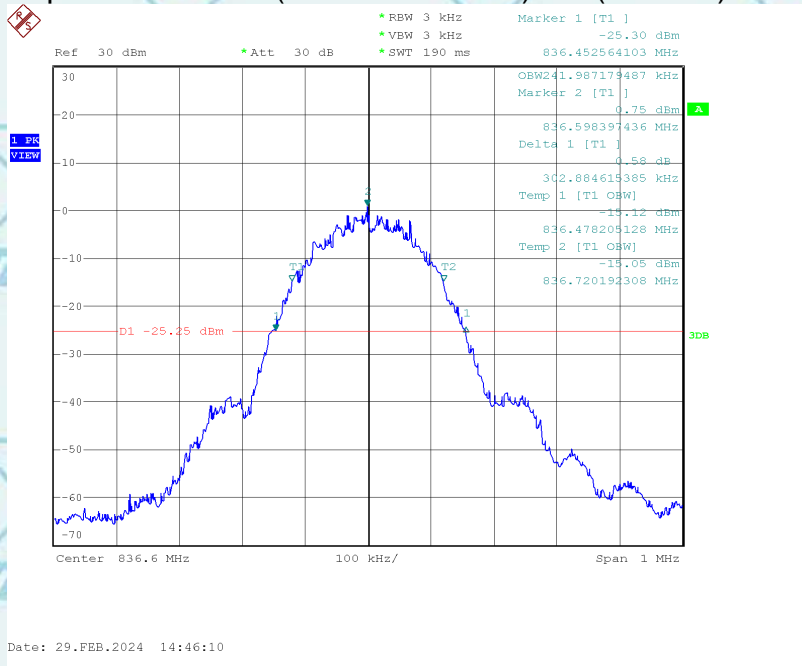



Report No.: WSCT-A2LA-R&E24020007A-RF

Certificate #5768.01

For Question, Please Contact with WSCT www.wsct-cert.com

Occupied Bandwidth (99% and -26dBc) 850(EGPRS) CH 251

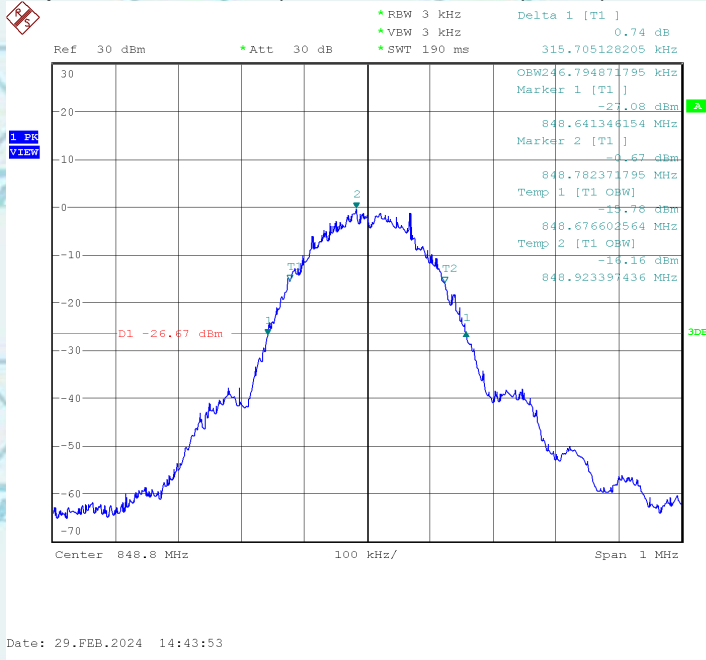

世标检测认证股份

ADD: Building A-B Baoshi Science & Technology Park, Baoshi Road, Bao'an District, Shenzhen, Guangdong, China
 TEL: 86-755-26990192 26992300 FAX: 86-755-86376605 E-mail: Fengbing.Wang@wsct-cert.com Http: www.wsct-cert.com

Member of the WSCT INC



Occupied Bandwidth (99% and -26dBc) 1900(PCS) CH 512

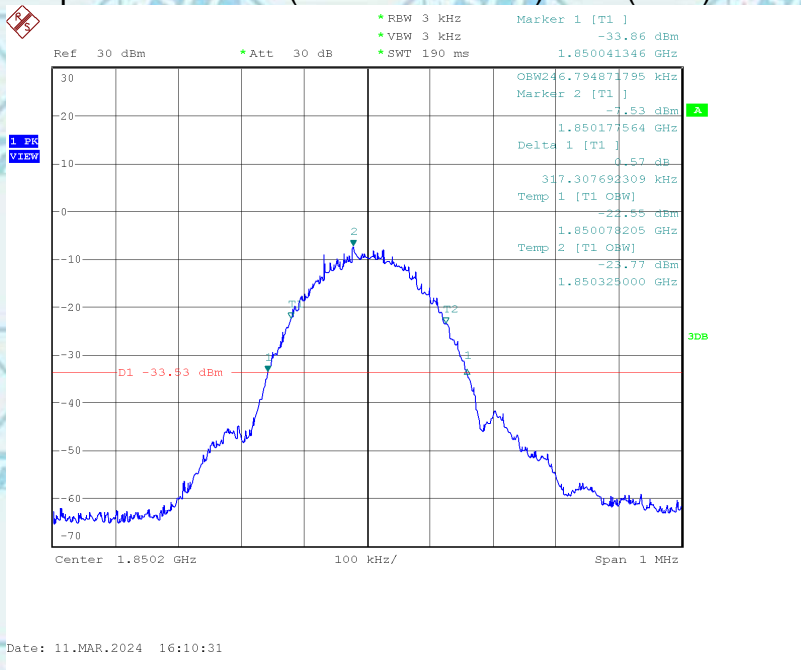

Occupied Bandwidth (99% and -26dBc) 1900(PCS) CH 661

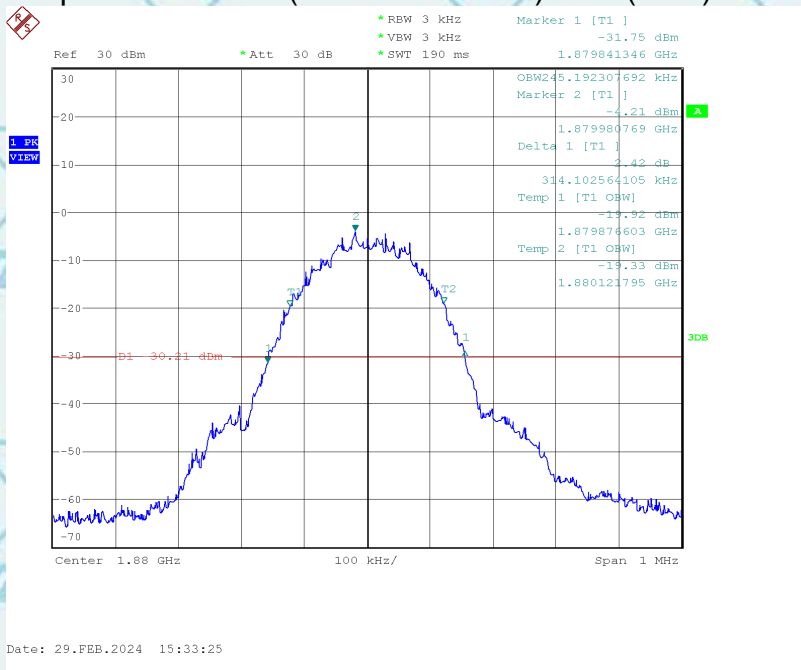



Report No.: WSCT-A2LA-R&E24020007A-RF

Certificate #5768.01

For Question, Please Contact with WSCT www.wsct-cert.com

Occupied Bandwidth (99% and -26dBc) 1900(PCS) CH 810

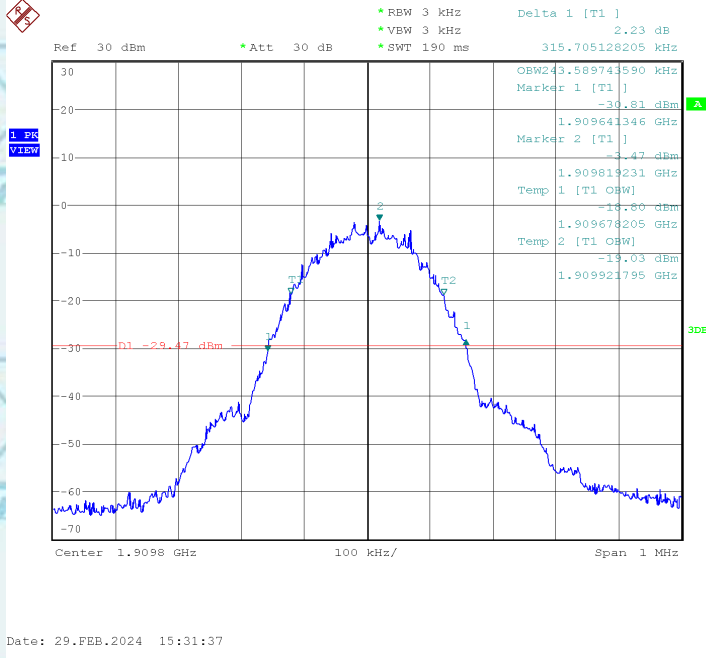

Occupied Bandwidth (99% and -26dBc) 1900(GPRS) CH 512

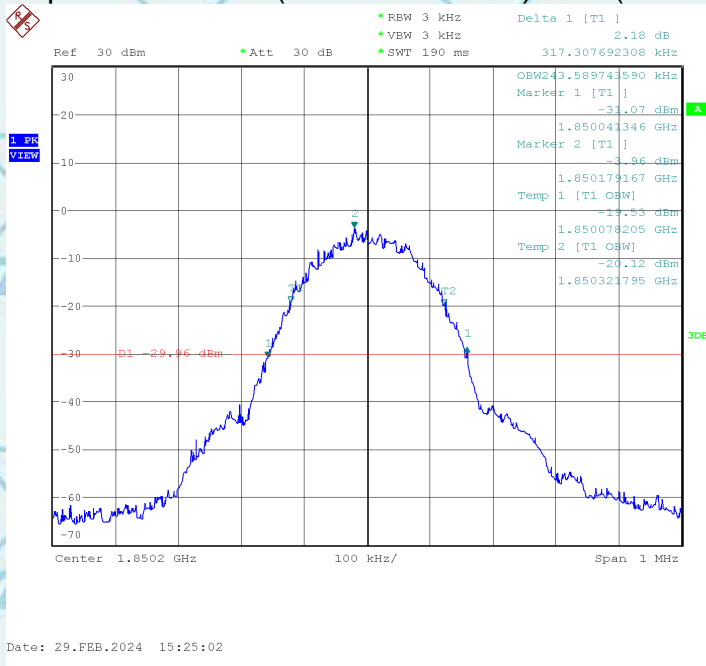



Report No.: WSCT-A2LA-R&E24020007A-RF

Certificate #5768.01

For Question, Please Contact with WSCT www.wsct-cert.com

Occupied Bandwidth (99% and -26dBc) 1900(GPRS) CH 661

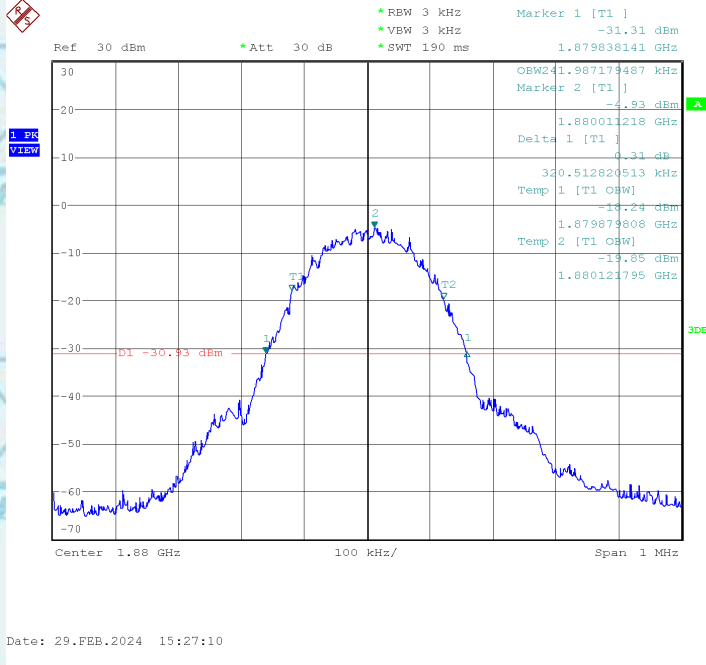

Occupied Bandwidth (99% and -26dBc) 1900(GPRS) CH 810

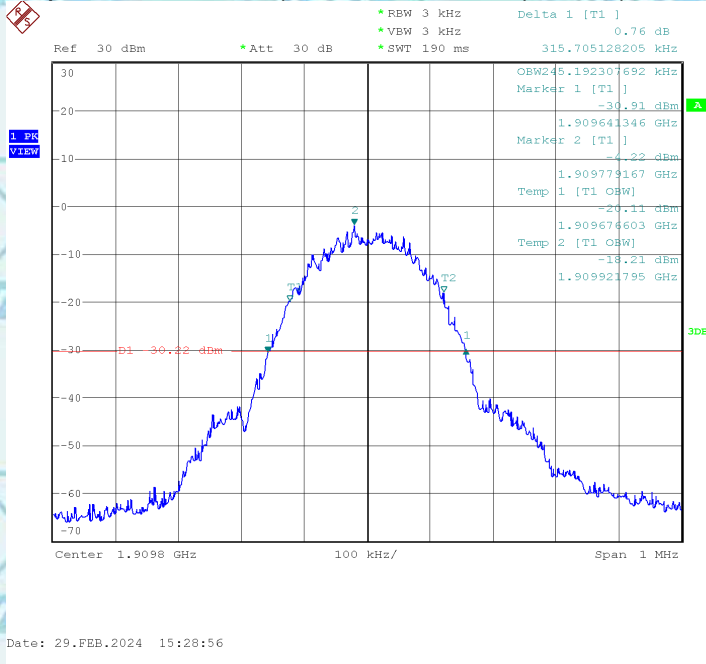



Report No.: WSCT-A2LA-R&E24020007A-RF

Certificate #5768.01

For Question, Please Contact with WSCT www.wsct-cert.com

Occupied Bandwidth (99% and -26dBc) 1900(EGPRS) CH 512

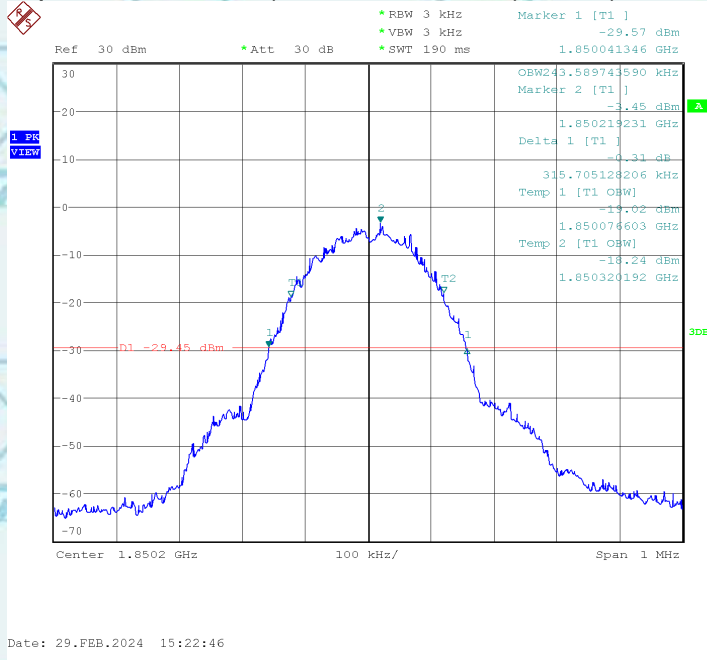

Occupied Bandwidth (99% and -26dBc) 1900(EGPRS) CH 661

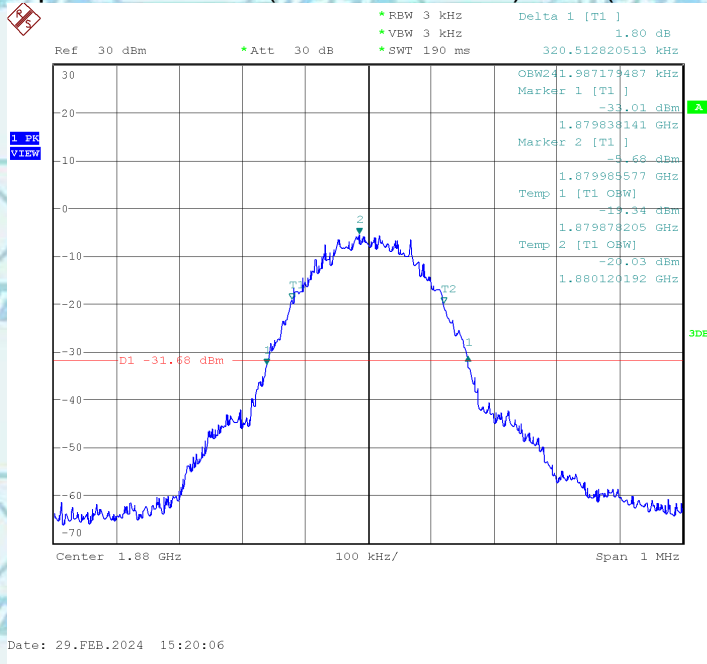



Report No.: WSCT-A2LA-R&E24020007A-RF

Certificate #5768.01

For Question, Please Contact with WSCT www.wsct-cert.com

Occupied Bandwidth (99% and -26dBc) 1900(EGPRS) CH 810

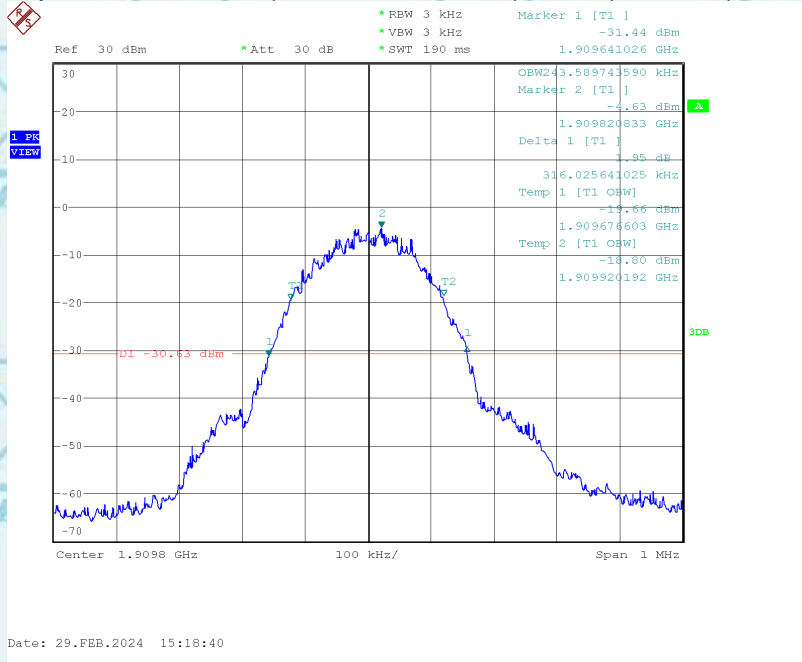

UTRA BANDS

Occupied Bandwidth (99% and -26dBc) WCDMA BAND II CH 9262

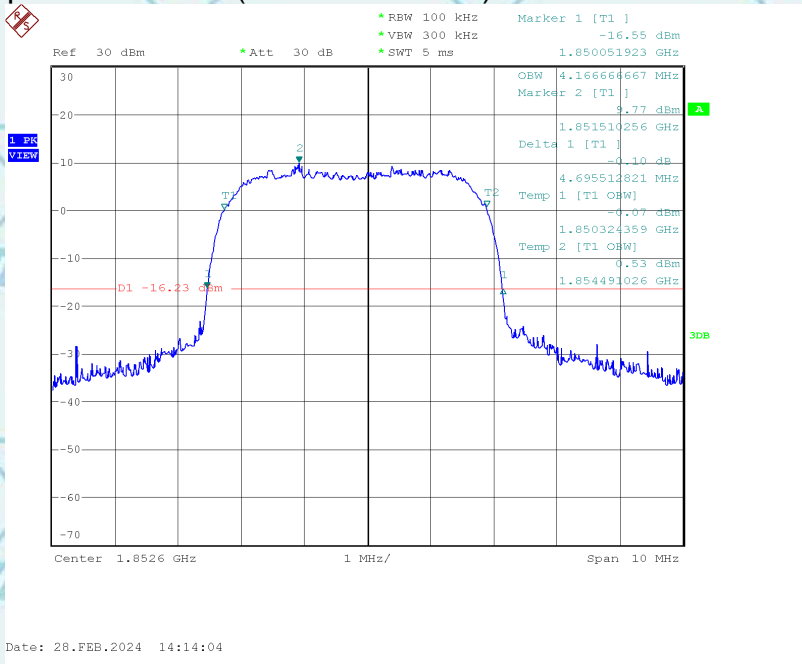



Report No.: WSCT-A2LA-R&E24020007A-RF

Certificate #5768.01

For Question, Please Contact with WSCT www.wsct-cert.com

Occupied Bandwidth (99%and-26dBc) WCDMA BAND II CH 9400

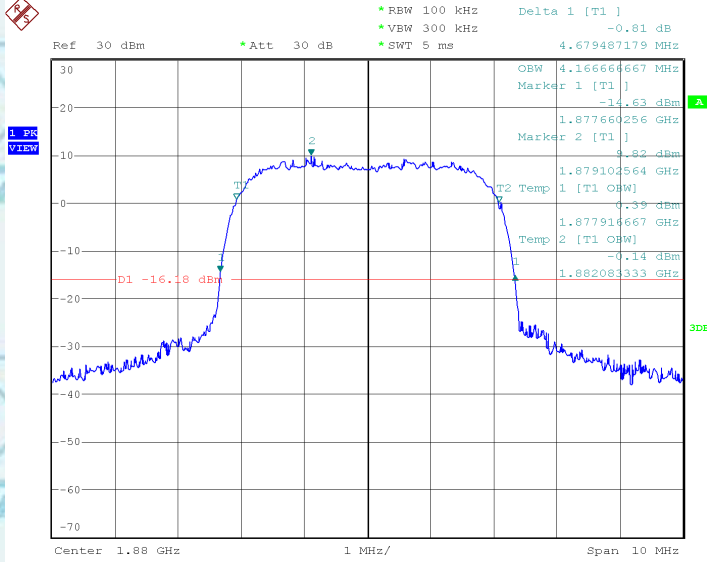

Date: 28.FEB.2024 14:12:05

Occupied Bandwidth (99%and-26dBc) WCDMA BAND II CH 9538

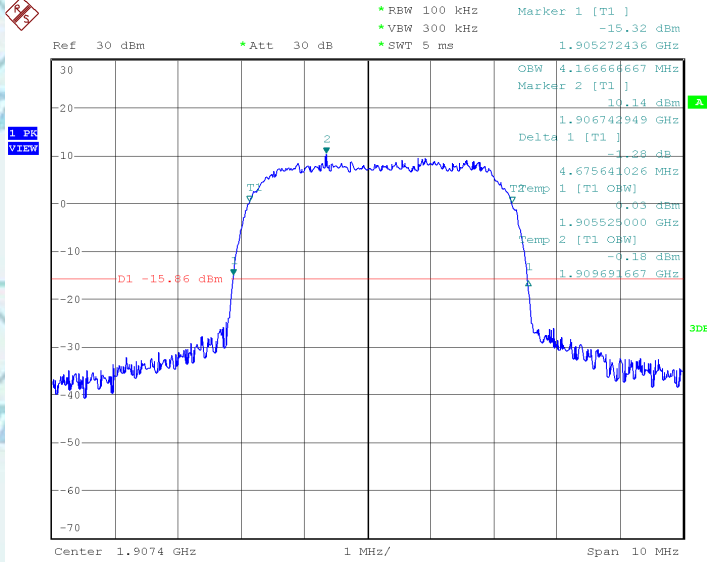

Date: 28.FEB.2024 14:09:10





Report No.: WSCT-A2LA-R&E24020007A-RF

Certificate #5768.01

For Question, Please Contact with WSCT www.wsct-cert.com

Occupied Bandwidth (99% and -26dBc) WCDMA BAND IV CH 1312

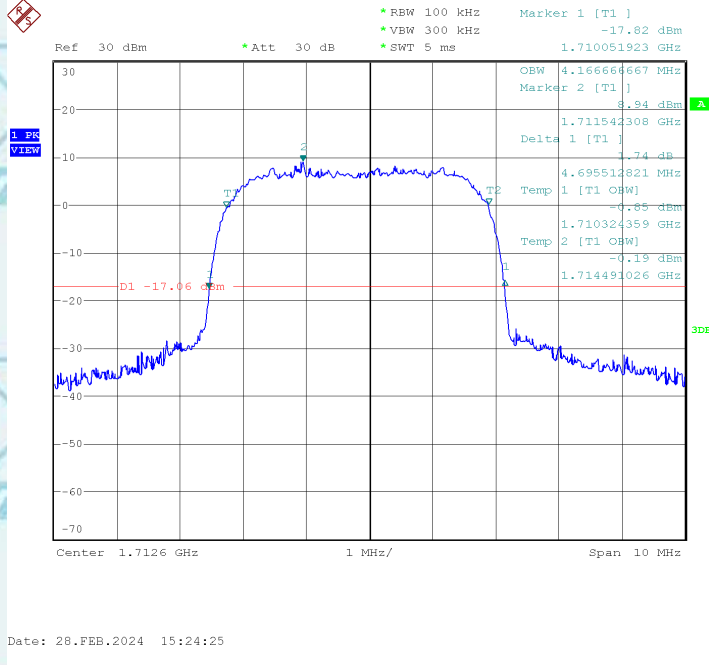

Occupied Bandwidth (99% and -26dBc) WCDMA BAND IV CH 1413

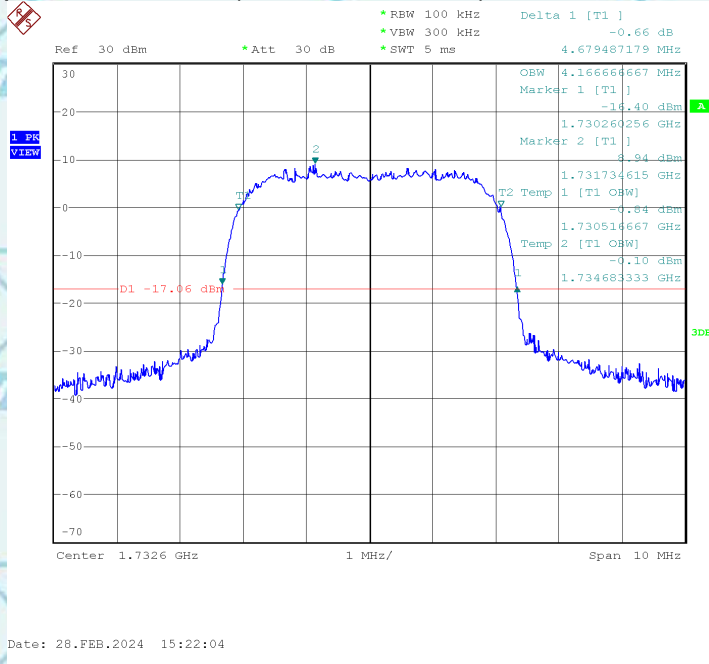



Report No.: WSCT-A2LA-R&E24020007A-RF

Certificate #5768.01

For Question, Please Contact with WSCT
www.wsct-cert.com

Occupied Bandwidth (99% and -26dBc) WCDMA BAND IV CH 1513

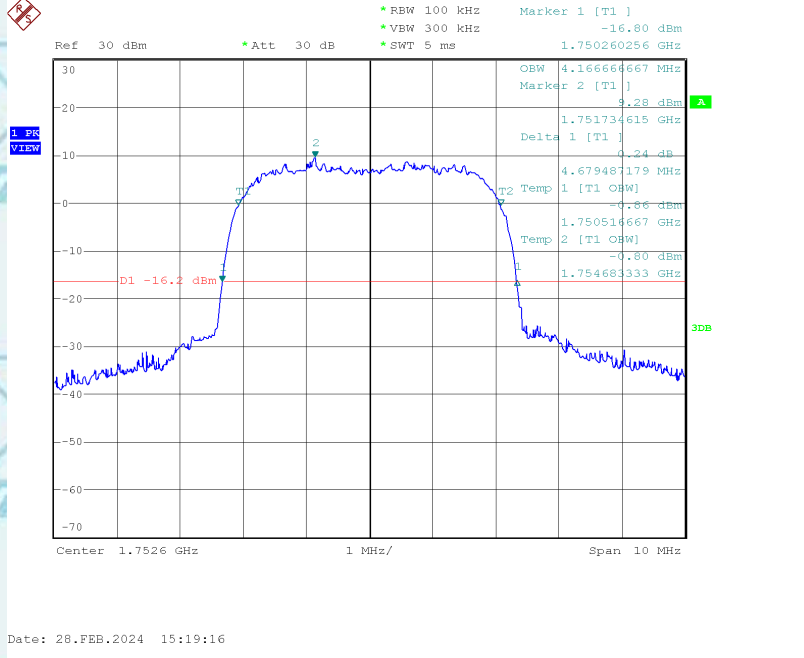

Occupied Bandwidth (99% and -26dBc) WCDMA BAND V CH 4132

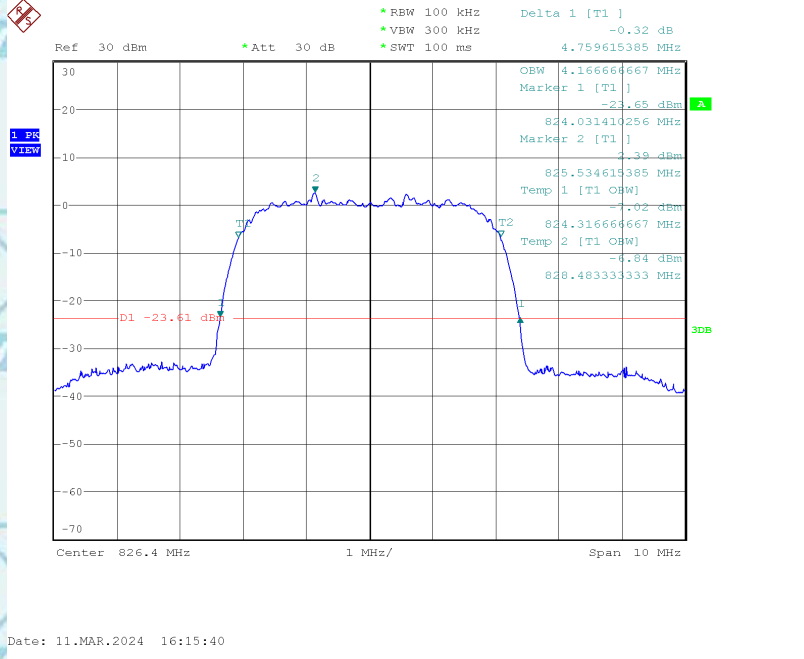



Report No.: WSCT-A2LA-R&E24020007A-RF

Certificate #5768.01

For Question, Please Contact with WSCT www.wsct-cert.com

Occupied Bandwidth (99%and-26dBc) WCDMA BAND V CH 4182

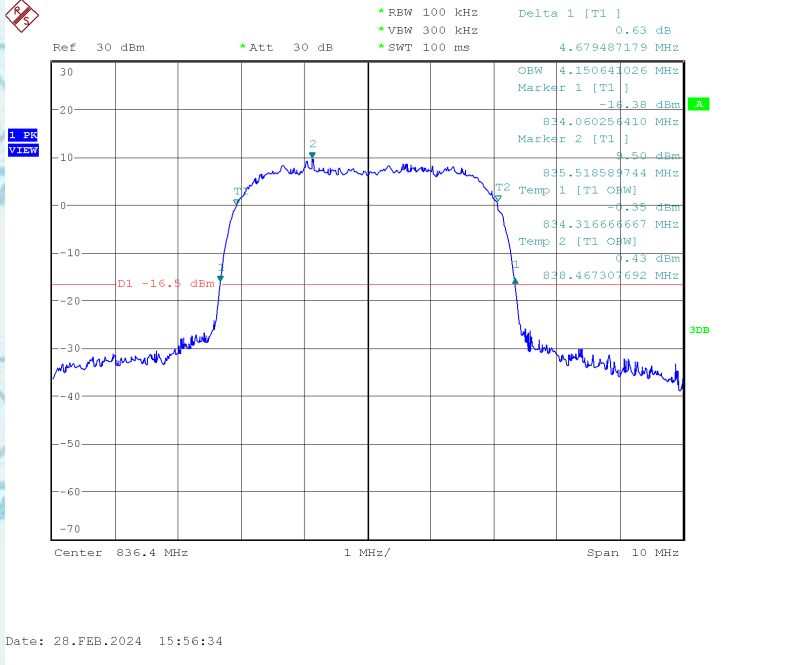

Occupied Bandwidth (99%and-26dBc) WCDMA BAND V CH 4233

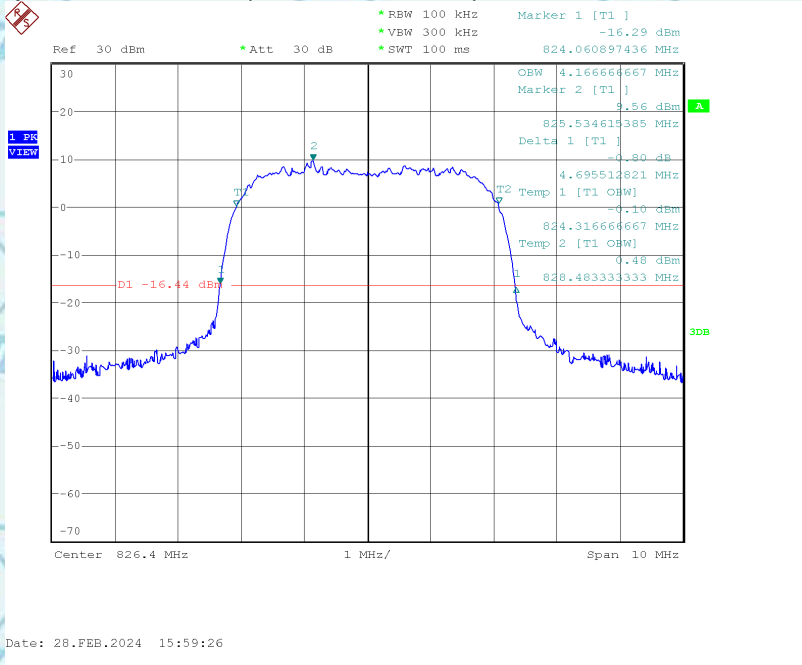

Refer to E-UTRA Annex for Band2, Band4, Band5, Band7, Band12, Band17, Band26, Band38, Band41, Band66.





9. BAND EDGE

Test Limit:

The radio frequency voltage or powers generated within the equipment and appearing on a spurious frequency shall be checked at the equipment output terminals when properly load ed with a suitable artificial antenna. Curves or equivalent data shall show the magnitude of each harmonic and other spurious emission that can be detected when the equipment is op erated under the conditions specified in §2.1049 as appropriate. The magnitude of spurious emissions which are attenuated more than 20 dB below the permissible value need not be specified. See section 4.

Test procedure:

The RF output of the transmitter was connected to the input of the spectrum analyzer through sufficient attenuation.

Test setup:

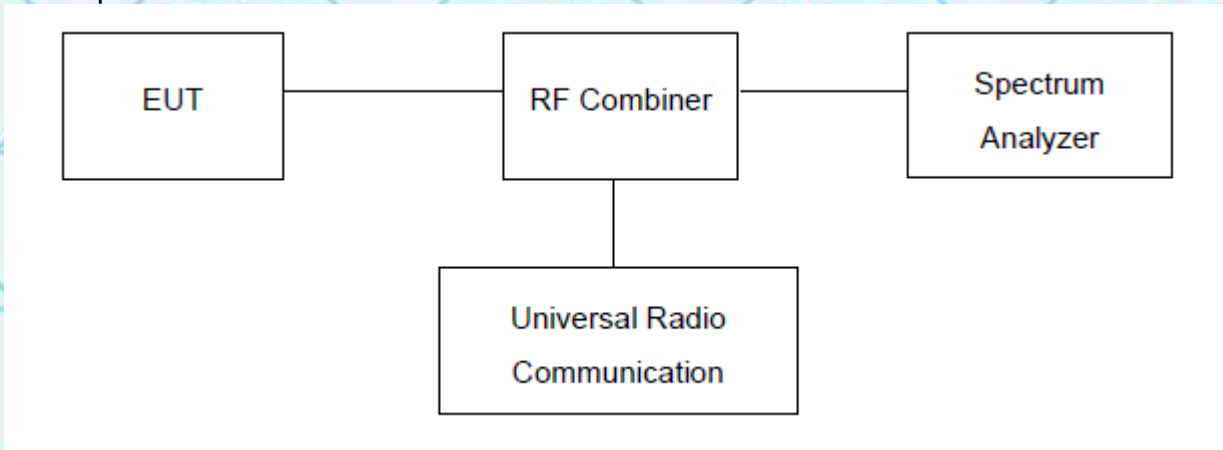



Measurement Result Test Plot(s)

Low Band Edge GSM 850 BAND CH 128

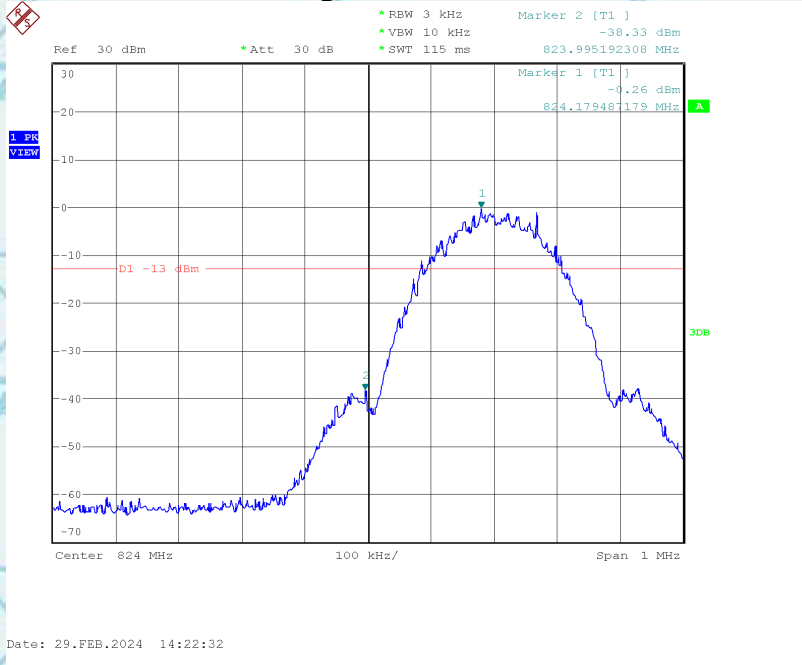



High Band Edge GSM 850 BAND CH 251

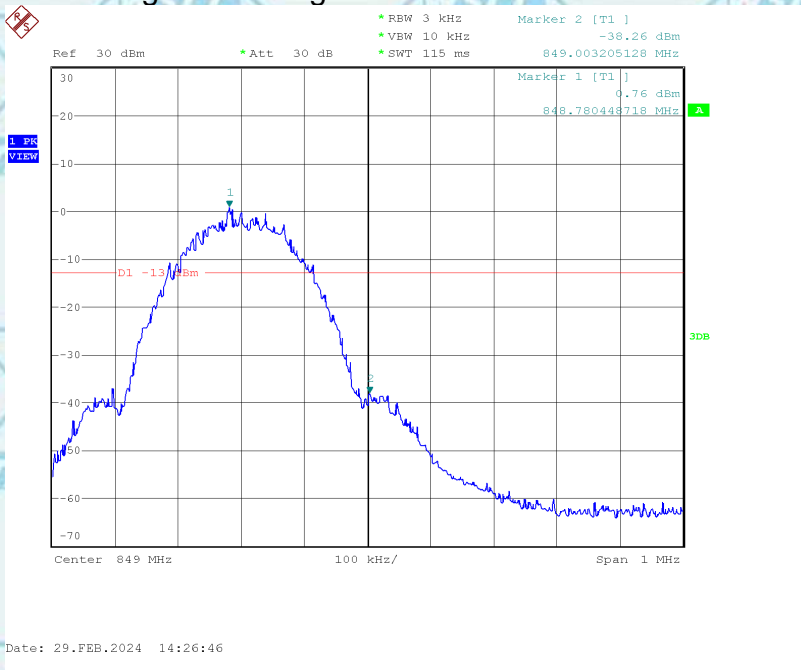



Low Band Edge PCS 1900 BAND CH 512

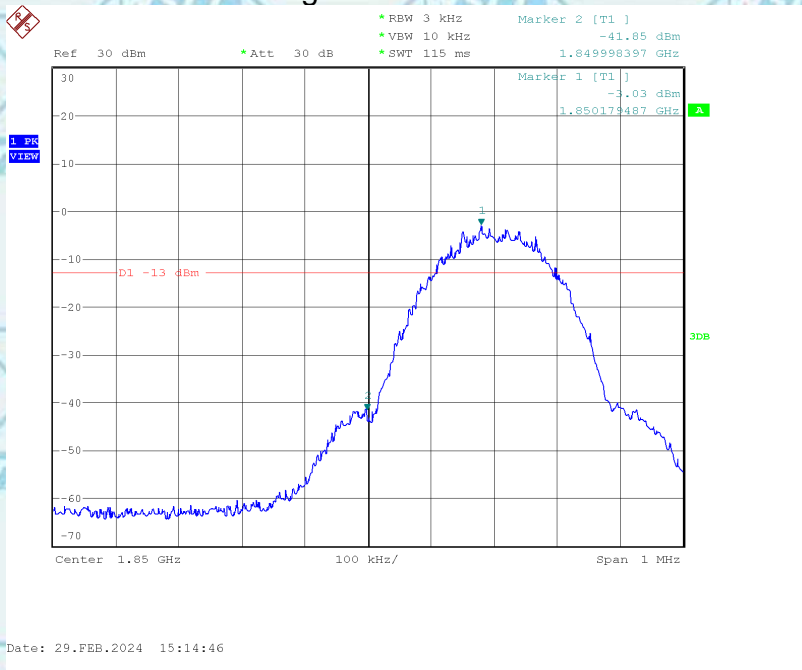

High Band Edge PCS 1900 BAND CH 810

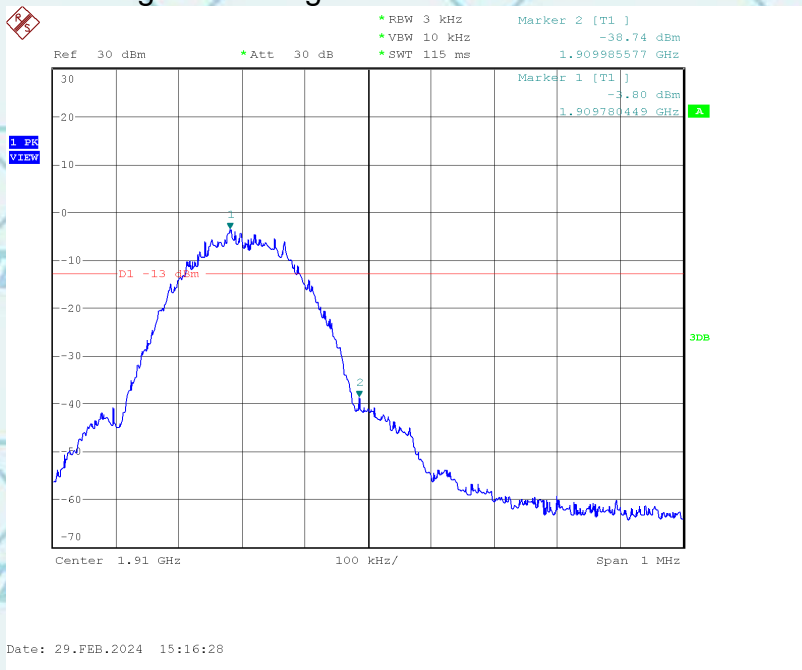



Low Band Edge WCDMA BAND II CH 9263

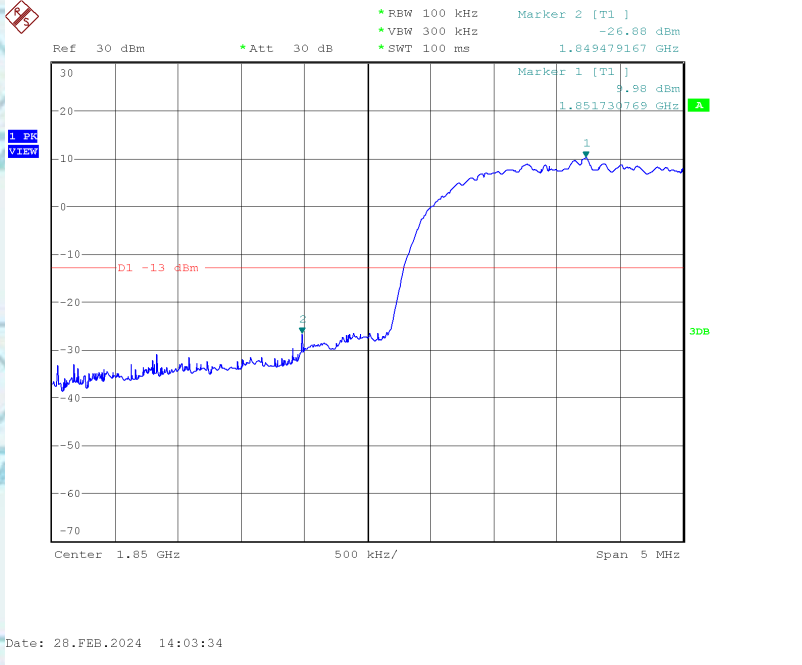

High Band Edge WCDMA BAND II CH 9537

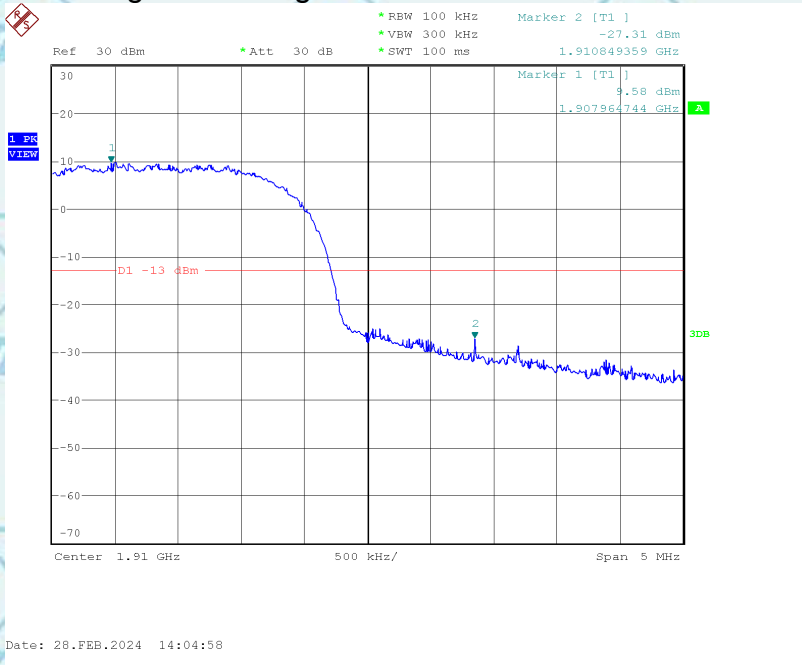



Low Band Edge WCDMA BAND IV CH 1312

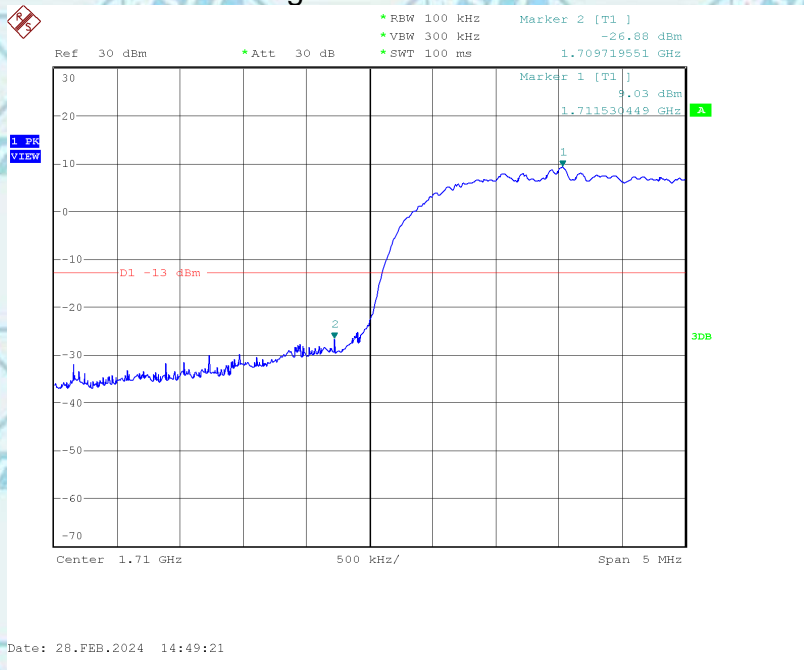

Low Band Edge WCDMA BAND IV CH 1513

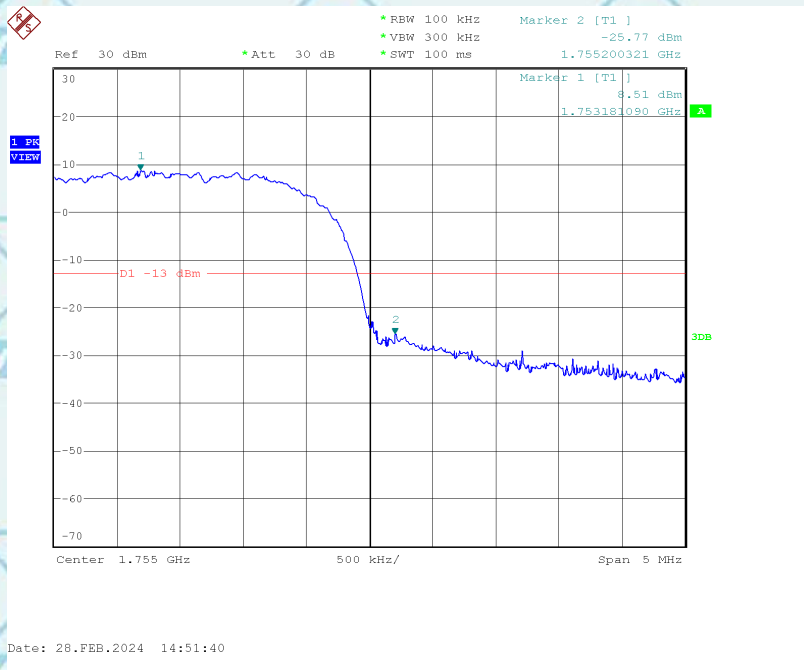



Low Band Edge WCDMA BAND V CH 4132

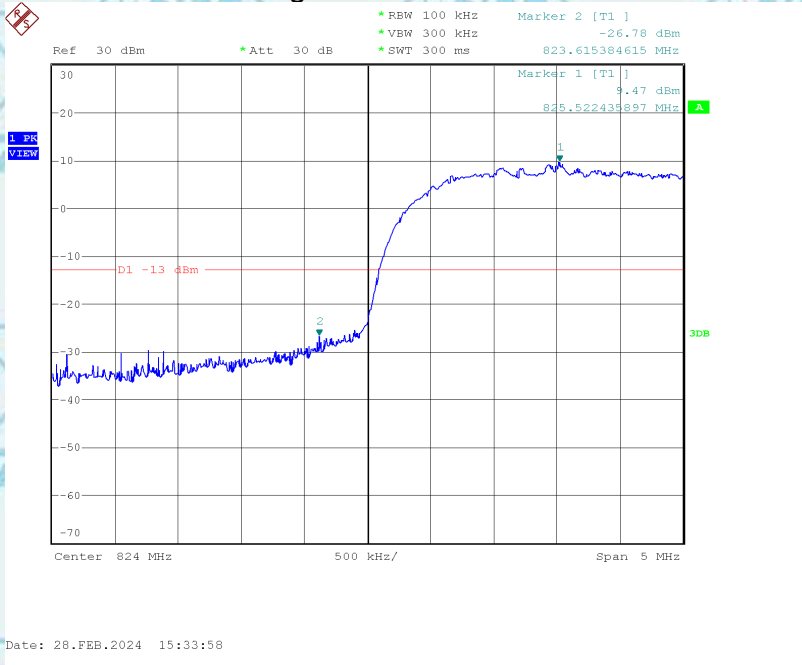

High Band Edge WCDMA BAND V CH 4233

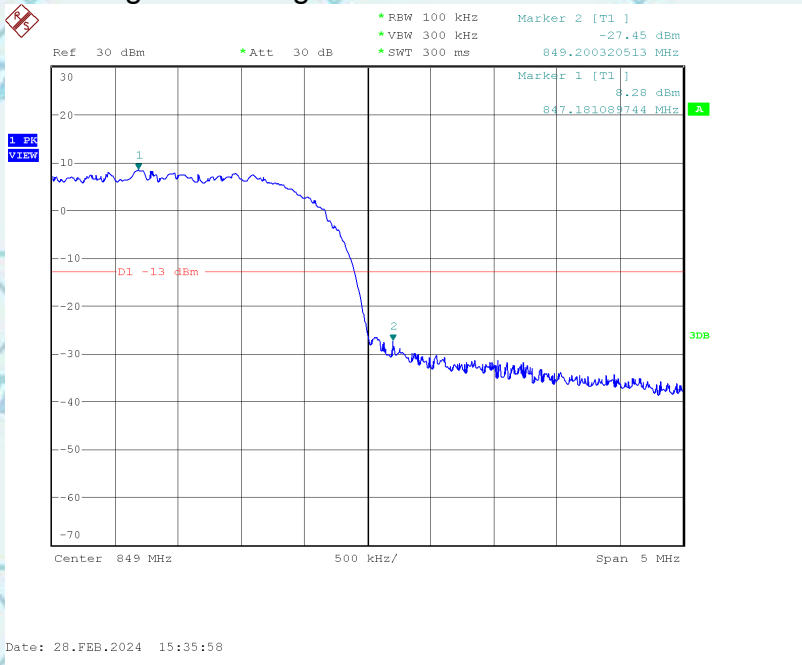

Refer to E-UTRA Annex for Band2, Band4, Band5, Band7, Band12, Band17, Band26, Band38, Band41, Band66.





10. FREQUENCY STABILITY

Test limit:

The frequency stability of the transmitter shall be measured while varying the ambient temperatures and supply voltages over the ranges specified in §2.1055. The specific frequency stability limits are provided in the relevant rules section(s), see section 4.

Test procedure:

Frequency Stability vs. Temperature: The equipment under test was connected to an external DC power supply and the RF output was connected to communication test set via feed-through attenuators. The EUT was placed inside the temperature chamber. The DC leads and RF output cable exited the chamber through an opening made for the purpose.

Test setup:

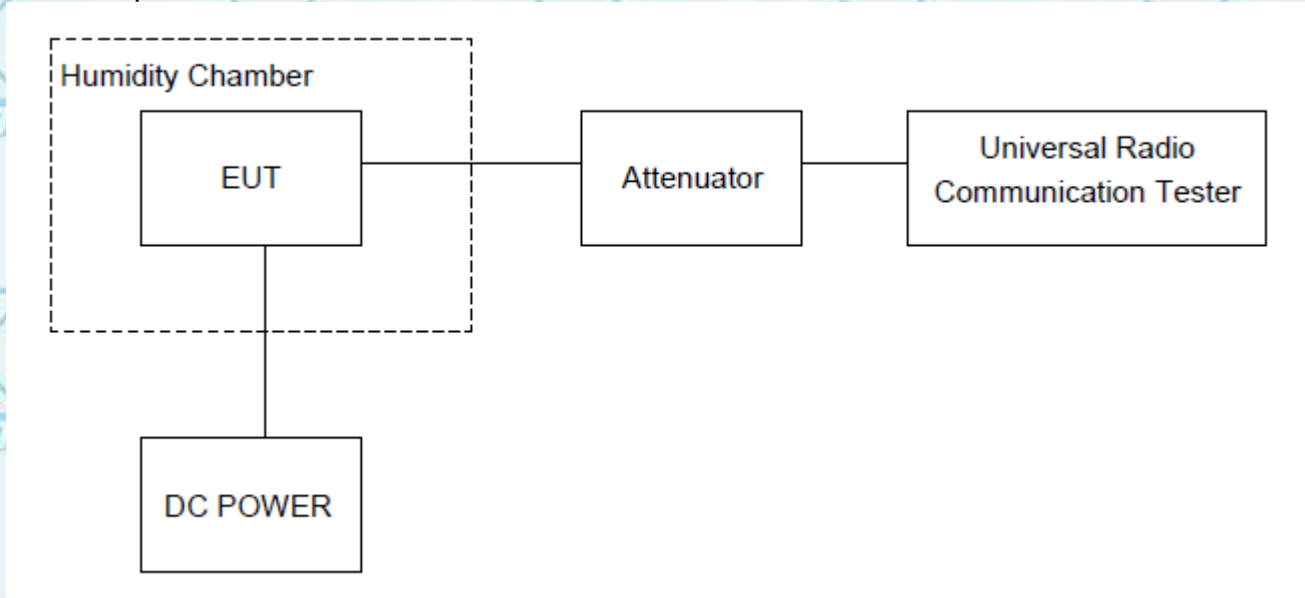



10.1. Measurement Result (Worst)

Frequency Error against Voltage for GSM 850 band (836.6MHz)

Voltage(V)	Frequency error(Hz)	Frequency error (ppm)
3.00	29	0.035
3.85	32	0.038
4.40	35	0.042

Frequency Error against Temperature for GSM 850 band (836.6MHz)

Temperature(°C)	Frequency error(Hz)	Frequency error(ppm)
-10	30	0.036
0	30	0.036
10	30	0.036
20	35	0.042
30	34	0.041
40	33	0.039
55	33	0.039

Frequency Error against Voltage for PCS 1900 band (1880MHz)

Voltage(V)	Frequency error(Hz)	Frequency error(ppm)
3.00	31	0.037
3.85	28	0.033
4.40	32	0.038

Frequency Error against Temperature for PCS 1900 band (1880MHz)

Temperature(°C)	Frequency error(Hz)	Frequency error(ppm)
-10	33	0.039
0	33	0.039
10	28	0.033
20	28	0.033
30	34	0.041
40	32	0.038
55	32	0.038



Frequency Error against Voltage for EGPRS 850 band (836.6MHz)

Voltage(V)	Frequency error(Hz)	Frequency error (ppm)
3.00	31	0.037
3.85	30	0.036
4.40	31	0.037

Frequency Error against Temperature for EGPRS 850 band (836.6MHz)

Temperature(°C)	Frequency error(Hz)	Frequency error(ppm)
-10	31	0.037
0	32	0.038
10	35	0.042
20	32	0.038
30	27	0.032
40	30	0.036
55	32	0.038



Frequency Error against Voltage for EGPRS 1900 band (1880MHz)

Voltage(V)	Frequency error(Hz)	Frequency error(ppm)
3.00	31	0.037
3.85	35	0.042
4.40	31	0.037

Frequency Error against Temperature for EGPRS 1900 band (1880MHz)

Temperature(°C)	Frequency error(Hz)	Frequency error(ppm)
-10	29	0.035
0	32	0.038
10	34	0.041
20	30	0.036
30	32	0.038
40	31	0.037
55	29	0.035

UTRA BANDS
Frequency Error against Voltage for WCDMA BAND 2 (1880MHz)

Voltage(V)	Frequency error(Hz)	Frequency error (ppm)
3.00	33	0.039
3.85	33	0.039
4.40	30	0.036

Frequency Error against Temperature for WCDMA BAND 2 (1880MHz)

Temperature(°C)	Frequency error(Hz)	Frequency error(ppm)
-10	32	0.038
0	29	0.035
10	33	0.039
20	33	0.039
30	31	0.037
40	33	0.039
55	32	0.038



Frequency Error against Voltage for WCDMA BAND 4 (1732.6MHz)

Voltage(V)	Frequency error(Hz)	Frequency error (ppm)
3.00	33	0.039
3.85	29	0.035
4.40	34	0.041

Frequency Error against Temperature for WCDMA BAND 4 (1732.6MHz)

Temperature(°C)	Frequency error(Hz)	Frequency error(ppm)
-10	31	0.037
0	30	0.036
10	33	0.039
20	33	0.039
30	27	0.032
40	32	0.038
55	31	0.037

Frequency Error against Voltage for WCDMA BAND 5 (836.4MHz)

Voltage(V)	Frequency error(Hz)	Frequency error(ppm)
3.00	30	0.036
3.85	33	0.039
4.40	28	0.033

Frequency Error against Temperature for WCDMA BAND 5 (836.4MHz)

Temperature(°C)	Frequency error(Hz)	Frequency error(ppm)
-10	33	0.039
0	30	0.036
10	35	0.042
20	33	0.039
30	28	0.033
40	30	0.036
55	28	0.033

Refer to E-UTRA Annex for LTE Band2, Band4, Band5, Band7, Band12, Band17, Band26, Band38, Band41, Band66.

---END OF REPORT---

