

1 Version

Version No.	Date	Description
00	14 Mar., 2024	Original

2 Contents

Page

Cover Page	1
1 Version	2
2 Contents	3
3 General Information	4
3.1 Client Information	4
3.2 General Description of E.U.T.	4
3.3 Test Mode and Test Environment	5
3.4 Description of Test Auxiliary Equipment	5
3.5 Measurement Uncertainty	5
3.6 Additions to, Deviations, or Exclusions from the Method	5
3.7 Laboratory Facility	6
3.8 Laboratory Location	6
3.9 Test Instruments List	7
4 Measurement Setup and Procedure	10
4.1 Test Channel	10
4.2 Test Setup	10
4.3 Test Procedure	12
5 Test Results	13
5.1 Summary	13
5.1.1 Clause and Data Summary	13
5.1.2 Test Limit	14
5.2 Antenna requirement	15
5.3 AC Power Line Conducted Emission	16
5.4 Emissions in Restricted Frequency Bands	18
5.5 Emissions in Non-restricted Frequency Bands	22

3 General Information

3.1 Client Information

Applicant:	ITEL MOBILE LIMITED
Address:	FLAT N 16/F BLOCK B UNIVERSAL INDUSTRIAL CENTRE 19-25 SHAN MEI STREET FOTAN NT HONGKONG
Manufacturer:	ITEL MOBILE LIMITED
Address:	FLAT N 16/F BLOCK B UNIVERSAL INDUSTRIAL CENTRE 19-25 SHAN MEI STREET FOTAN NT HONGKONG
Factory:	SHENZHEN TECNO TECHNOLOGY CO., LTD.
Address:	101, Building 24, Waijing Industrial Park, Fumin Community, Fucheng Street, Longhua District, Shenzhen City, P.R.China

3.2 General Description of E.U.T.

Product Name:	Mobile Phone
Model No.:	A667L
Operation Frequency:	2402 MHz - 2480 MHz
Channel Numbers:	40
Channel Separation:	2MHz
Modulation Technology:	GFSK
Data Speed:	1 Mbps (LE 1M PHY)
Antenna Type:	Internal Antenna
Antenna Gain:	0.32dBi (declare by applicant)
Antenna transmit mode:	SISO (1TX, 1RX)
Power Supply:	Rechargeable Li-ion Polymer Battery DC3.85V, 4900mAh
AC Adapter:	Model: U100ISB Input: AC100-240V, 50/60Hz, 0.3A Output: DC 5.0V, 2.0A
Test Sample Condition:	The test samples were provided in good working order with no visible defects.

3.3 Test Mode and Test Environment

Test Mode:	
Transmitting mode	Keep the EUT in continuous transmitting with modulation
Remark:	
<ol style="list-style-type: none"> For AC power line conducted emission and radiated spurious emission (below 1GHz), pre-scan all data speed, found 1 Mbps (LE 1M PHY) was worse case mode. The report only reflects the test data of worst mode. Channel Low, Mid and High for each type band with rated data rate were chosen for full testing. The field strength of spurious radiation emission was measured as EUT stand-up position (H mode) and lie down position (E1, E2 mode) for these modes. Just the worst case position (H mode) shown in report. 	
Operating Environment:	
Temperature:	15°C ~ 35°C
Humidity:	20 % ~ 75 % RH
Atmospheric Pressure:	1008 mbar
Voltage:	Nominal: 3.85Vdc, Extreme: Low 3.00Vdc, High 4.40Vdc
Test Engineer:	Logan (Conducted measurement) Kiran (Radiated measurement)

3.4 Description of Test Auxiliary Equipment

The EUT has been tested as an independent unit.

3.5 Measurement Uncertainty

Parameter	Expanded Uncertainty (Confidence of 95%(U = 2Uc(y)))
Conducted Emission for LISN (9kHz ~ 150kHz)	3.57 dB
Conducted Emission for LISN (150kHz ~ 30MHz)	3.14 dB
Radiated Emission (30MHz ~ 200MHz) (3m SAC)	4.6 dB
Radiated Emission (200MHz ~ 1000MHz) (3m SAC)	5.8 dB
Radiated Emission (1GHz ~ 6GHz) (3m FAR)	4.95 dB
Radiated Emission (6GHz ~ 18GHz) (3m FAR)	5.23 dB
Radiated Emission (18GHz ~ 40GHz) (3m FAR)	5.32 dB

Note: All the measurement uncertainty value were shown with a coverage k=2 to indicate 95% level of confidence. The measurement data show herein meets or exceeds the CISPR measurement uncertainty values specified in CISPR 16-4-2 and can be compared directly to specified limit to determine compliance.

3.6 Additions to, Deviations, or Exclusions from the Method

No

3.7 Laboratory Facility

The test facility is recognized, certified, or accredited by the following organizations:

- **FCC - Designation No.: CN1211**

JianYan Testing Group Shenzhen Co., Ltd. has been accredited as a testing laboratory by FCC(Federal Communications Commission). The test firm Registration No. is 727551.

- **ISED – CAB identifier.: CN0021**

The 3m Semi-anechoic chamber and 10m Semi-anechoic chamber of JianYan Testing Group Shenzhen Co., Ltd. has been Registered by Certification and Engineering Bureau of Industry Canada for radio equipment testing with Registration No.: 10106A-1.

- **CNAS - Registration No.: CNAS L15527**

JianYan Testing Group Shenzhen Co., Ltd. is accredited to ISO/IEC 17025:2017 General Requirements for the Competence of Testing and Calibration laboratories for the competence of testing. The Registration No. is CNAS L15527.

- **A2LA - Registration No.: 4346.01**

This laboratory is accredited in accordance with the recognized International Standard ISO/IEC 17025:2017 General requirements for the competence of testing and calibration laboratories. The test scope can be found as below link: <https://portal.a2la.org/scopepdf/4346-01.pdf>

3.8 Laboratory Location

JianYan Testing Group Shenzhen Co., Ltd.

Address: No.101, Building 8, Innovation Wisdom Port, No.155 Hongtian Road, Huangpu Community, Xinqiao Street, Bao'an District, Shenzhen, Guangdong, People's Republic of China.

Tel: +86-755-23118282, Fax: +86-755-23116366

Email: info-JYTee@lets.com, Website: <http://jyt.lets.com>

3.9 Test Instruments List

Radiated Emission(3m SAC):					
Test Equipment	Manufacturer	Model No.	Manage No.	Cal. Date (mm-dd-yy)	Cal. Due date (mm-dd-yy)
3m SAC	ETS	9m*6m*6m	WXJ001-1	04-14-2021	04-13-2024
Loop Antenna	Schwarzbeck	FMZB 1519 B	WXJ002-4	02-09-2023	02-08-2024
				01-05-2024	01-04-2025
BiConiLog Antenna	Schwarzbeck	VULB9163	WXJ002	02-09-2023	02-08-2024
				01-09-2024	01-08-2025
Horn Antenna	Schwarzbeck	BBHA9120D	WXJ002-2	02-09-2023	02-08-2024
				01-05-2024	01-04-2025
Horn Antenna	Schwarzbeck	BBHA9170	WXJ002-5	01-09-2023	01-08-2024
				12-28-2023	12-27-2024
Pre-amplifier (30MHz ~ 1GHz)	Schwarzbeck	BBV9743B	WXJ001-2	01-10-2023	01-09-2024
				12-27-2023	12-26-2024
Pre-amplifier (1GHz ~ 18GHz)	SKET	LNPA_0118G-50	WXJ001-3	01-10-2023	01-09-2024
				12-27-2023	12-26-2024
Pre-amplifier (18GHz ~ 40GHz)	RF System	TRLA-180400G45B	WXJ002-7	01-11-2023	01-10-2024
				12-27-2023	12-26-2024
EMI Test Receiver	Rohde & Schwarz	ESRP7	WXJ003-1	01-11-2023	01-10-2024
				12-27-2023	12-26-2024
Spectrum Analyzer	Rohde & Schwarz	FSP 30	WXJ004	01-10-2023	01-09-2024
				12-27-2023	12-26-2024
Spectrum Analyzer	KEYSIGHT	N9010B	WXJ004-2	09-25-2023	09-24-2024
Coaxial Cable (30MHz ~ 1GHz)	JYTSZ	JYT3M-1G-NN-8M	WXG001-4	01-18-2023	01-17-2024
				01-17-2024	01-16-2025
Coaxial Cable (1GHz ~ 18GHz)	JYTSZ	JYT3M-18G-NN-8M	WXG001-5	01-18-2023	01-17-2024
				01-17-2024	01-16-2025
Coaxial Cable (18GHz ~ 40GHz)	JYTSZ	JYT3M-40G-SS-8M	WXG001-7	01-18-2023	01-17-2024
				01-17-2024	01-16-2025
Band Reject Filter Group	Tonscend	JS0806-F	WXJ089	N/A	
Test Software	Tonscend	TS+	Version: 3.0.0.1		

Radiated Emission(3m FAR):					
Test Equipment	Manufacturer	Model No.	Manage No.	Cal. Date (mm-dd-yy)	Cal. Due date (mm-dd-yy)
3m FAR	YUNYI	9m*6m*6m	WXJ097	06-15-2023	06-14-2028
BiConiLog Antenna	Schwarzbeck	VULB9163	WXJ097-2	07-13-2023	07-12-2024
Biconical Antenna	Schwarzbeck	VUBA9117	WXJ002-1	07-02-2021	07-01-2024
Horn Antenna	Schwarzbeck	BBHA9120D	WXJ097-3	07-14-2023	07-13-2024
Horn Antenna	Schwarzbeck	BBHA9120D	WXJ002-3	01-09-2023	01-08-2024
				12-28-2023	12-27-2024
Horn Antenna	Schwarzbeck	BBHA9170	WXJ002-5	01-09-2023	01-08-2024
				12-28-2023	12-27-2024
Horn Antenna	Schwarzbeck	BBHA9170	WXJ002-6	01-09-2023	01-08-2024
				12-28-2023	12-27-2024
Pre-amplifier (30MHz ~ 1GHz)	YUNYI	PAM-310N	WXJ097-5	05-14-2023	05-13-2024
Pre-amplifier (1GHz ~ 18GHz)	YUNYI	PAM-118N	WXJ097-6	05-14-2023	05-13-2024
Pre-amplifier (18GHz ~ 40GHz)	RF System	TRLA-180400G45B	WXJ002-7	01-11-2023	01-10-2024
				12-27-2023	12-26-2024
EMI Test Receiver	Rohde & Schwarz	ESCI3	WXJ003	01-10-2023	01-09-2024
				12-27-2023	12-26-2024
Spectrum Analyzer	Rohde & Schwarz	FSP 30	WXJ004	01-10-2023	01-09-2024
				12-27-2023	12-26-2024
Spectrum Analyzer	KEYSIGHT	N9010B	WXJ081-1	06-13-2023	06-12-2024
Coaxial Cable (30MHz ~ 1GHz)	JYTSZ	JYT3M-1G-NN-13M	WXG097-1	08-01-2023	07-31-2024
Coaxial Cable (1GHz ~ 18GHz)	JYTSZ	JYT3M-18G-NN-8M	WXG097-2	08-01-2023	07-31-2024
Coaxial Cable (18GHz ~ 40GHz)	JYTSZ	JYT3M-40G-SS-8M	WXG097-3	08-01-2023	07-31-2024
High Band Reject Filter Group	Tonscend	JS0806-F	WXJ089	N/A	
Low Band Reject Filter Group	Tonscend	JS0806-F	WXJ097-4	N/A	
Test Software	Tonscend	TS+	Version: 5.0.0		

Conducted Emission:					
Test Equipment	Manufacturer	Model No.	Manage No.	Cal. Date (mm-dd-yy)	Cal. Due date (mm-dd-yy)
EMI Test Receiver	Rohde & Schwarz	ESR3	WXJ003-2	07-05-2023	07-04-2024
LISN	Schwarzbeck	NSLK 8127	QCJ001-13	01-10-2023	01-09-2024
				12-27-2023	12-26-2024
LISN	Rohde & Schwarz	ESH3-Z5	WXJ005-1	01-11-2023	01-10-2024
				12-27-2023	12-26-2024
LISN Coaxial Cable (9kHz ~ 30MHz)	JYTSZ	JYTCE-1G-NN-2M	WXG003-1	01-18-2023	01-17-2024
				01-17-2024	01-16-2025
RF Switch	TOP PRECISION	RSU0301	WXG003	N/A	
Test Software	AUDIX	E3	Version: 6.110919b		

Conducted Method:					
Test Equipment	Manufacturer	Model No.	Manage No.	Cal. Date (mm-dd-yy)	Cal. Due date (mm-dd-yy)
Spectrum Analyzer	Keysight	N9010B	WXJ004-3	11-01-2023	10-31-2024
Temperature Humidity Chamber	ZHONG ZHI	CZ-A-80D	WXJ032-3	01-09-2023	01-08-2025
Power Detector Box	MWRFTEST	MW100-PSB	WXJ007-4	09-25-2023	09-24-2024
DC Power Supply	Keysight	E3642A	WXJ025-2	N/A	
RF Control Unit	MWRFTEST	MW100-RFCB	WXG006	N/A	
Test Software	MWRFTEST	MTS 8310	Version: 2.0.0.0		

4 Measurement Setup and Procedure

4.1 Test Channel

According to ANSI C63.10-2013 chapter 5.6.1 Table 4 requirement, select lowest channel, middle channel, and highest channel in the frequency range in which device operates for testing. The detailed frequency points are as follows:

Lowest channel		Middle channel		Highest channel	
Channel No.	Frequency (MHz)	Channel No.	Frequency (MHz)	Channel No.	Frequency (MHz)
0	2402	20	2442	39	2480

4.2 Test Setup

1) Conducted emission measurement:

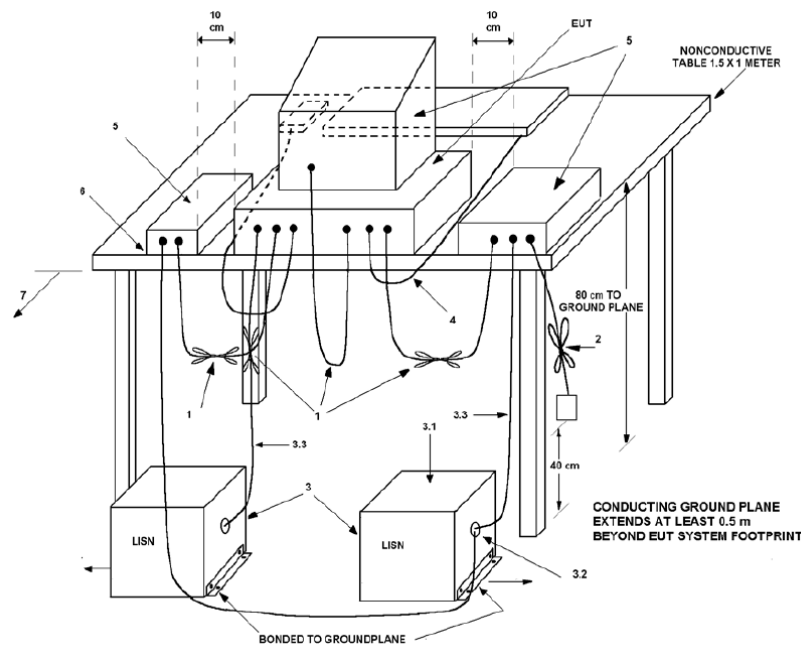

Note: The detailed descriptions please refer to Figure 8 of ANSI C63.4:2014.

2) Radiated emission measurement:

Below 1GHz (3m SAC)

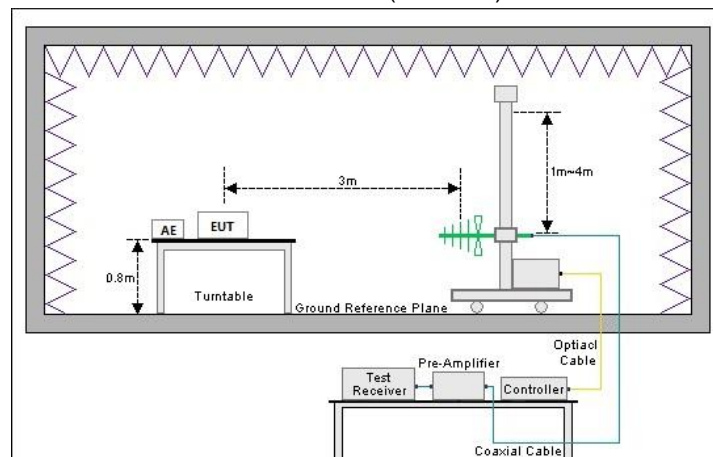

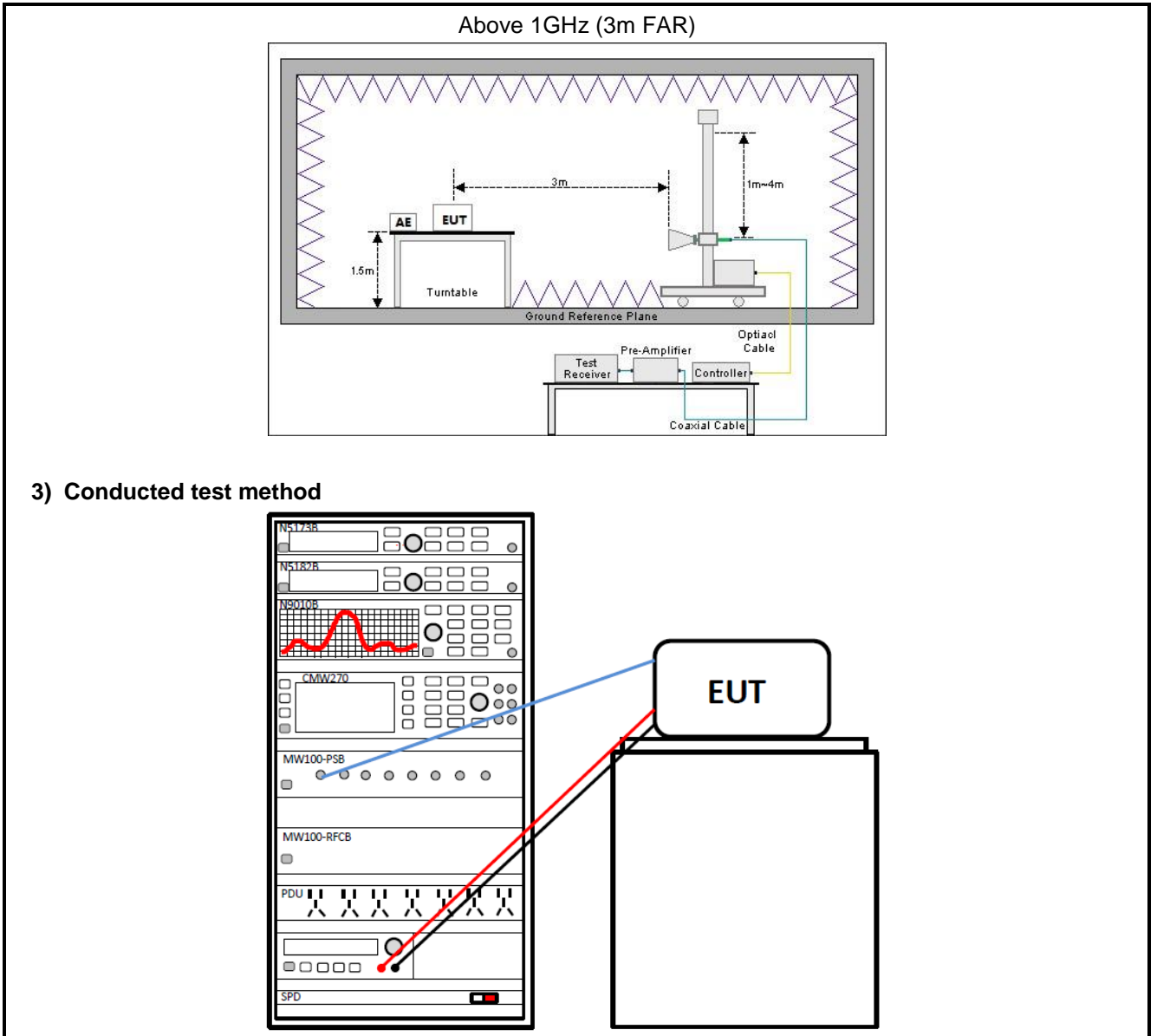

4.3 Test Procedure

Test method	Test step
Conducted emission	<ol style="list-style-type: none"> 1. The E.U.T and simulators are connected to the main power through a line impedance stabilization network (L.I.S.N.). This provides a 50ohm/50uH coupling impedance for the measuring equipment. 2. The peripheral devices are also connected to the main power through a LISN that provides a 50ohm/50uH coupling impedance with 50ohm termination. (Please refer to the block diagram of the test setup and photographs). 3. Both sides of A.C. line are checked for maximum conducted interference. In order to find the maximum emission, the relative positions of equipment and all of the interface cables must be changed according to ANSI C63.10 on conducted measurement.
Radiated emission	<p>For below 1GHz:</p> <ol style="list-style-type: none"> 1. The EUT was placed on the tabletop of a rotating table 0.8 m the ground at a 3 m semi anechoic chamber. The measurement distance from the EUT to the receiving antenna is 3 m. 2. EUT works in each mode of operation that needs to be tested , and having the EUT continuously working, respectively on 3 axis (X, Y & Z) and considered typical configuration to obtain worst position. The highest signal levels relative to the limit shall be determined by rotating the EUT from 0° to 360° and with varying the measurement antenna height between 1 m and 4 m in vertical and horizontal polarizations. 3. Open the test software to control the test antenna and test turntable. Perform the test, save the test results, and export the test data. <p>For above 1GHz:</p> <ol style="list-style-type: none"> 1. The EUT was placed on the tabletop of a rotating table 1.5 m the ground at a 3 m fully anechoic room. The measurement distance from the EUT to the receiving antenna is 3 m. 2. EUT works in each mode of operation that needs to be tested , and having the EUT continuously working, respectively on 3 axis (X, Y & Z) and considered typical configuration to obtain worst position. The highest signal levels relative to the limit shall be determined by rotating the EUT from 0° to 360° and with varying the measurement antenna height between 1 m and 4 m in vertical and horizontal polarizations. 3. Open the test software to control the test antenna and test turntable. Perform the test, save the test results, and export the test data.
Conducted test method	<ol style="list-style-type: none"> 1. The BLE antenna port of EUT was connected to the test port of the test system through an RF cable. 2. The EUT is keeping in continuous transmission mode and tested in all modulation modes. 3. Open the test software, prepare a test plan, and control the system through the software. After the test is completed, the test report is exported through the test software.

5 Test Results

5.1 Summary

5.1.1 Clause and Data Summary

Test items	Standard clause	Test data	Result
Antenna Requirement	15.203 15.247 (b)(4)	See Section 5.2	Pass
AC Power Line Conducted Emission	15.207	See Section 5.3	Pass
Conducted Output Power	15.247 (b)(3)	Appendix A – BLE 1M PHY	Pass
6dB Emission Bandwidth 99% Occupied Bandwidth	15.247 (a)(2)	Appendix A – BLE 1M PHY	Pass
Power Spectral Density	15.247 (e)	Appendix A – BLE 1M PHY	Pass
Band-edge Emission Conduction Spurious Emission	15.247 (d)	Appendix A – BLE 1M PHY	Pass
Emissions in Restricted Frequency Bands	15.205 15.247 (d)	See Section 5.4	Pass
Emissions in Non-restricted Frequency Bands	15.209 15.247(d)	See Section 5.5	Pass
Remark: 1. <i>Pass: The EUT complies with the essential requirements in the standard.</i> 2. <i>N/A: Not Applicable.</i> 3. <i>The cable insertion loss used by “RF Output Power” and other conduction measurement items is 0.5dB (provided by the customer).</i>			
Test Method:	ANSI C63.10-2013 KDB 558074 D01 15.247 Meas Guidance v05r02		

5.1.2 Test Limit

Test items	Limit																														
AC Power Line Conducted Emission	<table border="1"> <thead> <tr> <th rowspan="2">Frequency (MHz)</th> <th colspan="2">Limit (dBμV)</th> </tr> <tr> <th>Quasi-Peak</th> <th>Average</th> </tr> </thead> <tbody> <tr> <td>0.15 – 0.5</td> <td>66 to 56 <small>Note 1</small></td> <td>56 to 46 <small>Note 1</small></td> </tr> <tr> <td>0.5 – 5</td> <td>56</td> <td>46</td> </tr> <tr> <td>5 – 30</td> <td>60</td> <td>50</td> </tr> </tbody> </table> <p>Note 1: The limit level in dBμV decreases linearly with the logarithm of frequency. Note 2: The more stringent limit applies at transition frequencies.</p>	Frequency (MHz)	Limit (dB μ V)		Quasi-Peak	Average	0.15 – 0.5	66 to 56 <small>Note 1</small>	56 to 46 <small>Note 1</small>	0.5 – 5	56	46	5 – 30	60	50																
Frequency (MHz)	Limit (dB μ V)																														
	Quasi-Peak	Average																													
0.15 – 0.5	66 to 56 <small>Note 1</small>	56 to 46 <small>Note 1</small>																													
0.5 – 5	56	46																													
5 – 30	60	50																													
Conducted Output Power	For systems using digital modulation in the 902-928 MHz, 2400-2483.5 MHz, and 5725-5850 MHz bands: 1 Watt.																														
6dB Emission Bandwidth	The minimum 6 dB bandwidth shall be at least 500 kHz.																														
99% Occupied Bandwidth	N/A																														
Power Spectral Density	For digitally modulated systems, the power spectral density conducted from the intentional radiator to the antenna shall not be greater than 8 dBm in any 3 kHz band during any time interval of continuous transmission.																														
Band-edge Emission Conduction Spurious Emission	In any 100 kHz bandwidth outside the frequency band in which the spread spectrum or digitally modulated intentional radiator is operating, the radio frequency power that is produced by the intentional radiator shall be at least 20 dB below that in the 100 kHz bandwidth within the band that contains the highest level of the desired power, based on either an RF conducted or a radiated measurement, provided the transmitter demonstrates compliance with the peak conducted power limits. If the transmitter complies with the conducted power limits based on the use of RMS averaging over a time interval, as permitted under paragraph (b)(3) of this section, the attenuation required under this paragraph shall be 30 dB instead of 20 dB. Attenuation below the general limits specified in §15.209(a) is not required. In addition, radiated emissions which fall in the restricted bands, as defined in §15.205(a), must also comply with the radiated emission limits specified in §15.209(a) (see §15.205(c)).																														
Emissions in Restricted Frequency Bands Emissions in Non-restricted Frequency Bands	<table border="1"> <thead> <tr> <th rowspan="2">Frequency (MHz)</th> <th colspan="2">Limit (dBμV/m)</th> <th rowspan="2">Detector</th> </tr> <tr> <th>@ 3m</th> <th>@ 10m</th> </tr> </thead> <tbody> <tr> <td>30 – 88</td> <td>40.0</td> <td>30.0</td> <td>Quasi-peak</td> </tr> <tr> <td>88 – 216</td> <td>43.5</td> <td>33.5</td> <td>Quasi-peak</td> </tr> <tr> <td>216 – 960</td> <td>46.0</td> <td>36.0</td> <td>Quasi-peak</td> </tr> <tr> <td>960 – 1000</td> <td>54.0</td> <td>44.0</td> <td>Quasi-peak</td> </tr> </tbody> </table> <p>Note: The more stringent limit applies at transition frequencies.</p> <table border="1"> <thead> <tr> <th rowspan="2">Frequency</th> <th colspan="2">Limit (dBμV/m) @ 3m</th> </tr> <tr> <th>Average</th> <th>Peake</th> </tr> </thead> <tbody> <tr> <td>Above 1 GHz</td> <td>54.0</td> <td>74.0</td> </tr> </tbody> </table> <p>Note: The measurement bandwidth shall be 1 MHz or greater.</p>	Frequency (MHz)	Limit (dB μ V/m)		Detector	@ 3m	@ 10m	30 – 88	40.0	30.0	Quasi-peak	88 – 216	43.5	33.5	Quasi-peak	216 – 960	46.0	36.0	Quasi-peak	960 – 1000	54.0	44.0	Quasi-peak	Frequency	Limit (dB μ V/m) @ 3m		Average	Peake	Above 1 GHz	54.0	74.0
Frequency (MHz)	Limit (dB μ V/m)		Detector																												
	@ 3m	@ 10m																													
30 – 88	40.0	30.0	Quasi-peak																												
88 – 216	43.5	33.5	Quasi-peak																												
216 – 960	46.0	36.0	Quasi-peak																												
960 – 1000	54.0	44.0	Quasi-peak																												
Frequency	Limit (dB μ V/m) @ 3m																														
	Average	Peake																													
Above 1 GHz	54.0	74.0																													

5.2 Antenna requirement

Standard requirement:	FCC Part 15 C Section 15.203 /247(b)(4)
<p>15.203 requirement: An intentional radiator shall be designed to ensure that no antenna other than that furnished by the responsible party shall be used with the device. The use of a permanently attached antenna or of an antenna that uses a unique coupling to the intentional radiator, the manufacturer may design the unit so that a broken antenna can be replaced by the user, but the use of a standard antenna jack or electrical connector is prohibited.</p>	
<p>15.247(b) (4) requirement: (4) The conducted output power limit specified in paragraph (b) of this section is based on the use of antennas with directional gains that do not exceed 6 dBi. Except as shown in paragraph (c) of this section, if transmitting antennas of directional gain greater than 6 dBi are used, the conducted output power from the intentional radiator shall be reduced below the stated values in paragraphs (b)(1), (b)(2), and (b)(3) of this section, as appropriate, by the amount in dB that the directional gain of the antenna exceeds 6 dBi.</p>	
E.U.T Antenna:	
<p>The BLE antenna is an Internal antenna which cannot replace by end-user, the best case gain of the antenna is 0.32 dBi. See product internal photos for details.</p>	

5.3 AC Power Line Conducted Emission

Product name:	Mobile Phone	Product model:	A667L
Test by:	Asher	Test mode:	BLE Tx (LE 1M PHY)
Test frequency:	150 kHz ~ 30 MHz	Phase:	Line
Test voltage:	AC 120 V/60 Hz		

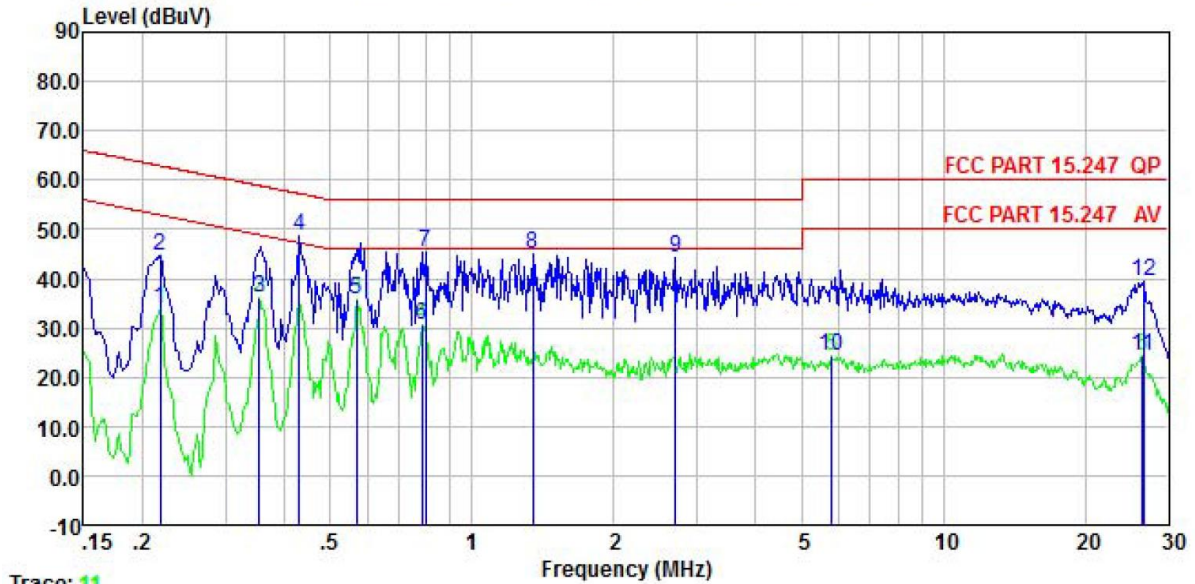

Trace: 11

	Read	LISN	Aux2	Cable	Level	Limit	Over	Remark
Freq	Level	Factor	Factor	Loss	Level	Line	Limit	
MHz	dBuV	dB	dB	dB	dBuV	dBuV	dB	
1	0.219	23.16	0.20	10.50	0.03	33.89	52.88	-18.99 Average
2	0.219	34.00	0.20	10.50	0.03	44.73	62.88	-18.15 QP
3	0.354	25.56	0.20	10.50	0.02	36.28	48.87	-12.59 Average
4	0.431	37.85	0.20	10.50	0.03	48.58	57.24	-8.66 QP
5	0.570	24.88	0.20	10.50	0.02	35.60	46.00	-10.40 Average
6	0.783	19.75	0.20	10.50	0.03	30.48	46.00	-15.52 Average
7	0.796	34.75	0.20	10.50	0.03	45.48	56.00	-10.52 QP
8	1.345	34.26	0.20	10.50	0.12	45.08	56.00	-10.92 QP
9	2.707	33.27	0.20	10.50	0.11	44.08	56.00	-11.92 QP
10	5.805	13.40	0.20	10.50	0.09	24.19	50.00	-25.81 Average
11	26.418	13.13	0.40	10.50	0.21	24.24	50.00	-25.76 Average
12	26.558	28.33	0.40	10.50	0.20	39.43	60.00	-20.57 QP

Remark:

1. Level = Read level + LISN Factor + Cable Loss.

Product name:	Mobile Phone	Product model:	A667L
Test by:	Asher	Test mode:	BLE Tx (LE 1M PHY)
Test frequency:	150 kHz ~ 30 MHz	Phase:	Neutral
Test voltage:	AC 120 V/60 Hz		

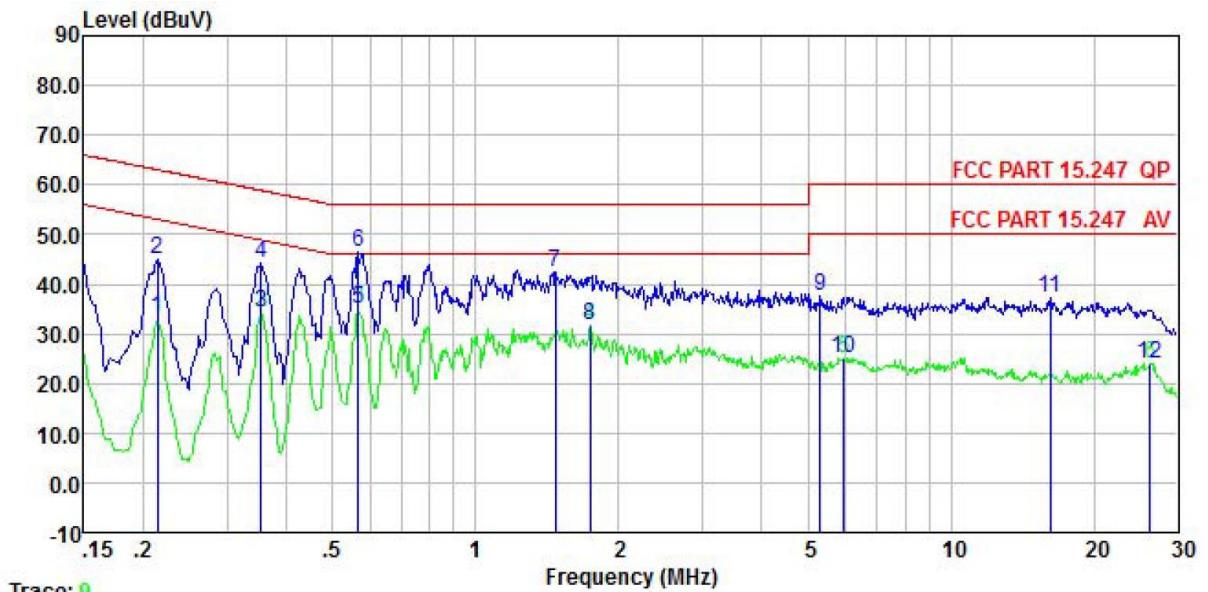

Trace: 9

	Read Freq	Level	LISN Factor	Aux2 Factor	Cable Loss	Level	Limit Line	Over Limit	Remark
	MHz	dBuV	dB	dB	dB	dBuV	dBuV	dB	
1	0.214	22.34	0.20	10.50	0.03	33.07	53.05	-19.98	Average
2	0.214	34.38	0.20	10.50	0.03	45.11	63.05	-17.94	QP
3	0.354	23.49	0.20	10.50	0.02	34.21	48.87	-14.66	Average
4	0.354	33.67	0.20	10.50	0.02	44.39	58.87	-14.48	QP
5	0.567	24.23	0.20	10.50	0.02	34.95	46.00	-11.05	Average
6	0.567	35.68	0.20	10.50	0.02	46.40	56.00	-9.60	QP
7	1.472	31.59	0.26	10.50	0.14	42.49	56.00	-13.51	QP
8	1.744	20.76	0.28	10.50	0.18	31.72	46.00	-14.28	Average
9	5.305	26.77	0.30	10.50	0.09	37.66	60.00	-22.34	QP
10	5.961	14.18	0.30	10.50	0.09	25.07	50.00	-24.93	Average
11	16.140	26.00	0.40	10.50	0.16	37.06	60.00	-22.94	QP
12	26.278	12.90	0.40	10.50	0.21	24.01	50.00	-25.99	Average

Remark:

1. Level = Read level + LISN Factor + Cable Loss.

5.4 Emissions in Restricted Frequency Bands

Product Name:	Mobile Phone	Product Model:	A667L
Test By:	Kiran	Test mode:	BLE Tx (LE 1M PHY)
Test Channel:	Lowest channel	Polarization:	Vertical
Test Voltage:	DC 3.85V		

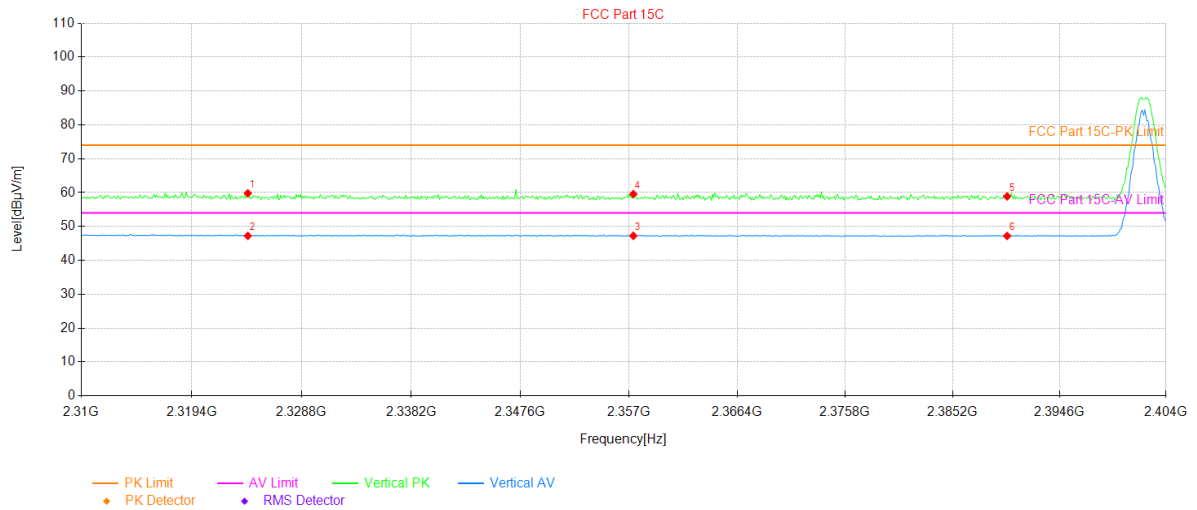

Suspected Data List											
NO.	Freq. [MHz]	Reading [dBµV]	Factor [dB/m]	Level [dBµV/m]	Limit [dBµV/m]	Margin [dB]	Angle [°]	Detector	Verdict	Polarity	
1	2324.19	23.67	36.12	59.79	74.00	14.21	310	PK	PASS	Vertical	
2	2324.19	11.10	36.12	47.22	54.00	6.78	295	AV	PASS	Vertical	
3	2357.38	10.94	36.30	47.24	54.00	6.76	257	AV	PASS	Vertical	
4	2357.38	23.25	36.30	59.55	74.00	14.45	208	PK	PASS	Vertical	
5	2390.00	22.40	36.47	58.87	74.00	15.13	333	PK	PASS	Vertical	
6	2390.00	10.74	36.47	47.21	54.00	6.79	322	AV	PASS	Vertical	

Remark:

1. Level = Reading + Factor(Antenna Factor + Cable Loss – Pre-amplifier Factor).

Product Name:	Mobile Phone	Product Model:	A667L
Test By:	Kiran	Test mode:	BLE Tx (LE 1M PHY)
Test Channel:	Lowest channel	Polarization:	Horizontal
Test Voltage:	DC 3.85V		

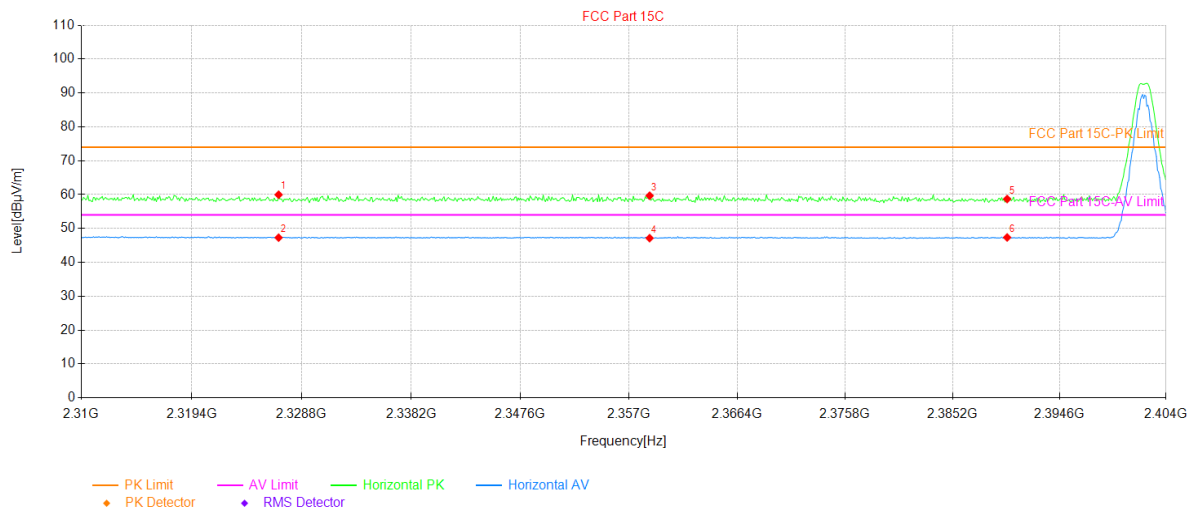

Suspected Data List										
NO.	Freq. [MHz]	Reading [dBµV]	Factor [dB/m]	Level [dBµV/m]	Limit [dBµV/m]	Margin [dB]	Angle [°]	Detector	Verdict	Polarity
1	2326.83	23.85	36.12	59.97	74.00	14.03	148	PK	PASS	Horizontal
2	2326.83	11.17	36.12	47.29	54.00	6.71	121	AV	PASS	Horizontal
3	2358.79	23.35	36.32	59.67	74.00	14.33	60	PK	PASS	Horizontal
4	2358.79	10.83	36.32	47.15	54.00	6.85	232	AV	PASS	Horizontal
5	2390.00	22.22	36.47	58.69	74.00	15.31	99	PK	PASS	Horizontal
6	2390.00	10.89	36.47	47.36	54.00	6.64	171	AV	PASS	Horizontal

Remark:

1. Level = Reading + Factor(Antenna Factor + Cable Loss – Pre-amplifier Factor).

Product Name:	Mobile Phone	Product Model:	A667L
Test By:	Kiran	Test mode:	BLE Tx (LE 1M PHY)
Test Channel:	Highest channel	Polarization:	Vertical
Test Voltage:	DC 3.85V		

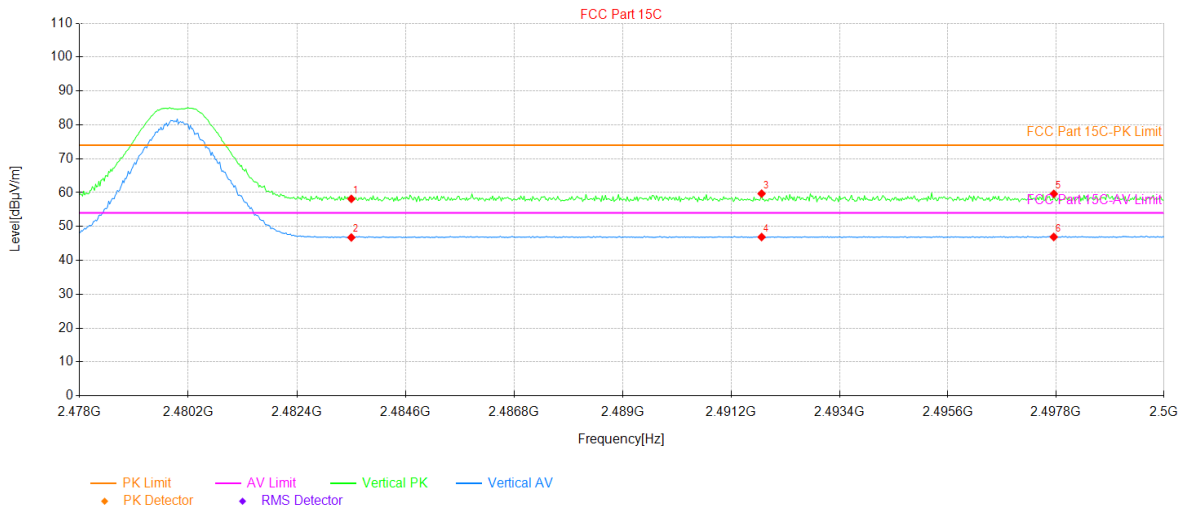

Suspected Data List										
NO.	Freq. [MHz]	Reading [dBµV]	Factor [dB/m]	Level [dBµV/m]	Limit [dBµV/m]	Margin [dB]	Angle [°]	Detector	Verdict	Polarity
1	2483.50	22.05	36.11	58.16	74.00	15.84	307	PK	PASS	Vertical
2	2483.50	10.65	36.11	46.76	54.00	7.24	285	AV	PASS	Vertical
3	2491.82	23.56	36.14	59.70	74.00	14.30	341	PK	PASS	Vertical
4	2491.82	10.75	36.14	46.89	54.00	7.11	139	AV	PASS	Vertical
5	2497.76	23.44	36.17	59.61	74.00	14.39	304	PK	PASS	Vertical
6	2497.76	10.74	36.17	46.91	54.00	7.09	158	AV	PASS	Vertical

Remark:

1. Level = Reading + Factor(Antenna Factor + Cable Loss – Pre-amplifier Factor).

Product Name:	Mobile Phone	Product Model:	A667L
Test By:	Kiran	Test mode:	BLE Tx (LE 1M PHY)
Test Channel:	Highest channel	Polarization:	Horizontal
Test Voltage:	DC 3.85V		

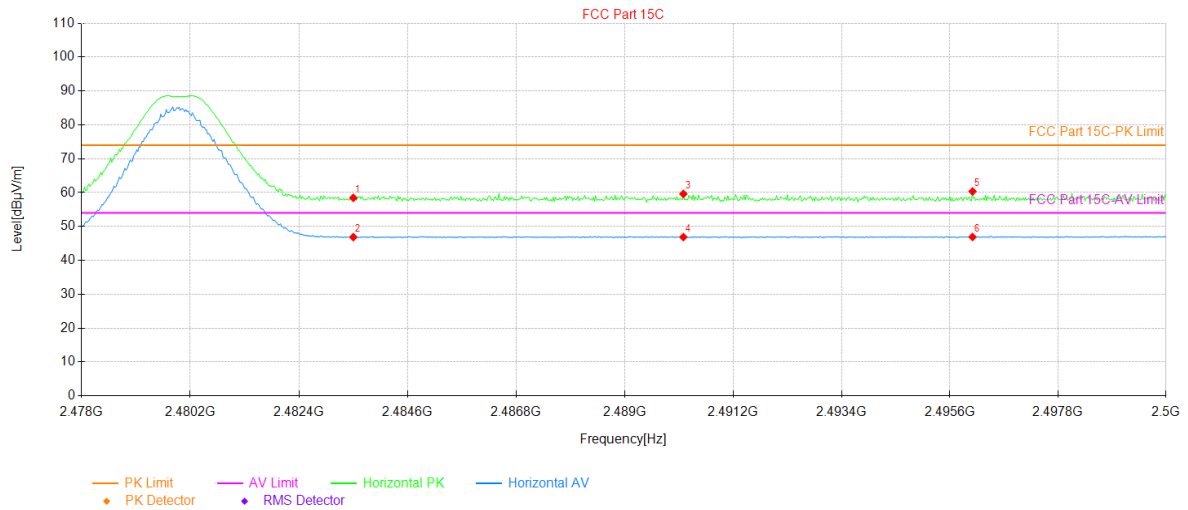

Suspected Data List										
NO.	Freq. [MHz]	Reading [dBµV]	Factor [dB/m]	Level [dBµV/m]	Limit [dBµV/m]	Margin [dB]	Angle [°]	Detector	Verdict	Polarity
1	2483.50	22.34	36.11	58.45	74.00	15.55	132	PK	PASS	Horizontal
2	2483.50	10.75	36.11	46.86	54.00	7.14	110	AV	PASS	Horizontal
3	2490.19	23.47	36.14	59.61	74.00	14.39	99	PK	PASS	Horizontal
4	2490.19	10.73	36.14	46.87	54.00	7.13	327	AV	PASS	Horizontal
5	2496.06	24.19	36.16	60.35	74.00	13.65	26	PK	PASS	Horizontal
6	2496.06	10.73	36.16	46.89	54.00	7.11	200	AV	PASS	Horizontal

Remark:

1. Level = Reading + Factor(Antenna Factor + Cable Loss – Pre-amplifier Factor).

5.5 Emissions in Non-restricted Frequency Bands

Below 1GHz:

Product Name:	Mobile Phone	Product Model:	A667L
Test By:	Kiran	Test mode:	BLE Tx (LE 1M PHY)
Test Frequency:	30 MHz ~ 1 GHz	Polarization:	Vertical
Test Voltage:	DC 3.85V		

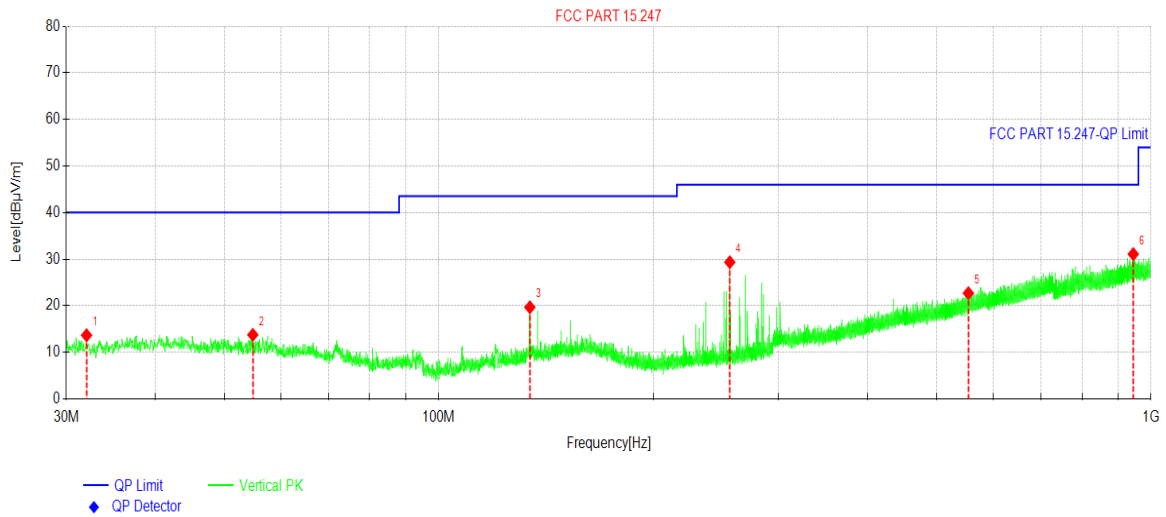

Suspected Data List

NO.	Freq. [MHz]	Reading[dBµV/m]	Factor [dB]	Level [dBµV/m]	Limit [dBµV/m]	Margin [dB]	Trace	Polarity
1	32.0371	28.31	-14.65	13.66	40.00	26.34	PK	Vertical
2	54.8332	27.88	-14.12	13.76	40.00	26.24	PK	Vertical
3	134.280	34.13	-14.46	19.67	43.50	23.83	PK	Vertical
4	256.263	44.59	-15.25	29.34	46.00	16.66	PK	Vertical
5	554.214	29.38	-6.68	22.70	46.00	23.30	PK	Vertical
6	944.270	30.31	0.77	31.08	46.00	14.92	PK	Vertical

Remark:

1. Level = Reading + Factor(Antenna Factor + Cable Loss – Preamplifier Factor).

Product Name:	Mobile Phone	Product Model:	A667L
Test By:	Kiran	Test mode:	BLE Tx (LE 1M PHY)
Test Frequency:	30 MHz ~ 1 GHz	Polarization:	Horizontal
Test Voltage:	DC 3.85V		

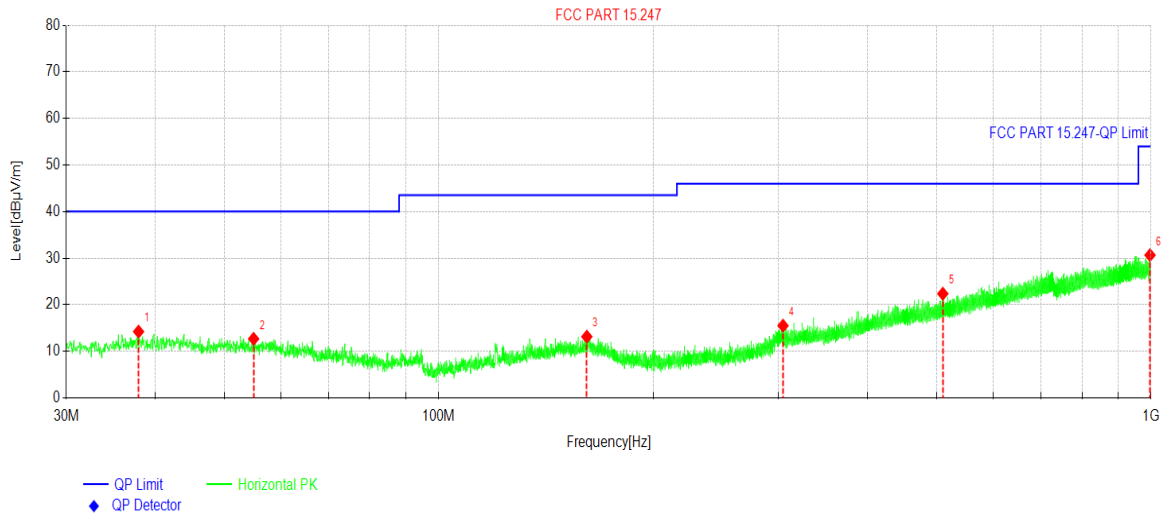

Suspected Data List								
NO.	Freq. [MHz]	Reading[dBµV/m]	Factor [dB]	Level [dBµV/m]	Limit [dBµV/m]	Margin [dB]	Trace	Polarity
1	37.9059	27.95	-13.72	14.23	40.00	25.77	PK	Horizontal
2	54.9787	26.80	-14.12	12.68	40.00	27.32	PK	Horizontal
3	161.441	26.79	-13.65	13.14	43.50	30.36	PK	Horizontal
4	304.378	28.75	-13.25	15.50	46.00	30.50	PK	Horizontal
5	510.174	30.16	-7.80	22.36	46.00	23.64	PK	Horizontal
6	996.847	29.51	1.14	30.65	54.00	23.35	PK	Horizontal

Remark:

1. Level = Reading + Factor(Antenna Factor + Cable Loss – Preamplifier Factor).

Above 1GHz:

BLE Tx (LE 1M PHY)						
Test channel: Lowest channel						
Detector: Peak Value						
Frequency (MHz)	Read Level (dBμV)	Factor (dB)	Level (dBμV/m)	Limit (dBμV/m)	Margin (dB)	Polarization
4804.00	50.05	-8.00	42.05	74.00	31.95	Vertical
4804.00	49.22	-8.00	41.22	74.00	32.78	Horizontal
Detector: Average Value						
Frequency (MHz)	Read Level (dBμV)	Factor (dB)	Level (dBμV/m)	Limit (dBμV/m)	Margin (dB)	Polarization
4804.00	40.27	-8.00	32.27	54.00	21.73	Vertical
4804.00	40.15	-8.00	32.15	54.00	21.85	Horizontal
Test channel: Middle channel						
Detector: Peak Value						
Frequency (MHz)	Read Level (dBμV)	Factor (dB)	Level (dBμV/m)	Limit (dBμV/m)	Margin (dB)	Polarization
4884.00	50.70	-7.45	43.25	74.00	30.75	Vertical
4884.00	50.03	-7.45	42.58	74.00	31.42	Horizontal
Detector: Average Value						
Frequency (MHz)	Read Level (dBμV)	Factor (dB)	Level (dBμV/m)	Limit (dBμV/m)	Margin (dB)	Polarization
4884.00	39.59	-7.45	32.14	54.00	21.86	Vertical
4884.00	39.22	-7.45	31.77	54.00	22.23	Horizontal
Test channel: Highest channel						
Detector: Peak Value						
Frequency (MHz)	Read Level (dBμV)	Factor (dB)	Level (dBμV/m)	Limit (dBμV/m)	Margin (dB)	Polarization
4960.00	50.28	-7.08	43.20	74.00	30.80	Vertical
4960.00	48.71	-7.08	41.63	74.00	32.37	Horizontal
Detector: Average Value						
Frequency (MHz)	Read Level (dBμV)	Factor (dB)	Level (dBμV/m)	Limit (dBμV/m)	Margin (dB)	Polarization
4960.00	40.25	-7.08	33.17	54.00	20.83	Vertical
4960.00	40.28	-7.08	33.20	54.00	20.80	Horizontal
Remark:						
1. Level = Reading + Factor.						
2. Test Frequency up to 25GHz, and the emission levels of other frequencies are lower than the limit 20dB, not show in test report.						

-----End of report-----