

# RADIO TEST REPORT

## FCC ID: 2AJK8-KA2RF

**Product :** Paste wireless switch at will

**Trade Mark :** N/A

**Model Name :** KA2RF

**Family Model :** N/A

**Report No. :** S22021602305001

### Prepared for

Shenzhen Ligan Intelligent Technology Co.,Ltd  
6/F, 10 Bldg,Nangang 2nd Industrial Park, Songbai Road No.1026, Xili,  
Nanshan District, Shenzhen, China.

### Prepared by

Shenzhen NTEK Testing Technology Co., Ltd.  
1/F, Building E, Fenda Science Park, Sanwei Community, Xixiang Street  
Bao'an District, Shenzhen 518126 P.R. China  
Tel.: 400-800-6106,0755-2320 0050 / 2320 0090  
Website:<http://www.ntek.org.cn>

TEST RESULT CERTIFICATION

Applicant's name : Shenzhen Lingan Intelligent Technology Co.,Ltd
Address : 6/F, 10 Bldg,Nangang 2nd Industrial Park, Songbai Road No.1026, Xili, Nanshan District, Shenzhen, China.

Manufacturer's Name : Shenzhen Lingan Intelligent Technology Co.,Ltd
Address : 6/F, 10 Bldg,Nangang 2nd Industrial Park, Songbai Road No.1026, Xili, Nanshan District, Shenzhen, China.

Product description

Product name : Paste wireless switch at will
Model and/or type reference : KA2RF
Family Model : N/A
Rating(s) : DC 3V powered by Battery

Standards : FCC Part15.249

Test procedure : ANSI C63.10-2013

This device described above has been tested by NTEK, and the test results show that the equipment under test (EUT) is in compliance with the FCC requirements. And it is applicable only to the tested sample identified in the report.

This report shall not be reproduced except in full, without the written approval of NTEK, this document may be altered or revised by NTEK, personnel only, and shall be noted in the revision of the document.

Date of Test

Date (s) of performance of tests : Feb. 17, 2022 ~Mar. 10, 2022

Date of Issue : Mar. 10, 2021

Test Result : Pass

Testing Engineer :

Susan Li

(Susan Li)

Authorized Signatory :

Alex

(Sam Chen)

<b>Table of Contents</b>	<b>Page</b>
<b>1 . SUMMARY OF TEST RESULTS</b>	<b>4</b>
1.1 TEST FACILITY	5
1.2 MEASUREMENT UNCERTAINTY	5
<b>2 . GENERAL INFORMATION</b>	<b>6</b>
2.1 GENERAL DESCRIPTION OF EUT	6
2.2 DESCRIPTION OF TEST MODES	7
2.3 BLOCK DIGRAM SHOWING THE CONFIGURATION OF SYSTEM TESTED	8
2.4 DESCRIPTION OF SUPPORT UNITS(CONDUCTED MODE)	9
2.5 EQUIPMENTS LIST FOR ALL TEST ITEMS	10
<b>3 . ANTENNA REQUIREMENT</b>	<b>12</b>
3.1 STANDARD REQUIREMENT	12
3.2 EUT ANTENNA	12
3.3 CONDUCTED EMISSION MEASUREMENT	13
3.3.1 POWER LINE CONDUCTED EMISSION LIMITS	13
3.3.2 TEST PROCEDURE	13
3.3.3 DEVIATION FROM TEST STANDARD	13
3.3.4 TEST SETUP	14
3.2.5 TEST RESULT	15
3.4 RADIATED EMISSION MEASUREMENT	16
3.4.1 RADIATED EMISSION LIMITS	16
3.4.2 TEST PROCEDURE	17
3.4.3 DEVIATION FROM TEST STANDARD	17
3.4.4 TEST RESULTS (BELOW 30MHZ)	20
3.4.5 TEST RESULTS (BELOW 1000 MHZ)	21
3.4.6 TEST RESULTS (ABOVE 1000 MHZ)	23
3.4.7 TEST RESULTS (RESTRICTED BANDS REQUIREMENTS)	29
<b>4. BANDWIDTH TEST</b>	<b>33</b>
4.1 TEST PROCEDURE	33
4.2 DEVIATION FROM STANDARD	33
4.3 TEST SETUP	33
<b>5. TEST RESULTS</b>	<b>34</b>

### 1. SUMMARY OF TEST RESULTS

Test procedures according to the technical standards:

FCC Part15, Subpart C (15.249)			
Standard Section	Test Item	Judgment	Remark
15.207	Conducted Emission	N/A	
15.203	Antenna Requirement	Pass	
15.249 15.209	Radiated Spurious Emission	Pass	
15.249(a)	Fundamental Measurement	Pass	
15.205	Band Edge Emission	Pass	
15.215c	Occupied Bandwidth	Pass	

Remark:

“N/A” denotes test is not applicable in this Test Report.

### 1.1 TEST FACILITY

Shenzhen NTEK Testing Technology Co., Ltd  
 Add. : 1/F, Building E, Fenda Science Park, Sanwei Community, Xixiang Street, Bao'an District, Shenzhen 518126 P.R. China.  
 FCC FRN Registration No.:463705; IC Registration No.:9270A-1  
 CNAS Registration No.:L5516

### 1.2 MEASUREMENT UNCERTAINTY

The reported uncertainty of measurement  $y \pm U$ , where expanded uncertainty  $U$  is based on a standard uncertainty multiplied by a coverage factor of  $k=2$ , providing a level of confidence of approximately **95 %**.

No.	Item	Uncertainty
1	Conducted Emission Test	$\pm 1.38\text{dB}$
2	RF power,conducted	$\pm 0.16\text{dB}$
3	Spurious emissions,conducted	$\pm 0.21\text{dB}$
4	All emissions,radiated(<1G)	$\pm 4.68\text{dB}$
5	All emissions,radiated(>1G)	$\pm 4.89\text{dB}$
6	Temperature	$\pm 0.5^\circ\text{C}$
7	Humidity	$\pm 2\%$

## 2. GENERAL INFORMATION

### 2.1 GENERAL DESCRIPTION OF EUT

Equipment	Paste wireless switch at will
Trade Mark	N/A
Model Name	KA2RF
Family Model	N/A
Model Difference	N/A
Product Description	The EUT is a Paste wireless switch at will
	Operation Frequency: 2420MHz-2465MHz
	Modulation Type: GFSK
	Antenna Designation: PCB Antenna
	Antenna Gain(Peak) 2dBi
	Based on the application, features, or specification exhibited in User's Manual. More details of EUT technical specification, please refer to the User's Manual.
Channel List	Please refer to the Note 2.
Rating	DC 3V powered by Battery
Adapter	N/A
Battery	DC 3V,30mA
HW Version	N/A
SW Version	BKX-LGM-220109-V2

Note:

- For a more detailed features description, please refer to the manufacturer's specifications or the User's Manual.

2.

Channel	Frequency (MHz)
00	2420
01	2440
02	2465

3.

Table for Filed Antenna

Ant.	Brand	Model Name	Antenna Type	Connector	Gain (dBi)	NOTE
1	N/A	N/A	PCB Antenna	N/A	2	Antenna

## 2.2 DESCRIPTION OF TEST MODES

To investigate the maximum EMI emission characteristics generates from EUT, the test system was pre-scanning tested base on the consideration of following EUT operation mode or test configuration mode which possible have effect on EMI emission level. Each of these EUT operation mode(s) or test configuration mode(s) mentioned above was evaluated respectively.

Pretest Mode	Description
Mode 1	TX 2420MHz
Mode 2	TX 2440MHz
Mode 3	TX 2465MHz
Mode 4	Normal link

### For Radiated Spurious Emission

Pretest Mode	Description
Mode 1	TX 2420MHz
Mode 2	TX 2440MHz
Mode 3	TX 2465MHz

### For Conducted Emission

Final Test Mode	Description
Mode 1	TX 2420MHz
Mode 2	TX 2440MHz
Mode 3	TX 2465MHz
Mode 4	Normal link

Note:

(1) The measurements are performed at the highest, middle, lowest available channels.

### 2.3 BLOCK DIGRAM SHOWING THE CONFIGURATION OF SYSTEM TESTED

Conducted Emission Mode

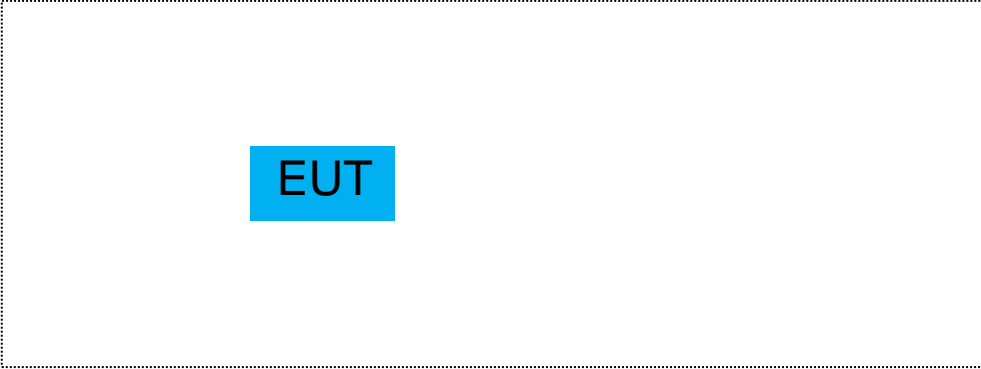

Radiated Spurious Emission Test

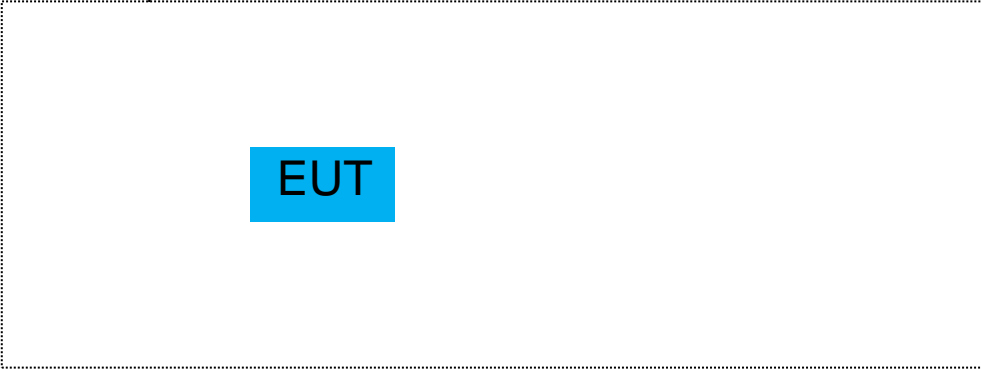



**2.4 DESCRIPTION OF SUPPORT UNITS(CONDUCTED MODE)**

The EUT has been tested as an independent unit together with other necessary accessories or support units. The following support units or accessories were used to form a representative test configuration during the tests.

Item	Equipment	Mfr/Brand	Model/Type No.	Series No.	Note

Item	Cable Type	Shielded Type	Ferrite Core	Length	Note

Note:

- (1) The support equipment was authorized by Declaration of Confirmation.
- (2) For detachable type I/O cable should be specified the length in cm in 『Length』 column.

## 2.5 EQUIPMENTS LIST FOR ALL TEST ITEMS

### Radiation Test equipment

	Kind of Equipment	Manufacturer	Type No.	Serial No.	Last calibration	Calibrated until	Calibration period
1	Spectrum Analyzer	Agilent	E4407B	MY45108040	2021.04.27	2022.04.26	1 year
2	Spectrum Analyzer	Agilent	N9020A	MY49100060	2021.07.01	2022.06.30	1 year
3	Spectrum Analyzer	R&S	FSV40	101417	2021.07.01	2022.06.30	1 year
4	Test Receiver	R&S	ESPI7	101318	2021.04.27	2022.04.26	1 year
5	Bilog Antenna	TESEQ	CBL6111D	31216	2021.03.29	2022.03.28	1 year
6	50Ω Coaxial Switch	Anritsu	MP59B	6200983705	2020.05.11	2023.05.10	3 year
7	Horn Antenna	EM	EM-AH-10180	2011071402	2021.03.29	2022.03.28	1 year
8	Broadband Horn Antenna	SCHWARZBECK	BBHA 9170	803	2021.11.7	2022.11.6	1 year
9	Amplifier	EMC	EMC051835SE	980246	2021.07.01	2022.06.30	1 year
10	Active Loop Antenna	SCHWARZBECK	FMZB 1519B	055	2021.11.7	2022.11.6	1 year
11	Power Meter	DARE	RPR3006W	15100041SN084	2021.07.01	2022.06.30	1 year
12	Test Cable (9KHz-30MHz)	N/A	R-01	N/A	2019.08.06	2022.08.05	3 year
13	Test Cable (30MHz-1GHz)	N/A	R-02	N/A	2019.08.06	2022.08.05	3 year
14	High Test Cable(1G-40G Hz)	N/A	R-03	N/A	2019.06.28	2022.06.27	3 year
15	High Test Cable(1G-40G Hz)	N/A	R-04	N/A	2019.08.06	2022.08.05	1 year
16	Filter	TRILTHIC	2400MHz	29	2021.07.01	2022.06.30	1 year
17	temporary antenna connector (Note)	NTS	R001	N/A	N/A	N/A	N/A

**Note:**

We will use the temporary antenna connector (soldered on the PCB board) When conducted test  
And this temporary antenna connector is listed within the instrument list

**Conduction Test equipment**

Item	Kind of Equipment	Manufacturer	Type No.	Serial No.	Last calibration	Calibrated until	Calibration period
1	Test Receiver	R&S	ESCI	101160	2021.04.27	2022.04.26	1 year
2	LISN	R&S	ENV216	101313	2021.04.27	2022.04.26	1 year
3	LISN	SCHWARZBECK	NNLK 8129	8129245	2021.04.27	2022.04.26	1 year
4	50Ω Coaxial Switch	ANRITSU CORP	MP59B	6200983704	2020.05.11	2023.05.10	3 year
5	Test Cable (9KHz-30MHz)	N/A	C01	N/A	2020.05.11	2023.05.10	3 year
6	Test Cable (9KHz-30MHz)	N/A	C02	N/A	2020.05.11	2023.05.10	3 year
7	Test Cable (9KHz-30MHz)	N/A	C03	N/A	2020.05.11	2023.05.10	3 year

Note: Each piece of equipment is scheduled for calibration once a year except the Test Cable which is scheduled for calibration every 3 years.

### 3. ANTENNA REQUIREMENT

#### 3.1 STANDARD REQUIREMENT

15.203 requirement: For intentional device, according to 15.203: an intentional radiator shall be designed to ensure that no antenna other than that furnished by the responsible party shall be used with the device.

#### 3.2 EUT ANTENNA

The EUT antenna is permanent attached PCB antenna(Gain:2dBi). It comply with the standard requirement.

### 3.3 CONDUCTED EMISSION MEASUREMENT

#### 3.3.1 POWER LINE CONDUCTED EMISSION Limits (Frequency Range 150KHz-30MHz)

Frequency(MHz)	Conducted Emission Limit	
	Quasi-peak	Average
0.15-0.5	66-56*	56-46*
0.5-5.0	56	46
5.0-30.0	60	50

Note: 1. \*Decreases with the logarithm of the frequency  
 2. The lower limit shall apply at the transition frequencies  
 3. The limit decreases in line with the logarithm of the frequency in the range of 0.15 to 0.50MHz.

The following table is the setting of the receiver

Receiver Parameters	Setting
Attenuation	10 dB
Start Frequency	0.15 MHz
Stop Frequency	30 MHz
IF Bandwidth	9 kHz

#### 3.3.2 TEST PROCEDURE

- a. The EUT was placed 0.4 meters from the horizontal ground plane with EUT being connected to the power mains through a line impedance stabilization network (LISN). All other support equipments powered from additional LISN(s). The LISN provide 50 Ohm/ 50uH of coupling impedance for the measuring instrument.
- b. Interconnecting cables that hang closer than 40 cm to the ground plane shall be folded back and forth in the center forming a bundle 30 to 40 cm long.
- c. I/O cables that are not connected to a peripheral shall be bundled in the center. The end of the cable may be terminated, if required, using the correct terminating impedance. The overall length shall not exceed 1 m.
- d. LISN at least 80 cm from nearest part of EUT chassis.
- e. For the actual test configuration, please refer to the related Item –EUT Test Photos.  
 Margin=Measure-ment-Limits, Measure-ment=Reading level+Correct Factor

#### 3.3.3 DEVIATION FROM TEST STANDARD

No deviation

3.3.4 TEST SETUP

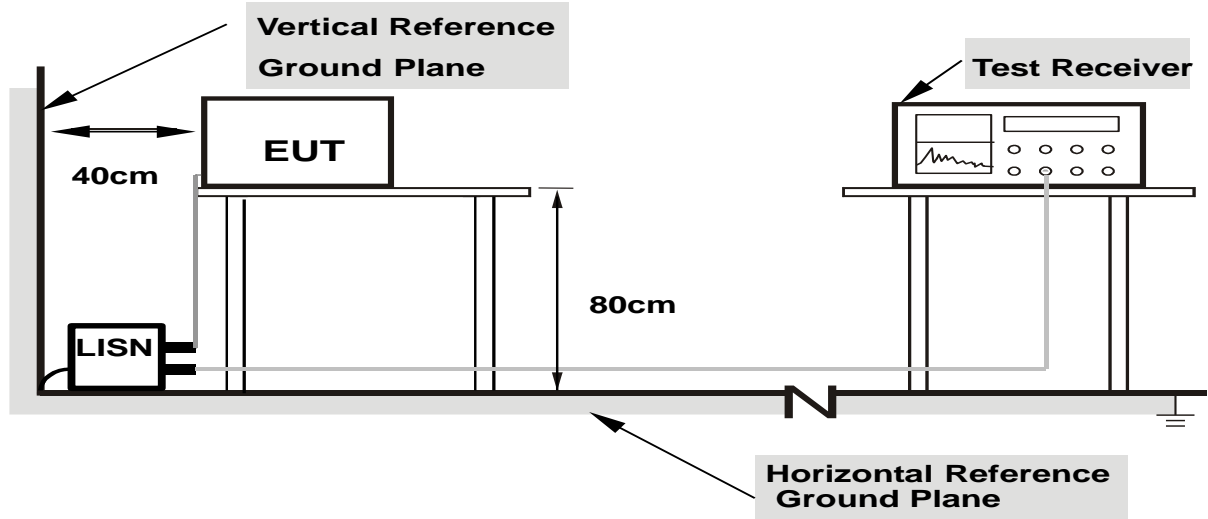

- Note:**
1. Support units were connected to second LISN.
  2. Both of LISNs (AMN) are 80 cm from EUT and at least 80 from other units and other metal planes

**3.2.5 TEST RESULT**

EUT :	Paste wireless switch at will	Model Name :	KA2RF
Temperature :	26 °C	Relative Humidity :	54%
Pressure :	1010hPa	Phase :	N/A
Test Voltage :	N/A	Test Mode :	N/A

Note: This product can only be powered by battery, no charging port, so no AC power-line conducted test is required.

### 3.4 RADIATED EMISSION MEASUREMENT

#### 3.4.1 Radiated Emission Limits ( FCC 15.209 )

Frequencies (MHz)	Field Strength (micorvolts/meter)	Measurement Distance (meters)
0.009~0.490	2400/F(KHz)	300
0.490~1.705	24000/F(KHz)	30
1.705~30.0	30	30
Frequency (MHz)	Limit (dBuV)	
30~88	40	3
88~216	43.5	3
216~960	46	3
960 -10000	54.00	3
*902 - 928	94.00	3

Note:

- (1) The tighter limit applies at the band edges.
- (2) Emission level (dBuV/m)=20log Emission level (uV/m).
- (3) \*Note: This is the limit for the fundamental frequency.

#### LIMITS OF RADIATED EMISSION MEASUREMENT ( FCC 15.249)

Frequency of Emission (MHz)	Field Strength of fundamental ((millivolts /meter)	Field Strength of Harmonics (microvolts/meter)
2400-2483.5	50	500

Notes:

- (1) Emissions radiated outside of the specified frequency bands, except for harmonics, shall be attenuated by at least 50 dB below the level of the fundamental or to the general radiated emission limits in Section 15.209, whichever is the lesser attenuation.

Spectrum Parameter	Setting
Attenuation	Auto
Start Frequency	1000 MHz
Stop Frequency	10th carrier harmonic
RB / VB (emission in restricted band)	1MHz / 1MHz for Peak

Receiver Parameter	Setting
Attenuation	Auto
Start ~ Stop Frequency	9kHz~150kHz / RB 200Hz for QP
Start ~ Stop Frequency	150kHz~30MHz / RB 9kHz for QP
Start ~ Stop Frequency	30MHz~1000MHz / RB 120kHz for QP



### 3.4.2 TEST PROCEDURE

- a. The measuring distance of at 3 m shall be used for measurements at frequency up to 1GHz. For frequencies above 1GHz, any suitable measuring distance may be used.
- b. The EUT was placed on the top of a rotating table 0.8 m for below 1GHz and 1.5m for above 1GHz the ground at a 3 meter. The table was rotated 360 degrees to determine the position of the highest radiation.
- c. The height of the equipment or of the substitution antenna shall be 0.8 m for below 1GHz and 1.5m for above 1GHz; the height of the test antenna shall vary between 1 m to 4 m. Both horizontal and vertical polarizations of the antenna are set to make the measurement.
- d. The initial step in collecting conducted emission data is a spectrum analyzer peak detector mode pre-scanning the measurement frequency range. Significant peaks are then marked and then Quasi Peak detector mode re-measured.
- e. If the Peak Mode measured value compliance with and lower than Quasi Peak Mode Limit, the EUT shall be deemed to meet QP Limits and then no additional QP Mode measurement performed.
- f. For the actual test configuration, please refer to the related Item –EUT Test Photos.

Note:

Both horizontal and vertical antenna polarities were tested and performed pretest to three orthogonal axis. The worst case emissions were reported

### 3.4.3 DEVIATION FROM TEST STANDARD

No deviation

(A) Radiated Emission Test-Up Frequency Below 30MHz

(a)

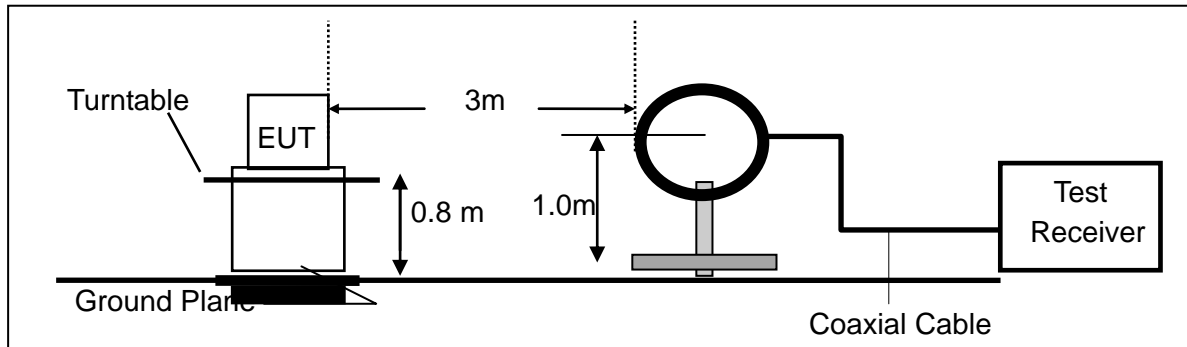

(B) Radiated Emission Test-Up Frequency 30MHz~1GHz

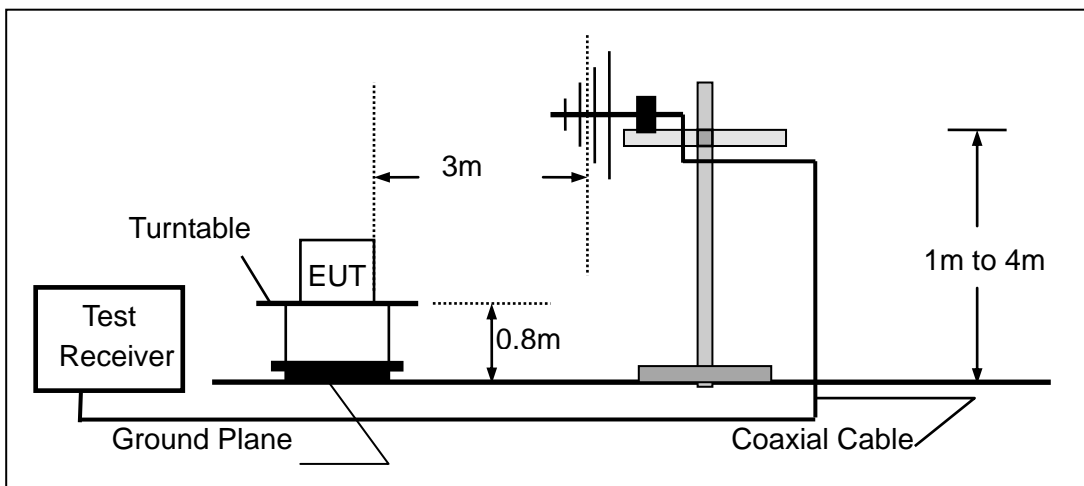

(C) Radiated Emission Test-Up Frequency Above 1GHz

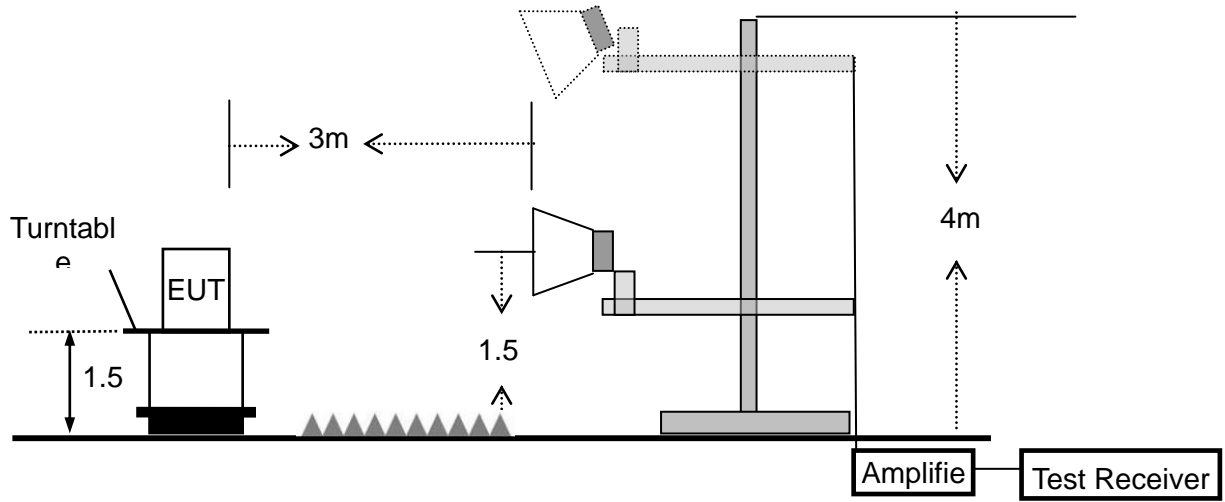

### 3.4.4 TEST RESULTS (BELOW 30MHz)

EUT :	Paste wireless switch at will	Model Name. :	KA2RF
Temperature :	20 °C	Relative Humidity :	48%
Pressure :	1010 hPa	Test Voltage :	DC 3V
Test Mode :	TX	Polarization :	--

Freq.	Reading	Limit	Margin	State
(MHz)	(dBuV/m)	(dBuV/m)	(dB)	P/F
--	--	--	--	PASS
--	--	--	--	PASS

**NOTE:**

The amplitude of spurious emissions which are attenuated by more than 20dB below the permissible value has no need to be reported.

Remark:1. Emission level in dBuV/m= $20 \log(uV/m)$

2. Measurement was performed at an antenna to the closed point of EUT distance of meters.

3. For Frequency 9kHz~30MHz:

Distance extrapolation factor = $40\log(\text{Specific distance/ test distance})(dB)$ ;

Limit line=Specific limits(dBuV) + distance extrapolation factor.

For Frequency above 30MHz:

Distance extrapolation factor = $20\log(\text{Specific distance/ test distance})(dB)$ ;

Limit line=Specific limits(dBuV) + distance extrapolation factor.

**3.4.5 TEST RESULTS (BELOW 1000 MHz)**

EUT :	Paste wireless switch at will	Model Name :	KA2RF
Temperature :	25 °C	Relative Humidity :	51%
Pressure :	1010 hPa	Test Voltage :	DC 3V
Test Mode :	Model 4	Polarization :	Vertical

Polar (H/V)	Frequency	Meter Reading	Factor	Emission Level	Limits	Margin	Remark
	(MHz)	(dBuV)	(dB)	(dBuV/m)	(dBuV/m)	(dB)	
V	33.0949	11.62	17.53	29.15	40.00	-10.85	QP
V	40.1347	15.10	13.96	29.06	40.00	-10.94	QP
V	47.4917	20.88	10.81	31.69	40.00	-8.31	QP
V	54.0711	22.86	7.14	30.00	40.00	-10.00	QP
V	60.2800	23.24	5.97	29.21	40.00	-10.79	QP
V	74.9191	21.18	7.25	28.43	40.00	-11.57	QP

**Remark:**

Absolute Level= ReadingLevel+ Factor, Margin= Absolute Level - Limit

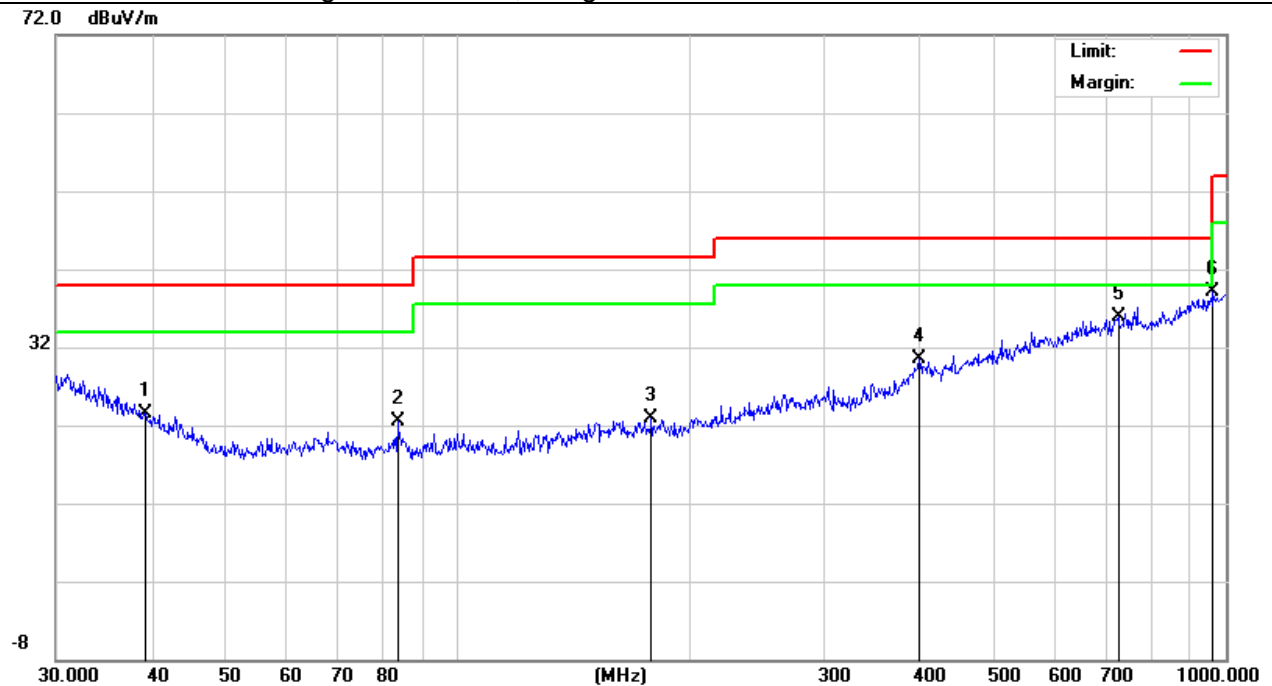

Polar (H/V)	Frequency	Meter Reading	Factor	Emission Level	Limits	Margin	Remark
	(MHz)	(dBuV)	(dB)	(dBuV/m)	(dBuV/m)	(dB)	
H	39.2991	4.75	18.77	23.52	40.00	-16.48	QP
H	83.5222	8.11	14.32	22.43	40.00	-17.57	QP
H	178.7584	5.90	16.98	22.88	43.50	-20.62	QP
H	399.0302	5.72	24.75	30.47	46.00	-15.53	QP
H	724.2611	7.10	28.87	35.97	46.00	-10.03	QP
H	962.1622	7.10	31.92	39.02	54.00	-14.98	QP

**Remark:**

Absolute Level= ReadingLevel+ Factor, Margin= Absolute Level - Limit

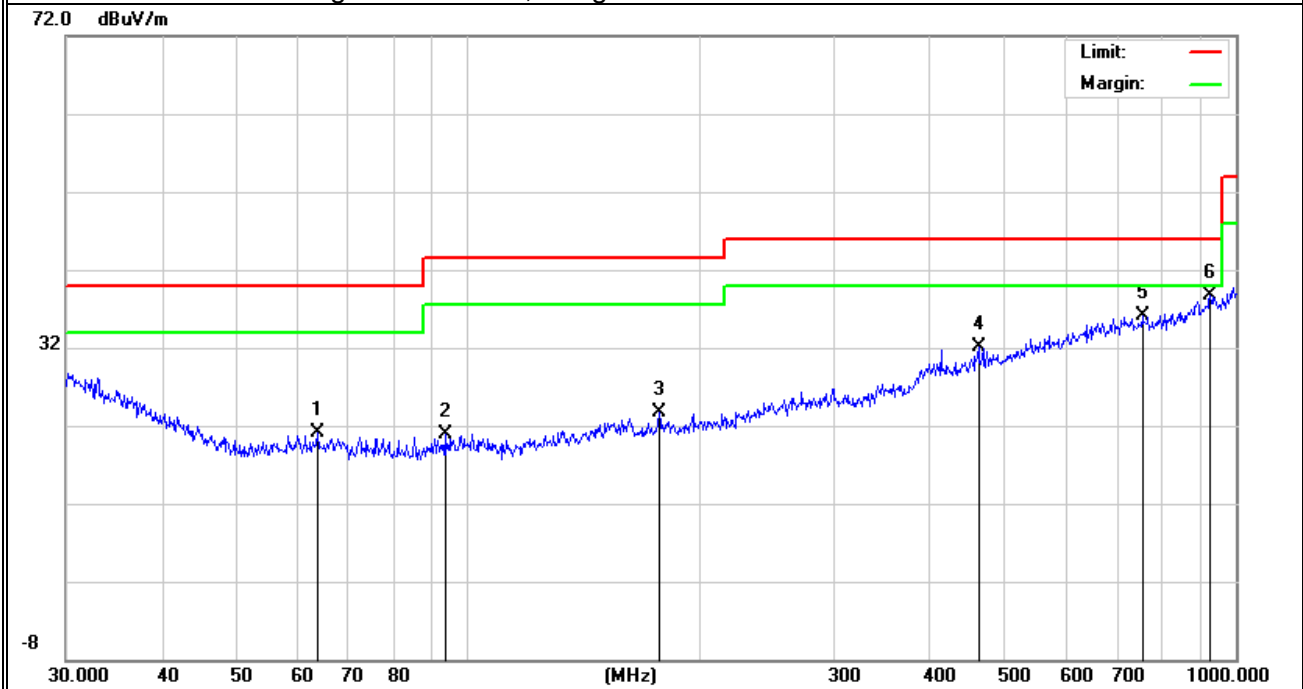

**3.4.6 TEST RESULTS (ABOVE 1000 MHZ)**

Note: For above 18GHz, the amplitude of spurious emissions which are attenuated by more than 20dB below the permissible value has no need to be reported.

EUT :	Paste wireless switch at will	Model Name :	KA2RF
Temperature :	25 °C	Relative Humidity :	51%
Pressure :	1010 hPa	Test Voltage :	DC 3V
Test Mode :	TX 2420MHz	Polarization :	Horizontal

Frequency (MHz)	Meter Reading (dBμV)	Factor (dB)	Emission Level (dBμV/m)	Limits (dBμV/m)	Margin (dB)	Detector Type
2420.0000	78.45	1.05	79.5	114.00	-34.5	peak
2420.0000	67.32	1.05	68.37	94.00	-25.63	AVG
13452.5000	35.33	15.17	50.50	74.00	-23.5	peak
13452.5000	24.81	15.17	39.98	54.00	-14.02	AVG

Remark:  
Factor = Antenna Factor + Cable Loss – Pre-amplifier.

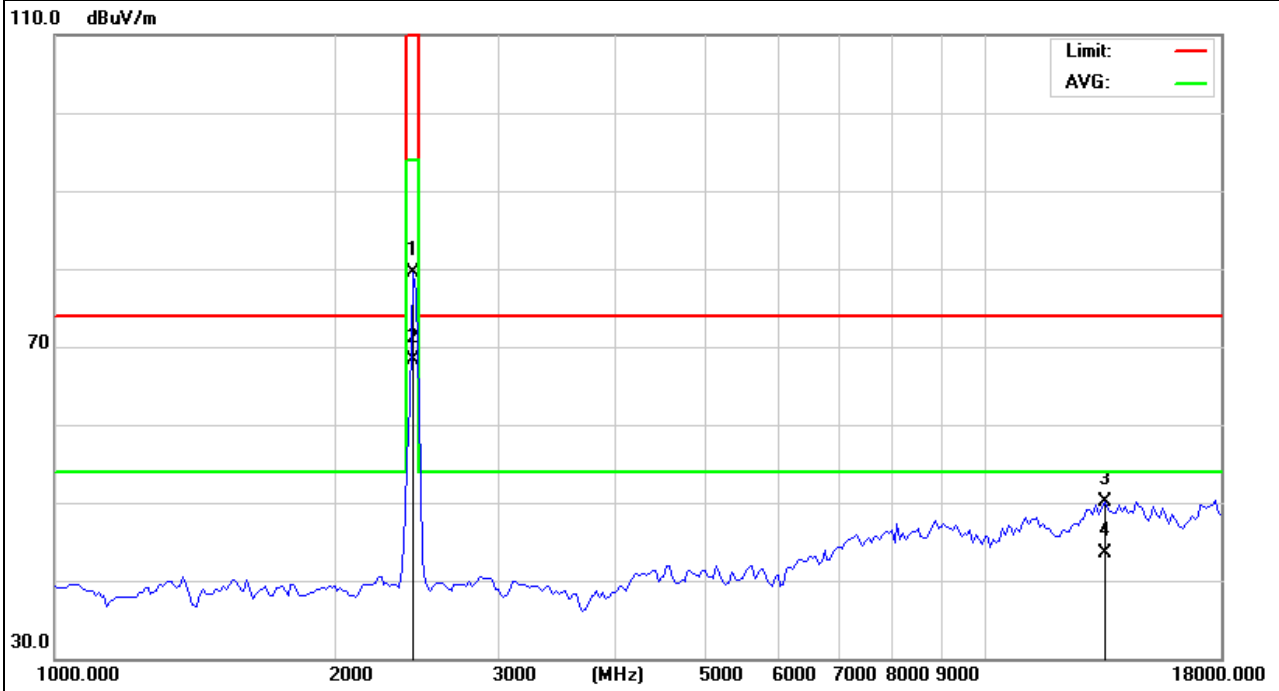

EUT :	Paste wireless switch at will	Model Name :	KA2RF
Temperature :	25 °C	Relative Humidity :	51%
Pressure :	1010 hPa	Test Voltage :	DC 3V
Test Mode :	TX 2420MHz	Polarization :	Vertical

Frequency (MHz)	Meter Reading (dBμV)	Factor (dB)	Emission Level (dBμV/m)	Limits (dBμV/m)	Margin (dB)	Detector Type
2420.0000	77.67	1.05	78.72	114.00	-35.28	peak
2420.0000	68.51	1.05	69.56	94.00	-24.44	AVG
13580.0000	35.68	15.32	51.00	74.00	-23.00	peak
13580.0000	21.84	15.32	37.16	54.00	-16.84	AVG

Remark:  
Factor = Antenna Factor + Cable Loss – Pre-amplifier.  
No emission above 18GHz.

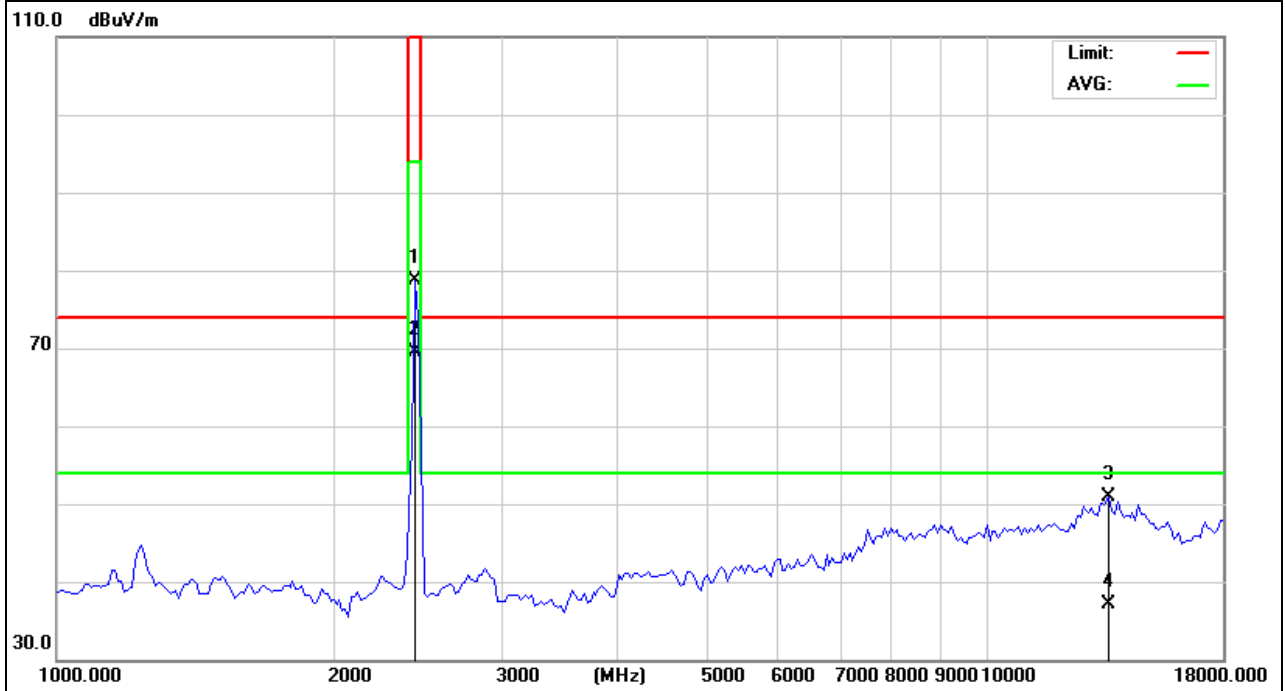

Note: EUT Pre-scan X/Y/Z orientation, only worst case is presented in the report(X orientation).



EUT :	Paste wireless switch at will	Model Name :	KA2RF
Temperature :	25 °C	Relative Humidity :	51%
Pressure :	1010 hPa	Test Voltage :	DC 3V
Test Mode :	TX 2440MHz	Polarization :	Horizontal

Frequency (MHz)	Meter Reading (dBμV)	Factor (dB)	Emission Level (dBμV/m)	Limits (dBμV/m)	Margin (dB)	Detector Type
2440.0000	80.53	1.11	81.64	114.00	-32.36	peak
2440.0000	71.75	1.11	72.86	94.00	-21.14	AVG
14005.0000	35.31	15.59	50.90	74.00	-23.10	peak
14005.0000	24.21	15.59	39.80	54.00	-14.20	AVG

Remark:  
Factor = Antenna Factor + Cable Loss – Pre-amplifier.

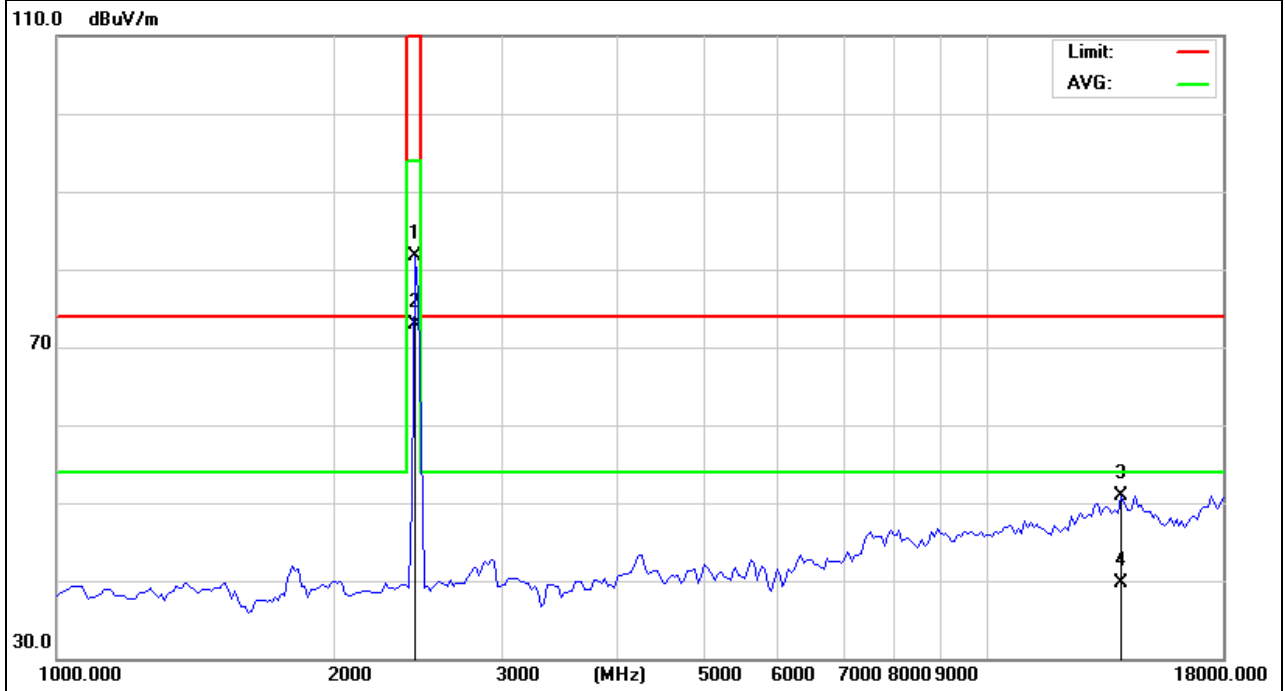

EUT :	Paste wireless switch at will	Model Name :	KA2RF
Temperature :	25 °C	Relative Humidity :	51%
Pressure :	1010 hPa	Test Voltage :	DC 3V
Test Mode :	TX 2440MHz	Polarization :	Vertical

Frequency (MHz)	Meter Reading (dBμV)	Factor (dB)	Emission Level (dBμV/m)	Limits (dBμV/m)	Margin (dB)	Detector Type
2440.0000	76.79	1.11	77.90	114.00	-36.10	peak
2440.0000	67.81	1.11	68.92	94.00	-25.08	AVG
11072.5000	35.36	14.08	49.44	74.00	-24.56	peak
11072.5000	23.54	14.08	37.62	54.00	-16.38	AVG

Remark:  
Factor = Antenna Factor + Cable Loss – Pre-amplifier.

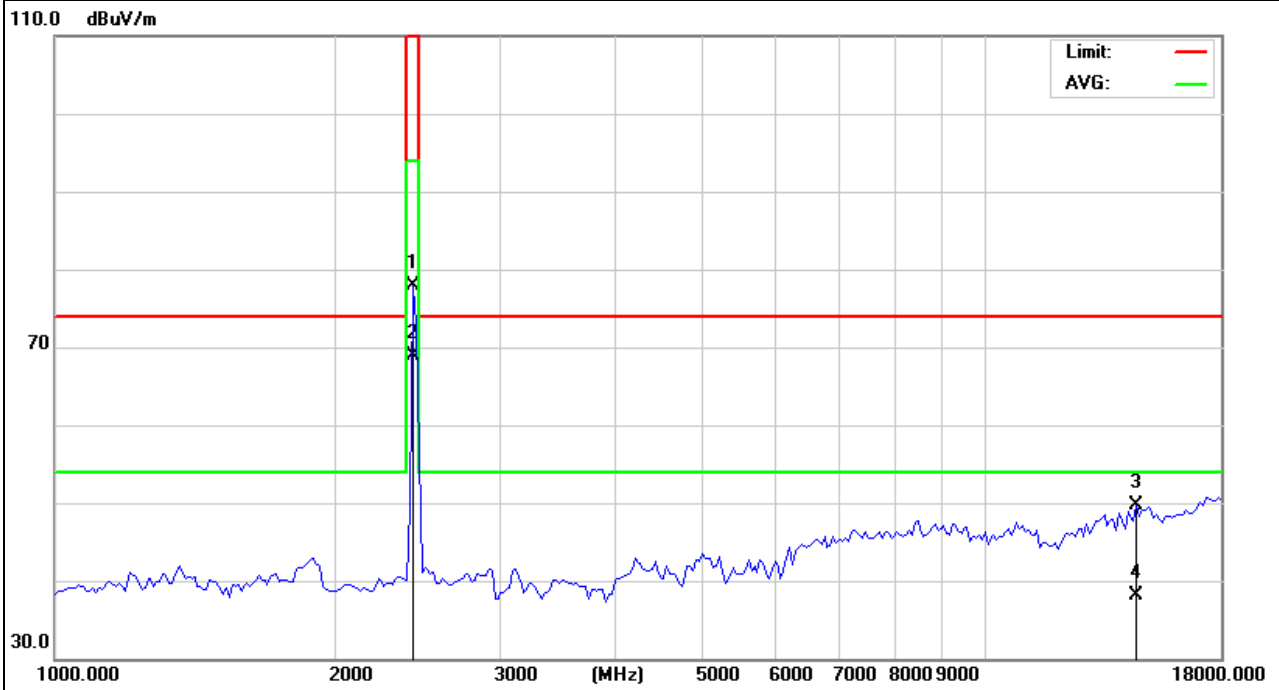

EUT :	Paste wireless switch at will	Model Name :	KA2RF
Temperature :	25 °C	Relative Humidity :	51%
Pressure :	1010 hPa	Test Voltage :	DC 3V
Test Mode :	TX 2465MHz	Polarization :	Horizontal

Frequency (MHz)	Meter Reading (dBμV)	Factor (dB)	Emission Level (dBμV/m)	Limits (dBμV/m)	Margin (dB)	Detector Type
2465.0000	59.63	1.18	60.81	114.00	-53.19	peak
2465.0000	50.69	1.18	51.87	94.00	-42.13	AVG
11072.5000	35.36	14.08	49.44	74.00	-24.56	peak
11072.5000	23.54	14.08	37.62	54.00	-16.38	AVG

Remark:  
Factor = Antenna Factor + Cable Loss – Pre-amplifier.

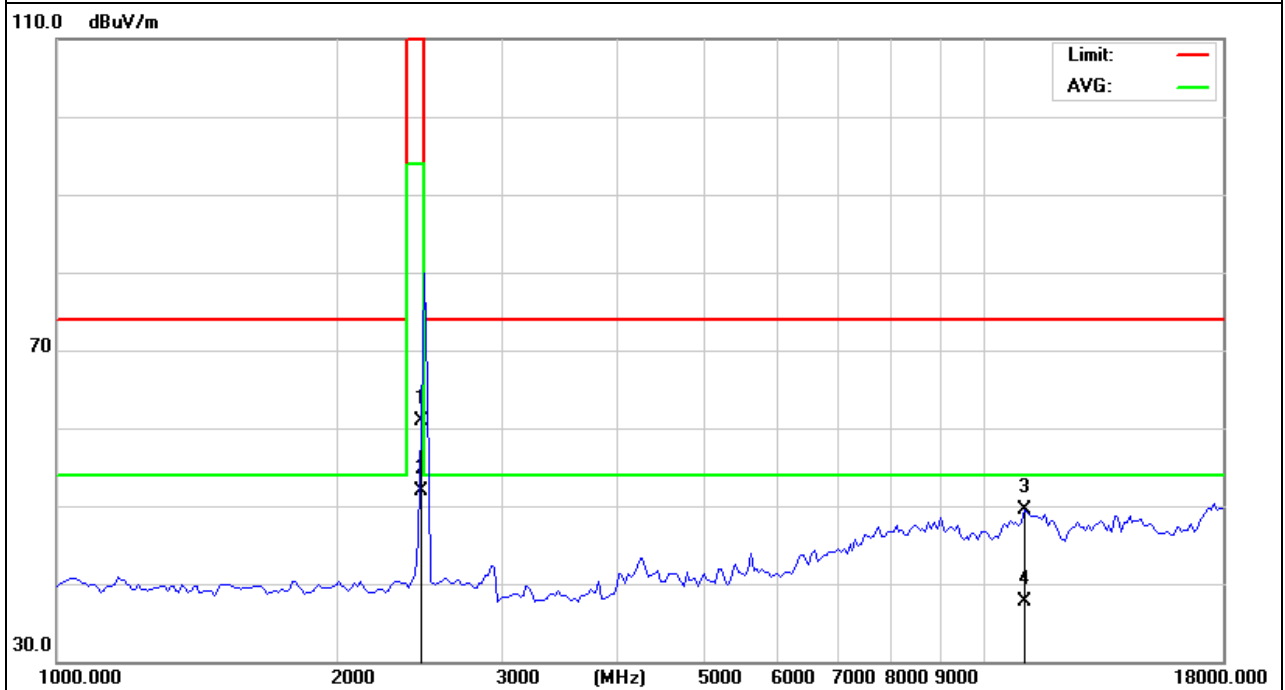

EUT :	Paste wireless switch at will	Model Name :	KA2RF
Temperature :	25 °C	Relative Humidity :	51%
Pressure :	1010 hPa	Test Voltage :	DC 3V
Test Mode :	TX 2465MHz	Polarization :	Vertical

Frequency (MHz)	Meter Reading (dBμV)	Factor (dB)	Emission Level (dBμV/m)	Limits (dBμV/m)	Margin (dB)	Detector Type
2465.0000	58.73	1.18	59.91	114.00	-54.09	peak
2465.0000	49.87	1.18	51.05	94.00	-42.95	AVG
9117.5000	37.74	12.32	50.06	74.00	-23.94	peak
9117.5000	25.80	12.32	38.12	54.00	-15.88	AVG

Remark:  
Factor = Antenna Factor + Cable Loss – Pre-amplifier.

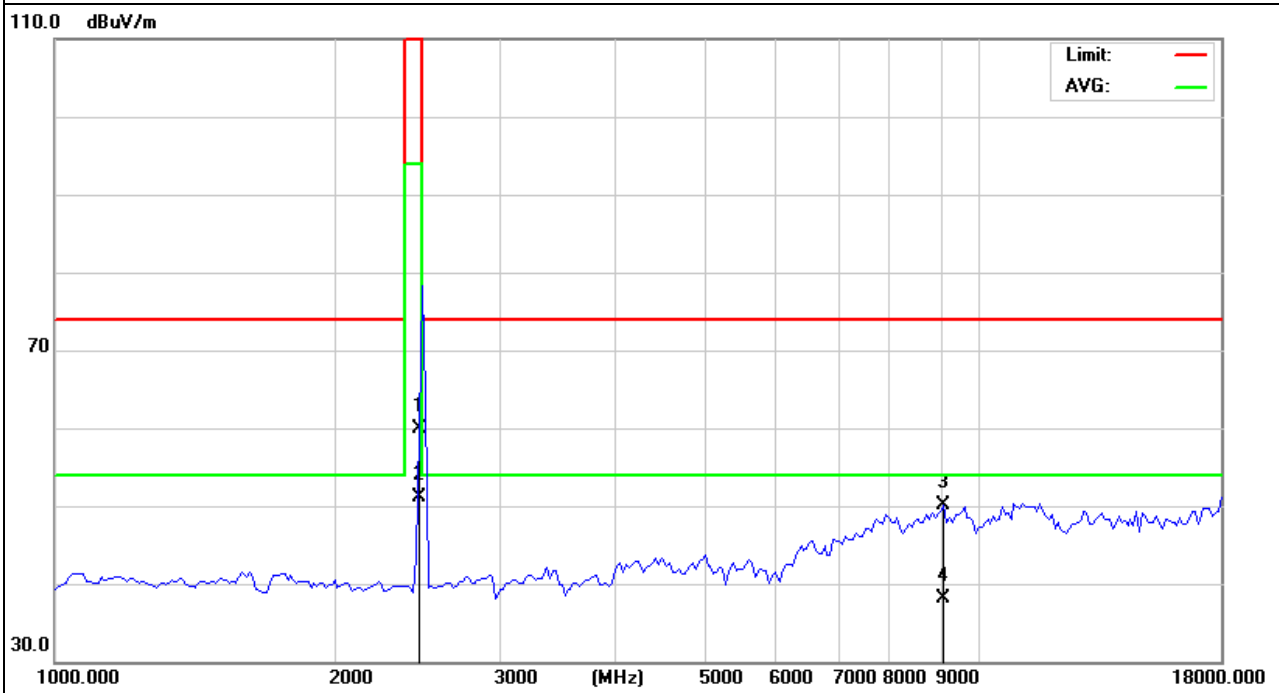

Note: EUT Pre-scan X/Y/Z orientation, only worst case is presented in the report(X orientation).

**3.4.7 TEST RESULTS (RESTRICTED BANDS REQUIREMENTS)**

EUT :	Paste wireless switch at will	Model Name :	KA2RF
Temperature :	25 °C	Relative Humidity :	51%
Pressure :	1010 hPa	Test Voltage :	DC 3V
Test Mode :	TX 2420MHz	Polarization :	Horizontal

Frequency (MHz)	Meter Reading (dBμV)	Factor (dB)	Emission Level (dBμV/m)	Limits (dBμV/m)	Margin (dB)	Detector Type
2402.0000	35.81	0.99	36.8	114.00	-77.2	peak
2402.0000	29.51	0.99	30.5	94.00	-63.5	AVG

Remark:  
Factor = Antenna Factor + Cable Loss – Pre-amplifier.

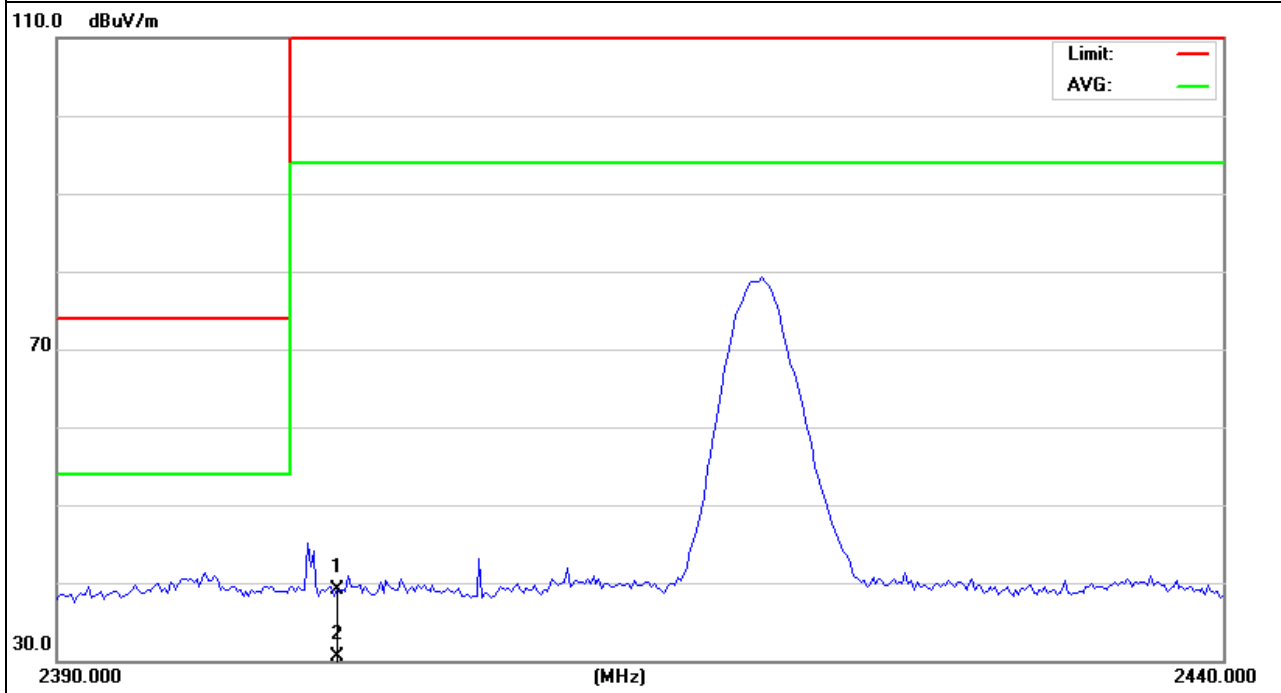

EUT :	Paste wireless switch at will	Model Name :	KA2RF
Temperature :	25 °C	Relative Humidity :	51%
Pressure :	1010 hPa	Test Voltage :	DC 3V
Test Mode :	TX 2420MHz	Polarization :	Vertical

Frequency (MHz)	Meter Reading (dB $\mu$ V)	Factor (dB)	Emission Level (dB $\mu$ V/m)	Limits (dB $\mu$ V/m)	Margin (dB)	Detector Type
2402.0000	38.02	0.99	39.01	114.00	-74.99	peak
2402.0000	29.48	0.99	30.47	94.00	-63.53	AVG

Remark:  
Factor = Antenna Factor + Cable Loss – Pre-amplifier.

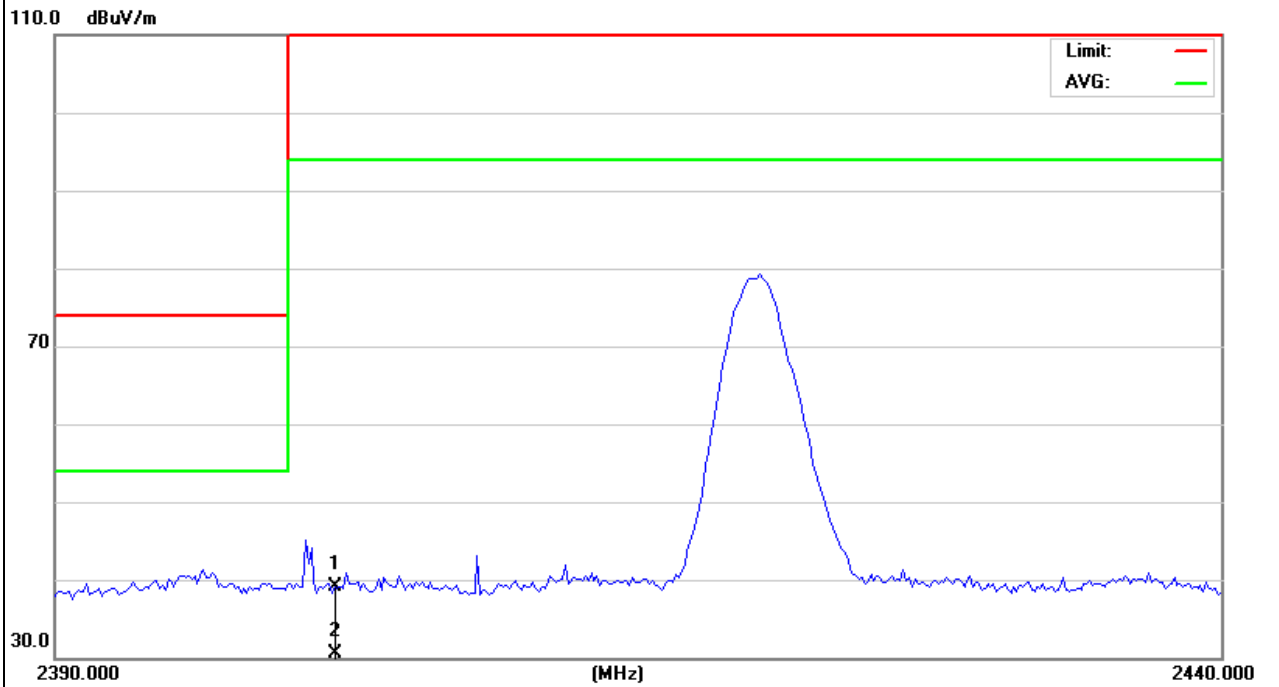

EUT :	Paste wireless switch at will	Model Name :	KA2RF
Temperature :	25 °C	Relative Humidity :	51%
Pressure :	1010 hPa	Test Voltage :	DC 3V
Test Mode :	TX 2465MHz	Polarization :	Horizontal

Frequency (MHz)	Meter Reading (dBμV)	Factor (dB)	Emission Level (dBμV/m)	Limits (dBμV/m)	Margin (dB)	Detector Type
2483.5000	37.61	1.23	38.84	74.00	-35.16	peak
2483.5000	30.06	1.23	31.29	54.00	-22.71	AVG

Remark:  
Factor = Antenna Factor + Cable Loss – Pre-amplifier.

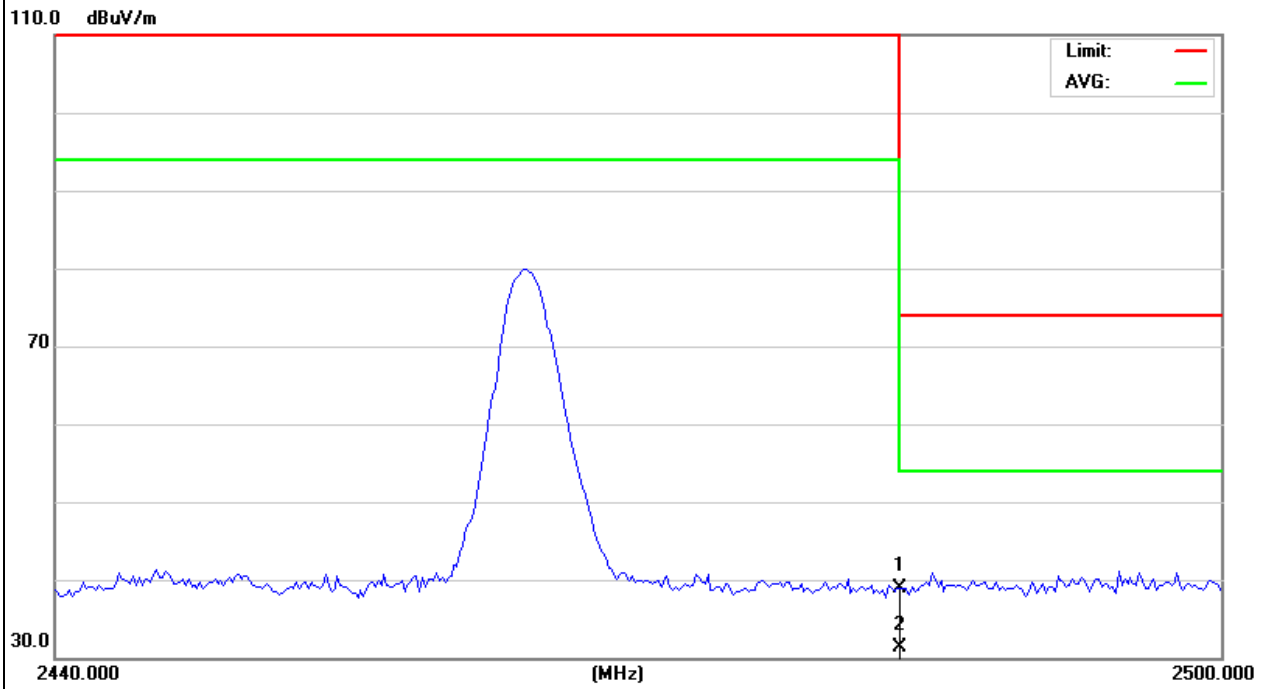

EUT :	Paste wireless switch at will	Model Name :	KA2RF
Temperature :	25 °C	Relative Humidity :	51%
Pressure :	1010 hPa	Test Voltage :	DC 3V
Test Mode :	TX 2465MHz	Polarization :	Vertical

Frequency (MHz)	Meter Reading (dBμV)	Factor (dB)	Emission Level (dBμV/m)	Limits (dBμV/m)	Margin (dB)	Detector Type
2483.5000	38.69	1.23	39.92	74.00	-34.08	peak
2483.5000	30.22	1.23	31.45	54.00	-22.55	AVG

Remark:  
Factor = Antenna Factor + Cable Loss – Pre-amplifier.

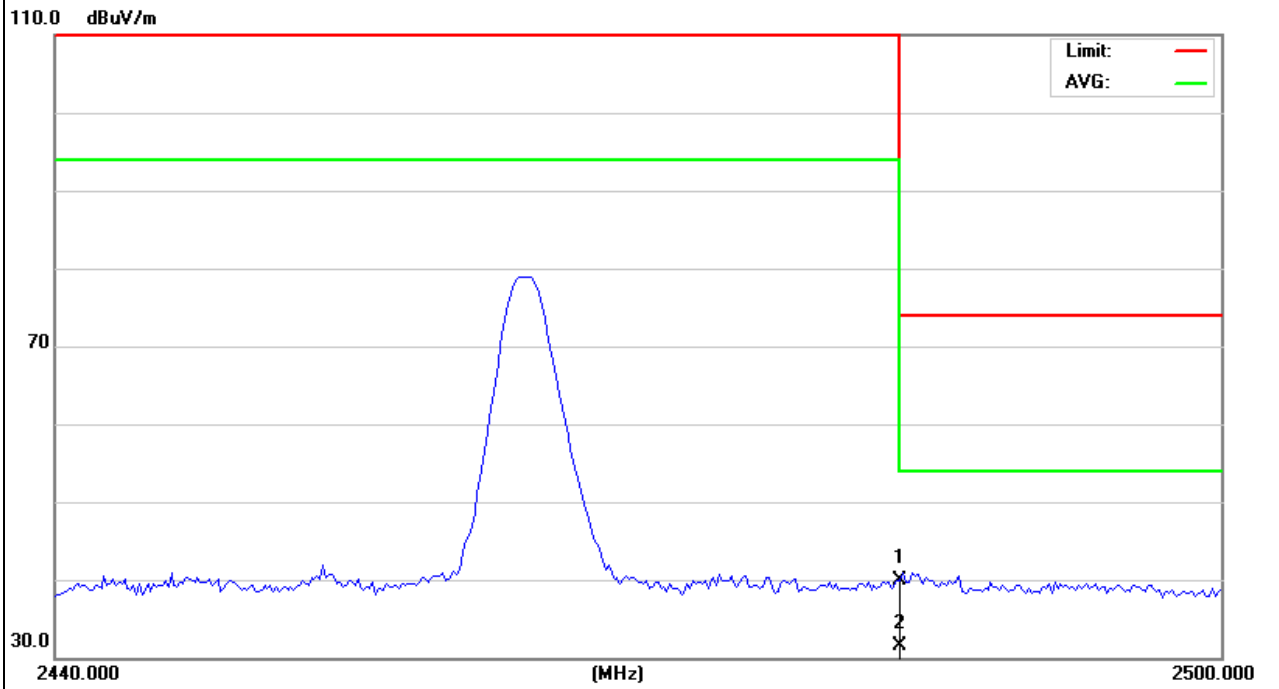



## 4. BANDWIDTH TEST

### 4.1 TEST PROCEDURE

- a. The EUT was directly connected to the spectrum analyzer and antenna output port as show in the block diagram below,
- b. Spectrum Setting : RBW= 100KHz, VBW $\geq$ RBW, Sweep time = Auto.

### 4.2 DEVIATION FROM STANDARD

No deviation.

### 4.3 TEST SETUP



5. TEST RESULTS

EUT :	Paste wireless switch at will	Model Name :	KA2RF
Temperature :	26 °C	Relative Humidity :	53%
Pressure :	1020 hPa	Test Power :	DC 3V
Test Mode :	TX(2420MHz/2440MHz/2465MHz)		

Test Frequency (MHz)	20 dBc Bandwidth (MHz)
2420	1.182
2440	1.177
2465	1.184

20 dBc Bandwidth 2420 MHz

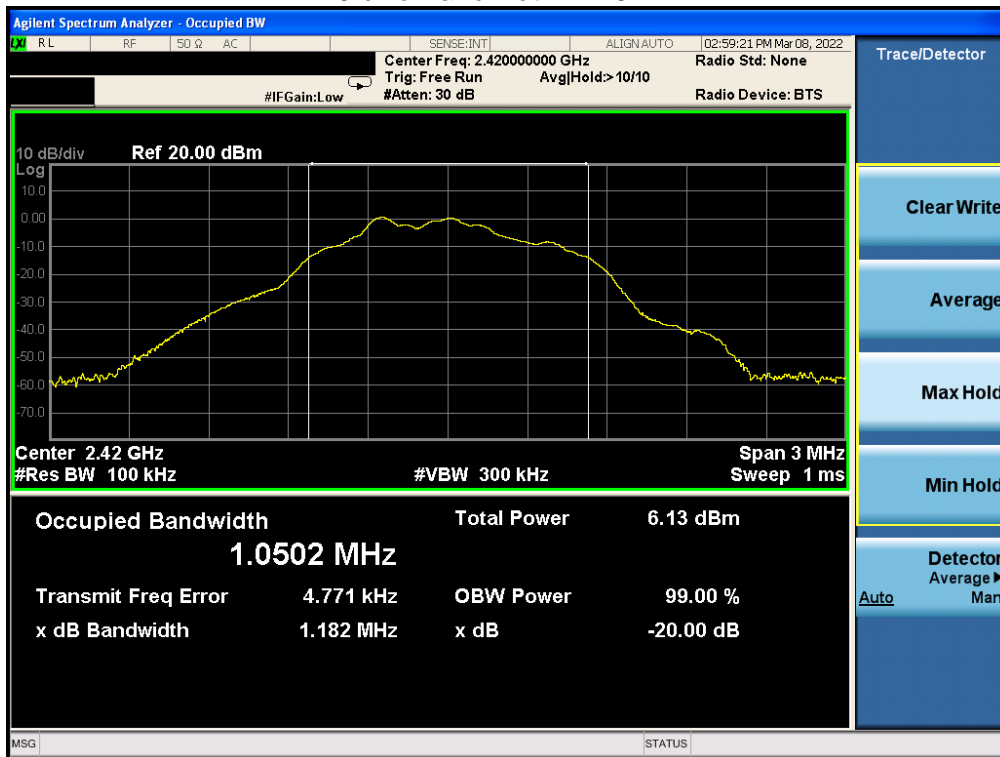

20 dBc Bandwidth 2440MHz

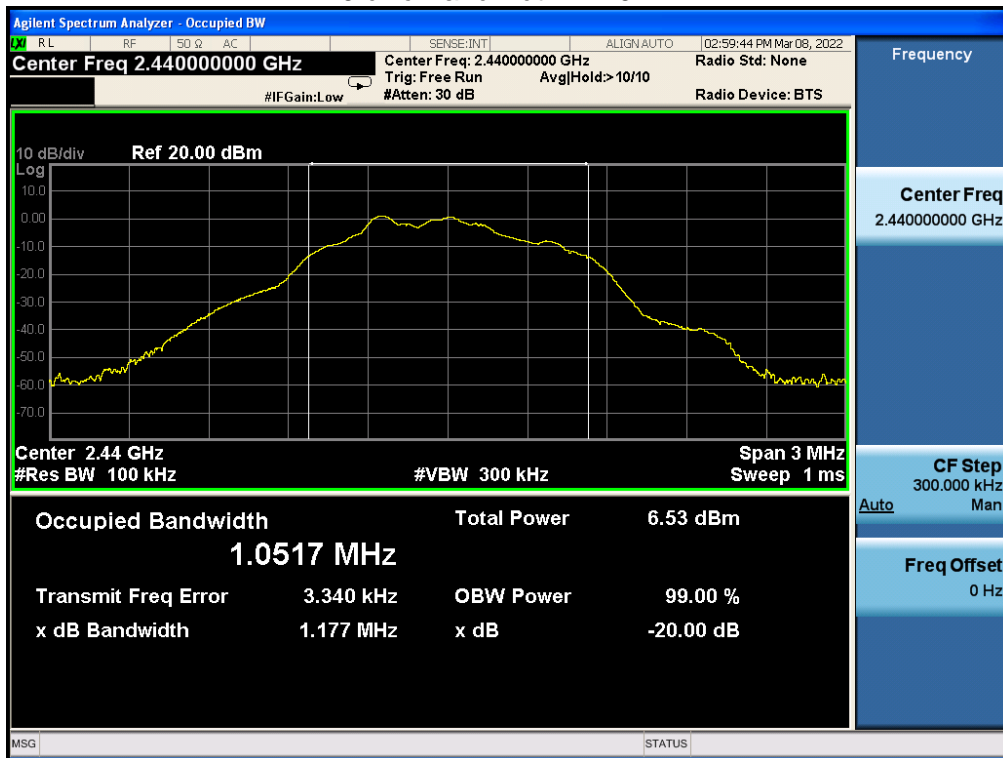

20 dBc Bandwidth 2465MHz



END OF REPORT