

标签粘贴处

Richmat 豪江
Model: HJH8B
 Contains FCC ID: 2AITPHJC0

CE

This device complies with Part 15 of the FCC Rules. Operation is subject to the following two conditions:
 (1) this device may not cause harmful interference, and
 (2) this device must accept any interference received, including interference that may cause undesired operation.

				编号	HJH8B	名称	总装图		
				材质	—	比例	1:2	设计	谭英军
				质量g	—	规格	—	审核	
				物料编码	—			批准	
更改标记	更改描述	签字	日期	青岛豪江电器有限公司				日期	
共 1 页		第 1 页		Qingdao Richriver Electrics Co.,Ltd				单位 mm	第 1 角法

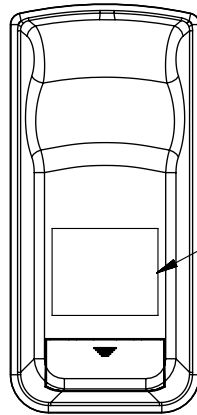
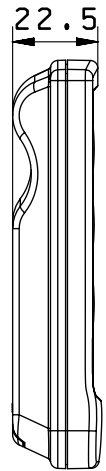
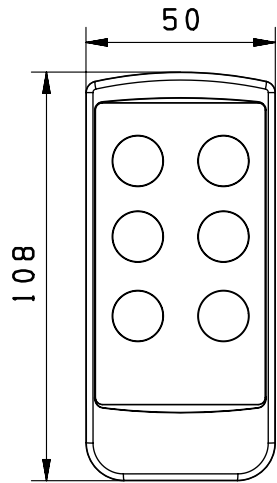

标签粘贴处

Richmat 豪江
Model: HJH12
 Contains FCC ID: 2A1TPHJC0

CE

This device complies with Part 15 of the FCC Rules. Operation is subject to the following two conditions:
 (1) this device may not cause harmful interference, and
 (2) this device must accept any interference received, including interference that may cause undesired operation.

				编 号	H12	名 称	遥控器		
				材 质		比 例	1:2	设 计	谭英军
				质量 g		规 格		审 核	
				物料编码				批 准	
更改标记	更改描述	签字	日期	青岛豪江电器有限公司				日 期	
共 1 页		第 1 页		Qingdao Richriver Electrics Co.,Ltd				单 位 mm	第 1 角法

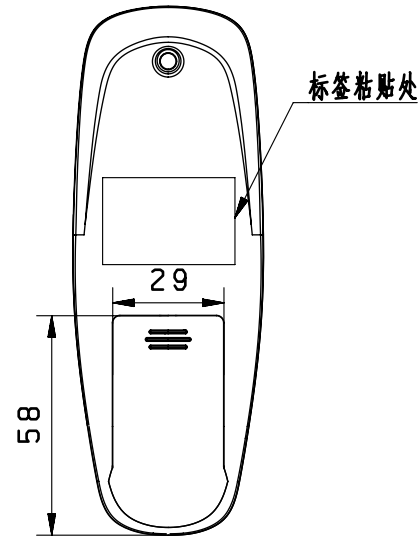
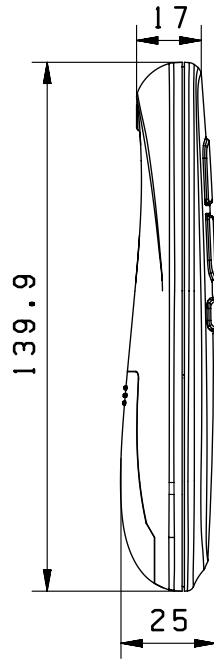
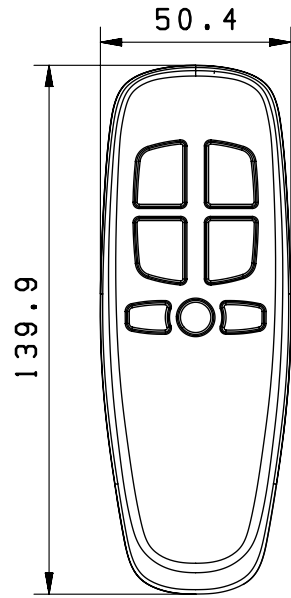

Richmat 豪江
 Model: HJH13
 Contains FCC ID: 2AITPHJC0

CE

This device complies with Part 15 of the FCC Rules. Operation is subject to the following two conditions:
 (1) this device may not cause harmful interference, and
 (2) this device must accept any interference received, including interference that may cause undesired operation.

				编号	H13	名称	总装图		
				材质	—	比例	1:2	设计	谭英军
				质量 g	—	规格	—	审核	
				物料编码	—		批准		
更改标记	更改描述	签字	日期	青岛豪江电器有限公司				日期	
共 1 页		第 1 页		Qingdao Richriver Electrics Co.,Ltd				单位 mm	第 1 角法

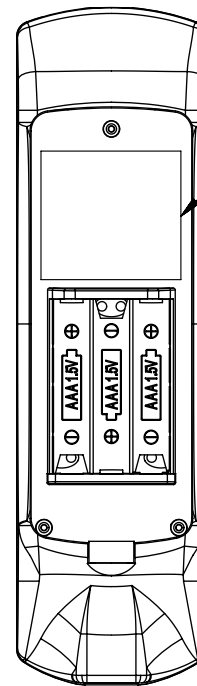
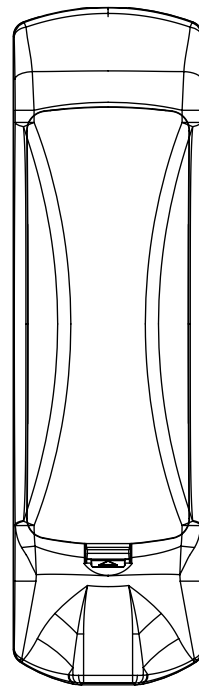
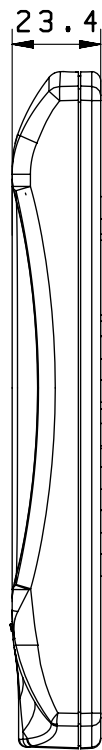
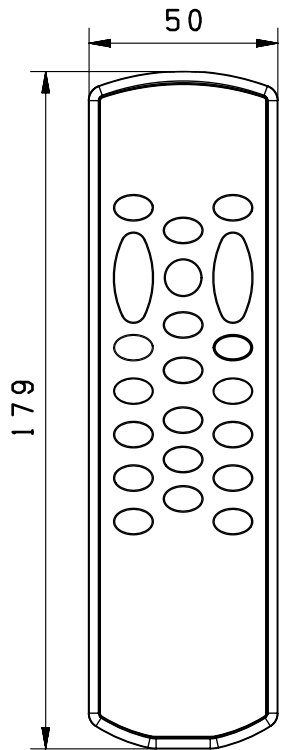

Richmat 豪江
Model: HJH26
 Contains FCC ID: 2A1TPHJC0

CE

This device complies with Part 15 of the FCC Rules. Operation is subject to the following two conditions:
 (1) this device may not cause harmful interference, and
 (2) this device must accept any interference received, including interference that may cause undesired operation.

				编号	H26	名称	遥控器
				材质		比例	1:2
				质量g		规格	
				物料编码		批准	
更改标记	更改描述	签字	日期	青岛豪江电器有限公司			日期
共 1 页		第 1 页		Qingdao Richriver Electrics Co.,Ltd			单位 mm 第 1 角法

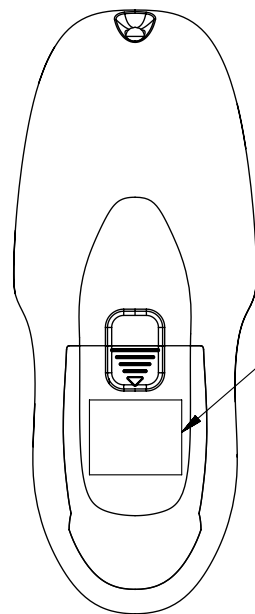
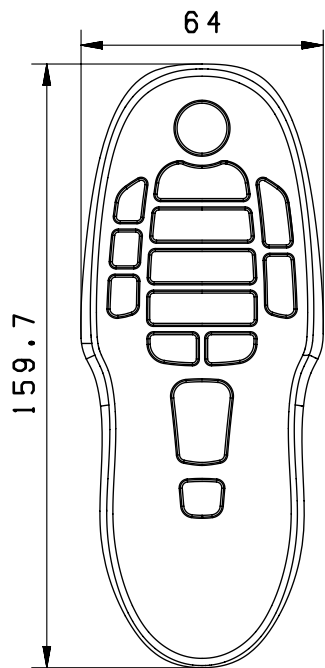

标签粘贴处

Richmat 豪江
 Model: HJH29
 Contains FCC ID: 2AITPHJC0

CE

This device complies with Part 15 of the FCC Rules. Operation is subject to the following two conditions:
 (1) this device may not cause harmful interference, and
 (2) this device must accept any interference received, including interference that may cause undesired operation.

				编号	HJH29	名称	总装图		
				材质		比例	1:2	设计	谭英军
				质量 g		规格		审核	
				物料编码				批准	
更改标记	更改描述	签字	日期	青岛豪江电器有限公司				日期	
共 1 页		第 1 页		Qingdao Richriver Electrics Co.,Ltd				单位 m m	第 1 角法

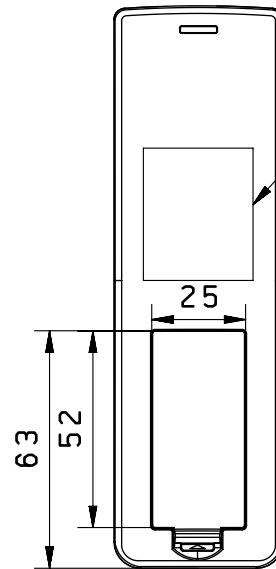
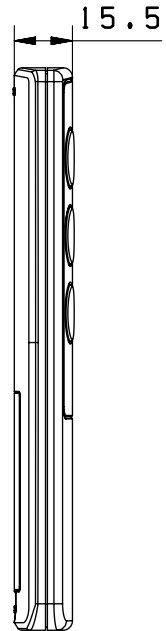
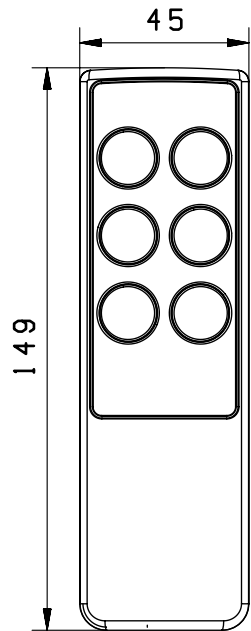

标签粘贴处

Richmat 豪江
 Model: HJH37
 Contains FCC ID: 2AITPHJC0

CE

This device complies with Part 15 of the FCC Rules. Operation is subject to the following two conditions:
 (1) this device may not cause harmful interference, and
 (2) this device must accept any interference received, including interference that may cause undesired operation.

				编号	H37	名称	总装图		
				材质		比例	1:2	设计	谭英军
				质量 g		规格		审核	
				物料编码				批准	
更改标记	更改描述	签字	日期	青岛豪江电器有限公司				日期	
共 1 页		第 1 页		Qingdao Richriver Electrics Co.,Ltd				单位 mm	第 1 角法

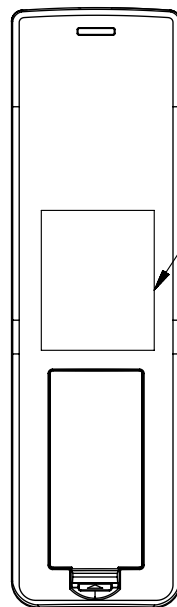
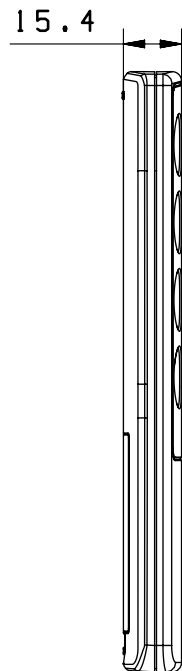
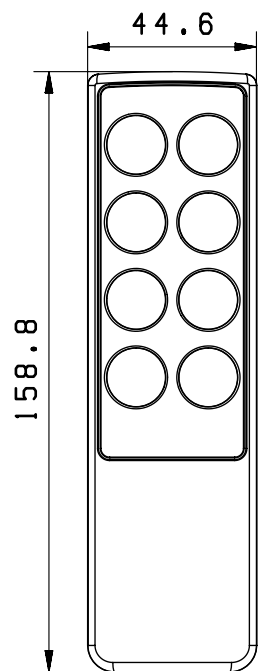

标签粘贴处

Richmat 豪江
 Model: HJH39
 Contains FCC ID: 2A1TPHJC0

CE

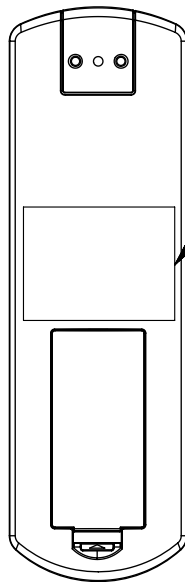
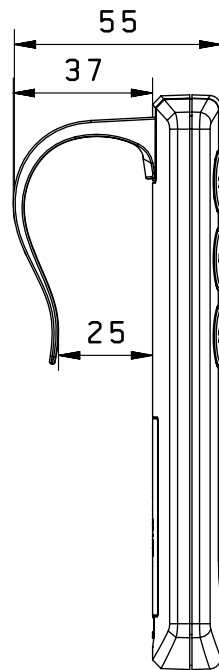
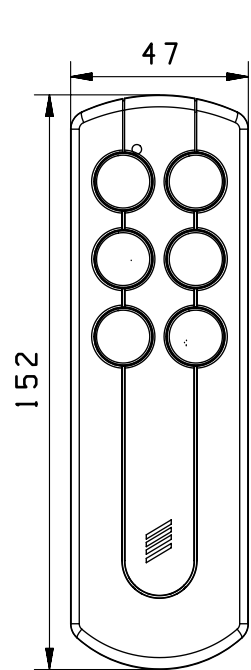

This device complies with Part 15 of the FCC Rules. Operation is subject to the following two conditions:
 (1) this device may not cause harmful interference, and
 (2) this device must accept any interference received, including interference that may cause undesired operation.

				编号	HJH39	名称	遥控器		
				材质		比例	1:2	设计	谭英军
				质量 g	—	规格	—	审核	
				物料编码				批准	
更改标记	更改描述	签字	日期	青岛豪江电器有限公司				日期	
共 1 页		第 1 页		Qingdao Richriver Electrics Co.,Ltd				单位 mm	第 1 角法



标签粘贴处

Richmat 豪江
 Model: HJH51
 Contains FCC ID: 2A1TPHJC0



CE

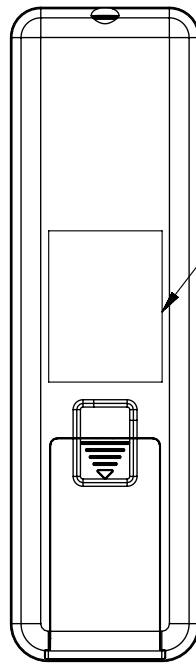
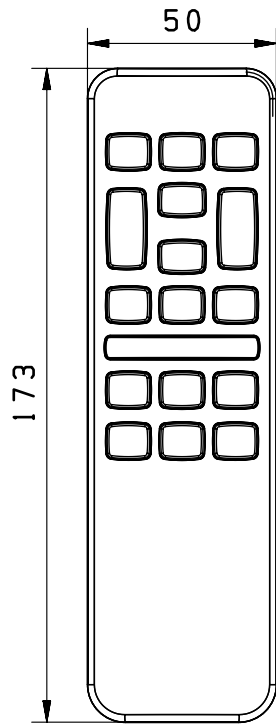

This device complies with Part 15 of the FCC Rules. Operation is subject to the following two conditions:
 (1) this device may not cause harmful interference, and
 (2) this device must accept any interference received, including interference that may cause undesired operation.

				编号	HJH51	名称	遥控器		
				材质		比例	1:2	设计	谭英军
				质量 g	—	规格	—	审核	
				物料编码				批准	
更改标记	更改描述	签字	日期	青岛豪江电器有限公司				日期	
共 1 页		第 1 页		Qingdao Richriver Electrics Co.,Ltd				单位 mm	第 1 角法



标签粘贴处

Richmat 豪江 
 Model: HJH55 
 Contains FCC ID: 2AITPHJC0

This device complies with Part 15 of the FCC Rules. Operation is subject to the following two conditions:
 (1) this device may not cause harmful interference, and
 (2) this device must accept any interference received, including interference that may cause undesired operation.

				编号	HJH55	名称	遥控器		
				材质	—	比例	1:2	设计	谭英军
				质量 g	—	规格	—	审核	
				物料编码	—		批准		
更改标记	更改描述	签字	日期	青岛豪江电器有限公司				日期	
共 1 页		第 1 页		Qingdao Richriver Electrics Co.,Ltd				单位 mm	第 1 角法