

TEST REPORT

Report No.: BCTC2204308917E

Applicant: ShenZhen YuYuanXin Electronic Technology Co., LTD

Product Name: WIRELESS CONTROLLER

Model/Type Ref.: TNS-1126

Tested Date: 2022-04-07 to 2022-04-12

Issued Date: 2022-04-12

Shenzhen BCTC Testing Co., Ltd.



FCC ID: 2AJJCTNS-1126

Product Name: WIRELESS CONTROLLER
Trademark: N/A
Model/Type Ref.: TNS-1126
TNS-1126A, TNS-1126B, TNS-1126D, TNS-1126C
Prepared For: ShenZhen YuYuanXin Electronic Technology Co., LTD
Address: Building 11, Tianluohu Industry Park, Guihua Industry Area, Guanguang Road, Guanlan Town, Longhua District, Shenzhen, Guangdong, China
Manufacturer: ShenZhen YuYuanXin Electronic Technology Co., LTD
Address: Building 11, Tianluohu Industry Park, Guihua Industry Area, Guanguang Road, Guanlan Town, Longhua District, Shenzhen, Guangdong, China
Prepared By: Shenzhen BCTC Testing Co., Ltd.
Address: 1-2/F., Building B, Pengzhou Industrial Park, No.158, Fuyuan 1st Road, Tangwei, Fuhai Subdistrict, Bao'an District, Shenzhen, Guangdong, China
Sample Received Date: 2022-04-07
Sample tested Date: 2022-04-07 to 2022-04-12
Issue Date: 2022-04-12
Report No.: BCTC2204308917E
Test Standards: FCC Part15.247
ANSI C63.10-2013
Test Results: PASS
Remark: This is Bluetooth Classic radio test report.

Tested by:

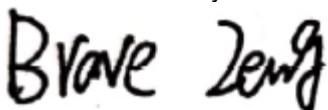

Brave Zeng/ Project Handler

Approved by:



Zero Zhou/Reviewer

The test report is effective only with both signature and specialized stamp. This result(s) shown in this report refer only to the sample(s) tested. Without written approval of Shenzhen BCTC Testing Co., Ltd, this report can't be reproduced except in full. The tested sample(s) and the sample information are provided by the client.

Table Of Content

Test Report Declaration	Page
1. Version	5
2. Test Summary	6
3. Measurement Uncertainty	7
4. Product Information And Test Setup	8
4.1 Product Information.....	8
4.2 Test Setup Configuration	8
4.3 Support Equipment	8
4.4 Channel List.....	9
4.5 Test Mode.....	9
4.6 Table Of Parameters Of Text Software Setting.....	9
5. Test Facility And Test Instrument Used.....	10
5.1 Test Facility.....	10
5.2 Test Instrument Used.....	10
6. Conducted Emissions.....	12
6.1 Block Diagram Of Test Setup.....	12
6.2 Limit	12
6.3 Test Procedure	12
6.4 EUT Operating Conditions	13
6.5 Test Result.....	14
7. Radiated Emissions.....	16
7.1 Block Diagram Of Test Setup.....	16
7.2 Limit	17
7.3 Test Procedure	18
7.4 EUT Operating Conditions	19
7.5 Test Result.....	19
8. Radiated Band Emission Measurement And Restricted Bands Of Operation	23
8.1 Block Diagram Of Test Setup.....	23
8.2 Limit	23
8.3 Test Procedure	24
8.4 EUT Operating Conditions	24
8.5 Test Result.....	25
9. Conducted Emission	26
9.1 Block Diagram Of Test Setup.....	26
9.2 Limit	26
9.3 Test Procedure	26
9.4 Test Result.....	26
10. 20 DB Bandwidth.....	36
10.1 Block Diagram Of Test Setup.....	36
10.2 Limit	36
10.3 Test Procedure	36
10.4 Test Result.....	37
11. Maximum Peak Output Power.....	42
11.1 Block Diagram Of Test Setup.....	42

11.2	Limit	42
11.3	Test Procedure	42
11.4	Test Result.....	43
12.	Hopping Channel Separation	48
12.1	Block Diagram Of Test Setup.....	48
12.2	Limit	48
12.3	Test Procedure	48
12.4	Test Result.....	49
13.	Number Of Hopping Frequency.....	54
13.1	Block Diagram Of Test Setup.....	54
13.2	Limit	54
13.3	Test Procedure	54
13.4	Test Result.....	55
14.	Dwell Time.....	57
14.1	Block Diagram Of Test Setup.....	57
14.2	Limit	57
14.3	Test Procedure	57
14.4	Test Result.....	58
15.	Antenna Requirement	63
15.1	Limit	63
15.2	Test Result.....	63
16.	EUT Photographs.....	64
17.	EUT Test Setup Photographs.....	65

(Note: N/A Means Not Applicable)

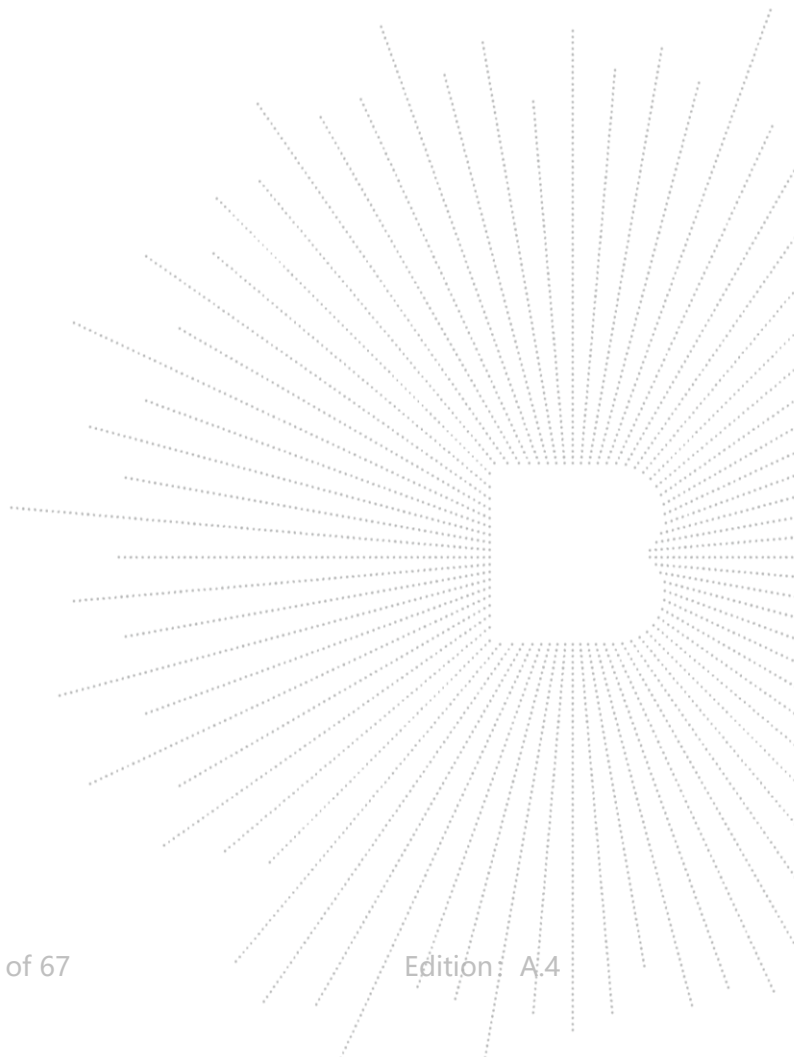

1. Version

Report No.	Issue Date	Description	Approved
BCTC2204308917E	2022-04-12	Original	Valid

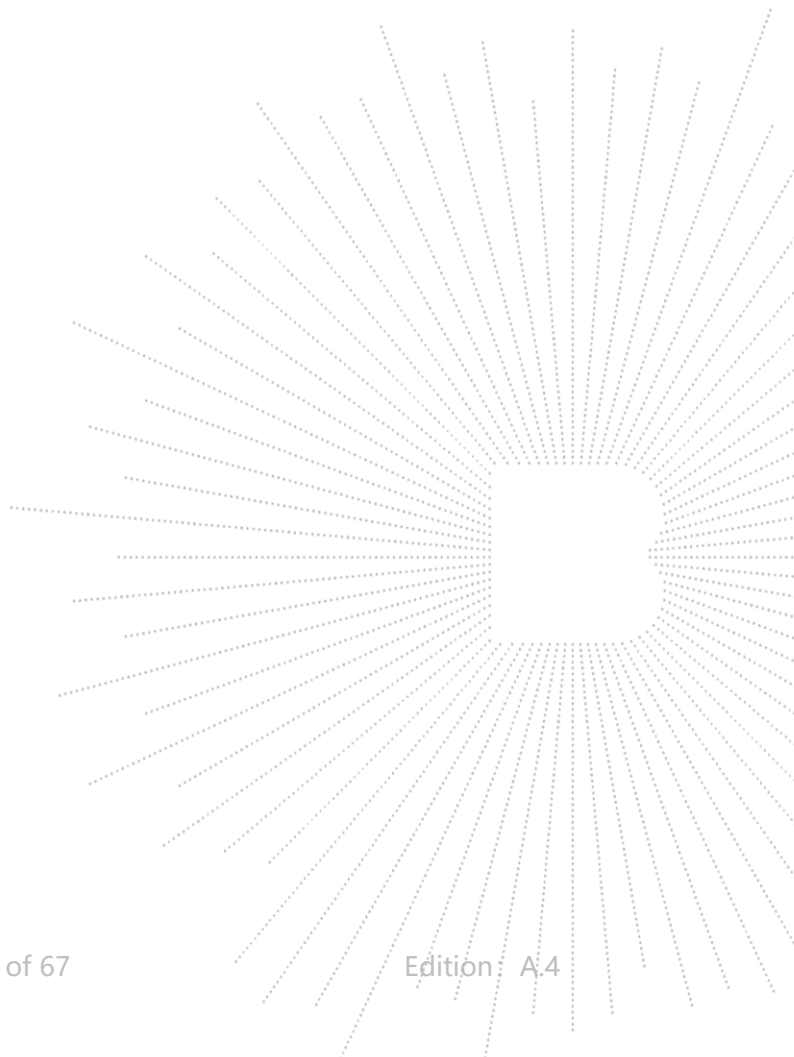

2. Test Summary

The Product has been tested according to the following specifications:

No.	Test Parameter	Clause No	Results
1	Conducted emission AC power port	§15.207	PASS
2	Conducted peak output power for FHSS	§15.247(b)(1)	PASS
3	20dB Occupied bandwidth	§15.247(a)(1)	PASS
4	Number of hopping frequencies	§15.247(a)(1)(iii)	PASS
5	Dwell Time	§15.247(a)(1)(iii)	PASS
6	Spurious RF conducted emissions	§15.247(d)	PASS
7	Band edge	§15.247(d)	PASS
8	Spurious radiated emissions for transmitter	§15.247(d) & §15.209 & §15.205	PASS
9	Antenna Requirement	15.203	PASS

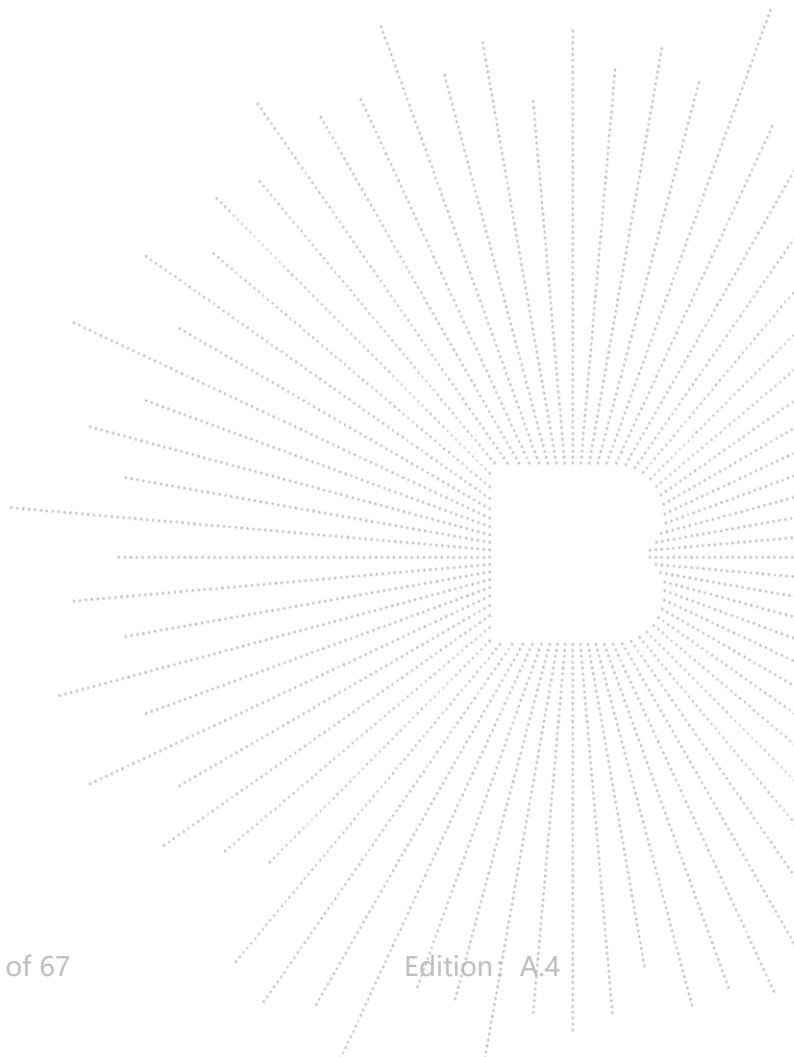

3. Measurement Uncertainty

Where relevant, the following measurement uncertainty levels have been estimated for tests performed on the Product as specified in CISPR 16-4-2. This uncertainty represents an expanded uncertainty expressed at approximately the 95% confidence level using a coverage factor of $k=2$.

No.	Item	Uncertainty
1	3m chamber Radiated spurious emission(9kHz-30MHz)	U=3.7dB
2	3m chamber Radiated spurious emission(30MHz-1GHz)	U=4.3dB
3	3m chamber Radiated spurious emission(1GHz-18GHz)	U=4.5dB
4	3m chamber Radiated spurious emission(18GHz-40GHz)	U=3.34dB
5	Conducted Emission(150kHz-30MHz)	U=3.20dB
6	Conducted Adjacent channel power	U=1.38dB
7	Conducted output power uncertainty Above 1G	U=1.576dB
8	Conducted output power uncertainty below 1G	U=1.28dB
9	humidity uncertainty	U=5.3%
10	Temperature uncertainty	U=0.59°C

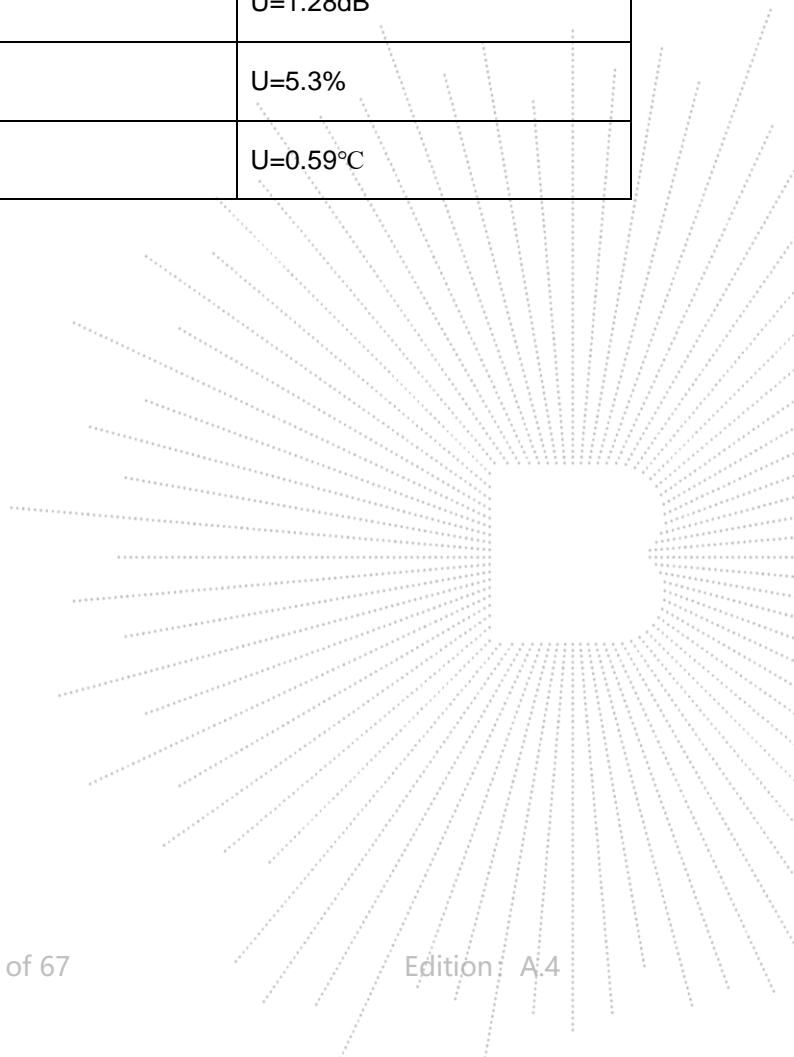

4. Product Information And Test Setup

4.1 Product Information

Model/Type Ref.:	TNS-1126 TNS-1126A, TNS-1126B, TNS-1126D, TNS-1126C
Model differences:	All the model are the same circuit and RF module, except model names.
Operation Frequency:	2402-2480MHz
Type of Modulation:	GFSK, $\pi/4$ DQPSK, 8DPSK
Number Of Channel	79CH
Antenna installation:	PCB antenna
Antenna Gain:	0dBi
Ratings:	AC 120V/60Hz/DC 3.7V

4.2 Test Setup Configuration

See test photographs attached in *EUT TEST SETUP PHOTOGRAPHS* for the actual connections between Product and support equipment.

Conducted Emission:

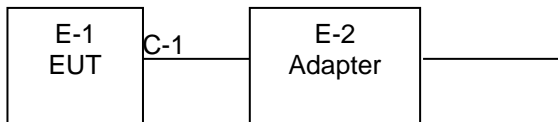

Radiated Spurious Emission

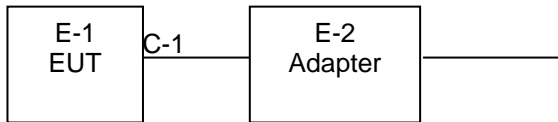

4.3 Support Equipment

No.	Device Type	Brand	Model	Series No.	Note
E-1	WIRELESS CONTROLLER	N/A	TNS-1126	N/A	EUT
E-2	Adapter	N/A	BCTC001	N/A	Auxiliary

Item	Shielded Type	Ferrite Core	Length	Note
C-1	NO	NO	0.5M	DC cable unshielded

Notes:

1. All the equipment/cables were placed in the worst-case configuration to maximize the emission during the test.
2. Grounding was established in accordance with the manufacturer's requirements and conditions for the intended use.

4.4 Channel List

CH	Frequency (MHz)	CH	Frequency (MHz)	CH	Frequency (MHz)	CH	Frequency (MHz)
0	2402	1	2403	2	2404	3	2405
4	2406	5	2407	6	2408	7	2409
8	2410	9	2411	10	2412	11	2413
12	2414	13	2415	14	2416	15	2417
16	2418	17	2419	18	2420	19	2421
20	2422	21	2423	22	2424	23	2425
24	2426	25	2427	26	2428	27	2429
28	2430	29	2431	30	2432	31	2433
32	2434	33	2435	34	2436	35	2437
36	2438	37	2439	38	2440	39	2441
40	2442	41	2443	42	2444	43	2445
44	2446	45	2447	46	2448	47	2449
48	2450	49	2451	50	2452	51	2453
52	2454	53	2455	54	2456	55	2457
56	2458	57	2459	58	2460	59	2461
60	2462	61	2463	62	2464	63	2465
64	2466	65	2467	66	2468	67	2469
68	2470	69	2471	70	2472	71	2473
72	2474	73	2475	74	2476	75	2477
76	2478	77	2479	78	2480	79	/

4.5 Test Mode

To investigate the maximum EMI emission characteristics generated from EUT, the test system was pre-scanning tested based on the consideration of following EUT operation mode or test configuration mode which possible have effect on EMI emission level. Each of these EUT operation mode(s) or test configuration mode(s) mentioned above was evaluated respectively.

Test Mode	Test mode	Low channel	Middle channel	High channel
1	Transmitting(GFSK)	2402MHz	2441MHz	2480MHz
2	Transmitting($\pi/4$ DQPSK)	2402MHz	2441MHz	2480MHz
3	Transmitting(8DPSK)	2402MHz	2441MHz	2480MHz
4	Charging(Conducted emission)			
5	Transmitting (Radiated emission)			

Note:

- (1) The measurements are performed at the highest, middle, lowest available channels.
- (2) Fully-charged battery is used during the test

4.6 Table Of Parameters Of Text Software Setting

During testing channel & power controlling software provided by the customer was used to control the operating channel as well as the output power level. The RF output power selection is for the setting of RF output power expected by the customer and is going to be fixed on the firmware of the final end product power parameters

Test software Version	CMD		
Frequency	2402 MHz	2441 MHz	2480 MHz
Parameters	DEF	DEF	DEF

5. Test Facility And Test Instrument Used

5.1 Test Facility

All measurement facilities used to collect the measurement data are located at Shenzhen BCTC Testing Co., Ltd. Address: 1-2/F., Building B, Pengzhou Industrial Park, No.158, Fuyuan 1st Road, Tangwei, Fuhai Subdistrict, Bao'an District, Shenzhen, Guangdong, China. The site and apparatus are constructed in conformance with the requirements of ANSI C63.4 and CISPR 16-1-1 other equivalent standards. FCC Test Firm Registration Number: 712850 IC Registered No.: 23583

5.2 Test Instrument Used

Conducted emissions Test					
Equipment	Manufacturer	Model#	Serial#	Last Cal.	Next Cal.
Receiver	R&S	ESR3	102075	May 28, 2021	May 27, 2022
LISN	R&S	ENV216	101375	May 28, 2021	May 27, 2022
Software	Frad	EZ-EMC	EMC-CON 3A1	\	\
Attenuator	\	10dB DC-6GHz	1650	May 28, 2021	May 27, 2022

RF Conducted Test					
Equipment	Manufacturer	Model#	Serial#	Last Cal.	Next Cal.
Power Metter	Keysight	E4419	\	May 28, 2021	May 27, 2022
Power Sensor (AV)	Keysight	E9300A	\	May 28, 2021	May 27, 2022
Signal Analyzer20kHz-26.5GHz	Keysight	N9020A	MY49100060	May 28, 2021	May 27, 2022
Spectrum Analyzer9kHz-40GHz	R&S	FSP40	\	May 28, 2021	May 27, 2022

Radiated emissions Test (966 chamber)					
Equipment	Manufacturer	Model#	Serial#	Last Cal.	Next Cal.
966 chamber	ChengYu	966 Room	966	Jun. 06. 2020	Jun. 05, 2023
Receiver	R&S	ESR3	102075	May 28, 2021	May 27, 2022
Receiver	R&S	ESRP	101154	May 28, 2021	May 27, 2022
Amplifier	SKET	LAPA_01G18 G-45dB	\	May 28, 2021	May 27, 2022
Amplifier	Schwarzbeck	BBV9744	9744-0037	May 28, 2021	May 27, 2022
TRILOG Broadband Antenna	Schwarzbeck	VULB9163	942	Jun. 01, 2021	May 31, 2022
Horn Antenna	Schwarzbeck	BBHA9120D	1541	Jun. 02, 2021	Jun. 01, 2022
Horn Antenn(18GHz -40GHz)	Schwarzbeck	BBHA9170	00822	Jun. 15, 2021	Jun. 14, 2022
Amplifier(18G Hz-40GHz)	MITEQ	TTA1840-35- HG	2034381	May 28, 2021	May 27, 2022
Loop Antenna(9kHz -30MHz)	Schwarzbeck	FMZB1519B	00014	Jun. 02, 2021	Jun. 01, 2022
RF cables1(9kHz- 30MHz)	Huber+Suhnar	9kHz-30MHz	B1702988-00 08	May 28, 2021	May 27, 2022
RF cables2(30MH z-1GHz)	Huber+Suhnar	30MHz-1GH z	1486150	May 28, 2021	May 27, 2022
RF cables3(1GHz- 40GHz)	Huber+Suhnar	1GHz-40GHz	1607106	May 28, 2021	May 27, 2022
Power Metter	Keysight	E4419	\	May 28, 2021	May 27, 2022
Power Sensor (AV)	Keysight	E9300A	\	May 28, 2021	May 27, 2022
Signal Analyzer20kHz -26.5GHz	Keysight	N9020A	MY49100060	May 28, 2021	May 27, 2022
Spectrum Analyzer9kHz- 40GHz	R&S	FSP40	\	May 28, 2021	May 27, 2022
Software	Frad	EZ-EMC	FA-03A2 RE	\	\

6. Conducted Emissions

6.1 Block Diagram Of Test Setup

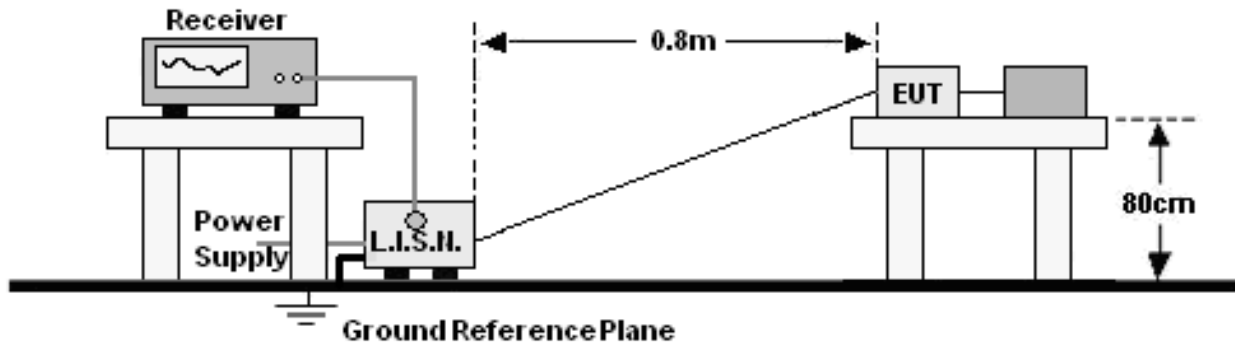

6.2 Limit

FREQUENCY (MHz)	Limit (dBuV)	
	Quas-peak	Average
0.15 -0.5	66 - 56 *	56 - 46 *
0.50 -5.0	56.00	46.00
5.0 -30.0	60.00	50.00

Notes:
 1. *Decreasing linearly with logarithm of frequency.
 2. The lower limit shall apply at the transition frequencies.

6.3 Test Procedure

Receiver Parameters	Setting
Attenuation	10 dB
Start Frequency	0.15 MHz
Stop Frequency	30 MHz
IF Bandwidth	9 kHz

- The Product was placed on a nonconductive table 0.8 m above the horizontal ground reference plane, and 0.4 m from the vertical ground reference plane, and connected to the main through Line Impedance Stability Network (L.I.S.N).
- The RBW of the receiver was set at 9 kHz in 150 kHz ~ 30MHz with Peak and AVG detector in Max Hold mode. Run the receiver's pre-scan to record the maximum disturbance generated from Product in all power lines in the full band.
- For each frequency whose maximum record was higher or close to limit, measure its QP and AVG values and record.

6.4 EUT Operating Conditions

The EUT was configured for testing in a typical fashion (as a customer would normally use it). The EUT has been programmed to continuously transmit during test. This operating condition was tested and used to collect the included data.

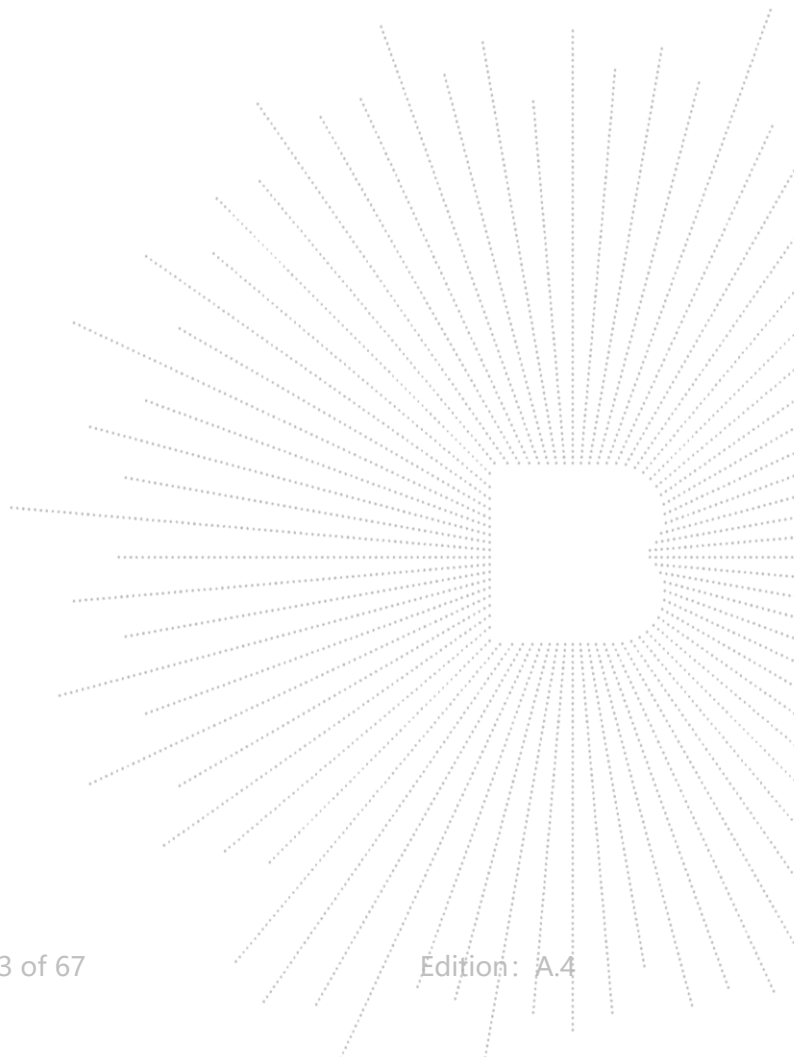

6.5 Test Result

Temperature:	26 °C	Relative Humidity:	54%
Pressure:	101kPa	Phase :	Line
Test Voltage :	AC 120V/60Hz	Test Mode:	Mode 1

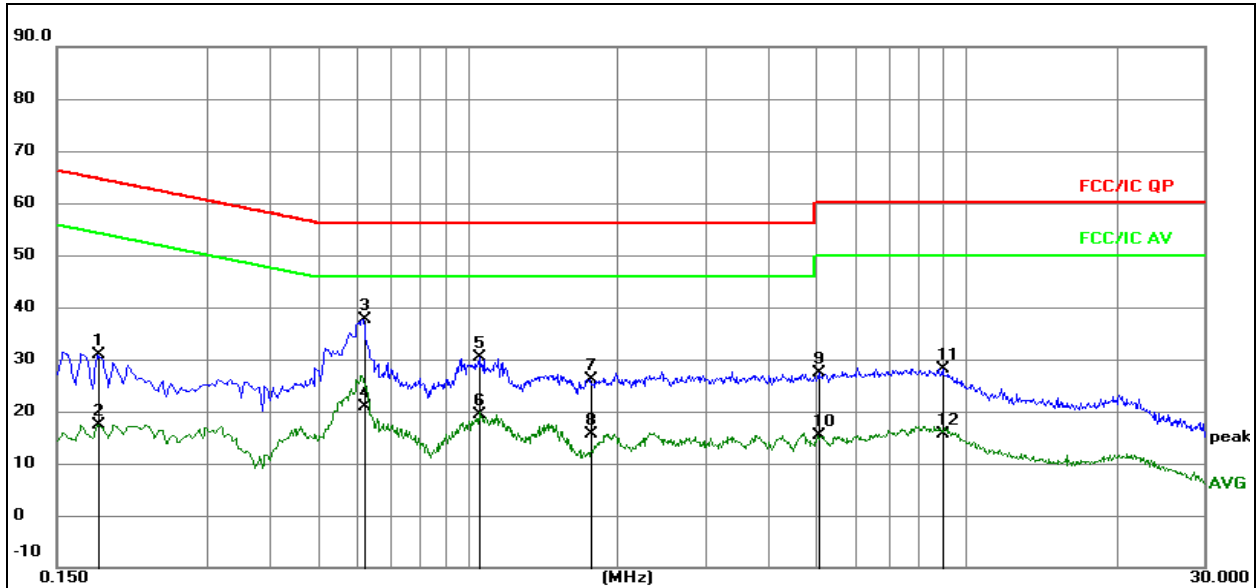

Remark:

1. All readings are Quasi-Peak and Average values.
2. Factor = Insertion Loss + Cable Loss.
3. Measurement=Reading Level+ Correct Factor
4. Over=Measurement-Limit

No.	Mk.	Freq. MHz	Reading Level	Correct Factor dB	Measure- ment dBuV	Limit dBuV	Over dB	Detector
1		0.1815	11.21	19.60	30.81	64.42	-33.61	QP
2		0.1815	-2.15	19.60	17.45	54.42	-36.97	AVG
3	*	0.6180	18.04	19.61	37.65	56.00	-18.35	QP
4		0.6180	1.15	19.61	20.76	46.00	-25.24	AVG
5		1.0545	10.79	19.62	30.41	56.00	-25.59	QP
6		1.0545	-0.23	19.62	19.39	46.00	-26.61	AVG
7		1.7700	6.49	19.62	26.11	56.00	-29.89	QP
8		1.7700	-3.89	19.62	15.73	46.00	-30.27	AVG
9		5.0595	7.65	19.70	27.35	60.00	-32.65	QP
10		5.0595	-4.34	19.70	15.36	50.00	-34.64	AVG
11		8.9790	8.30	19.77	28.07	60.00	-31.93	QP
12		8.9790	-4.14	19.77	15.63	50.00	-34.37	AVG

Temperature:	26 °C	Relative Humidity:	54%
Pressure:	101kPa	Phase :	Neutral
Test Voltage :	AC 120V/60Hz	Test Mode:	Mode 1

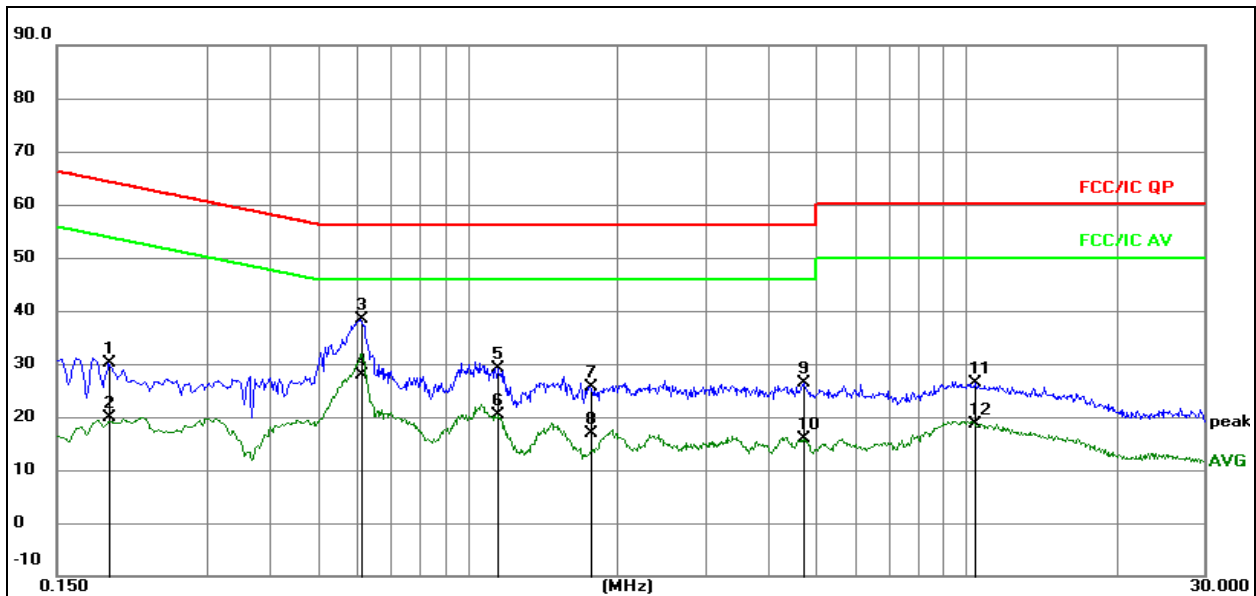
Remark:

1. All readings are Quasi-Peak and Average values.
2. Factor = Insertion Loss + Cable Loss.
3. Measurement=Reading Level+ Correct Factor
4. Over=Measurement-Limit

No.	Mk.	Freq. MHz	Reading Level	Correct Factor dB	Measure- ment dBuV	Limit dBuV	Over dB	Detector
1		0.1904	10.52	19.60	30.12	64.02	-33.90	QP
2		0.1904	0.28	19.60	19.88	54.02	-34.14	AVG
3	*	0.6108	18.86	19.61	38.47	56.00	-17.53	QP
4		0.6108	8.25	19.61	27.86	46.00	-18.14	AVG
5		1.1473	9.43	19.62	29.05	56.00	-26.95	QP
6		1.1473	0.78	19.62	20.40	46.00	-25.60	AVG
7		1.7623	6.13	19.62	25.75	56.00	-30.25	QP
8		1.7623	-2.62	19.62	17.00	46.00	-29.00	AVG
9		4.7213	6.69	19.69	26.38	56.00	-29.62	QP
10		4.7213	-3.89	19.69	15.80	46.00	-30.20	AVG
11		10.3972	6.52	19.79	26.31	60.00	-33.69	QP
12		10.3972	-1.14	19.79	18.65	50.00	-31.35	AVG

7. Radiated Emissions

7.1 Block Diagram Of Test Setup

(A) Radiated Emission Test-Up Frequency Below 30MHz

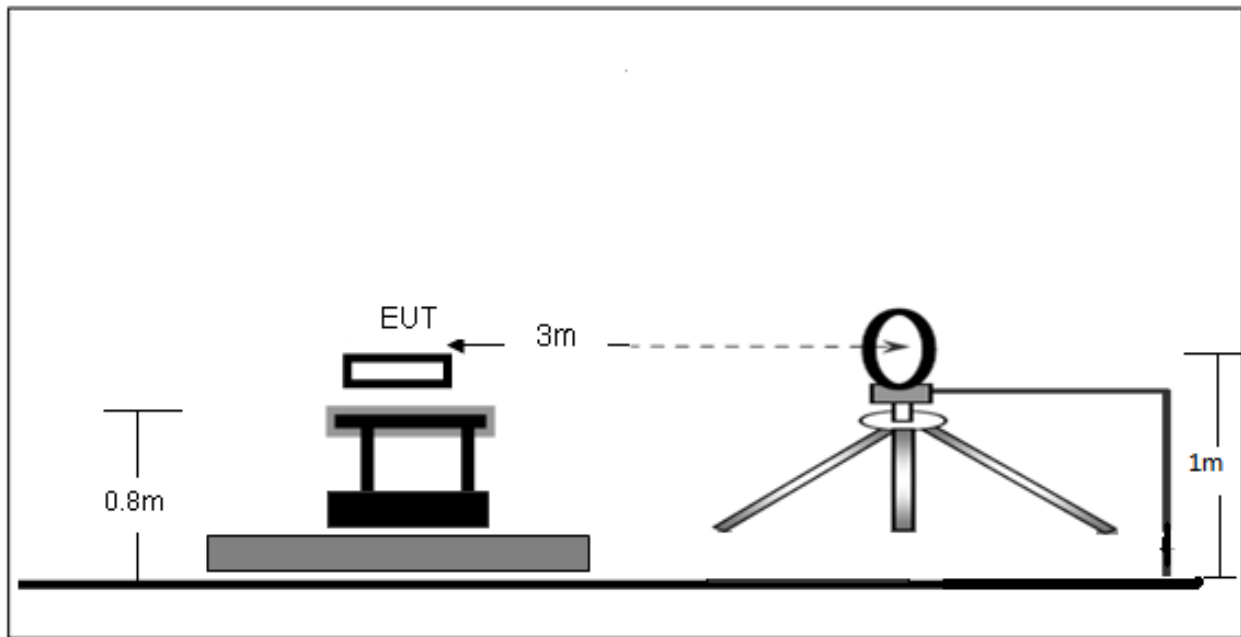

(B) Radiated Emission Test-Up Frequency 30MHz~1GHz

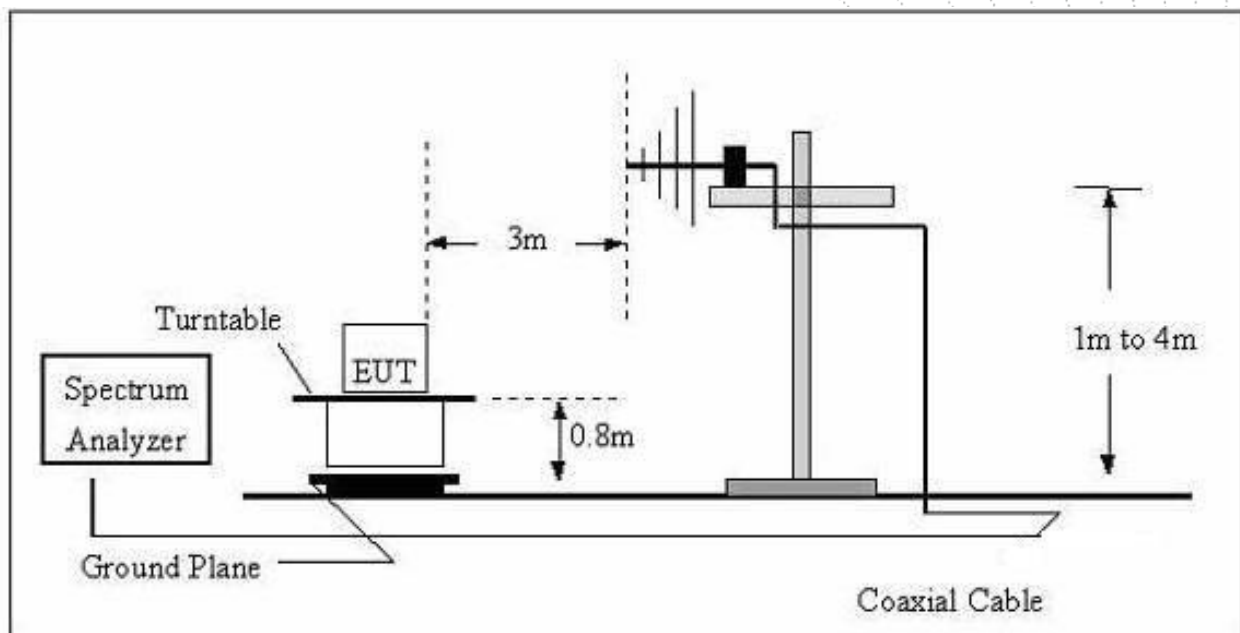

(C) Radiated Emission Test-Up Frequency Above 1GHz



7.2 Limit

20dBc in any 100 kHz bandwidth outside the operating frequency band. In case the emission fall within the restricted band specified on 15.205(a), then the 15.209(a) limit in the table below has to be followed.

Frequency (MHz)	Field Strength uV/m	Distance (m)	Field Strength Limit at 3m Distance	
			uV/m	dBuV/m
0.009 ~ 0.490	2400/F(kHz)	300	10000 * 2400/F(kHz)	20log ^{(2400/F(kHz))} + 80
0.490 ~ 1.705	24000/F(kHz)	30	100 * 24000/F(kHz)	20log ^{(24000/F(kHz))} + 40
1.705 ~ 30	30	30	100 * 30	20log ⁽³⁰⁾ + 40
30 ~ 88	100	3	100	20log ⁽¹⁰⁰⁾
88 ~ 216	150	3	150	20log ⁽¹⁵⁰⁾
216 ~ 960	200	3	200	20log ⁽²⁰⁰⁾
Above 960	500	3	500	20log ⁽⁵⁰⁰⁾

LIMITS OF RADIATED EMISSION MEASUREMENT (Above 1000MHz)

FREQUENCY (MHz)	Limit (dBuV/m) (at 3M)	
	PEAK	AVERAGE
Above 1000	74	54

Notes:

- (1) The limit for radiated test was performed according to FCC PART 15C.
- (2) The tighter limit applies at the band edges.
- (3) Emission level (dBuV/m) = 20log Emission level (uV/m).

7.3 Test Procedure

Receiver Parameter	Setting
Attenuation	Auto
9kHz~150kHz	RBW 200Hz for QP
150kHz~30MHz	RBW 9kHz for QP
30MHz~1000MHz	RBW 120kHz for QP

Spectrum Parameter	Setting
1-25GHz	RBW 1 MHz /VBW 1 MHz for Peak, RBW 1 MHz / VBW 10Hz for Average

Below 1GHz test procedure as below:

- a. The EUT was placed on the top of a rotating table 0.8 meters above the ground at a 3 meter semi-anechoic chamber. The table was rotated 360 degrees to determine the position of the highest radiation.
 - b. The EUT was set 3 meters away from the interference-receiving antenna, which was mounted on the top of a variable-height antenna tower.
 - c. The antenna height is varied from one meter to four meters above the ground to determine the maximum value of the field strength. Both horizontal and vertical polarizations of the antenna are set to make the measurement.
 - d. For each suspected emission, the EUT was arranged to its worst case and then the antenna was tuned to heights from 1 meter to 4 meters (for the test frequency of below 30MHz, the antenna was tuned to heights 1 meter) and the rotatable table was turned from 0 degrees to 360 degrees to find the maximum reading.
 - e. The test-receiver system was set to Peak Detect Function and Specified Bandwidth with Maximum Hold Mode.
 - f. If the emission level of the EUT in peak mode was 10dB lower than the limit specified, then testing could be stopped and the peak values of the EUT would be reported. Otherwise the emissions that did not have 10dB margin would be re-tested one by one using peak, quasi-peak or average method as specified and then reported in a data sheet.
- Above 1GHz test procedure as below:
- g. Different between above is the test site, change from Semi- Anechoic Chamber to fully Anechoic Chamber and change form table 0.8 metre to 1.5 metre(Above 18GHz the distance is 1 meter and table is 1.5 metre).
 - h. Test the EUT in the lowest channel, the middle channel ,the Highest channel.

Note:

Both horizontal and vertical antenna polarities were tested and performed pretest to three orthogonal axis. The worst case emissions were reported.

Above 1GHz test procedure as below:

- a. The EUT was placed on the top of a rotating table 1.5 meters above the ground at a 3 meter chamber. The table was rotated 360 degrees to determine the position of the highest radiation.
- b. The EUT was set 3 meters away from the interference-receiving antenna, which was mounted on the top of a variable-height antenna tower.
- c. The antenna height is varied from one meter to four meters above the ground to determine the maximum value of the field strength. Both horizontal and vertical polarizations of the antenna are set to make the measurement.
- d. For each suspected emission, the EUT was arranged to its worst case and then the antenna was tuned to heights from 1 meter to 4 meters and the rota table was turned from 0 degrees to 360 degrees to find the maximum reading.
- e. The test-receiver system was set to Peak Detect Function and Specified Bandwidth with Maximum Hold Mode.
- f. If the emission level of the EUT in peak mode was 10dB lower than the limit specified, then testing could be stopped and the peak values of the EUT would be reported. Otherwise the emissions that did not have 10dB margin would be re-tested one by one using peak, quasi-peak or average method as specified and then reported in a data sheet.
- g. Test the EUT in the lowest channel, the Highest channel.

Note:

Both horizontal and vertical antenna polarities were tested and performed pretest to three orthogonal axis. The worst case emissions were reported.

7.4 EUT Operating Conditions

The EUT was configured for testing in a typical fashion (as a customer would normally use it). The EUT has been programmed to continuously transmit during test. This operating condition was tested and used to collect the included data.

7.5 Test Result

Below 30MHz

Temperature:	26°C	Relative Humidity:	24%
Pressure:	101 kPa	Test Voltage :	AC120V/60Hz
Test Mode :	Mode 2	Polarization :	--

Freq. (MHz)	Reading (dBuV/m)	Limit (dBuV/m)	Margin (dB)	State P/F
--	--	--	--	PASS
--	--	--	--	PASS

Note:

The amplitude of spurious emissions which are attenuated by more than 20dB below the permissible value has no need to be reported.

Distance extrapolation factor = $40 \log(\text{specific distance/test distance})$ (dB);

Limit line = specific limits(dBuv) + distance extrapolation factor.

Between 30MHz – 1GHz

Temperature:	26 °C	Relative Humidity:	54%
Pressure:	101KPa	Phase :	Horizontal
Test Mode:	Mode 1	Remark:	N/A

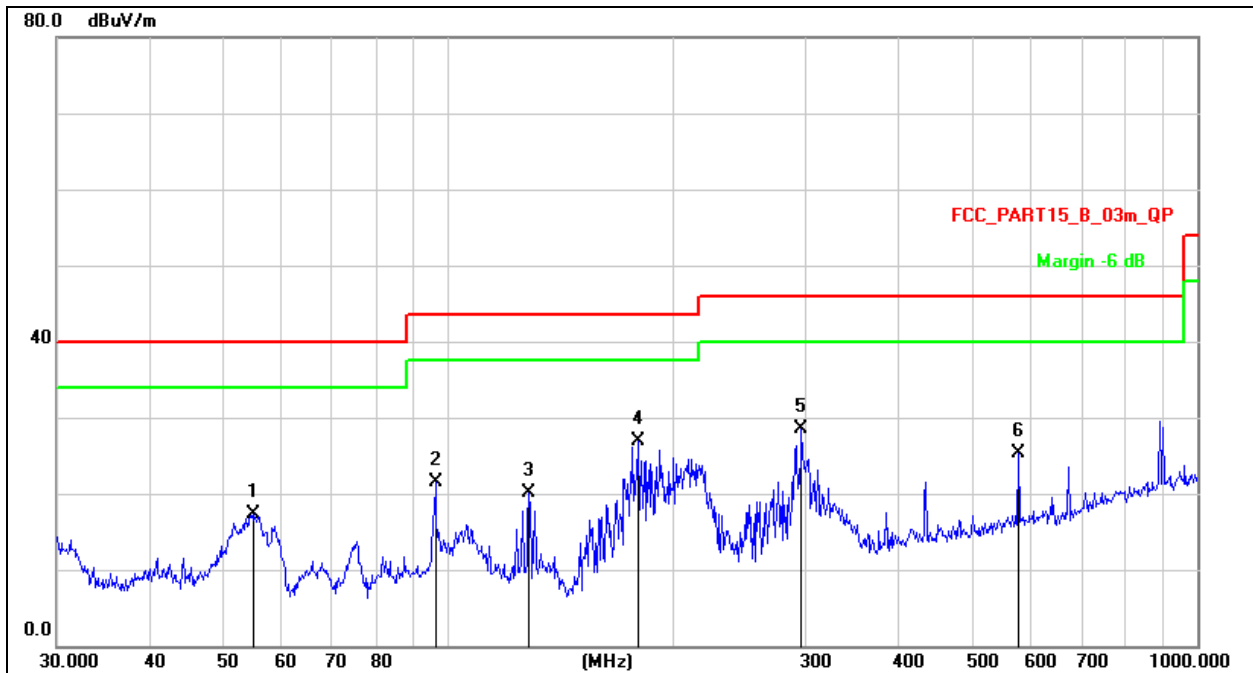

Remark:
 1. Factor = Antenna Factor + Cable Loss – Pre-amplifier.
 2. Measurement=Reading Level+ Correct Factor
 3. Over=Measurement-Limit

No.	Mk.	Freq.	Reading Level	Correct Factor	Measurement	Limit	Over	Detector
		MHz	dBuV	dB	dBuV/m	dB/m	dB	
1		54.8348	32.66	-15.36	17.30	40.00	-22.70	QP
2		96.0986	38.54	-16.99	21.55	43.50	-21.95	QP
3		128.1130	38.16	-18.09	20.07	43.50	-23.43	QP
4	*	179.3863	44.54	-17.62	26.92	43.50	-16.58	QP
5		296.1836	42.20	-13.72	28.48	46.00	-17.52	QP
6		576.6443	32.32	-7.06	25.26	46.00	-20.74	QP

Temperature:	26 °C	Relative Humidity:	54%
Pressure:	101KPa	Phase :	Vertical
Test Mode:	Mode 1	Remark:	N/A

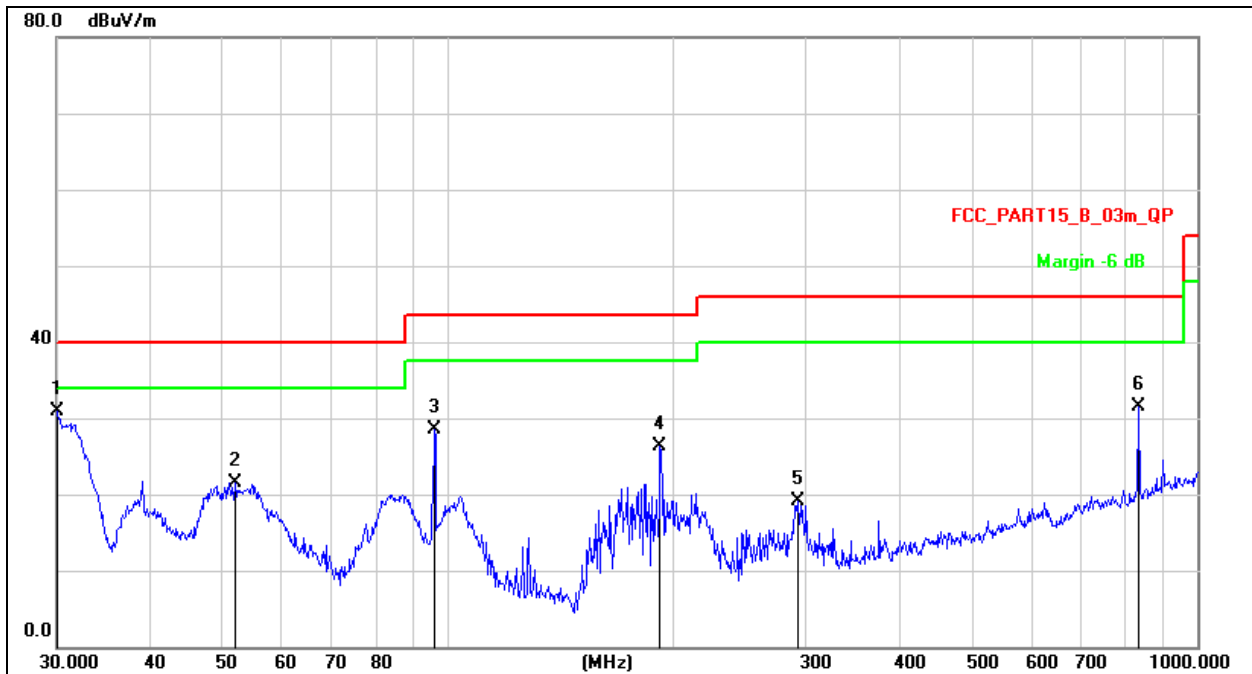

Remark:

1. Factor = Antenna Factor + Cable Loss – Pre-amplifier.
2. Measurement=Reading Level+ Correct Factor
3. Over=Measurement-Limit

No.	Mk.	Freq. MHz	Reading Level dBuV	Correct Factor dB	Measure- ment dBuV/m	Limit dB/m	Over dB	Detector
1	*	30.0000	48.13	-17.28	30.85	40.00	-9.15	QP
2		52.0251	36.66	-15.06	21.60	40.00	-18.40	QP
3		95.7622	45.48	-17.05	28.43	43.50	-15.07	QP
4		191.7450	43.22	-16.83	26.39	43.50	-17.11	QP
5		293.0842	32.97	-13.81	19.16	46.00	-26.84	QP
6		833.3171	34.39	-2.89	31.50	46.00	-14.50	QP

Between 1GHz – 25GHz

Polar (H/V)	Frequency	Reading Level	Correct Factor	Measure- ment	Limits	Over	Detector Type
	(MHz)	(dBuV/m)	(dB)	(dBuV/m)	(dBuV/ m)	(dB)	
GFSK Low channel							
V	4804.00	54.94	-0.43	54.51	74.00	-19.49	PK
V	4804.00	46.12	-0.43	45.69	54.00	-8.31	AV
V	7206.00	44.57	8.31	52.88	74.00	-21.12	PK
V	7206.00	34.31	8.31	42.62	54.00	-11.38	AV
H	4804.00	53.38	-0.43	52.95	74.00	-21.05	PK
H	4804.00	43.96	-0.43	43.53	54.00	-10.47	AV
H	7206.00	43.07	8.31	51.38	74.00	-22.62	PK
H	7206.00	34.46	8.31	42.77	54.00	-11.23	AV
GFSK Middle channel							
V	4882.00	53.27	-0.38	52.89	74.00	-21.11	PK
V	4882.00	47.22	-0.38	46.84	54.00	-7.16	AV
V	7323.00	43.61	8.83	52.44	74.00	-21.56	PK
V	7323.00	34.52	8.83	43.35	54.00	-10.65	AV
H	4882.00	52.09	-0.38	51.71	74.00	-22.29	PK
H	4882.00	42.03	-0.38	41.65	54.00	-12.35	AV
H	7323.00	42.51	8.83	51.34	74.00	-22.66	PK
H	7323.00	33.69	8.83	42.52	54.00	-11.48	AV
GFSK High channel							
V	4960.00	56.00	-0.32	55.68	74.00	-18.32	PK
V	4960.00	46.65	-0.32	46.33	54.00	-7.67	AV
V	7440.00	48.07	9.35	57.42	74.00	-16.58	PK
V	7440.00	37.43	9.35	46.78	54.00	-7.22	AV
H	4960.00	53.77	-0.32	53.45	74.00	-20.55	PK
H	4960.00	44.74	-0.32	44.42	54.00	-9.58	AV
H	7440.00	47.05	9.35	56.40	74.00	-17.60	PK
H	7440.00	38.84	9.35	48.19	54.00	-5.81	AV

Remark:

1. Emission Level = Meter Reading + Factor,
Factor = Antenna Factor + Cable Loss – Pre-amplifier.
Over = Emission Level - Limit
2. If peak below the average limit, the average emission was no test.
3. In restricted bands of operation, The spurious emissions below the permissible value more than 20dB
4. The amplitude of spurious emissions which are attenuated by more than 20dB below the permissible value has no need to be reported.
5. All the Modulation are test, the worst mode is GFSK, the data recording in the report.

8. Radiated Band Emission Measurement And Restricted Bands Of Operation

8.1 Block Diagram Of Test Setup

Radiated Emission Test-Up Frequency Above 1GHz

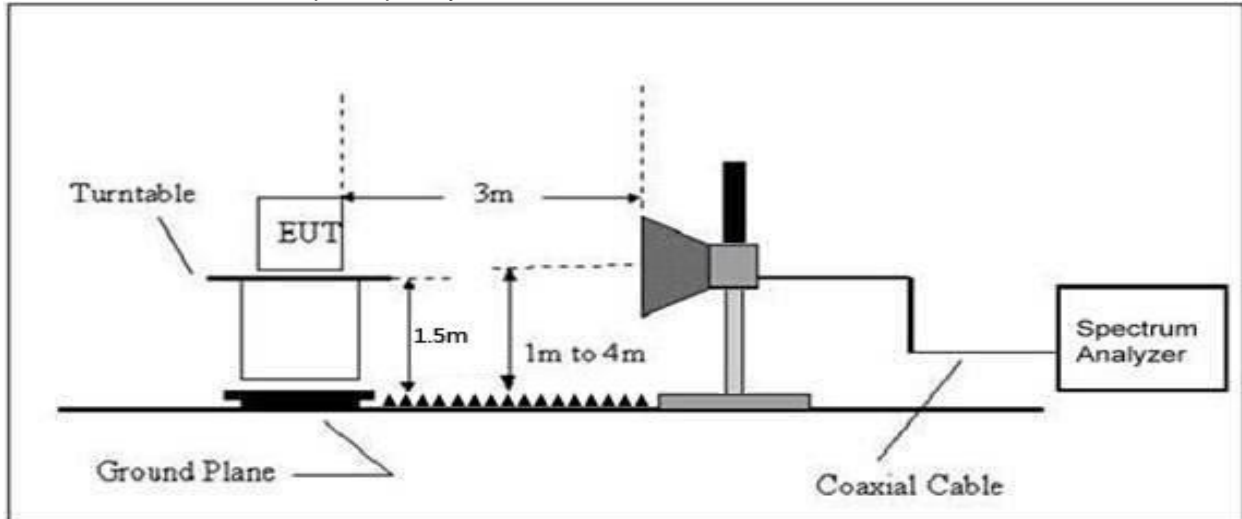

8.2 Limit

FCC Part15 C Section 15.209 and 15.205

(a) Except as shown in paragraph (d) of this section, only spurious emissions are permitted in any of the frequency bands listed below:

MHz	MHz	MHz	GHz
0.090-0.110	16.42-16.423	399.9-410	4.5-5.15
0.495-0.505	16.69475-16.69525	608-614	5.35-5.46
2.1735-2.1905	16.80425-16.80475	960-1240	7.25-7.75
4.125-4.128	25.5-25.67	1300-1427	8.025-8.5
4.17725-4.17775	37.5-38.25	1435-1626.5	9.0-9.2
4.20725-4.20775	73-74.6	1645.5-1646.5	9.3-9.5
6.215-6.218	74.8-75.2	1660-1710	10.6-12.7
6.26775-6.26825	108-121.94	1718.8-1722.2	13.25-13.4
6.31175-6.31225	123-138	2200-2300	14.47-14.5
8.291-8.294	149.9-150.05	2310-2390	15.35-16.2
8.362-8.366	156.52475-156.52525	2483.5-2500	17.7-21.4
8.37625-8.38675	156.7-156.9	2690-2900	22.01-23.12
8.41425-8.41475	162.0125-167.17	3260-3267	23.6-24.0
12.29-12.293	167.72-173.2	3332-3339	31.2-31.8
12.51975-12.52025	240-285	3345.8-3358	36.43-36.5
12.57675-12.57725	322-335.4	3600-4400	(²)
13.36-13.41			

LIMITS OF RADIATED EMISSION MEASUREMENT (Above 1000MHz)

FREQUENCY (MHz)	Limit (dBuV/m) (at 3M)	
	PEAK	AVERAGE
Above 1000	74	54

Notes:

- (1)The limit for radiated test was performed according to FCC PART 15C.
- (2)The tighter limit applies at the band edges.
- (3)Emission level (dBuV/m)=20log Emission level (uV/m).

8.3 Test Procedure

Receiver Parameter	Setting
Attenuation	Auto
Start Frequency	2300MHz
Stop Frequency	2520
RB / VB (emission in restricted band)	1 MHz / 1 MHz for Peak, 1 MHz / 1/T Hz for Average

Above 1GHz test procedure as below:

- a. The EUT was placed on the top of a rotating table 1.5 meters above the ground at a 3 meter chamber. The table was rotated 360 degrees to determine the position of the highest radiation.
- b. The EUT was set 3 meters away from the interference-receiving antenna, which was mounted on the top of a variable-height antenna tower.
- c. The antenna height is varied from one meter to four meters above the ground to determine the maximum value of the field strength. Both horizontal and vertical polarizations of the antenna are set to make the measurement.
- d. For each suspected emission, the EUT was arranged to its worst case and then the antenna was tuned to heights from 1 meter to 4 meters and the rota table was turned from 0 degrees to 360 degrees to find the maximum reading.
- e. The test-receiver system was set to Peak Detect Function and Specified Bandwidth with Maximum Hold Mode.
- f. If the emission level of the EUT in peak mode was 10dB lower than the limit specified, then testing could be stopped and the peak values of the EUT would be reported. Otherwise the emissions that did not have 10dB margin would be re-tested one by one using peak, quasi-peak or average method as specified and then reported in a data sheet.
- g. Test the EUT in the lowest channel, the Highest channel.

Note:

Both horizontal and vertical antenna polarities were tested and performed pretest to three orthogonal axis. The worst case emissions were reported.

8.4 EUT Operating Conditions

The EUT was configured for testing in a typical fashion (as a customer would normally use it). The EUT has been programmed to continuously transmit during test. This operating condition was tested and used to collect the included data.

8.5 Test Result

	Polar (H/V)	Frequency (MHz)	Reading Level (dBUV/m)	Correct Factor (dB)	Measurement (dBUV/m)	Limits (dBUV/m)		Result
					PK	PK	AV	
GFSK	Low Channel 2402MHz							
	H	2390.00	54.12	-6.70	47.42	74.00	54.00	PASS
	H	2400.00	57.99	-6.71	51.28	74.00	54.00	PASS
	V	2390.00	53.30	-6.70	46.60	74.00	54.00	PASS
	V	2400.00	57.48	-6.71	50.77	74.00	54.00	PASS
	High Channel 2480MHz							
	H	2483.50	58.40	-6.79	51.61	74.00	54.00	PASS
	H	2500.00	52.62	-6.81	45.81	74.00	54.00	PASS
	V	2483.50	55.49	-6.79	48.70	74.00	54.00	PASS
	V	2500.00	52.85	-6.81	46.04	74.00	54.00	PASS
$\pi/4$DQPSK	Low Channel 2402MHz							
	H	2390.00	54.42	-6.70	47.72	74.00	54.00	PASS
	H	2400.00	57.96	-6.71	51.25	74.00	54.00	PASS
	V	2390.00	55.04	-6.70	48.34	74.00	54.00	PASS
	V	2400.00	58.76	-6.71	52.05	74.00	54.00	PASS
	High Channel 2480MHz							
	H	2483.50	58.30	-6.79	51.51	74.00	54.00	PASS
	H	2500.00	51.85	-6.81	45.04	74.00	54.00	PASS
	V	2483.50	58.50	-6.79	51.71	74.00	54.00	PASS
	V	2500.00	53.66	-6.81	46.85	74.00	54.00	PASS
8DPSK	Low Channel 2402MHz							
	H	2390.00	53.63	-6.70	46.93	74.00	54.00	PASS
	H	2400.00	57.83	-6.71	51.12	74.00	54.00	PASS
	V	2390.00	53.02	-6.70	46.32	74.00	54.00	PASS
	V	2400.00	56.24	-6.71	49.53	74.00	54.00	PASS
	High Channel 2480MHz							
	H	2483.50	56.48	-6.79	49.69	74.00	54.00	PASS
	H	2500.00	51.78	-6.81	44.97	74.00	54.00	PASS
	V	2483.50	55.45	-6.79	48.66	74.00	54.00	PASS
	V	2500.00	52.72	-6.81	45.91	74.00	54.00	PASS

Remark:

- Emission Level = Meter Reading + Factor,
Factor = Antenna Factor + Cable Loss – Pre-amplifier.
Over= Emission Level – Limit
- If the PK measured levels comply with average limit, then the average level were deemed to comply with average limit.
- In restricted bands of operation, The spurious emissions below the permissible value more than 20dB
- The amplitude of spurious emissions which are attenuated by more than 20dB below the permissible value has no need to be reported.

9. Conducted Emission

9.1 Block Diagram Of Test Setup

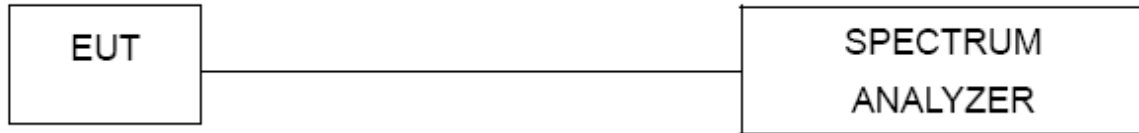

9.2 Limit

Regulation 15.247 (d), In any 100 kHz bandwidth outside the frequency band in which the spread spectrum or digitally modulated intentional radiator is operating, the radio frequency power that is produced by the intentional radiator shall be at least 20 dB below that in the 100 kHz bandwidth within the band that contains the highest level of the desired power, based on either an RF conducted or a radiated measurement, provided the transmitter demonstrates compliance with the peak conducted power limits. If the transmitter complies with the conducted power limits based on the use of RMS averaging over a time interval, as permitted under paragraph (b)(3) of this section, the attenuation required under this paragraph shall be 30 dB instead of 20 dB. Attenuation below the general limits specified in §15.209(a) is not required. In addition, radiated emissions which fall in the restricted bands, as defined in §15.205(a), must also comply with the radiated emission limits specified in §15.209(a) (see §15.205(c))

9.3 Test Procedure

1. Remove the antenna from the EUT and then connect a low RF cable from the antenna port to the spectrum;
2. Set the spectrum analyzer:
 - Below 1GHz:
 - RBW = 100kHz, VBW = 300kHz, Sweep = auto
 - Detector function = peak, Trace = max hold
 - Above 1GHz:
 - RBW = 1MHz, VBW = 3MHz, Sweep = auto
 - Detector function = peak, Trace = max hold

9.4 Test Result

Temperature :	26°C	Relative Humidity :	54%
Test Voltage :	AC120V/60Hz	Remark:	N/A

30MHz – 25GHz GFSK Low Channel

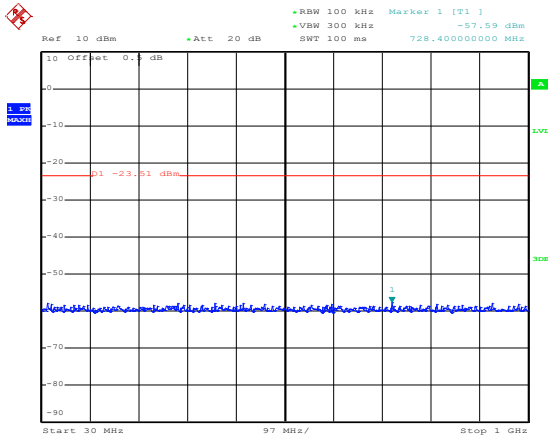

Date: 12.APR.2022 10:00:50

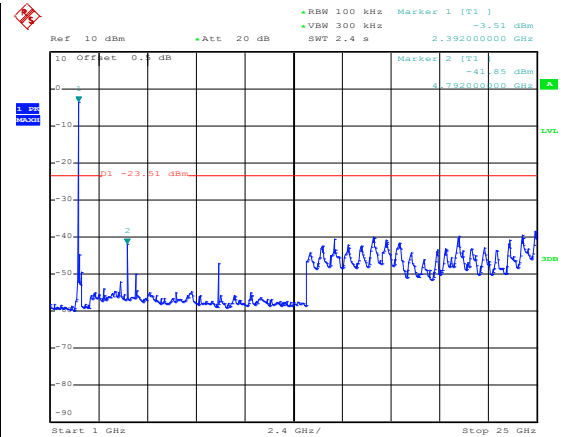

Date: 12.APR.2022 09:59:39

GFSK Middle Channel

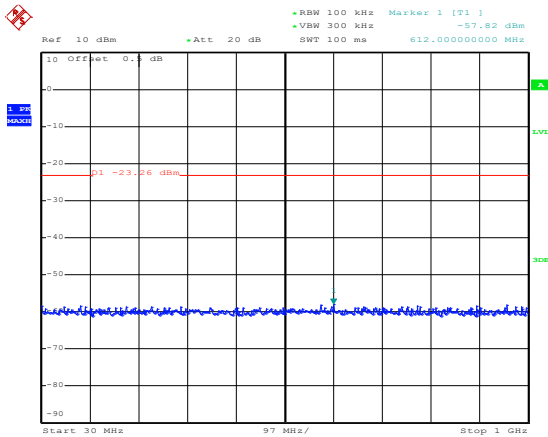

Date: 12.APR.2022 10:04:39

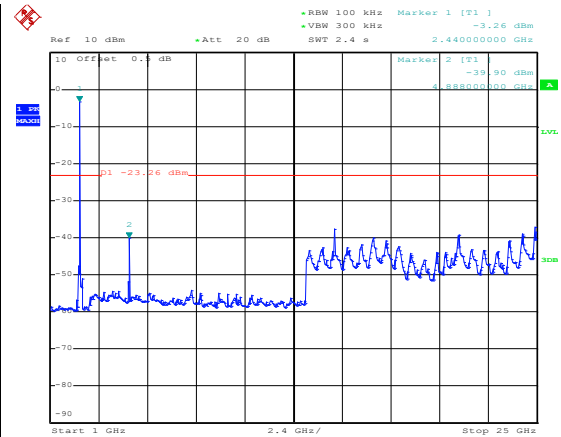

Date: 12.APR.2022 10:03:48

GFSK High Channel

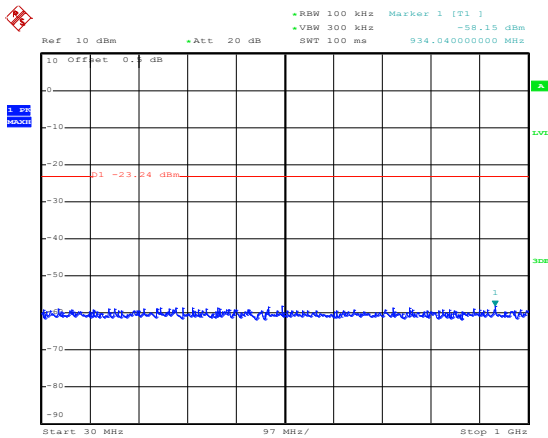

Date: 12.APR.2022 10:23:41

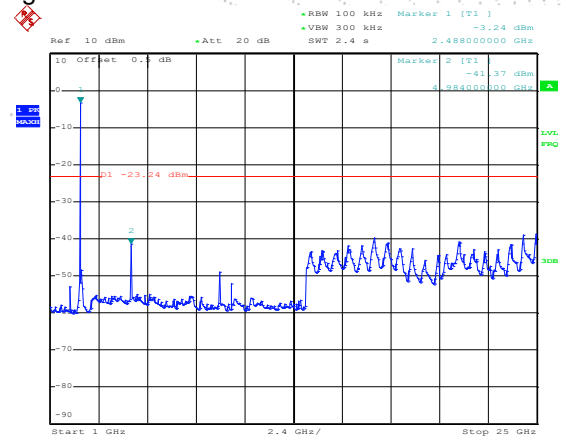

Date: 12.APR.2022 10:17:53

$\pi/4$ DQPSK Low Channel

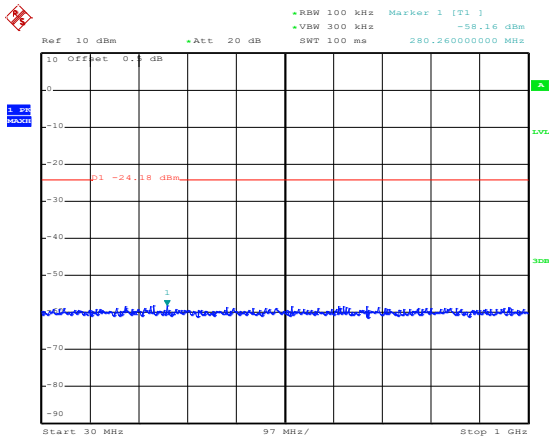

Date: 12.APR.2022 09:56:16

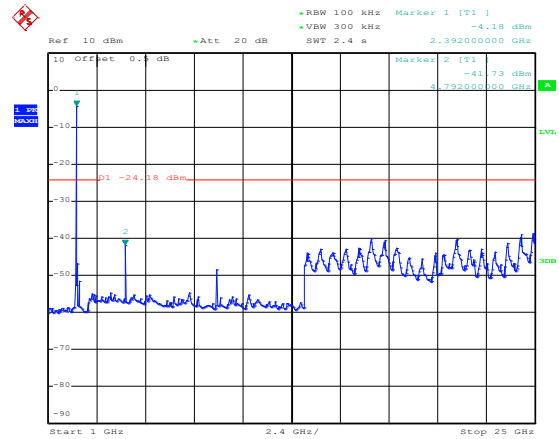

Date: 12.APR.2022 09:55:43

$\pi/4$ DQPSK Middle Channel

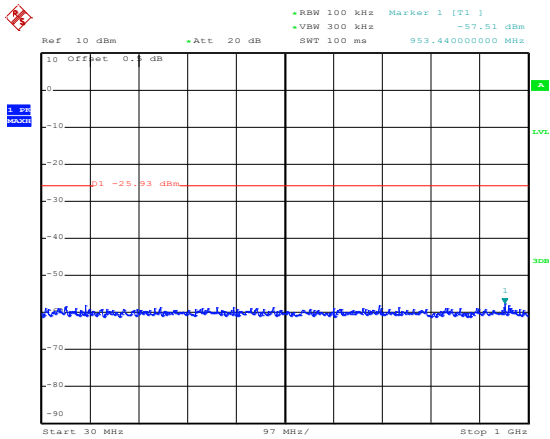

Date: 12.APR.2022 10:07:24

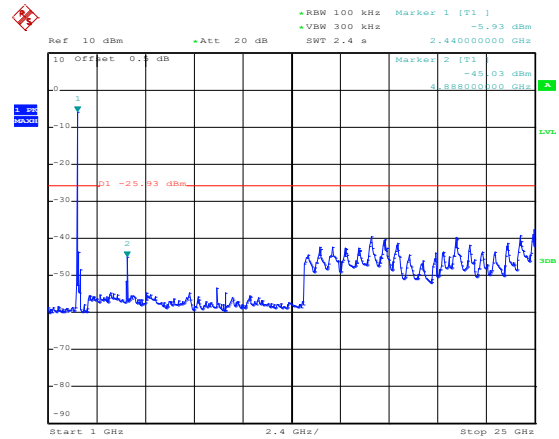

Date: 12.APR.2022 10:06:51

$\pi/4$ DQPSK High Channel

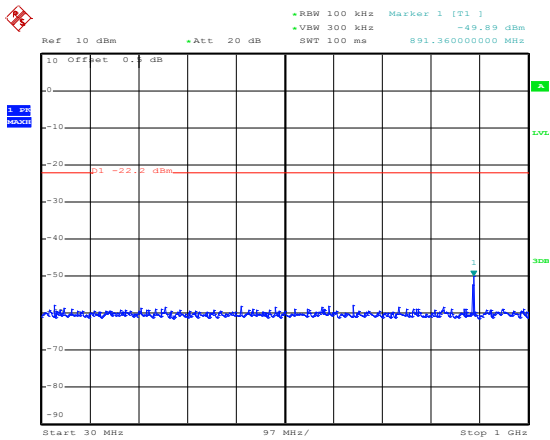

Date: 12.APR.2022 10:23:00

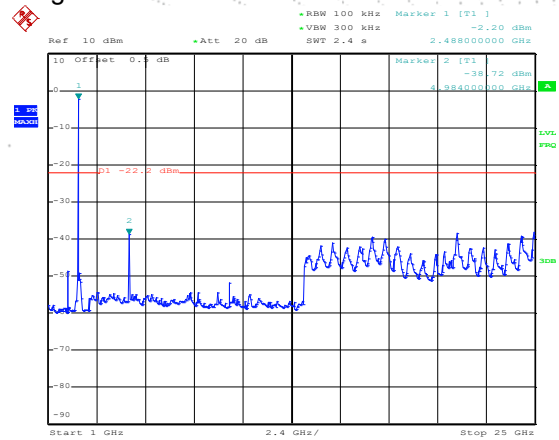

Date: 12.APR.2022 10:16:04

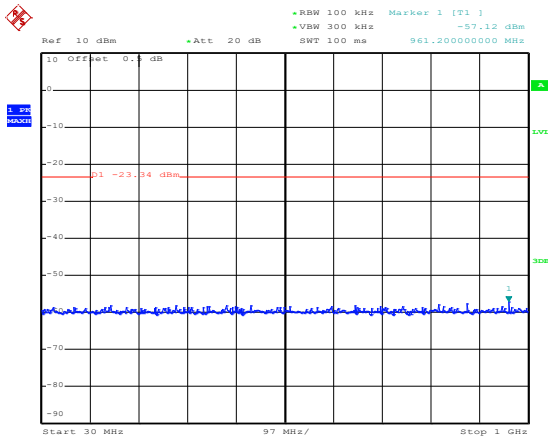
8DPSK Low Channel

Date: 12.APR.2022 09:57:22

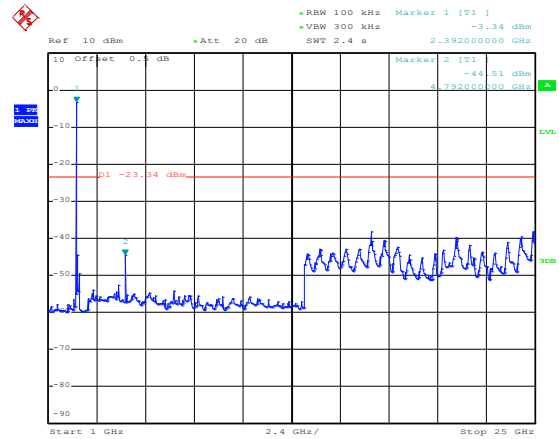

Date: 12.APR.2022 09:53:46

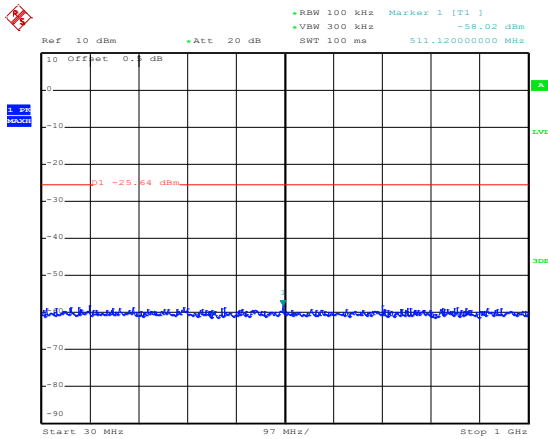
8DPSK Middle Channel

Date: 12.APR.2022 10:09:53

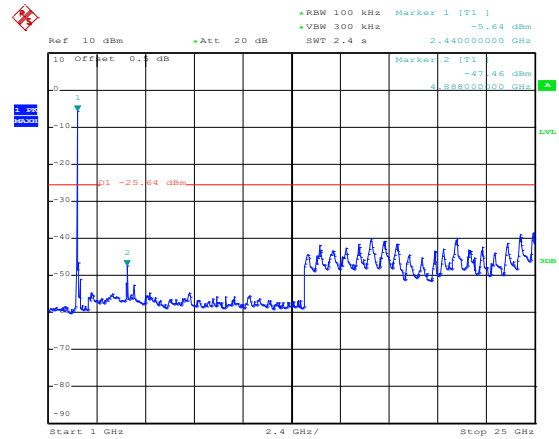

Date: 12.APR.2022 10:09:34

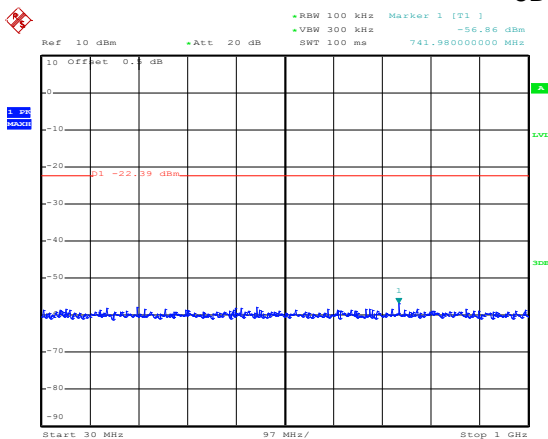
8DPSK High Channel

Date: 12.APR.2022 10:22:01

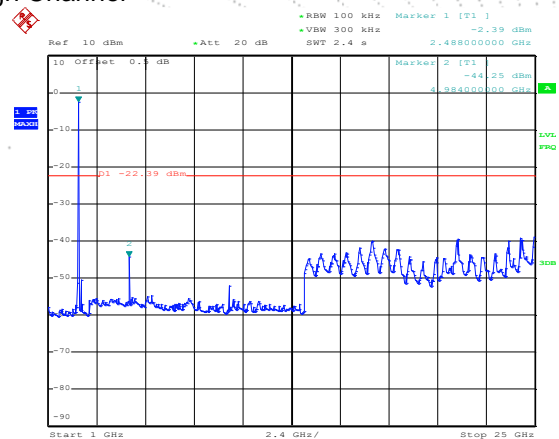

Date: 12.APR.2022 10:19:09

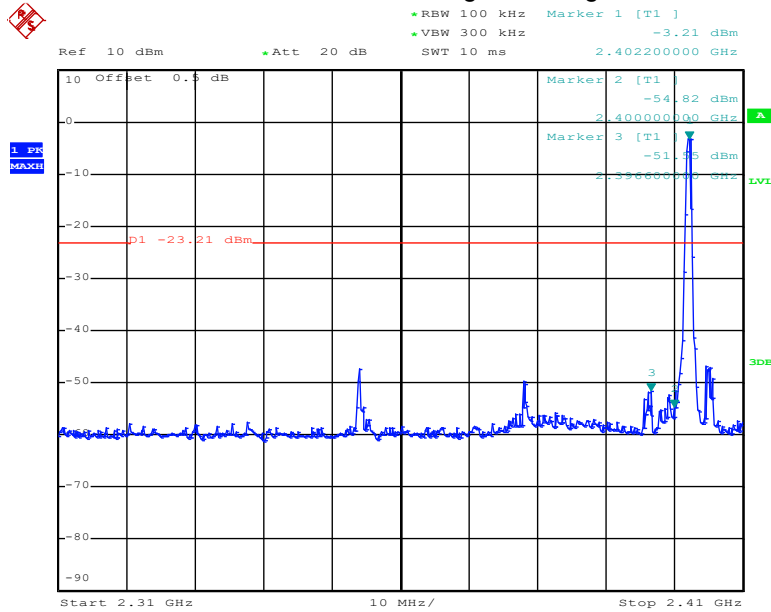
GFSK Transmitting Band edge-left side

Date: 12.APR.2022 10:35:00

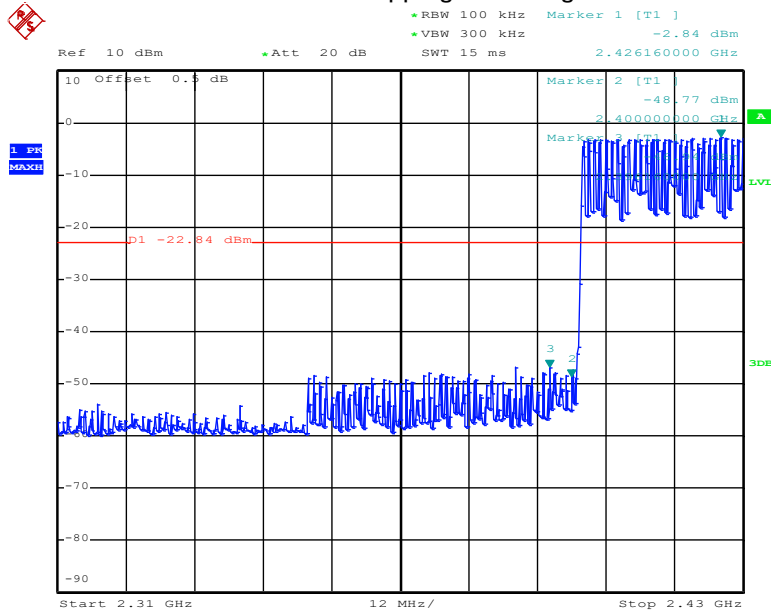
GFSK Hopping Band edge-left side

Date: 12.APR.2022 10:48:00

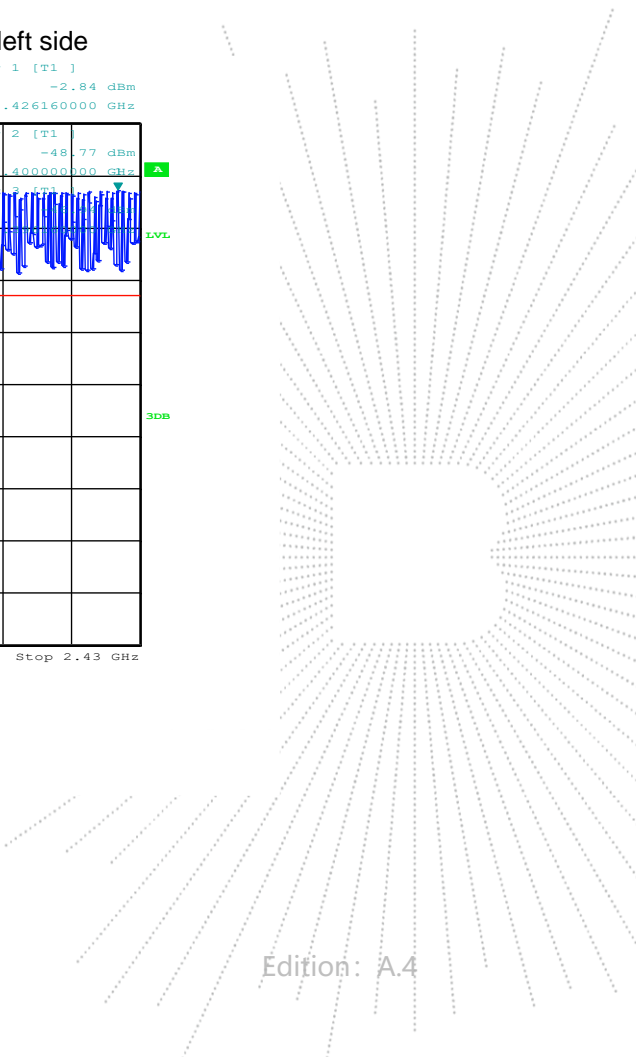

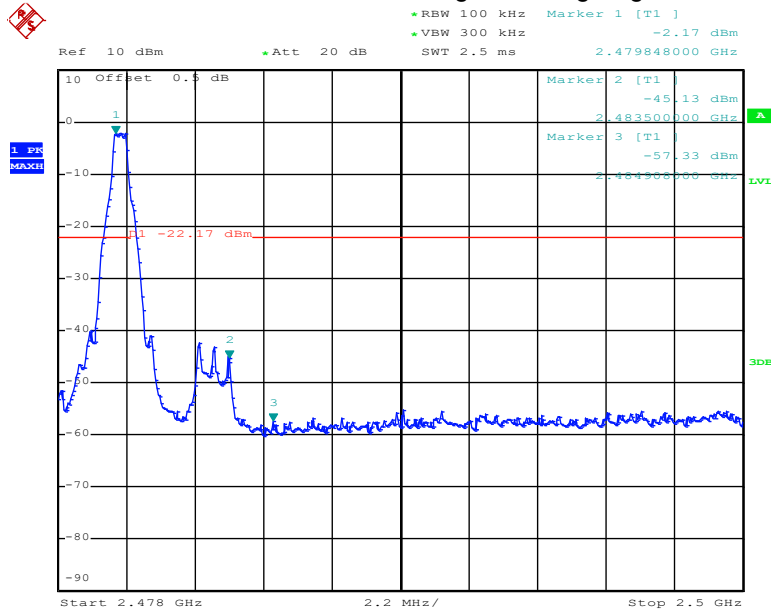
GFSK Transmitting Band edge-right side

Date: 12.APR.2022 10:36:22

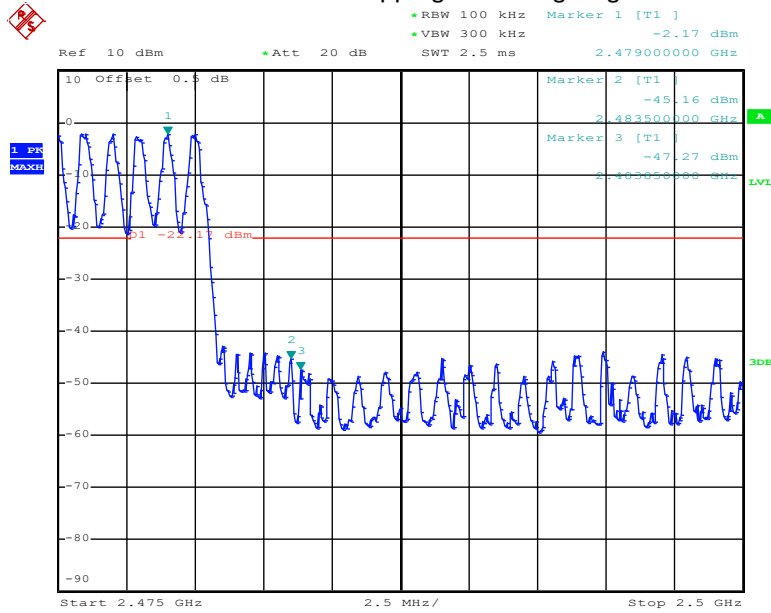
GFSK Hopping Band edge-right side

Date: 12.APR.2022 11:04:07

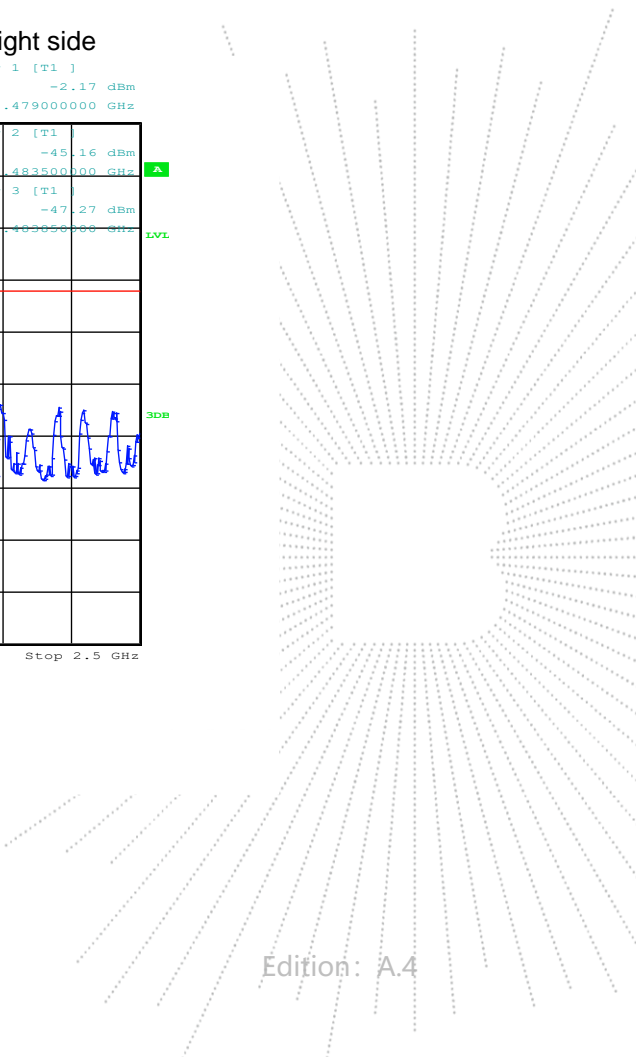

$\pi/4$ DQPSK Transmitting Band edge-left side

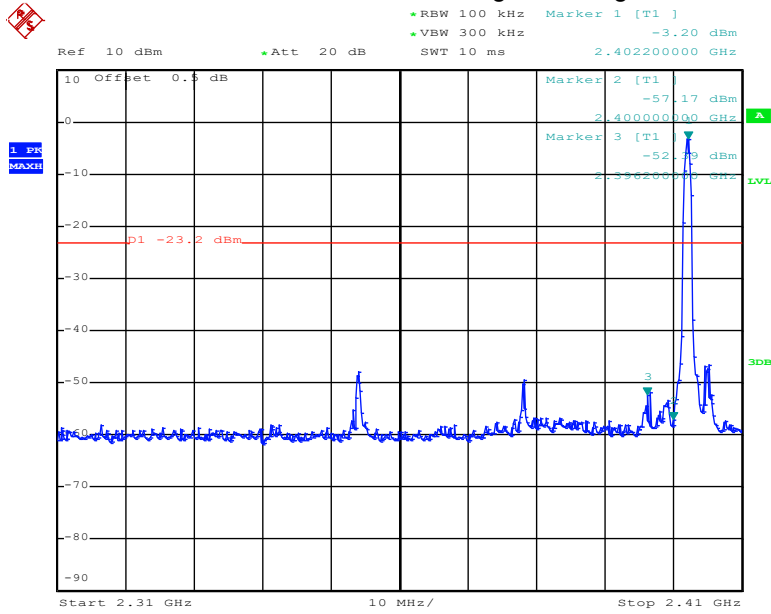

Date: 12.APR.2022 10:34:13

$\pi/4$ DQPSK Hopping Band edge-left side

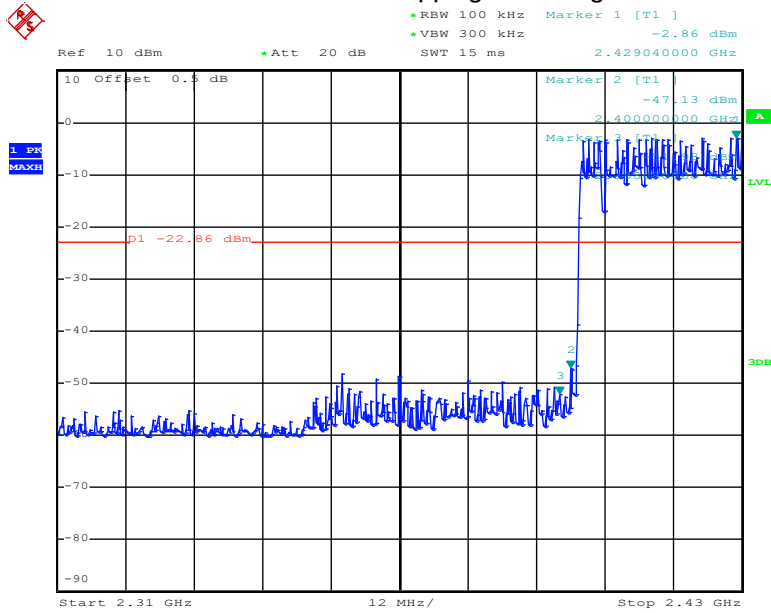

Date: 12.APR.2022 10:50:48

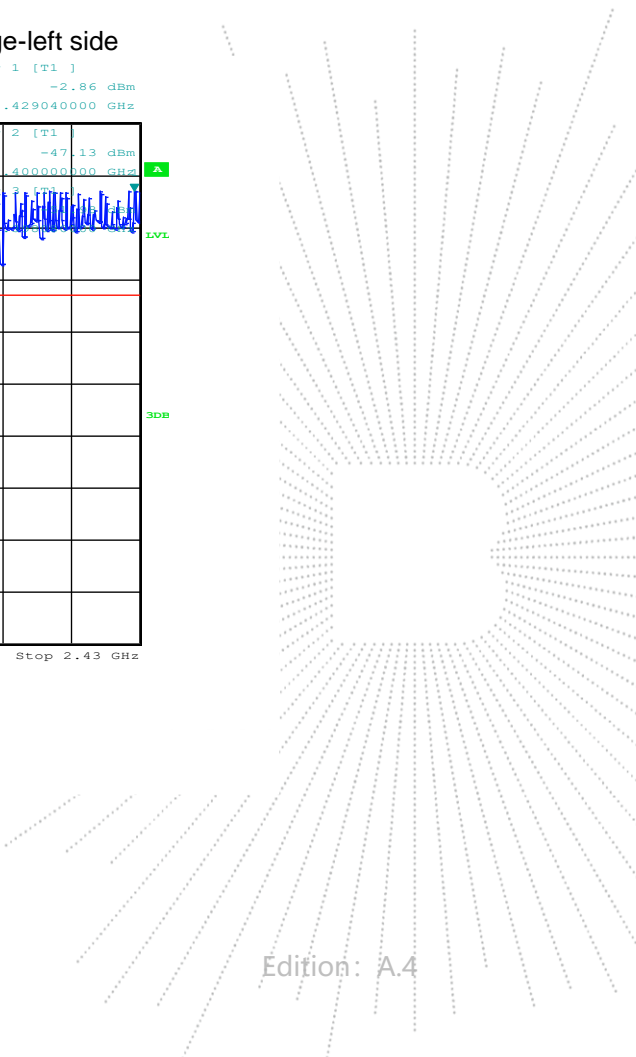

$\pi/4$ DQPSK Transmitting Band edge-right side

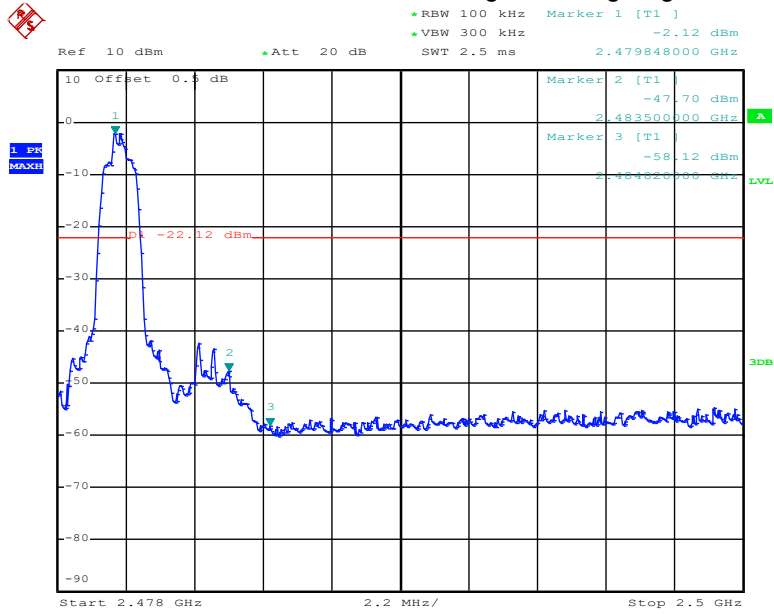

Date: 12.APR.2022 10:37:30

$\pi/4$ DQPSK Hopping Band edge-right side

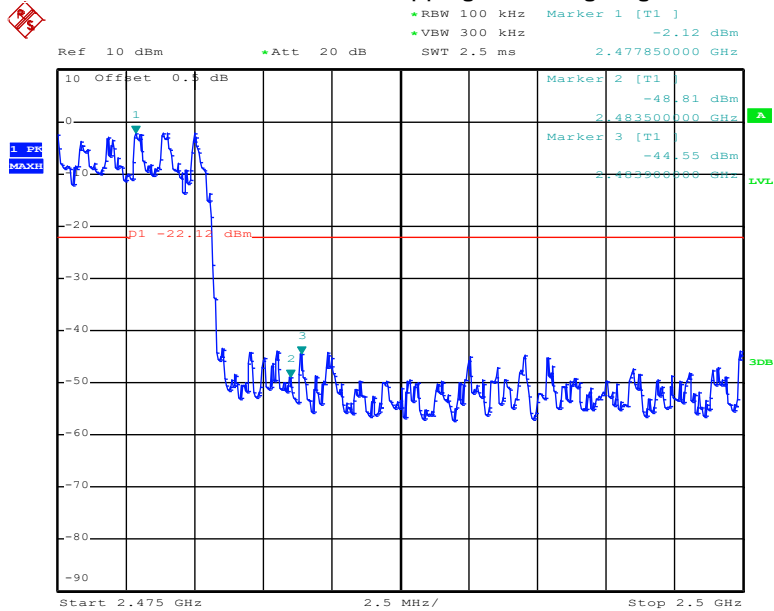

Date: 12.APR.2022 11:02:01

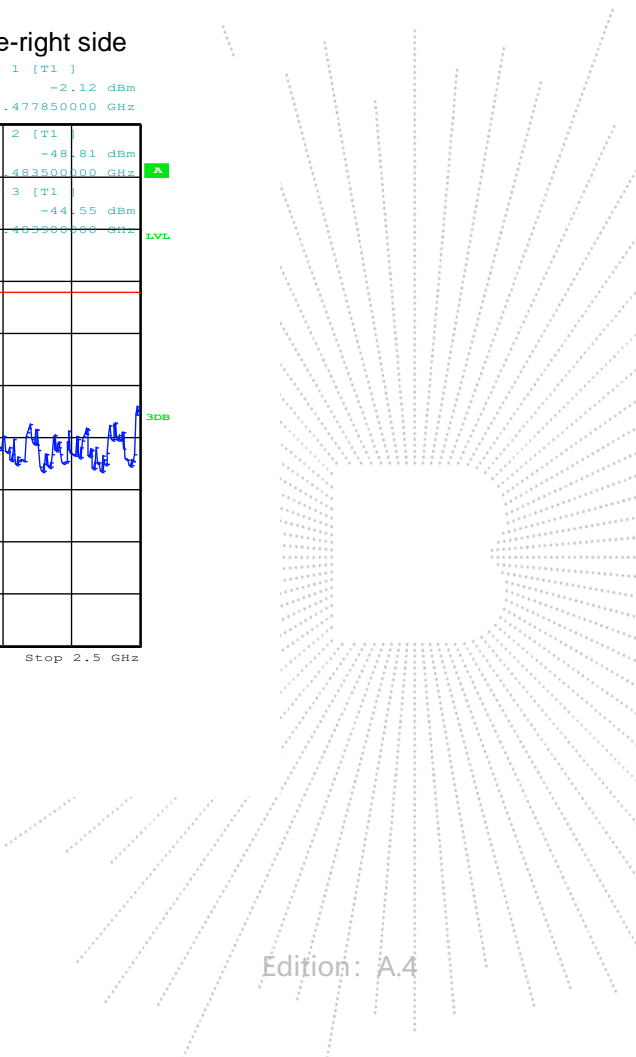

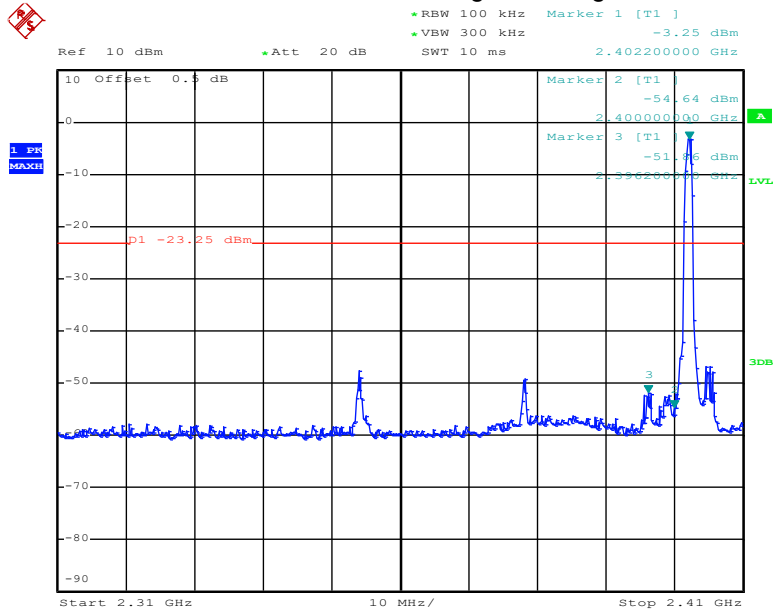
8DPSK Transmitting Band edge-left side

Date: 12.APR.2022 10:33:45

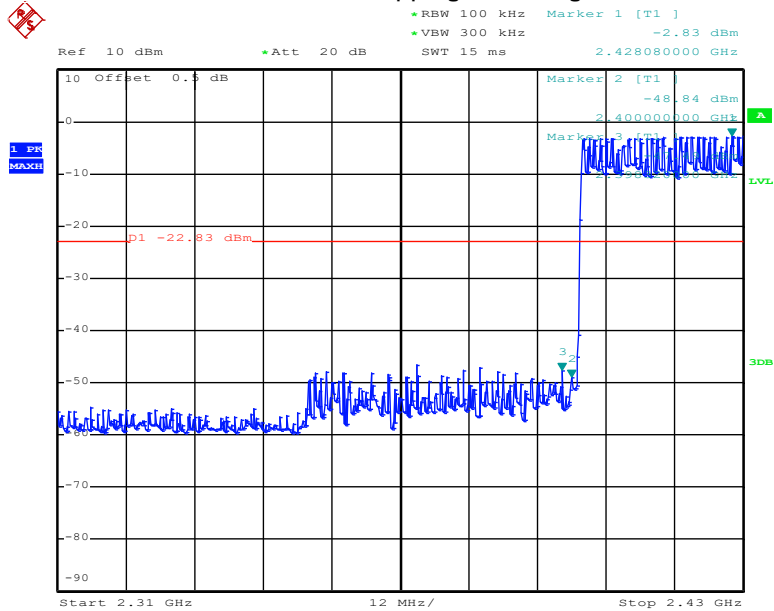
8DPSK Hopping Band edge-left side

Date: 12.APR.2022 10:55:24

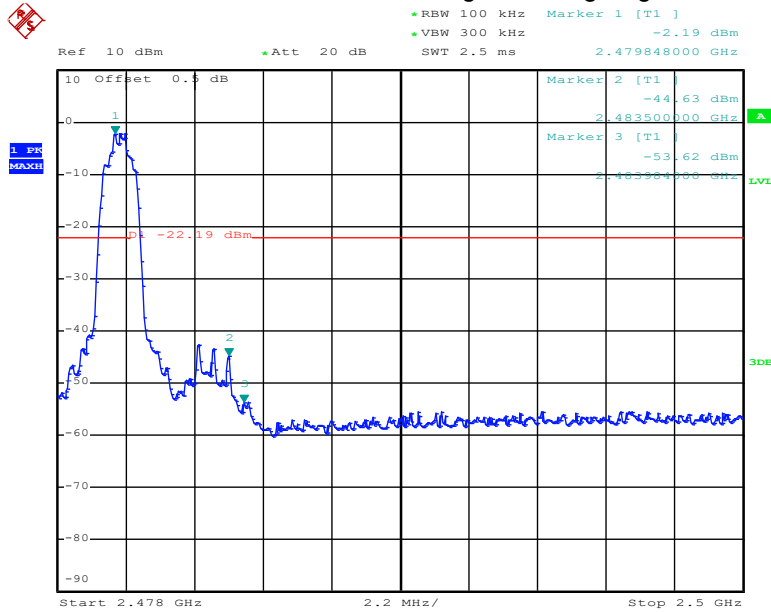
8DPSK Transmitting Band edge-right side

Date: 12.APR.2022 10:39:10

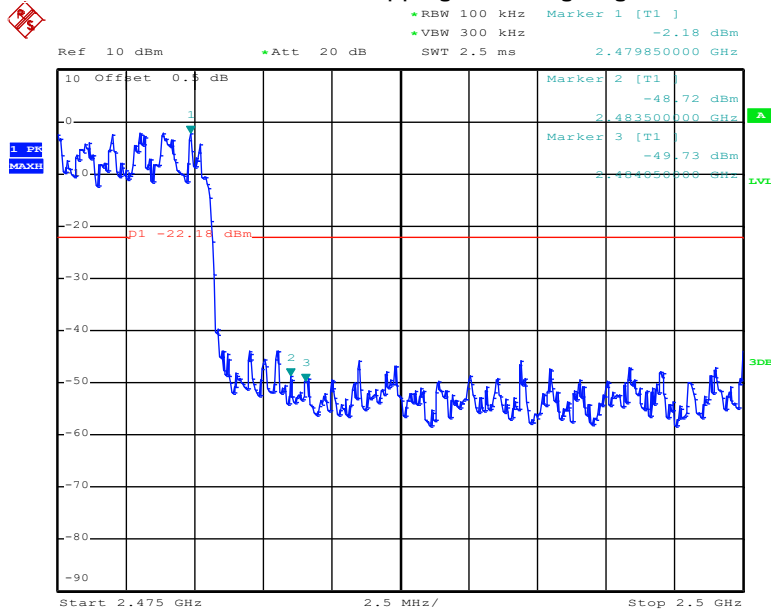
8DPSK Hopping Band edge-right side

Date: 12.APR.2022 10:58:57

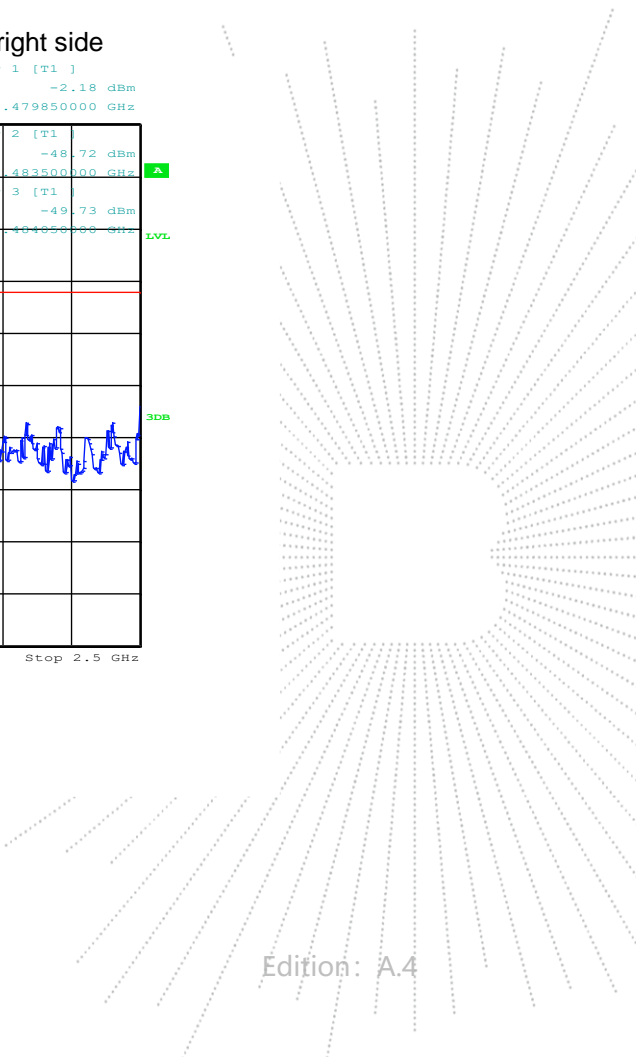

10. 20 DB Bandwidth

10.1 Block Diagram Of Test Setup



10.2 Limit

N/A

10.3 Test Procedure

1. Set RBW = 30kHz.
2. Set the video bandwidth (VBW) $\geq 3 \times$ RBW.
3. Detector = Peak.
4. Trace mode = max hold.
5. Sweep = auto couple.
6. Allow the trace to stabilize.
7. Measure the maximum width of the emission that is constrained by the frequencies associated with the two outermost amplitude points (upper and lower frequencies) that are attenuated by 20 dB relative to the maximum level measured in the fundamental emission. .

10.4 Test Result

Temperature :	26°C	Relative Humidity :	54%
Test Voltage :	AC120V/60Hz	Remark	N/A

Modulation	Test Channel	Bandwidth(MHz)
GFSK	Low	0.798
GFSK	Middle	0.816
GFSK	High	0.810
π /4DQPSK	Low	1.164
π /4DQPSK	Middle	1.164
π /4DQPSK	High	1.164
8DPSK	Low	1.140
8DPSK	Middle	1.146
8DPSK	High	1.146

Test plots

GFSK Low Channel

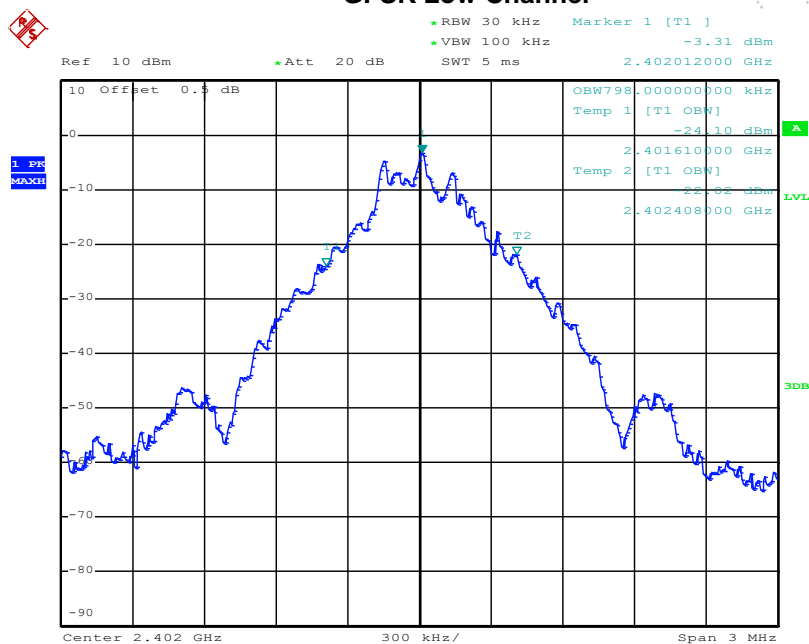

Date: 12.APR.2022 09:50:05

GFSK Middle Channel

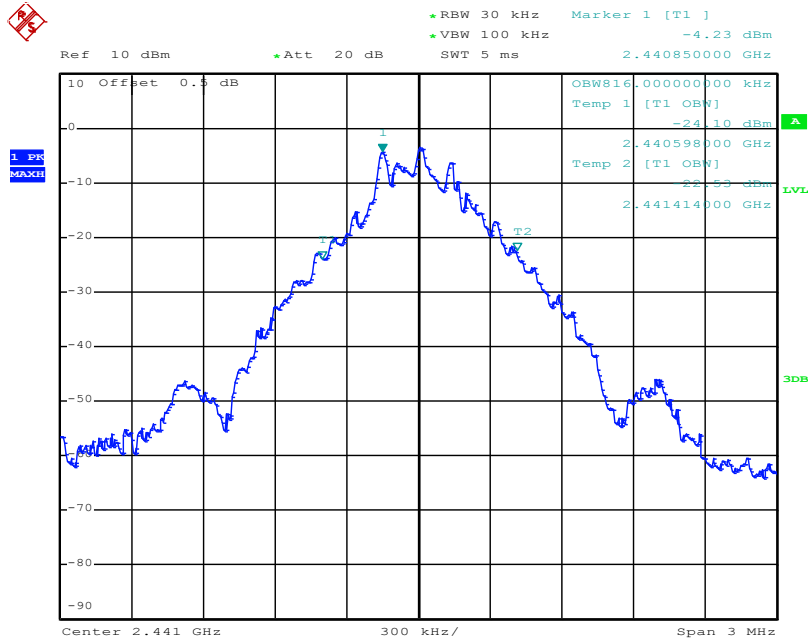

Date: 12.APR.2022 09:49:26

GFSK High Channel

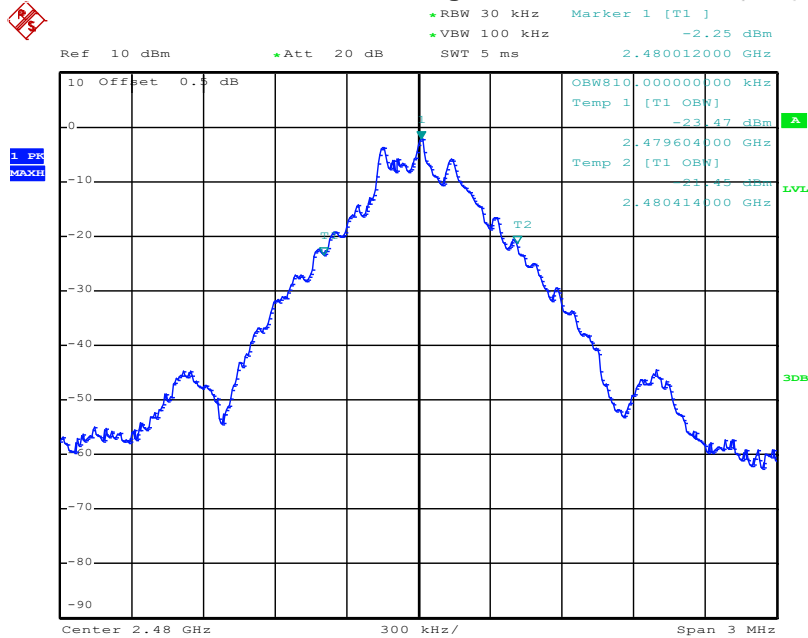

Date: 12.APR.2022 09:47:53

$\pi/4$ DQPSK Low Channel

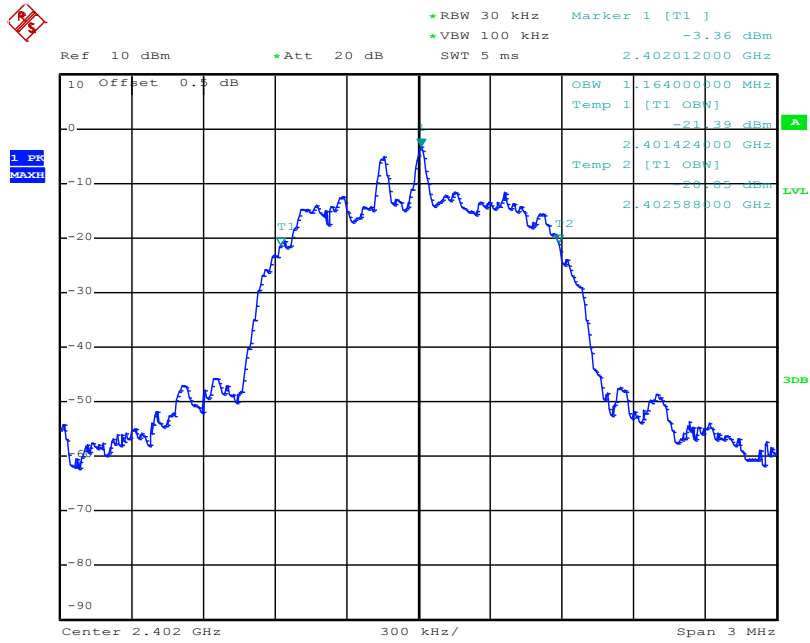

Date: 12.APR.2022 09:50:15

$\pi/4$ DQPSK Middle Channel

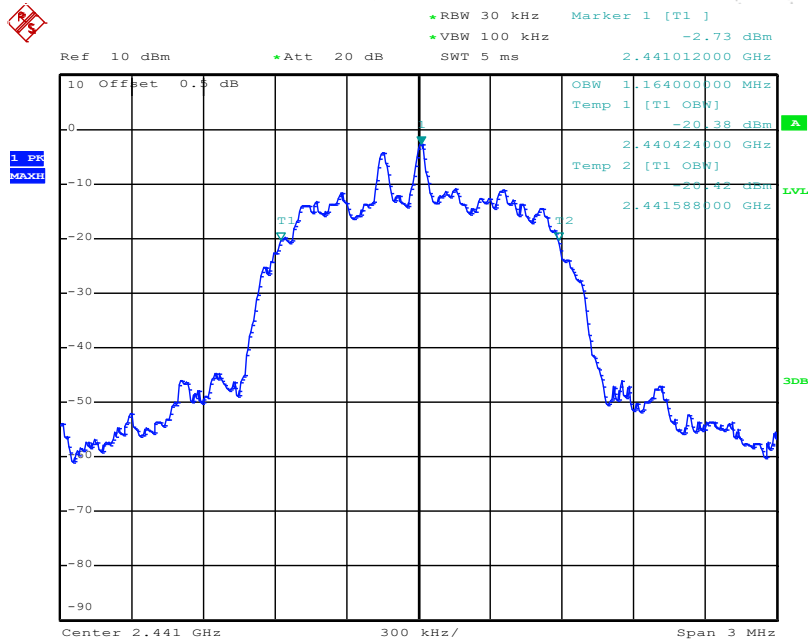

Date: 12.APR.2022 09:49:16

$\pi/4$ DQPSK High Channel

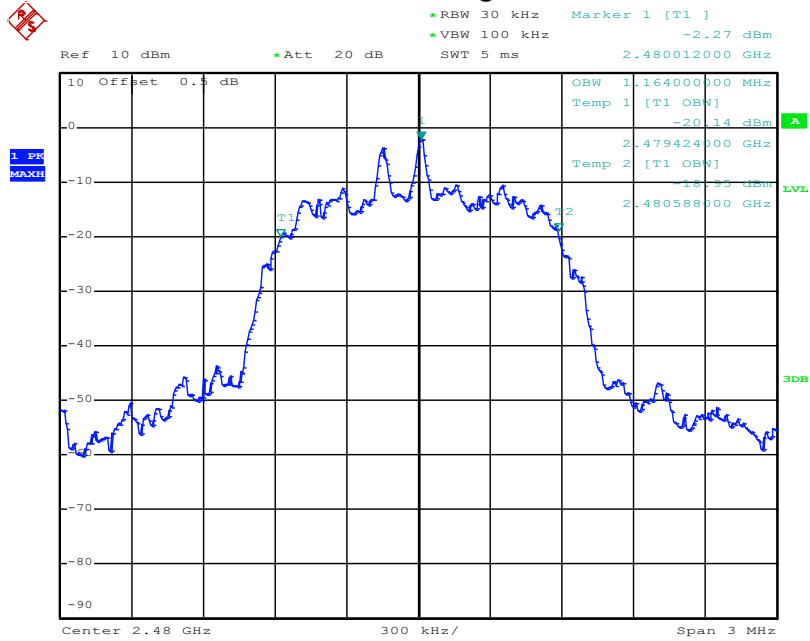

Date: 12.APR.2022 09:48:11

8DPSK Low Channel

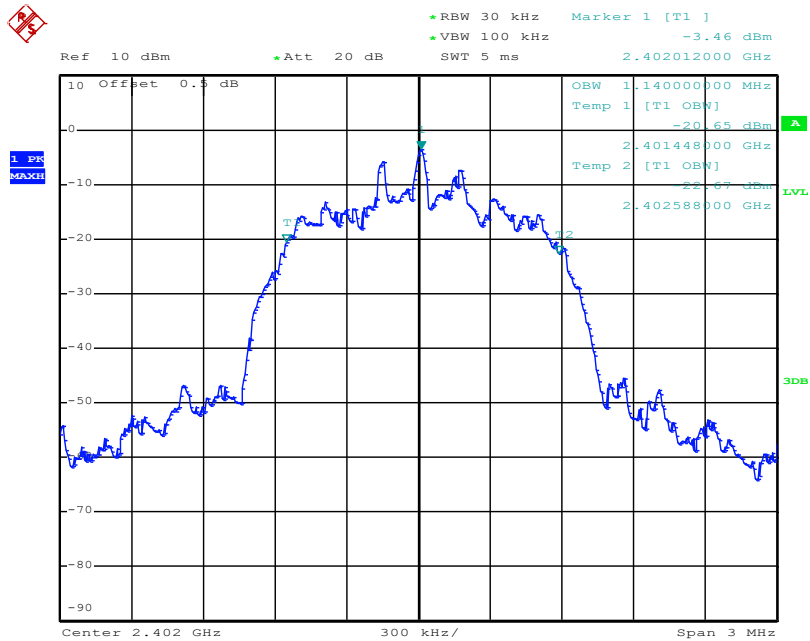

Date: 12.APR.2022 09:50:26

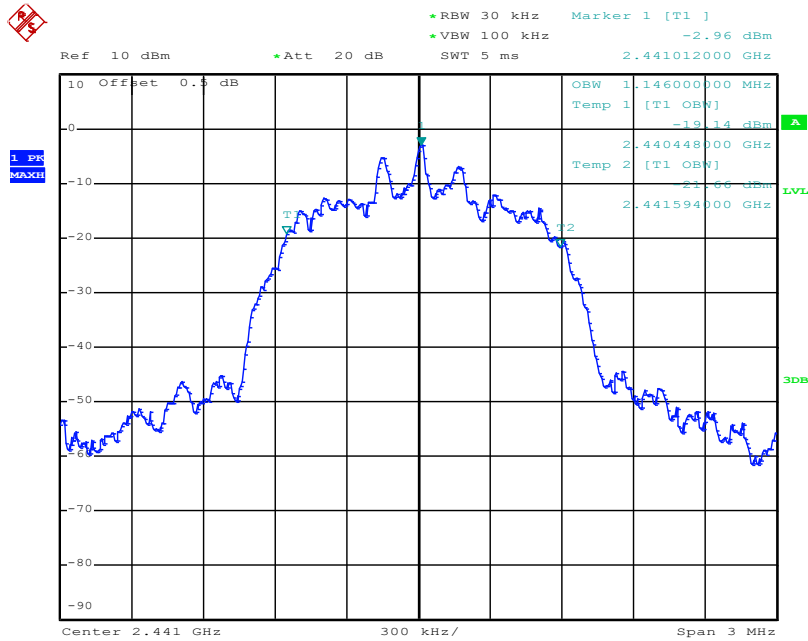
8DPSK Middle Channel

Date: 12.APR.2022 09:49:05

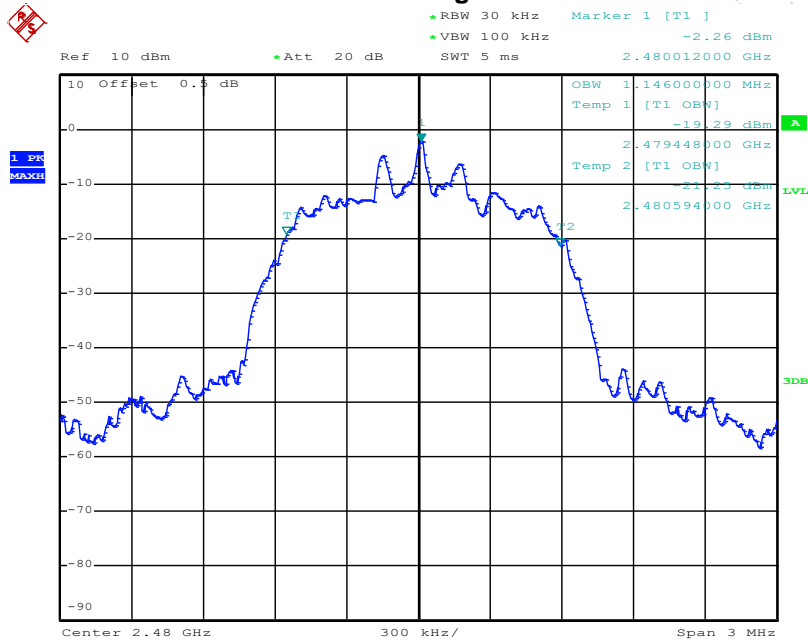
8DPSK High Channel

Date: 12.APR.2022 09:48:33

11. Maximum Peak Output Power

11.1 Block Diagram Of Test Setup



11.2 Limit

FCC Part15 (15.247), Subpart C				
Section	Test Item	Limit	Frequency Range (MHz)	Result
15.247(b)(1)	Peak Output Power	0.125 watt or 21dBm	2400-2483.5	PASS

11.3 Test Procedure

1. Remove the antenna from the EUT and then connect a low RF cable from the antenna port to the spectrum.
2. Set the spectrum analyzer: RBW = 3MHz. VBW = 3MHz. Sweep = auto; Detector Function = Peak.
3. Keep the EUT in transmitting at lowest, medium and highest channel individually. Record the max value.

11.4 Test Result

Temperature :	26°C	Relative Humidity :	54%
Test Voltage :	AC120V/60Hz	Remark:	N/A

Modulation	Test Channel	Output Power (dBm)	Limit (dBm)
GFSK	Low	-3.20	21
GFSK	Middle	-2.54	21
GFSK	High	-2.16	21
$\pi/4$ DQPSK	Low	-2.51	21
$\pi/4$ DQPSK	Middle	-1.70	21
$\pi/4$ DQPSK	High	-1.33	21
8DPSK	Low	-2.21	21
8DPSK	Middle	-1.18	21
8DPSK	High	-0.81	21

Test plots
GFSK Low Channel

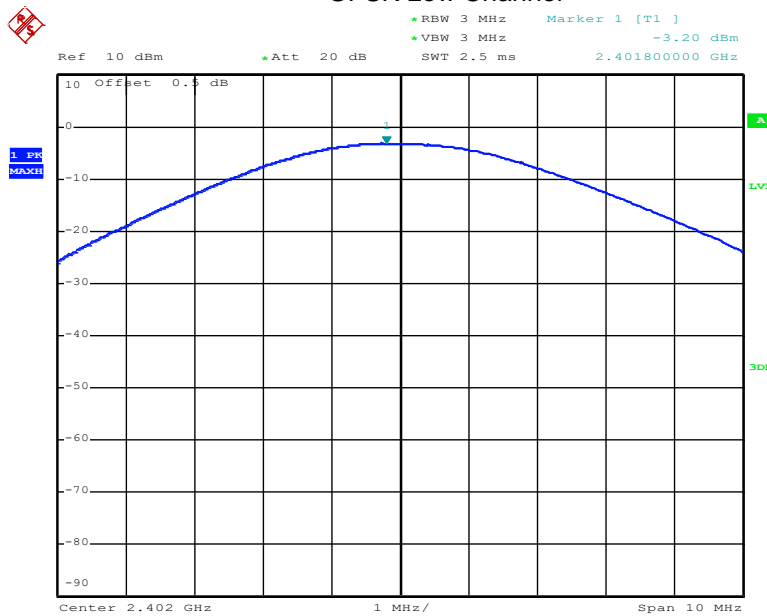

Date: 12.APR.2022 09:39:35

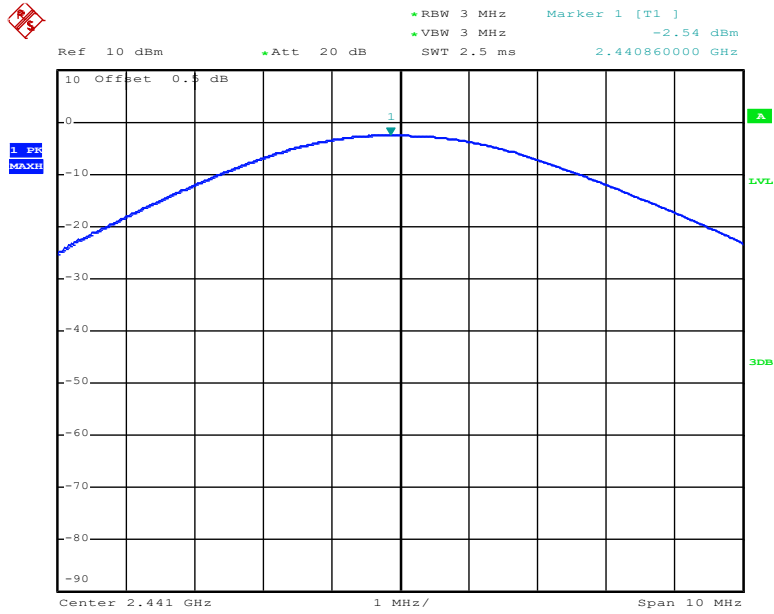
GFSK Middle Channel

Date: 12.APR.2022 09:37:41

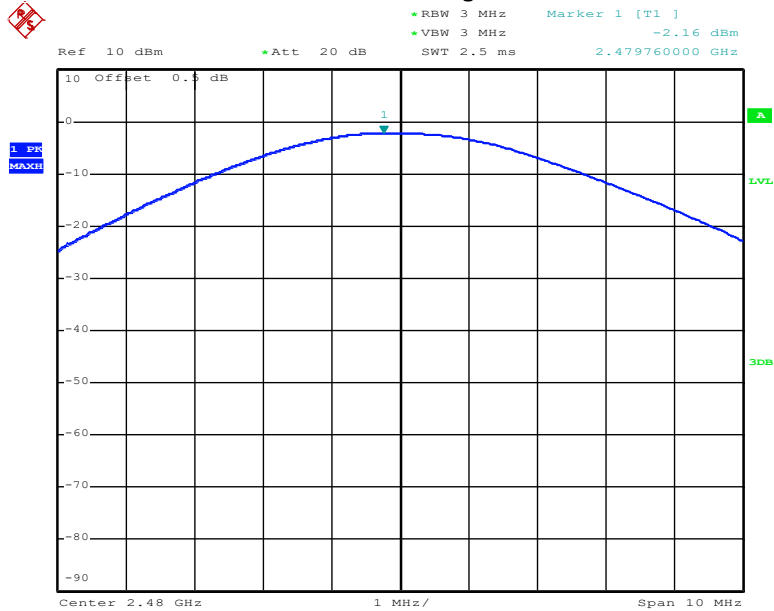
GFSK High Channel

Date: 12.APR.2022 09:39:02

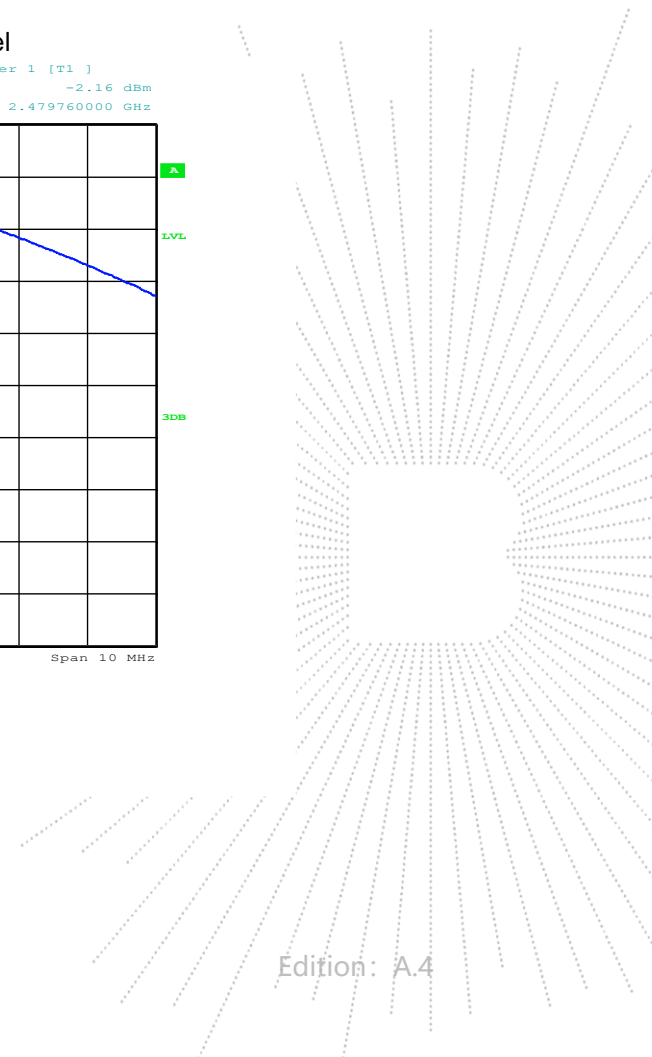

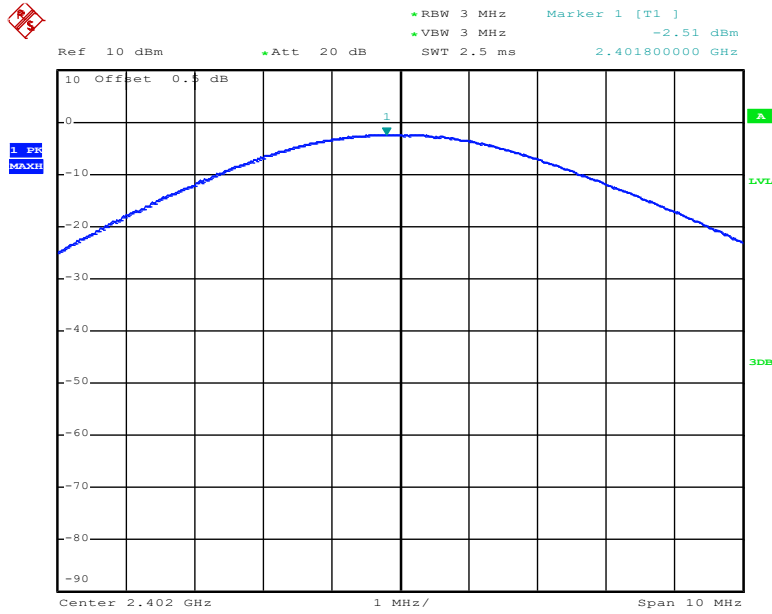
$\pi/4$ DQPSK Low Channel

Date: 12.APR.2022 09:39:49

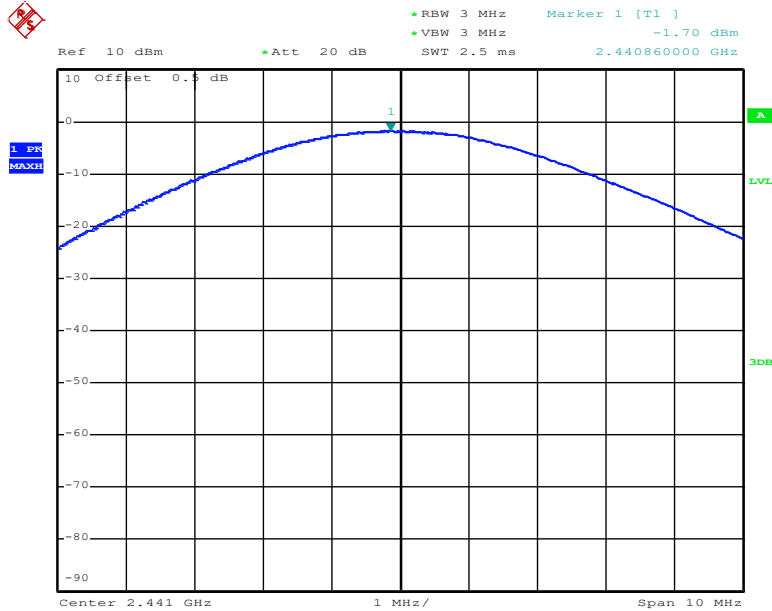
 $\pi/4$ DQPSK Middle Channel

Date: 12.APR.2022 09:37:52

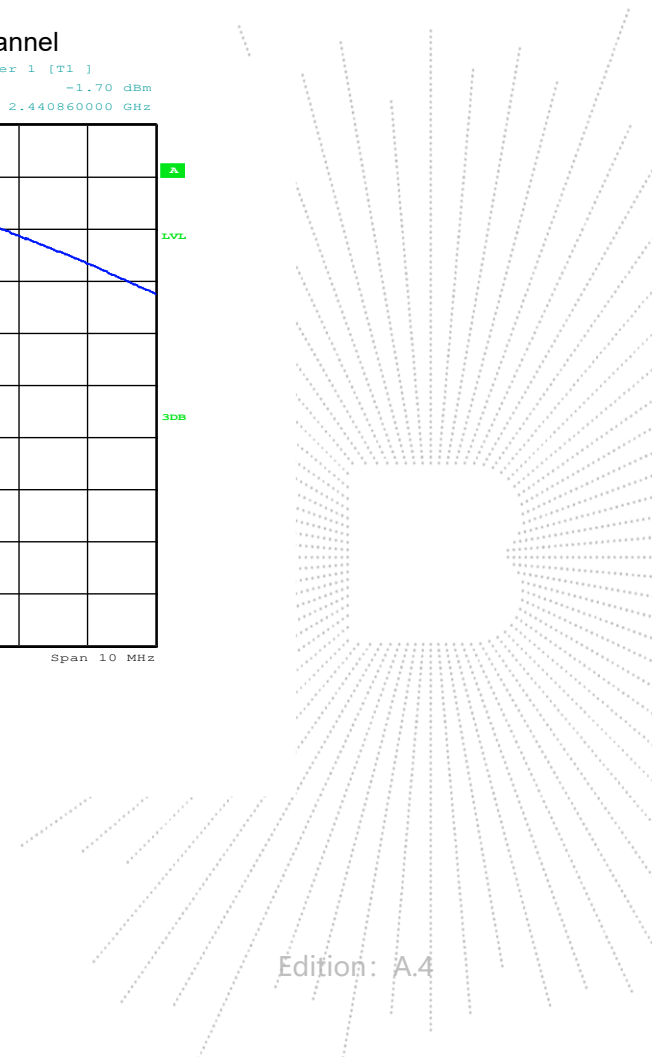

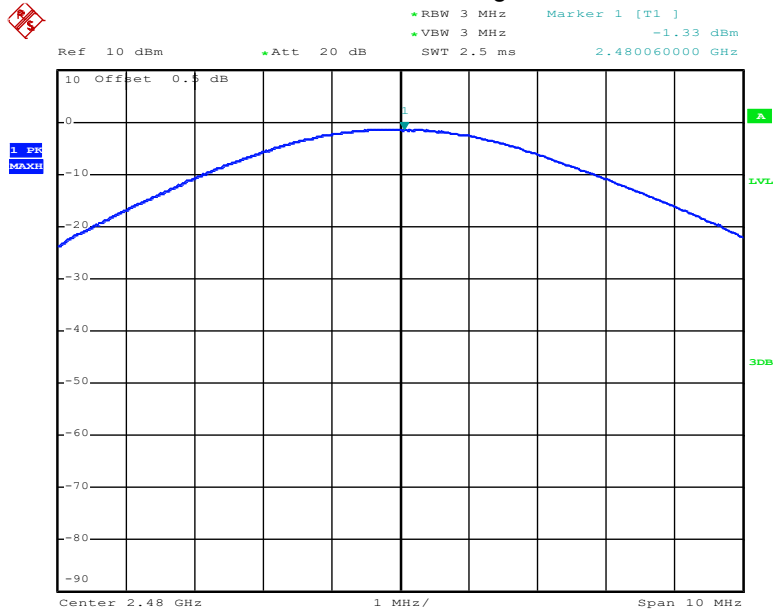
$\pi/4$ DQPSK High Channel

Date: 12.APR.2022 09:38:51

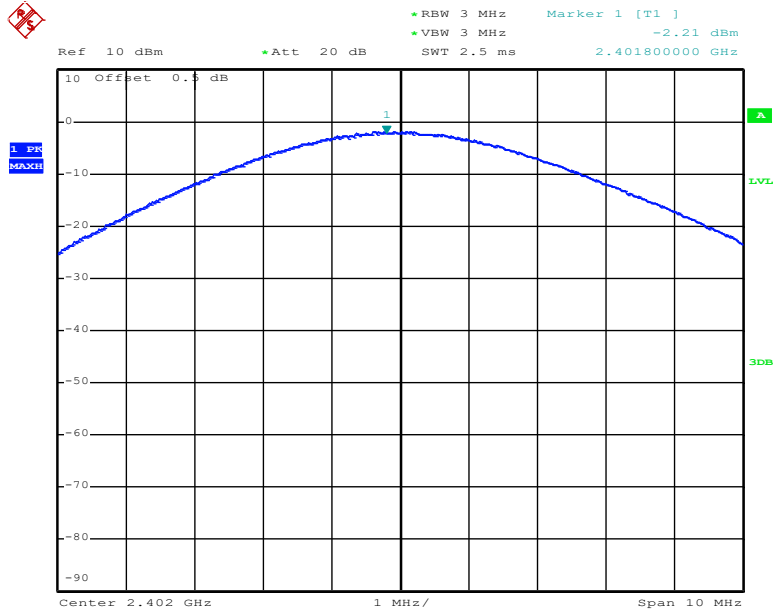
8DPSK Low Channel

Date: 12.APR.2022 09:39:59

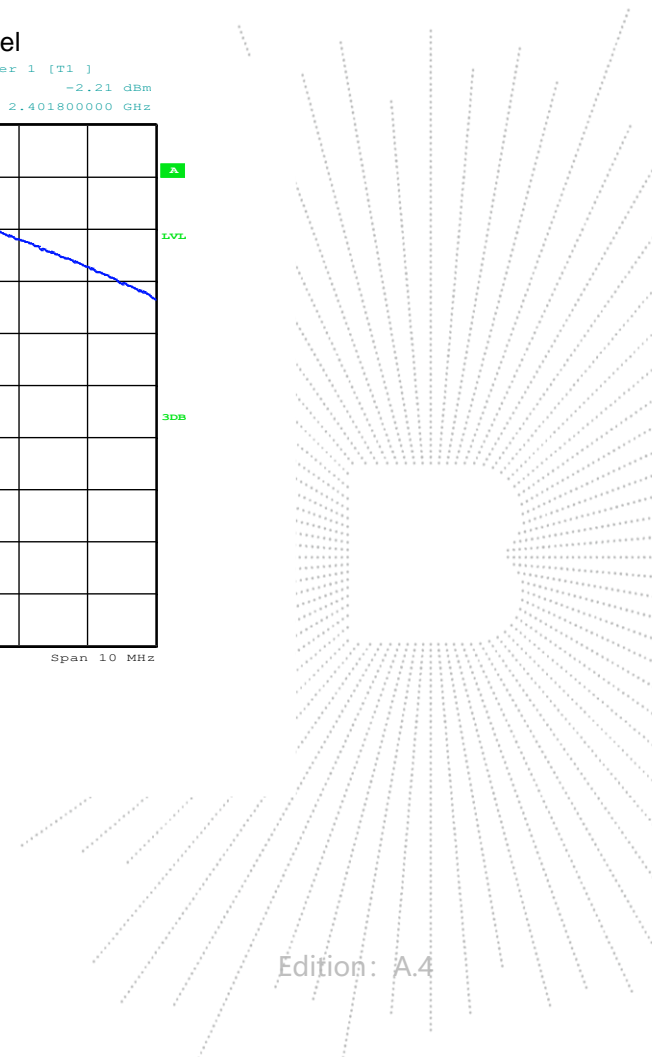

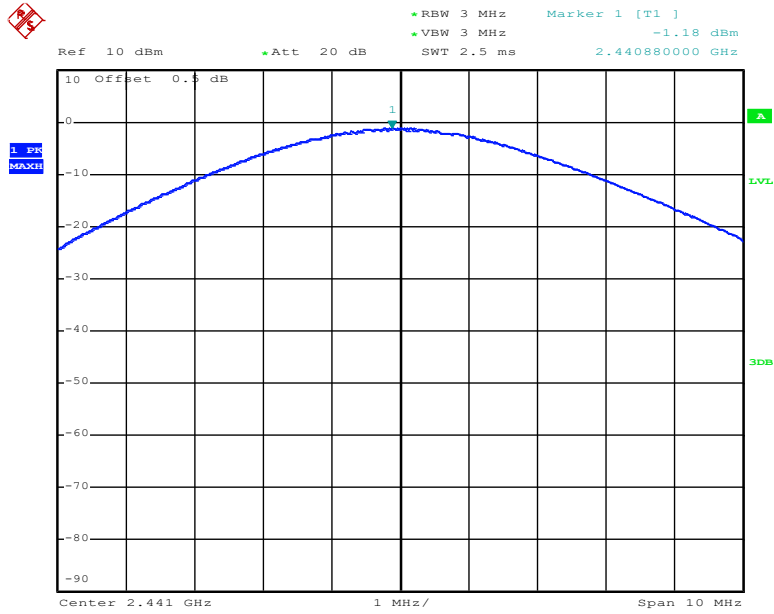
8DPSK Middle Channel

Date: 12.APR.2022 09:38:03

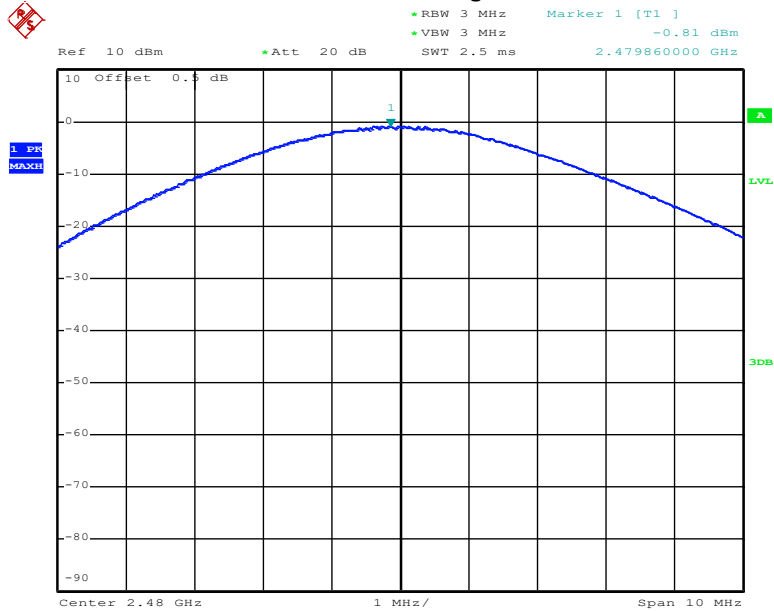
8DPSK High Channel

Date: 12.APR.2022 09:38:40

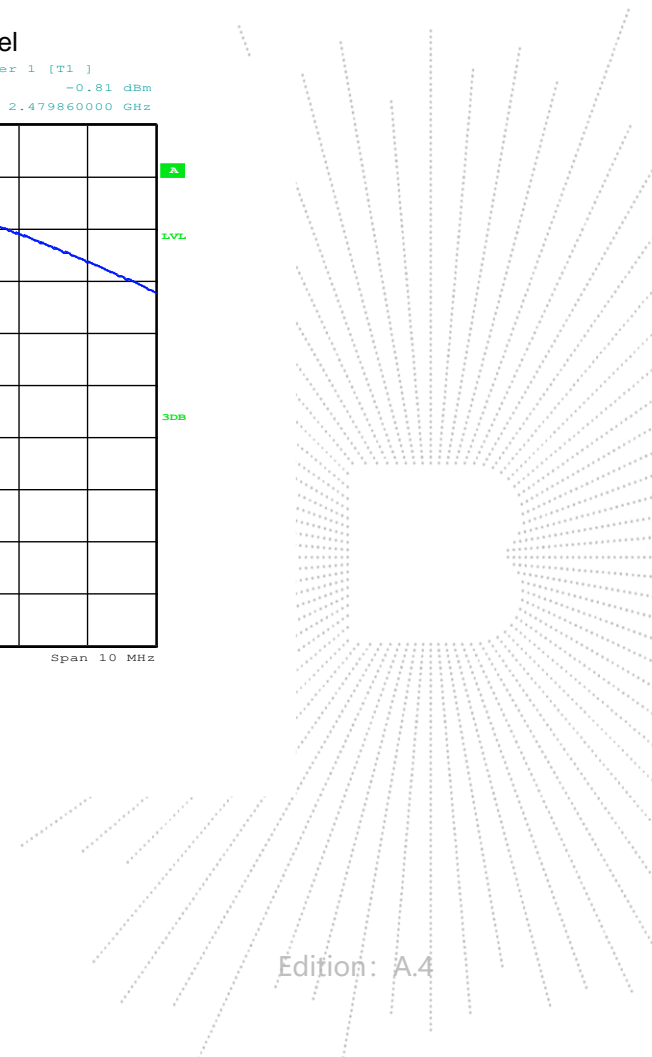

12. Hopping Channel Separation

12.1 Block Diagram Of Test Setup



12.2 Limit

Frequency hopping systems shall have hopping channel carrier frequencies separated by a minimum of 25 kHz or the 20 dB bandwidth of the hopping channel, whichever is greater. Alternatively, frequency hopping systems operating in the 2400-2483.5 MHz band may have hopping channel carrier frequencies that are separated by 25 kHz or two-thirds of the 20 dB bandwidth of the hopping channel, whichever is greater, provided the systems operate with an output power no greater than 0.125W.

12.3 Test Procedure

1. Remove the antenna from the EUT and then connect a low RF cable from the antenna port to the spectrum.
2. Set the spectrum analyzer: RBW = 30kHz. VBW = 100kHz , Span = 2.0MHz. Sweep = auto; Detector Function = Peak. Trace = Max hold.
3. Allow the trace to stabilize. Use the marker-delta function to determine the separation between the peaks of the adjacent channels. The limit is specified in one of the subparagraphs of this Section Submit this plot.

12.4 Test Result

Modulation	Test Channel	Separation (MHz)	Limit(MHz)	Result
GFSK	Low	1.004	0.798	PASS
GFSK	Middle	1.004	0.816	PASS
GFSK	High	1.000	0.810	PASS
$\pi/4$ DQPSK	Low	1.004	0.776	PASS
$\pi/4$ DQPSK	Middle	1.004	0.776	PASS
$\pi/4$ DQPSK	High	1.000	0.776	PASS
8DPSK	Low	1.004	0.760	PASS
8DPSK	Middle	1.004	0.764	PASS
8DPSK	High	1.000	0.764	PASS

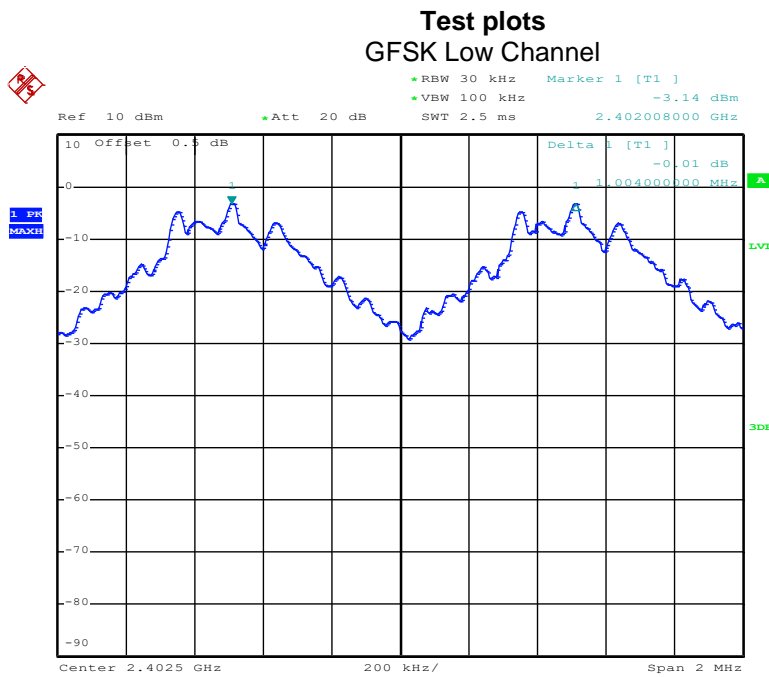

Date: 12.APR.2022 11:44:39

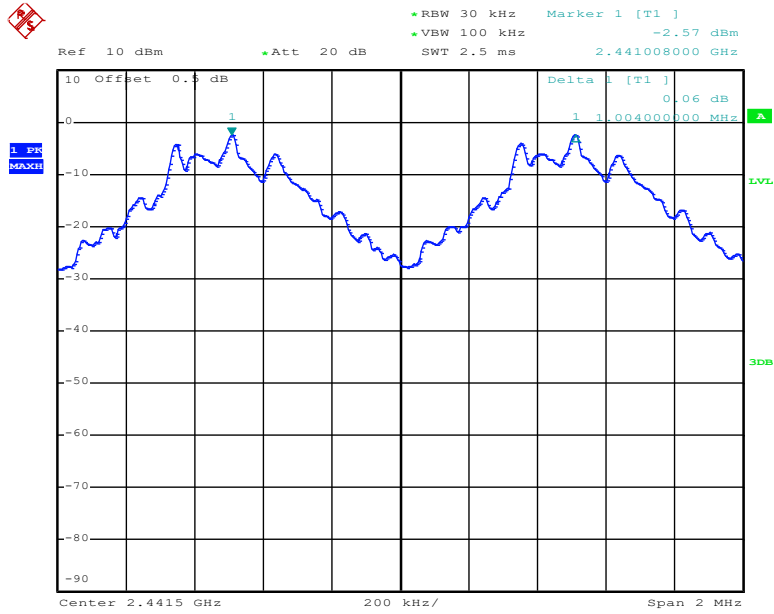
GFSK Middle Channel

Date: 12.APR.2022 11:46:02

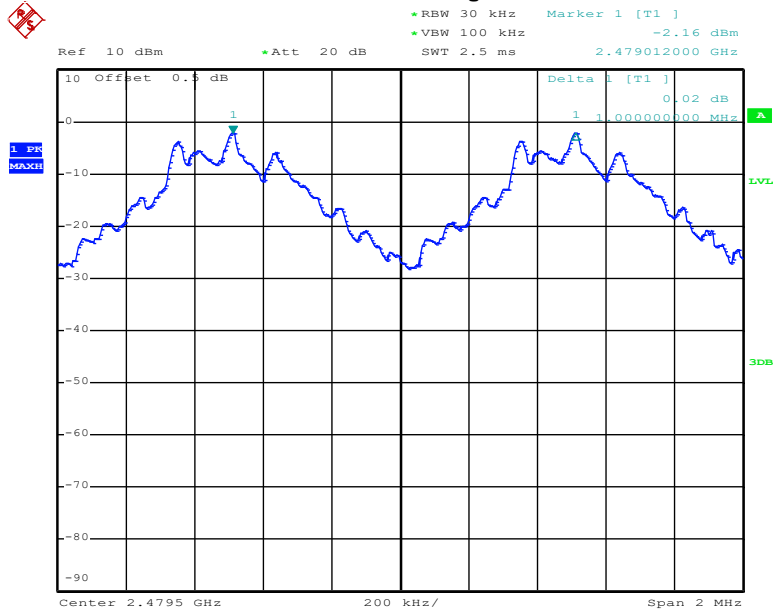
GFSK High Channel

Date: 12.APR.2022 11:48:37

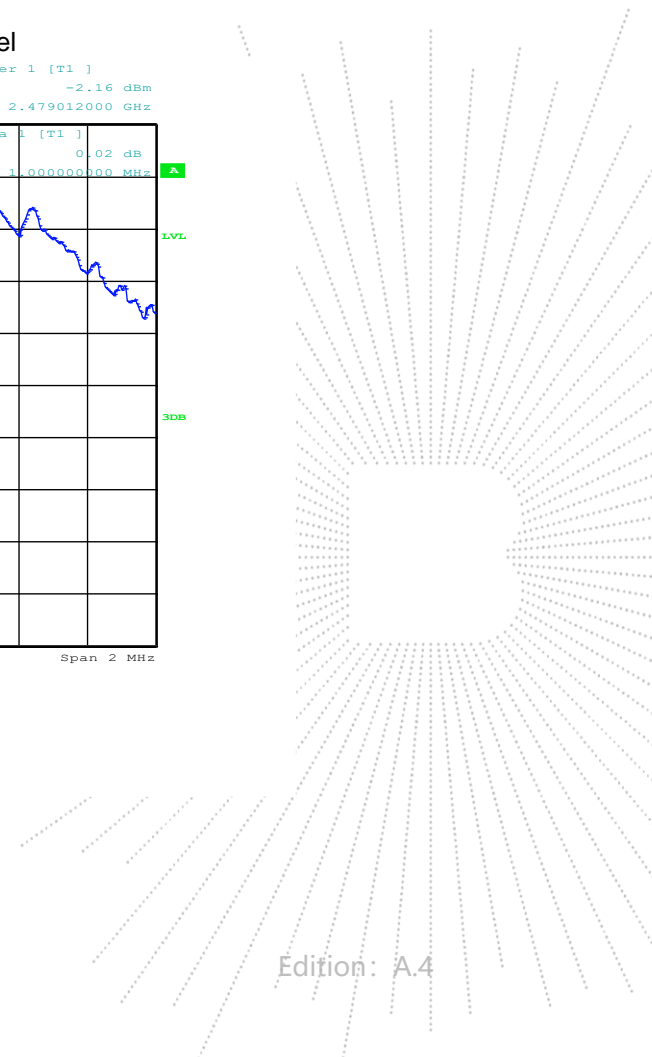

$\pi/4$ DQPSK Low Channel

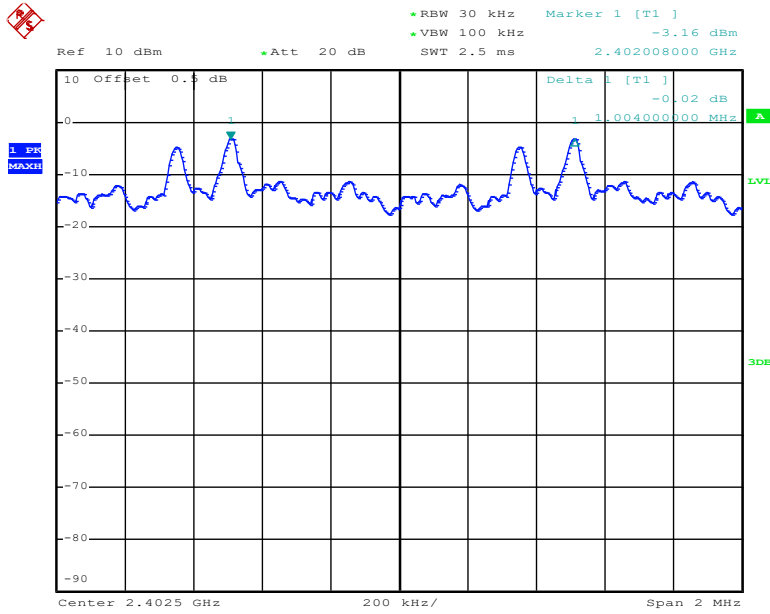

Date: 12.APR.2022 11:24:22

$\pi/4$ DQPSK Middle Channel

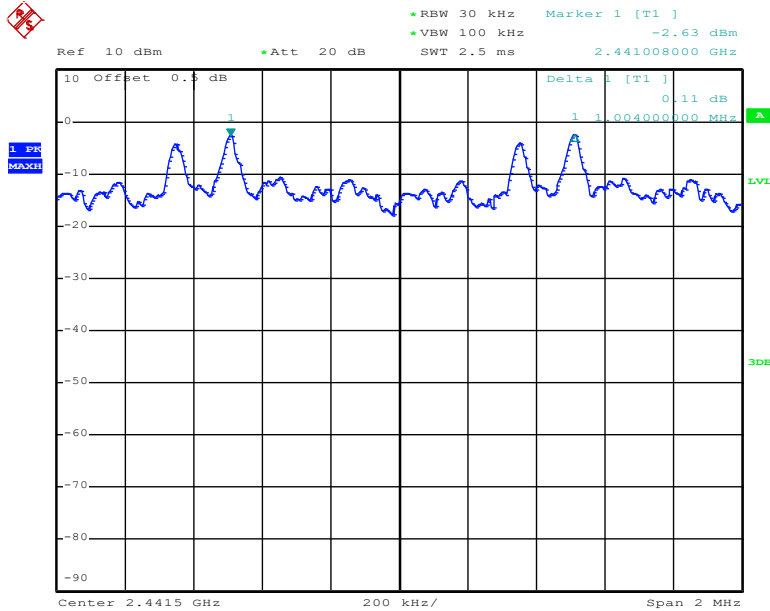

Date: 12.APR.2022 11:46:28

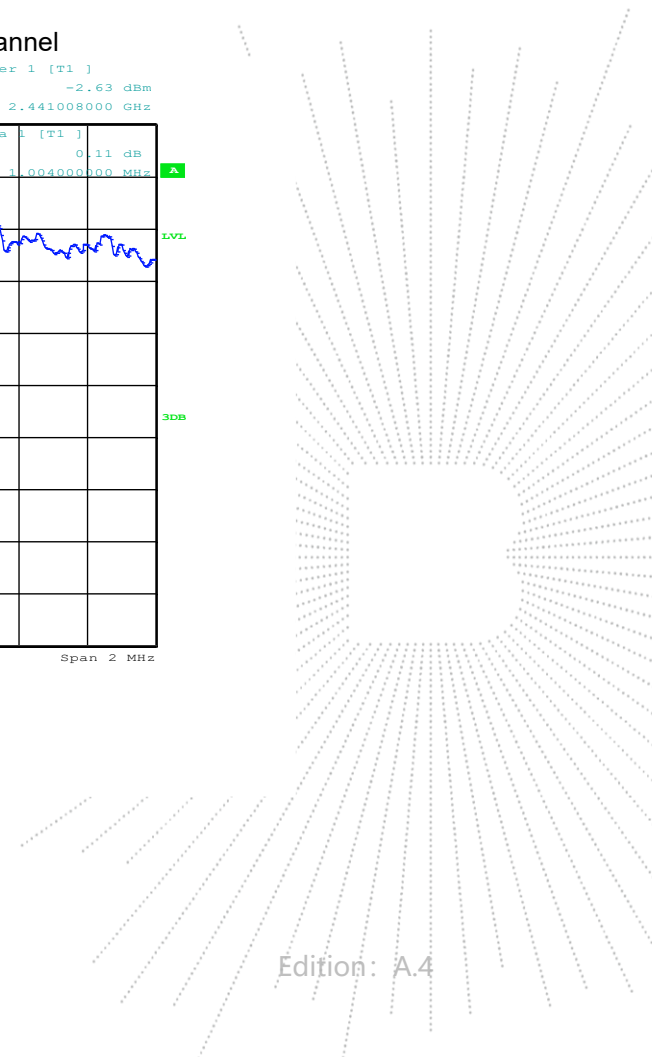

$\pi/4$ DQPSK High Channel

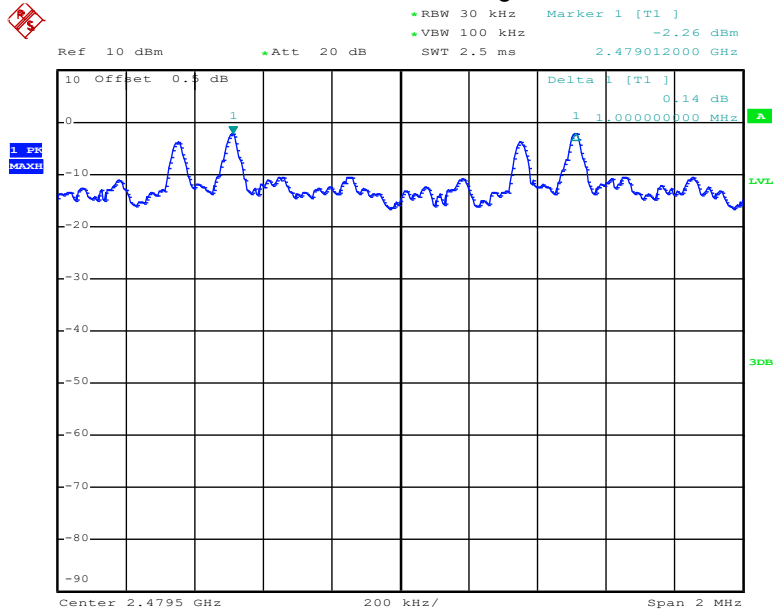

Date: 12.APR.2022 11:48:10

8DPSK Low Channel

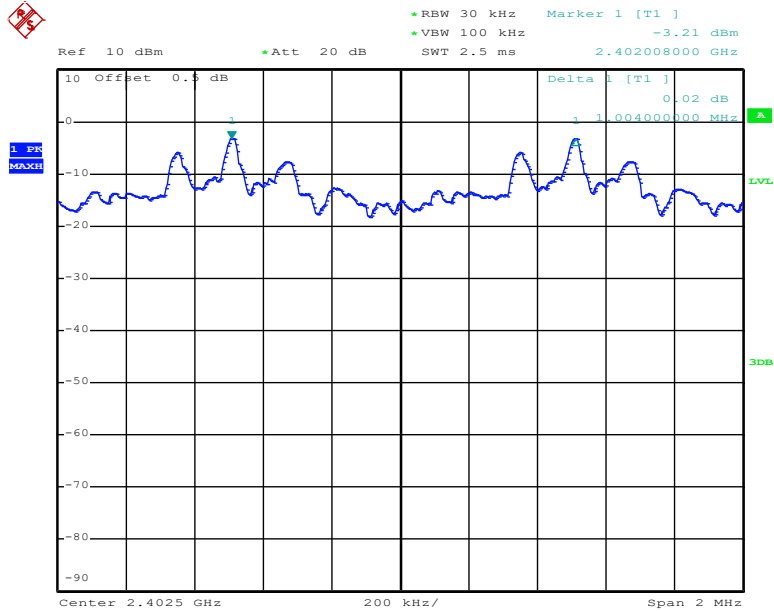

Date: 12.APR.2022 11:22:28

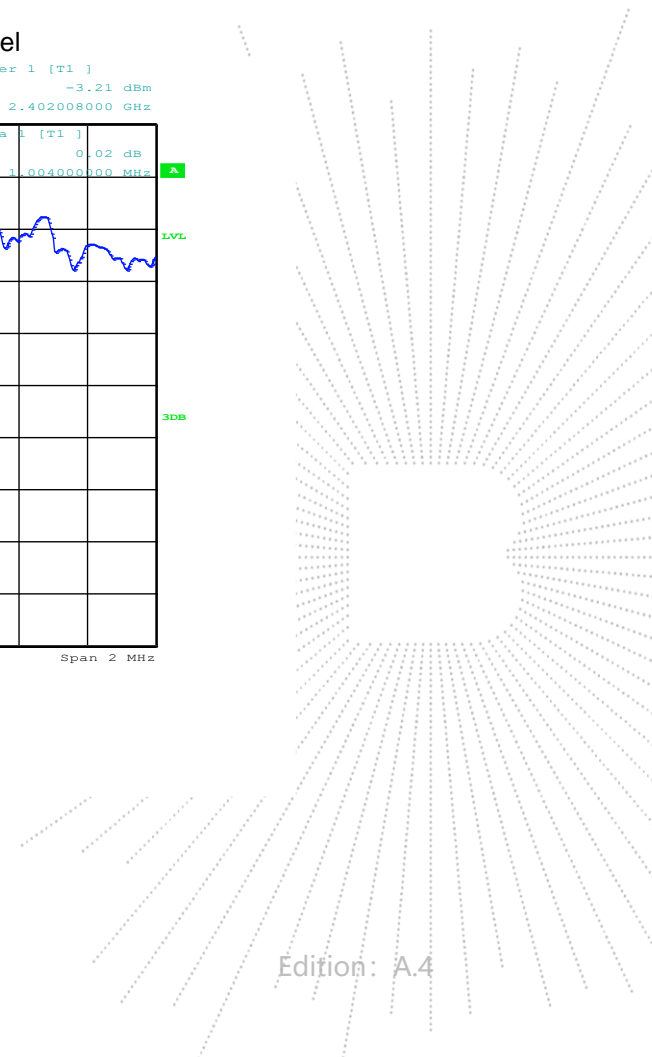

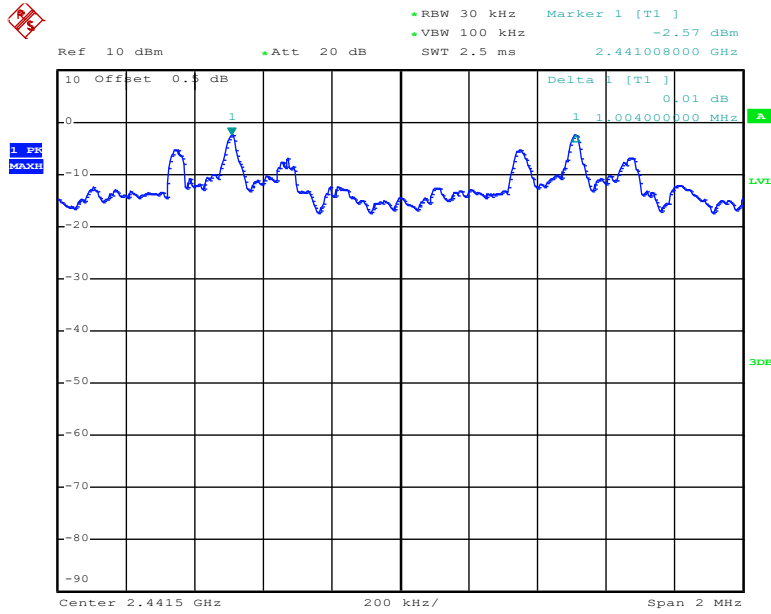
8DPSK Middle Channel

Date: 12.APR.2022 11:46:51

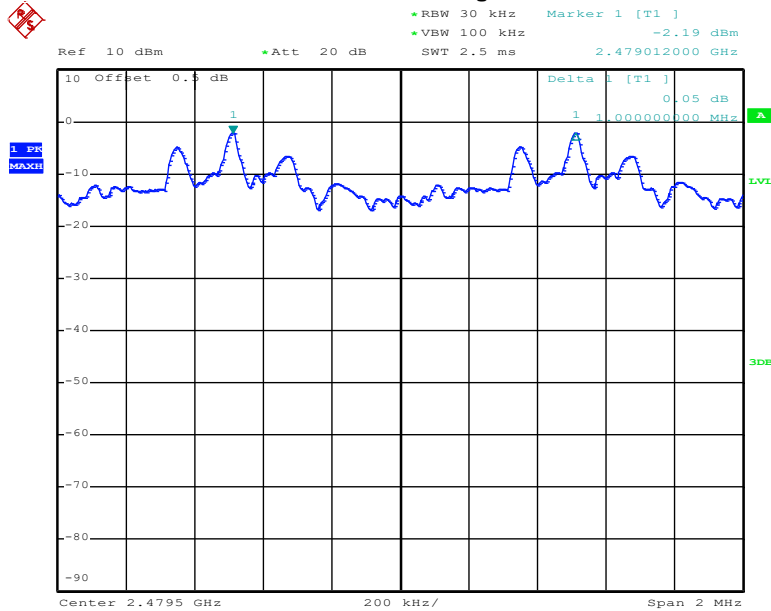
8DPSK High Channel

Date: 12.APR.2022 11:47:43

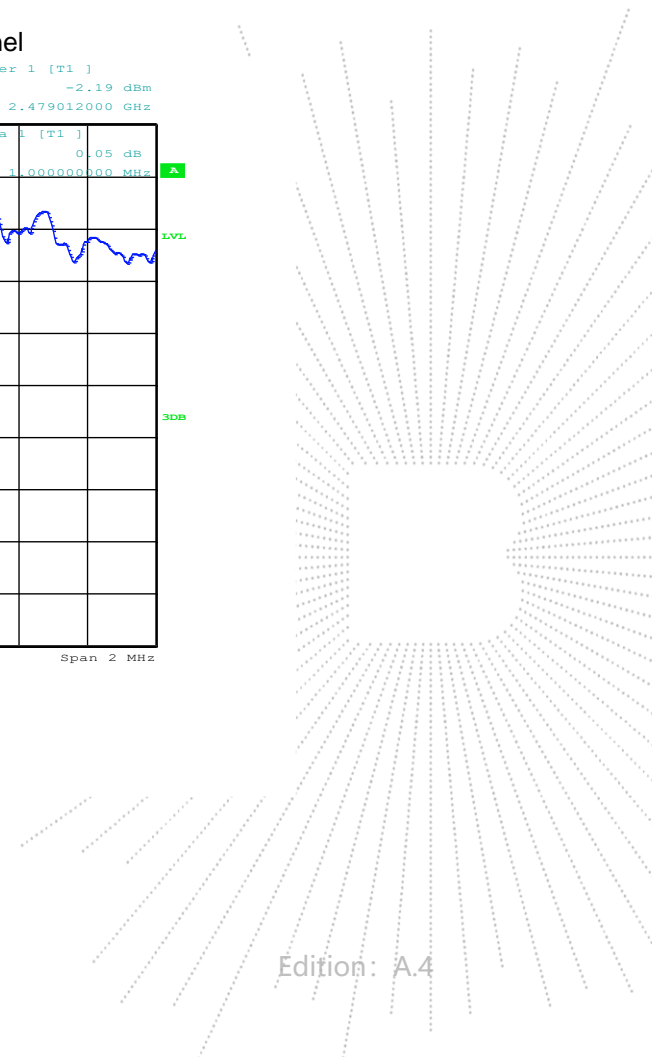

13. Number Of Hopping Frequency

13.1 Block Diagram Of Test Setup



13.2 Limit

Frequency hopping systems in the 2400-2483.5 MHz band shall use at least 15 channels.

13.3 Test Procedure

1. Remove the antenna from the EUT and then connect a low RF cable from the antenna port to the spectrum.
2. Set the spectrum analyzer: RBW = 100kHz. VBW = 300kHz. Sweep = auto; Detector Function = Peak. Trace = Max hold.
3. Allow the trace to stabilize. It may prove necessary to break the span up to sections. in order to clearly show all of the hopping frequencies. The limit is specified in one of the subparagraphs of this Section.
4. Set the spectrum analyzer: Start Frequency = 2.4GHz, Stop Frequency = 2.4835GHz. Sweep=auto;

13.4 Test Result

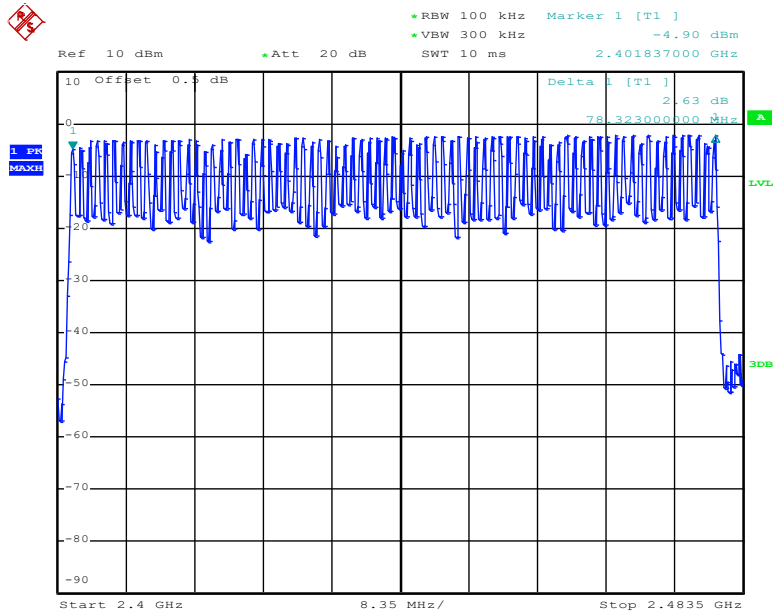
Test Plots:
 79 Channels in total
 GFSK

Date: 12.APR.2022 11:10:47

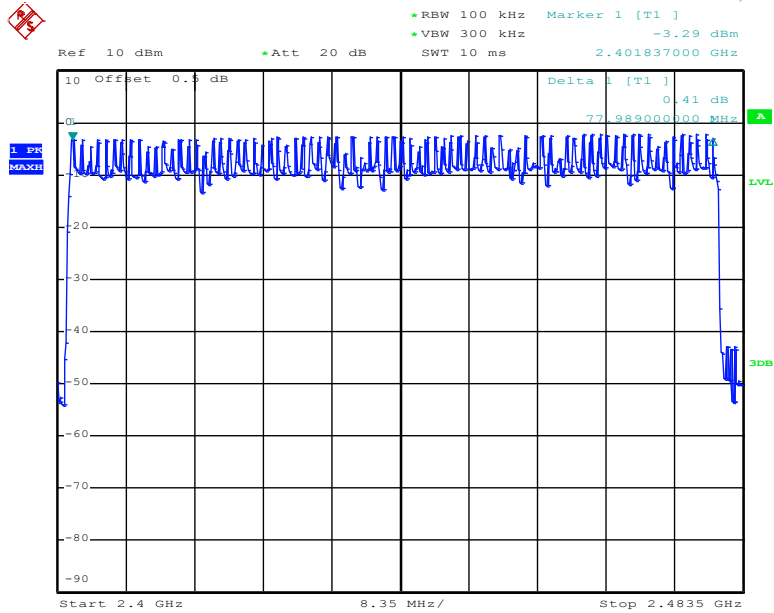
 $\pi/4$ DQPSK

Date: 12.APR.2022 11:13:40

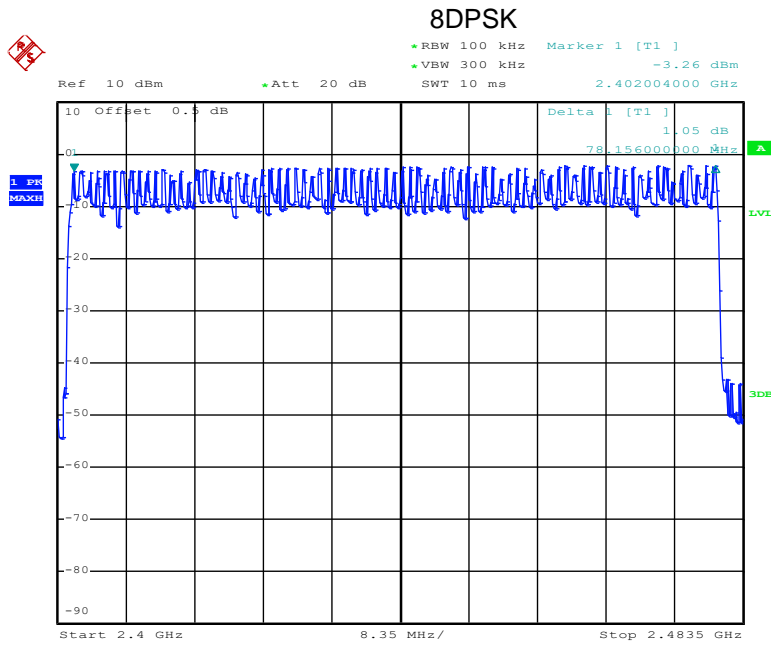

Date: 12.APR.2022 11:16:45

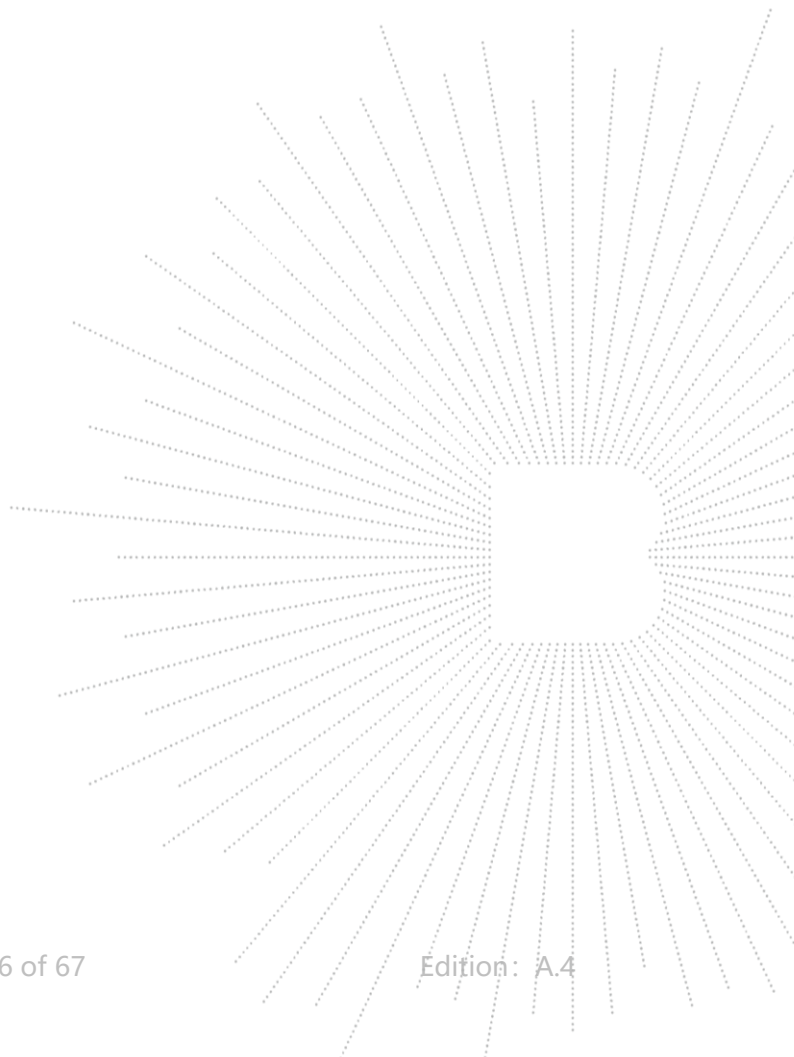

14. Dwell Time

14.1 Block Diagram Of Test Setup



14.2 Limit

Frequency hopping systems in the 2400-2483.5 MHz band shall use at least 15 channels. The average time of occupancy on any channel shall not be greater than 0.4 seconds within a period of 0.4 seconds multiplied by the number of hopping channels employed. Frequency hopping systems may avoid or suppress transmissions on a particular hopping frequency provided that a minimum of 15 channels are used.

14.3 Test Procedure

1. Remove the antenna from the EUT and then connect a low RF cable from the antenna port to the spectrum.
2. Set spectrum analyzer span = 0. Centred on a hopping channel;
3. Set RBW = 1MHz and VBW = 3MHz. Sweep = as necessary to capture the entire dwell time per hopping channel. Set the EUT for DH5, DH3 and DH1 packet transmitting.
4. Use the marker-delta function to determine the dwell time. If this value varies with different modes of operation (e.g.. data rate. modulation format. etc.). repeat this test for each variation. The limit is specified in one of the subparagraphs of this Section. Submit this plot(s).

14.4 Test Result

DH5 Packet permit maximum 1600 / 79 / 6 hops per second in each channel (5 time slots RX, 1 time slot TX).

DH3 Packet permit maximum 1600 / 79 / 4 hops per second in each channel (3 time slots RX, 1 time slot TX).

DH1 Packet permit maximum 1600 / 79 / 2 hops per second in each channel (1 time slot RX, 1 time slot TX). So, the Dwell Time can be calculated as follows:

DH5: $1600/79/6 \times 0.4 \times 79 \times (\text{MkrDelta})/1000$

DH3: $1600/79/4 \times 0.4 \times 79 \times (\text{MkrDelta})/1000$

DH1: $1600/79/2 \times 0.4 \times 79 \times (\text{MkrDelta})/1000$

Remark: Mkr Delta is once pulse time.

Modulation	Channel Data	Packet	pulse time(ms)	Dwell Time(s)	Limits(s)
GFSK	Middle	DH1	0.422	0.135	0.4
		DH3	1.686	0.270	0.4
		DH5	2.942	0.314	0.4
$\pi/4$ DQPSK	Middle	2DH1	0.432	0.138	0.4
		2DH3	1.681	0.269	0.4
		2DH5	2.936	0.313	0.4
8DPSK	Middle	3DH1	0.434	0.139	0.4
		3DH3	1.694	0.271	0.4
		3DH5	2.940	0.314	0.4

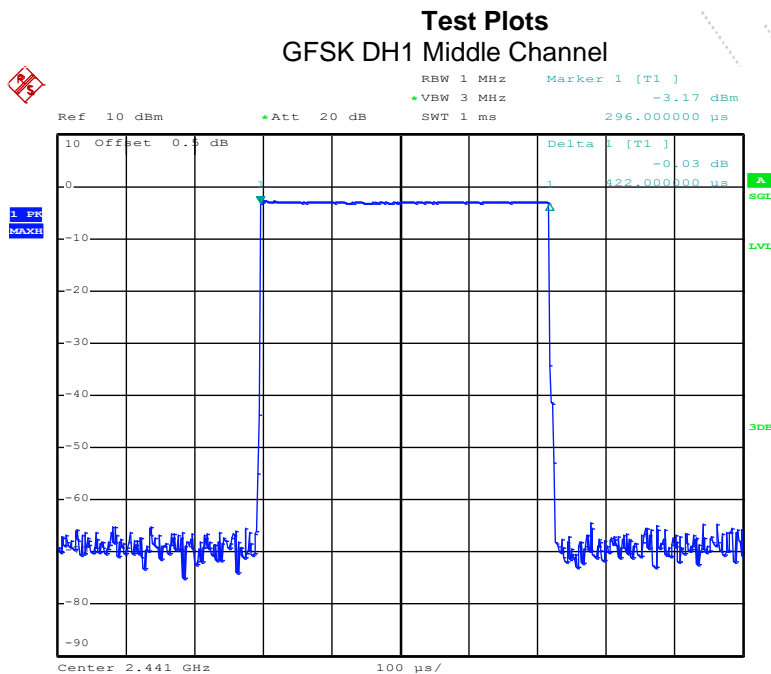

Date: 12.APR.2022 11:50:15

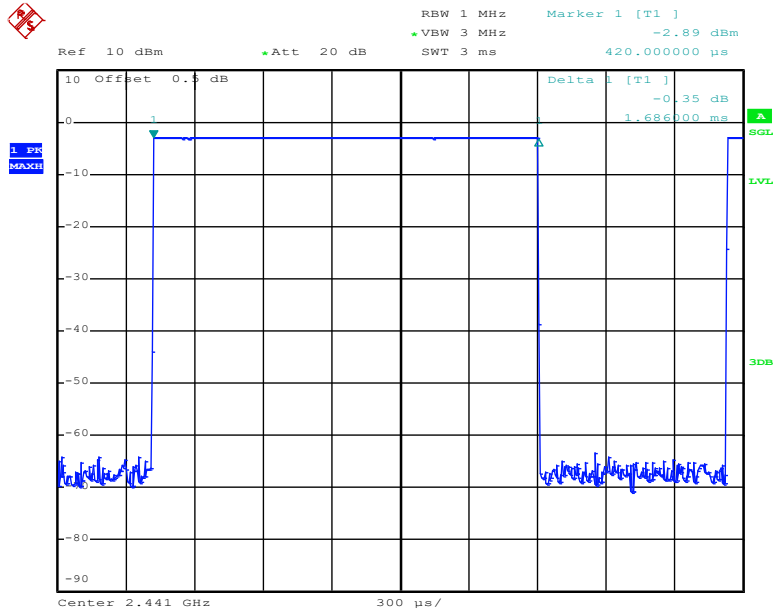
GFSK DH3 Middle Channel

Date: 12.APR.2022 11:50:55

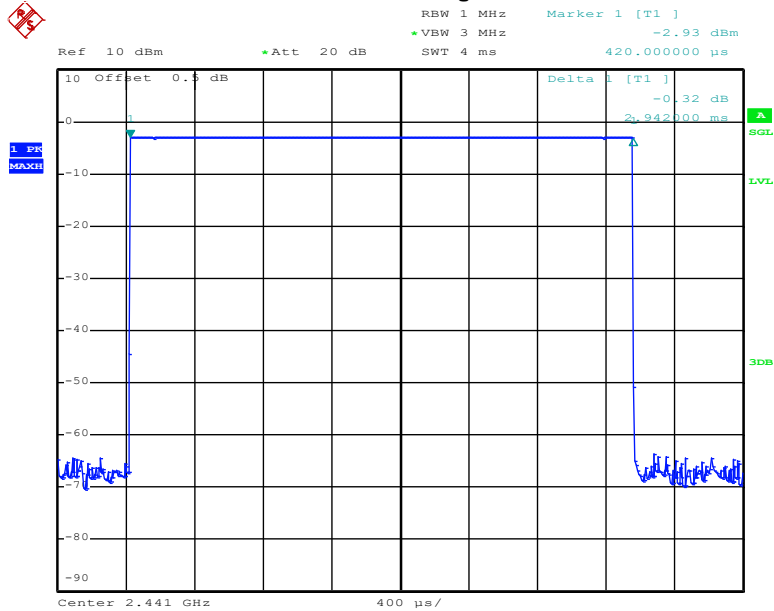
GFSK DH5 High Middle Channel

Date: 12.APR.2022 11:51:28

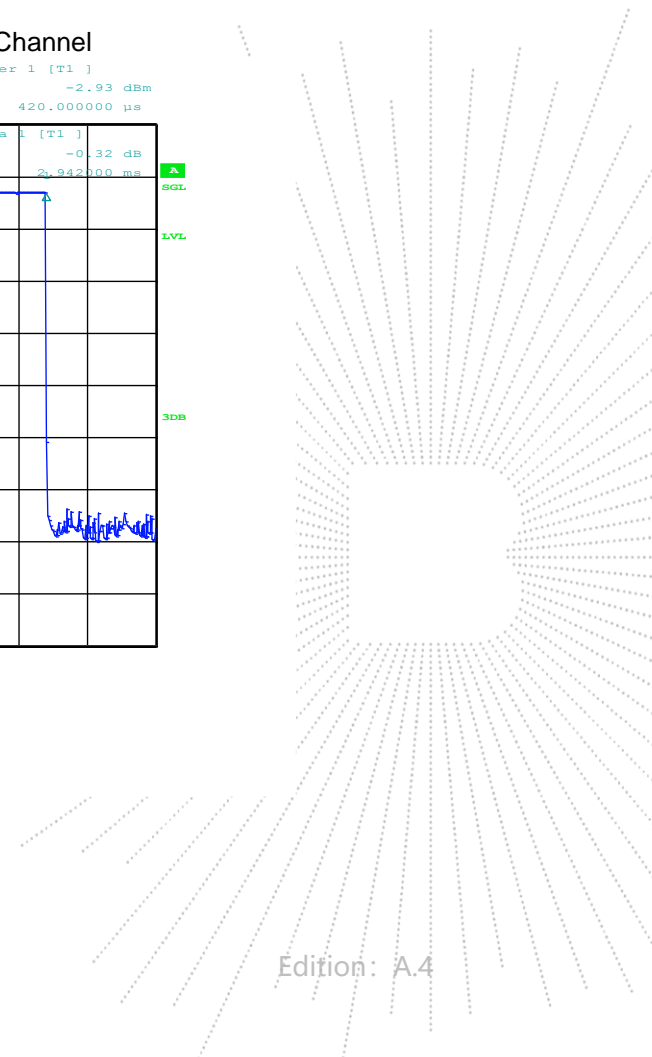

$\pi/4$ DQPSK DH1 Middle Channel

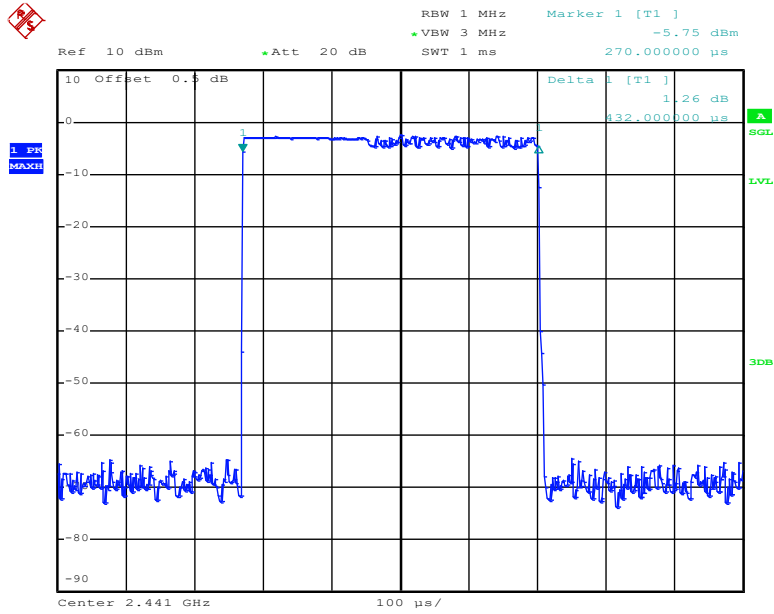

Date: 12.APR.2022 11:55:06

$\pi/4$ DQPSK DH3 Middle Channel

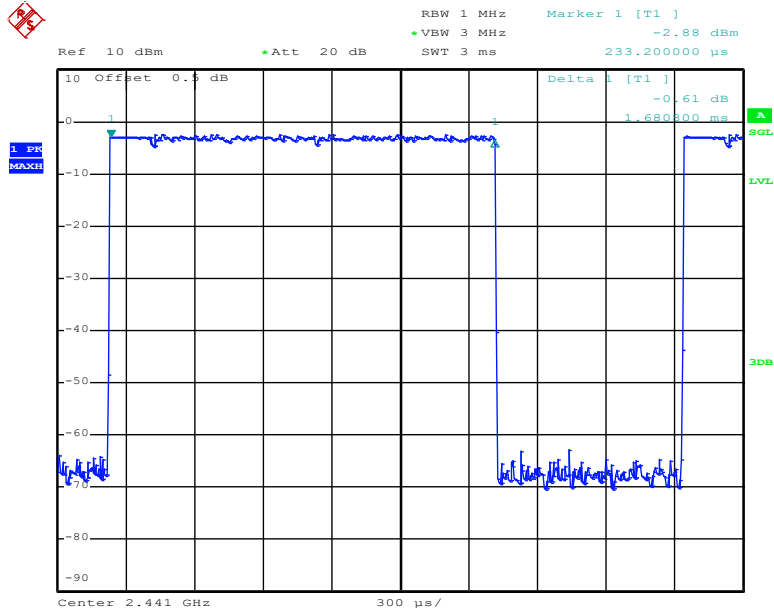

Date: 12.APR.2022 11:54:22

$\pi/4$ DQPSK DH5 Middle Channel

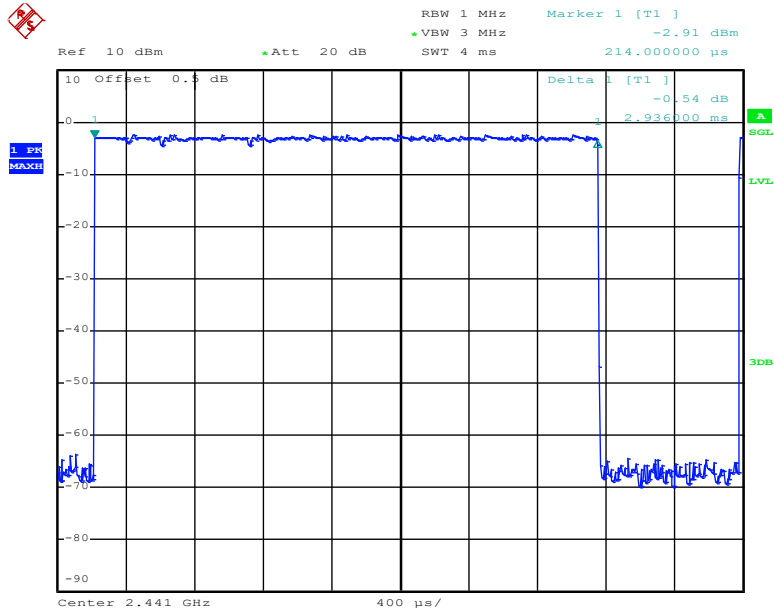

Date: 12.APR.2022 11:55:50

8DPSK DH1 Middle Channel

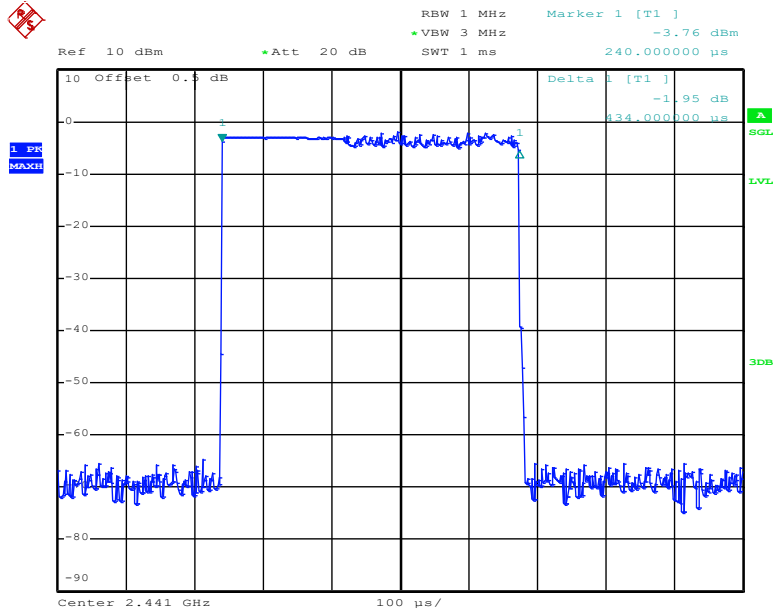

Date: 12.APR.2022 11:56:34

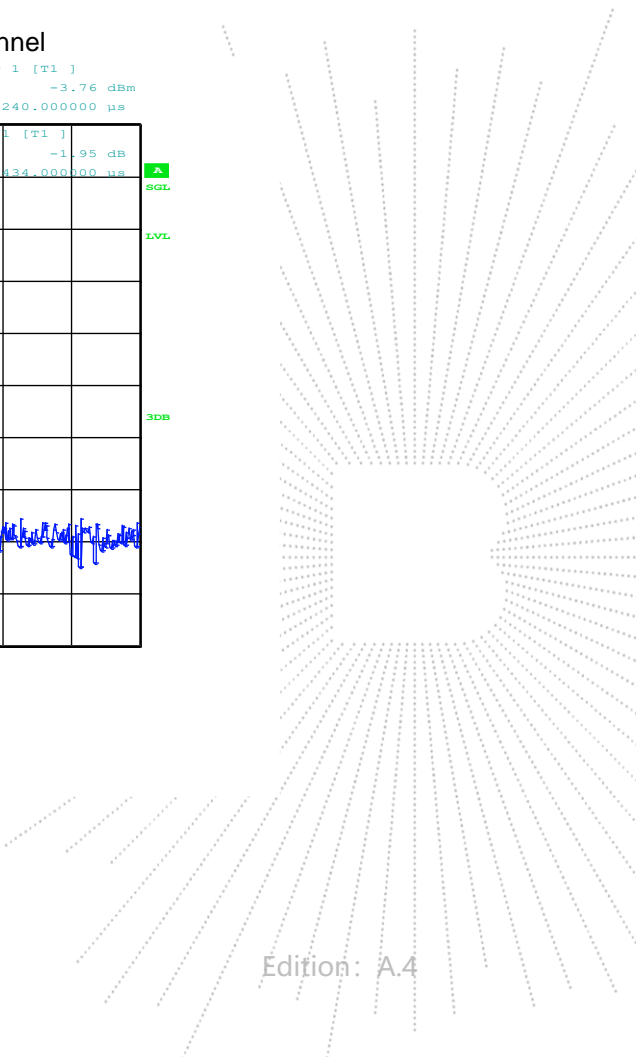

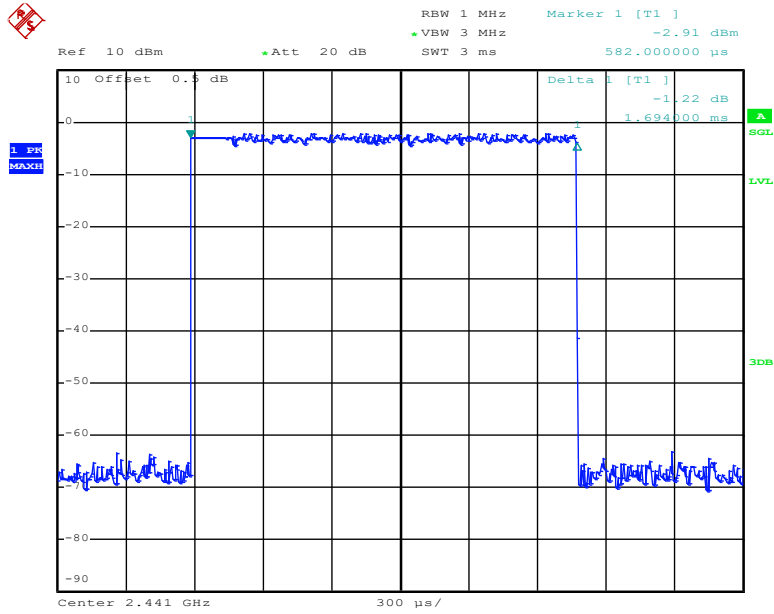
8DPSK DH3 Middle Channel

Date: 12.APR.2022 11:57:11

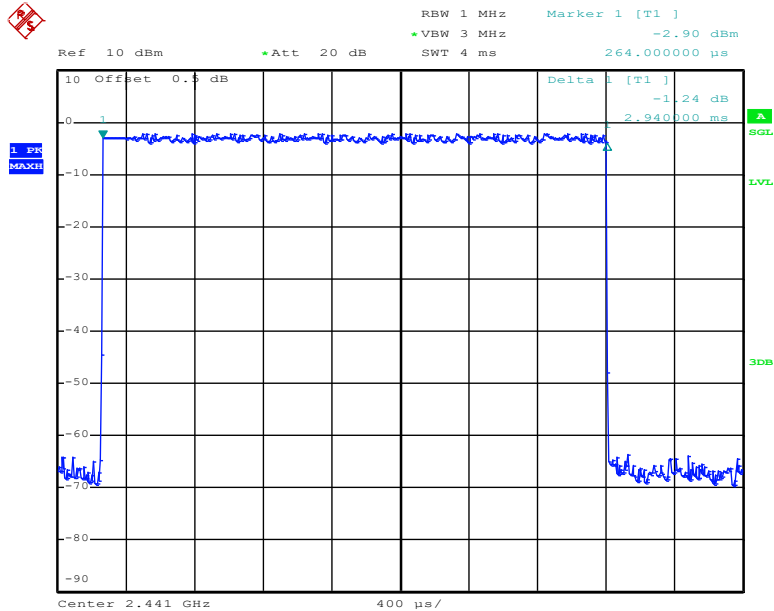
8DPSK DH5 Middle Channel

Date: 12.APR.2022 11:58:13

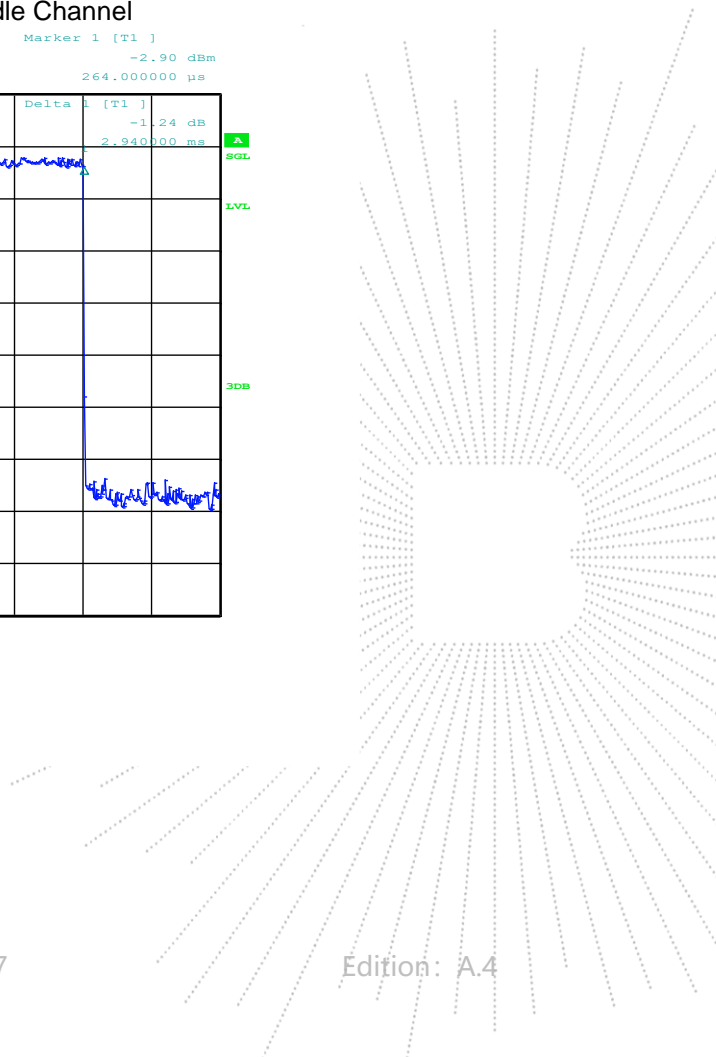

15. Antenna Requirement

15.1 Limit

15.203 requirement: For intentional device, according to 15.203: an intentional radiator shall be designed to ensure that no antenna other than that furnished by the responsible party shall be used with the device.

15.2 Test Result

The EUT antenna is PCB antenna, fulfill the requirement of this section.

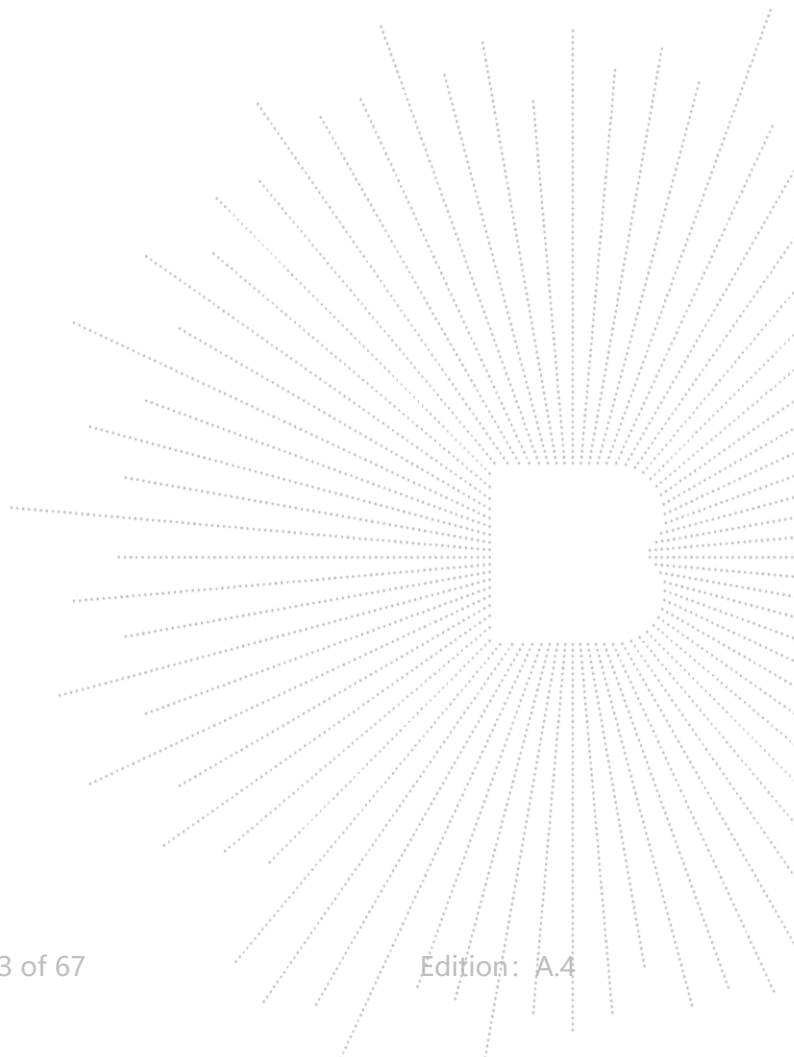

16. EUT Photographs

EUT Photo 1



EUT Photo 2



17. EUT Test Setup Photographs

Conducted Measurement Photo

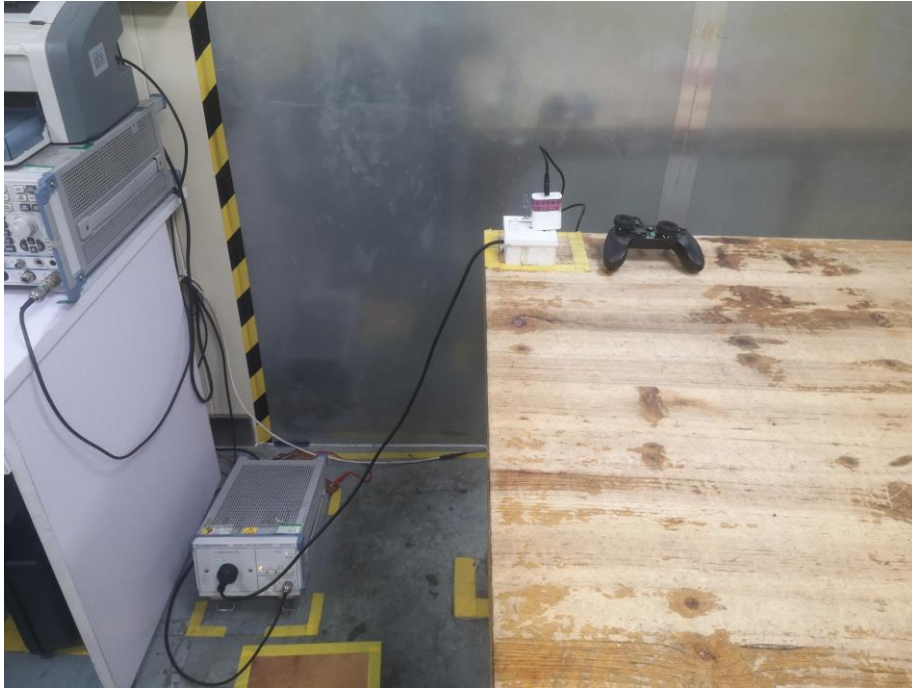

Radiated Measurement Photos

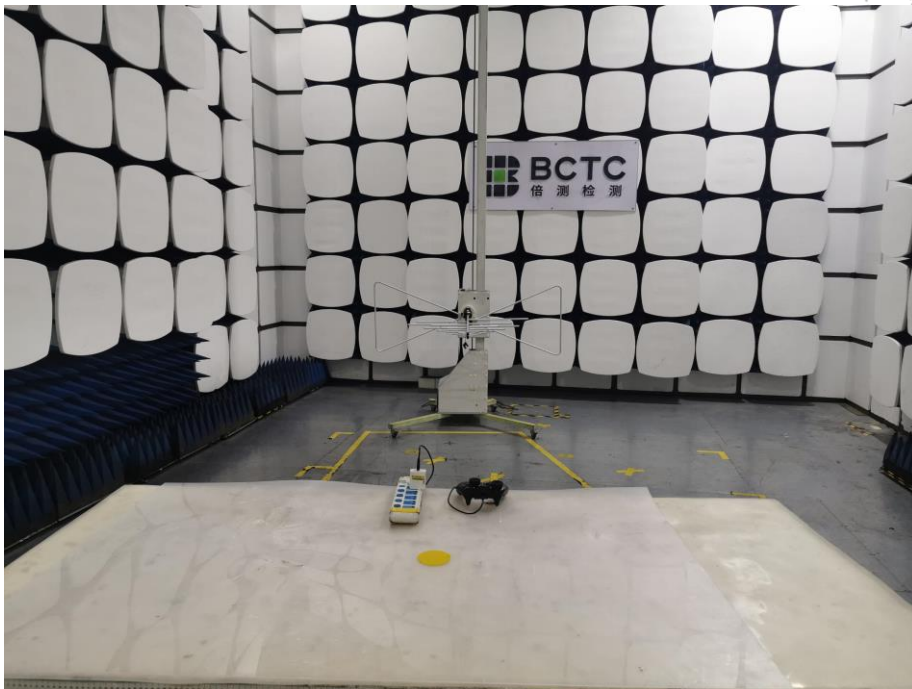

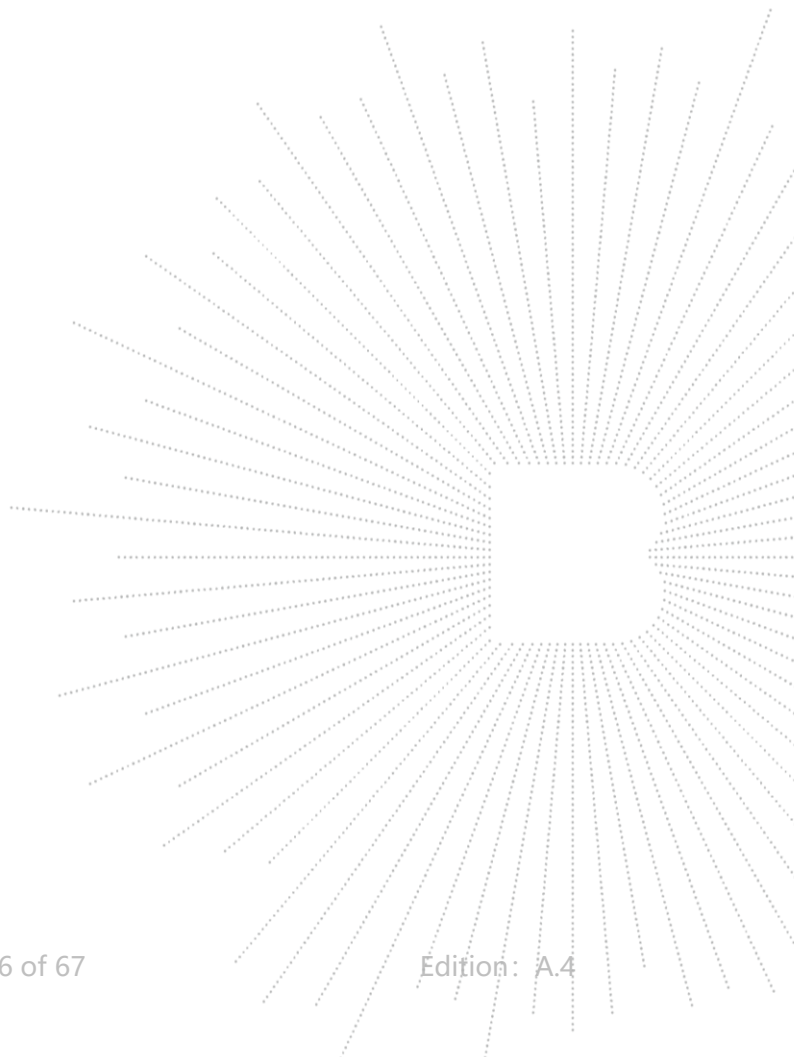

STATEMENT

- 1.The equipment lists are traceable to the national reference standards.
- 2.The test report can not be partially copied unless prior written approval is issued from our lab.
- 3.The test report is invalid without stamp of laboratory.
- 4.The test report is invalid without signature of person(s) testing and authorizing.
- 5.The test process and test result is only related to the Unit Under Test.
- 6.The quality system of our laboratory is in accordance with ISO/IEC17025.
- 7.If there is any objection to report, the client should inform issuing laboratory within 15 days from the date of receiving test report.

Address:

1-2/F., Building B, Pengzhou Industrial Park, No.158, Fuyuan 1st Road, Tangwei, Fuhai Subdistrict, Bao'an District, Shenzhen, Guangdong, China

TEL: 400-788-9558

P.C.: 518103

FAX: 0755-33229357

Website: <http://www.chnbctc.com>

E-Mail: bctc@bctc-lab.com.cn

***** END *****

