

FCC TEST REPORT
for
ShenZhen YuYuanXin Electronic Technology Co., LTD.

Bluetooth Keyboard
Model No.: TP4-008

Prepared for : ShenZhen YuYuanXin Electronic Technology Co., LTD.
Address : Building 11, Tianluohu Industry Park, Guihua Industry Area,
Guanguang Road, Guanlan Town, Longhua District, Shenzhen,
Guangdong, 518110 China

Prepared By : Shenzhen Anbotek Compliance Laboratory Limited
Address : 1/F., Building 1, SEC Industrial Park, No.0409 Qianhai Road,
Nanshan District, Shenzhen, Guangdong, China
Tel: (86) 755-26066544
Fax: (86) 755-26014772

Report Number : R011608181I
Date of Test : Aug. 08~19, 2016
Date of Report : Aug. 22, 2016

TABLE OF CONTENTS

Description	Page
Test Report	
1. GENERAL INFORMATION.....	5
1.1 Description of Device (EUT).....	5
1.2 Auxiliary Equipment Used during Test.....	6
1.3 Description of Test Facility.....	6
1.4 Measurement Uncertainty.....	6
2. TEST PROCEDURE.....	7
3. CONDUCTED EMISSION.....	8
3.1 Block Diagram of Test Setup.....	8
3.2 Power Line Conducted Emission Measurement Limits (15.207).....	8
3.3 Configuration of EUT on Measurement.....	8
3.4 Operating Condition of EUT.....	8
3.5 Test Procedure.....	9
3.6 Power Line Conducted Emission Measurement Results.....	9
4. RADIATION INTERFERENCE.....	14
4.1 Requirements (15.247, 15.209):.....	14
4.2 Test Procedure.....	14
4.3 Test Configuration.....	15
4.4 Test Results.....	16
5. CHANNEL SEPARATION TEST.....	25
5.1 Measurement Procedure.....	25
5.2 Test SET-UP.....	25
5.3 Test Equipment.....	25
5.4 Test Results.....	26
6. 20DB BANDWIDTH TEST.....	28
6.1 Measurement Procedure.....	28
6.2 Test SET-UP.....	28
6.3 Test Equipment.....	28
6.4 Test Results.....	28
7. QUANTITY OF HOPPING CHANNEL TEST.....	30
7.1 Measurement Procedure.....	30
7.2 Test SET-UP.....	30
7.3 Test Equipment.....	30
7.4 Test Results.....	30
8. DWELL TIME TEST.....	32
8.1 Measurement Procedure.....	32

8.2 Test SET-UP..... 32
8.3 Test Equipment..... 32
8.4 Test Results..... 32
9. MAXIMUM PEAK OUTPUT POWER TEST..... 34
9.1 Measurement Procedure..... 34
9.2 Test SET-UP..... 34
9.3 Test Equipment..... 34
9.4 Test Results..... 35
10. BAND EDGE TEST..... 37
10.1 Measurement Procedure..... 37
10.2 Test SET-UP..... 37
10.3 Test Equipment..... 38
10.4 Test Results..... 38
11. ANTENNA APPLICATION..... 42
11.1 Antenna requirement..... 42
11.2 Result..... 42
12. PHOTOGRAPH..... 43
12.1 Photo of Power Line Conducted Emission Measurement..... 43
12.2 Photo of Radiation Emission Test..... 43
APPENDIX I (EXTERNAL PHOTOS)..... 45
APPENDIX II (INTERNAL PHOTOS)..... 49

TEST REPORT

Applicant : ShenZhen YuYuanXin Electronic Technology Co., LTD.
Manufacturer : ShenZhen YuYuanXin Electronic Technology Co., LTD.
EUT : Bluetooth Keyboard
Model No. : TP4-008
Serial No. : N.A.
Trade Mark : N.A.
Rating : DC 3.7V, 200mAh

Measurement Procedure Used:

FCC Part15 Subpart C 2015, Paragraph 15.207, 15.247 & 15.209

The device described above is tested by Shenzhen Anbotek Compliance Laboratory Limited to determine the maximum emission levels emanating from the device and the severe levels of the device can endure and its performance criterion. The measurement results are contained in this test report and Shenzhen Anbotek Compliance Laboratory Limited is assumed full of responsibility for the accuracy and completeness of these measurements. Also, this report shows that the EUT (Equipment Under Test) is technically compliant with the FCC Part 15 Subpart C requirements.

This report applies to above tested sample only and shall not be reproduced in part without written approval of Shenzhen Anbotek Compliance Laboratory Limited.

Date of Test : Aug. 08~19, 2016

Prepared by : *Baron Wen*
(Tested Engineer / Baron Wen)

Reviewer : *Dolly mo*
(Project Manager / Dolly Mo)

Approved & Authorized Signer : *Tom Chen*
(Manager / Tom Chen)

1. GENERAL INFORMATION

1.1 Description of Device (EUT)

EUT	: Bluetooth Keyboard
Model Number	: TP4-008
Test Power Supply	: AC 120V, 60Hz for adapter/ AC 240V, 60Hz for adapter/ DC 3.7V Battery inside
Frequency	: 2402~2480MHz
Antenna Specification	: PCB Antenna: 0.944dBi
Modulation	: GFSK, $\pi/4$ DQPSK, 8DPSK
Applicant Address	: ShenZhen YuYuanXin Electronic Technology Co., LTD. : Building 11, Tianluohu Industry Park, Guihua Industry Area, Guanguang Road, Guanlan Town, Longhua District, Shenzhen, Guangdong, 518110 China
Manufacturer Address	: ShenZhen YuYuanXin Electronic Technology Co., LTD. : Building 11, Tianluohu Industry Park, Guihua Industry Area, Guanguang Road, Guanlan Town, Longhua District, Shenzhen, Guangdong, 518110 China
Factory Address	: ShenZhen YuYuanXin Electronic Technology Co., LTD. : Building 11, Tianluohu Industry Park, Guihua Industry Area, Guanguang Road, Guanlan Town, Longhua District, Shenzhen, Guangdong, 518110 China
Date of receipt	: Aug. 08, 2016
Date of Test	: Aug. 08~19, 2016

1.2 Auxiliary Equipment Used during Test

Adapter : Manufacturer: ZTE
M/N: STC-A2050I1000USBA-C
S/N: 201202102100876
Input: 100-240V~50/60Hz 0.3A
Output: DC 5V, 1000mA

1.3 Description of Test Facility

The test facility is recognized, certified, or accredited by the following organizations:

FCC-Registration No.: 752021

Shenzhen Anbotek Compliance Laboratory Limited, EMC Laboratory has been registered and fully described in a report filed with the (FCC) Federal Communications Commission. The acceptance letter from the FCC is maintained in our files. Registration 752021, July 06, 2016.

IC-Registration No.: 8058A-1

Shenzhen Anbotek Compliance Laboratory Limited., EMC Laboratory has been registered and fully described in a report filed with the (IC) Industry Canada. The acceptance letter from the IC is maintained in our files. Registration 8058A, June 13, 2016.

Test Location

All Emissions tests were performed at
Shenzhen Anbotek Compliance Laboratory Limited. at 1/F., Building 1, SEC
Industrial Park, No.0409 Qianhai Road, Nanshan District, Shenzhen, Guangdong,
China

1.4 Measurement Uncertainty

Radiation Uncertainty : Ur = 4.1 dB (Horizontal)
Ur = 4.3 dB (Vertical)
Conduction Uncertainty : Uc = 3.4dB

2. Test Procedure

GENERAL: This report shall NOT be reproduced except in full without the written approval of Shenzhen Anbotek Compliance Laboratory Limited. The EUT was transmitting a test signal during the testing.

RADIATION INTERFERENCE: The test procedure used was ANSI STANDARD C63.10-2013 using a spectrum analyzer with a pre-selector. The analyzer was calibrated in dB above a microvolt at the output of the antenna. The resolution bandwidth was 100KHz and the video bandwidth was 300KHz up to 1.0GHz and 1.0MHz with a video BW of 3.0MHz above 1.0GHz. The ambient temperature of the EUT was 74.3oF with a humidity of 69%.

FORMULA OF CONVERSION FACTORS: The Field Strength at 3m was established by adding the meter reading of the spectrum analyzer (which is set to read in units of dBuV) to the antenna correction factor supplied by the antenna manufacturer. The antenna correction factors are stated in terms of dB. The gain of the Preselector was accounted for in the Spectrum Analyzer Meter Reading.

Example:

Freq (MHz) METER READING + ACF = FS
20 dBuV + 10.36 dB = 30.36 dBuV/m @ 3m

ANSI STANDARD C63.10-2013 10.1.7 MEASUREMENT PROCEDURES: The EUT was placed on a table 80 cm high and with dimensions of 1m by 1.5m. The EUT was placed in the center of the table (1.5m side). The table used for radiated measurements is capable of continuous rotation.

When an emission was found, the table was rotated to produce the maximum signal strength. At this point, the antenna was raised and lowered from 1m to 4m. The antenna was placed in both the horizontal and vertical planes.

3. Conducted Emission

3.1 Block Diagram of Test Setup

3.1.1. Block diagram of connection between the EUT and simulators

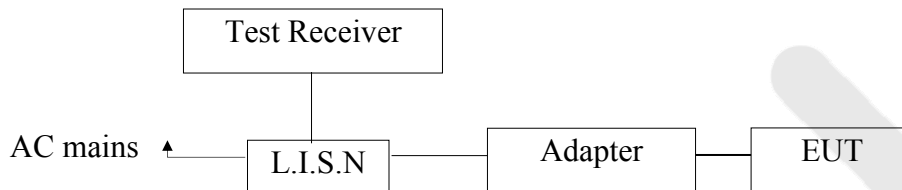

3.2 Power Line Conducted Emission Measurement Limits (15.207)

Frequency MHz	Limits dB(μV)	
	Quasi-peak Level	Average Level
0.15 ~ 0.50	66 ~ 56*	56 ~ 46*
0.50 ~ 5.00	56	46
5.00 ~ 30.00	60	50

- Notes: 1. *Decreasing linearly with logarithm of frequency.
2. The lower limit shall apply at the transition frequencies.

3.3 Configuration of EUT on Measurement

The following equipments are installed on Power Line Conducted Emission Measurement to meet the commission requirement and operating regulations in a manner which tends to maximize its emission characteristics in a normal application.

3.4 Operating Condition of EUT

- 3.4.1. Setup the EUT and simulator as shown as Section 3.1.
- 3.4.2. Turn on the power of all equipment.
- 3.4.3. Let the EUT work in test mode (Charging, BT Mode) and measure it.

3.5 Test Procedure

The EUT system is connected to the power mains through a line impedance stabilization network (L.I.S.N.). This provides a 50ohm coupling impedance for the EUT system. Please refer the block diagram of the test setup and photographs. Both sides of AC line are checked to find out the maximum conducted emission. In order to find the maximum emission levels, the relative positions of equipment and all of the interface cables shall be changed according to FCC ANSI C63.10-2013 on Conducted Emission Measurement.

The bandwidth of test receiver (ESCI) set at 9KHz.

The frequency range from 150KHz to 30MHz is checked.

The test results are reported on Section 3.6.

Test Equipment

Item	Equipment	Manufacturer	Model No.	Serial No.	Last Cal.	Cal. Interval
1.	Two-Line V-network	Rohde & Schwarz	ENV216	100055	Apr. 16, 2016	1 Year
2.	EMI Test Receiver	Rohde & Schwarz	ESCI	100627	Apr. 16, 2016	1 Year
3.	RF Switching Unit	Compliance Direction	RSU-M2	38303	Apr. 16, 2016	1 Year

3.6 Power Line Conducted Emission Measurement Results

PASS.

The frequency range from 150KHz to 30 MHz is investigated.

The EUT was tested on (Charging, BT Mode) modes, only the worst data of (Charging) is attached in the following pages.

CONDUCTED EMISSION TEST DATA

Test Site: 1# Shielded Room
 Operating Condition: Charging
 Test Specification: AC 120V, 60Hz for adapter
 Comment: Live Line
 Tem.:25°C Hum.:50%

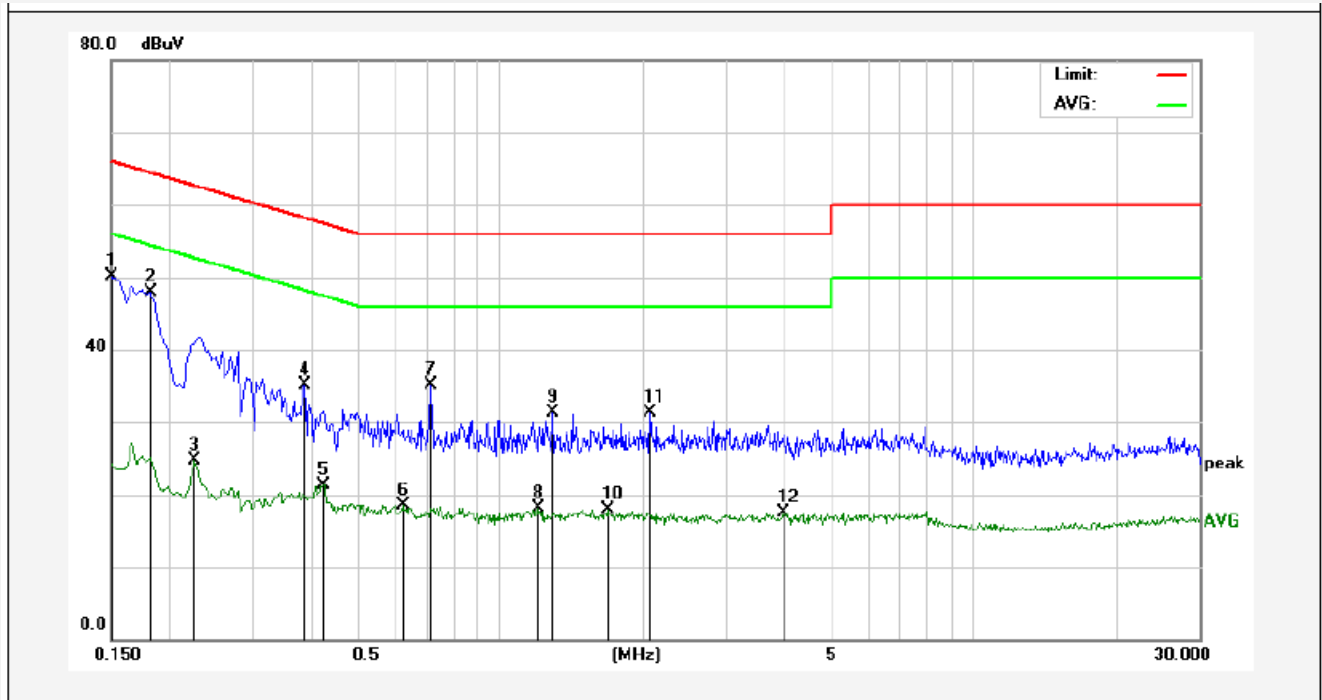

No.	Freq. (MHz)	Reading (dBuV)	Factor (dB)	Result (dBuV)	Limit dBuV	Over Limit (dB)	Detector	Remark
1	0.1500	30.04	20.00	50.04	65.99	-15.95	QP	
2	0.1819	27.87	20.00	47.87	64.39	-16.52	QP	
3	0.2260	4.73	20.00	24.73	52.59	-27.86	AVG	
4	0.3860	15.18	20.00	35.18	58.15	-22.97	QP	
5	0.4220	1.38	20.00	21.38	47.41	-26.03	AVG	
6	0.6220	-1.52	20.00	18.48	46.00	-27.52	AVG	
7	0.7140	15.18	20.00	35.18	56.00	-20.82	QP	
8	1.2059	-1.95	20.00	18.05	46.00	-27.95	AVG	
9	1.2940	11.32	20.00	31.32	56.00	-24.68	QP	
10	1.6860	-2.02	20.00	17.98	46.00	-28.02	AVG	
11	2.0700	11.36	20.00	31.36	56.00	-24.64	QP	
12	3.9700	-2.42	20.00	17.58	46.00	-28.42	AVG	

CONDUCTED EMISSION TEST DATA

Test Site: 1# Shielded Room
 Operating Condition: Charging
 Test Specification: AC 120V, 60Hz for adapter
 Comment: Neutral Line
 Tem.:25°C Hum.:50%

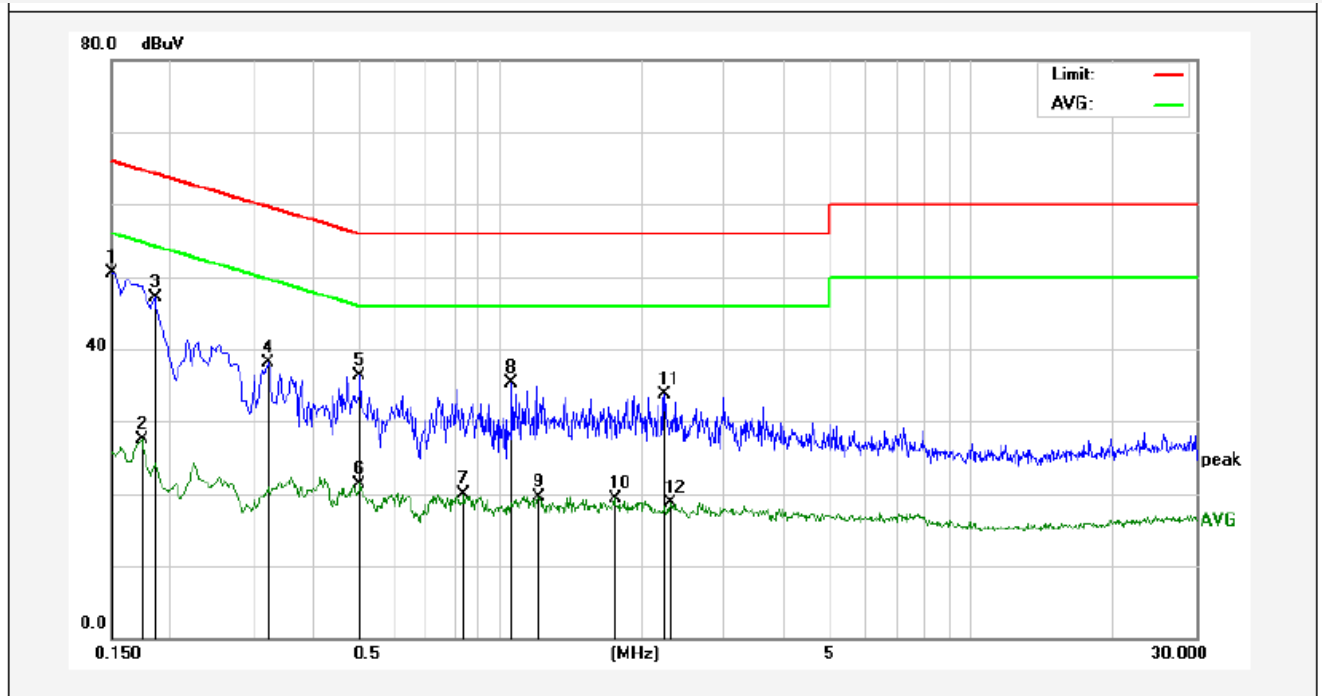

No.	Freq. (MHz)	Reading (dBuV)	Factor (dB)	Result (dBuV)	Limit dBuV	Over Limit (dB)	Detector	Remark
1	0.1500	30.59	20.00	50.59	65.99	-15.40	QP	
2	0.1740	7.44	20.00	27.44	54.76	-27.32	AVG	
3	0.1860	27.08	20.00	47.08	64.21	-17.13	QP	
4	0.3220	18.12	20.00	38.12	59.65	-21.53	QP	
5	0.5060	16.27	20.00	36.27	56.00	-19.73	QP	
6	0.5060	1.40	20.00	21.40	46.00	-24.60	AVG	
7	0.8420	-0.14	20.00	19.86	46.00	-26.14	AVG	
8	1.0620	15.37	20.00	35.37	56.00	-20.63	QP	
9	1.2100	-0.56	20.00	19.44	46.00	-26.56	AVG	
10	1.7580	-0.77	20.00	19.23	46.00	-26.77	AVG	
11	2.2380	13.69	20.00	33.69	56.00	-22.31	QP	
12	2.2980	-1.31	20.00	18.69	46.00	-27.31	AVG	

CONDUCTED EMISSION TEST DATA

Test Site: 1# Shielded Room
 Operating Condition: Charging
 Test Specification: AC 240V, 60Hz for adapter
 Comment: Live Line
 Tem.:25°C Hum.:50%

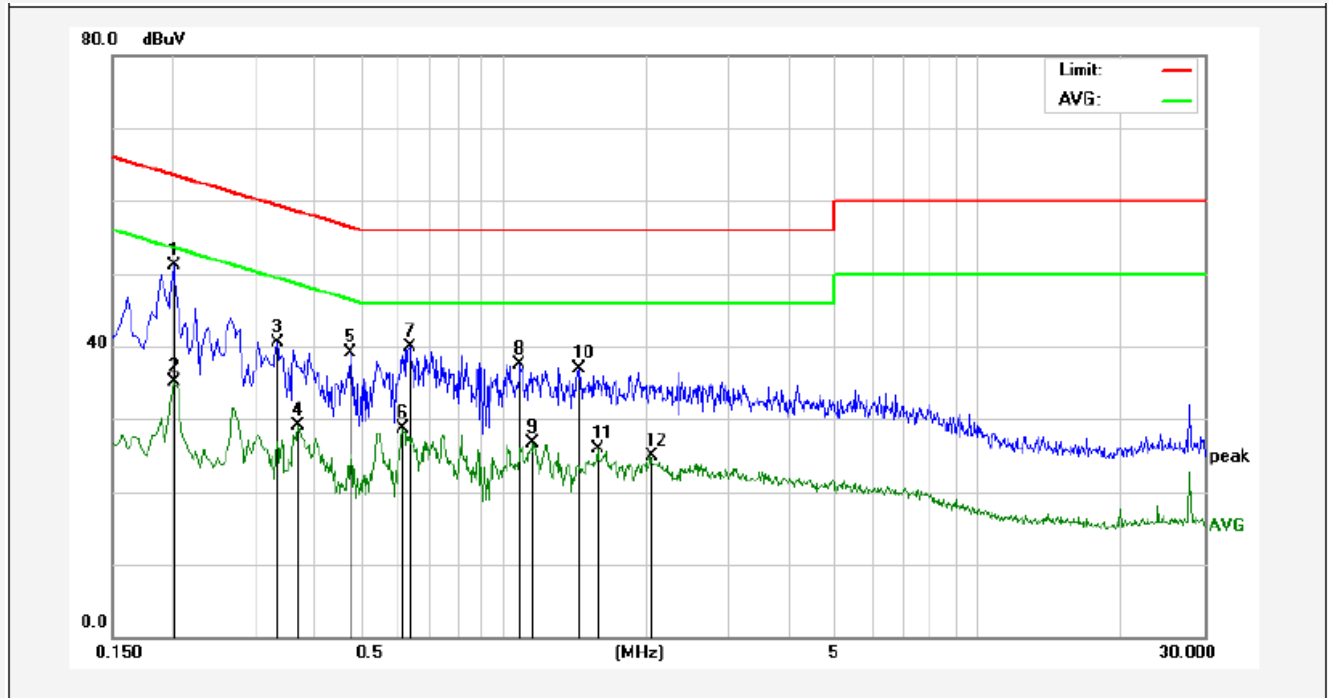

No.	Freq. (MHz)	Reading (dBuV)	Factor (dB)	Result (dBuV)	Limit dBuV	Over Limit (dB)	Detector	Remark
1	0.2020	31.10	20.00	51.10	63.52	-12.42	QP	
2	0.2020	15.10	20.00	35.10	53.52	-18.42	AVG	
3	0.3339	20.49	20.00	40.49	59.35	-18.86	QP	
4	0.3700	9.03	20.00	29.03	48.50	-19.47	AVG	
5	0.4780	19.01	20.00	39.01	56.37	-17.36	QP	
6	0.6140	8.75	20.00	28.75	46.00	-17.25	AVG	
7	0.6340	19.93	20.00	39.93	56.00	-16.07	QP	
8	1.0859	17.51	20.00	37.51	56.00	-18.49	QP	
9	1.1539	6.76	20.00	26.76	46.00	-19.24	AVG	
10	1.4460	16.93	20.00	36.93	56.00	-19.07	QP	
11	1.5780	5.84	20.00	25.84	46.00	-20.16	AVG	
12	2.0460	4.90	20.00	24.90	46.00	-21.10	AVG	

CONDUCTED EMISSION TEST DATA

Test Site: 1# Shielded Room
 Operating Condition: Charging
 Test Specification: AC 240V, 60Hz for adapter
 Comment: Neutral Line
 Tem.:25°C Hum.:50%

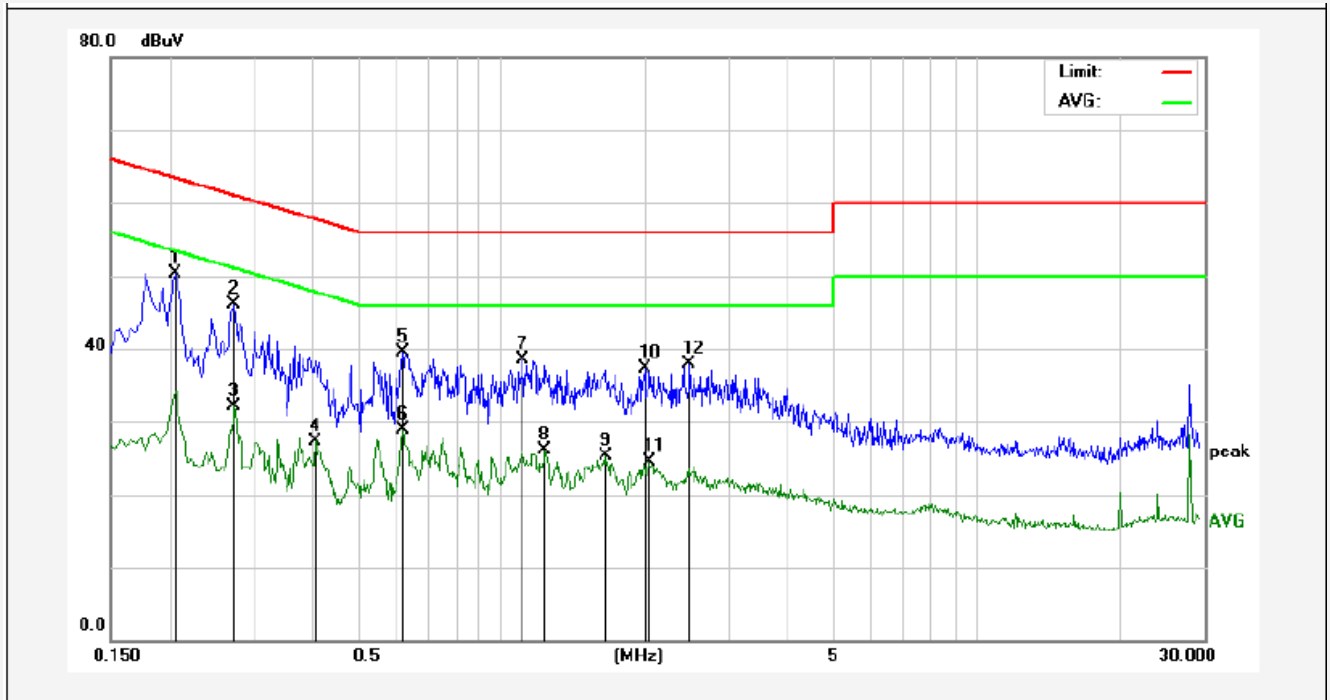

No.	Freq. (MHz)	Reading (dBuV)	Factor (dB)	Result (dBuV)	Limit dBuV	Over Limit (dB)	Detector	Remark
1	0.2060	30.21	20.00	50.21	63.36	-13.15	QP	
2	0.2740	26.11	20.00	46.11	60.99	-14.88	QP	
3	0.2740	12.05	20.00	32.05	50.99	-18.94	AVG	
4	0.4060	7.35	20.00	27.35	47.73	-20.38	AVG	
5	0.6180	19.41	20.00	39.41	56.00	-16.59	QP	
6	0.6180	8.86	20.00	28.86	46.00	-17.14	AVG	
7	1.1100	18.47	20.00	38.47	56.00	-17.53	QP	
8	1.2340	6.12	20.00	26.12	46.00	-19.88	AVG	
9	1.6500	5.33	20.00	25.33	46.00	-20.67	AVG	
10	1.9940	17.37	20.00	37.37	56.00	-18.63	QP	
11	2.0420	4.44	20.00	24.44	46.00	-21.56	AVG	
12	2.4820	17.88	20.00	37.88	56.00	-18.12	QP	

4. Radiation Interference

4.1 Requirements (15.247, 15.209):

4.1.1. Test Limits (< 30 MHz)

Frequency (MHz)	Field Strength (microvolts/meter)	Measurement Distance (meter)
0.009-0.490	2400/F(kHz)	300
0.490-1.705	24000/F(kHz)	30
1.705-30.0	30	30

4.1.2. Test Limits (\geq 30 MHz)

FIELD STRENGTH of Fundamental: @3M	FIELD STRENGTH of Harmonics	S15.209	
902-928 MHz		30 - 88 MHz	40 dBuV/m
2.4-2.4835 GHz		88 - 216 MHz	43.5
94 dB μ V/m @3m	54 dB μ V/m @3m	216 - 960 MHz	46
		ABOVE 960 MHz	54dBuV/m

For range 9KHz~30MHz, The measured value is really too low to be recorded.

Emissions radiated outside of the specified frequency bands, except for harmonics, shall be attenuated by at least 50 dB below the level of the fundamental or to the general radiated emission limits in 15.209, whichever is the lesser attenuation.

4.2 Test Procedure

For below 1GHz: The EUT is placed on a turntable, which is 0.8m above the ground plane.
For above 1GHz: The EUT is placed on a turntable, which is 1.5m above the ground plane.
The turn table can rotate 360 degrees to determine the position of the maximum emission level.
The EUT is set 3 meters away from the receiving antenna which is mounted on a antenna tower.
The antenna can be moved up and down from 1 to 4 meters to find out the maximum emission level. Rotated the EUT through three orthogonal axes to determine the maximum emissions, both horizontal and vertical polarization of the antenna are set on test. The EUT is tested in 9*6*6 Chamber. The device is evaluated in xyz orientation.

For 30MHz to 1000MHz:

Set the spectrum analyzer as:
RBW = 100kHz, VBW =300kHz,
Detector= Quasi-Peak
Trace mode= Max hold.
Sweep- auto couple.

For Above 1GHz:

Set the spectrum analyzer as:
RBW = 1MHz, VBW =3MHz,
Detector= Peak
Trace mode= Max hold.
Sweep- auto couple.

Set the spectrum analyzer as:
RBW =1MHz, VBW =10Hz
Detector= Average
Trace mode= Max hold.
Sweep- auto couple.

Test Equipment

Item	Equipment	Manufacturer	Model No.	Serial No.	Last Cal.	Cal. Interval
1.	Spectrum Analysis	Agilent	E4407B	US39390582	Apr. 17, 2016	1 Year
2.	Preamplifier	Instruments corporation	EMC011830	980100	Apr. 17, 2016	1 Year
3.	EMI Test Receiver	Rohde & Schwarz	ESPI	101604	Apr. 17, 2016	1 Year
4.	Double Ridged Horn Antenna	Instruments corporation	GTH-0118	351600	Apr. 20, 2016	1 Year
5.	Bilog Broadband Antenna	Schwarzbeck	VULB9163	VULB 9163-289	Apr. 20, 2016	1 Year
6.	Pre-amplifier	SONOMA	310N	186860	Apr. 17, 2016	1 Year
7.	EMI Test Software EZ-EMC	SHURPLE	N/A	N/A	N/A	N/A
8	Power Sensor	DAER	RPR3006W	15I00041SN046	Jun 30, 2016	1 Year
9	MXA Spectrum Analysis	Agilent	N9020A	MY51170037	Jun 30, 2016	1 Year
10	MXG RF Vector Signal Generator	Agilent	N5182A	MY48180656	Jun 30, 2016	1 Year
11	Signal Generator	Agilent	E4421B	MY41000743	Jun 30, 2016	1 Year
12	DC Power supply	IV	IV-8080	YQSB0096	Jun 30, 2016	1 Year
13	TEMP&HUMI PROGRAMMABLE CHAMBER	Bell Group	BE-THK-150M8	SE-0137	Mar 16, 2016	1 Year

4.3 Test Configuration

4.3.1. 9k to 30MHz emissions:

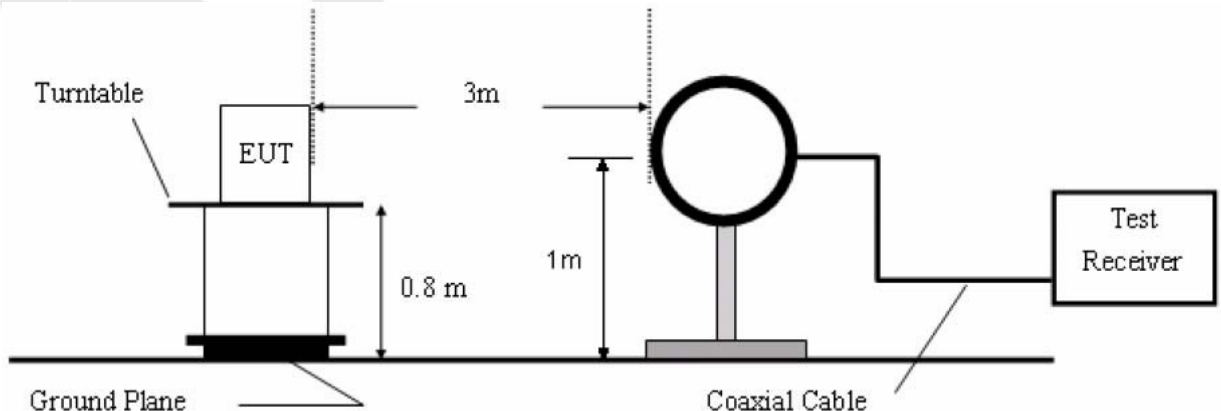

4.3.2. 30M to 1G emissions:

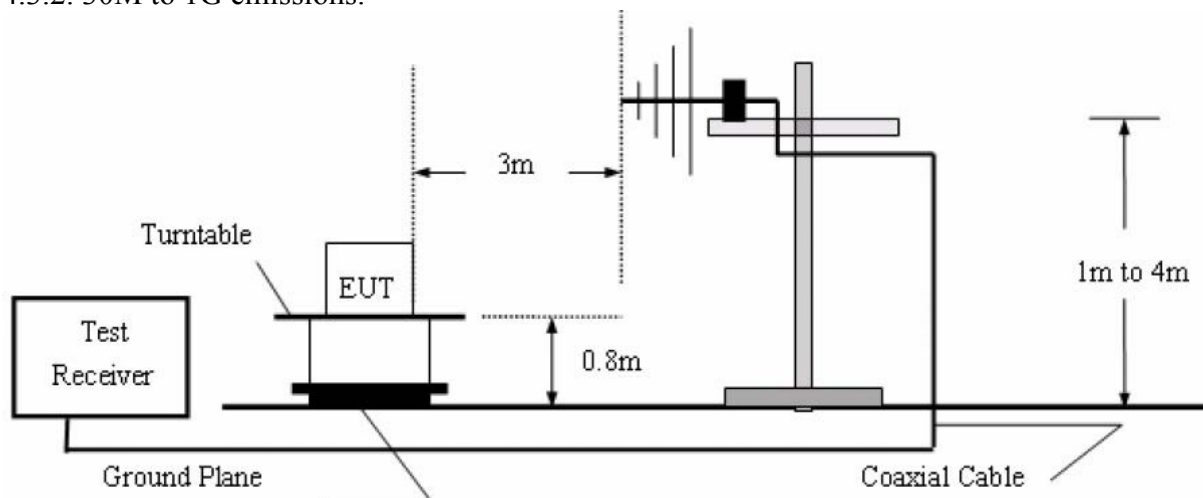

4.3.3. 1G to 40G emissions:

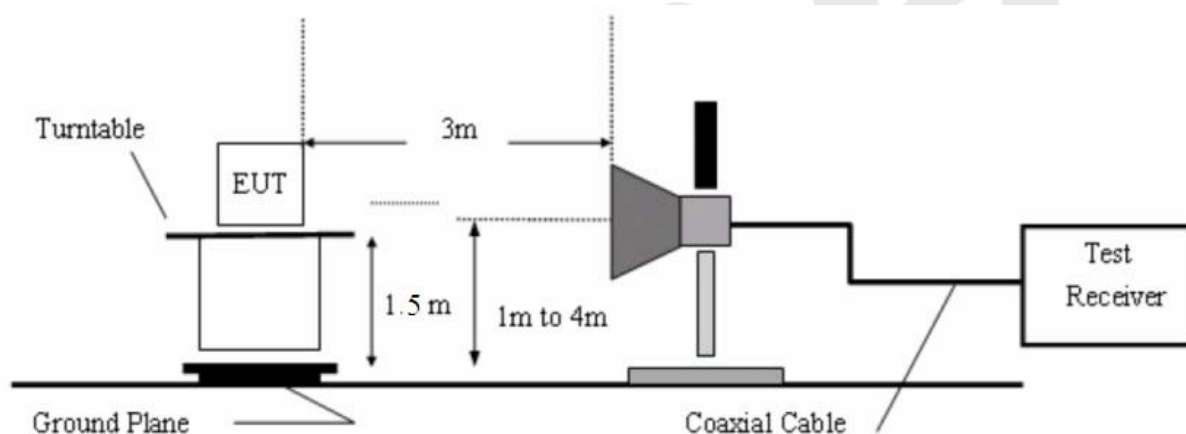

4.4 Test Results

PASS.

The EUT was tested on (Charging, BT Mode) modes, only the worst data of (Charging) is attached in the following pages.

Only the worst case (x orientation).

The EDR was tested on ($\pi/4$ DQPSK, 8DPSK) modes, only the worst data of ($\pi/4$ DQPSK) is attached in the following pages.

The test results of above 18000MHz are attenuated more than 20dB below the permissible limits, so the results don't record in the report.

Job No.:	0116081811	Polarization:	Horizontal
Standard:	(RE)FCC PART 15C _3m	Power Source:	AC 120V, 60Hz for adapter
Test item:	Radiation Test (30~1000MHz)	Temp.(C)/Hum.(%RH):	24.3(C)/55%RH
Test Mode:	Charging	Distance:	3m

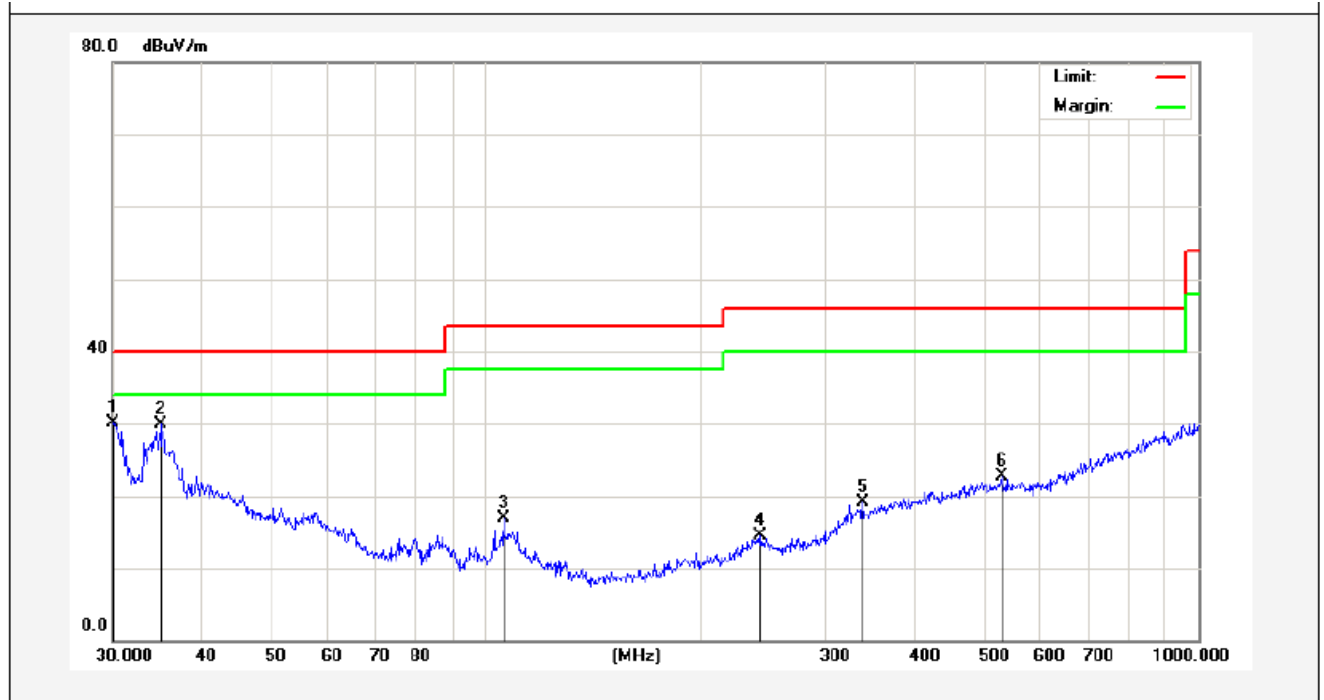

No.	Freq. (MHz)	Reading (dBuV/m)	Factor (dB/m)	Result (dBuV/m)	Limit (dBuV/)	Over Limit (dB)	Detector	Height (cm)	degree (deg)	Remark
1	30.1054	47.04	-16.89	30.15	40.00	-9.85	peak			
2	35.1278	44.06	-14.19	29.87	40.00	-10.13	peak			
3	106.0126	37.68	-20.69	16.99	43.50	-26.51	peak			
4	243.3772	32.68	-18.24	14.44	46.00	-31.56	peak			
5	338.4001	33.56	-14.37	19.19	46.00	-26.81	peak			
6	530.1014	33.76	-11.04	22.72	46.00	-23.28	peak			

Job No.:	0116081811	Polarization:	Vertical
Standard:	(RE)FCC PART 15C _3m	Power Source:	AC 120V, 60Hz for adapter
Test item:	Radiation Test (30~1000MHz)	Temp.(C)/Hum.(%RH):	24.3(C)/55%RH
Test Mode:	Charging	Distance:	3m

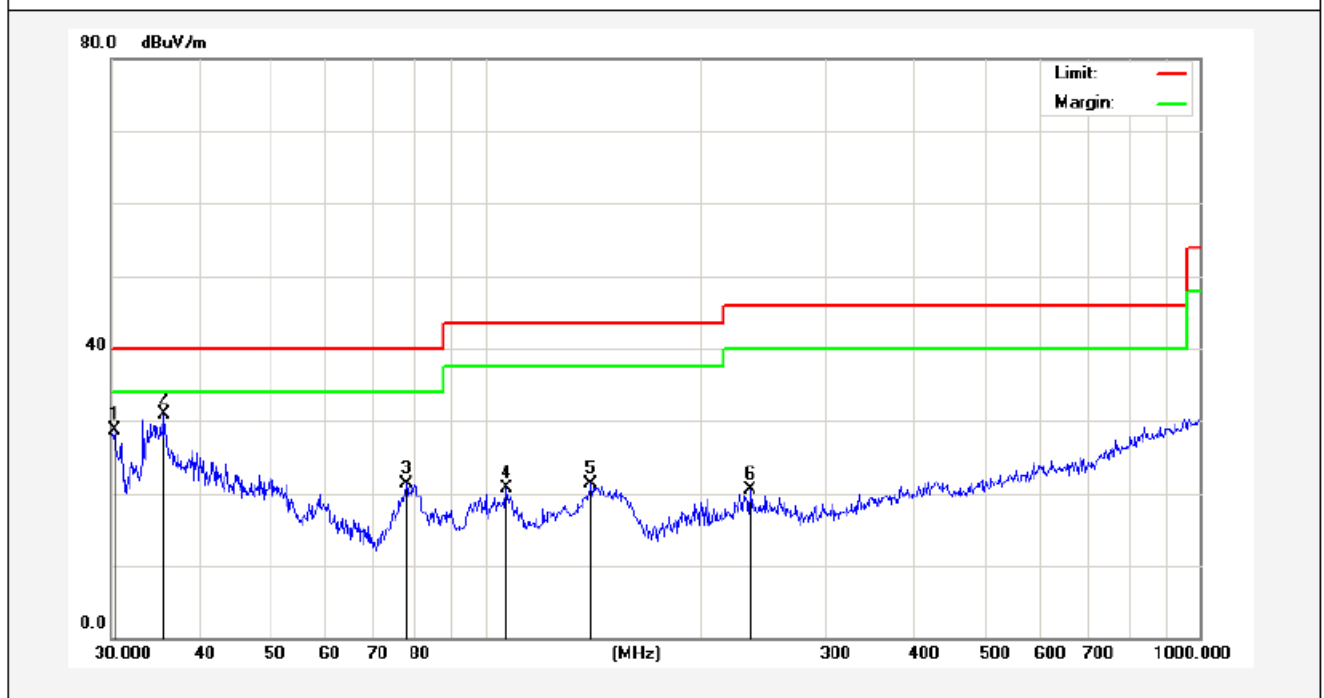

No.	Freq. (MHz)	Reading (dBuV/m)	Factor (dB/m)	Result (dBuV/m)	Limit (dBuV/)	Over Limit (dB)	Detector	Height (cm)	degree (deg)	Remark
1	30.3173	45.49	-16.77	28.72	40.00	-11.28	peak			
2	35.4993	44.80	-13.90	30.90	40.00	-9.10	peak			
3	77.5928	41.50	-20.28	21.22	40.00	-18.78	peak			
4	107.1337	36.39	-15.67	20.72	43.50	-22.78	peak			
5	140.8351	39.85	-18.46	21.39	43.50	-22.11	peak			
6	234.9909	34.93	-14.35	20.58	46.00	-25.42	peak			

Job No.:	011608181I	Polarization:	Horizontal
Standard:	(RE)FCC PART 15C_Class B_3m	Power Source:	DC 3.7V
Test item:	Radiation Test (Above 1GHz)	Temp.(C)/Hum.(%RH):	24.3(C)/55%RH
Test Mode:	TX(2402 MHz)	Distance:	3m

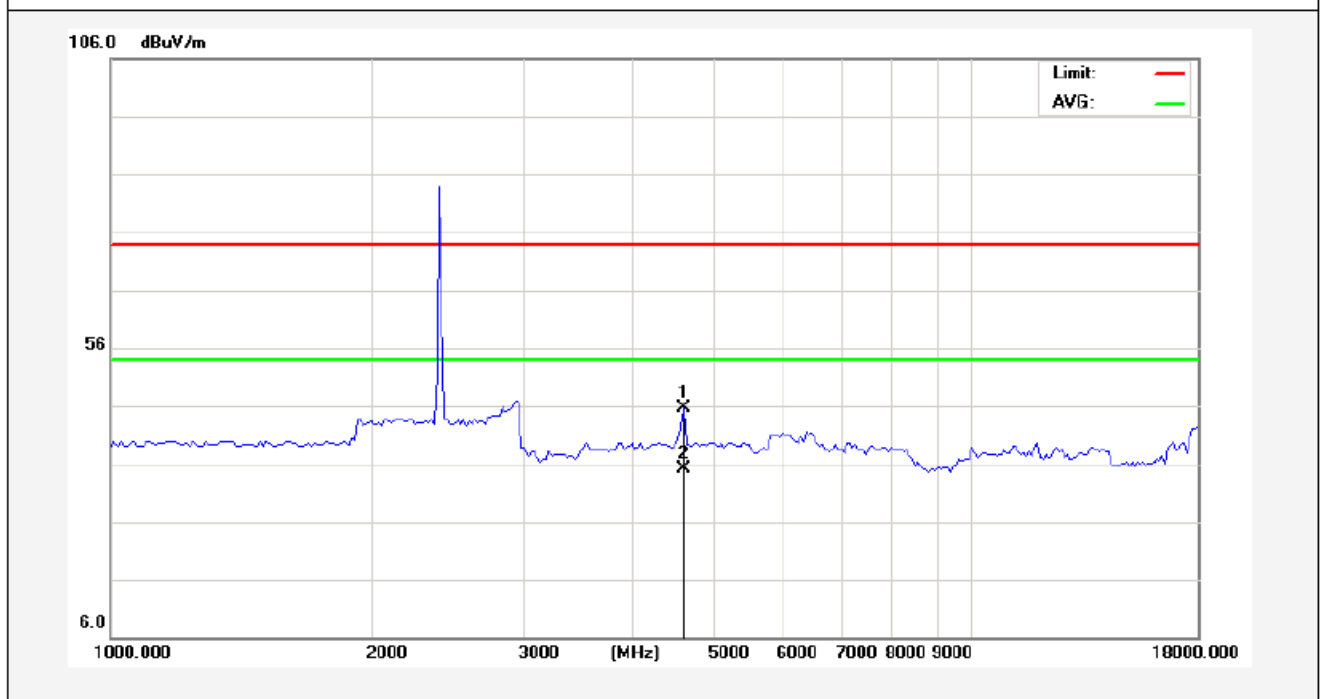

No.	Freq. (MHz)	Reading (dBuV/m)	Factor (dB/m)	Result (dBuV/m)	Limit (dBuV/)	Over Limit (dB)	Detector	Height (cm)	degree (deg)	Remark
1	4612.500	42.72	2.96	45.68	74.00	-28.32	peak			
2	4612.500	32.27	2.96	35.23	54.00	-18.77	AVG			

AMR

Job No.:	0116081811	Polarization:	Vertical
Standard:	(RE)FCC PART 15C_Class B_3m	Power Source:	DC 3.7V
Test item:	Radiation Test (Above 1GHz)	Temp.(C)/Hum.(%RH):	24.3(C)/55%RH
Test Mode:	TX(2402 MHz)	Distance:	3m

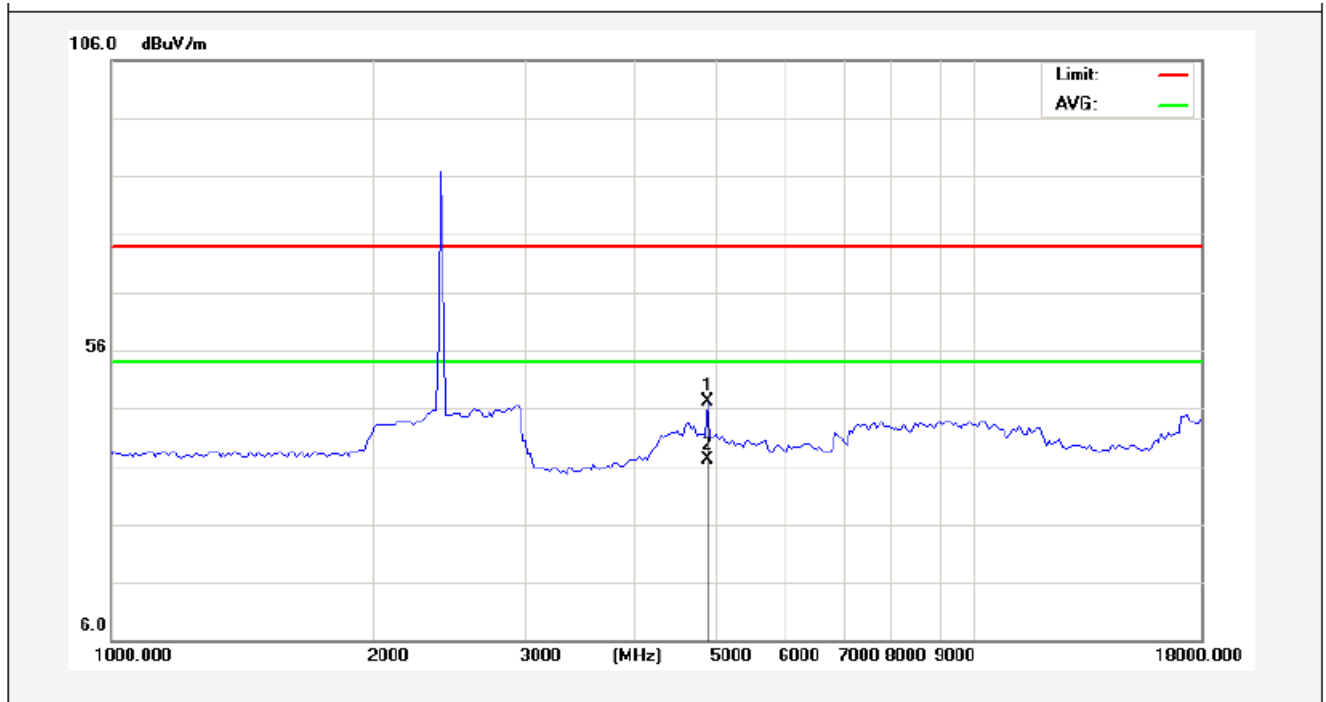

No.	Freq. (MHz)	Reading (dBuV/m)	Factor (dB/m)	Result (dBuV/m)	Limit (dBuV/)	Over Limit (dB)	Detector	Height (cm)	degree (deg)	Remark
1	4867.500	43.70	3.41	47.11	74.00	-26.89	peak			
2	4867.500	33.80	3.41	37.21	54.00	-16.79	AVG			

AMR

Job No.:	0116081811	Polarization:	Horizontal
Standard:	(RE)FCC PART 15C_Class B_3m	Power Source:	DC 3.7V
Test item:	Radiation Test (Above 1GHz)	Temp.(C)/Hum.(%RH):	24.3(C)/55%RH
Test Mode:	TX(2441 MHz)	Distance:	3m

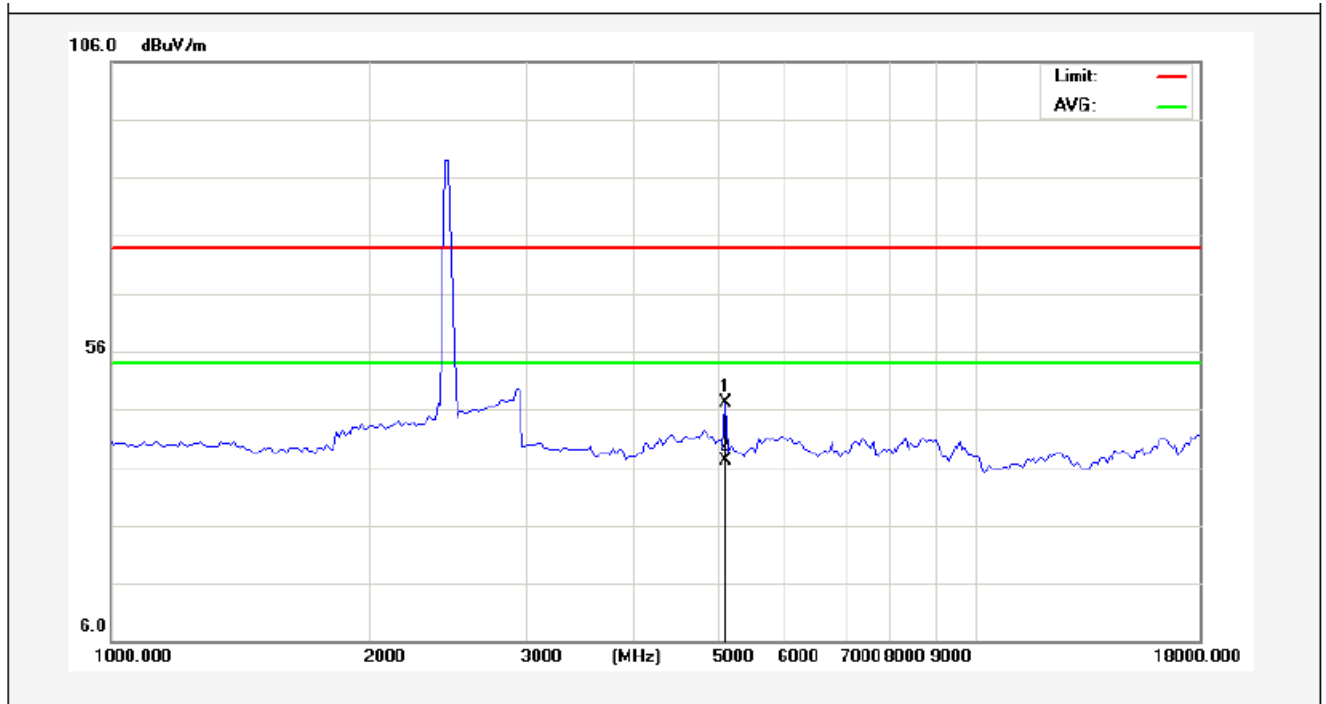

No.	Freq. (MHz)	Reading (dBuV/m)	Factor (dB/m)	Result (dBuV/m)	Limit (dBuV/)	Over Limit (dB)	Detector	Height (cm)	degree (deg)	Remark
1	5122.500	43.52	3.73	47.25	74.00	-26.75	peak			
2	5122.500	33.48	3.73	37.21	54.00	-16.79	AVG			

AMR

Job No.:	011608181I	Polarization:	Vertical
Standard:	(RE)FCC PART 15C_Class B_3m	Power Source:	DC 3.7V
Test item:	Radiation Test (Above 1GHz)	Temp.(C)/Hum.(%RH):	24.3(C)/55%RH
Test Mode:	TX(2441 MHz)	Distance:	3m

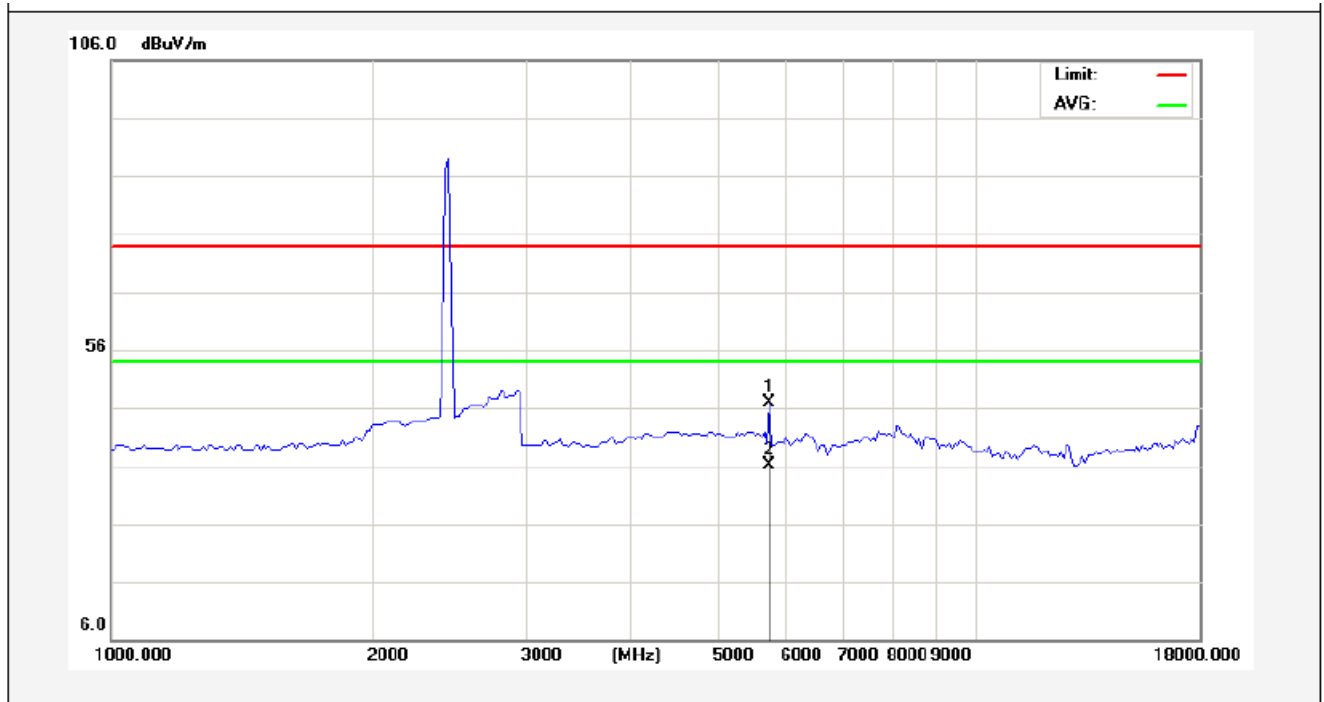

No.	Freq. (MHz)	Reading (dBuV/m)	Factor (dB/m)	Result (dBuV/m)	Limit (dBuV/)	Over Limit (dB)	Detector	Height (cm)	degree (deg)	Remark
1	5760.000	41.23	5.61	46.84	74.00	-27.16	peak			
2	5760.000	30.60	5.61	36.21	54.00	-17.79	AVG			



Job No.:	011608181I	Polarization:	Horizontal
Standard:	(RE)FCC PART 15C_Class B_3m	Power Source:	DC 3.7V
Test item:	Radiation Test (Above 1GHz)	Temp.(C)/Hum.(%RH):	24.3(C)/55%RH
Test Mode:	TX(2480 MHz)	Distance:	3m

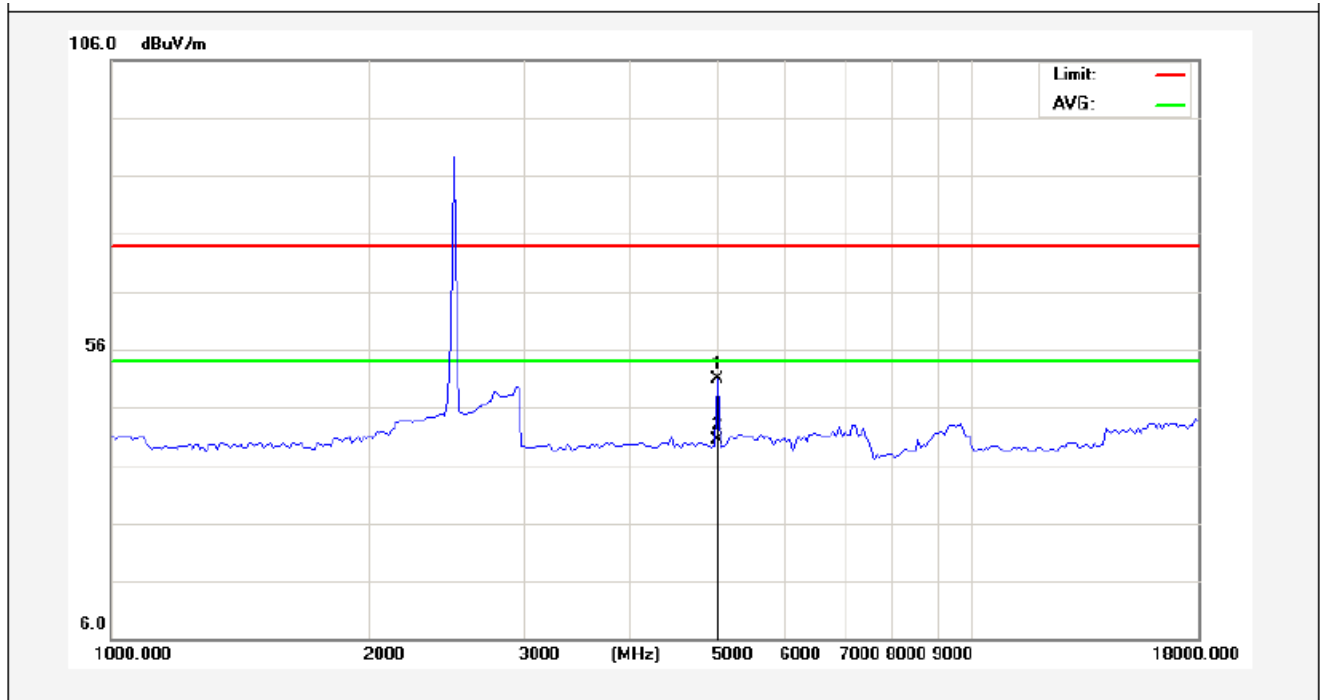

No.	Freq. (MHz)	Reading (dBuV/m)	Factor (dB/m)	Result (dBuV/m)	Limit (dBuV/)	Over Limit (dB)	Detector	Height (cm)	degree (deg)	Remark
1	5037.500	47.20	3.67	50.87	74.00	-23.13	peak			
2	5037.500	36.67	3.67	40.34	54.00	-13.66	AVG			

AMR

Job No.:	0116081811	Polarization:	Vertical
Standard:	(RE)FCC PART 15C_Class B_3m	Power Source:	DC 3.7V
Test item:	Radiation Test (Above 1GHz)	Temp.(C)/Hum.(%RH):	24.3(C)/55%RH
Test Mode:	TX(2480 MHz)	Distance:	3m

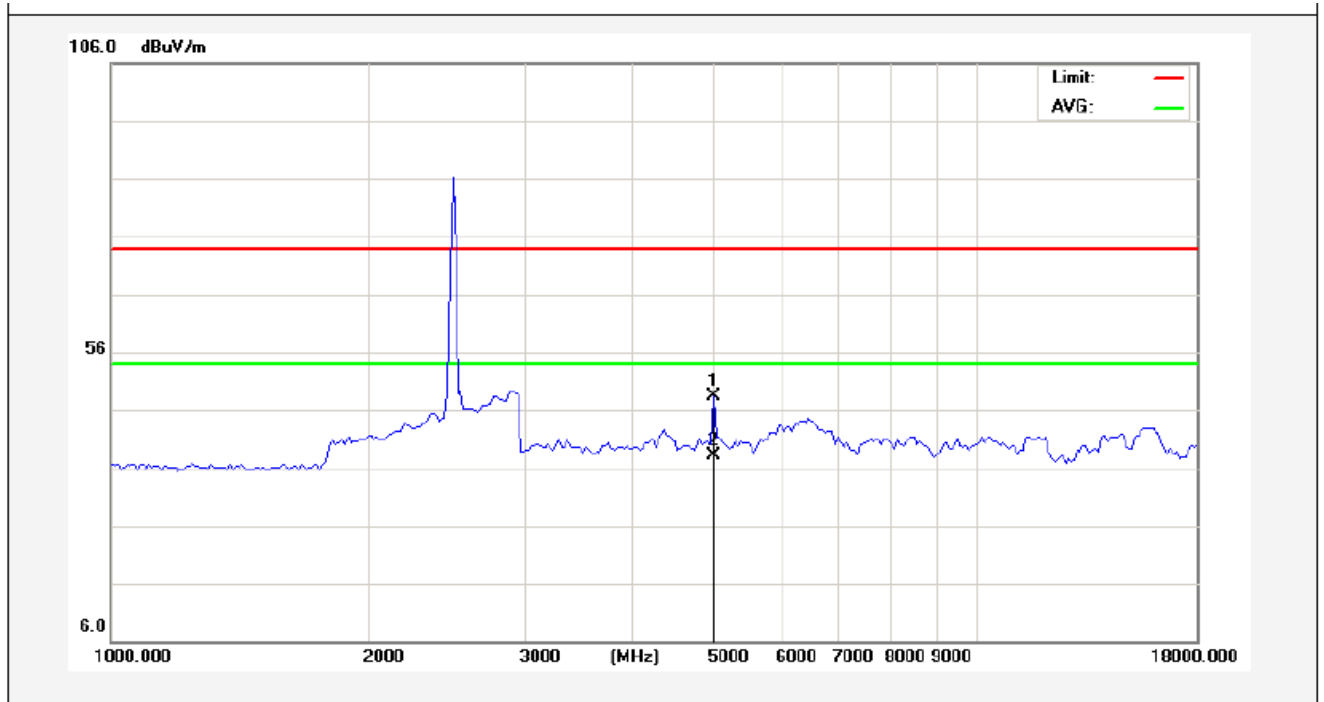

No.	Freq. (MHz)	Reading (dBuV/m)	Factor (dB/m)	Result (dBuV/m)	Limit (dBuV/)	Over Limit (dB)	Detector	Height (cm)	degree (deg)	Remark
1	4995.000	44.82	3.64	48.46	74.00	-25.54	peak			
2	4995.000	34.57	3.64	38.21	54.00	-15.79	AVG			

AMR

5. CHANNEL SEPARATION TEST

5.1 Measurement Procedure

The EUT must have its hopping function enabled. Using the following spectrum analyzer settings:

1. Span= Wide enough to capture the peaks of two adjacent channels
2. Set the RBW = 30 kHz.
3. Set the VBW = 100 kHz.
4. Sweep time = auto couple.
5. Detector function = peak.
6. Trace mode = max hold.
7. Allow trace to fully stabilize.

5.2 Test SET-UP

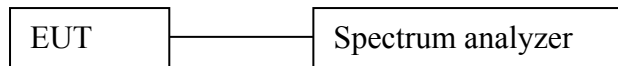

5.3 Test Equipment

Item	Equipment	Manufacturer	Model No.	Serial No.	Last Cal.	Cal. Interval
1.	Spectrum Analysis	Agilent	E4407B	US39390582	Apr. 17, 2016	1 Year
2.	Preamplifier	Instruments corporation	EMC011830	980100	Apr. 17, 2016	1 Year
3.	EMI Test Receiver	Rohde & Schwarz	ESPI	101604	Apr. 17, 2016	1 Year
4.	Double Ridged Horn Antenna	Instruments corporation	GTH-0118	351600	Apr. 20, 2016	1 Year
5.	Bilog Broadband Antenna	Schwarzbeck	VULB9163	VULB 9163-289	Apr. 20, 2016	1 Year
6.	Pre-amplifier	SONOMA	310N	186860	Apr. 17, 2016	1 Year
7.	EMI Test Software EZ-EMC	SHURPLE	N/A	N/A	N/A	N/A
8	Power Sensor	DAER	RPR3006W	15I00041SN046	Jun 30, 2016	1 Year
9	MXA Spectrum Analysis	Agilent	N9020A	MY51170037	Jun 30, 2016	1 Year
10	MXG RF Vector Signal Generator	Agilent	N5182A	MY48180656	Jun 30, 2016	1 Year
11	Signal Generator	Agilent	E4421B	MY41000743	Jun 30, 2016	1 Year
12	DC Power supply	IV	IV-8080	YQSB0096	Jun 30, 2016	1 Year
13	TEMP&HUMI PROGRAMMABLE CHAMBER	Bell Group	BE-THK-150M8	SE-0137	Mar 16, 2016	1 Year

5.4 Test Results

Test Item : Frequency Separation Test Mode : CH Low ~ CH High
 Test Voltage : DC 3.7V Temperature : 24°C
 Test Result : PASS Humidity : 55%RH

Channel	Frequency (MHz)	Separation Read Value (kHz)	Limit (kHz)	Modulation Mode
Low	2401	1002	929.6	BDR
Mid	2441	1002	929.0	BDR
High	2480	1002	927.6	BDR
Low	2401	1002	844.0	EDR
Mid	2441	1002	841.3	EDR
High	2480	1002	838.7	EDR

Remark:

1. The limit of mode (EDR) is 2/3 of 20dB BW;
2. The EDR was tested on ($\pi/4$ DQPSK, 8DPSK) modes, only the worst data of ($\pi/4$ DQPSK) is attached in the following pages.



Test Mode: BDR---Low



Test Mode: BDR---Mid



Test Mode: BDR---High



Test Mode: EDR---Low



Test Mode: EDR---Mid

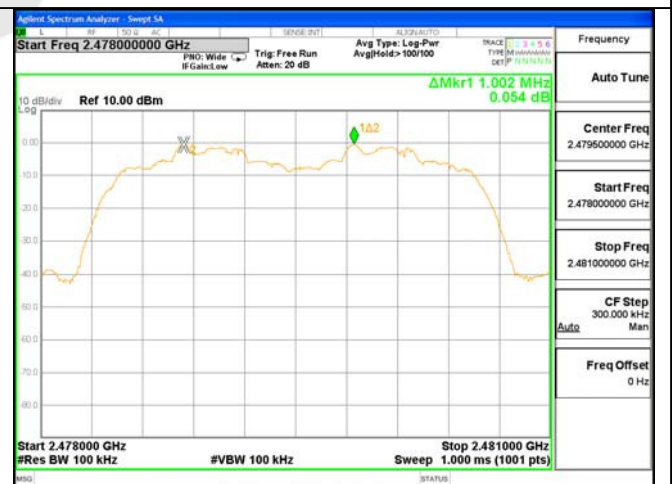

Test Mode: EDR---High

6. 20DB BANDWIDTH TEST

6.1 Measurement Procedure

Using the following spectrum analyzer settings:

1. Span= approximately 2 to 3 times the 20dB bandwidth, centered on a hopping channel.
2. Set the RBW = 30 kHz.
3. Set the VBW = 100 kHz.
4. Sweep time = auto couple.
5. Detector function = peak.
6. Trace mode = max hold.
7. Allow trace to fully stabilize.

6.2 Test SET-UP

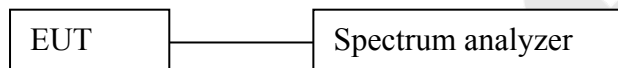

6.3 Test Equipment

Same as the equipment listed in 5.3.

6.4 Test Results

Test Item	: 20dB BW	Test Mode	: CH Low ~ CH High
Test Voltage	: DC 3.7V	Temperature	: 24°C
Test Result	: PASS	Humidity	: 55%RH

Channel	Frequency (MHz)	20dB Down BW(kHz)	Modulation Mode
Low	2401	929.6	BDR
Mid	2441	929.0	BDR
High	2480	927.6	BDR
Low	2401	1266.0	EDR
Mid	2441	1262.0	EDR
High	2480	1258.0	EDR

Remark: The EDR was tested on ($\pi/4$ DQPSK, 8DPSK) modes, only the worst data of ($\pi/4$ DQPSK) is attached in the following pages.

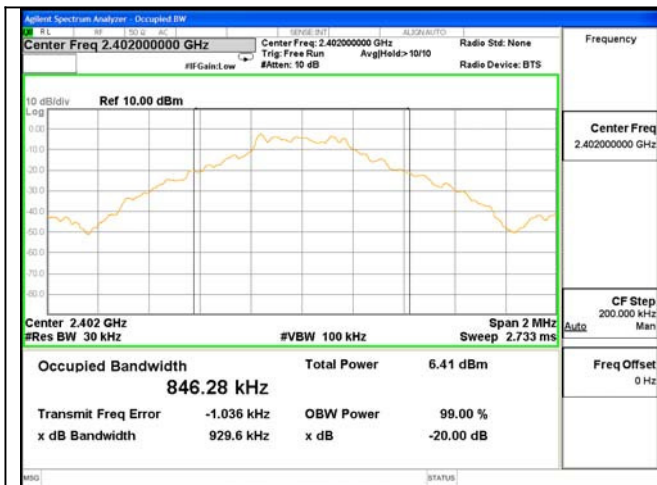

Test Mode: BDR---Low

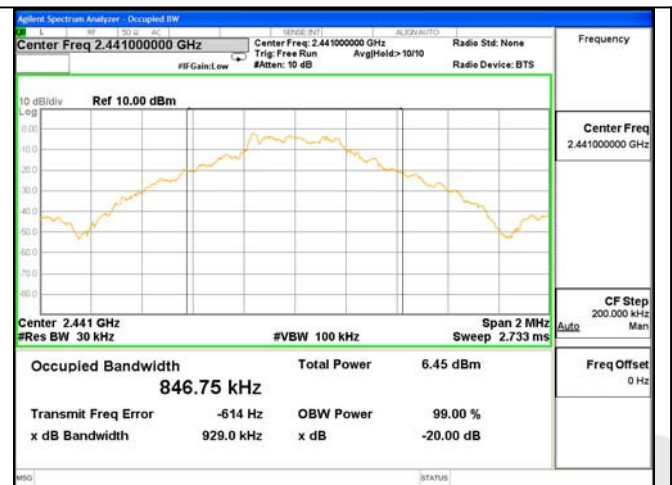

Test Mode: BDR---Mid

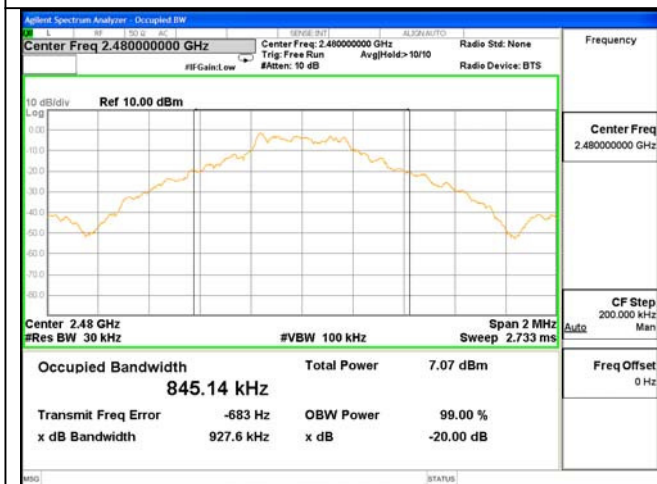

Test Mode: BDR---High

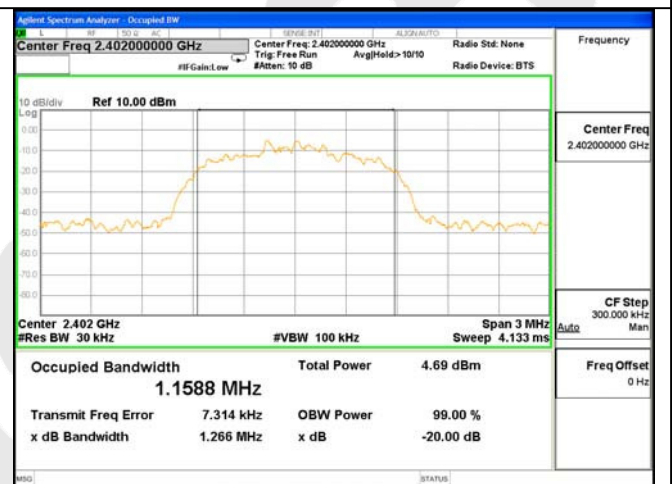

Test Mode: EDR---Low

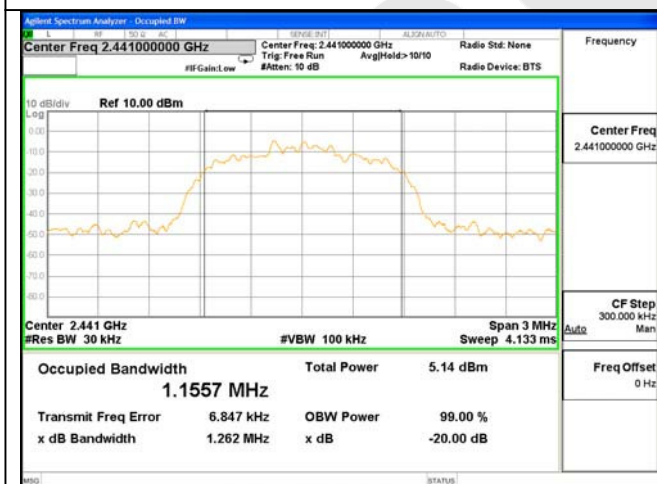

Test Mode: EDR---Mid

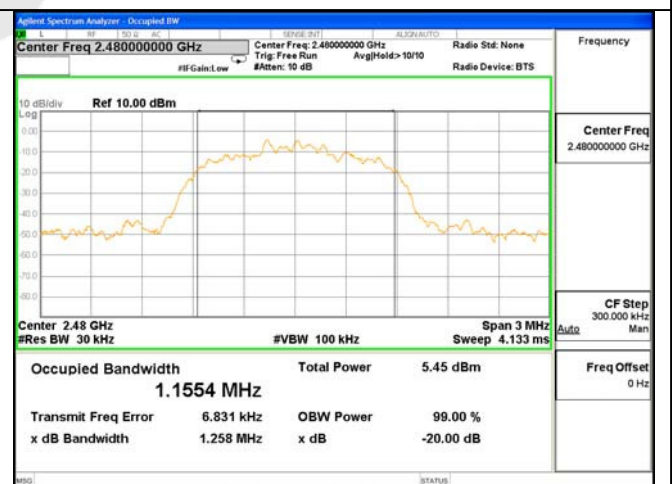

Test Mode: EDR---High

7. QUANTITY OF HOPPING CHANNEL TEST

7.1 Measurement Procedure

The EUT must have its hopping function enabled. Using the following spectrum analyzer setting:

1. Span= the frequency band of operation
2. Set the RBW = 1 MHz.
3. Set the VBW = 1 MHz.
4. Sweep time = auto couple.
5. Detector function = peak.
6. Trace mode = max hold.
7. Allow trace to fully stabilize.

7.2 Test SET-UP

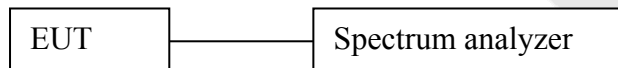

7.3 Test Equipment

Same as the equipment listed in 5.3.

7.4 Test Results

Test Item	: Number of Hopping Frequency	Test Mode	: CH Low ~ CH High
Test Voltage	: DC 3.7V	Temperature	: 24°C
Test Result	: PASS	Humidity	: 55%RH

Hopping Channel Frequency Range	Quantity of Hopping Channel	Quantity of Hopping Channel
2402-2480	79	> 15

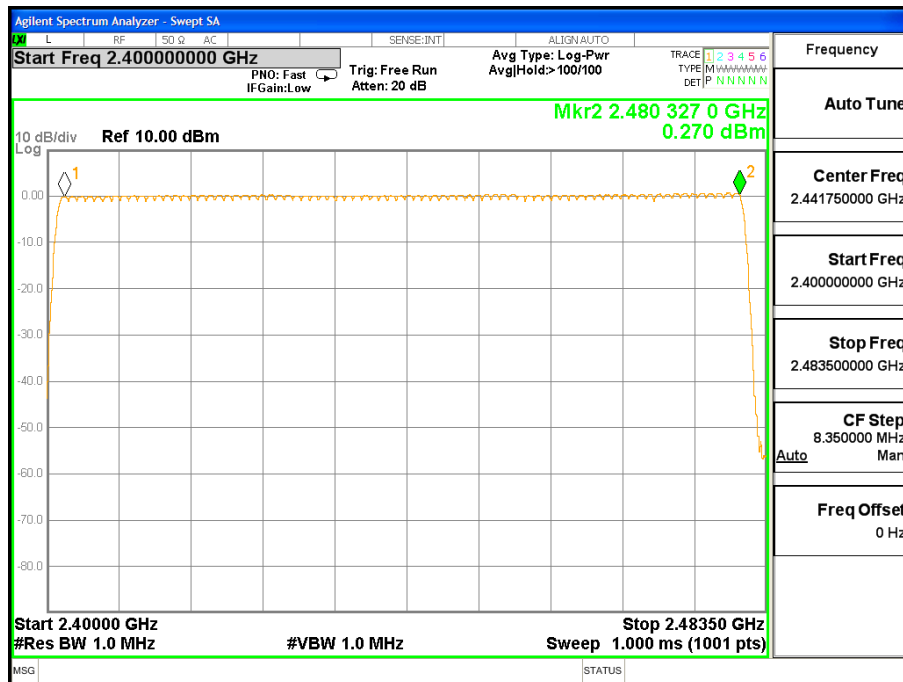

8. DWELL TIME TEST

8.1 Measurement Procedure

The EUT must have its hopping function enabled. Use the following spectrum analyzer settings:

1. Span= zero span, centered on a hopping channel
2. Set the RBW = 1 MHz.
3. Set the VBW = 1 MHz.
4. Sweep time = as necessary to capture the entire dwell time per hopping channel.
5. Detector function = peak.
6. Trace mode = max hold.
7. Allow trace to fully stabilize.

8.2 Test SET-UP

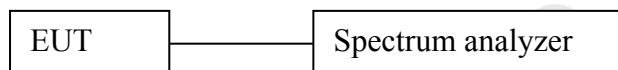

8.3 Test Equipment

Same as the equipment listed in 5.3.

8.4 Test Results

Test Item	: Time of Occupancy	Test Mode	: CH Low ~ CH High
Test Voltage	: DC 3.7V	Temperature	: 24°C
Test Result	: PASS	Humidity	: 55%RH

Package Type	Pulse width (ms)	Time slot length(ms)	Dwell time (ms)	Limit (s)	Modulation
DH1	0.364	time slot length *1600/2 /79 * 31.6	116.48	0.4	BDR
DH3	1.620	time slot length *1600/4 /79 * 31.6	259.20	0.4	BDR
DH5	2.863	time slot length *1600/6 /79 * 31.6	305.39	0.4	BDR
DH1	0.376	time slot length *1600/2 /79 * 31.6	120.32	0.4	EDR
DH3	1.620	time slot length *1600/4 /79 * 31.6	259.20	0.4	EDR
DH5	2.863	time slot length *1600/6 /79 * 31.6	305.39	0.4	EDR



Test Mode: BDR---DH1



Test Mode: BDR---DH3



Test Mode: BDR---DH5



Test Mode: EDR---DH1

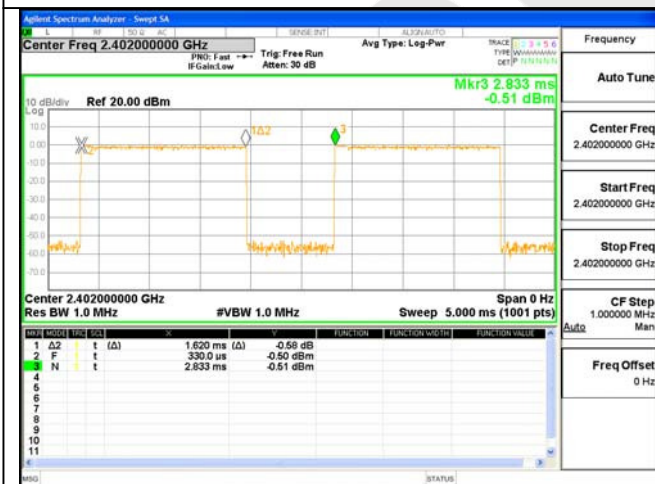

Test Mode: EDR---DH3



Test Mode: EDR---DH5

9. MAXIMUM PEAK OUTPUT POWER TEST

9.1 Measurement Procedure

- a. Check the calibration of the measuring instrument(SA) using either an internal calibrator or a known signal from an external generator.
- b. Turn on the EUT and connect it to measurement instrument. Then set it to any one convenient frequency within its operating range. Set a reference level on the measuring instrument equal to the highest peak value.
- c. The center frequency of the spectrum analyzer is set to the fundamental frequency and using proper RBW and VBW setting.
- d. Measure the captured power within the band and recording the plot.
- e. Repeat above procedures until all frequencies required were complete.

Using the following spectrum analyzer settings:

1. Span= approximately 5 times the 20dB bandwidth, centered on a hopping channel
2. Set the RBW = 3 MHz.
3. Set the VBW = 3 MHz.
4. Sweep time = auto couple.
5. Detector function = peak.
6. Trace mode = max hold.
7. Allow trace to fully stabilize.

9.2 Test SET-UP

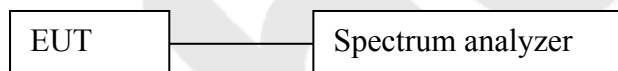

9.3 Test Equipment

Same as the equipment listed in 5.3.

9.4 Test Results

Test Item	: Max. peak output power	Test Mode	: CH Low ~ CH High
Test Voltage	: DC 3.7V	Temperature	: 24°C
Test Result	: PASS	Humidity	: 55%RH

Channel Frequency (MHz)	Peak Power output(mW)	Peak Power output(dBm)	Peak Power Limit(mW)	Results	Modulation
2402	0.992	-0.034	1000	PASS	BDR
2441	1.035	0.149	1000	PASS	BDR
2480	1.162	0.653	1000	PASS	BDR
2402	0.980	-0.089	125	PASS	EDR
2441	1.018	0.078	125	PASS	EDR
2480	1.149	0.604	125	PASS	EDR

Remark: The EDR was tested on ($\pi/4$ DQPSK, 8DPSK) modes, only the worst data of ($\pi/4$ DQPSK) is attached in the following pages.

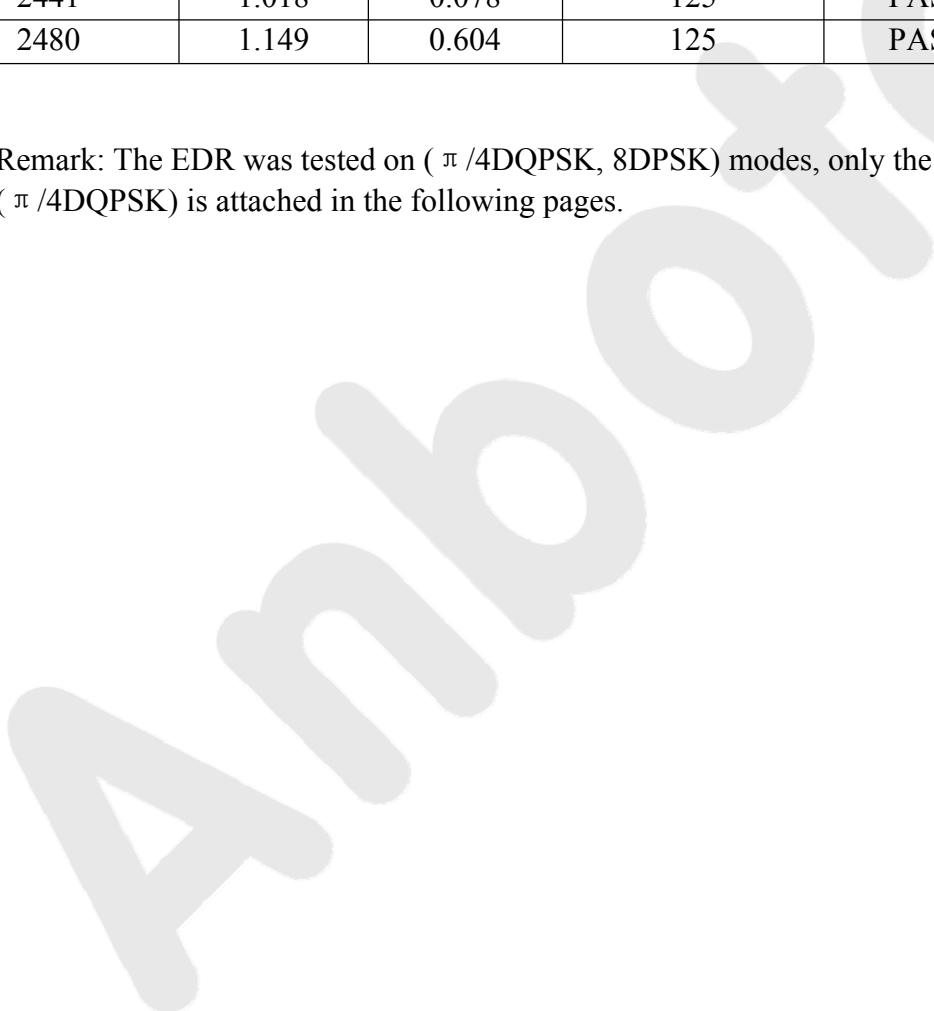

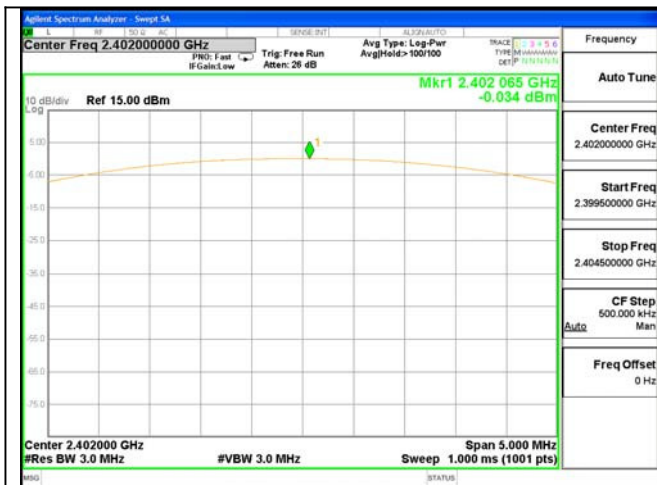

Test Mode: BDR---Low

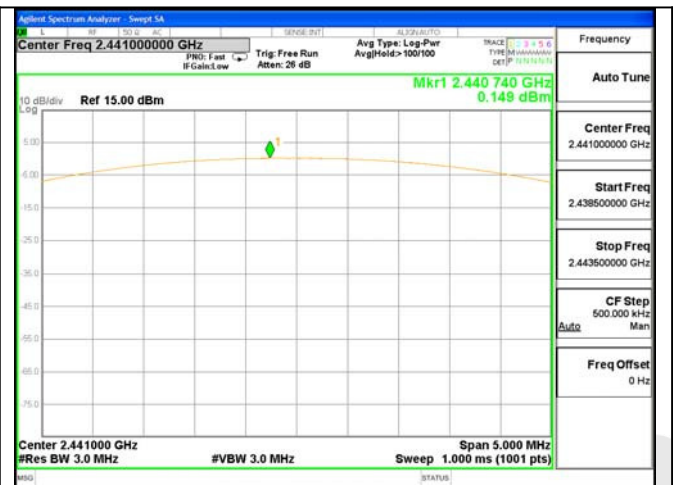

Test Mode: BDR---Mid

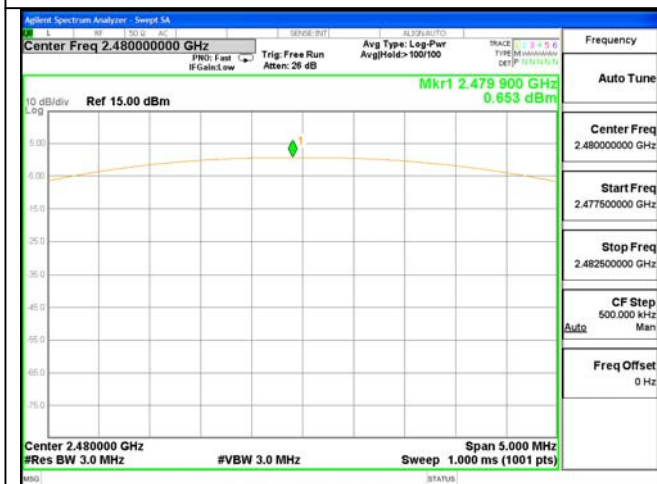

Test Mode: BDR---High

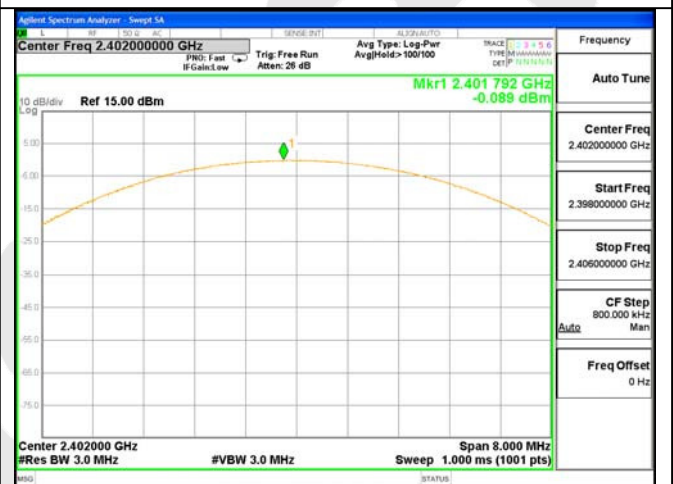

Test Mode: EDR---Low



Test Mode: EDR---Mid

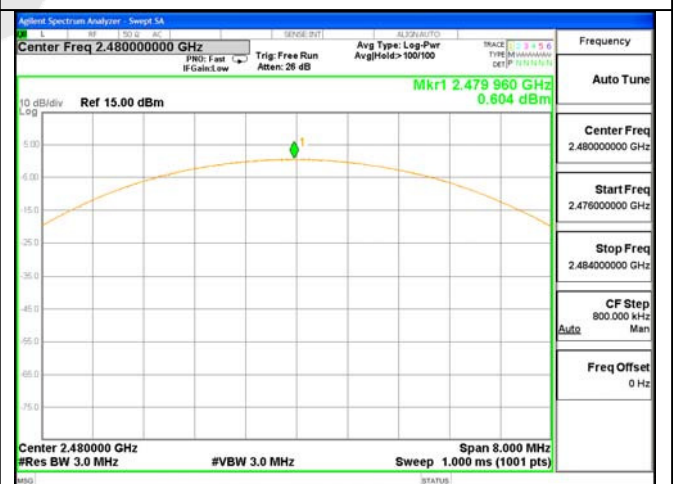

Test Mode: EDR---High

10. BAND EDGE TEST

10.1 Measurement Procedure

A) Conducted Emission method:

1. Check the calibration of the measuring instrument using either an internal calibrator or a known signal from an external generator.
2. Position the EUT without connection to measurement instrument. Put it on the Rotated table and turn on the EUT and make it operate in transmitting mode. Then set it to low Channel and High Channel within its operating range, and make sure the instrument is operated in its linear range.
3. Set both RBW and VBW of spectrum analyzer to 100kHz with a convenient frequency span including 100kHz bandwidth from band edge,
4. Measurement the highest amplitude appearing on spectral display and set it as a reference level. Plot the graph with marking the highest point and edge frequency.
5. Report above procedures until all measured frequencies were complete.

B) Radiated Emission method:

The EUT is placed on a turn table which is 1.5 meter high above the ground. The turn table can rotate 360 degrees to determine the position of the maximum emission level. The EUT is set 3 meters away from the receiving antenna which is mounted on a antenna tower. The antenna can be moved up and down from 1 to 4 meters to find out the maximum emission level. Rotated the EUT through three orthogonal axes to determine the maximum emissions, both horizontal and vertical polarization of the antenna are set on test. The EUT is tested in 9*6*6 Chamber. for Radiated emissions restricted band RBW= 1 MHz, VBW= 3 MHz.

10.2 Test SET-UP

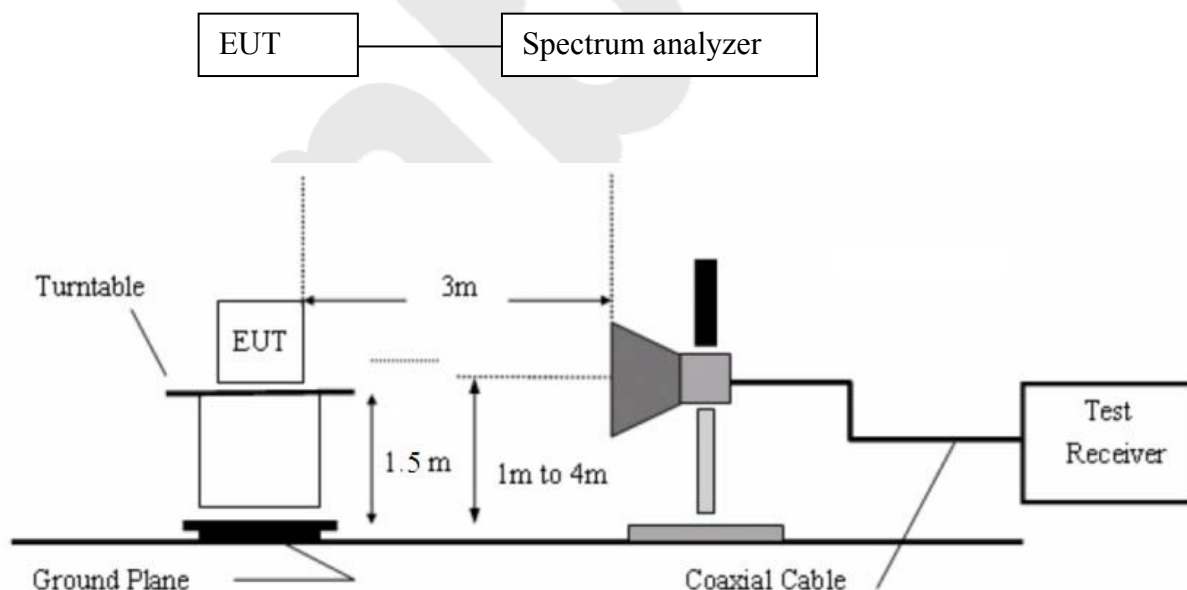

10.3 Test Equipment

Same as the equipment listed in 5.3.

10.4 Test Results

Pass.

Please refer the following data.

Test Item	: Band edge	Test Mode	: CH Low ~ CH High
Test Voltage	: DC 3.7V	Temperature	: 24°C
Test Result	: PASS	Humidity	: 55%RH

For Hopping Mode:

Remark: The EDR was tested on ($\pi/4$ DQPSK, 8DPSK) modes, only the worst data of ($\pi/4$ DQPSK) is attached in the following pages.

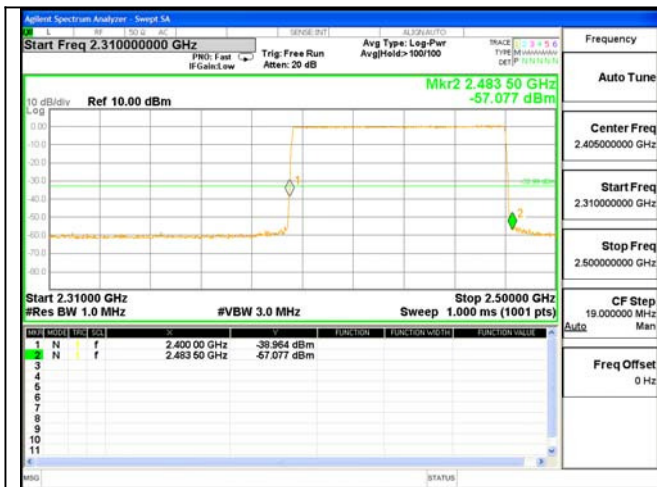

Test Mode: BDR



Test Mode: BDR

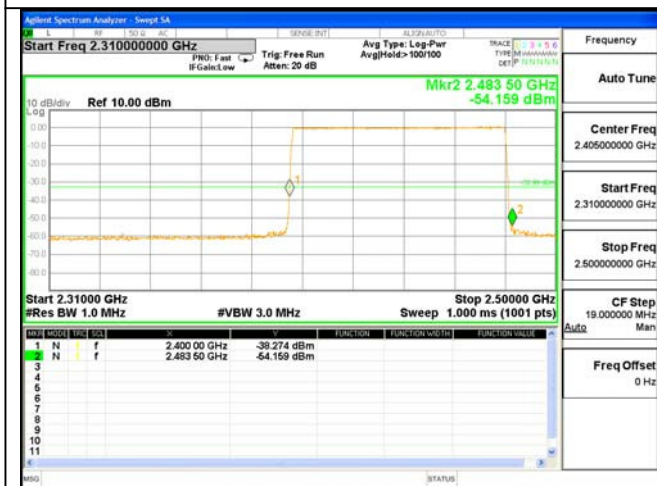

Test Mode: EDR

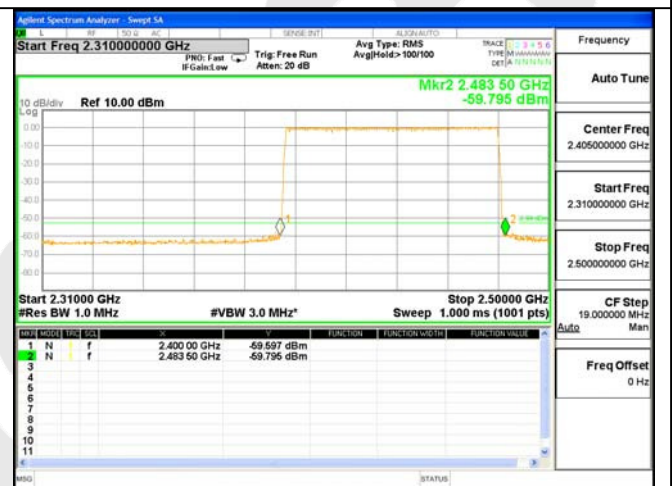

Test Mode: EDR

Test Item	: Band edge	Test Mode	: CH Low ~ CH High
Test Voltage	: DC 3.7V	Temperature	: 24°C
Test Result	: PASS	Humidity	: 55%RH

For Non-Hopping Mode:

1. Conducted Test

Frequency (MHz)	Peak Power Output(dBm)	Emission read Value(dBm)	Result of Band edge(dBc)	Band edge Limit(dBc)	Modulation
<2400	1.914	-43.345	45.289	>20dBc	BDR
	2.289	-34.326	32.037	>20dBc	EDR
>2483.5	0.087	-56.703	56.790	>20dBc	BDR
	0.748	-53.925	64.673	>20dBc	EDR

2. Radiated emission Test

Frequency (MHz)	Antenna polarization (H/V)	Emission (dBuV/m)		Band edge Limit (dBuV/m)		Modulation
		PK	AV	PK	AV	
<2400	V	53.15	39.51	74.00	54.00	BDR
	V	51.74	38.16	74.00	54.00	EDR
>2483.5	V	50.29	37.69	74.00	54.00	BDR
	V	48.88	35.93	74.00	54.00	EDR

Remark: The EDR was tested on ($\pi/4$ DQPSK, 8DPSK) modes, only the worst data of ($\pi/4$ DQPSK) is attached in the following pages.

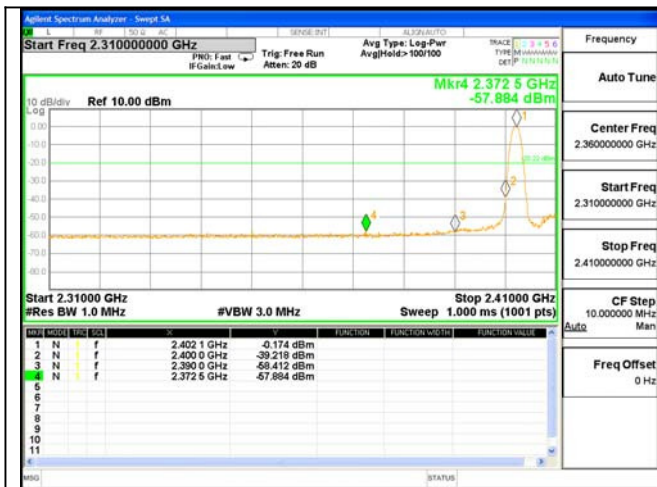

Test Mode: BDR



Test Mode: BDR



Test Mode: EDR

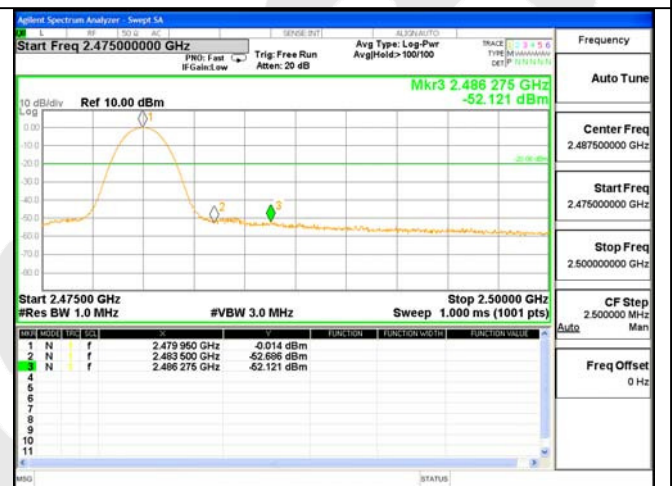

Test Mode: EDR

11. ANTENNA APPLICATION

11.1 Antenna requirement

The EUT'S antenna is met the requirement of FCC part 15C section 15.203 and 15.247.

FCC part 15C section 15.247 requirements:

Systems operating in the 2402-2480MHz band that are used exclusively for fixed, point-to-point operations may employ transmitting antennas with directional gain greater than 6dBi provided the maximum peak output power of the intentional radiator is reduced by 1dB for every 3dB that the directional gain of the antenna exceeds 6dBi.

11.2 Result

The EUT's antenna used a PCB Antenna, The antenna's gain is 0.944dBi and meets the requirement.

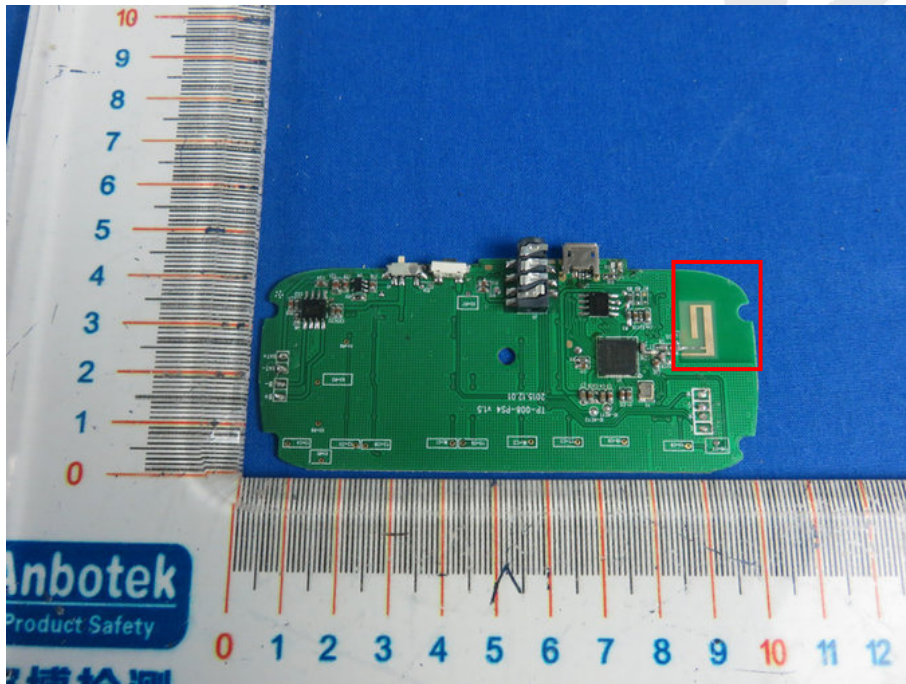

12. PHOTOGRAPH

12.1 Photo of Power Line Conducted Emission Measurement



12.2 Photo of Radiation Emission Test

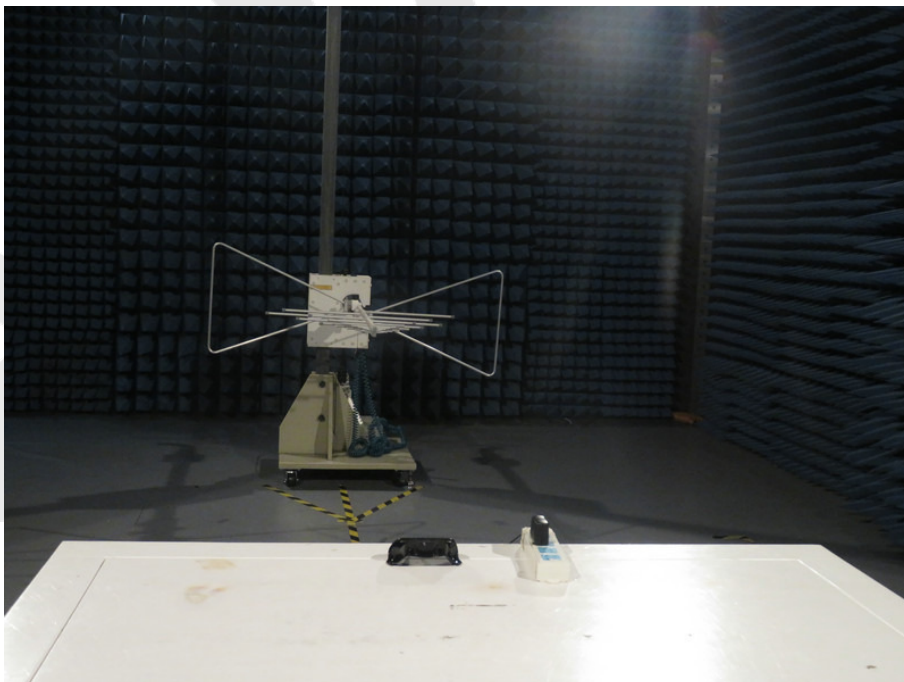

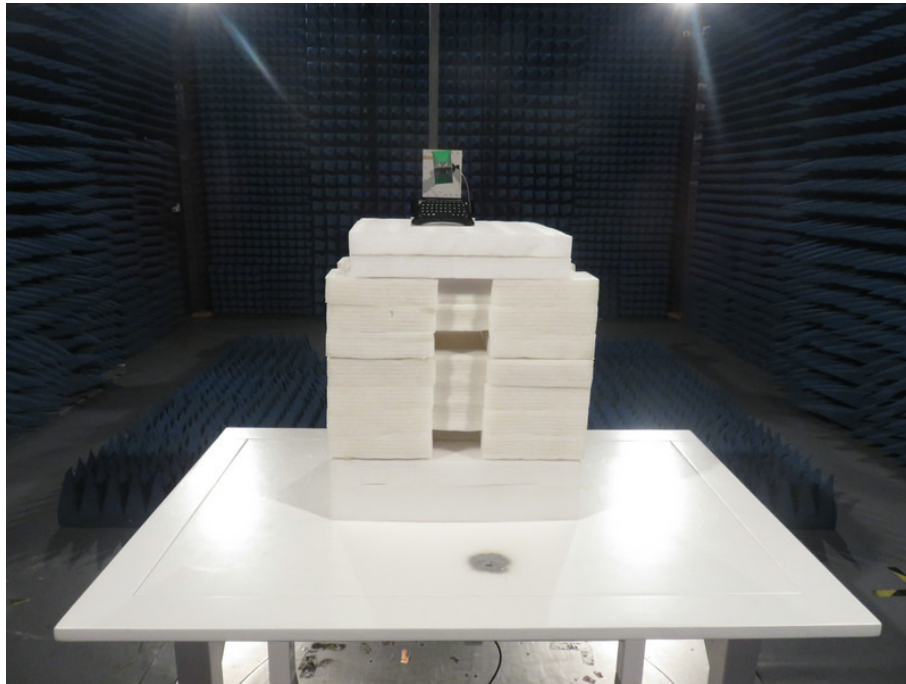

Anbotek

APPENDIX I (EXTERNAL PHOTOS)

1. Figure
The EUT-Overall View



2. Figure
The EUT-Top View



3. Figure
The EUT-Bottom View



4. Figure
The EUT-Front View



5. Figure
The EUT-Back View



6. Figure
The EUT-Right View



7. Figure
The EUT-Left View



APPENDIX II (INTERNAL PHOTOS)

1. Figure
The EUT-Inside View

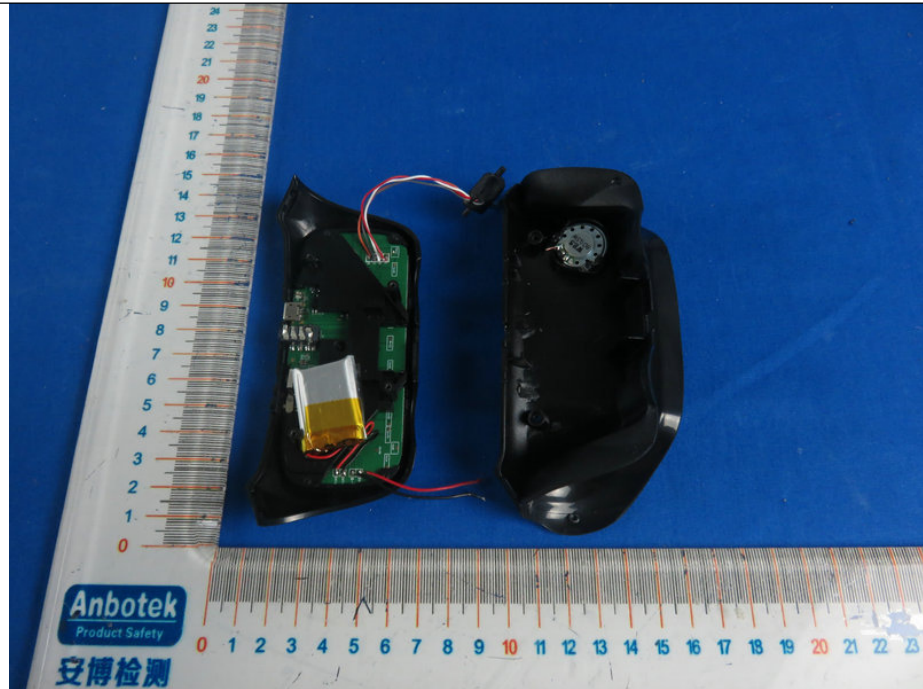

2. Figure
The EUT-Inside View



3. Figure
PCB of the EUT-Front View

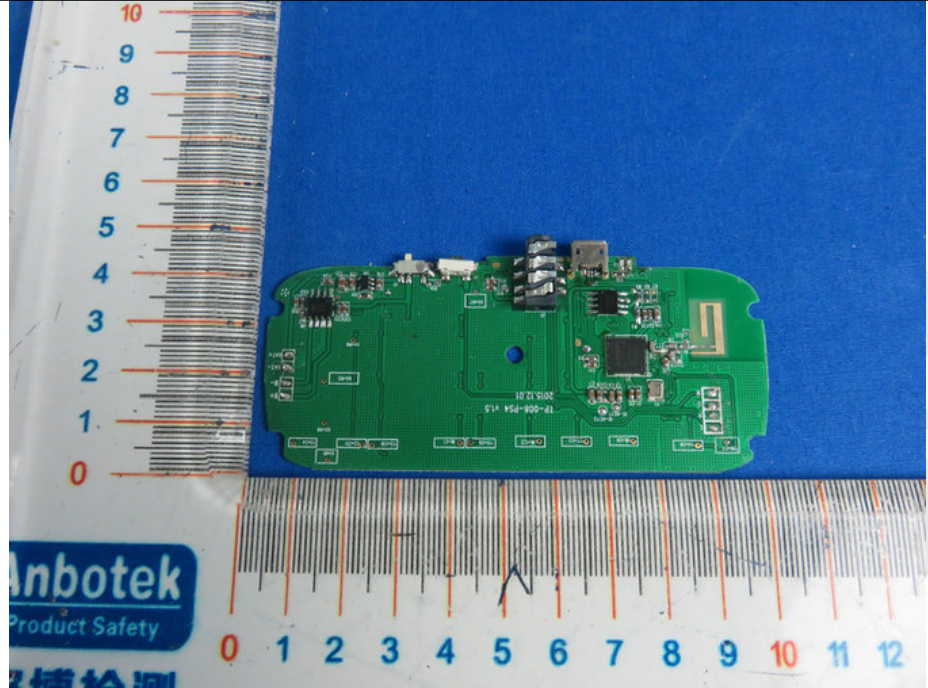

4. Figure
PCB of the EUT-Back View

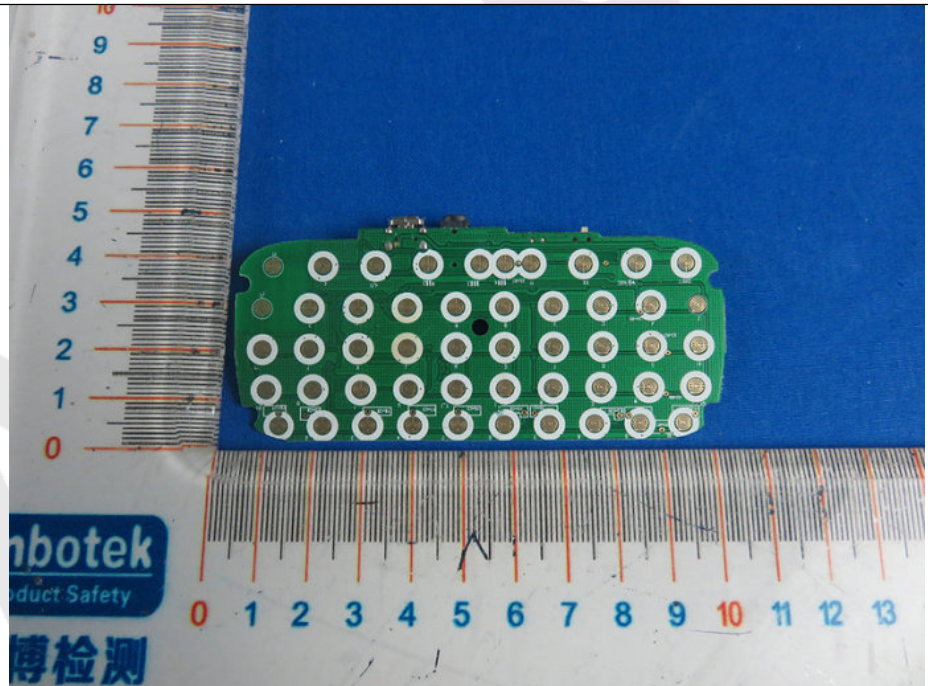

5. Figure
PCB of the EUT-Front View

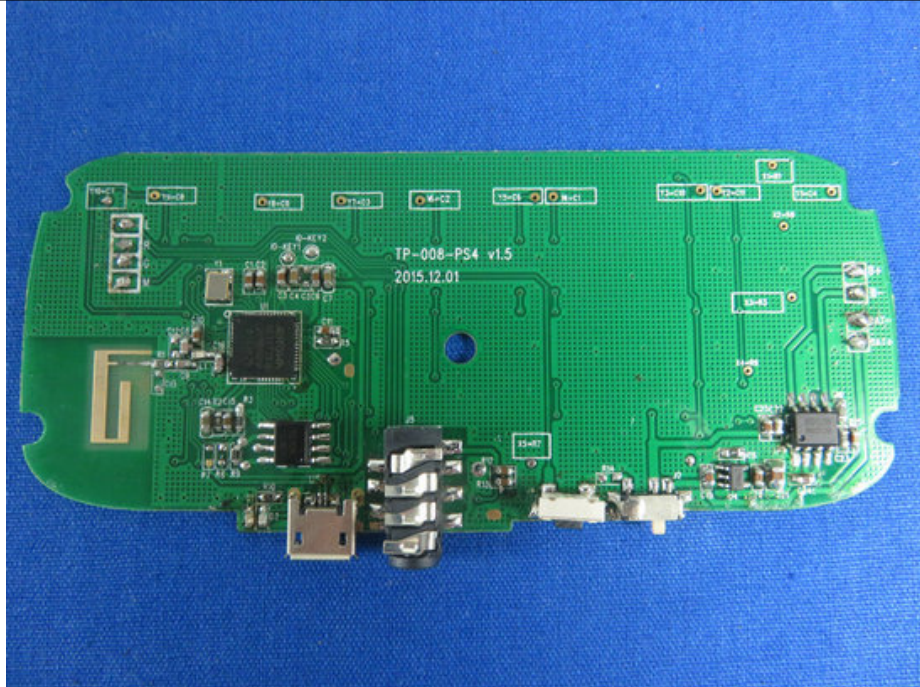

6. Figure
PCB of the EUT-Back View

