

Electromagnetic Emission

FCC MEASUREMENT REPORT

CERTIFICATION OF COMPLIANCE

FCC Part 15 Certification Measurement

PRODUCT : HP Sprocket Photo Printer
MODEL/Serial No. : SNPRH-1603 / KR66B1004X
MULTIPLE MODEL : -
BRAND NAME : 
FCC ID : 2AJJ9SNPRH-1603
APPLICANT : DSGLOBAL CO., LTD.
107, Gasan digital 2-ro, Geumcheon-gu, Seoul, KOREA
Attn.: In Jong Na / R&D Hardware Engineer
MANUFACTURER : HP Information Technology R&D (Shanghai) Co., Ltd.
Room203-C, No.26 Jia Feng Road, Waigaoqiao Free Trade Zone,
Pudong, Shanghai, 200131 P.R, CHINA
FACTORY : DSGLOBAL CO., LTD.
107, Gasan digital 2-ro, Geumcheon-gu, Seoul, KOREA
EQUIPMENT CLASS : DTS (Part 15 Digital Transmission System)
TYPE OF MODULATION : FHSS (GFSK)
FREQUENCY CHANNEL : 2 402 MHz to 2 480 MHz and Channel Spacing 2 MHz (40 Ch, BT 4.0 LE)
AIR DATE RATE : GFSK
ANTENNA TYPE : Chip Antenna (Integral)
ANTENNA GAIN : 1.80 dBi max
RF POWER : 3.96 mW
RULE PART(S) : FCC Part 15 Subpart C
FCC PROCEDURE : ANSI C63.10-2013
TEST REPORT No. : ETLT160803.0089
DATES OF TEST : August 03, 2016 to August 13, 2016
REPORT ISSUE DATE : August 22, 2016
TEST LABORATORY : ETL Inc. (FCC Designation Number : KR0022)

The HP Sprocket Photo Printer, Model SNPRH-1603 has been tested in accordance with the measurement procedures specified in ANSI C63.10-2013 at the ETL Test Laboratory and has been shown to be complied with the electromagnetic radiated emission limits specified in FCC Rule Part15 Subpart C section 15.247. I attest to the accuracy of data. All measurement herein was performed by me or was made under my supervision and is correct to the best of my knowledge and belief. I assume full responsibility for the completeness of these measurements and vouch for the qualifications of all persons taking them. The results of testing in this report apply to the product/system which was tested only. Other similar equipment will not necessarily produce the same results due to production tolerance and measurement uncertainties.

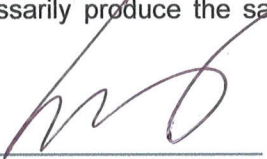
Prepared by: 
Dong Jin, Seo (Test Engineer)
August 22, 2016

Reviewed by: 
Kug Kyoung, Yoon (Chief Engineer)
August 22, 2016

ETL Inc.

Head office: #371-51, Gasan-dong, Geumcheon-gu, Seoul, 153-803, Korea

Open site: #499-1, Sagot-ri, Seosin-myeon, Hwaseong-si, Gyeonggi-do, 445-882, Korea

Tel: 82-2-858-0786 Fax: 82-2-858-0788

*The test report merely corresponds to the test sample(s).
This report shall not be reproduced, in whole or in part without the written approval of ETL Inc.*

Table of Contents

FCC Measurement Report

- 1. Introduction**
- 2. Product Information**
- 3. Description of Tests**
- 4. Test Condition**
- 5. Test Results**
 - 5.1 Summary of Test Results**
 - 5.2 6 dB Bandwidth**
 - 5.3 Maximum Peak Output Power**
 - 5.4 Bandwidth of Frequency Band Edges**
 - 5.5 Power Spectral Density**
 - 5.6 Spurious Emissions**
 - 5.7 Conducted Emissions Test**
 - 5.8 Radio Frequency Exposure**
- 6. Sample Calculation**
- 7. List of test Equipment used for Measurement**

FCC MEASUREMENT REPORT

Scope – Measurement and determination of electromagnetic emission (EME) of radio frequency devices including intentional radiators and/or unintentional radiators for compliance with the technical rules and regulations of the U.S Federal Communications Commission(FCC)

General Information

Applicant Name	: DSGLOBAL CO., LTD.
Address	: 107, Gasan digital 2-ro, Geumcheon-gu, Seoul, KOREA
Attention	: In Jong Na / R&D Hardware Engineer

- **EUT Type** : HP Sprocket Photo Printer
- **Model Number** : SNPRH-1603
- **S/N** : KR66B1004X
- **Modulation Technique** : GFSK
- **Frequency Channel** : 2 402 MHz to 2 480 MHz and Channel Spacing 2 MHz (40 Ch, BT 4.0 LE)
- **Antenna Type** : Chip Antenna (Integral)
- **Antenna Gain** : 1.80 dBi max
- **RF Power** : 3.96 mW
- **Environmental of Tests** : Temperature: (28.9 ± 5.8) °C
Humidity: (61 ± 13) % R.H.
Atmospheric Pressure: (100.8 ± 0.1) kPa
- **FCC Rule Part(s)** : FCC Part 15 Subpart C
- **Test Procedure** : ANSI C63.10-2013
- **EQUIPMENT CLASS** : DTS (Part 15 Digital Transmission System)
- **Place of Tests** : ETL Inc. Testing Lab. (FCC Designation Number : KR0022)

Radiated Emission test 1;
#499-1, Sagot-ri, Seosin-myeon, Hwaseong-si,
Gyeonggi-do, 445-882, Korea

Radiated Emission test 2 and Conducted Emission test;
#371-51, Gasan-dong, Geumcheon-gu, Seoul, 153-803, Korea

1. INTRODUCTION

The measurement test for radiated and conducted emission test was conducted at the ETL Inc. The site is constructed in conformance with the requirements of the ANSI C63.10-2013 and CISPR Publication 16. The ETL has site descriptions on file with the FCC for 3 m and 10 m site configurations. Detailed description of test facility was found to be in compliance with FCC Rules according to the ANSI C63.10-2013 and registered to the Federal Communications Commission (FCC Designation Number : KR0022).

The measurement procedure described in American National Standard for Method of Measurement of Radio-Noise Emission from Low-Voltage Electrical and Electronic Equipment in the Range of 9 kHz to 40 GHz (ANSI C63.10-2013) was used in determining radiated and conducted emissions from the DSGLOBAL CO., LTD. Model: SNPRH-1603

2. PRODUCT INFORMATION

2.1 Equipment Description

The Equipment Under Test (EUT) is the HP Sprocket Photo Printer (model: SNPRH-1603).

The model SNPRH-1603 is basic model that was tested.

2.2 General Specification

Item	Specification
Paper size	50 mm x 76 mm
Type of supported image file / Size	PNG (2 550 x 3 300) JPEG (baseline) Within a maximum of 10 M Byte Progressive JPEG not supported
Paper used	ZINK Paper (for Pomini only)
Paper storage conditions	Temperature: (22.5 ± 2.5) °C
	Humidity: (47.5 ± 7.5) % R.H.
Product operating conditions	Temperature: (22.5 ± 17.5) °C
	Humidity: Less than 70 % (35 °C)
Optimal print conditions	Temperature: (23.5 ± 8.5) °C
	Humidity: Less than 70 % (32 °C)
LED display	Power on / Standby / Communication / Charge / Error / Print / Update
Communication	Bluetooth 4.0
External connection terminal	Micro USB port (charging only)
USB power supply	Rated DC 5 V / 1.0 A Adapter (optional)
Normal operating voltage	DC 8 V
Built-in battery	500 mAh Lithium-ion (rechargeable)
Proper image resolution	More than 1 280 pixel x 2 448 pixel
Weight	186 g
Support App version	Android: 4.0 or higher iOS: 5.1 or higher (Support may not be provided depending on the user's Smartphone version and environment.)
High Internal Frequency	Memory clock → 264 MHz

3. DESCRIPTION OF TESTS

The tests documented in this report were performed in accordance with ANSI C63.10-2013 and FCC CFR 47 2.1046, 2.1047, 2.1049, 2.1051, 2.1053, 2.1055, 2.1057, 15.207, 15.209 and 15.247.

3.1 Radiated Emission Measurement

Radiated emission measurements were made in accordance with § 13 in ANSI C63.10-2013 "Measurement of Intentional radiators" The measurements were performed over the frequency range of 30 MHz to 40 GHz using antenna as the input transducer to a Spectrum analyzer or a Field Intensity Meter. The measurements were made with the detector set for "Peak, Quasi-peak, Average" within a bandwidth of 120 kHz and above 1 GHz is 1 MHz.

Preliminary measurements were made at 3 m using broadband antennas, and spectrum analyzer to determine the frequency producing the maximum emission in shielded room. Appropriate precaution was taken to ensure that all emission from the EUT were maximized and investigated. The system configuration, mode of operation, turntable azimuth and height with respect to the antenna were noted for each frequency found. The spectrum was scanned from 30 MHz to 1 000 MHz using Log-Bicon antenna. Above 1 GHz, linearly polarized double ridge horn antennas were used. Final measurements were made open site or SVSWR chamber at 3 m. The test equipment was placed on a styrofoam table. Sufficient time for the EUT, support equipment, and test equipment was allowed in order for them to warm up to their normal operating condition. Each frequency found during pre-scan measurements was re-examined by manual. The EUT, support equipment and interconnecting cables were re-configured to the set-up producing the maximum emission for the frequency and were placed on top of a table height for below 1GHz is 0.8 m, and for above 1GHz is 1.5 m. nonmetallic 1.0 m x 1.5 m table. The EUT, support equipment, and interconnecting cables were re-arranged and manipulated to maximize each emission. The turntable containing the system was rotated; the antenna height was varied 1 m to 4 m and stopped at the azimuth or height producing the maximum emission.

Varying the mode of operating frequencies of the EUT maximized each emission. The system was tested in all the three orthogonal planes and changing the polarity of the antenna. The worst-case emissions are recorded in the data tables. If necessary, the radiated emission measurement could be performed at a closer distance to ensure higher accuracy and the results were extrapolated to the specified distance using an inverse linear distance extrapolation factor (20 dB/decade) as per section 15.31(f).

Photographs of the worst-case emission can be seen in Photographs of the worst-case emission test setup can be seen in Appendix B.

3.2 Conducted Emission Measurement

Conducted emissions measurements were made in accordance with section § 13 in ANSI C63.10-2013 "measurement of intentional radiators" The measurements were performed over the frequency range of 0.15 MHz to 30 MHz using a 50 Ω /50 μ H LISN as the input transducer to a Spectrum Analyzer or a Test Receiver. The measurements were made with the detector set for "Peak" amplitude within a bandwidth of 9 kHz or for "quasi-peak" within a bandwidth of 9 kHz.

The line-conducted emission test is conducted inside a shielded anechoic chamber room with 1 m x 1.5 m x 0.8 m wooden table which is placed 0.4 m away from the vertical wall and 1.5 m away from the side wall of the chamber room. Two LISN are bonded to the shielded room. The EUT is powered from the LISN and the support equipment is powered from the other LISN. Power to the LISNs are filtered by a noise cut power line filters. All electrical cables are shielded by braided tinned steel tubing with inner ϕ 1.2 cm. If the EUT is a DC-powered device, power will be derived from the source power supply it normally will be powered from and these supply lines will be connected to the LISN. Non-inductive bundling to a 1 m length shortened all interconnecting cables more than 1 m. Sufficient time for the EUT, support equipment, and test equipment was allowed in order for them to warm up to their normal operating condition. The RF output of the LISN was connected to the EMI Test Receiver to determine the frequency producing the maximum emission from the EUT. The frequency producing the maximum level was reexamined using to set Quasi-Peak mode by manual, after scanned by automatic Peak mode from 0.15 MHz to 30 MHz. The bandwidth of the spectrum analyzer was set to 9 kHz. The EUT, support equipment, and interconnecting cables were arranged and manipulated to maximize each emission.

Photographs of the worst-case emission can be seen in Photographs of the worst-case emission test setup can be seen in Appendix B.

3.3 FCC Part 15.205 Restricted Bands of Operations

(a) Except as shown in paragraph (d) of this section, only spurious emissions are permitted in any of the frequency bands listed below:

MHz	MHz	MHz	GHz
0.090 - 0.110	16.42 - 16.423	399.9 - 410	4.5 - 5.15
¹ 0.495 - 0.505	16.694 75 - 16.695 25	608 - 614	5.35 - 5.46
2.173 5 - 2.190 5	16.804 25 - 16.804 75	960 - 1 240	7.25 - 7.75
4.125 - 4.128	25.5 - 25.67	1 300 - 1 427	8.025 - 8.5
4.177 25 - 4.177 75	37.5 - 38.25	1 435 - 1 626.5	9.0 - 9.2
4.207 25 - 4.207 75	73 - 74.6	1 645.5 - 1 646.5	9.3 - 9.5
6.215 - 6.218	74.8 - 75.2	1 660 - 1 710	10.6 - 12.7
6.267 75 - 6.268 25	108 - 121.94	1 718.8 - 1 722.2	13.25 - 13.4
6.311 75 - 6.312 25	123 - 138	2 200 - 2 300	14.47 - 14.5
8.291 - 8.294	149.9 - 150.05	2 310 - 2 390	15.35 - 16.2
8.362 - 8.366	156.524 75 - 156.525 25	2 483.5 - 2 500	17.7 - 21.4
8.376 25 - 8.386 75	156.7 - 156.9	2 690 - 2 900	22.01 - 23.12
8.414 25 - 8.414 75	162.012 5 - 167.17	3 260 - 3 267	23.6 - 24.0
12.29 - 12.293	167.72 - 173.2	3 332 - 3 339	31.2 - 31.8
12.519 75 - 12.520 25	240 - 285	3 345.8 - 3 358	36.43 - 36.5
12.576 75 - 12.577 25	322 - 335.4	3 600 - 4 400	(²)
13.36 - 13.41			

¹ Until February 1, 1999, this restricted band shall be 0.490 MHz - 0.510 MHz.

² Above 38.6

(b) Except as provided in paragraphs (d) and (e), the field strength of emissions appearing within these frequency bands shall not exceed the limits shown in Section 15.209. At frequencies equal to or less than 1 000 MHz, compliance with the limits in Section 15.209 shall be demonstrated using measurement instrumentation employing a CISPR quasi-peak detector. Above 1 000 MHz, compliance with the emission limits in Section 15.209 shall be demonstrated based on the average value of the measured emissions. The provisions in Section 15.35 apply to these measurements.

3.4 Antenna connection requirement

(1) According to §15.203

An intentional radiator shall be designed to ensure that no antenna other than that furnished by the responsible party shall be used with the device. The use of a permanently attached antenna or of an antenna that uses a unique coupling to the intentional radiator shall be considered sufficient to comply with the provisions of this Section. The manufacturer may design the unit so that a broken antenna can be replaced by the user, but the use of a standard antenna jack or electrical connector is prohibited. This requirement does not apply to carrier current devices or to devices operated under the provisions of Sections 15.211, 15.213, 15.217, 15.219, or 15.221. Further, this requirement does not apply to intentional radiators that must be professionally installed, such as perimeter protection systems and some field disturbance sensors, or to other intentional radiators which, in accordance with Section 15.31(d), must be measured at the installation site. However, the installer shall be responsible for ensuring that the proper antenna is employed so that the limits in this Part are not exceeded.

4. TEST CONDITION

4.1 Test Configuration

The device was configured for testing in a typical fashion (as a customer would normally use it). During the tests, the following conditions and configurations were used.

* This test was applied to X, Y, Z. and the worst result were investigated and reported.

4.2 Description of Test modes

HP Sprocket Photo Printer that has the control software.

4.3 The setup drawing(s)

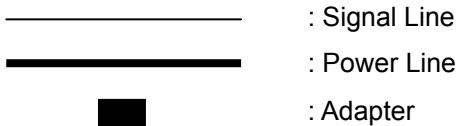
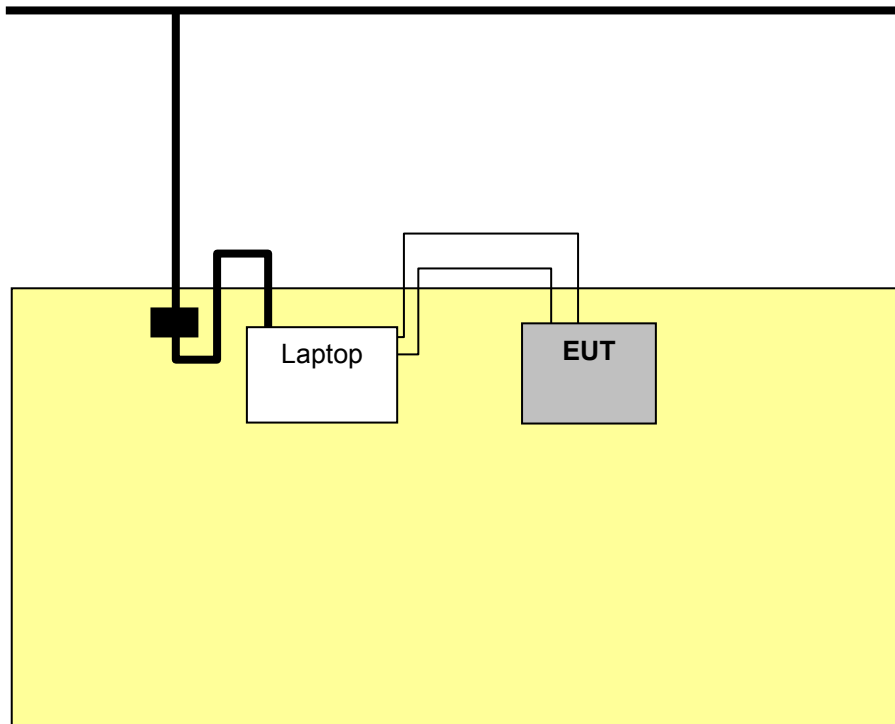

5. TEST RESULTS

5.1 Summary of Test Results

The measurement results were obtained with the EUT tested in the conditions described in this report. Detailed measurement data and plots showing the maximum emission of the EUT are reported.

47 CFR Part 15, Subpart C	Measurement Required	Result
15.247(a)(2)	6 dB Bandwidth	Pass
15.247(b)(3)	Maximum Peak Output Power	Pass
15.247(d)	Bandwidth of Frequency Band Edges	Pass
15.247(e)	Power Spectral Density	Pass
15.209(a)	Spurious Emissions	Pass
15.207	Conducted Emissions	Pass *
15.203	Antenna connection requirement	Integral antenna which is permanently attached and cannot be replaced.
1.1307(b)(1)	RF Exposure	Pass

** This test was tested at main host computer (EUT was connected USB port of the host computer).*

The data collected shows that the **DSGLOBAL CO., LTD. / HP Sprocket Photo Printer / SNPRH-1603** complied with technical requirements of above rules part 15.207, 209 and 15.247 Limits.

The equipment is not modified anything, mechanical or circuits to improve EMI status during a measurement. No EMI suppression device(s) was added and/or modified during testing.

5.2 6 dB Bandwidth

EUT	HP Sprocket Photo Printer / SNPRH-1603
Limit apply to	FCC Part 15.247(a)(2)
Test Date	August 13, 2016
Environmental of Test	(23.4 ± 0.0) °C, (48 ± 0) % R.H., (100.7 ± 0.0) kPa
Operating Condition	RF transmitting continuously during the tested.
Result	Passed

Limit

The maximum 6 dB bandwidth shall be at least 500 kHz.

Test Data

Frequency [MHz]	6 dB Bandwidth [kHz]	Limit
2 402	723	> 500 kHz
2 440	697	
2 480	697	

NOTES:

1. Measure frequency separation of relevant channel using spectrum analyzer.
2. RBW 100 kHz, VBW 300 kHz, Sweep 1s.
3. Please see the measured plot in next page.

Plots of 6 dB Bandwidth

[2 402 MHz]

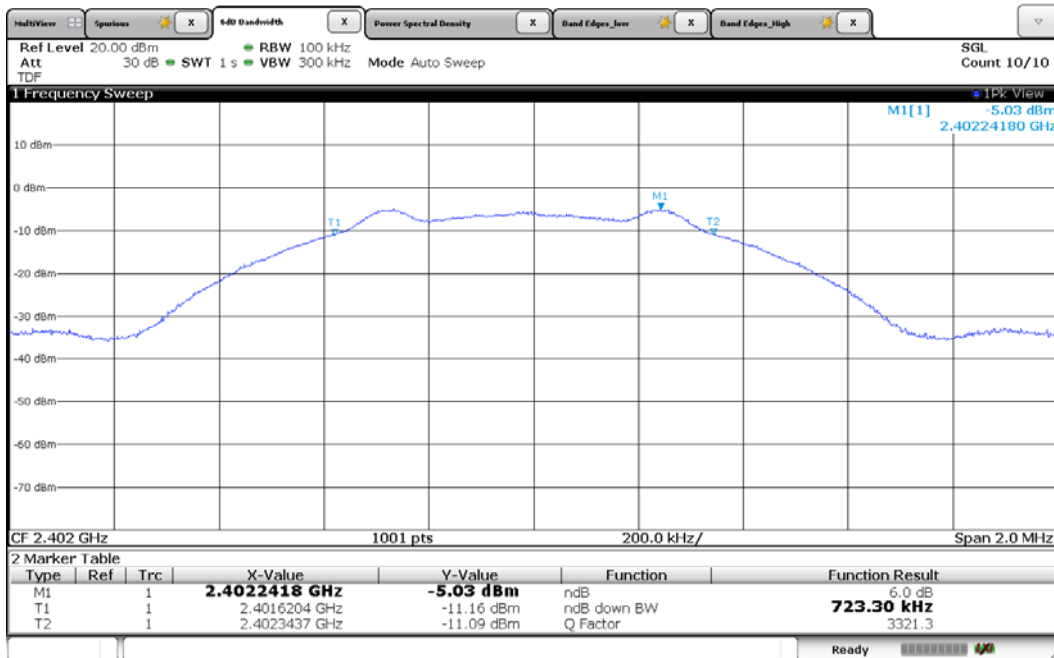

[2 440 MHz]

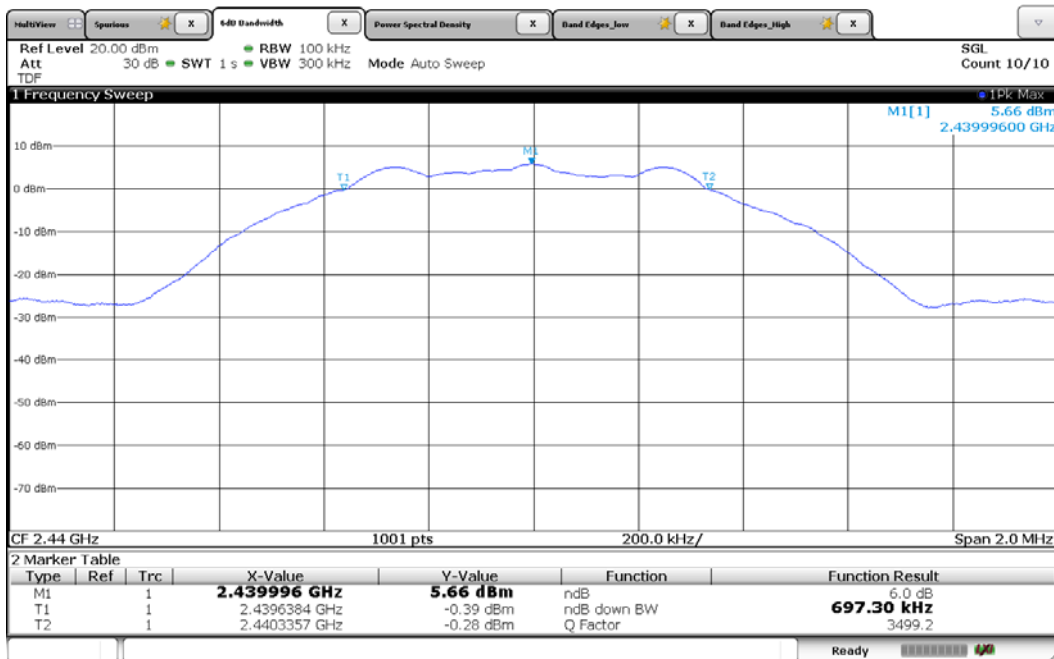

[2 480 MHz]

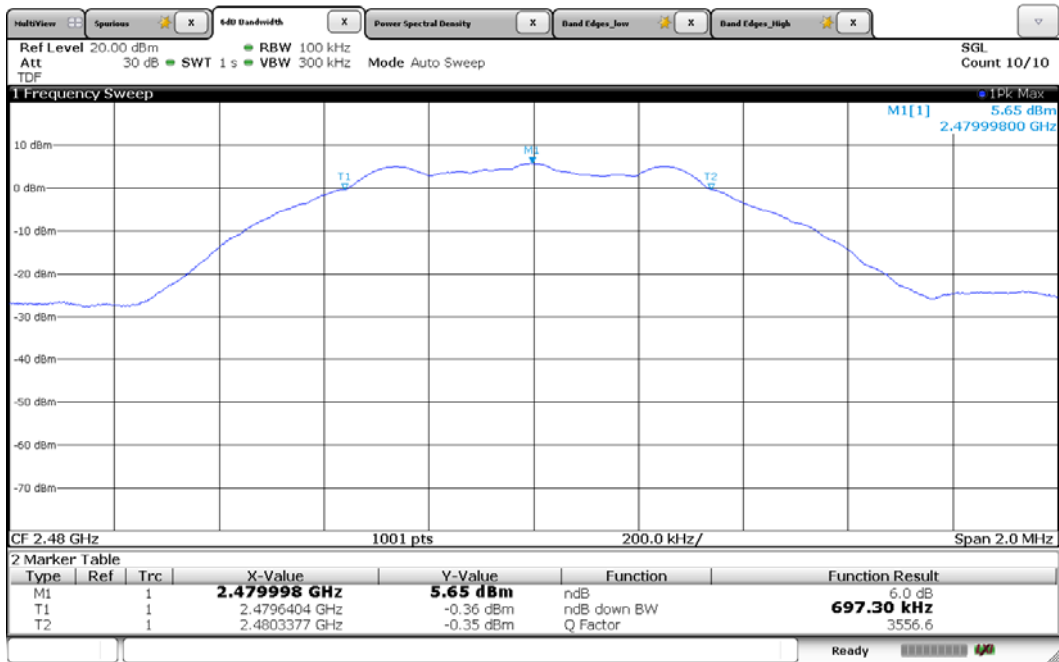

5.3 Maximum Peak Conducted Output Power

EUT	HP Sprocket Photo Printer / SNPRH-1603
Limit apply to	FCC Part 15.247(b)(3)
Test Date	August 13, 2016
Environmental of Test	(23.4 ± 0.0) °C, (48 ± 0) % R.H., (100.7 ± 0.0) kPa
Operating Condition	RF transmitting continuously during the tested.
Result	Passed

Limit

The maximum peak conducted output power of the intentional radiator shall not exceed the following:

For frequency hopping systems operating in the 2 400.0 MHz - 2 483.5 MHz band: 1 Watt

Test Data

Frequency [MHz]	Output Power [dBm]	Limit
2 402	4.95	< 30.00 dBm (1 W)
2 440	5.98	
2 480	5.97	

Plots of Output Power

[2 402 MHz]



[2 440 MHz]

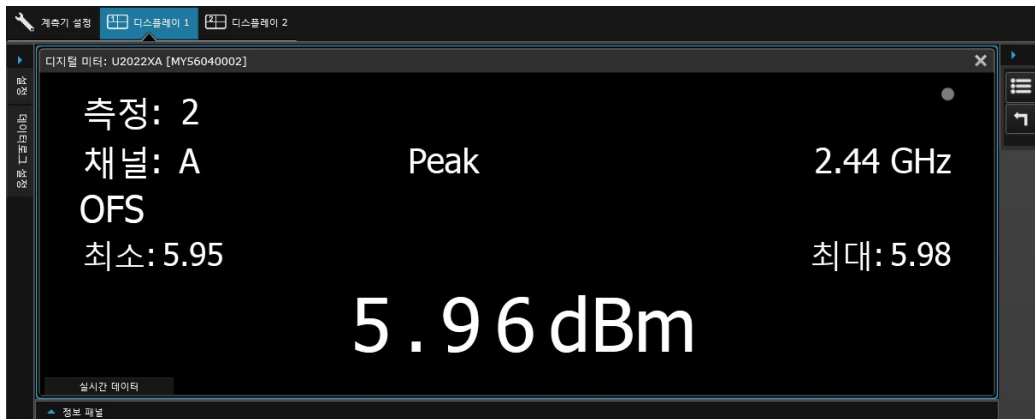

[2 480 MHz]

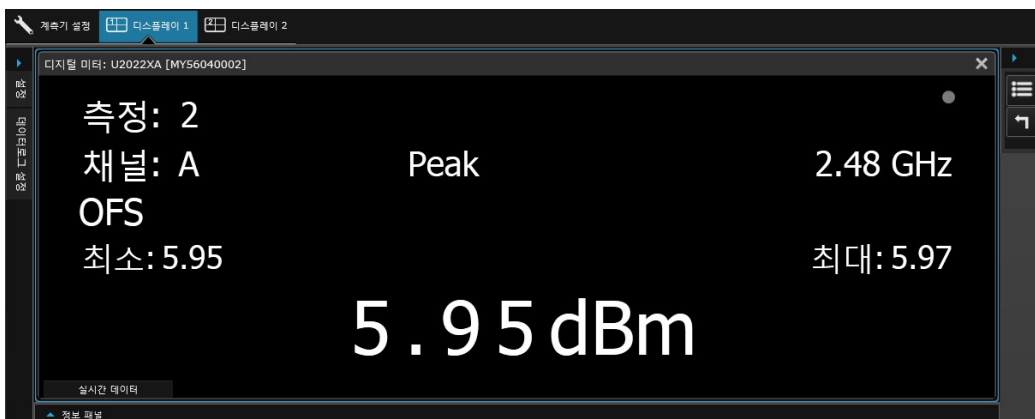

5.4 Bandwidth of Frequency Band Edges

EUT	HP Sprocket Photo Printer / SNPRH-1603
Limit apply to	FCC Part 15.247(d)
Test Date	August 05, 2016
Environmental of Test	(23.5 ± 0.2) °C, (48 ± 1) % R.H., (100.8 ± 0.0) kPa
Operating Condition	RF transmitting continuously during the tested.
Result	Passed

Limit

In any 100 kHz bandwidth outside the frequency band in which the spread spectrum or digitally modulated intentional radiator is operating, the radio frequency power that is produced by the intentional radiator shall be at least 20 dB below that in the 100 kHz bandwidth within the band that contains the highest level of the desired power, based on either an RF conducted or a radiated measurement, provided the transmitter demonstrates compliance with the peak conducted power limits. If the transmitter complies with the conducted power limits based on the use of RMS averaging over a time interval, as permitted under paragraph (b)(3) of this section, the attenuation required under this paragraph shall be 30 dB instead of 20 dB. Attenuation below the general limits specified in Section 15.209(a) is not required. In addition, radiated emissions which fall in the restricted bands, as defined in Section 15.205(a), must also comply with the radiated emission limits specified in Section 15.209(a) (see Section 15.205(c)).

Test Results

- Refer to see the measured plot in next page.

NOTES:

1. The test was performed to make a direct field strength measurement at the band edge frequencies.

Plots of Bandwidth of Frequency Band Edges

Conducted

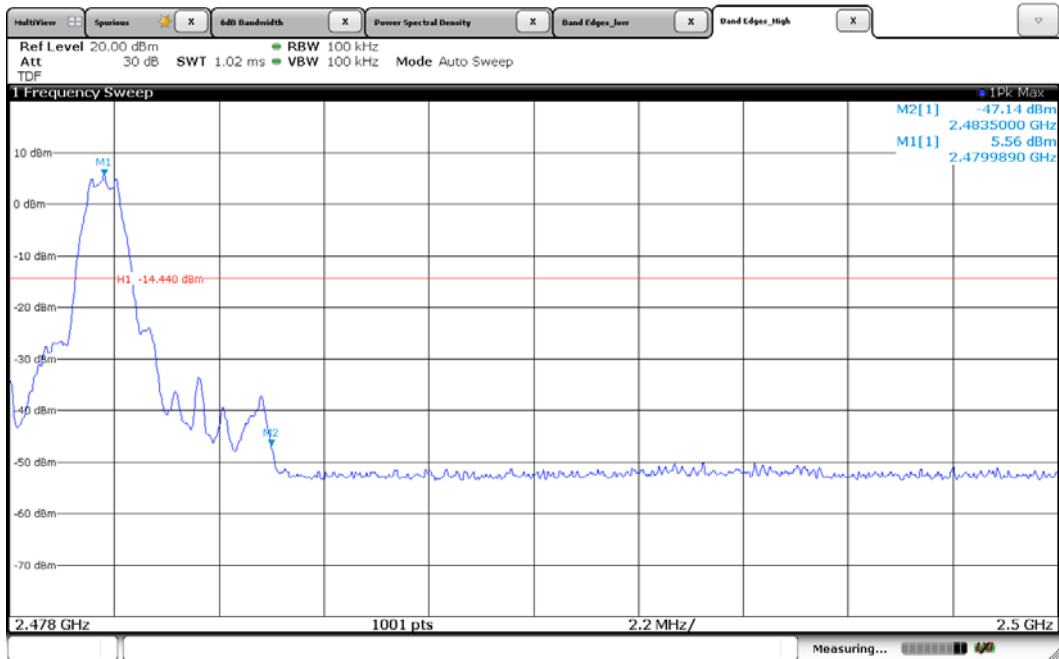
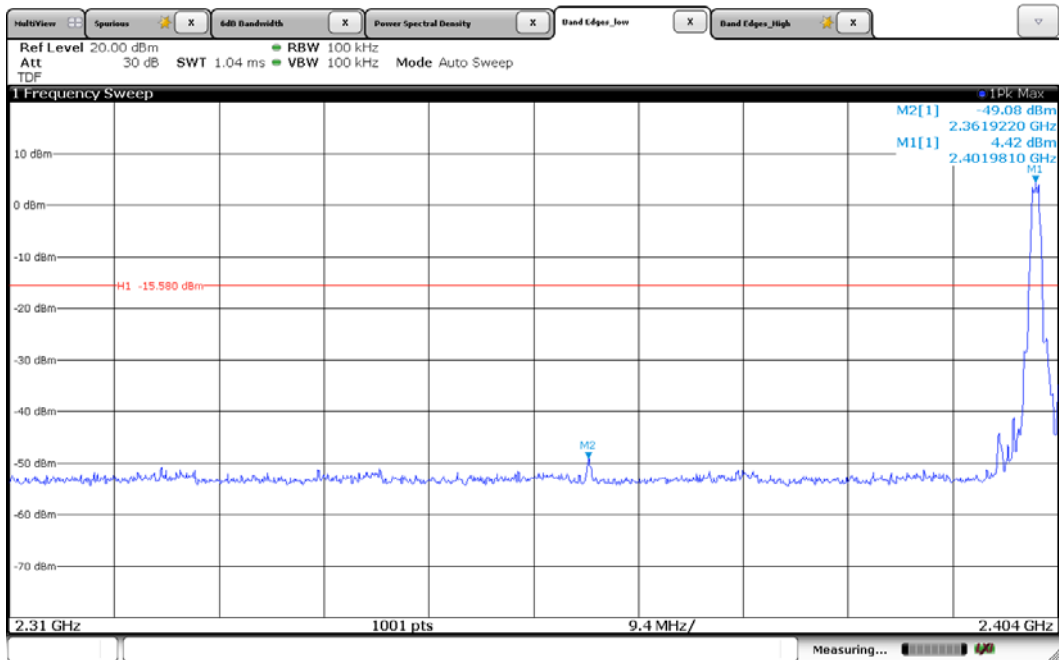

Radiated

Peak Detector: RBW: 1 MHz, VBW: 1 MHz (2 310 MHz - 2 390 MHz), Worst case (Low, Horizontal)

— Peak Limit Line
— AV Limit Line

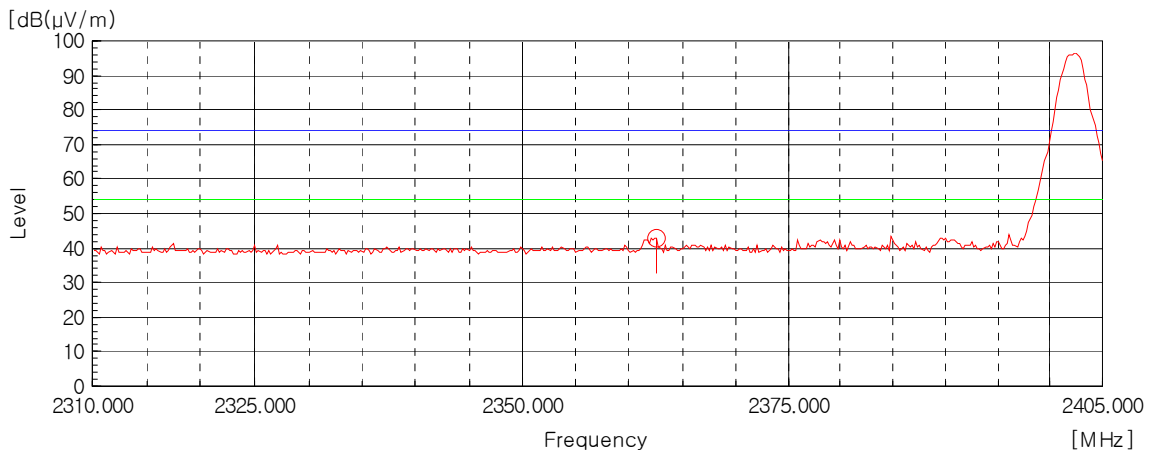

AV Detector: RBW: 1 MHz, VBW: 10 Hz (2 310 MHz - 2 390 MHz), Worst case (Low, Horizontal)

— Peak Limit Line
— AV Limit Line

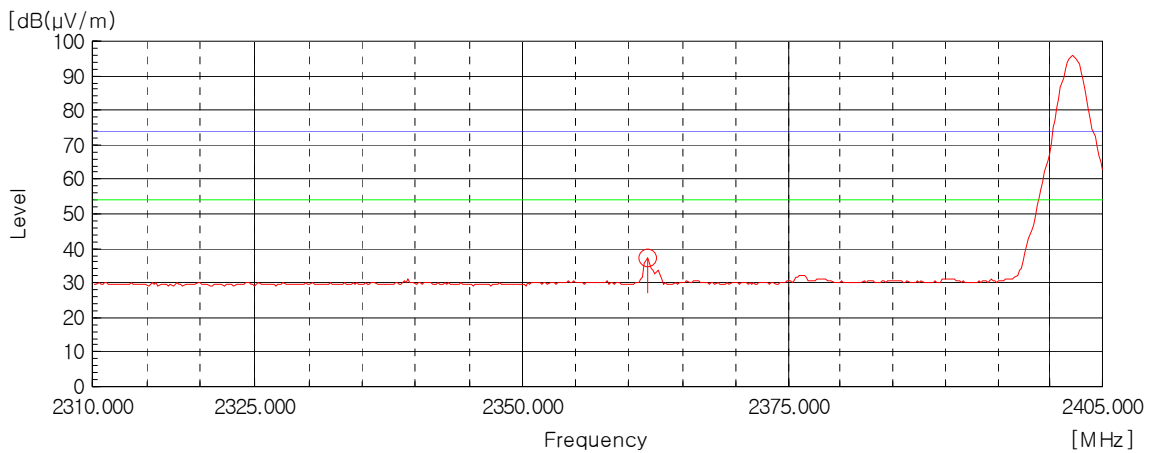

Peak Detector: RBW: 1 MHz, VBW: 1 MHz (2 483.5 MHz - 2 500 MHz), Worst case (High, Horizontal)

— Peak Limit Line
— AV Limit Line

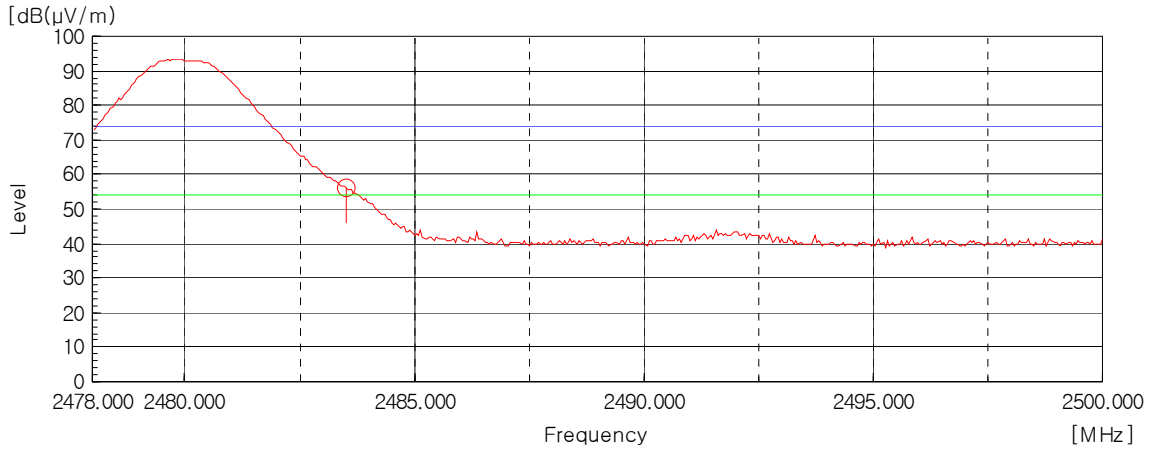

AV Detector: RBW: 1 MHz, VBW: 10 Hz (2 483.5 MHz - 2 500 MHz), Worst case (High, Horizontal)

— Peak Limit Line
— AV Limit Line

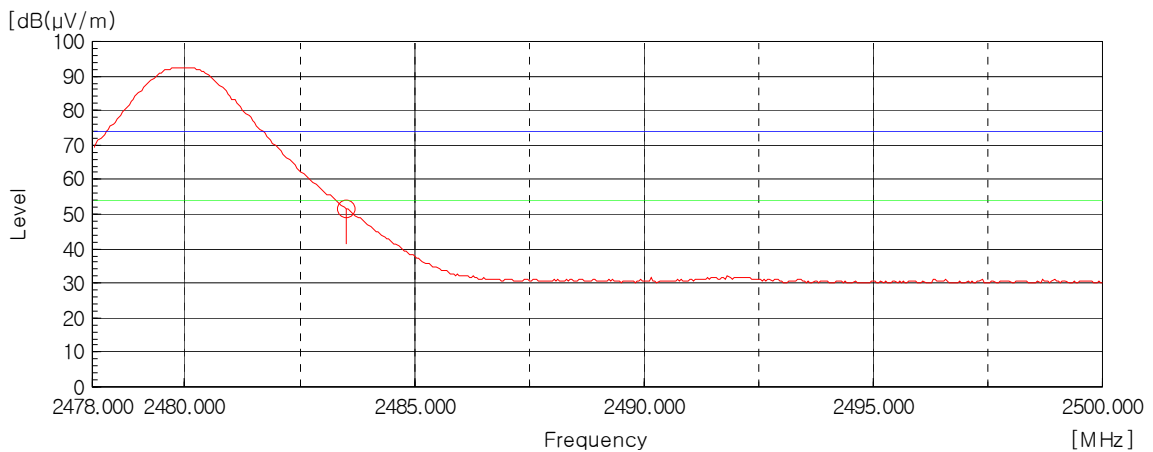

5.5 Power Spectral Density

EUT	HP Sprocket Photo Printer / SNPRH-1603
Limit apply to	FCC Part 15.247(e)
Test Date	August 13, 2016
Environmental of Test	(23.4 ± 0.0) °C, (48 ± 0) % R.H., (100.7 ± 0.0) kPa
Operating Condition	RF transmitting continuously during the tested.
Result	Passed

Limit

For digitally modulated systems, the power spectral density conducted from the intentional radiator to the antenna shall not be greater than 8 dBm in any 3 kHz band during any time interval of continuous transmission. This power spectral density shall be determined in accordance with the provisions of paragraph (b) of this section. The same method of determining the conducted output power shall be used to determine the power spectral density.

Test Data

Frequency [MHz]	PSD [dBm]	Limit
2 402	-14.20	8.00 dBm
2 440	-15.28	
2 480	-15.57	

NOTES:

1. Measure power spectral density of relevant channel using spectrum analyzer.
2. RBW 3 kHz, VBW 10 kHz, span(=6 dB bandwidth x 1.5), Sweep time (= auto couple).
3. Please see the measured plot in next page.

Plots of Power Spectral Density

[2 402 MHz]

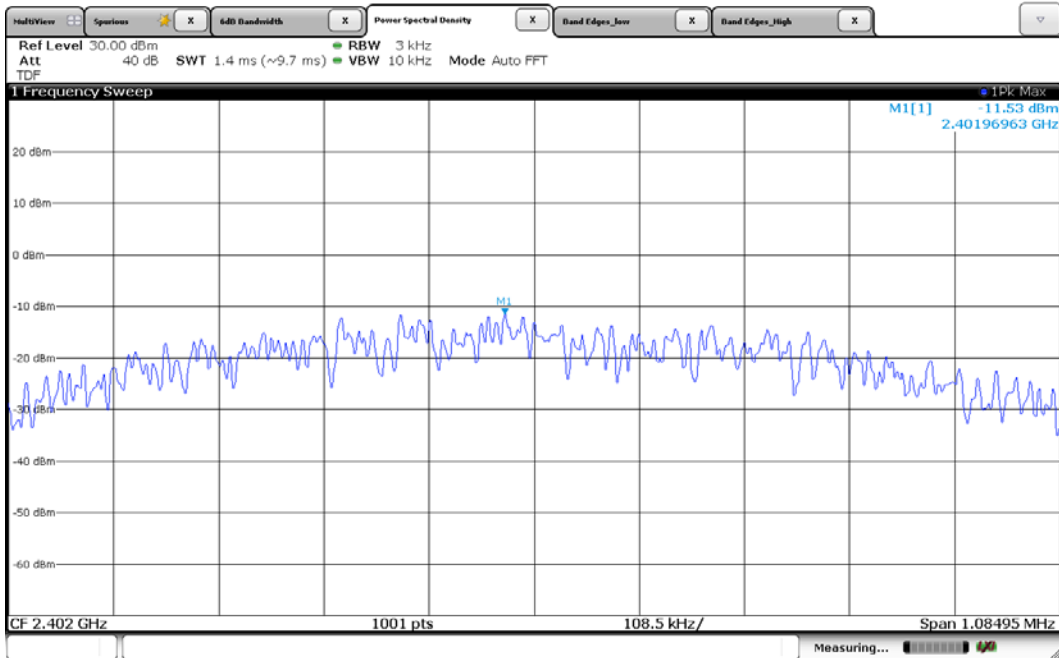

[2 440 MHz]

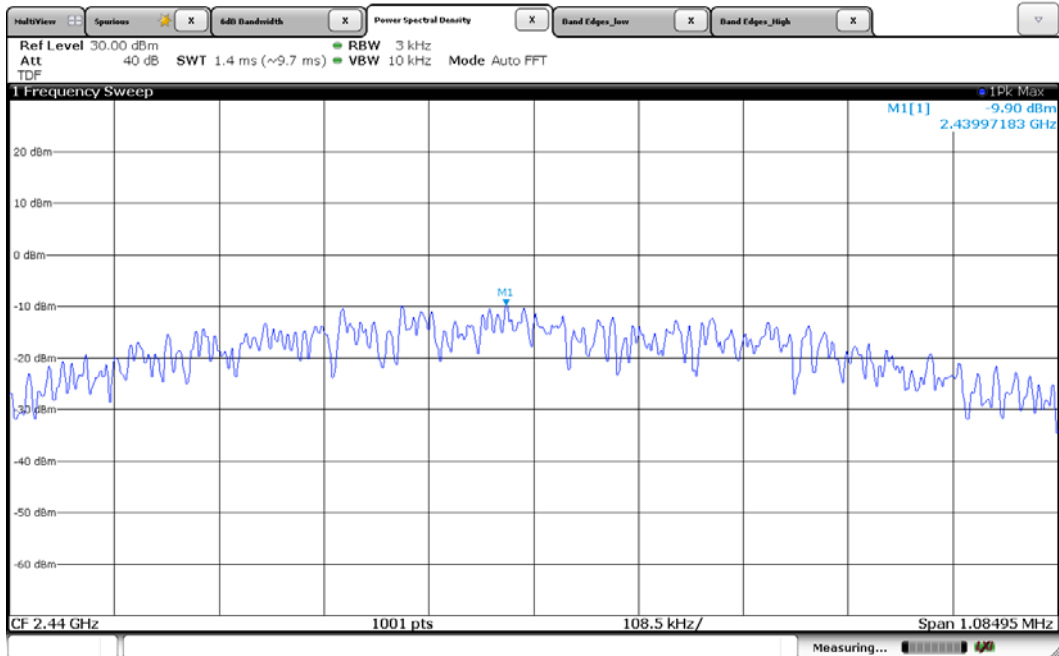

[2 480 MHz]

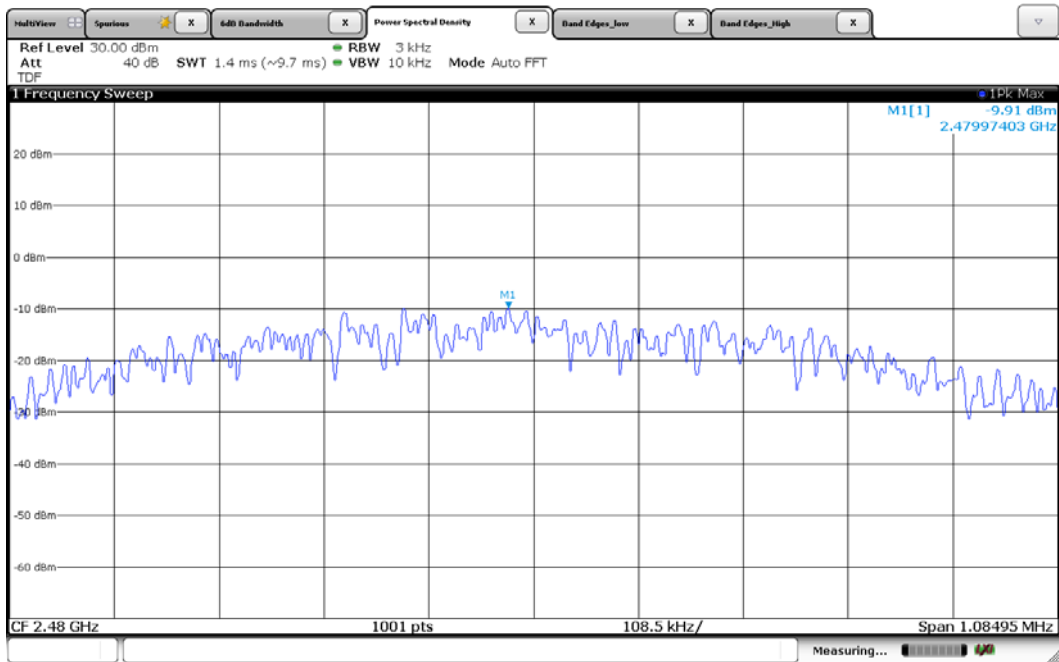

5.6 Spurious Emissions

EUT	HP Sprocket Photo Printer / SNPRH-1603
Limit apply to	FCC Part 15.209
Operating Condition	Low CH, Middle CH, High CH Transmission
Result	Passed

Limit

Except as provided elsewhere in this Subpart, the emissions from an intentional radiator shall not exceed the field strength levels specified in the following table:

Frequencies [MHz]	Field Strength [μ V/m]	Measurement Distance [m]
0.009 - 0.490	2 400/F(kHz)	300
0.490 - 1.705	24 000/F(kHz)	30
1.705 - 30.0	30	30
30 - 88	100	3
88 - 216	150	3
216 - 960	200	3
Above 960	500	3

* Except as provided in paragraph (g), fundamental emissions from intentional radiators operating under this Section shall not be located in the frequency bands 54 MHz - 72 MHz, 76 MHz - 88 MHz, 174 MHz - 216 MHz or 470 MHz - 806 MHz. However, operation within these frequency bands is permitted under other sections of this Part, e.g., Sections 15.231 and 15.241.

Test Results

- Refer to see the measured plot in next page.

Radiated Emissions Test data

- 9 kHz to 30 MHz

Test Date	August 12, 2016
Environmental of Test	(34.3 ± 0.3) °C, (72 ± 1) % R.H., (100.8 ± 0.0) kPa

The following table shows the highest levels of radiated emissions on both polarizations of horizontal and vertical. Detector mode: CISPR Quasi-Peak mode (100 Hz, 9 kHz)

Frequency [MHz]	Reading [dB(μV)]	Polarization (*H/**V)	Ant. Factor [dB/m]	Cable Loss [dB]	Result [dB(μV/m)]	Limit [dB(μV/m)]	Margin [dB]
	Emission attenuated more than 20 dB below the limit are not reported.						

Result: All emissions below noise floor of 20 dB(μV/m).

NOTES:

- * H : Horizontal polarization , ** V : Vertical polarization
- Result = Reading + Antenna factor + Cable loss
- Margin = Limit - Result
- The measurement was performed for the frequency range 9 kHz to 30 MHz according to FCC Part 15.209.

- Below 1 GHz (30 MHz to 1 GHz)

Test Date	August 12, 2016
Environmental of Test	(34.4 ± 0.1) °C, (69 ± 0) % R.H., (100.7 ± 0.0) kPa

The following table shows the highest levels of radiated emissions on both polarizations of horizontal and vertical. Detector mode: CISPR Quasi-Peak mode (6 dB Bandwidth: 120 kHz)

Frequency [MHz]	Reading [dB(μV)]	Polarization (*H/**V)	Ant. Factor [dB/m]	Cable+AMP [dB]	Height [cm]	Result [dB(μV/m)]	Limit [dB(μV/m)]	Margin [dB]
43.64	49.80	V	13.06	-30.72	107	32.14	40.00	7.86
53.18	48.30	V	12.95	-30.56	110	30.69	40.00	9.31
132.26	48.00	H	11.49	-29.69	370	29.80	43.50	13.70
149.31	51.10	H	12.83	-29.55	375	34.38	43.50	9.12
156.12	53.50	H	13.13	-29.48	376	37.15	43.50	6.35
168.40	50.80	V	12.48	-29.31	133	33.97	43.50	9.53

NOTES:

- * H : Horizontal polarization , ** V : Vertical polarization
- Result = Reading + Antenna factor + Cable loss
- Margin value = Limit - Result
- The measurement was performed for the frequency range above 30 MHz according to FCC Part 15.209.

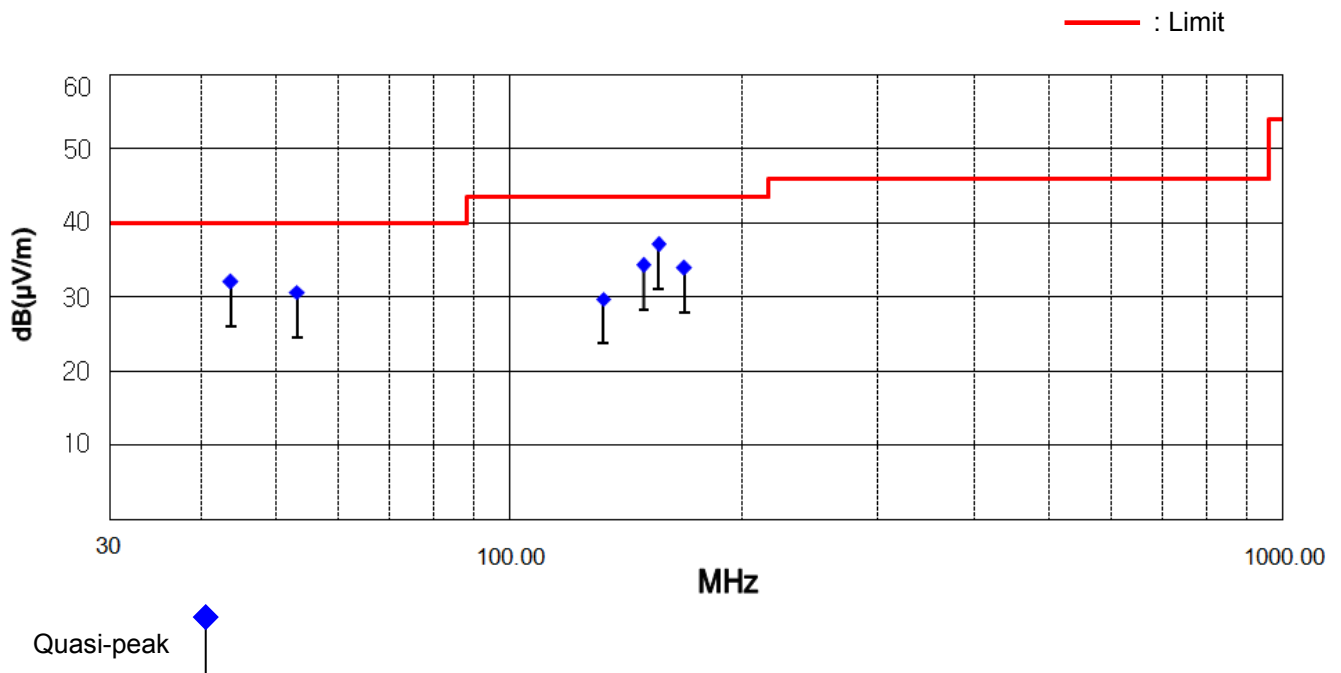

- Above 1 GHz (1 GHz to 25 GHz)

Test Date	August 05, 2016
Environmental of Test	(23.6 ± 0.3) °C, (49 ± 0) % R.H., (100.8 ± 0.0) kPa

1. Low CH (2 402 MHz)

Frequency [MHz]	Reading [dB(μV)]		Polarity (*H/**V)	Ant. Factor [dB/m]	Cable Loss [dB]	Result [dB(μV/m)]		Limit [dB(μV/m)]		Margin [dB]	
	Peak	Average				Peak	Average	Peak	Average	Peak	Average
1 593.88	54.62	38.22	H	25.73	-37.95	42.40	26.00	73.97	53.97	31.57	27.97
1 985.76	53.96	39.46	V	26.16	-37.22	42.90	28.40	73.97	53.97	31.07	25.57
2 559.44	53.19	45.49	V	27.54	-35.73	45.00	37.30	73.97	53.97	28.97	16.67
2 850.32	53.39	49.79	V	28.27	-35.46	46.20	42.60	73.97	53.97	27.77	11.37
3 003.84	58.58	56.08	V	28.65	-35.33	51.90	49.40	73.97	53.97	22.07	4.57
4 805.88	55.74	43.14	H	31.81	-34.65	52.90	40.30	73.97	53.97	21.07	13.67

2. Middle CH (2 440 MHz)

Frequency [MHz]	Reading [dB(μV)]		Polarity (*H/**V)	Ant. Factor [dB/m]	Cable Loss [dB]	Result [dB(μV/m)]		Limit [dB(μV/m)]		Margin [dB]	
	Peak	Average				Peak	Average	Peak	Average	Peak	Average
1 585.80	54.54	38.54	V	25.72	-37.96	42.30	26.30	73.97	53.97	31.67	27.67
1 981.72	53.46	39.66	V	26.16	-37.22	42.40	28.60	73.97	53.97	31.57	25.37
2 551.36	52.92	47.92	V	27.52	-35.74	44.70	39.70	73.97	53.97	29.27	14.27
2 854.36	53.68	47.88	V	28.28	-35.46	46.50	40.70	73.97	53.97	27.47	13.27
3 000.00	58.47	56.07	V	28.65	-35.32	51.80	49.40	73.97	53.97	22.17	4.57
3 296.94	53.17	48.97	V	28.74	-35.81	46.10	41.90	73.97	53.97	27.87	12.07

3. High CH (2 480 MHz)

Frequency [MHz]	Reading [dB(μV)]		Polarity (*H/**V)	Ant. Factor [dB/m]	Cable Loss [dB]	Result [dB(μV/m)]		Limit [dB(μV/m)]		Margin [dB]	
	Peak	Average				Peak	Average	Peak	Average	Peak	Average
1 589.84	54.83	38.63	V	25.72	-37.95	42.60	26.40	73.97	53.97	31.37	27.57
1 662.56	52.72	37.52	V	25.80	-37.82	40.70	25.50	73.97	53.97	33.27	28.47
1 985.76	53.56	38.86	V	26.16	-37.22	42.50	27.80	73.97	53.97	31.47	26.17
2 482.68	54.59	42.69	H	27.35	-35.84	46.10	34.20	73.97	53.97	27.87	19.77
2 854.36	53.58	50.68	V	28.28	-35.46	46.40	43.50	73.97	53.97	27.57	10.47
3 003.84	58.78	54.28	V	28.65	-35.33	52.10	47.60	73.97	53.97	21.87	6.37

NOTES:

1. * H : Horizontal polarization , ** V : Vertical polarization
2. Factor = Antenna factor + Cable loss + Preamp
3. Result = Reading + Factor
4. Margin = Limit - Result
5. Measuring frequencies from 1GHz to the 10th harmonic of highest fundamental frequency.
6. Measurements above show only up to 6 maximum emissions noted, or would be lesser if no specific emissions from the EUT are recorded (ie: margin > 20 dB from the applicable limit) and considered that's already beyond the background noise floor.
7. Spectrum setting:
 - a. Peak Setting 1 GHz to 10th harmonics of fundamental, RBW = 1 MHz, VBW = 1 MHz, Sweep = Auto
 - b. AV Setting 1 GHz to 10th harmonics of fundamental, RBW = 1 MHz, VBW = 10 kHz, Sweep = Auto

Test Date	August 13, 2016
Environmental of Test	(23.5 ± 0.0) °C, (48 ± 0) % R.H., (100.7 ± 0.0) kPa

Plots of Spurious Emissions (Conducted Measurement)

[CH Low]

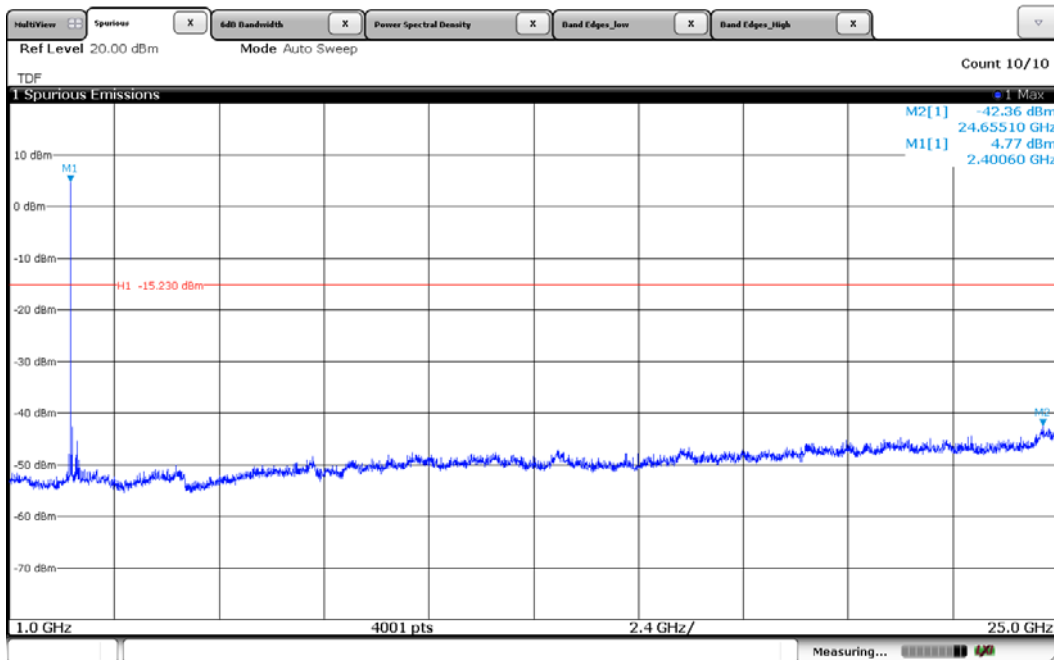
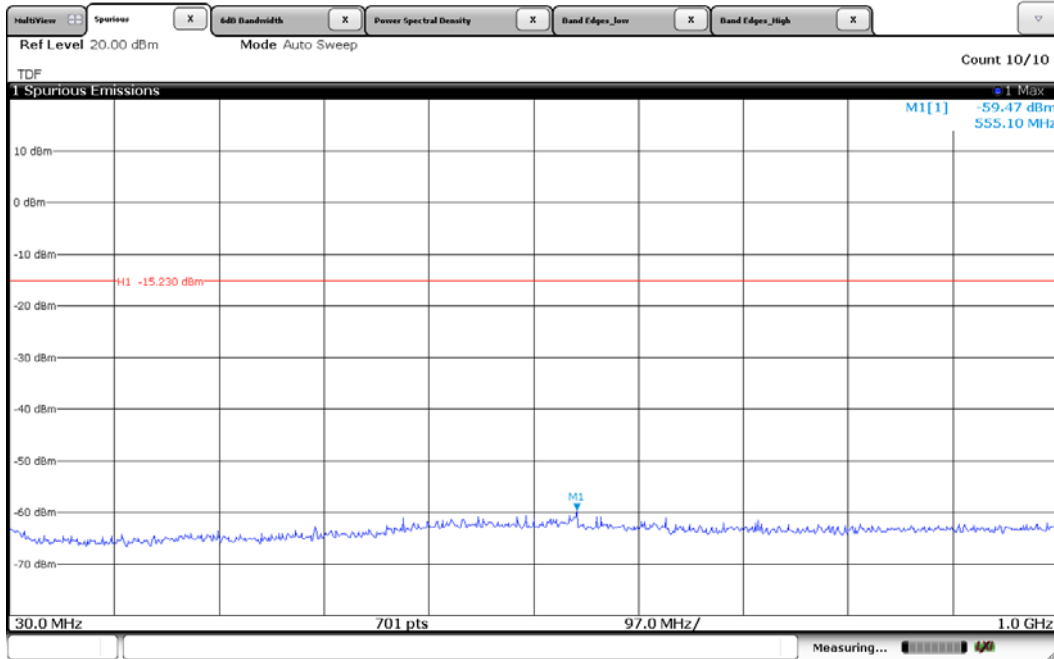

[CH Mid]

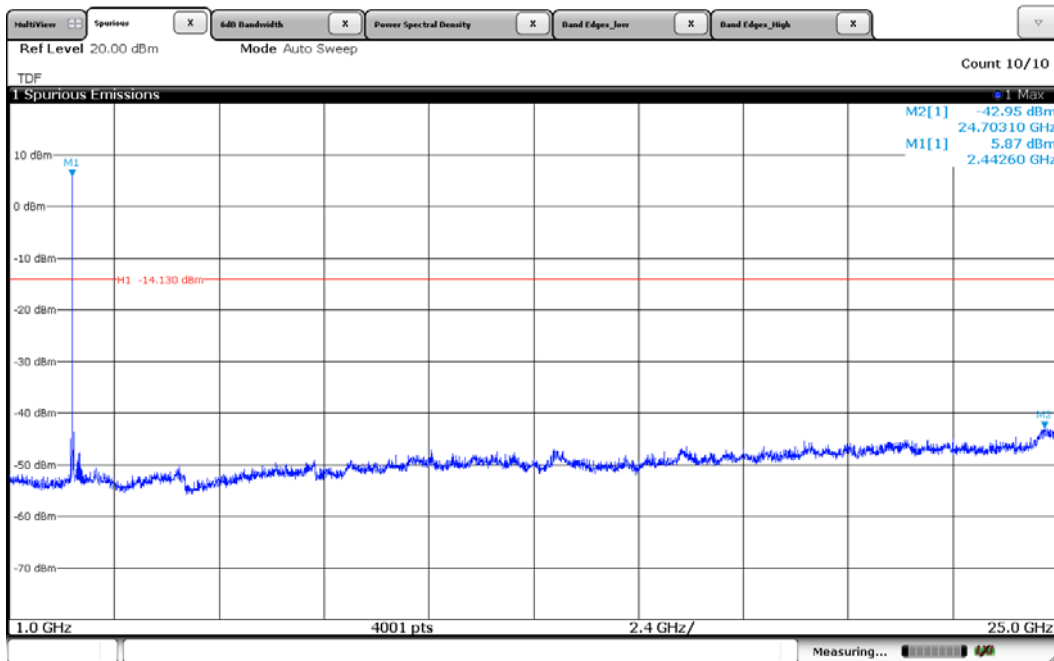
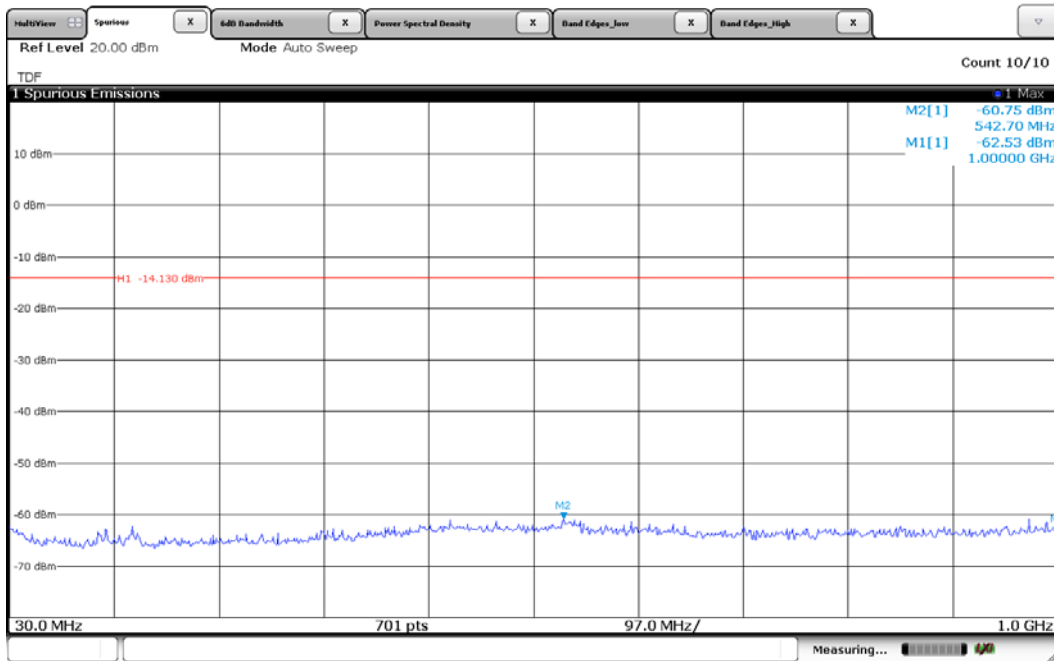

[CH High]

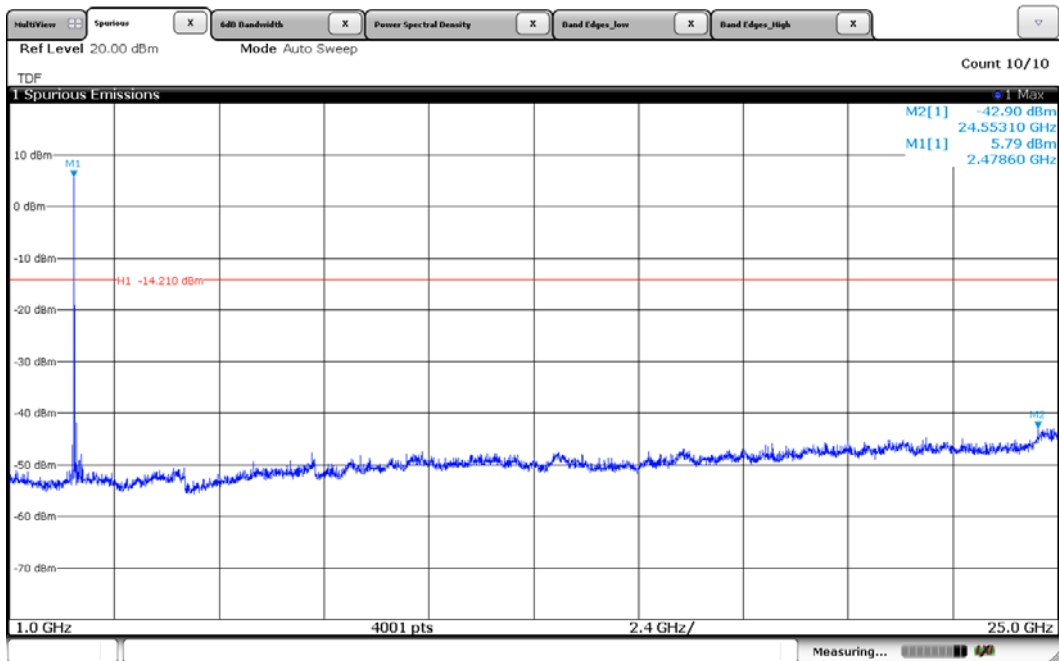
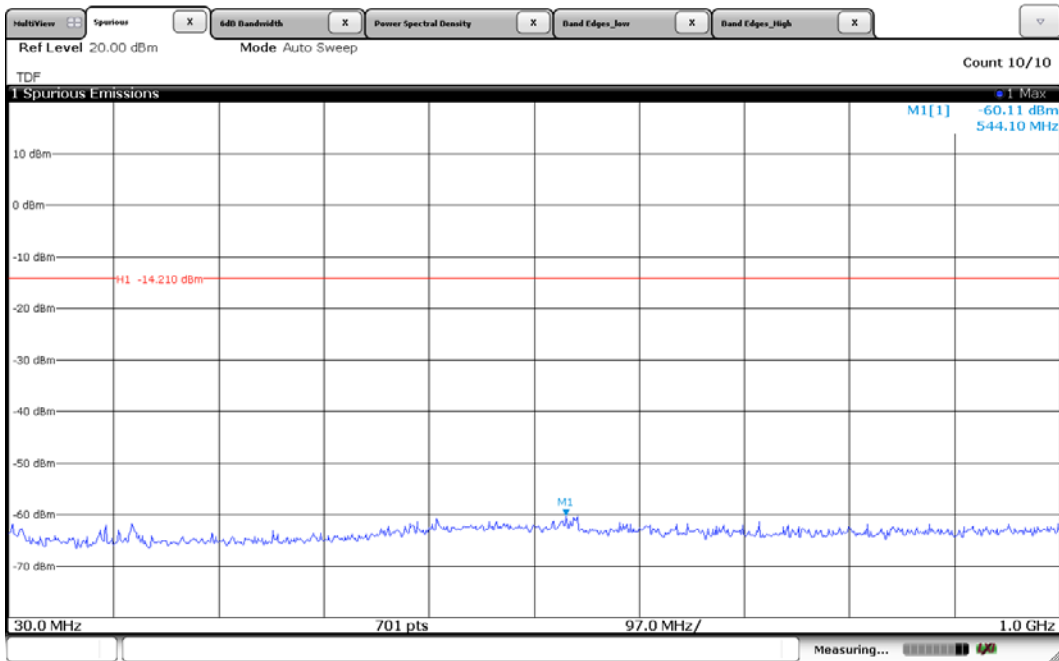

5.7 Conducted Emissions Measurement

EUT	HP Sprocket Photo Printer / SNPRH-1603
Limit apply to	FCC Part 15.207
Test Date	August 03, 2016
Environmental of Test	(23.1 ± 0.0) °C, (51 ± 0) % R.H., (100.8 ± 0.0) kPa
Operating Condition	RF transmitting continuously during the tested.
Result	Passed by 4.95 dB

Limit

For an intentional radiator that is designed to be connected to the public utility (AC) power line, the radio frequency voltage that is conducted back onto the AC power line on any frequency or frequencies within the band 150 kHz to 30 MHz shall not exceed the limits in the following table, as measured using a 50 μH/50 ohms line impedance stabilization network (LISN). Compliance with the provisions of this paragraph shall be based on the measurement of the radio frequency voltage between each power line and ground at the power terminal. The lower limit applies at the boundary between the frequencies ranges.

Frequency of Emission [MHz]	Conducted limit [dB(μV)]	
	Quasi-peak	Average
0.15 - 0.5	66 to 56 *	56 to 46 *
0.5 - 5	56	46
5 - 30	60	50

* Decreases with the logarithm of the frequency.

Test Results

- Refer to see the measured plot in next page.

Conducted Emission Test Data

The following data and graph shows the highest levels of conducted emissions on both polarizations of hot and neutral line.

Detector mode: CISPR Quasi-Peak mode (6 dB Bandwidth: 9 kHz)

NOTES:

1. Please see the measured data and graph in next page.
2. The Level (Result) value was included the reading, LISN factor and cable loss.
3. Delta (Margin) value = Limit - Level (Result)
4. Measurement were performed at the AC Power Inlet in the frequency band of 150 kHz ~ 30 MHz according to the FCC Part 15.207.
5. If the Quasi-Peak limit is met when using a Peak detector receiver, the EUT shall be deemed to meet both limits and measurement with the Quasi-Peak detector receiver is unnecessary.
6. If the average limit is met when using a Quasi-peak detector receiver, the EUT shall be deemed to meet both limits and measurement with the average detector receiver is unnecessary.

Line: HOT

ETL EMC Laboratory
 Conducted Emission Test Result

EUT: ETLT160803.0089
 Manuf:
 Op Cond:
 Operator:
 Test Spec:
 Comment: HOT

Prescan Measurement:	Detectors:	X PK / + AV
	Meas Time:	see scan settings
	Peaks:	16
	Acc Margin:	10 dB

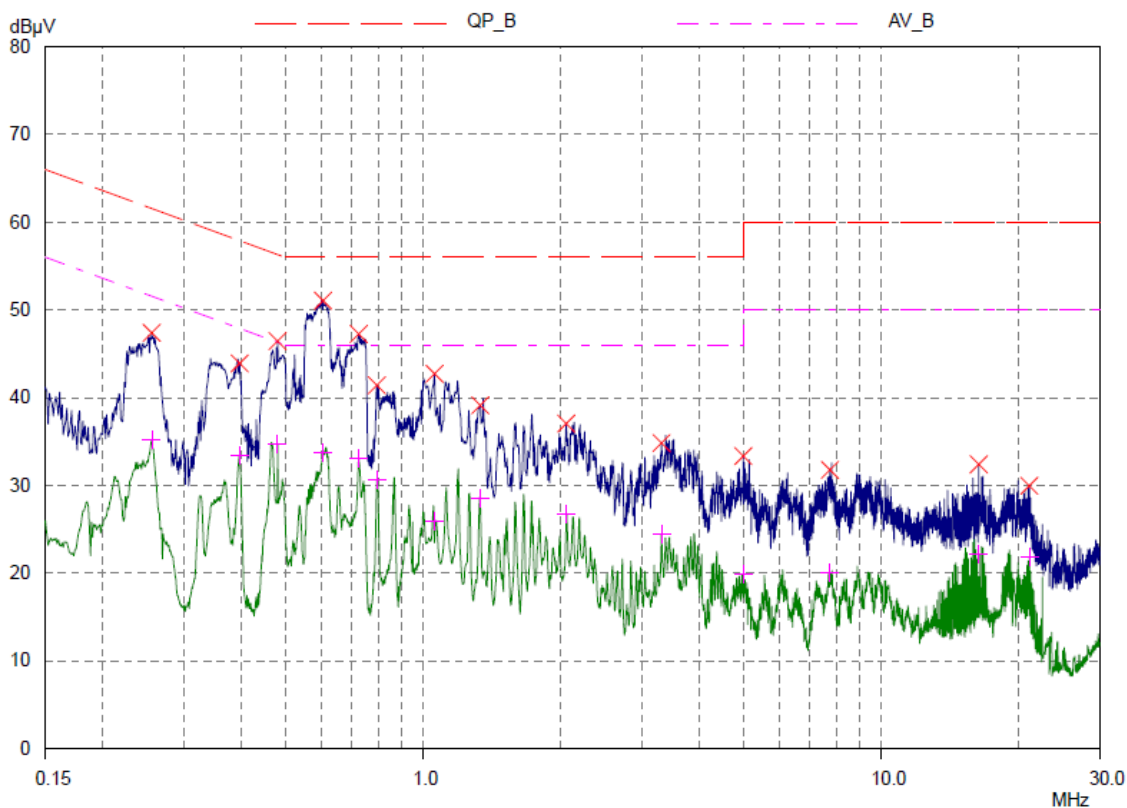

ETL EMC Laboratory

Conducted Emission Test Result

EUT: ETLT160803.0089
 Manuf:
 Op Cond:
 Operator:
 Test Spec:
 Comment: HOT

Prescan Measurement: Detectors: X PK / + AV
 Meas Time: see scan settings
 Peaks: 16
 Acc Margin: 10 dB

Peak Search Results

Frequency MHz	PK Level dBμV	PK Limit dBμV	PK Delta dB
0.256	47.38	61.56	14.18
0.398	43.90	57.90	14.00
0.482	46.45	56.30	9.85
0.606	51.05	56.00	4.95
0.724	47.26	56.00	8.74
0.793	41.41	56.00	14.59
1.06	42.72	56.00	13.28
1.335	39.14	56.00	16.86
2.055	37.05	56.00	18.95
3.32	34.83	56.00	21.17
5.005	33.32	60.00	26.68
7.74	31.75	60.00	28.25
16.35	32.38	60.00	27.62
21.1	29.96	60.00	30.04

Frequency MHz	AV Level dBμV	AV Limit dBμV	AV Delta dB
0.256	35.16	51.56	16.40
0.398	33.36	47.90	14.54
0.482	34.75	46.30	11.55
0.606	33.78	46.00	12.22
0.724	33.14	46.00	12.86
0.793	30.65	46.00	15.35
1.06	25.87	46.00	20.13
1.335	28.59	46.00	17.41
2.055	26.79	46.00	19.21
3.32	24.47	46.00	21.53
5.005	19.81	50.00	30.19
7.74	20.06	50.00	29.94
16.35	22.10	50.00	27.90
21.1	21.78	50.00	28.22

* limit exceeded

Line: Neutral

ETL EMC Laboratory
Conducted Emission Test Result

EUT: ETLT160803.0089
 Manuf:
 Op Cond:
 Operator:
 Test Spec:
 Comment: N

Prescan Measurement:	Detectors:	X PK / + AV
	Meas Time:	see scan settings
	Peaks:	16
	Acc Margin:	10 dB

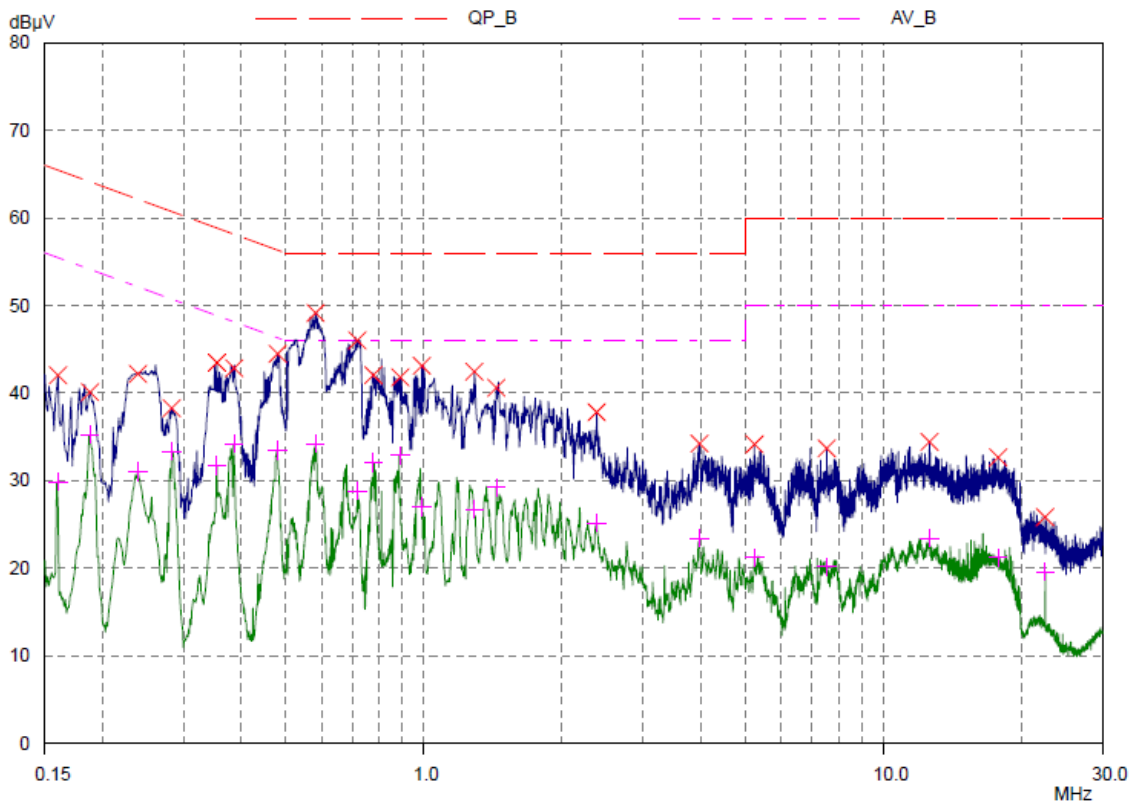

ETL EMC Laboratory

Conducted Emission Test Result

EUT: ETLT160803.0089
 Manuf:
 Op Cond:
 Operator:
 Test Spec:
 Comment: N

Prescan Measurement: Detectors: X PK / + AV
 Meas Time: see scan settings
 Peaks: 16
 Acc Margin: 10 dB

Peak Search Results

Frequency MHz	PK Level dBμV	PK Limit dBμV	PK Delta dB
0.16	42.03	65.46	23.43
0.188	40.10	64.12	24.02
0.239	42.18	62.13	19.95
0.283	38.28	60.73	22.45
0.355	43.48	58.84	15.36
0.387	42.84	58.13	15.29
0.481	44.49	56.32	11.83
0.582	49.14	56.00	6.86
0.718	46.01	56.00	9.99
0.777	42.05	56.00	13.95
0.889	41.79	56.00	14.21
0.991	43.11	56.00	12.89
1.29	42.45	56.00	13.55
1.44	40.59	56.00	15.41
2.38	37.82	56.00	18.18
3.985	34.23	56.00	21.77
5.245	34.14	60.00	25.86
7.535	33.69	60.00	26.31
12.61	34.42	60.00	25.58
17.8	32.66	60.00	27.34
22.53	25.83	60.00	34.17

Frequency MHz	AV Level dBμV	AV Limit dBμV	AV Delta dB
0.16	29.84	55.46	25.62
0.188	35.26	54.12	18.86
0.239	31.01	52.13	21.12
0.283	33.35	50.73	17.38
0.355	31.71	48.84	17.13
0.387	34.18	48.13	13.95
0.481	33.46	46.32	12.86

* limit exceeded

Peak Search Results (continued)

Frequency MHz	AV Level dBµV	AV Limit dBµV	AV Delta dB
0.582	34.23	46.00	11.77
0.718	28.81	46.00	17.19
0.777	32.08	46.00	13.92
0.889	32.89	46.00	13.11
0.991	27.03	46.00	18.97
1.29	26.70	46.00	19.30
1.44	29.26	46.00	16.74
2.38	25.17	46.00	20.83
3.985	23.41	46.00	22.59
5.245	21.22	50.00	28.78
7.535	20.14	50.00	29.86
12.61	23.44	50.00	26.56
17.8	21.19	50.00	28.81
22.53	19.58	50.00	30.42

* limit exceeded

5.8 Radio Frequency Exposure

Standard Applicable:

According to §1.1307(b)(1), systems operating under the provisions of this section shall be operated in a manner that ensure that the public is not exposed to radio frequency energy level in excess of the Commission's guideline.

This is a Portable device with its physical nature to be used nearby, the distance between radiating structure and human is less than 20 cm.

As per KDB 447498 D01, The 1-g and 10-g SAR test exclusion thresholds for 100 MHz to 6 GHz at test separation distances ≤ 50 mm are determined by:

$$[(\text{max. power of channel, including tune-up tolerance, mW}) / (\text{min. test separation distance, mm})] * \sqrt{f(\text{GHz})} \leq 3.0 \text{ for 1-g SAR and } \leq 7.5 \text{ for 10-g extremity SAR, where}$$

f (GHz) is the RF channel transmit frequency in GHz

Power and distance are rounded to the nearest mW and mm before calculation

The result is rounded to one decimal place for comparison

Measurement Result:

This is a portable device and the Max tune up power is **(3.98 mW)** lower than the threshold given and derived as above, where

$$= 3.98 \text{ (mW)} / 5 \text{ (mm)} * \sqrt{2.480 \text{ (GHz)}} = 1.25 < 3.00$$

As the result of calculation result indicates, the RF exposure generating from given transmitter (transmitter employed digital modulation) can be excluded from SAR measurement, and is deemed compliant with RF exposure as per FCC.

Frequency [MHz]	Output Power [dBm]	Target power [dBm]	Allowed tolerance [dB]	Max tune up power [dBm]	Max tune up power [mW]	Separation distance [mm]	RF exposure	Limit
2 402	4.95	3.00	± 2.00	5.00	3.16	5	0.98	3.00
2 440	5.98	4.00	± 2.00	6.00	3.98	5	1.24	3.00
2 480	5.97	4.00	± 2.00	6.00	3.98	5	1.25	3.00

6. SAMPLE CALCULATION

Sample Field Strength Calculation

The field strength is calculated by adding the Antenna Factor and Cable Factor.
The basic equation with a sample calculation is as follows:

$$FS = RA + AF + CF$$

Where FS = Field Strength

RA = Receiver Amplitude

AF = Antenna Factor

CF = Cable Attenuation Factor - Preamplifier Factor

$$dB(\mu V) = 20 \log_{10} (\mu V) : \text{Equation}$$

$$dB(\mu V) = dBm + 107$$

Example : @ 3 003.84 MHz

$$\text{Class B Limit} = 53.97 \text{ dB}(\mu V/m)$$

$$\text{Reading} = 56.08 \text{ dB}(\mu V)$$

$$\text{Antenna Factor} + (\text{Cable Loss} - \text{Amp. Gain}) = 28.65 + (-35.33) = -6.68 \text{ dB}(\mu V/m)$$

$$\text{Total} = 49.40 \text{ dB}(\mu V/m)$$

$$\text{Margin} = 53.97 - 49.40 = 4.57 \text{ dB}$$

$$= 4.57 \text{ dB below Limit}$$

7. List of test equipments used for measurements

	Test Equipment	Model	Mfg.	Serial No.	Cal. Date	Cal. Due Date
<input checked="" type="checkbox"/>	EMI Test Receiver	ESCS30	R&S	100087	16.01.12	17.01.12
<input checked="" type="checkbox"/>	EMI Test Receiver	ESCS30	R&S	847793/005	16.03.14	17.03.14
<input checked="" type="checkbox"/>	EMI Test Receiver	ESCI7	R&S	100851	15.09.04	16.09.04
<input checked="" type="checkbox"/>	Two-Line V-Network	ENV216	R&S	101715	16.03.15	17.03.15
<input checked="" type="checkbox"/>	Two-Line V-Network	ENV216	R&S	102055	16.04.11	17.04.11
<input checked="" type="checkbox"/>	Loop Antenna	6502	EMCO	00033743	14.09.23	16.09.23
<input checked="" type="checkbox"/>	LogBicon Antenna	VULB9160	Schwarzbeck	3164	15.06.08	17.06.08
<input checked="" type="checkbox"/>	Horn Antenna	BBHA 9120D	Schwarzbeck	826	16.03.23	18.03.23
<input checked="" type="checkbox"/>	Spectrum Analyzer	FSW43	R&S	103794	15.09.08	16.09.08
<input checked="" type="checkbox"/>	DC Power Supply	SDP 60-5D	SMTECHNO	605DOD 002	16.03.14	17.03.14
<input checked="" type="checkbox"/>	Amplifier	TK-PA18	TESTEK	120020	15.09.03	16.09.03
<input checked="" type="checkbox"/>	Amplifier	310N	SONOMA INSTRUMENT	284750	15.12.08	16.12.08
<input checked="" type="checkbox"/>	USB Wideband Power Sensor	U2022XA	Agilent	MY56040002	16.01.29	17.01.29
<input checked="" type="checkbox"/>	Band Reject Filter	WRCGV 2402/2480-2382/2500-52/10SS	Wainwright Instrument	2	15.09.03	16.09.03
<input checked="" type="checkbox"/>	Highpass Filter	WHKX3.0 /18G-6SS	Wainwright Instrument	15	16.03.14	17.03.14
<input checked="" type="checkbox"/>	Attenuator	BW-S10-2W263+	Mini-Circuits	-	16.03.15	17.03.15
<input checked="" type="checkbox"/>	Turn-Table	DS1200-S	Innco Systems Gmbh	2740311	N/A	N/A
<input checked="" type="checkbox"/>	Controller	HD2000	HD GmbH	C/125	N/A	N/A
<input checked="" type="checkbox"/>	Turn-Table	TT 1.35 SI	SES	-	N/A	N/A
<input checked="" type="checkbox"/>	Antenna Master	AM 4.5	SES	-	N/A	N/A