

Antenna Info for FCC ID: 2AJJ5-CHRONOS

Minimum Cable Loss: 0dB

Maximum Antenna Gain (see data sheet below): 0.5 dBi

Antenna Location

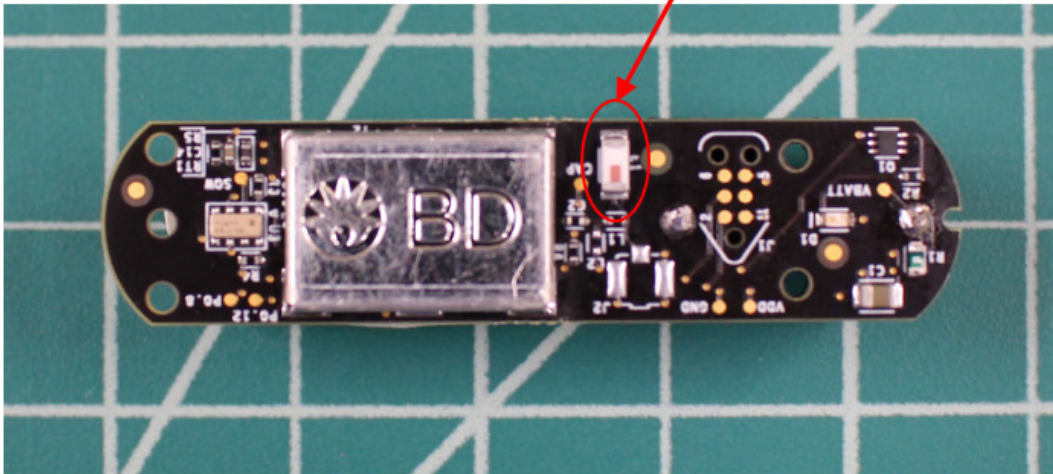

"High Frequency Ceramic Solutions"

Mini 2.45 GHz Antenna

Detail Specification: 7/18/2014

P/N 2450AT18A100

Page 1 of 4

General Specifications

Part Number	2450AT18A100
Frequency Range	2400 - 2500 Mhz
Peak Gain	0.5 dBi typ. (XZ-V)
Average Gain	-0.5 dBi typ. (XZ-V)
Return Loss	9.5 dB min.
Input Power	2W max. (CW)
Impedance	50 Ω
Operating Temperature	-40 to +125°C
Reel Quantity	3,000

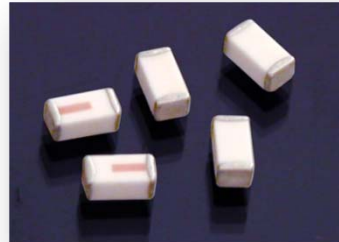

Mechanical Dimensions

	In	mm
L	0.126 \pm 0.008	3.20 \pm 0.20
W	0.063 \pm 0.008	1.60 \pm 0.20
T	0.051 +.004/-0.008	1.30 +0.1/-0.2
a	0.020 \pm 0.012	0.50 \pm 0.30

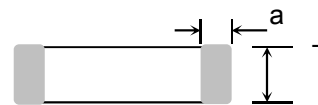
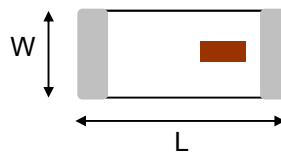

Mounting Considerations

a) Without Matching Circuits

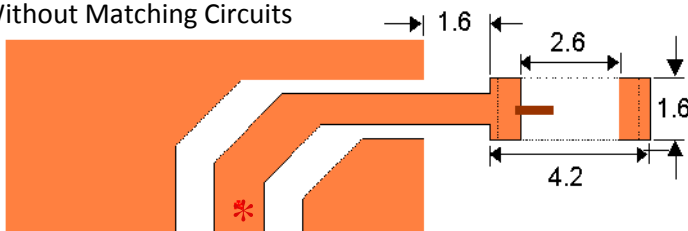

b) With Matching Circuits

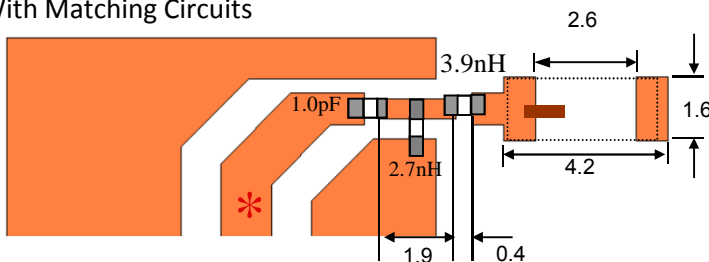

Mount these devices with mark facing up. Units: mm

* Line width should be designed to provide 50 Ω impedance matching characteristics.

Terminal Configuration

No.	Function
1	Feeding Point
2	NC



Note: It is recommended that the designer leave available slots for a "pi" (or shunt-series-shunt) network. The antenna matching network values here are used when antenna is mounted on Johanson's evaluation board. The matching values and topology on client's PCB will be different.

Need our help tuning the antenna on your board? Contact our RF Applications Eng Team at:

www.johansontechnology.com/component/techquestion

Antenna Tuning services:

www.johansontechnology.com/ipcantennaservices

Need the layout file of the above? Contact us at: www.johansontechnology.com/en/ask-a-technical-question.html

Johanson Technology, Inc. reserves the right to make design changes without notice.

All sales are subject to Johanson Technology, Inc. terms and conditions.



www.johansontechnology.com

4001 Calle Tecate • Camarillo, CA 93012 • TEL 805.389.1166 FAX 805.389.1821

Ver 1.3

2014 Johanson Technology, Inc. All Rights Reserved

"High Frequency Ceramic Solutions"

Mini 2.45 GHz Antenna

Detail Specification: 7/18/2014

P/N 2450AT18A100

Page 2 of 4

Typical Electrical Characteristics (T=25°C)

Test Board:

P/N: 2450AT18A100-EB1SMA
(orderable item)

The antenna matching network values here are used when antenna is mounted on Johanson's evaluation board. The matching values on client's PCB will be different. Go to: www.johansontechnology.com/ipcannaservices and see how to obtain the new values. If you need further help, contact our RF Applications Eng Team at:

www.johansontechnology.com/component/techquestion

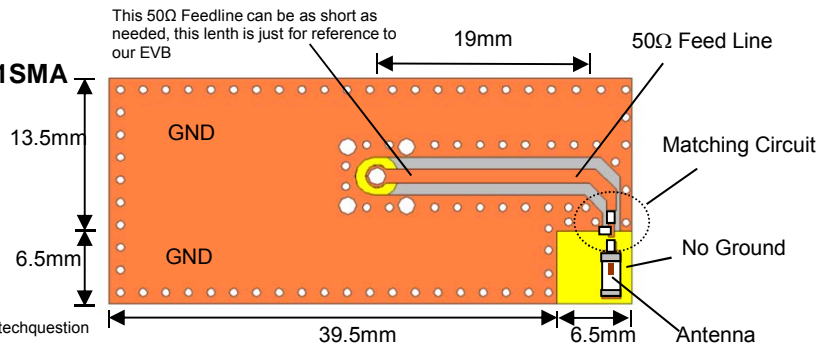

Return Loss with matching circuit @ +25C VSWR with matching circuit @ +25C and +125C

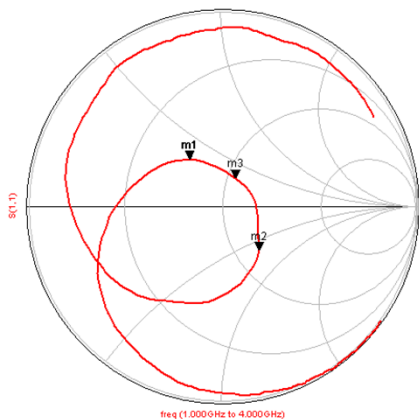
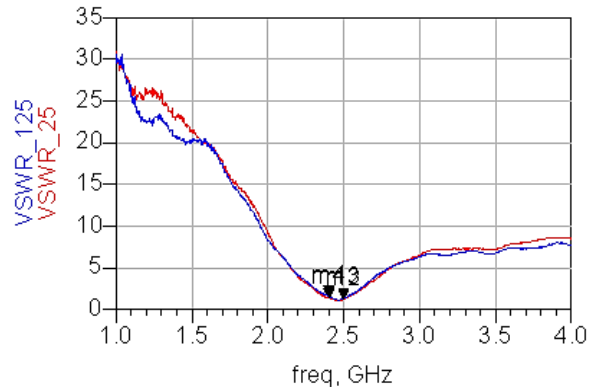
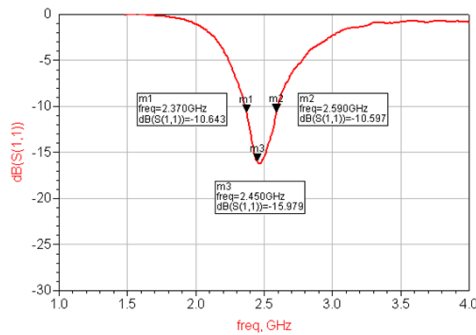

m 1
freq=2.400GHz
VSWR_25=1.386

m 2
freq=2.500GHz
VSWR_25=1.219

m 4
freq=2.400GHz
VSWR_125=1.606

m 3
freq=2.500GHz
VSWR_125=1.332

Johanson Technology, Inc. reserves the right to make design changes without notice.
All sales are subject to Johanson Technology, Inc. terms and conditions.

"High Frequency Ceramic Solutions"

Mini 2.45 GHz Antenna

Detail Specification: 7/18/2014

P/N 2450AT18A100

Page 3 of 4

Typical Radiation Patterns at 2.45GHz (+25C)

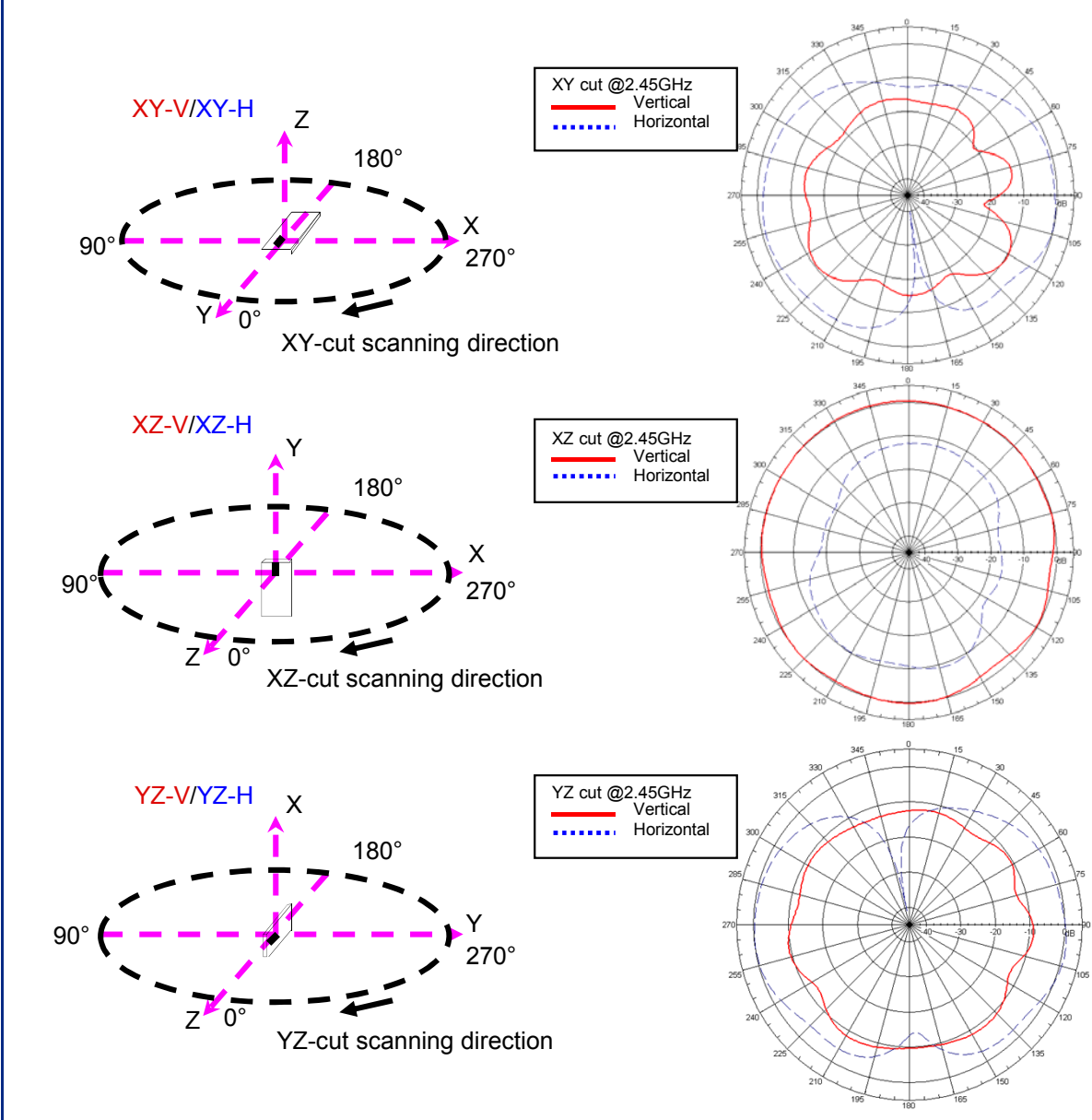

Johanson Technology, Inc. reserves the right to make design changes without notice.
All sales are subject to Johanson Technology, Inc. terms and conditions.



www.johansontechnology.com

4001 Calle Tecate • Camarillo, CA 93012 • TEL 805.389.1166 FAX 805.389.1821

Ver 1.3

2014 Johanson Technology, Inc. All Rights Reserved

"High Frequency Ceramic Solutions"

Mini 2.45 GHz Antenna

P/N 2450AT18A100

Detail Specification: 7/18/2014

Page 4 of 4

Part Number Explanation				
P/N Suffix	Packaging Style	Bulk (loose pieces)	Suffix = S	Eg. 2450AT18A100S
		T & R	Suffix = E	Eg. 2450AT18A100E
		T & R (Reverse)	Suffix = R	Eg. 2450AT18A100R (MOQ Applies)
	Termination style	100% Tin (RoHS)	Suffix = S/E/R	Eg. 2450AT18A100(S, E, R)
		Tin / Lead	Please consult Factory	
Evaluation Board(s) (1-port SMA antenna test boards)	2450AT18A100-EB1SMA (Page 2) Orderable item!			

AEC-Q2000 qualification available after special p/n: 2450AT18A100-AEC order. MOQ of 24K PCS applies for AEC and allow 16 weeks for AEC report leadtime.

Would you like Johanson Technology's RF team to help you design and tune our antenna on your board? Click on the link below:

Antenna layout review, tuning, and characterization services
www.johansontechnology.com/ipcantennaservices

Packaging information
www.johansontechnology.com/ipcpackaging.html

Soldering Information
www.johansontechnology.com/ipcsoldering-profile

RoHS Compliance
www.johansontechnology.com/technical-notes/rohs-compliance.html

MSL Info
www.johansontechnology.com/technical-notes/msl-rating.html

Recommended Storage Condition and Max Shelf Life
www.johansontechnology.com/ipcstorage-shelflife

Johanson Technology, Inc. reserves the right to make design changes without notice.
 All sales are subject to Johanson Technology, Inc. terms and conditions.



www.johansontechnology.com
 001 Calle Tecate • Camarillo, CA 93012 • TEL 805.389.1166 FAX 805.389.1821

Ver 1.3

2014 Johanson Technology, Inc. All Rights Reserved