

KRUZER

USER MANUAL

For Kruger and multi Kruger



MAKRO
METAL DETECTORS

**Authorized
R&D CENTER**

WARNINGS

READ CAREFULLY BEFORE OPERATION OF THE DEVICE

LEGAL DISCLAIMERS

► Comply with applicable laws and regulations governing use of metal detectors while using this detector. Do not use the detector without authorization in protected or archeological sites. Do not use this detector around unexploded ordnance or in restricted military zones without authorization. Notify appropriate authorities with details of any historical or culturally significant artifacts you find.

WARNINGS

► **Kruzer** is a state-of-the-art electronic device. Do not assemble or operate the device before reading the user manual.

► Do not store the device and search coil under extremely low or high temperatures for extended periods. (Storage Temperature: - 20°C to 60°C / - 4°F to 140°F)

► The device has been designed with IP68 rating as a waterproof unit up to 5 meters (**except for the wireless headphones!**).

► Pay attention to the items below after using the device especially under salty water:
1. Wash the system box, shaft and the coil with tap water and be sure no salt water is left in the connectors.

2. Do not use any chemicals for cleaning and/or for any other purposes.

3. Wipe the screen and the shaft dry with a soft, non-scratch cloth.

► Protect the detector against impacts during normal use. For shipping, carefully place detector in original carton and secure with shock resistant packaging.

► **Kruzer** metal detector may only be disassembled and repaired by **Nokta** Authorized Service Centers. Unauthorized disassembly/intrusion into the metal detector control housing for any reason voids the warranty.

► Do not use the device indoors. The device may constantly give target signals indoors where there are many metals present. Use the device outdoors, in open fields.

► Do not let another detector or an electromagnetic device come in close proximity (10m (30ft.)) to the device.

IMPORTANT

Do not carry any metal objects while using the device. Keep the device away from your shoes while walking. The device may detect the metals on you or inside your shoes as targets.

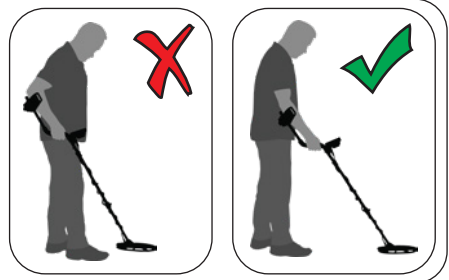

For Consumers within the European Union: Do not dispose of this equipment in general household waste. The crossed wheeled bin symbol on this equipment indicates this unit should not be disposed of in general household waste, but recycled in compliance with local government regulations and environmental requirements.



TABLE OF CONTENTS

ASSEMBLY.....	1
INTRODUCTION TO THE DEVICE.....	2
BATTERY INFORMATION.....	3-4
HEADPHONE INFORMATION.....	4
DISPLAY.....	5
CORRECT USE.....	6
QUICK GUIDE.....	7
GROUND BALANCE.....	8-11
TARGET ID.....	11-12
SEARCH MODES (MODE).....	13-14
SETTINGS.....	15-20
OPTIONS.....	20-22
EXTRA UNDERGROUND DEPTH (E.U.D.).....	23
PINPOINT.....	23-24
TARGET DEPTH.....	24
LARGE OR SHALLOW TARGETS.....	24
FALSE SIGNALS AND REASONS.....	24-25
MAGNETIC MINERALIZATION INDICATOR.....	25
ROCKS AND SEARCHING IN ROCKY TERRAINS.....	25-26
TRACKING AND EFFECTS OF ROCKS.....	26
METALS UNDER ROCKS.....	26-27
DETECTION ON THE BEACH AND UNDERWATER.....	27
MESSAGES.....	28
SOFTWARE UPDATE.....	28
TECHNICAL SPECIFICATIONS.....	29

ASSEMBLY

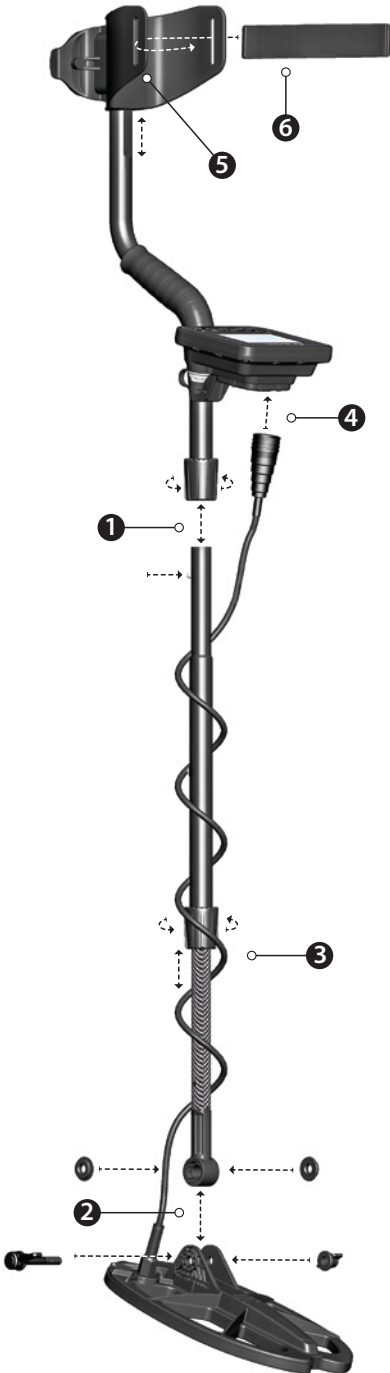

(1) To attach the middle rod with the upper S-rod, loosen the twistlock. Press down the pin and engage the pieces together and tighten the twist lock after the pin is clicked into the hole.

(2) After inserting the washers on the lower shaft, place the lower shaft in its location on the search coil. Secure by tightening the screw and nut. Do not overtighten.

(3) Loosen the twist lock to adjust the length of the device to your height. Adjust the length of the shaft by keeping the pin located on the rear pressed down and clicking the pin in any of the holes. Secure by tightening the twist lock.

(4) Wind the search coil cable on the shaft without stretching too much. Fold down the plastic bellows on the cable and plug the connector to the search coil input socket on the system box. Then secure by tightening the nut. Finally, holding the plastic bellows from the top, pull it and fully stretch it over the connector housing. When you want to disconnect the bellows, pull it down by holding it from the top only. When connecting or disconnecting, do NOT twist it!

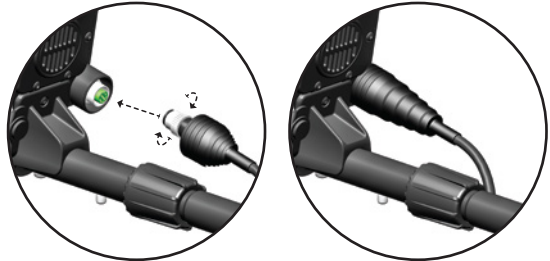

(5) Loosen the screw inside the armrest to adjust it to your comfort. Slide the armrest up or down to align the screw to one of the three holes on the S-rod. Secure by tightening the screw.

(6) Insert the armrest strap as shown in the picture and adjust it to your arm size and tighten.

INTRODUCTION TO THE DEVICE



- (1) LCD Display
- (2) Select / Extra Underground Depth (E.D.U)
- (3) SETTINGS button to access the basic settings
- (4) Pinpoint button
- (5) Keypad for navigation among menu options and changing the device settings
- (6) On / Off button
- (7) OPTIONS button to access extra settings
- (8) Ground balance button
- (9) Wired headphones / charger / optional battery pack input
- IMPORTANT!** When the connectors are not in use, keep them closed with the plastic cap!
- (10) Speaker
- (11) Search coil input socket

BATTERY INFORMATION

Kruzer has an internal 3700mAh Lithium Polymer battery.

Battery life is approximately 14-19 hours for the **Kruzer** and 9-19 hours for the **multi Kruzer**. Battery life will be less in 5kHz compared to other frequencies on the **multi Kruzer**. Other factors such as usage of speaker or wired/wireless headphones will also affect battery life for each model.

Charging

Charge the **Kruzer** before initial use. Charging will take approximately 4 hours.

To charge the battery, insert one of the ends of the cable supplied with the charger to the wired headphones / charger input socket and the other end to the charging adapter.

You can also power and charge the battery with a powerbank. To do this, just insert one of the ends of the cable supplied with the charger to the wired headphones / charger input socket and the other end to the powerbank. Please note that you will not be able to attach wired headphones to the device when a powerbank is attached to the device.

IMPORTANT! Do not use a different charging adapter other than the one supplied with your device!

OPTIONAL BATTERY PACK

You can purchase the optional battery pack and use it when the device's internal battery is dead and you cannot charge it.

You can attach the battery pack easily to the back of the armrest as shown in the pictures.



The battery pack takes 4 AA Alkaline or rechargeable NiCd or NiMH batteries.

The battery pack does not come with the device, it is an optional accessory and it does not include the 4 AA batteries.

BATTERY INFORMATION

Because the input socket for the wired headphones cannot be used when the optional battery pack is attached to the device, you can attach your wired headphones to the input socket on the battery pack.

IMPORTANT! 2 optional battery packs cannot be attached back to back to the device. When you want to charge the internal battery of the device, do not forget to disconnect the optional battery pack! Do not attempt to attach the charging adapter to the connector on the optional battery pack. This input is for wired headphones only!

Low Battery Level

Battery icon on the display shows the battery life status. When the charge decreases, the bars inside the battery icon decrease, too. "Lo" message appears on the display when the batteries are depleted.

When the optional battery is low, the device will display the low battery warning "Lo" on the screen the internal battery. In such a case, the batteries need to be replaced or the internal battery must be used. If you want to switch to using the internal battery, remove the optional battery case cable and turn the device off and on again. Otherwise, the device will continue to display the Lo battery warning.

BATTERY WARNINGS:

Do not expose the device to extreme temperatures (for example a car's trunk or glove compartment)

Do not charge the battery in temperatures over 35° C (95° F) or below 0° C (32° F).

The **Kruzer** battery can only be replaced by **Makro Detectors** or its authorized service centers.

INFORMATION ABOUT HEADPHONES

The **Kruzer** comes with 2.4 GHz wireless headphones. **The wireless headphones are NOT waterproof.**

The wireless connection will work as long as the system box of the device is not submerged in the water. In other words, you can use your wireless headphones while searching in shallow water with the coil submerged underwater. Please remember though that the wireless headphones should not contact with water.

IMPORTANT! Do not use a different charging adapter other than the one supplied with your device to charge the wireless headphones!

In case of the system box being submerged underwater, the wireless connection will not work. In this case, you need to purchase our optional waterproof headphones for land and underwater use.

For land use only, you can also purchase our optional headphones adapter should you want to use the **Kruzer** with your own wired headphones.

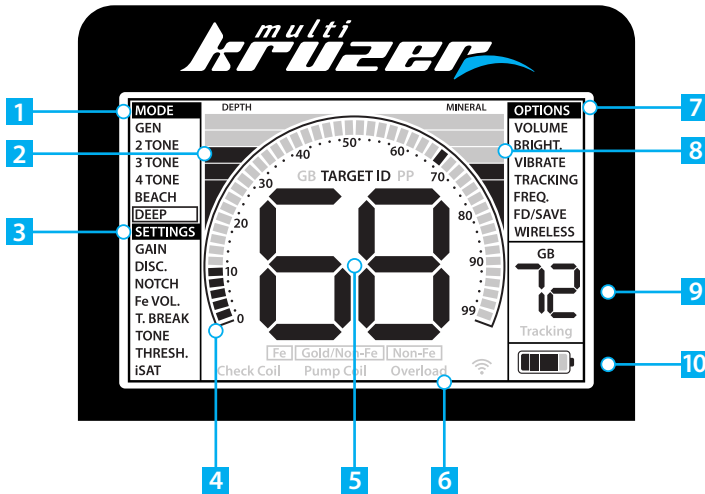

(1) Search Modes.

(2) Instant Depth Meter.

(3) Settings.

(4) Target ID scale.

Shows the ID of the detected target on the ID scale. It also indicates the IDs filtered by Disc. and Notch settings as well as the tone breakpoints.

(5) Section which shows the Target ID upon target detection, the ground balance whole number value during ground balancing (GB) and the estimated target depth (PP) in the pinpoint mode. In addition, the numeric value of any setting selected from the menu is displayed in this field.

(6) Section which shows the warning messages.

(7) Options.

(8) Magnetic mineralization indicator.

(9) Section which shows the fine tuning value during ground balance adjustment and current ground balance value during search.

(10) Battery level indicator.

CORRECT USE



Shaft height is wrong

It is very important to adjust the shaft to your height correctly to be able to search without discomfort and fatigue.



Shaft height is correct

Adjust the height of the shaft so that you are standing in an upright position, your arm is relaxed and the search coil is approximately 5cm (~2") above the ground.

CORRECT WAY OF SWEEPING

Wrong search coil angle



Wrong search coil angle



Correct search coil angle



Incorrect way of sweeping

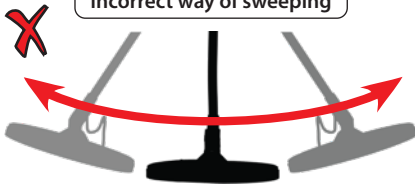

Correct way of sweeping

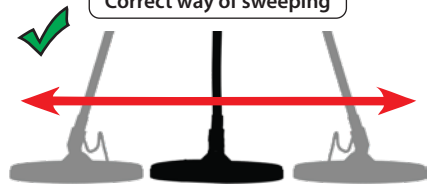

It is important to keep the search coil parallel to the ground in order to get accurate results.

The search coil must be parallel to the ground at all times.

QUICK GUIDE

- 1) Assemble the device as per the instructions on page 1.
- 2) Push the on/off button to turn on the device.
- 3) When the device is turned on, it will start in the 2 TONE mode and 14kHz operating frequency. You can change the mode based on ground conditions. For instance, if you are detecting on wet beach sand, you may want to select the BEACH mode. You can also change the frequency of the device on the **multi Kruzer** model. You can find more details on search modes and frequencies further in this manual.
- 4) To ground balance, push and hold the GB button and pump the search coil up and down to 3cm (1.2") above the ground until a "beep" sound is heard.
- 5) You can increase the GAIN if needed. Increasing the gain will offer you greater depth. However, if the surroundings or the ground cause excessive noise in the device, you need to lower the gain setting.
- 6) Testing the device with various metals would be helpful for getting familiar with the sounds produced by the device.
- 7) Based on the IDs of the metals you don't want to detect, you can adjust the DISC. setting and ignore those metals. For instance, if you don't want to detect ferrous metals with 00-05 ID in the 2 TONE mode, you can set the DISC. to 5.
- 8) If you are detecting in a very trashy area and the device is getting too many iron signals, instead of DISC. you can use the Fe Vol. to lower or completely turn off the iron audio. This will provide more depth.
- 9) You can filter out certain Target IDs using the NOTCH and enable the device to ignore these metals during searching or to provide an iron audio for them.
- 10) If you wish, you can adjust the tone break points of the device with the T.BREAK feature and change the frequency of the tones using the TONE setting.
- 11) You can now start searching.
- 12) Since your device operates with the motion principle, swing the search coil right and left maintaining 5cm (2") distance above the ground. If the search coil does not move, the device will not provide any audio responses even if the coil is over a metal target.
- 13) When a target is detected, the ID of the target and its position on the ID scale will be displayed on the screen. The device will also produce an audio response according to the search mode selected.
- 14) Upon target detection, you can pinpoint the exact location of the target by pressing and holding the PP button. The audio volume will increase and the audio pitch will also increase as you approach the target.

GROUND BALANCE

Ground balance can be performed in three ways with the **Kruzer**: Automatic, Manual and Tracking.

When the GB button is pushed while performing automatic or manual ground balance, the device will switch to the General Search (GEN) mode automatically on the background without any indication to the user, regardless of the selected search mode.

Upon completion of ground balance, current ground balance value is shown in the Ground Balance (GB) box on the right side of the display.

Automatic Ground Balance

Automatic ground balance is performed as follows in all search modes:

- 1) Find a spot where there is no metal.
- 2) Push and hold the GB button down (GROUND BALANCE value and "Pump Coil" warning message will be shown on display) and start pumping the search coil up and down from about 15-20 cm (~6" - 8") above the ground down to 3 cm (~1") off the ground with smooth movements and keeping it parallel to the ground.

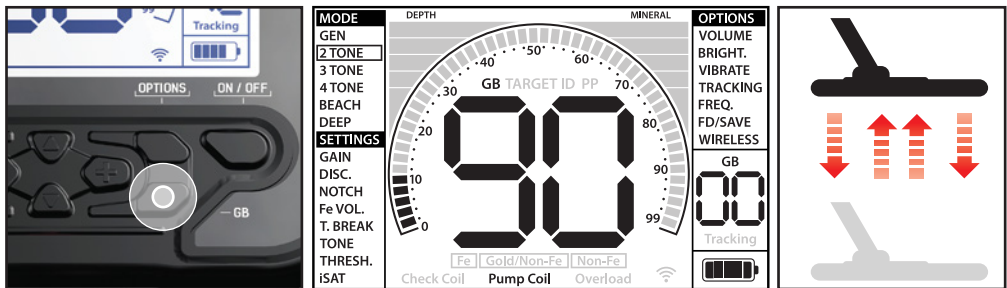

3) Continue until a beep, indicating the completion of ground balance, is heard. Based on ground conditions, it usually takes about 2-4 pumps for the ground balance to be completed.

4) Upon completion of the ground balance, ground balance value is shown on the display (GB). The device continues to ground balance and produce a beep sound as long as you keep the GB button pushed down and pump the coil. In order to ensure that the ground balance is proper, ground balance at least 2-3 times and check the ground balance values on the display. In general, the difference between the values shall not be higher than 1-2 numbers.

5) If you cannot ground balance, in other words, if no beep sound is produced, it means that either the ground is too conductive or not mineralized or there is a target right below the search coil. In such a case, retry ground balance at a different spot. If you still cannot ground balance, read the section titled "**Important Details Concerning Ground Balance**".

When the ground balance button is released, the device continues to operate in the GEN mode for a short period of time and the ground balance value stays on display. This makes it possible to manually fine tune the automatic ground balance value. Refer to the following "**Manual Ground Balance**" section for further information regarding this feature. If this is not desired, press the PP button once to return to the main screen.

NOTE: If the iSAT value is set high, the device may not auto ground balance. In such a case, lower the iSAT value first. After ground balancing, set the iSAT back to its original position.

GROUND BALANCE

Manual Ground Balance

Allows you to manually modify the ground balance value. It is not preferred mostly because it takes time. However, it is the preferred option in cases where a successful ground balance cannot be performed using other methods or minor corrections are required to the automatic balance.

Kruzer is designed to allow for automatic ground balancing conveniently on any type of ground. Therefore, it is recommended to perform automatic ground balance upon start up. However, the ground may not be suitable for automatic ground balancing in some cases and the device cannot ground balance on such grounds (Except for the BEACH mode). For instance, wet beach sand, soils containing alkali or salty water, trashy sites, ploughed fields, highly mineralized grounds and grounds with very low mineralization are not suitable for automatic ground balance. In such terrains, you can auto ground balance in the BEACH mode and then switch to other modes or try manual ground balancing. However, manual ground balance requires a skill which develops over time through practice.

To perform manual ground balance:

1) Find a clear spot without metals and switch the device to the GEN mode.

2) You need to listen to the sounds coming from the ground in order to perform manual ground balance. Pump the search coil up and down from about 15-20 cm (~6"- 8") above the ground down to 3 cm (~1") off the ground with smooth movements and keeping it parallel to the ground.

If the sound gets higher when lifting off the search coil above the ground, the ground balance value is too low, in other words, the effect from the ground is negative and the ground balance value needs to be increased by using the (+) button. On the other hand, if the sound gets higher when lowering the search coil to the ground, the ground balance value is too high, in other words, the effect from the ground is positive and the ground balance value needs to be decreased by using the (-) button.

3) Push the ground balance button once and release it. The ground balance value will be shown on the display and remain there for a moment. You can return to the ground balance screen by pushing the ground balance button if the screen switches.

Manual ground balance functions within the range of 0-99.80 However, each value covers 5 steps used for fine tuning within itself and these steps are indicated as multiples of 20 in the Ground Balance window (GB). For example, ground balance value shown on the side is 70.80.

Press (+) or (-) to increase or decrease the ground balance value, respectively. If the key is pressed once at a time, the values count one by one and if it is held down, the values will change quickly.

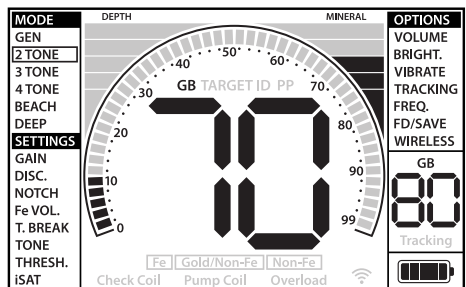

4) Repeat the above procedure until the sound heard from the ground is eliminated.

The sound may not be eliminated completely in some areas. In these cases, listen to the sounds produced when moving the search coil towards and away from the ground to check if the ground balance is correct. If there is no difference between the two sounds then the ground balance is set properly.

The device will return to the main screen automatically after a short period of time upon completion of ground balance. To return to the main screen instantly, just press the PP button once.

IMPORTANT! Experienced detectorists adjust the ground balance setting to a slightly positive response (weak but audible sound is produced when moving the search coil closer to ground). This method may produce favorable results for experienced users in certain fields where small targets are searched for.

Ground Tracking (TRACKING)

In this option, the user does not need to make any adjustments. TRACKING feature is activated from the OPTIONS menu by switching it to 01 position. The word "Tracking" is displayed at the bottom of the GB window. The device updates the ground balance automatically as long as the search coil is swung over the ground and shows the ground balance value in the GB window. It does not provide any feedback to the user (like the beep sound in automatic ground balance).

While tracking is active, the device can initially produce a loud signal when it detects a different ground structure (for instance a mineral rock) or a target. In this case, swing the search coil over the spot where the device produces the signal. If the sound remains the same and the device shows an ID, it is possibly a target. If the sound attenuates too much or is lost after a few swings, it means that the device has produced a signal for the different ground structure or a stone.

NOTE: It is recommended that you use tracking in the General Search mode (GEN) and not in the discrimination modes.

Tracking is suitable for use in areas where different soil structures are present within the same land or in fields where mineralized rocks are scattered widely apart. If you use ground tracking in areas where hot rocks are intensely present, the device may not be able to eliminate these highly mineralized rocks or you may miss the smaller or deeper metals.

IMPORTANT! Ensure that tracking is off during air tests. Otherwise, the device will attempt to perform ground balance on the target and the depth will be reduced.

Ground Balance Value

Ground balance value provides information about the ground you are searching on. Some typical ground types are as follows:

- 0-25 Wet salt water or wet alkali soils
- 25-50 Wet salt water and wet alkali soils covered with dry layers
- 50-70 Regular, low-quality soils
- 70-90 Highly magnetic soils, magnetite or maghemite and similar highly mineralized soils, black sand.

Important Details Concerning Ground Balance

1) Upon start up, the ground balance value is set to 90. The device can perform ground balance automatically within the range of 20-99.80 in all modes and 00-99.80 in the BEACH mode.

2) If the ground mineralization is too low, automatic ground balance may fail to work in

GROUND BALANCE

other modes except for the BEACH mode. In such a case, you can auto ground balance in the BEACH mode and then switch to other modes or try manual ground balancing.

3) You can test the accuracy of the ground balance with the pinpoint mode. After ground balancing, if you receive no sound or a weak one when you move the search coil closer to the ground in the pinpoint mode, then the ground balance is successful. If the sound gets louder when you move the search coil closer to the ground, then the ground balance is not successful. In this case, simply change your location. If ground balance is not possible despite these efforts, you should continue your search without performing ground balance.

You cannot search in the General Search (GEN) mode without ground balancing. You need to use one of the discrimination modes and increase the DISC. value until the noise is eliminated.

4) Once the ground balance is set, it will remain satisfactory for a long time in most areas. However, if you encounter an excavated, backfilled or geologically composite soil structure, a ground balance should be performed again to adapt to the varying soil structure. In addition, re-ground balancing is recommended for the multi Kruzer model if you change the operating frequency of the device (5kHz/14kHz/19kHz) in certain ground conditions.

5) When using the optional large coil, pump the coil more slowly and do not keep it very close to the ground.

6) In some cases where the iSAT value is set high, the device may not be able to ground balance automatically. In such a case, first lower the iSAT and after ground balancing switch it back to its previous position.

TARGET ID

TARGET ID is the number produced by the metal detector based on the conductivity of the metals and gives an idea to the user about what the target may be. Target ID is shown with two digits on the display and ranges between 00-99.

NOTE: Keep in mind, large targets will ID higher than expected, even though they may be of lower conductance.

In some cases, the device may produce multiple IDs for the same target. In other words, the IDs may be jumpy. This may result from several factors. Target orientation, depth, purity of the metal, corrosion, mineralization level of the soil etc. Even the direction of the search coil swing may cause the device to generate multiple IDs.

In some cases, the device may fail to provide any ID. The device needs to receive a strong and a clear signal from the target in order to provide an ID. Therefore, it may not be able to provide an ID for targets at fringe depths or smaller targets even if the device detects them.

Keep in mind that target IDs are “probable”, in other words, estimated values and it would not be possible to know the properties of a buried object exactly until it is dug out.

IDs of non-ferrous metals such as copper, silver, aluminum and lead are high. Target ID range of gold is wide and may fall within the same range of metal wastes such as iron, foil, screw caps, and pull tabs. Therefore, if you are looking for gold targets, digging out some trash metals is expected.

On the **multi Kruzer**, when the operating frequency is changed (5kHz/14kHz/19kHz), the Target ID will change as well. This represents the "Standard" ID scaling of the device.

IMPORTANT! At start up, multi Kruzer will utilize the "Normalized" ID scale and not the Standard ID scale. In other words, the IDs will not change upon frequency change and the device will generate the 14kHz IDs in each frequency. However, based on ground conditions IDs may vary for certain metals.

If you prefer to see the different IDs produced by each frequency, you need use the "Standard" ID scale. To switch to the standard IDs, **while the device is on**, push the plus (+) and minus (-) buttons at the same time. Letters "Sd" will appear on the screen. If you wish to revert back to the normalized IDs, repeat the same process and letters "no" will appear on the screen.

The table showing the probable IDs for the Kruzer and the multi Kruzer models is placed at the back of this manual. You can easily detach the page and carry it with you during your searches.

Coins searched throughout the world are made of different metals and in different sizes in different geographical locations and historical eras. Therefore, in order to learn the Target IDs of the coins in a specific region, it is suggested to perform a test with the samples of such coins, if possible.

It may take some time and experience to make best use of the Target ID feature in your search area. Different brands and models of detectors produce different target ID numbers. The numbers vary even more depending on target depth, ground mineralization, and adjacent metals. But after some practice, you will quickly become comfortable with the meanings of the **Kruzer's** Target IDs.

Kruzer has 6 search modes designed for different terrains and targets. You can navigate between the modes easily by using the direction buttons. The selected mode name will be framed on screen.

General Search (GEN)

Different than the other modes, this mode features a threshold tone which is continuously heard in the background.

In this mode, the device does not discriminate targets and detects all targets (metals, mineralized rocks etc.). ID of the detected target is shown on the display (except for negative hot rocks) and the same audio tone is provided for all targets. The audio tone increases in pitch as the coil approaches the target. This is the typical All Metal mode found in most detectors.

Gain, threshold and iSAT settings in this mode are optimized to provide the best performance on different terrains. You can modify these settings based on ground conditions.

We recommend using the GEN mode when discrimination is not important and not using it in heavy trash areas or areas containing many hot rocks.

2-Tone Discrimination (2 TONE)

Recommended especially for relic hunting. It produces good results particularly on clean sites which do not contain waste metal. More depth can be obtained on sites which are rocky or those that contain waste metals by using the DISC. and NOTCH and swinging the search coil more slowly (one right/left pass per approximately 1 second). DISC. is set to 03 as a default value. You can modify this value according to the ID of the targets you don't want to detect.

In this mode, the device produces a low tone for ferrous targets with IDs between 0-15. For targets with IDs 16-99, it produces a higher tone which increases in pitch as the coil approaches the target. By using the T.BREAK feature, you can adjust the break points of the target response tones on the Target ID range.

3-Tone Discrimination (3 TONE)

This is the 3-tone discrimination mode designed for coin hunting especially in trashy sites such as parks. In this mode, the device produces a low tone for ferrous targets with 0-15 IDs, a medium tone for gold and non-ferrous metals with IDs 16-66 and a high tone for non-ferrous metals with IDs 67-99 such as silver, brass and copper. By using the T.BREAK feature, you can adjust the break points of the target response tones on the Target ID range.

4-Tone Discrimination (4 TONE)

4-tone discrimination mode designed for coin hunting in low-medium mineralization. Due to its high gain and depth, this mode is a bit noisier than the other modes. Noise will be more in the air versus in the ground. Take this fact into consideration when adjusting the gain level.

In this mode, the device produces a low tone for ferrous targets with 0-15 IDs, a medium tone for gold and non-ferrous metals with IDs 16-30, a medium-high tone for metals with 31-66 IDs, and a high tone for non-ferrous metals with IDs 67-99. By using the T.BREAK feature, you can adjust the break points of the target response tones on the Target ID range.

BEACH MODE (BEACH)

This is a special mode of the Kruzer developed for conductive grounds (salty wet sand beach, grounds with alkali soil etc.). The feature of this mode presents the ability to ignore iron and similar targets in this group and to be able to perform ground balance on any type of ground. While the device performs ground balance in the range of 20-99.80 automatically in the other discrimination modes, the device ground balances in the range of 0-99.80 in this mode. This enables easier ground balancing on conductive grounds where normally ground balance cannot be performed at all or performed with difficulty.

In this mode, the device produces a low tone for ferrous targets with IDs between 0-15. For targets with IDs 16-99, it produces a higher tone which increases in pitch as the coil approaches the target. By using the T.BREAK feature, you can adjust the break points of the target response tones on the Target ID range.

Different than the other modes, the DISC. is set to 15 as a default value in this mode in order to ignore ferrous metals or ground noise.

Salt water and alkali grounds are significantly conductive due to high ionization and cause effects similar to that of iron in detectors. These effects may make it impossible to search for metals with a standard detector. Existence of an iron elimination feature in a detector can improve the situation but may not be sufficient.

Kruzer's BEACH mode eliminates such effects and ground noise. Aspects to be taken into consideration while searching on conductive grounds are explained in more detail in the section titled **Detection on the Beach and Underwater (page 27)**.

Deep Mode (DEEP)

Recommended especially for relic hunting, this mode is the deepest mode of the device. Therefore, it may run relatively noisier. Noise will be more in the air versus in the ground. Take this fact into consideration when adjusting the gain level. While searching in this mode, a slower swing speed is required.

The discrimination ability of the DEEP mode is relatively less compared to the other modes. Hence, its performance may vary on trashy sites versus clean ones.

In this mode, the device produces a low tone for ferrous targets with IDs between 0-15. For gold and non-ferrous targets with IDs 16-99, it produces a higher tone which increases in pitch as the coil approaches the target. By using the T.BREAK feature, you can adjust the break points of the target response tones on the Target ID range.

SETTINGS

Push the SETTINGS button to access the basic settings. You can navigate the basic settings with the up and down buttons. The value of the selected setting will be displayed on screen. You can change the value using the plus (+) and minus (-) buttons. If the up/down and +/- buttons are held down, the options and values will change rapidly.

To exit the settings, press the SETTINGS or the PP button once. Settings will time out in approximately 8 seconds and the device will revert back to the modes window.

NOTE: Certain settings are mode specific and thus cannot be selected in other modes.

GAIN

Gain is the depth setting of the device. It is also used to eliminate the ambient electromagnetic signals from the surrounding environment and noise signals transmitted from ground.

NOTE: To obtain maximum depth performance, to eliminate the noise caused by electromagnetic interference, try shifting the frequency first.

Frequency shift is done with the **FREQ.** option in the **Kruzer** and with a combination of buttons in the **multi Kruzer** (see pages 21-22). In the **multi Kruzer**, when the frequency shifting is not sufficient for eliminating noise, you can also change the operating frequency (5kHz/14kHz/19kHz) of the device.

Gain setting range is 01-99 and pre-defined for each mode. All modes start at default settings. They can be manually modified when necessary. Gain adjustment applies to the selected mode; the modified setting does not affect the gain setting of the other modes.

NOTE: If the ground is highly mineralized causing the device to overload, decrease the gain until the "Overload" message disappears from the screen.

Gain in General Search Mode (GEN):

In the GEN mode, gain setting causes an increase or decrease in the popping sounds and false signals. Gain setting is a personal preference. However, It is important to set the gain setting to the highest level possible where no major popping sounds are heard to avoid missing smaller and deeper targets. For example; if the noise level is suitable for searching and is the same at gain levels 40 and 70, then 70 should be preferred. Using the factory default levels will be a good starting point until you get familiar and experienced with the device.

Gain in Discrimination Modes:

Since the threshold setting is not available in the discrimination modes, you can increase the depth of the device or ensure noise-free operation on different grounds only by using the GAIN setting.

In order to adjust the gain in the discrimination modes, first ground balance while the gain is at its default setting. After ground balance is completed, hold the search coil stationary or swing over the ground at search height. Reduce the gain if the device receives noise. If not (ensure that the **DISC.** is also at its default settings when checking this), increase the gain gradually until there is no popping sound. If the device starts to receive noise during searching, reduce the gain gradually.

NOTE: **Kruzer** is a high gain device and some of the search modes will run relatively noisy (**DEEP** and **4 TONE**) compared to other modes so as to provide the best depth performance. However, due to the design characteristics of these modes, the noise will be heard more if

the coil is in free air than sweeping the coil on the ground. Please keep this factor in mind while adjusting the gain.

Discrimination (DISC.)

Disc. is the ability of the device to ignore all metals below a certain Target ID. In the DISC. process, the filtered ID range is shown with lines on the ID scale and every 2 consecutive IDs are represented with 1 line. For example, if you set the Disc. to 30, 15 lines will be shown between the 0-30 ID range on the scale and the device will not produce an audio response for any metals with IDs between 0-30.

DISC. setting is disabled for GEN mode only. For all other modes, the factory default value will be displayed on screen at start up.

In order to change the DISC. value, select the DISC. option from the SETTINGS and decrease or increase the value using the plus (+) or minus (-) buttons. Please remember that certain targets, other than the ones you want to ignore, may also be missed or their signals may become weaker when using the DISC. setting.

In the case of receiving multiple IDs for the same target - let's say 35 and 55 - due to the orientation of the target or the composition of the metal itself, if you set the DISC. to 40, because 35 will fall in the filtered range, the signal strength as well as the depth may diminish.

NOTE: DISC. setting works inversely proportional to depth up to level 15 in all modes. In other words, as the DISC. is increased up to 15, stability will increase but depth will be reduced and vice versa. Above 15 though, both depth and noise will increase.

NOTCH

NOTCH is the ability of the device to discriminate single or multiple Target IDs by not emitting an audio response for them or giving a low iron tone (please refer to iron tone in notch).

Although NOTCH may seem similar to DISC. at first glance, these two settings have different functions. While the DISC. filters out all IDs between 0 and the set value, the NOTCH filters IDs individually.

With the NOTCH you can reject a single ID or multiple IDs at the same time. This process does not affect any IDs below or above the selected IDs. For example, you can filter out IDs between 31-35 as well as 50 simultaneously.

How To Use The NOTCH Setting

When NOTCH is selected from the SETTINGS, first, the current DISC. value will be displayed on screen and discriminated ID range will be shown on the ID scale with lines. For example, if the DISC. is set to 15, when you select NOTCH, number 16 will be displayed on screen corresponding to 8 lines on the ID scale (every 2 consecutive IDs are represented with 1 line). NOTCH cannot be used within the DISC. range. In other words, if the DISC. is set to 15, NOTCH can only be applied to IDs 16 or higher. If you want to NOTCH IDs 15 or below, first you need to change the DISC. value.

NOTCH rejects or accepts IDs with the help of the cursor in the middle of the screen. To move the cursor on the scale, plus (+) and minus (-) buttons are used. The cursor blinks while it is moving on the scale. When you are on the first ID that you want to reject, press

the SELECT button once. This ID is now rejected and it is shown on the screen with a line. If you want to reject multiple IDs, continue to press the plus (+) or minus (-) button. If non-consecutive IDs want to be rejected, push the SELECT button once to have the cursor blink for navigation on the scale and repeat the process above. The cursor will appear where you left it the next time you use the NOTCH.

To give an example; let's say you want to reject IDs between 21-25 and the cursor is at 10. Press the plus (+) button until you reach number 21. Then push the SELECT button once. Number 21 will be marked with a line. When you reach number 25 using the (+) button again, IDs between 20-25 will be filtered out and they will be shown on the ID scale with 4 lines (every 2 consecutive IDs are represented with 1 line).

To accept back the filtered IDs, select NOTCH from SETTINGS. The cursor will appear where you last left it. Using the plus (+) or the minus (-) button, select the ID you want to accept and push the SELECT button. Then, using the plus (+) or minus (-) button again, unfilter the IDs back in. 1 line will be erased for every 2 consecutive IDs accepted.

Iron Tone in Notch Setting:

This will enable you to get a low iron tone for your notched out target IDs instead of silencing them. To use this feature, first select Fe VOL. from the SETTINGS and using the plus (+) button select the iron tone volume between n1-n5. n5 is the maximum level and the iron volume will be reduced as you go down but it cannot be silenced completely.

NOTCH adjustment applies to the selected search mode only. The change does not affect the other modes.

IMPORTANT! In the **multi Kruzer**, if you are using the Standard ID scale and you change the operating frequency of the device, you may need to re-adjust the NOTCH values according to the IDs you will get in the new frequency.

Iron Volume (Fe VOL.)

It adjusts or turns off the volume of the low iron tone. It can be adjusted between 0-5 or n1-n5.

0-5: 5 is the maximum level. As you lower it, the audio response volume the device produces for ferrous metals will decrease. At 0 level, the iron audio will be silenced. In other words, the device will detect ferrous targets, the Target ID will be displayed on the screen but the device will not produce any audio response.

n1-n5: This will enable you to get a low iron tone for your notched out target IDs instead of silencing them. n5 is the maximum level and the iron volume will be reduced as you go down but it cannot be silenced completely.

Fe VOL. adjustment applies to the selected search mode only. The change does not affect the other modes.

Tone Break (T.BREAK)

It is used to adjust the break points of the target response tones on the Target ID range. Default Tone Break points in the Kruzer will vary according to the search mode. By using the Tone Break feature, for each metal group (Fe, Gold/Non-Fe, Non-Fe) you can change the point where the low tone changes into the higher tone.

SETTINGS

To use the Tone Break feature, first select T.BREAK from SETTINGS. The names of the metal groups mentioned above will appear at the bottom of the screen. The Tone Break point of the metal group will be shown on the screen numerically while the cursor at the top will point to it on the ID scale. In some modes, there are 2 tone break points and in some there are 3. To select the metal group, just push the SELECT button. Selection will be framed. To change the value of the break point, plus (+) or minus (-) button is used.

To give an example for the above explanation; let's say you are in the DI3 mode and you want to change the Tone Break points. First, select T.BREAK from SETTINGS. Fe and Gold/Non-Fe will appear at the bottom of the screen and Fe will be framed. The default value of 15 will also be displayed on the screen. Using the plus (+) or the minus (-) button change this number to any value you want. Let's say you increased it to 40. Then, push the SELECT button once to select the Gold/Non-Fe. Let's say you decreased the default value of 66 to 50. In this case, the device will produce a low iron tone for all metals with IDs equal to or less than 40, a medium tone for metals with IDs 41-50 and a high tone for metals with IDs greater than 50 (If you have also adjusted the audio tones (TONE), the selected frequency will apply to the new ID ranges).

Tone Break adjustment applies to the selected search mode only. The change does not affect the other modes.

IMPORTANT! If you are using the Standard ID scale in the multi Kruzer and you change the operating frequency of the device, you may need to re-adjust the Tone Break points according to the IDs you will get in the new frequency.

TONE

Allows you to change the target audio response tones and the threshold sound according to your preference. For each metal group (Fe, Gold/Non-Fe, Non-Fe) the frequency can be adjusted between 150 Hz (15) and 700 Hz (70).

When TONE is selected from the SETTINGS, names of the metal groups mentioned above will appear at the bottom of the screen and the selected one will be framed. To select another group, just press the SELECT button. Then use the plus (+) or the minus (-) button to change the audio frequency.

NOTE: If you want to change the frequency of the 4th tone in the 4 TONE mode, while Non-Fe is selected, press the SELECT button once. The frame will disappear and the audio frequency of the 4th tone will appear on the screen. use the (+) or the (-) button to change it.

TONE adjustment applies to the selected search mode only. The change does not affect the other modes.

Threshold (Thresh.)

In the General Search Mode (GEN), search is performed with a continuous humming sound in the background, also referred to as the threshold sound. The loudness of this hum directly impacts the detection depth of smaller and deeper targets and it is adjusted by the threshold (Thresh.) setting. If the threshold is set too high, a weak target signal may not be heard. On the contrary, if the threshold is too low, you give up the depth advantage this setting offers. In other words, weak signals of smaller or deeper targets may be missed. It is recommended for average users to leave this setting at its default value and for experienced users to adjust to the highest level where they can still hear the weak target signals.

Threshold level is directly related to the Gain and iSAT settings. Please be sure to read the related sections of the manual carefully.

iSAT (Intelligent Self-Adjusting Threshold)

iSAT in General Search Mode (GEN)

For the General Search Mode (GEN) to perform accurately, a stable threshold sound is necessary. You cannot search in the General Search Mode without ground balancing. Changes that occur in the soil structure and mineralization levels after ground balancing, may cause a rise or fall in the background hum and disrupt the threshold's stability which will result in false signals and thus missing signals of small metals. iSAT adjusts the speed that the device recovers its threshold hum and eliminates the negative effects of mineralized soils. Increasing the iSAT in high mineralization will enable a more stable operation by avoiding false signals. This, however, may cause some loss in depth and it is normal.

NOTE: In high mineralization, if you receive too many false signals without disruption in the threshold hum, lower the gain first before increasing the iSAT. If the false signals continue, set the gain back to its original value and increase the iSAT.

If the mineralization is low, you can decrease the iSAT and sweep the coil more slowly for a deeper detection.

iSAT consists of 10 levels. The device will start at level 6. It is recommended that iSAT should be increased in high-mineralization and decreased in low mineralization.

iSAT in Discrimination Modes

It is used to eliminate false signals caused by ground noise or hot rocks when searching in discrimination modes and the available range is between 00-10. Its factory default value is set to (1). You can change the value using the plus (+) and minus (-) buttons.

If the device receives a lot of false signals due to highly mineralized soil or hot rocks in the discrimination modes, first re-ground balance. If the false signals continue, lower the GAIN and check again. In case the false signals still exist, try increasing the DISC. value. Regardless of all these, if the false signals still exist, first change the GAIN and DISC. values back to their previous levels. Then, increase the iSAT level until the false signals are eliminated.

At the maximum level of iSAT, false signals will disappear or will be minimized. However, in some cases, increasing the iSAT will result in loss of depth for certain metals such as copper.

NOTE: When detecting in 19kHz, on wet or highly mineralized ground, in order not to miss smaller high conductive metals (silver, copper etc.) it is recommended not to increase the iSAT level too high.

NOTE: iSAT value ranges between 00-10. The factory default is 01. At "0", the iSAT feature will be inactive. If the ground is not highly mineralized or does not contain many hot rocks, setting the iSAT to "0" is recommended.

Volume

This control allows you to increase or decrease the device's volume based on your preference and environmental conditions. Volume level can be adjusted from 0 to 10. When you turn off and on the device, it will start with the last volume level you chose. This setting is common to all modes; changes will take effect in all modes.

Because the volume level affects power consumption, we recommend you not to increase it more than necessary.

Brightness (BRIGHT.)

It enables you to adjust display backlight level according to your personal preference. It ranges between 0-5 and C1-C5. At 0 level, the backlight is off. When set between 1-5, it lights up only for a short period of time when a target is detected or while navigating the menu and then it goes off. At C1-C5 levels, it will be continuously lit. The continuous operation of the backlight will affect power consumption, which is not recommended.

The backlight setting is restored to the final saved setting when the device is turned off and on again. This setting is common in all modes; change made in any mode also applies to the other modes.

Vibration (VIBRATE)

This feature provides feedback to the user by producing a vibration effect when a target is detected. It can be used independently or together with the audio response. When audio response is disabled, all feedbacks are provided to the user as vibration only during target detection.

Vibration setting is adjusted within the range of 00-05. When it is switched to 0, vibration feature is completely disabled. If the vibration is at 01 level, the device provides long vibration signals and at 05 it provides short vibration signals. The magnitude of the vibration effect can vary according to the depth of the target and the swinging speed. This setting is common in all search modes; change made in any mode also applies to the other modes.

Vibration may not be felt in the General Search mode (GEN) with weak signals; it will be felt as the signal gets stronger. In other words, vibration does not start at the depth where the audio tones are heard but at a lesser depth. Therefore, if you are detecting with vibration only and audio tones are off, you can miss weaker and deeper signals.

Vibration speed is constant in the pinpoint mode and cannot be adjusted. Vibration is off at 0 position. 01-05 values provide the same level of vibration in the pinpoint mode. When vibration is used in the pinpoint mode, vibration speed increases as the target is approached and it reaches the maximum level over the center of the target.

The vibration setting is restored to the final saved setting when the device is turned off and on again. This setting is common in all modes; change made in any mode also applies to the other modes.

Tracking (TRACKING)

When tracking is active (01 position), the device continuously tracks the changing ground structures and automatically reconfigures the ground balance setting. The invisible changes in ground affect the detection depth as well as the discrimination ability of the device so it is possible to operate the device at higher performance using this feature under suitable

ground conditions. **Please refer to page 10 for more information on Tracking.**

When tracking is activated, "Tracking" will be displayed at the bottom of the GB window.

NOTE: Tracking is recommended to be used in the GEN mode only.

Frequency (FREQ.)

This setting has different functions in the **Kruzer** and the **multi Kruzer**. In the **Kruzer**, it is used to shift the frequency and in the **multi Kruzer** it is used to change the operating frequency of the device.

FREQ. Setting in the Kruzer - Frequency Shift

It is used to eliminate the electromagnetic interference that the device receives from another detector which operates in the same frequency range nearby or from the surroundings. If too much noise is received when the search coil is lifted in the air, this may be caused by the local electromagnetic signals or excessive gain settings.

To eliminate the noise caused by electromagnetic interference, try shifting the frequency first (FREQ.) before lowering the gain to obtain maximum depth performance. Frequency shift consists of 5 steps. Default setting is F3 which is the central frequency. You can shift the frequency between F1-F5 using the plus (+) and the minus (-) buttons.

IMPORTANT! Frequency shift may impair performance. Therefore, it is suggested that you do not shift the frequency unless it is necessary.

FREQ. Setting in the multi Kruzer - Changing the frequency

Multi Kruzer offers 3 operating frequencies — 5kHz, 14kHz and 19kHz— to suit different target and soil types.

Based on the frequency selected, the detector's detection performance for different types of targets will vary. The list below includes, but are not limited to, different types of targets that correspond to each frequency:

5kHz: Large ferrous and non-ferrous objects

High conductive coins

Medium or relatively small targets in non-mineralized ground without iron trash

Ferrous masses and militaria

14kHz: General use

Small coins

Different size coins in medium-highly mineralized ground

19kHz: Small coins with different conductivities and thin large coins

Gold coins, rings, small jewelry, sheet iron, foil

Small targets in iron trash

To change the operating frequency of the device, press the **OPTIONS** button first. After selecting the **FREQ.** option, change the frequency using the plus (+) and minus (-) buttons. You will hear the sound of the relay circuit; this is normal. At the same time, lines will start rotating in the middle of the screen and they will stop when the new frequency is active.

Shifting the Frequency in the multi Kruzer:

Just like in the **Kruzer**, it is used to eliminate the electromagnetic interference that the device receives from another detector which operates in the same frequency range nearby or from the surroundings.

To shift the frequency, first select **FREQ.** from **OPTIONS** and then press **SELECT** once.

Frequency shift consists of 5 steps. Default setting is **F3** which is the central frequency. You can shift the frequency between **F1-F5** using the plus (+) and the minus (-) buttons.

Factory Default /Save (FD/SAVE)

With the **FD/SAVE** feature of the **Kruzer**, you can save your settings or restore factory defaults. Save function saves all settings except for the ground balance and tracking. The device starts in the last mode where the save function was performed.

To save your settings, select **FD/SAVE** on screen. Two dashes (--) will be displayed on screen. Push the right button. When "**SA**" is displayed, press the **SELECT** button once. You will see lines rotating in the middle of the screen. When the saving is completed, the lines will stop rotating and the **SA** text will disappear.

To go back to factory defaults, select **FD/Save** on screen. Two dashes (--) will be displayed on screen. Push the left button. When "**Fd**" is displayed, press the **SELECT** button once. You will see lines rotating in the **GB** window on the right side. When the process is completed, the lines will stop rotating and the **Fd** text will disappear.

Wireless Connection (WIRELESS)

It is used to turn on and off the wireless headphones connection and to change the channel.

After choosing the **WIRELESS** option, you can change the channels between **00-19** or you can completely turn the wireless connection off by choosing the **oF** position.

For more detailed info about the wireless headphones, please read the instructions included with the headphones.

EXTRA UNDERGROUND DEPTH (E.U.D.)

The target IDs of metals in high mineralization and under hot rocks or at fringe depths may be reflected differently on the device than what they really are.

Based on the DISC. setting, you may experience a depth loss for such metals or the device may not detect these metals at all.

The E.U.D feature of the **Kruzer** enables you to detect such metals deeper utilizing a different tone than the other tones of the device. When using the E.U.D, the device does not discriminate metals and it provides the same tone for all targets.

You can use the E.U.D feature of the device 2 ways: Instantly or continuously. To use the feature instantly, you must keep the SELECT button pushed down, and to use it continuously you must double click the SELECT button. In both cases, the frame around the selected search mode will keep on blinking.

E.U.D will not work in the GEN and BEACH modes. If you are using the E.U.D constantly, unless you turn it off, the feature will be active even if you change the search mode.

NOTE: Because this feature enables the device to detect some targets that are normally masked by ground conditions and thus are undetectable, it is possible to dig more ferrous targets when using this feature.

PINPOINT

Pinpoint is to find the center or the exact location of a detected target.

Kruzer is a motion detector (except for the static modes). In other words, you are required to move the search coil over the target or the target over the search coil in order for the device to detect the target. The pinpoint mode is a non-motion mode. The device continues to give a signal when the search coil is kept stationary over the target.

Ground balance should be performed properly in order to ensure precise pinpointing. It is recommended to perform ground balance again before performing pinpoint operation on changing ground structures.

In the pinpoint mode, estimated target depth is shown on the display. In the pinpoint mode, the signal tone increases in pitch and volume as the search coil approaches the target. In this mode, the device does not discriminate or give target IDs. If the device is in the vibration mode, the speed of vibration will increase as you get closer to the center of target.

To perform pinpoint:

- 1) After a target is detected, move the search coil aside where there is no target response and push the PP button.
- 2) Keep the button pressed down and bring the search coil closer to the target slowly and parallel to the ground.
- 3) Signal sound becomes stronger and changes in pitch while getting closer to the target center and also the number indicating target depth on the display decreases.
- 4) Mark the position which provides the loudest sound using a tool or your foot.

5) Repeat the above procedure by changing your direction 90°. Actions to be performed from a couple of different directions will narrow the target area and provide you with the most exact details of the target location.

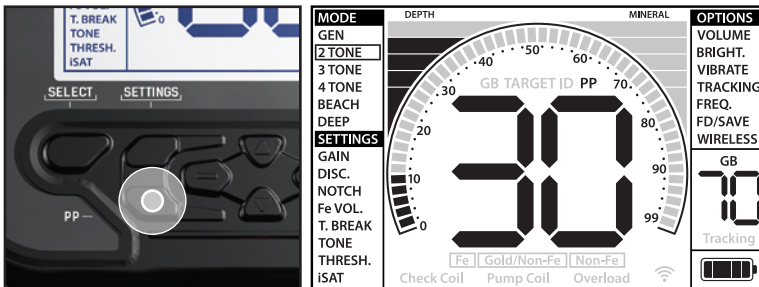

TARGET DEPTH

The device provides an estimated target depth according to the signal strength both during detection and in the pinpoint mode.

Depth Indicator: It shows the target's proximity to the surface in 5 levels during detection.

Because each mode of the **Kruzer** has different depth, the depth indicator will display a different depth level for the same target in different modes.

In the pinpoint mode, estimated target depth is shown on the display in cms (or inches - please see below for details) while getting closer to the target.

Depth detection is adjusted presuming that the target is a 2.5cm (1") coin. Actual depth varies according to the size of the target. For instance, the detector will indicate more depth for a target smaller than a 2.5cm (1") coin and less depth for a larger target. In reality, pinpoint procedure is not intended for depth determination but exact location determination. Therefore, it is recommended that the depth indicator on the display is used for determining the proximity to the target.

IMPORTANT! If you want the target depth to be displayed in inches instead of cms please do the following: While the device is off, press and hold the **SELECT** and **OPTIONS** buttons simultaneously and turn the device on. "In" will be displayed. To switch back to cms, you need to turn the device off and then repeat the above procedure. While the device is initializing, "SI" will be displayed.

LARGE OR NEAR-SURFACE TARGETS

Targets which are near the surface may give multiple different signals to the device. If you suspect a target near the surface, lift the search coil and swing it more slowly until a single signal is received. Also, if there is a large target near the surface it may cause an overload in the search coil and the device starts to generate a continuous sound which resembles a siren. "Overload" message is shown on the display simultaneously. In such a case, lift the search coil up until the message disappears.

FALSE SIGNALS AND REASONS

Sometimes, the device may produce signals which are similar to a target signal although no metal target is present. There are various reasons for the false signals received by the

device. The most common ones are ground mineralization or rocks with high mineral content, surrounding electromagnetic signals, operation of another nearby detector, rusted or corroded iron or foil in the soil, gain or threshold values set too high.

Surrounding electromagnetic signals can be eliminated by reducing the gain. If another detector is operating nearby, you may attempt to shift the frequency or perform your search at a distance where no interference occurs. If these do not improve the situation, in the **multi Kruzer**, you may try changing the operating frequency (5kHz/14kHz/19kHz) of the device. For ground mineralization or rocks with high mineral content, and gain and threshold set too high, please read the related sections.

MAGNETIC MINERALIZATION INDICATOR

The Magnetic Mineralization Indicator consists of 5 levels. The indicator bars do not rise at low mineral levels during search and at start up. In areas where the magnetic mineral level is high, the indicator bars will rise according to the intensity. This measurement can be summarized as the level of magnetic property and intensity of the ground.

This measurement is important from two aspects. First, on grounds with high magnetic mineralization, search depth is low and users should be aware of this fact. Second, magnetic mineralization is a property which is particularly seen with mineralized rocks and this measurement plays an important role for the device to eliminate the false signals produced by these rocks.

ROCKS AND SEARCHING IN ROCKY TERRAINS (GENERAL AND DISCRIMINATION MODES)

Challenging ground conditions arise especially when conductivity and magnetic properties of the ground is too intense. Operation of the device over such ground is made possible by selecting the best operating mode and frequency (**multi Kruzer**) as well as using proper ground balance, gain, iSAT and threshold settings.

Stones and rocks or cavities inside the ground are as important as the ground itself in regards to the search and target detection quality.

Soil and rocks have two different properties just like the targets you are searching for. One of them is the intensity and the other one is the conductivity - magnetic permeability ratio and these two properties are independent from each other. In this manual, the conductivity - magnetic permeability ratio will be referred to as ID in short. High magnetic permeability, low conductivity results in low ID. Soil or rocks can be highly permeable and have low or high IDs as well. If the conductivity increases relatively to magnetic permeability then the ID will also increase.

Hot rocks are classified as negative or positive based on their ID being low or high in comparison to the ID of the soil they are in. One or both of the types may be present in a field. The negative and positive effects mentioned here will only be valid if ground balancing is properly done on the existing ground. Otherwise, soil itself will not act differently from hot rocks in terms of ID. In "TRACKING" however, conditions will differ. Therefore, the effects of rocks in tracking will be discussed separately. Here we are referring to a proper ground balance without tracking.

Positive rocks act just like metal and produce a metal sound. In the General Search Mode (GEN) they produce a "zip zip" sound when the search coil is moved over them. If the signal is strong enough, the device may produce an ID for these rocks. Negative rocks in the

General Search mode, produce a long “boing” sound when the search coil is moved over them. The device does not give an ID for these rocks even if the signal is strong.

Positive rocks provide a typical metal sound in discrimination modes. Negative rocks do not provide a sound in discrimination modes (except for rare cases of false signals).

At higher settings of iSAT, there will be no change in the sounds of positive or negative hot rocks. As the iSAT value is decreased, the sound of positive hot rocks will remain the same but the negative hot rocks may give a thinner beep sound instead of the boing sound.

Therefore, you can make a decision by listening to the audio responses produced by the device in the field. If you receive a metal sound, it means that you either detected a positive rock or a piece of metal. If you receive a strong signal and a stable ID, you can distinguish if the detected target is a rock or metal by checking the ID. However, remember that weak signals may produce different IDs and metals under rocks may produce different metal signals. Therefore, the most appropriate action is to dig up when a metal signal is received.

If you are operating with discrimination modes and you know the ID of the surrounding rocks, you can use the DISC. setting to eliminate the rocks. However, this may not be sufficient to avoid all rock signals. The device may still receive signals from rocks because soil and rocks together will form a combined effect and generate a different ID than those of rocks.

TRACKING AND EFFECTS OF ROCKS

When the tracking is active, the device may give an audio response and ID when it passes over a hot rock because the effect of the rock will be different than the ground's. If you swing the search coil over the rock, tracking will automatically adjust the setting and the audio response/ID will either disappear or diminish significantly. Because there is a slight delay in tracking, you may hear a strong signal at the first one or two swings until the setting is adjusted. Then the sound will get weaker and disappear. This will not happen with metal targets because metals will prevent the device from ground balancing. Therefore, in tracking, if you are getting a constant signal over a target after repeated swings, there is a high possibility that the target is a metal. Moving from over a rock back to soil, the device may give signals to the ground for a few swings until the ground balance setting is updated again. This is normal and should not mislead you.

Tracking is not recommended to eliminate rocks under normal conditions. It is recommended for use in areas with changing soil types.

METALS UNDER ROCKS

Kruzer increases the possibility of detecting metal targets under mineralized rocks through the proper adjustment of your settings. The combined effect created by the rock and metal together is lower than the effect that the metal creates by itself and the displayed ID will be different than the metal's expected ID. The displayed ID is formed by the combination of rock and metal together and gets closer to the ID of the rock if the size of the metal is smaller in relation to the rock. Keep in mind that metals under hot rocks will never appear with their own metal ID. For instance, a gold piece under a brick may produce an iron tone and ID.

Remember this very simple principle as it will save you lots of time: “If the target you detect is not a stone, it can be metal”.

The key to detecting targets under mineralized rocks, particularly when positive rocks are in question, is the knowledge of the maximum ID value produced by the surrounding positive rocks. If you are performing a search in the General Search mode (GEN), monitor the ID produced by the device. If the ID provided by your device is close to the rock and iron zone, it is quite possible that you detected a target under the rock. In the case of using DISC. in the GEN mode, all rocks below the Disc. level will produce a low iron tone and all above will produce a higher tone.

If you filter off the rocks with a correctly adjusted DISC. setting in discrimination modes, you can hear the signal of the target under the rock if the target signal has a slightly greater effect than the filtered ID. The important thing here is that if you detect a target and dig out a rock, you should note the ID you got before digging and use it as the Disc. value the next time.

For instance; the hot rocks in your search field tend to give IDs around 00-01. In this case, you should set the DISC. to maximum 02. This way you can eliminate rocks and receive the signals of metals underneath. If you set the Disc. too high unnecessarily, you will lose metals along with rocks.

If the hot rocks in your search area tend to give high IDs, then the chances of missing the signals of small metals underneath will be high as well.

SEARCHING ON THE BEACH AND UNDERWATER

Kruzer is a waterproof metal detector. This provides convenient detection underwater and on the beach.

As explained before, salt water and alkali grounds are significantly conductive and cause effects similar to iron in detectors. **Kruzer's** BEACH mode is specially designed for such conditions. You can perform your search easily using the BEACH mode without requiring any special settings.

BEACH mode is ideal for salty wet beach sand. You can use the other modes while performing search over dry beach sand.

You should consider the following while performing search over wet beach sand or underwater:

- 1) When you swing the search coil over the holes you dig in wet beach sand, you can receive metal signals, this is a normal condition.
- 2) The search coil may give false signals when going into and coming out of the water so please try to keep the coil either in or out of the water.

Pay attention to the items bellows after using the device especially under salty water:

1. Wash the system box, shaft and the coil with tap water and be sure no salt water is left in the connectors.
2. Do not use any chemicals for cleaning and/or for any other purposes.
3. Wipe the screen and the shaft dry with a soft, non-scratch cloth.

MESSAGES

Warning messages are shown at the bottom of the display. Messages that may appear are as follows:

Overload

It appears on the display simultaneously with the overload alarm. This happens when the search coil encounters a near surface or a very large object. The device reverts back to normal operation if you lift the coil up. If the alarm and the message continue along a long line, you may be over a long metal such as a pipe.

In case of high mineralization, the device may overload. If the cause of overloading is not a large metal, it may be the ground itself and this situation may be overcome by lowering the gain.

Pump Coil

This message appears when the GB button is pressed for ground balancing. It does not indicate any error or problem. It only indicates what should be done.

Check Coil

It indicates an interruption in the search coil transmitter signal. The search coil connector may be unattached, loose or disconnected. If you own another detector with the same coil connector, please be sure that you have not attached the wrong coil by mistake. If none of the above exists, the search coil or its cable may have a defect. If the issue continues when you change the search coil, there may be an issue in the coil control circuit.

SOFTWARE UPDATE

Kruzer has software update capability. All software updates made after the device is released to the market will be announced on the product's web page along with updating instructions.

System Version Information:

To see the software version of the **Kruzer's** system card and LCD, while the device is OFF, press the plus (+) and minus (-) buttons simultaneously and turn the unit on. Continue to hold the buttons depressed until you can read the software version. The major version will be shown in the Target ID section and the minor version in the GB window.



TECHNICAL SPECIFICATIONS

Operating Principle	: VLF
Operating Frequency	: Kruzer: 14kHz Multi Kruzer: 5kHz/14kHz/19kHz
Audio Frequencies	: 150 Hz - 700Hz adjustable
Search Modes	: 6
Iron Audio	: Yes
Tone Break	: Yes
Notch Filter	: Yes
Ground Balance	: Automatic / Manual / Tracking
Pinpoint	: Yes
Frequency Shift	: Yes
Vibration	: Yes
Gain Setting	: 01-99
Target ID	: 00-99
Search Coil	: KR28 Waterproof DD 28 x 18 cm (11" x 7")
Display	: Custom LCD
Backlight:	: Yes
Weight	: 1.4 kg (3lbs.) including the search coil
Length	: 111cm -135,5cm ayarlanabilir
Battery	: 3700mAh Lithium Polymer
Warranty	: 2 years

Makro Detectors reserves the right to change the design, specifications or accessories without notice and without any obligation or liability whatsoever.

	TARGET IDs		
	Kruzer: 14kHz multi Kruzer: 5/14/19kHz		
	5kHz	14kHz (normal)	19kHz
2 Euro	33	52	57
1 Euro	40	68	75
Euro 50 Cent	49	70	77
Euro 20 Cent	40	66	72
Euro 10 Cent	34	59	67
US Coins			
US Quarter	72	87	90
US Nickel	21	30	36
US Dime	60	78	82
US Zinc Penny	38	66	71
US Copper Penny	61	79	84
US Half Dollar	83	93	95
US Silver Dollar	88	96	96
UK Coins			
One Pound (1982)	40	67	72
Two Pounds (2006)	48	71	77
Fifty Pence (2008)	23	35	44
Twenty Pence (1982)	24	38	51
Two Pence (1988)	70	86	90
Penny (1918)	40	66	71
1938 Shilling	47	69	75
1921 Half Crown	70	84	89
1928 Six Pence	30	53	62
1868 Six Pence	55	74	79
1842 Four Pence	49	69	75
1952 Three Pence	56	74	80
IMPORTANT! In the multi Kruzer, if you are using the "Normalized" ID scale, the device will produce the 14kHz IDs in all frequencies. Some differences may be observed between the frequencies for certain metals and soil conditions.			

FCC ID: 2AJJ2-KRUZER

NOKTA MUHENDISLIK INS. ELEK. PLAS. GIDA VE REKLAM SAN. TIC. LTD. STI.

Model name: METAL DETECTOR

Model No.: Kruzer

This device complies with Part 15 of the FCC rules. Operation is subject to the following two conditions: 1) this device may not cause harmful interference, and 2) this device must accept any interference received, including interference that may cause undesired operation.

Changes or modifications not expressly approved by the party responsible for compliance could void the user's authority to operate the equipment.

Note: This equipment has been tested and found to comply with the limits for a Class B digital device, pursuant to part 15 of the FCC Rules. These limits are designed to provide reasonable protection against harmful interference in a residential installation. This equipment generates, uses and can radiate radio frequency energy and, if not installed and used in accordance with the instructions, may cause harmful interference to radio communications. However, there is no guarantee that interference will not occur in a particular installation. If this equipment does cause harmful interference to radio or television reception, which can be determined by turning the equipment off and on, the user is encouraged to try to correct the interference by one or more of the following measures:

- Reorient or relocate the receiving antenna.
- Increase the separation between the equipment and receiver.
- Connect the equipment into an outlet on a circuit different from that to which the receiver is connected.
- Consult the dealer or an experienced radio/TV technician for help.

MAKRO

METAL DETECTORS

www.makrodetector.com

