

# TEST REPORT

**Applicant:** CREATIVE LABS PTE. LTD.  
**Address:** 31 International Business Park #03-01, Singapore 609921  
**Equipment Type:** Creative Stage Air V2  
**Model Name:** MF8395  
**Brand Name:** CREATIVE  
**FCC ID:** 2AJIV-MF8395  
**ISED Number:** 20469-MF8395  
**Test Standard:** 47 CFR Part 15 Subpart C  
RSS-Gen Issue 5  
RSS-247 Issue 2  
(refer section 3.1)  
**Test Date:** Jan. 27, 2022 - Mar. 01, 2022  
**Date of Issue:** May 05, 2022

**ISSUED BY:**

Shenzhen BALUN Technology Co., Ltd.

**Tested by:** Julie Zhu

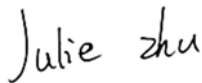

**Checked by:** Ye Hongji



**Approved by:** Liao Jianming  
(Technical Director)



<b>Revision History</b>		
Version	Issue Date	Revisions
<u>Rev. 01</u>	<u>May 05, 2022</u>	<u>Initial Issue</u>

## TABLE OF CONTENTS

1	GENERAL INFORMATION .....	4
1.1	Identification of the Testing Laboratory .....	4
1.2	Identification of the Responsible Testing Location .....	4
2	PRODUCT INFORMATION .....	5
2.1	Applicant Information.....	5
2.2	Manufacturer Information .....	5
2.3	General Description for Equipment under Test (EUT) .....	5
2.4	Technical Information .....	6
2.5	Additional Instructions .....	8
3	SUMMARY OF TEST RESULTS.....	9
3.1	Test Standards .....	9
3.2	Test Verdict .....	10
4	GENERAL TEST CONFIGURATIONS.....	11
4.1	Test Environments .....	11
4.2	Test Equipment List.....	11
4.3	Test Software List.....	11
4.4	Measurement Uncertainty .....	12
4.5	Description of Test Setup .....	12
4.6	Measurement Results Explanation Example.....	15
5	TEST ITEMS.....	16
5.1	Antenna Requirements.....	16
5.2	Frequency Hopping Systems .....	17
5.3	Number of Hopping Frequencies .....	19
5.4	Peak Output Power and E.I.R.P .....	20

5.5	Occupied Bandwidth .....	21
5.6	Carrier Frequency Separation .....	22
5.7	Time of Occupancy (Dwell time) .....	23
5.8	Conducted Spurious Emission & Authorized-band band-edge .....	25
5.9	Conducted Emission .....	26
5.10	Radiated Spurious Emission .....	27
5.11	Band Edge (Restricted-band band-edge).....	29
ANNEX A	TEST RESULT .....	30
A.1	Number of Hopping Frequency .....	30
A.2	Peak Output Power and E.I.R.P .....	31
A.3	20 dB and 99% bandwidth .....	34
A.4	Hopping Frequency Separation.....	39
A.5	Average Time of Occupancy .....	40
A.6	Conducted Spurious Emissions & Authorized-band band-edge .....	43
A.7	Conducted Emissions.....	50
A.8	Radiated Spurious Emission .....	52
A.9	Band Edge (Restricted-band band-edge).....	66
ANNEX B	TEST SETUP PHOTOS .....	70
ANNEX C	EUT EXTERNAL PHOTOS .....	70
ANNEX D	EUT INTERNAL PHOTOS .....	70

# 1 GENERAL INFORMATION

## 1.1 Identification of the Testing Laboratory

Company Name	Shenzhen BALUN Technology Co., Ltd.
Address	Block B, 1/F, Baisha Science and Technology Park, Shahe West Road, Nanshan District, ShenZhen, GuangDong Province, China
Phone Number	+86 755 6685 0100

## 1.2 Identification of the Responsible Testing Location

Test Location	Shenzhen BALUN Technology Co., Ltd.
Address	Block B, 1/F, Baisha Science and Technology Park, Shahe West Road, Nanshan District, ShenZhen, GuangDong Province, China
Accreditation Certificate	The laboratory is a testing organization accredited by FCC as a accredited testing laboratory. The designation number is CN1196. The laboratory has been listed by Industry Canada to perform electromagnetic emission measurements. The recognition numbers of test site are 11524A.
Description	All measurement facilities used to collect the measurement data are located at Block B, 1/F, Baisha Science and Technology Park, Shahe West Road, Nanshan District, ShenZhen, GuangDong Province, China

## 2 PRODUCT INFORMATION

### 2.1 Applicant Information

Applicant	CREATIVE LABS PTE. LTD.
Address	31 International Business Park #03-01, Singapore 609921

### 2.2 Manufacturer Information

Manufacturer	CREATIVE LABS PTE. LTD.
Address	31 International Business Park #03-01, Singapore 609921

### 2.3 General Description for Equipment under Test (EUT)

EUT Name	Creative Stage Air V2
Model Name Under Test	MF8395
Series Model Name	N/A
Description of Model name differentiation	N/A
Serial Number	01MF839500000
Hardware Version	FS65B-Ver1.4
Software Version	FS65B-(Creative Stage Air V2)2853-220121-v4.1
Dimensions (Approx.)	N/A
Weight (Approx.)	N/A

## 2.4 Technical Information

Network and Wireless connectivity	Bluetooth (BR+EDR)
-----------------------------------	--------------------

The requirement for the following technical information of the EUT was tested in this report:

Modulation Technology	FHSS
Modulation Type	GFSK, $\pi/4$ -DQPSK, 8-DPSK
Product Type	<input checked="" type="checkbox"/> Mobile <input type="checkbox"/> Portable <input type="checkbox"/> Fix Location
Transfer Rate	DH5: 1 Mbps 2DH5: 2 Mbps 3DH5: 3 Mbps
Frequency Range	The frequency range used is 2400 MHz to 2483.5 MHz.
Number of Channel	79 (at intervals of 1 MHz)
Tested Channel	0 (2402 MHz), 39 (2441 MHz), 78 (2480 MHz)
Antenna Type	PCB Antenna
Antenna Gain	0.1 dBi (In test items related to antenna gain, the final results reflect this figure. This value is provided by the applicant.)
Antenna Impedance	50 $\Omega$
Antenna System (MIMO Smart Antenna)	N/A

All channel was listed on the following table:

Channel number	Freq. (MHz)	Channel number	Freq. (MHz)	Channel number	Freq. (MHz)	Channel number	Freq. (MHz)
<b>0</b>	<b>2402</b>	21	2423	42	2444	63	2465
1	2403	22	2424	43	2445	64	2466
2	2404	23	2425	44	2446	65	2467
3	2405	24	2426	45	2447	66	2468
4	2406	25	2427	46	2448	67	2469
5	2407	26	2428	47	2449	68	2470
6	2408	27	2429	48	2450	69	2471
7	2409	28	2430	49	2451	70	2472
8	2410	29	2431	50	2452	71	2473
9	2411	30	2432	51	2453	72	2474
10	2412	31	2433	52	2454	73	2475
11	2413	32	2434	53	2455	74	2476
12	2414	33	2435	54	2456	75	2477
13	2415	34	2436	55	2457	76	2478
14	2416	35	2437	56	2458	77	2479
15	2417	36	2438	57	2459	<b>78</b>	<b>2480</b>
16	2418	37	2439	58	2460	-	-
17	2419	38	2440	59	2461	-	-
18	2420	<b>39</b>	<b>2441</b>	60	2462	-	-
19	2421	40	2442	61	2463	-	-
20	2422	41	2443	62	2464	-	-

## 2.5 Additional Instructions

EUT Software Settings:

Mode	<input checked="" type="checkbox"/> Bluetooth test mode loop back enabled. EUT is controlled over CBT / CMW.
------	---

During testing, Channel and Power Controlling Software provided by the customer was used to control the operating channel as well as the output power level. The RF output power selection is for the setting of RF output power expected by the customer and is going to be fixed on the firmware of the final end product.

Power level setup in software			
Test Software Version	The prototype was powered on and entered the test mode to control the fixed frequency.		
Mode	Channel	Frequency (MHz)	Soft Set
DH5	CH0	2402	TX LEVEL is built-in set parameters and cannot be changed and selected.
	CH39	2441	
	CH78	2480	
2DH5	CH0	2402	
	CH39	2441	
	CH78	2480	
3DH5	CH0	2402	
	CH39	2441	
	CH78	2480	



### 3 SUMMARY OF TEST RESULTS

#### 3.1 Test Standards

No.	Identity	Document Title
1	47 CFR Part 15, Subpart C	Miscellaneous Wireless Communications Services
2	RSS-Gen Issue 5	General Requirements for Compliance of Radio Apparatus
3	RSS-247 Issue 2	Digital Transmission Systems (DTSs), Frequency Hopping Systems(FHSs) and Licence-Exemp Local Area Network (LE-LAN) Devices
4	ANSI C63.10-2013	American National Standard for Testing Unlicensed Wireless Devices
5	KDB 558074 D01 15.247 Meas Guidance v05r02	Guidance for compliance measurements on digital transmission system, frequency hopping spread spectrum system, and hybrid system devices operating under section 15.247 of the FCC rules

### 3.2 Test Verdict

No.	Description	FCC Part No.	ISED Part No.	Channel	Test Result	Verdict	Remark
1	Antenna Requirement	15.203	RSS-247, 5.4 (f)	N/A	--	Pass	Note <sup>1</sup>
2	Number of Hopping Frequencies	15.247(a)	RSS-247, 5.1 (d)	Hopping Mode	ANNEX A.1	Pass	Note <sup>2</sup>
3	Peak Output Power and E.I.R.P	15.247(b)	RSS-247, 5.4 (b)	Low/Middle/High	ANNEX A.2	Pass	--
4	Occupied Bandwidth	15.247(a)	RSS-247, 5.1 (a)	Low/Middle/High	ANNEX A.3	Pass	Note <sup>2</sup>
5	Carrier Frequency Separation	15.247(a)	RSS-247, 5.1 (b)	Hopping Mode	ANNEX A.4	Pass	Note <sup>2</sup>
6	Time of Occupancy (Dwell time)	15.247(a)	RSS-247, 5.1 (d)	Hopping Mode	ANNEX A.5	Pass	Note <sup>2</sup>
7	Conducted Spurious Emission & Authorized-band band-edge	15.247(d)	RSS-247, 5.5	Low/Middle/High	ANNEX A.6	Pass	Note <sup>2</sup>
8	Conducted Emission	15.207	RSS-GEN, 8.8	Low/Middle/High	ANNEX A.7	Pass	Note <sup>2</sup>
9	Radiated Spurious Emission	15.209 15.247(d)	RSS-247, 5.5	Hopping Mode, Low/Middle/High	ANNEX A.8	Pass	Note <sup>2</sup>
10	Band Edge(Restricted-band band-edge)	15.209 15.247(d)	RSS-247, 5.5	Hopping Mode, Low/Middle/High	ANNEX A.9	Pass	Note <sup>2</sup>
11	Receiver Spurious Emissions	--	RSS-Gen, 7.3	--	--	N/A	Note <sup>3</sup>

Note <sup>1</sup>: Please refer to section 5.1

Note <sup>2</sup>:  $\pi/4$ -DQPSK is the EDR 2M rate mode, 8-DPSK is the EDR 3M rate mode. The consistency of test results in  $\pi/4$ -DQPSK and 8-DPSK is very high. So we chose 8-DPSK as a typical representative to appear on the report. Another we will show all the modes on the RF output power test item.

Note <sup>3</sup>: Only radio communication receivers operating in stand-alone mode within the band 30-960 MHz, as well as scanner receivers, are subject to Industry Canada requirements, so this test is not applicable.

## 4 GENERAL TEST CONFIGURATIONS

### 4.1 Test Environments

During the measurement, the normal environmental conditions were within the listed ranges:

Relative Humidity	45% to 55%	
Atmospheric Pressure	100 kPa to 102 kPa	
Temperature	NT (Normal Temperature)	+22°C to +25°C
Working Voltage of the EUT	NV (Normal Voltage)	3.7V

### 4.2 Test Equipment List

Description	Manufacturer	Model	Serial No.	Cal. Date	Cal. Due
Spectrum Analyzer	ROHDE&SCHWARZ	FSV-40	101544	2022.01.04	2023.01.03
Spectrum Analyzer	KEYSIGHT	N9020A	MY50330200	2021.06.01	2022.05.31
Bluetooth Signaling Unit	ROHDE&SCHWARZ	CMW500	142028	2021.06.01	2022.05.31
EMI Receiver	KEYSIGHT	N9038A	MY53220118	2021.09.13	2022.09.12
EMI Receiver	ROHDE&SCHWARZ	ESRP	101036	2021.10.10	2022.10.09
LISN	SCHWARZBECK	NSLK 8127	8127-687	2021.06.08	2022.06.07
Test Antenna-Loop(9 kHz-30 MHz)	SCHWARZBECK	FMZB 1519	1519-037	2021.04.16	2024.04.15
Test Antenna-Bi-Log(30 MHz-3 GHz)	SCHWARZBECK	VULB 9163	9163-624	2021.08.20	2024.08.19
Test Antenna-Horn(1-18 GHz)	SCHWARZBECK	BBHA 9120D	9120D-1917	2019.07.02	2022.07.01
Test Antenna-Horn (18-40 GHz)	A-INFO	LB-180400KF	J211060273	2021.07.02	2024.07.01
Anechoic Chamber	RAINFORD	9m*6m*6m	N/A	2021.09.04	2024.09.09
Anechoic Chamber	EMC Electronic Co., Ltd	20.10*11.60*7.35m	N/A	2021.08.15	2024.08.14
Shielded Enclosure	ChangNing	CN-130701	130703	--	--

### 4.3 Test Software List

Description	Manufacturer	Software Version	Serial No.	Applicable test Setup
BL410R	BALUN	V2.1.1.488	N/A	The section 4.5.1
BL410E	BALUN	V19.8.28.435	N/A	The section 4.5.2&4.5.3&4.5.4&4.5.5

## 4.4 Measurement Uncertainty

The following measurement uncertainty levels have been estimated for tests performed on the EUT as specified in CISPR 16-4-2.

This uncertainty represents an expanded uncertainty expressed at approximately the 95% confidence level using a coverage factor of k=2.

Parameters	Uncertainty
Occupied Channel Bandwidth	2.8%
RF output power, conducted	1.28 dB
Power Spectral Density, conducted	1.30 dB
Unwanted Emissions, conducted	1.84 dB
All emissions, radiated	5.36 dB
Temperature	0.82°C
Humidity	4.1%

## 4.5 Description of Test Setup

### 4.5.1 For Antenna Port Test

Conducted value (dBm) = Measurement value (dBm) + cable loss (dB)

For example: the measurement value is 10 dBm and the cable 0.5dBm used, then the final result of EUT:  
Conducted value (dBm) = 10 dBm + 0.5 dB = 10.5 dBm

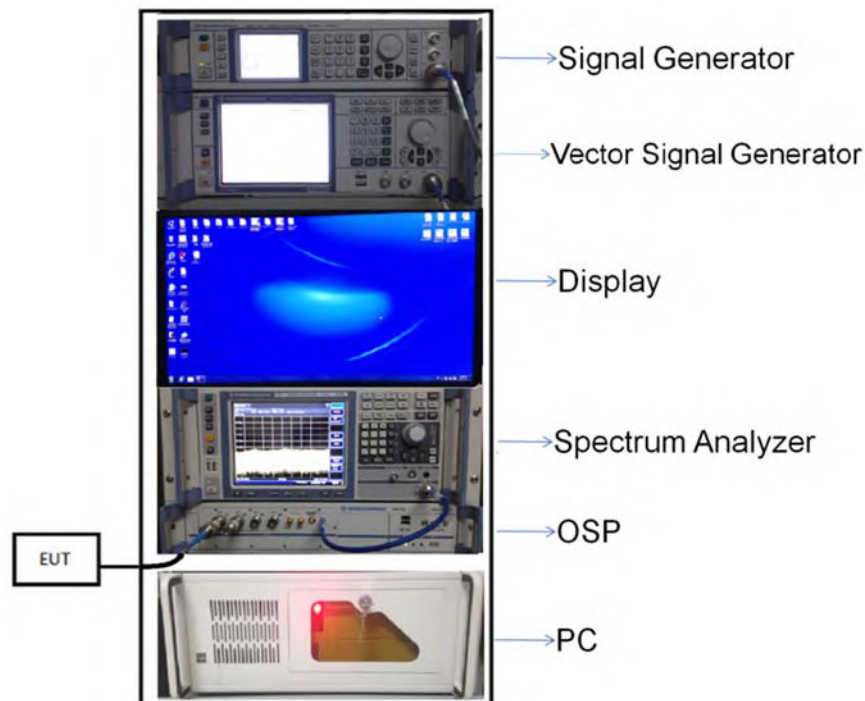

(Diagram 1)

### 4.5.2 For AC Power Supply Port Test

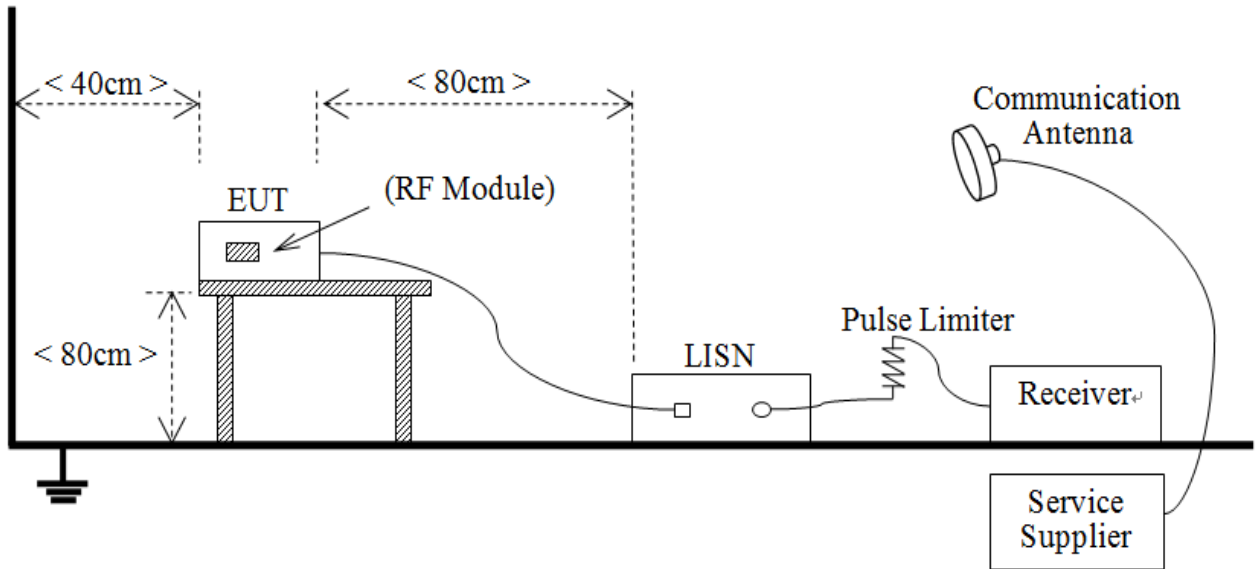

(Diagram 2)

### 4.5.3 For Radiated Test (Below 30 MHz)

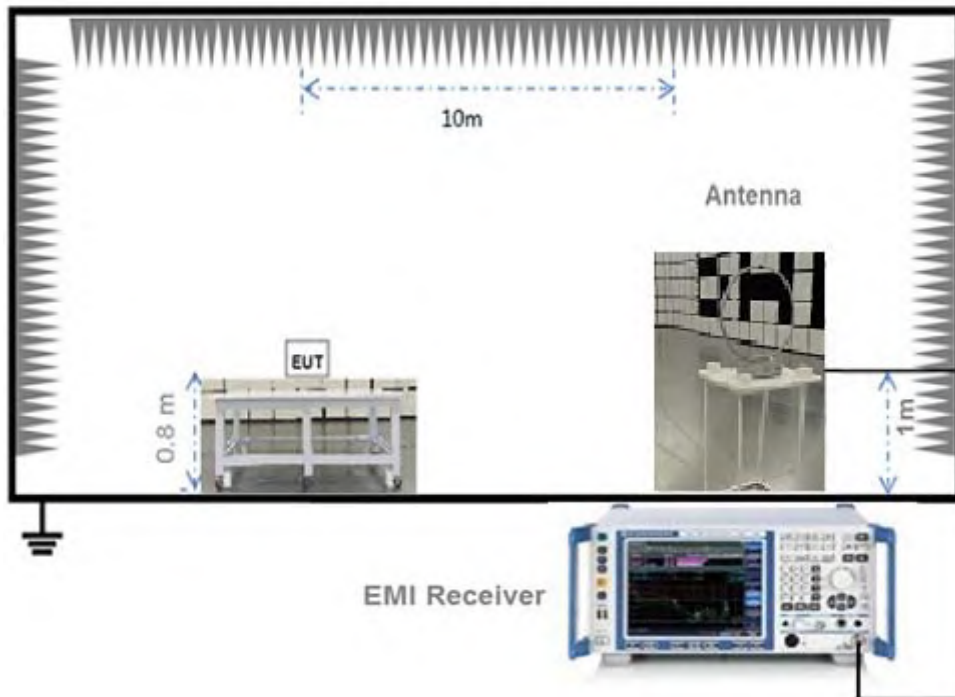

(Diagram 3)

#### 4.5.4 For Radiated Test (30 MHz-1 GHz)

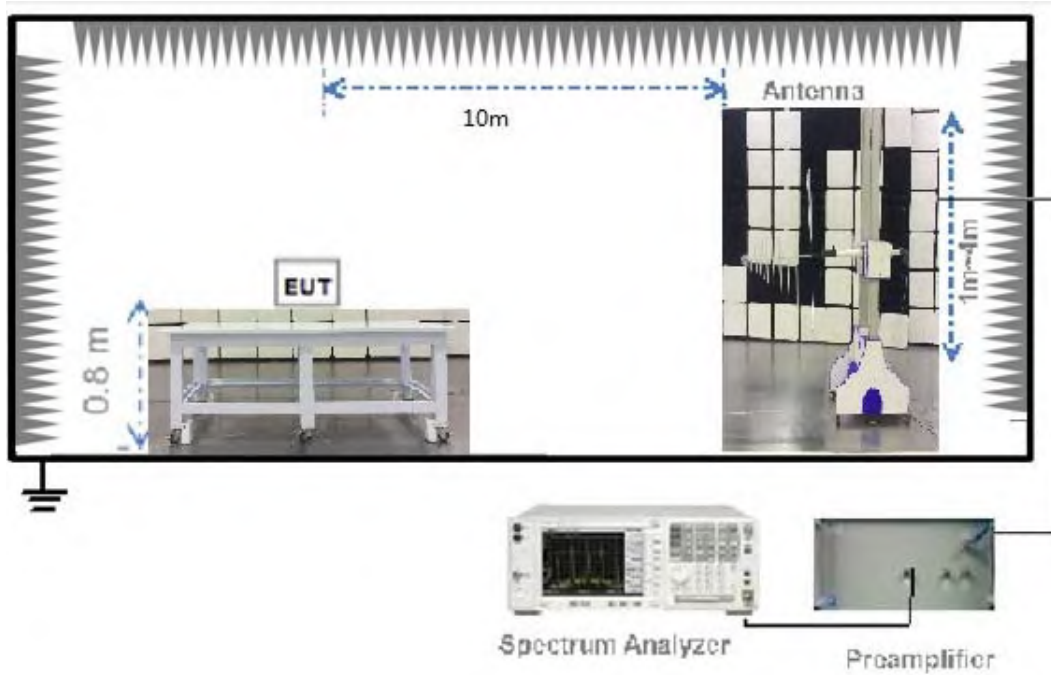

(Diagram 4)

#### 4.5.5 For Radiated Test (Above 1 GHz)

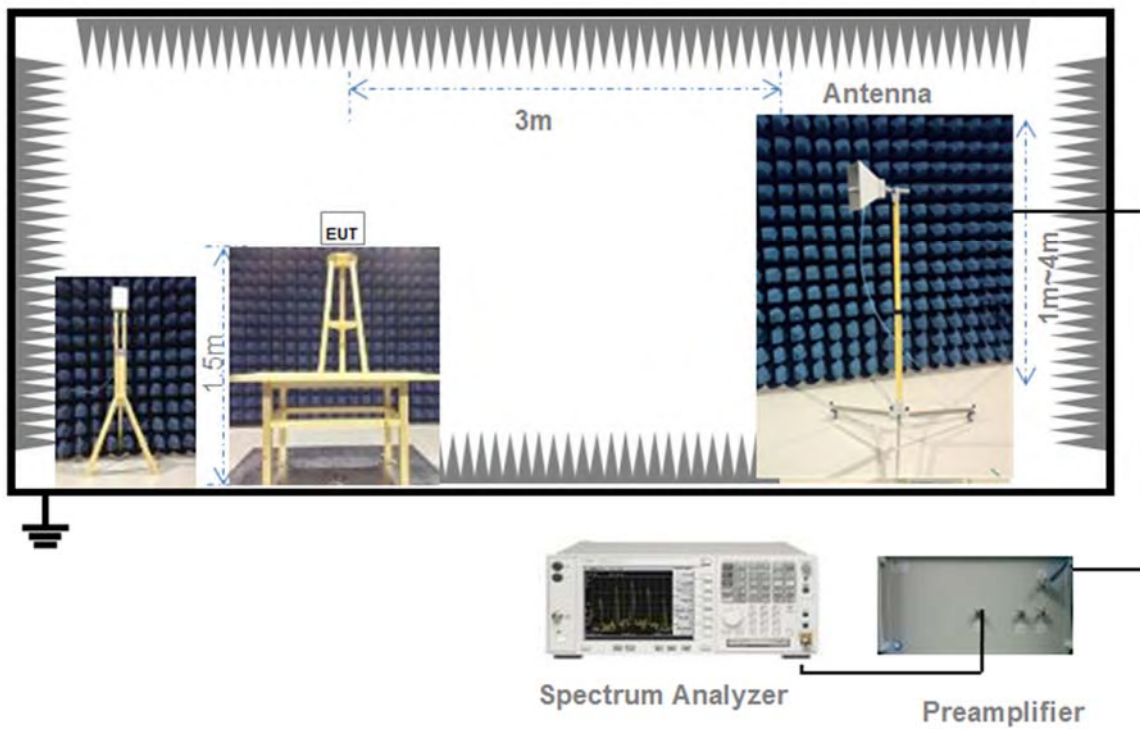

(Diagram 5)

## 4.6 Measurement Results Explanation Example

### 4.6.1 For conducted test items:

The offset level is set in the spectrum analyzer to compensate the RF cable loss and attenuator between EUT conducted output port and spectrum analyzer. With the offset compensation, the spectrum analyzer reading level is exactly the EUT RF output level.

The spectrum analyzer offset is derived from RF cable loss and attenuator factor.

Offset = RF cable loss + attenuator factor.



## 5 TEST ITEMS

### 5.1 Antenna Requirements

#### 5.1.1 Relevant Standards

FCC §15.203 & 15.247(b); RSS-247, 5.4 (f)

An intentional radiator shall be designed to ensure that no antenna other than that furnished by the responsible party shall be used with the device. The use of a permanently attached antenna or of an antenna that uses a unique coupling to the intentional radiator shall be considered sufficient to comply with the provisions of this section. The manufacturer may design the unit so that a broken antenna can be replaced by the user, but the use of a standard antenna jack or electrical connector is prohibited. This requirement does not apply to carrier current devices or to devices operated under the provisions of § 15.211, § 15.213, § 15.217, § 15.219, or § 15.221. Further, this requirement does not apply to intentional radiators that must be professionally installed, such as perimeter protection systems and some field disturbance sensors, or to other intentional radiators which, in accordance with § 15.31(d), must be measured at the installation site. However, the installer shall be responsible for ensuring that the proper antenna is employed so that the limits in this part are not exceeded.

If directional gain of transmitting antennas is greater than 6 dBi, the power shall be reduced by the same level in dB comparing to gain minus 6 dBi. For the fixed point-to-point operation, the power shall be reduced by one dB for every 3 dB that the directional gain of the antenna exceeds 6 dBi. The use of a permanently attached antenna or of an antenna that uses a unique coupling to the intentional radiator shall be considered sufficient to comply with the FCC rule.

#### 5.1.2 Antenna Anti-Replacement Construction

The Antenna Anti-Replacement as following method:

Protected Method	Description
The antenna is embedded in the product.	An embedded-in antenna design is used.

Reference Documents	Item
Photo	Please refer to the EUT Photo documents.

#### 5.1.3 Antenna Gain

The antenna peak gain of EUT is less than 6 dBi. Therefore, it is not necessary to reduce maximum peak output power limit.



## 5.2 Frequency Hopping Systems

### 5.2.1 Relevant Standards

FCC §15.247(a) (1) (i) (ii) (iii) (iv); FCC §15.247(g); FCC §15.247(h)

Describe how the hopping sequence is generated. Provide an example of the hopping sequence channels, to demonstrate that the sequence meets the requirement specified in the definition of an FHSS system. Per the definition in Section 2.1(c), the hop set shall appear as random in the near term, shall appear as evenly distributed in the long term, and sequential hops shall be randomly distributed in both direction and magnitude of change.

Describe how each individual EUT meets the requirement that each of its hopping channels is used equally on average (e.g., that each new transmission event begins on the next channel in the hopping sequence after the final channel used in the previous transmission event).

Describe how the associated receiver(s) complies with the requirement that the input bandwidth (either RF or IF) matches the bandwidth of the transmitted signal.

Describe how the associated receiver(s) has the ability to shift frequencies in synchronization with the transmitted signals.

For short burst systems, describe how the EUT complies with the requirement that it be designed to be capable of operating as a true frequency hopping system. Specifically, the device shall comply with the equal frequency use and pseudorandom hopping sequence requirement when transmitting in short bursts, and shall be designed to comply when presented with continuous data (or information) stream.

Describe how the EUT complies with the requirement that it not have the ability to be coordinated with other FHSS systems in an effort to avoid the simultaneous occupancy of individual hopping frequencies by multiple transmitters.

### 5.2.2 Description of the systems

1. According to the preset procedure of the whole network, all the stations in the automatic control network synchronously change the frequency multiple times within one second, and temporarily stay on each frequency hopping channel. Periodic synchronization signaling is sent from the primary station, instructing all slaves to simultaneously change the operating frequency, then the hopping sequence is generated.
2. The hop set shall appear as random in the near term, shall appear as evenly distributed in the long term, and sequential hops shall be randomly distributed in both direction and magnitude of change.

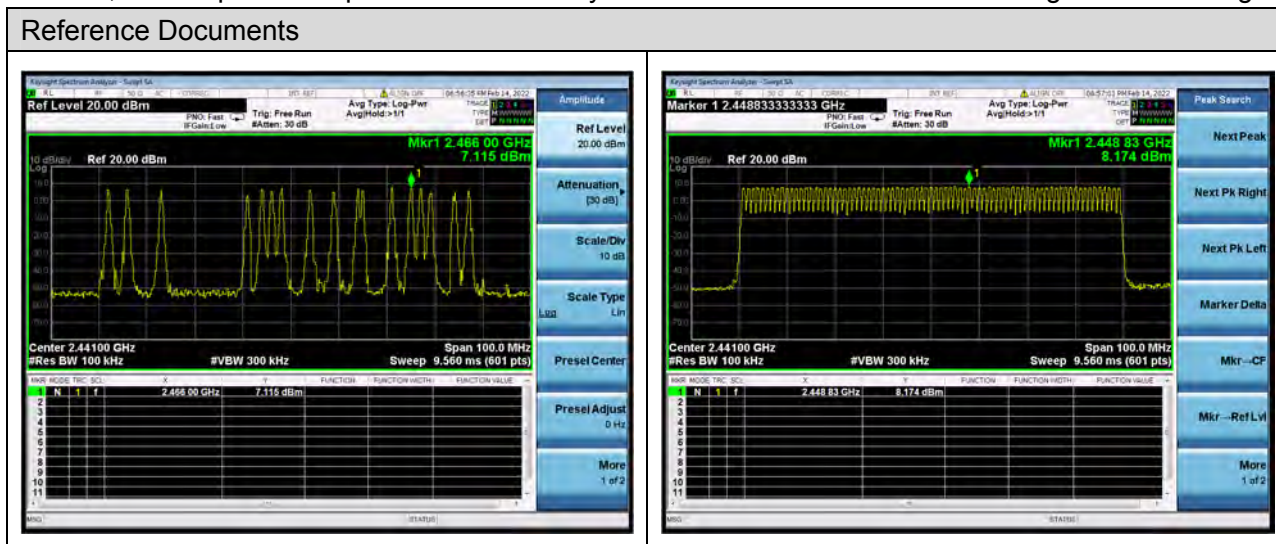

3. Channels are classified into two categories, used and unused, where used channels are part of the hopping sequence and unused channels are replaced in the hopping sequence by used channels in a pseudo-random way. Make each individual EUT meets the requirement that each of its hopping channels is used equally on average.
4. The input bandwidth and transmitted bandwidth are both 1MHz, the associated receiver(s) complies with the requirement that the input bandwidth matches the bandwidth of the transmitted signal.
5. Connected devices communicate on the same physical channel by synchronizing with a common clock and hopping sequence.
6. EUT isn't short burst systems.
7. EUT can't have the ability to be coordinated with other FHSS systems in an effort.

## 5.3 Number of Hopping Frequencies

### 5.3.1 Limit

FCC §15.247(a) (1) (iii); RSS-247, 5.1 (d)

Frequency hopping systems operating in the 2400 MHz to 2483.5 MHz bands shall use at least 15 hopping frequencies.

### 5.3.2 Test Setup

See section 4.5.1 for test setup description for the antenna port. The photo of test setup please refer to ANNEX B.

### 5.3.3 Test Procedure

The EUT must have its hopping function enabled. Use the following spectrum analyzer settings:

Span = The frequency band of operation

RBW = To identify clearly the individual channels, set the RBW to less than 30% of the channel spacing or the 20 dB bandwidth, whichever is smaller.

VBW  $\geq$  RBW

Sweep = auto

Detector function = peak

Trace = max hold

Allow the trace to stabilize

### 5.3.4 Test Result

Please refer to ANNEX A.1.

## 5.4 Peak Output Power and E.I.R.P

### 5.4.1 Test Limit

FCC § 15.247(b)

For frequency hopping systems operating in the 2400-2483.5 MHz band employing at least 75 non-overlapping hopping channels band: 1 watt. For all other frequency hopping systems in the 2400-2483.5 MHz band: 0.125 watts.

RSS-247, 5.4 (b)

For FHSs operating in the band 2400-2483.5 MHz, the maximum peak conducted output power shall not exceed 1.0 W and the e.i.r.p. shall not exceed 4 W if the hopset uses 75 or more hopping channels; the maximum peak conducted output power shall not exceed 0.125 W and the e.i.r.p. shall not exceed 0.5 W if the hopset uses less than 75 hopping channels (see Section 5.4(5) for exceptions).

### 5.4.2 Test Setup

See section 4.5.1 for test setup description for the antenna port. The photo of test setup please refer to ANNEX B.

### 5.4.3 Test Procedure

The Module operates at hopping-off test mode. The lowest, middle and highest channels are selected to perform testing to verify the conducted RF output peak power of the Module.

Use the following spectrum analyzer settings:

Span = approximately 5 times the 20 dB bandwidth, centered on a hopping channel

RBW > the 20 dB bandwidth of the emission being measured

VBW  $\geq$  RBW

Sweep = auto

Detector function = peak

Trace = max hold

Allow the trace to stabilize.

### 5.4.4 Test Result

Please refer to ANNEX A.2.

## 5.5 Occupied Bandwidth

### 5.5.1 Limit

FCC §15.247(a); RSS-247, 5.1 (a)

Measurement of the 20dB bandwidth of the modulated signal.

### 5.5.2 Test Setup

See section 4.5.1 for test setup description for the antenna port. The photo of test setup please refer to ANNEX B.

### 5.5.3 Test Procedure

Use the following spectrum analyzer settings:

Span = approximately 2 to 5 times the 20 dB bandwidth, centered on a hopping channel

RBW = in the range of 1% to 5% of the OBW

VBW  $\geq$  RBW

Sweep = auto

Detector function = peak

Trace = max hold

The EUT should be transmitting at its maximum data rate, Allow the trace to stabilize.

### 5.5.4 Test Result

Please refer to ANNEX A.3.

## 5.6 Carrier Frequency Separation

### 5.6.1 Limit

FCC §15.247(a); RSS-247, 5.1 (b)

Frequency hopping systems shall have hopping channel carrier frequencies separated by a minimum of 25 kHz or the 2/3 of the 20 dB bandwidth of the hopping channel, whichever is greater.

### 5.6.2 Test Setup

See section 4.5.1 for test setup description for the antenna port. The photo of test setup please refer to ANNEX B.

### 5.6.3 Test Procedure

The EUT must have its hopping function enabled. Use the following spectrum analyzer settings:

Span = wide enough to capture the peaks of two adjacent channels

Resolution (or IF) Bandwidth (RBW)  $\geq$  1% of the span

Video (or Average) Bandwidth (VBW)  $\geq$  RBW

Sweep = auto

Detector function = peak

Trace = max hold

Allow the trace to stabilize. Use the marker-delta function to determine the separation between the peaks of the adjacent channels.

### 5.6.4 Test Result

Please refer to ANNEX A.4.

## 5.7 Time of Occupancy (Dwell time)

### 5.7.1 Limit

FCC §15.247(a); RSS-247, 5.1 (d)

Frequency hopping systems in the 2400 MHz - 2483.5 MHz band shall use at least 15 non-overlapping channels. The average time of occupancy on any channel shall not be greater than 0.4 seconds within a period of 0.4 seconds multiplied by the number of hopping channels employed. Frequency hopping systems may avoid or suppress transmissions on a particular hopping frequency provided that a minimum of 15 channels are used.

### 5.7.2 Test Setup

See section 4.5.1 for test setup description for the antenna port. The photo of test setup please refer to ANNEX B.

### 5.7.3 Test Procedure

The EUT shall have its hopping function enabled. Use the following spectrum analyzer settings:

Span: Zero span, centered on a hopping channel

RBW shall be  $\leq$  channel spacing and where possible RBW should be set  $\gg 1 / T$ , where T is the expected dwell time per channel

Sweep: As necessary to capture the entire dwell time per hopping channel; where possible use a video trigger and trigger delay so that the transmitted signal starts a little to the right of the start of the plot. The trigger level might need slight adjustment to prevent triggering when the system hops on an adjacent channel; a second plot might be needed with a longer sweep time to show two successive hops on a channel

Detector function: Peak

Trace: Max hold

Use the marker-delta function to determine the transmit time per hop. If this value varies with different modes of operation (data rate, modulation format, number of hopping channels, etc.), then repeat this test for each variation in transmit time.

The average time of occupancy on any channel within the Period can be calculated with formulas:

For GFSK and 8-DPSK:

For DH1 package type

$$\{\text{Total of Dwell}\} = \{\text{Pulse Time}\} * (1600 / 2) / \{\text{Number of Hopping Frequency}\} * \{\text{Period}\}$$

$$\{\text{Period}\} = 0.4 \text{ s} * \{\text{Number of Hopping Frequency}\}$$

For DH3 package type

$$\{\text{Total of Dwell}\} = \{\text{Pulse Time}\} * (1600 / 4) / \{\text{Number of Hopping Frequency}\} * \{\text{Period}\}$$

$$\{\text{Period}\} = 0.4 \text{ s} * \{\text{Number of Hopping Frequency}\}$$

For DH5 package type

$$\{\text{Total of Dwell}\} = \{\text{Pulse Time}\} * (1600 / 6) / \{\text{Number of Hopping Frequency}\} * \{\text{Period}\}$$

$$\{\text{Period}\} = 0.4 \text{ s} * \{\text{Number of Hopping Frequency}\}$$

For AFH Mode:

For DH1 package type

$$\{\text{Total of Dwell}\} = \{\text{Pulse Time}\} * (800 / 2) / \{\text{Number of Hopping Frequency}\} * \{\text{Period}\}$$

{Period} = 0.4 s \* {Number of Hopping Frequency}

For DH3 package type

{Total of Dwell} = {Pulse Time} \* (800 / 4) / {Number of Hopping Frequency} \* {Period}

{Period} = 0.4 s \* {Number of Hopping Frequency}

For DH5 package type

{Total of Dwell} = {Pulse Time} \* (800 / 6) / {Number of Hopping Frequency} \* {Period}

{Period} = 0.4 s \* {Number of Hopping Frequency}

The lowest, middle and highest channels are selected to perform testing to record the dwell time of each occupation measured in this channel, which is called Pulse Time here.

#### 5.7.4 Test Result

Please refer to ANNEX A.5.



## 5.8 Conducted Spurious Emission & Authorized-band band-edge

### 5.8.1 Limit

FCC §15.247(d); RSS-247, 5.5

In any 100 kHz bandwidth outside the frequency band in which the spread spectrum or digitally modulated intentional radiator is operating, the radio frequency power that is produced by the intentional radiator shall be at least 20 dB below that in the 100 kHz bandwidth within the band that contains the highest level of the desired power, based on either an RF conducted or a radiated measurement.

### 5.8.2 Test Setup

See section 4.5.1 for test setup description for the antenna port. The photo of test setup please refer to ANNEX B.

### 5.8.3 Test Procedure

Use the following spectrum analyzer settings:

Span = wide enough to capture the peak level of the in-band emission and all spurious emissions (e.g., harmonics) from the lowest frequency generated in the EUT up through the 10th harmonic. Typically, several plots are required to cover this entire span.

RBW = 100 kHz

VBW = 300 kHz

Sweep = auto

Detector function = peak

Trace = max hold

Allow the trace to stabilize

### 5.8.4 Test Result

Please refer to ANNEX A.6.

## 5.9 Conducted Emission

### 5.9.1 Limit

FCC §15.207; RSS-GEN, 8.8

For an intentional radiator that is designed to be connected to the public utility (AC) power line, the radio frequency voltage that is conducted back onto the AC power line on any frequency within the band 150 kHz to 30 MHz shall not exceed the limits in the following table, as measured using a 50 $\mu$ H/50 $\Omega$  line impedance stabilization network (LISN).

Frequency range (MHz)	Conducted Limit (dB $\mu$ V)	
	Quai-peak	Average
0.15 - 0.50	66 to 56	56 to 46
0.50 - 5	56	46
0.50 - 30	60	50

### 5.9.2 Test Setup

See section 4.5.2 for test setup description for the AC power supply port. The photo of test setup please refer to ANNEX B.

### 5.9.3 Test Procedure

The maximum conducted interference is searched using Peak (PK), if the emission levels more than the AV and QP limits, and that have narrow margins from the AV and QP limits will be re-measured with AV and QP detectors. Tests for both L phase and N phase lines of the power mains connected to the EUT are performed. Refer to recorded points and plots below.

Devices subject to Part 15 must be tested for all available U.S. voltages and frequencies (such as a nominal 120 VAC, 50/60 Hz and 240 VAC, 50/60 Hz) for which the device is capable of operation. A device rated for 50/60 Hz operation need not be tested at both frequencies provided the radiated and line conducted emissions are the same at both frequencies.

### 5.9.4 Test Result

Please refer to ANNEX A.7.

## 5.10 Radiated Spurious Emission

### 5.10.1 Limit

FCC §15.209&15.247(d); RSS-247, 5.5

Radiated emission outside the frequency band attenuation below the general limits specified in FCC section 15.209(a) is not required. In addition, radiated emissions which fall in the restricted bands, as defined in FCC section 15.205(a), must also comply with the radiated emission limits specified in FCC section 15.209(a).

According to FCC section 15.209 (a), except as provided elsewhere in this subpart, the emissions from an intentional radiator shall not exceed the field strength levels specified in the following table:

Frequency (MHz)	Field Strength ( $\mu\text{V}/\text{m}$ )	Measurement Distance (m)
0.009 - 0.490	2400/F(kHz)	300
0.490 - 1.705	24000/F(kHz)	30
1.705 - 30.0	30	30
30 - 88	100	3
88 - 216	150	3
216 - 960	200	3
Above 960	500	3

Note:

1. Field Strength (dB $\mu\text{V}/\text{m}$ ) = 20\*log[Field Strength ( $\mu\text{V}/\text{m}$ )].
2. In the emission tables above, the tighter limit applies at the band edges.
3. For Above 1000 MHz, the emission limit in this paragraph is based on measurement instrumentation employing an average detector, measurement using instrumentation with a peak detector function, corresponding to 20dB above the maximum permitted average limit.
4. For above 1000 MHz, limit field strength of harmonics: 54dBuV/m@3m (AV) and 74dBuV/m@3m (PK).

### 5.10.2 Test Setup

See section 4.5.3 to 4.5.5 for test setup description for the antenna port. The photo of test setup please refer to ANNEX B.

### 5.10.3 Test Procedure

The measurement frequency range is from 9 kHz to the 10th harmonic of the fundamental frequency. The Turn Table is actuated to turn from 0° to 360°, and both horizontal and vertical polarizations of the Test Antenna are used to find the maximum radiated power. Mid channels on all channel bandwidth verified. Only the worst RB size/offset presented.

The power of the EUT transmitting frequency should be ignored.

All Spurious Emission tests were performed in X, Y, Z axis direction. And only the worst axis test condition was recorded in this test report.

Use the following spectrum analyzer settings:

Span = wide enough to fully capture the emission being measured

RBW = 1 MHz for  $f \geq 1$  GHz, 100 kHz for  $f < 1$  GHz

VBW  $\geq$  RBW

Sweep = auto

Detector function = peak

Trace = max hold

For measurement below 1GHz, If the emission level of the EUT measured by the peak detector is 3 dB lower than the applicable limit, the peak emission level will be reported, Otherwise, the emission measurement will be repeated using the quasi-peak detector and reported.

#### 5.10.4 Test Result

Please refer to ANNEX A.8.

## 5.11 Band Edge (Restricted-band band-edge)

### 5.11.1 Limit

FCC §15.209&15.247(d)

Radiated emission outside the frequency band attenuation below the general limits specified in FCC section 15.209(a) is not required. In addition, radiated emissions which fall in the restricted bands, as defined in FCC section 15.205(a), must also comply with the radiated emission limits specified in FCC section 15.209(a).

### 5.11.2 Test Setup

See section 4.5.3 to 4.5.5 for test setup description for the antenna port. The photo of test setup please refer to ANNEX B.

### 5.11.3 Test Procedure

The measurement frequency range is from 9 kHz to the 10th harmonic of the fundamental frequency. The Turn Table is actuated to turn from 0° to 360°, and both horizontal and vertical polarizations of the Test Antenna are used to find the maximum radiated power. Mid channels on all channel bandwidth verified. Only the worst RB size/offset presented.

The power of the EUT transmitting frequency should be ignored.

All Spurious Emission tests were performed in X, Y, Z axis direction. And only the worst axis test condition was recorded in this test report.

Use the following spectrum analyzer settings:

Span = wide enough to fully capture the emission being measured

RBW = 1 MHz for  $f \geq 1$  GHz, 100 kHz for  $f < 1$  GHz

VBW  $\geq$  RBW

Sweep = auto

Detector function = peak

Trace = max hold

For measurement below 1GHz, If the emission level of the EUT measured by the peak detector is 3 dB lower than the applicable limit, the peak emission level will be reported, Otherwise, the emission measurement will be repeated using the quasi-peak detector and reported.

### 5.11.4 Test Result

Please refer to ANNEX A.9.

# ANNEX A TEST RESULT

## A.1 Number of Hopping Frequency

### Test Data

Test Mode	Frequency Block (MHz)	Measured Channel Numbers	Min. Limit	Verdict
GFSK	2400 - 2483.5	79	15	Pass
8-DPSK	2400 - 2483.5	79	15	Pass

### Test Plots

GFSK 2.4 GHz ~ 2.4415 GHz

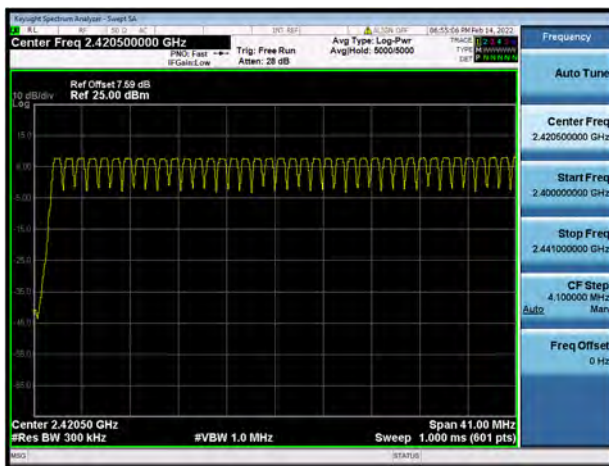

GFSK 2.4415 GHz ~ 2.4835 GHz

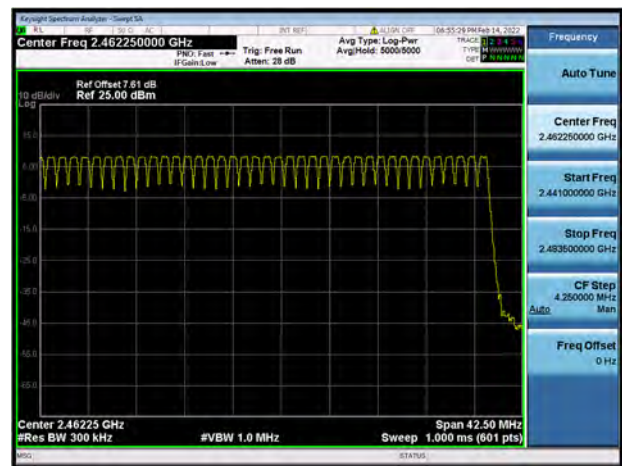

8-DPSK 2.4 GHz ~ 2.4415 GHz



8-DPSK 2.4415 GHz ~ 2.4835 GHz

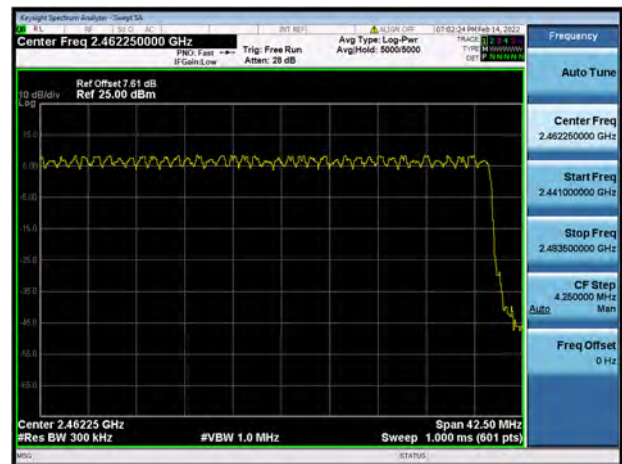

## A.2 Peak Output Power and E.I.R.P

### Peak Power Test Data

Channel	Measured Output Peak Power						Limit		Verdict
	GFSK		$\pi/4$ -DQPSK		8-DPSK		dBm	mW	
	dBm	mW	dBm	mW	dBm	mW			
Low	8.23	6.65	8.83	7.64	9.22	8.36	21	125	Pass
Middle	8.54	7.15	9.20	8.31	9.65	9.23			Pass
High	8.55	7.17	9.20	8.33	9.61	9.15			Pass

### E.I.R.P Test Data (For ISED)

Channel	E.I.R.P						Limit		Verdict
	GFSK		$\pi/4$ -DQPSK		8-DPSK		dBm	mW	
	dBm	mW	dBm	mW	dBm	mW			
Low	8.33	6.81	8.93	7.82	9.32	8.55	36	4000	Pass
Middle	8.64	7.31	9.30	8.51	9.75	9.44			Pass
High	8.65	7.33	9.30	8.51	9.71	9.35			Pass



Test Plots

GFSK LOW CHANNEL

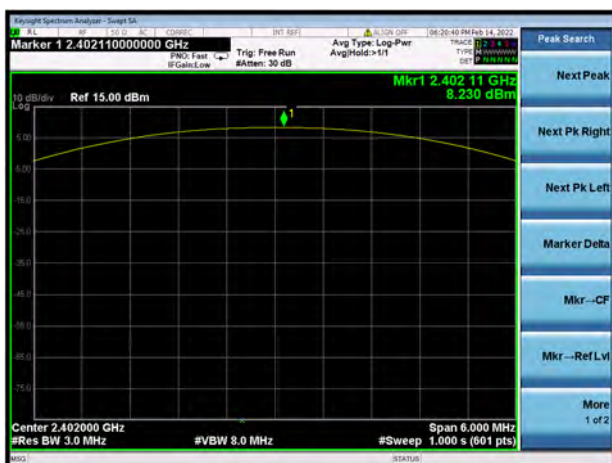

GFSK MIDDLE CHANNEL

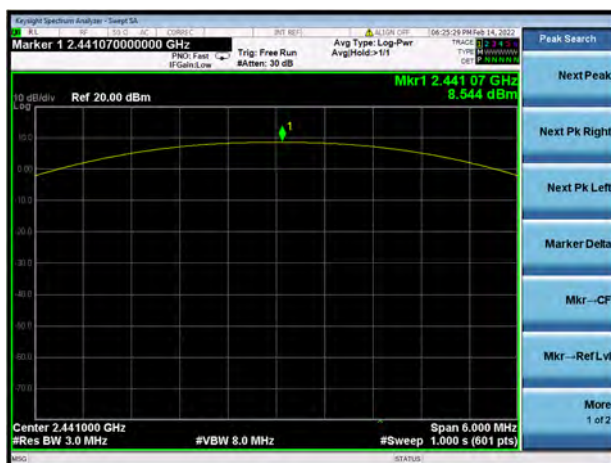

GFSK HIGH CHANNEL

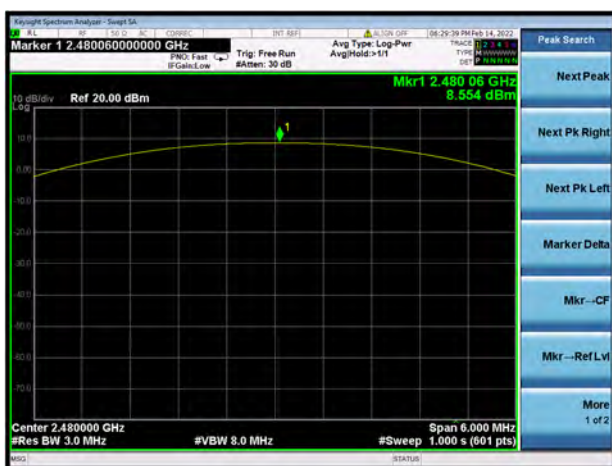

$\pi/4$ -DQPSK LOW CHANNEL

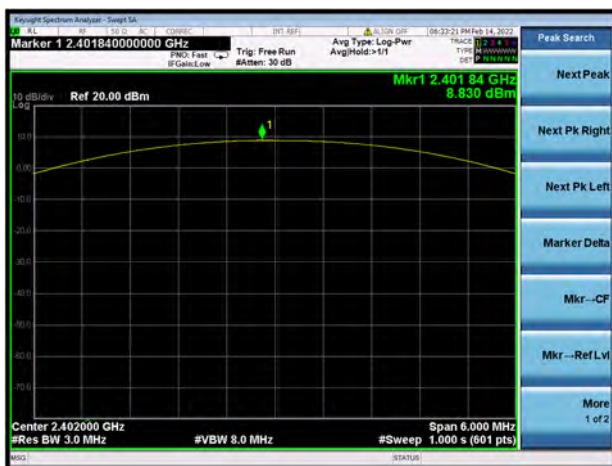

$\pi/4$ -DQPSK MIDDLE CHANNEL

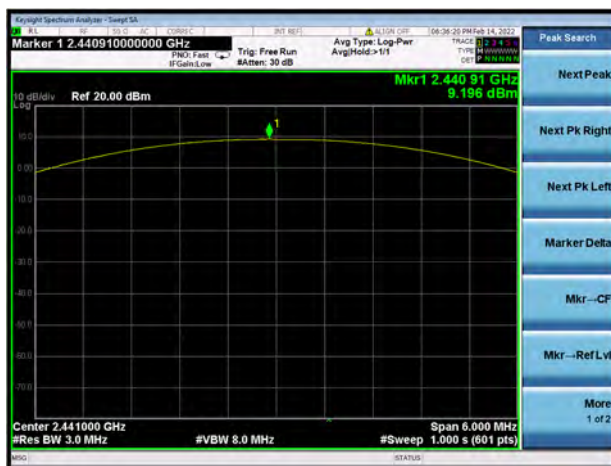



$\pi/4$ -DQPSK HIGH CHANNEL



8-DPSK LOW CHANNEL

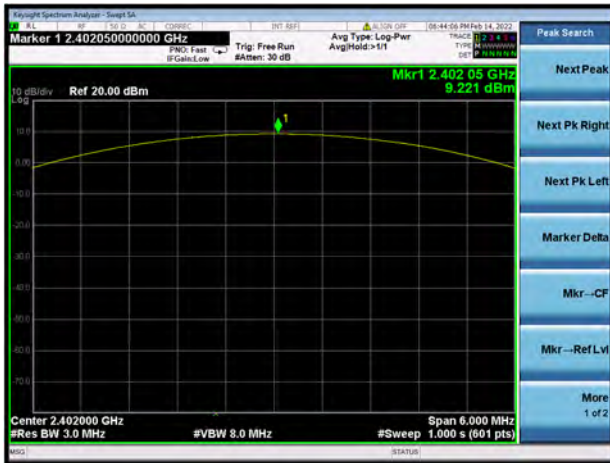

8-DPSK MIDDLE CHANNEL

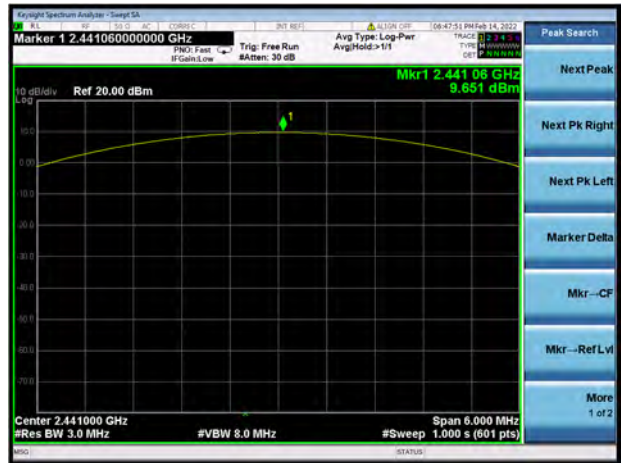

8-DPSK HIGH CHANNEL

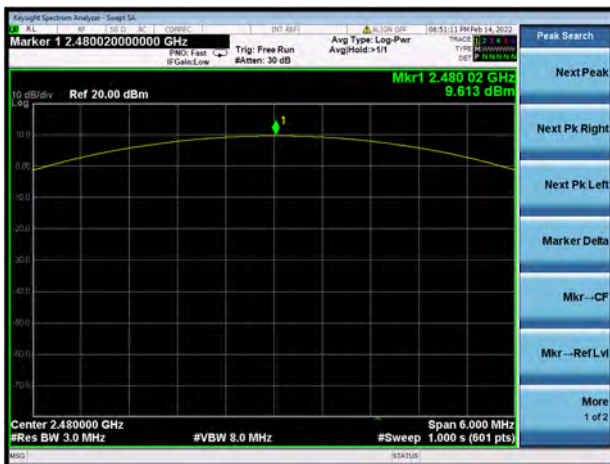

### A.3 20 dB and 99% bandwidth

#### Test Data

GFSK		
Channel	20 dB Bandwidth (MHz)	99% Bandwidth (MHz)
Low	0.955000	0.905960
Middle	0.955000	0.904380
High	0.955000	0.902860
$\pi/4$ -DQPSK		
Channel	20 dB Bandwidth (MHz)	99% Bandwidth (MHz)
Low	1.290000	1.160300
Middle	1.290000	1.161100
High	1.290000	1.158100
8-DPSK		
Channel	20 dB Bandwidth (MHz)	99% Bandwidth (MHz)
Low	1.295000	1.160100
Middle	1.295000	1.157000
High	1.295000	1.155000

Test Plots

20 dB Bandwidth

GFSK LOW CHANNEL



GFSK MIDDLE CHANNEL



GFSK HIGH CHANNEL



$\pi/4$ -DQPSK LOW CHANNEL



$\pi/4$ -DQPSK MIDDLE CHANNEL





$\pi/4$ -DQPSK HIGH CHANNEL



8-DPSK LOW CHANNEL



8-DPSK MIDDLE CHANNEL



8-DPSK HIGH CHANNEL



99% Bandwidth

GFSK LOW CHANNEL

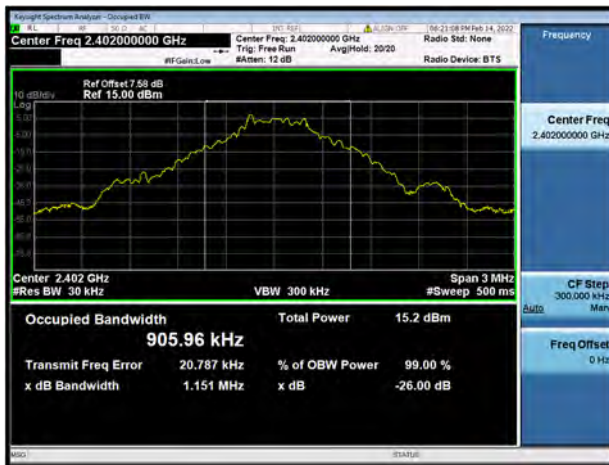

GFSK MIDDLE CHANNEL

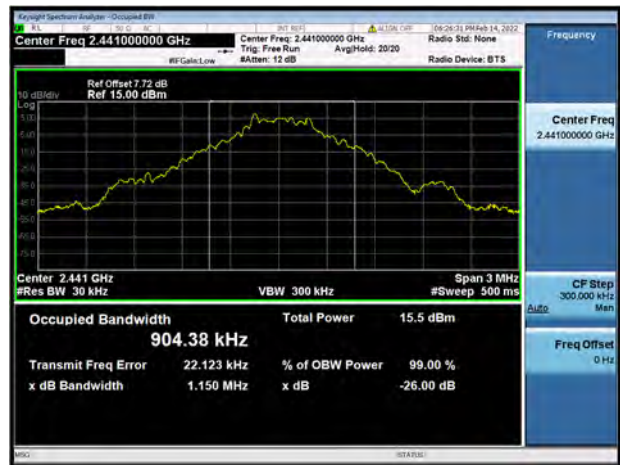

GFSK HIGH CHANNEL



$\pi/4$ -DQPSK LOW CHANNEL

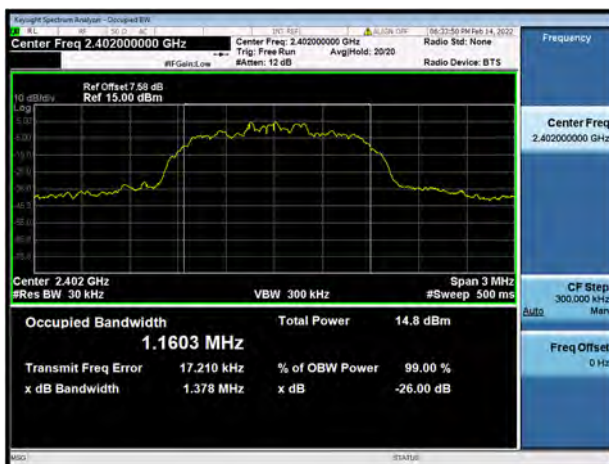

$\pi/4$ -DQPSK MIDDLE CHANNEL

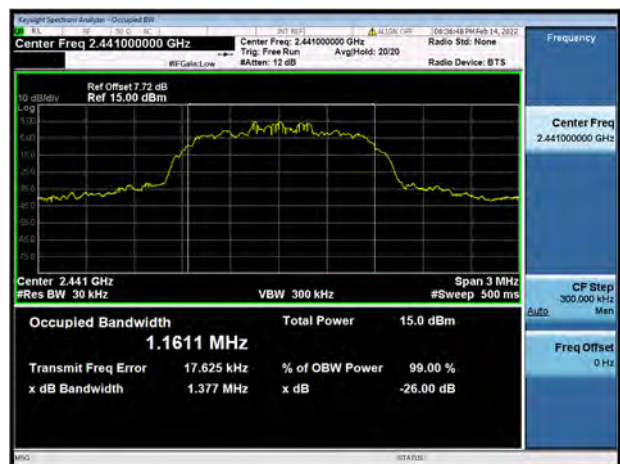



$\pi/4$ -DQPSK HIGH CHANNEL



8-DPSK LOW CHANNEL

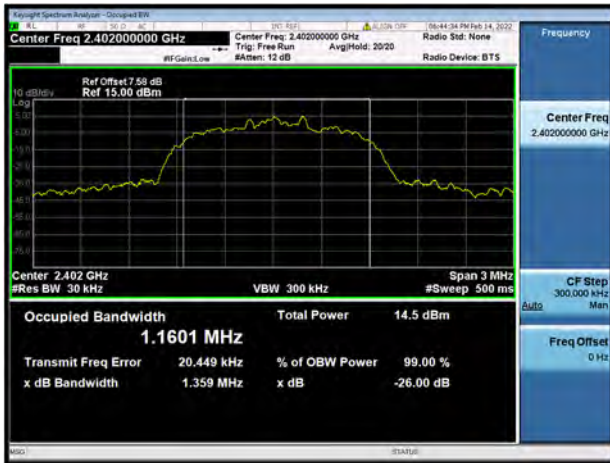

8-DPSK MIDDLE CHANNEL

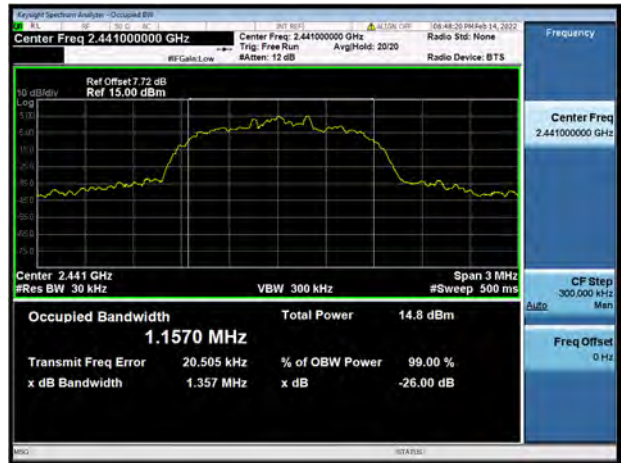

8-DPSK HIGH CHANNEL

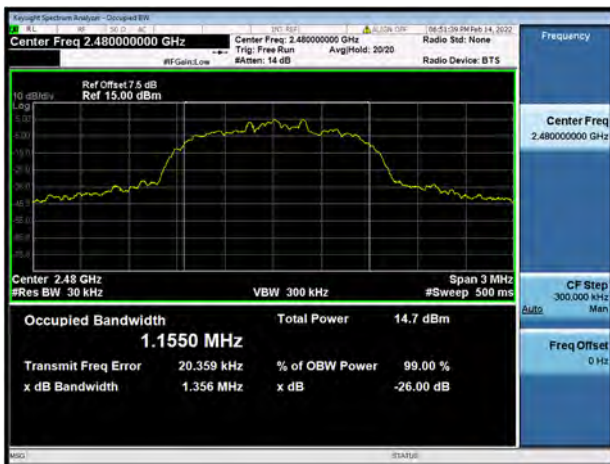

## A.4 Hopping Frequency Separation

### Test Data

Mode	Frequency separation (MHz)	2/3 of the 20 dB Bandwidth (MHz)	Verdict
GFSK	0.995	0.637	Pass
8-DPSK	1.000	0.863	Pass

### Test Plots

GFSK

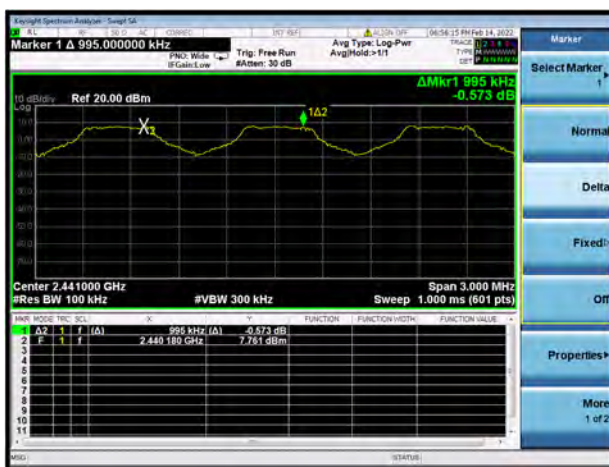

8-DPSK

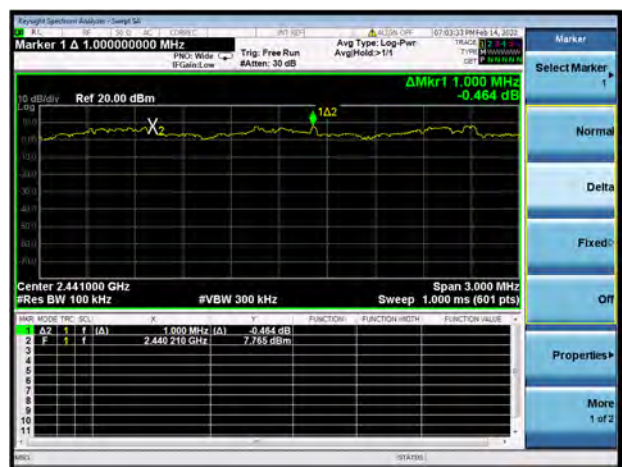

## A.5 Average Time of Occupancy

### Test Data

GFSK				
DH Packet	Pulse Width (ms)	Total of Dwell (ms)	Limit (sec)	Verdict
DH 1	0.39840	127.488	0.4	Pass
DH 3	1.65500	264.800	0.4	Pass
DH 5	2.89500	308.800	0.4	Pass
8-DPSK				
DH Packet	Pulse Width (ms)	Total of Dwell (ms)	Limit (sec)	Verdict
DH 1	0.39360	125.952	0.4	Pass
DH 3	1.64100	262.560	0.4	Pass
DH 5	2.89500	308.800	0.4	Pass
AFH Mode				
DH Packet	Pulse Width (ms)	Total of Dwell (ms)	Limit (sec)	Verdict
DH 1	0.40000	64.000	0.4	Pass
DH 3	1.65500	132.400	0.4	Pass
DH 5	2.90700	155.040	0.4	Pass



Test Plots

GFSK DH1

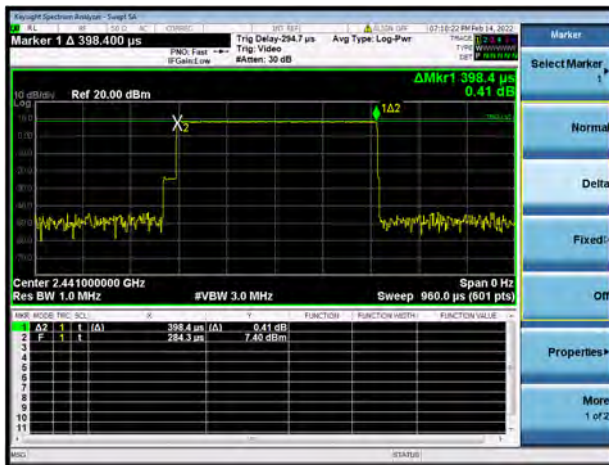

GFSK DH3

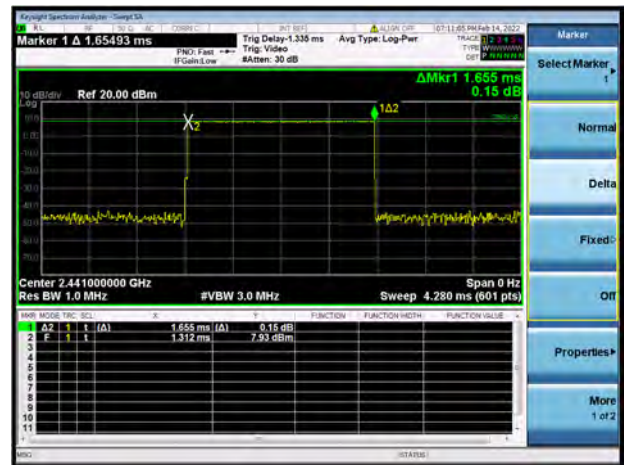

GFSK DH5

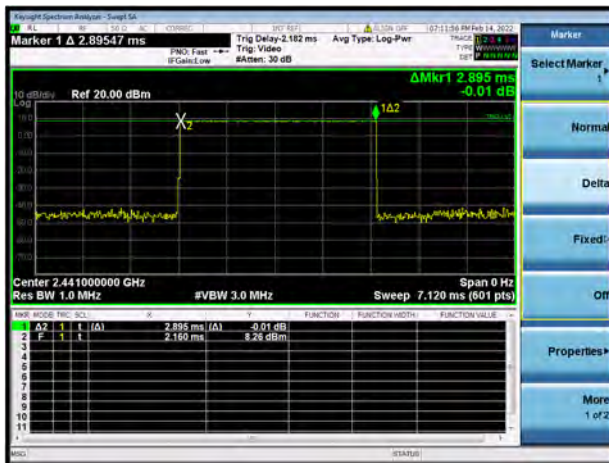

8-DPSK DH1

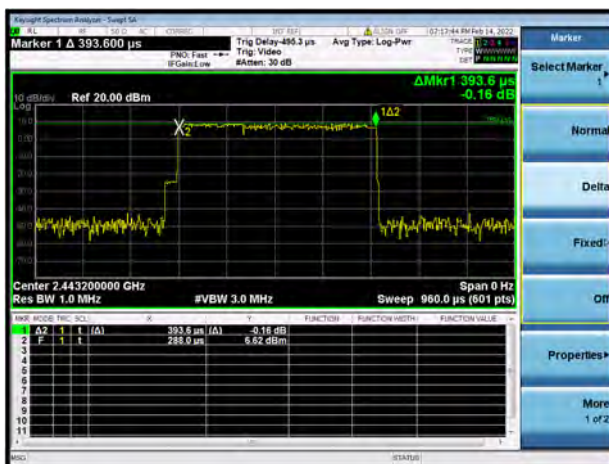

8-DPSK DH3

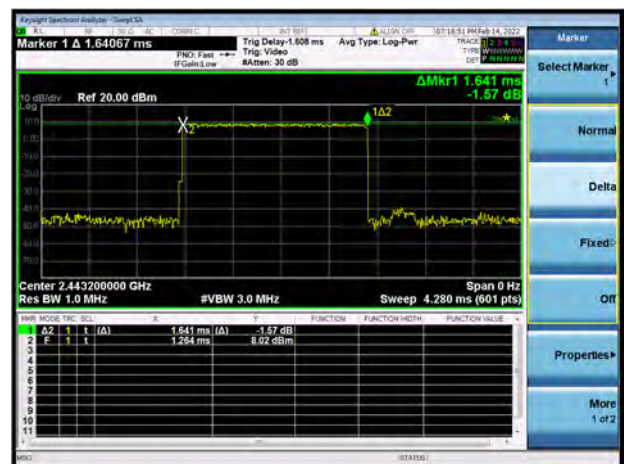

8-DPSK DH5

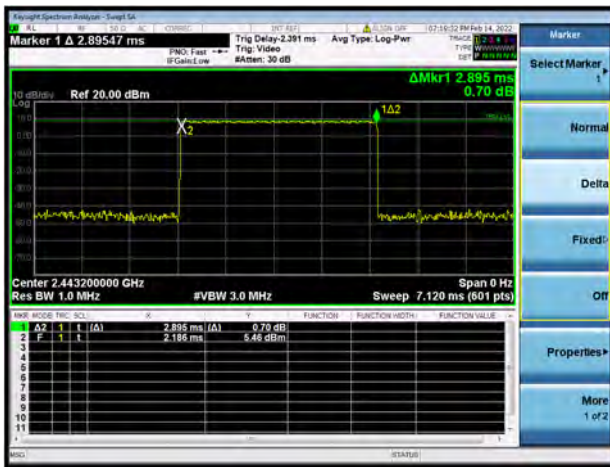

AFH Mode DH1

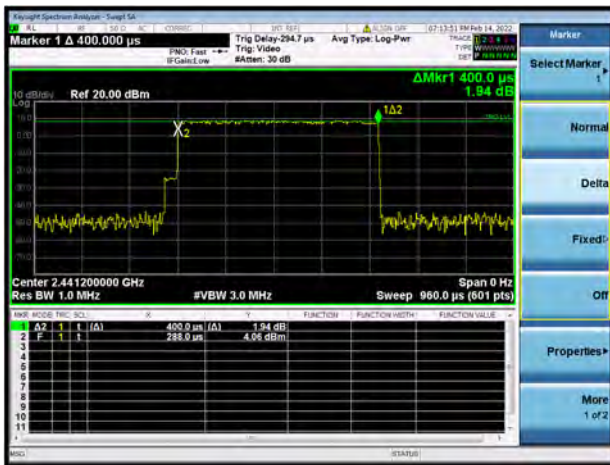

AFH Mode DH3

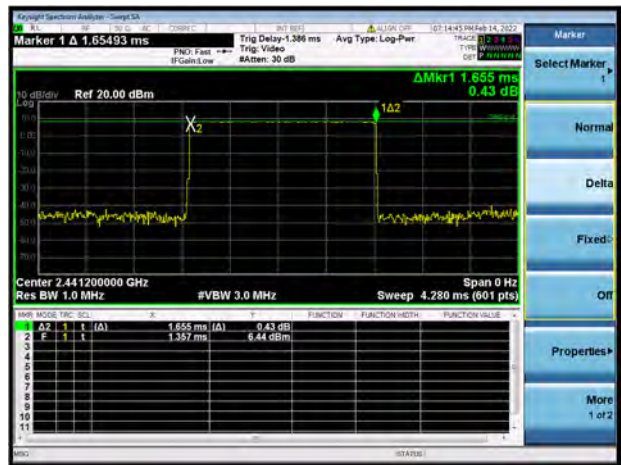

AFH Mode DH5

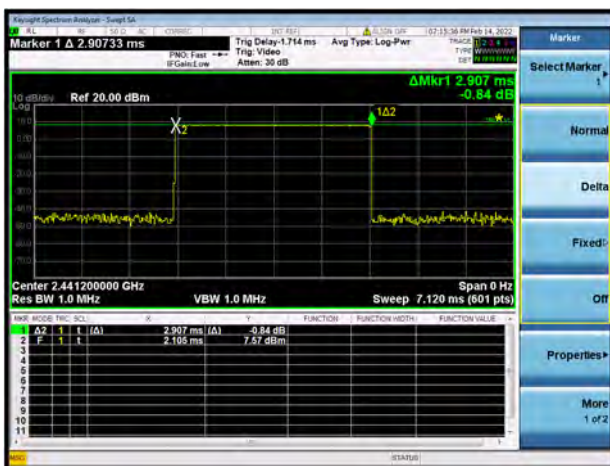

## A.6 Conducted Spurious Emissions & Authorized-band band-edge

### Test Data

GFSK				
Channel	Measured Max. Out of Band Emission (dBm)	Limit (dBm)		Verdict
		Carrier Level	Calculated 20 dBc Limit	
Low	-37.03	7.87	-12.13	Pass
Middle	-37.51	8.19	-11.81	Pass
High	-37.10	8.18	-11.82	Pass

8-DPSK				
Channel	Measured Max. Out of Band Emission (dBm)	Limit (dBm)		Verdict
		Carrier Level	Calculated 20 dBc Limit	
Low	-36.73	7.80	-12.20	Pass
Middle	-37.39	8.14	-11.86	Pass
High	-37.03	8.12	-11.88	Pass

Hopping Mode				
Mode	Measured Max. Out of Band Emission (dBm)	Limit (dBm)		Verdict
		Carrier Level	Calculated 20 dBc Limit	
GFSK	-36.27	8.17	-11.83	Pass
8-DPSK	-36.53	7.77	-12.23	Pass



Test Plots

GFSK LOW CHANNEL, CARRIER LEVEL



GFSK LOW CHANNEL, BAND EDGE

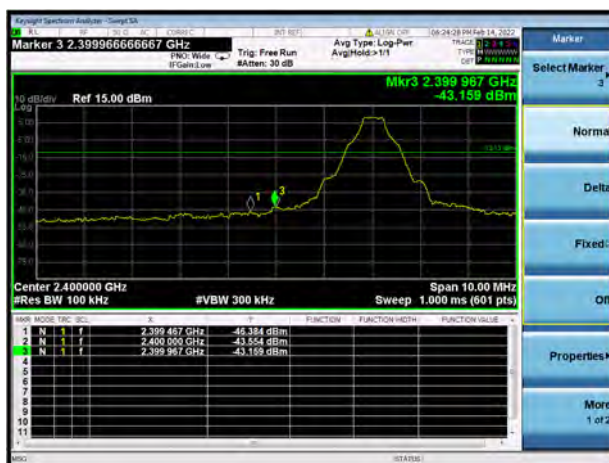

GFSK LOW CHANNEL, SPURIOUS  
30 MHz ~ 3 GHz

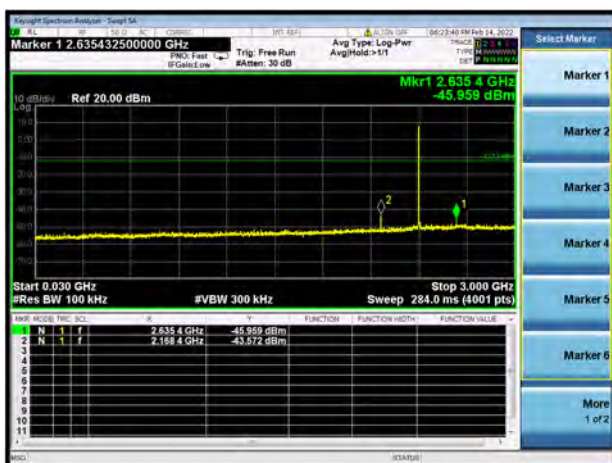

GFSK LOW CHANNEL, SPURIOUS  
3 GHz ~ 25 GHz

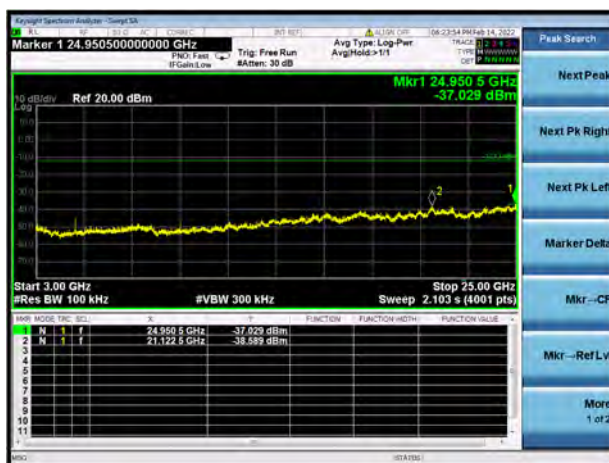

GFSK MIDDLE CHANNEL, CARRIER LEVEL



GFSK MIDDLE CHANNEL, SPURIOUS  
30 MHz ~ 3 GHz

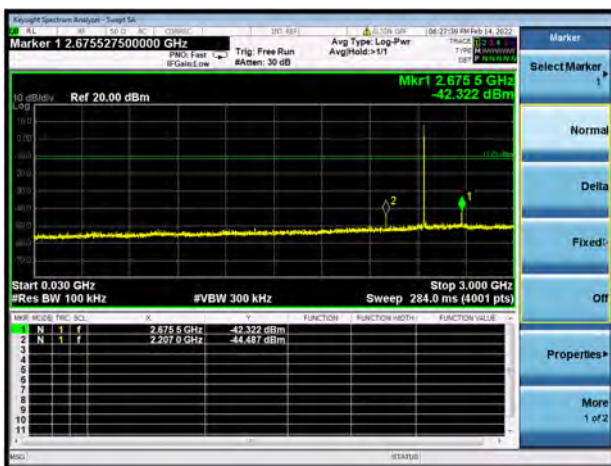

GFSK MIDDLE CHANNEL, SPURIOUS  
3 GHz ~ 25 GHz

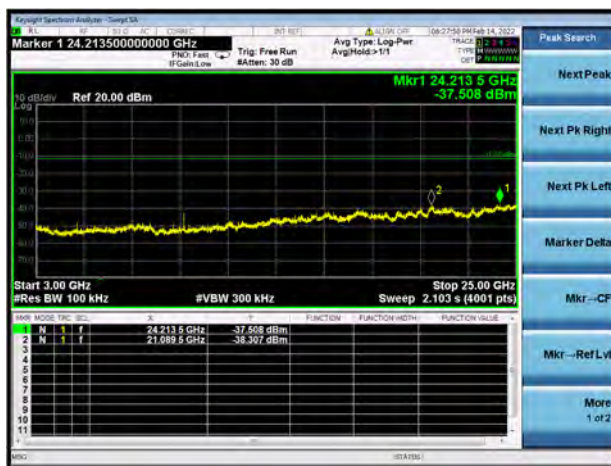

GFSK HIGH CHANNEL, CARRIER LEVEL

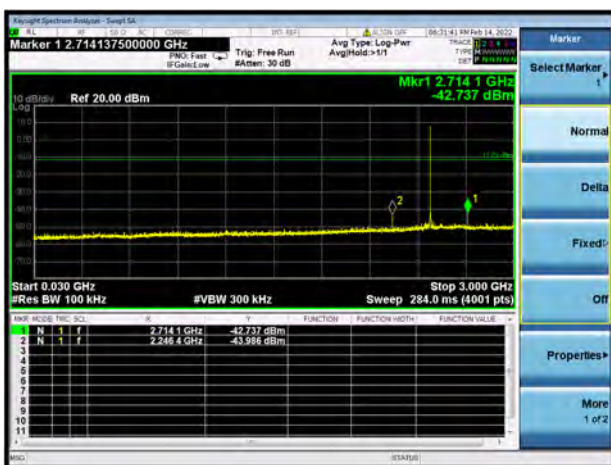

GFSK HIGH CHANNEL, BAND EDGE

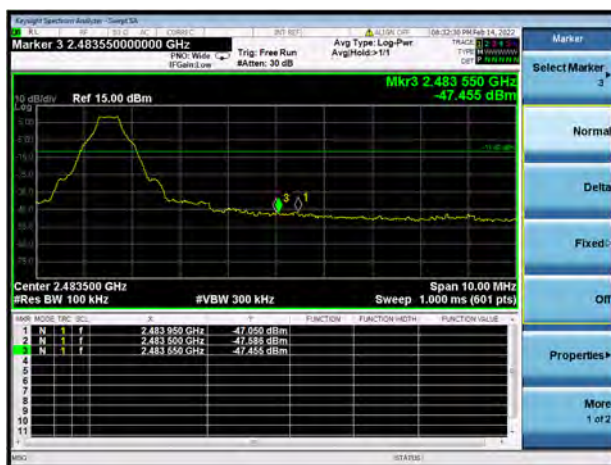

GFSK HIGH CHANNEL, SPURIOUS  
30 MHz ~ 3 GHz

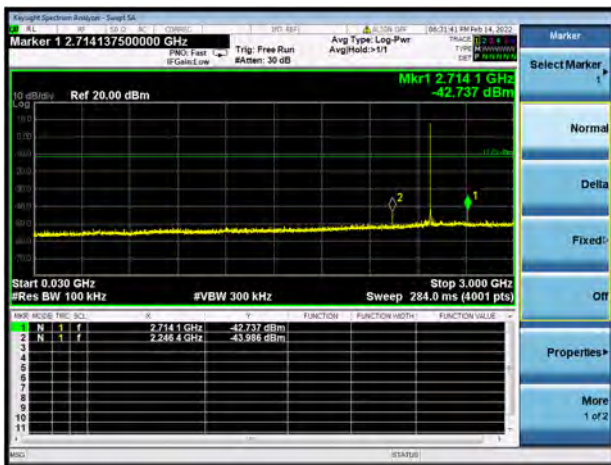

GFSK HIGH CHANNEL, SPURIOUS  
3 GHz ~ 25 GHz

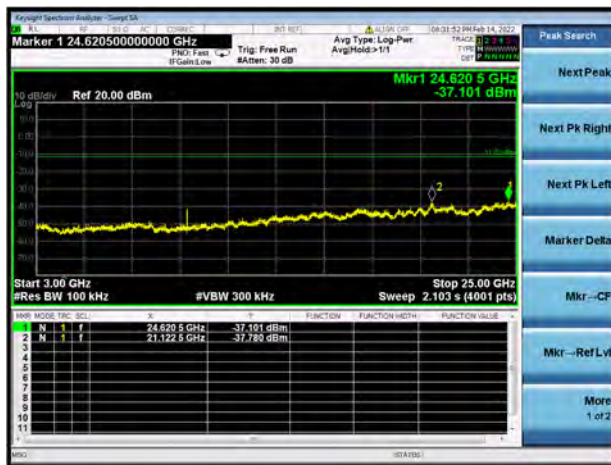



8-DPSK LOW CHANNEL, CARRIER LEVEL

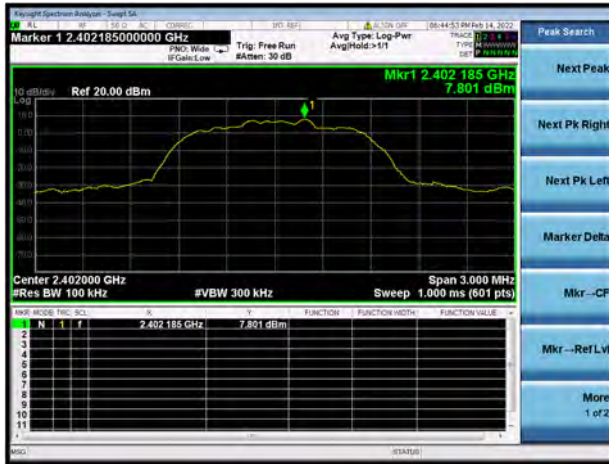

8-DPSK LOW CHANNEL, BAND EDGE

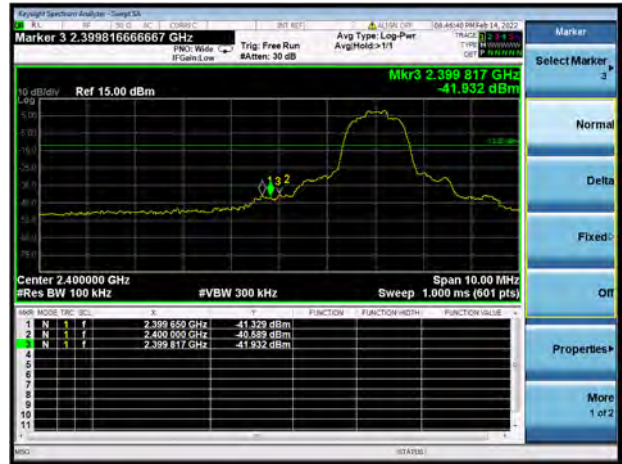

8-DPSK LOW CHANNEL, SPURIOUS

30 MHz ~ 3 GHz

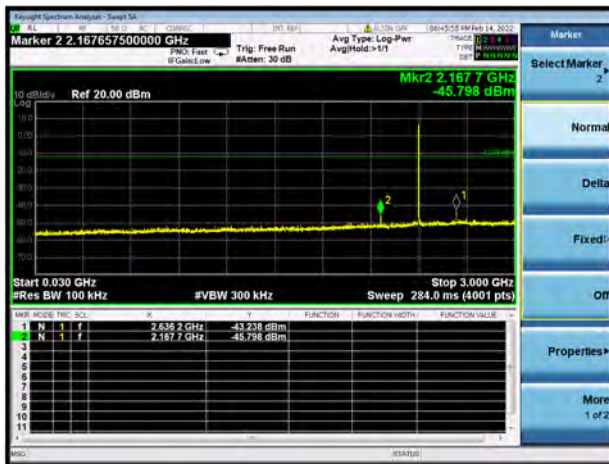

8-DPSK LOW CHANNEL, SPURIOUS

3 GHz ~ 25 GHz

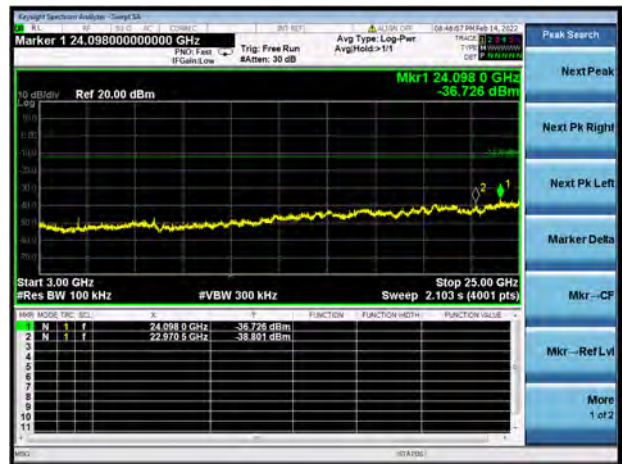

8-DPSK MIDDLE CHANNEL, CARRIER LEVEL

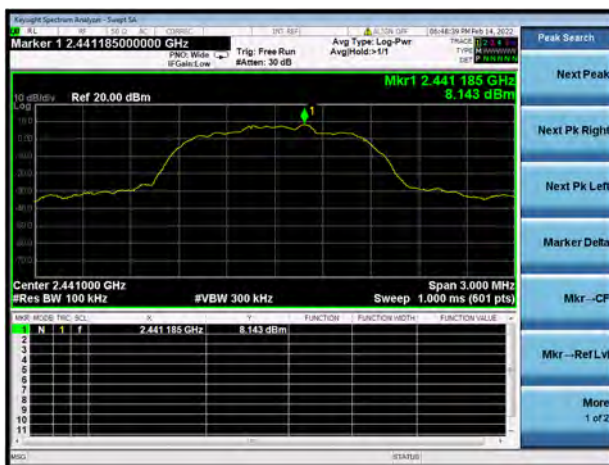

8-DPSK MIDDLE CHANNEL, SPURIOUS  
30 MHz ~ 3 GHz

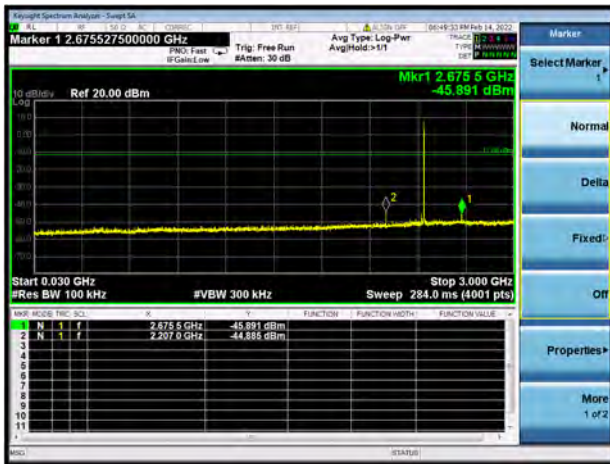

8-DPSK MIDDLE CHANNEL, SPURIOUS  
3 GHz ~ 25 GHz

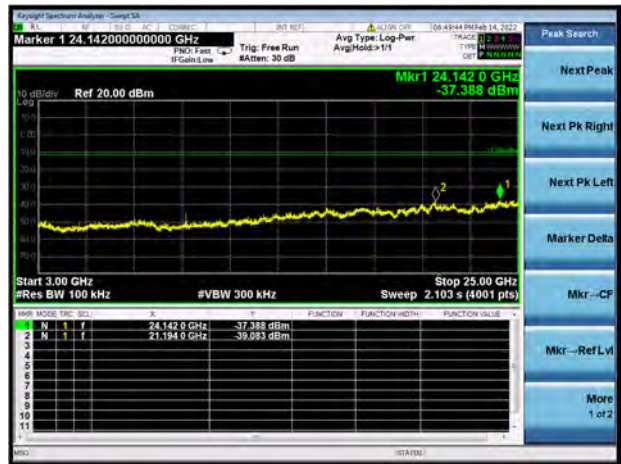

8-DPSK HIGH CHANNEL, CARRIER LEVEL

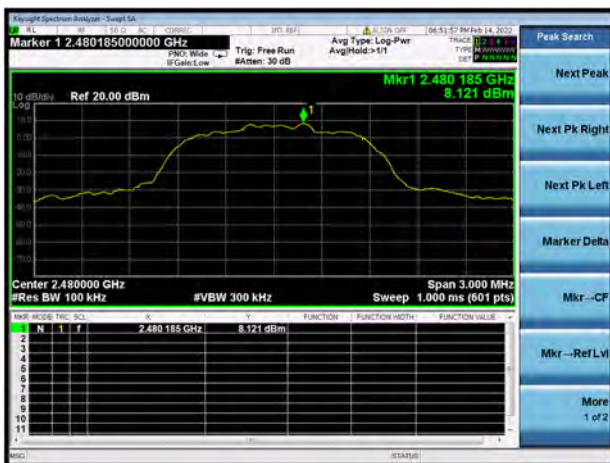

8-DPSK HIGH CHANNEL, BAND EDGE



8-DPSK HIGH CHANNEL, SPURIOUS  
30 MHz ~ 3 GHz

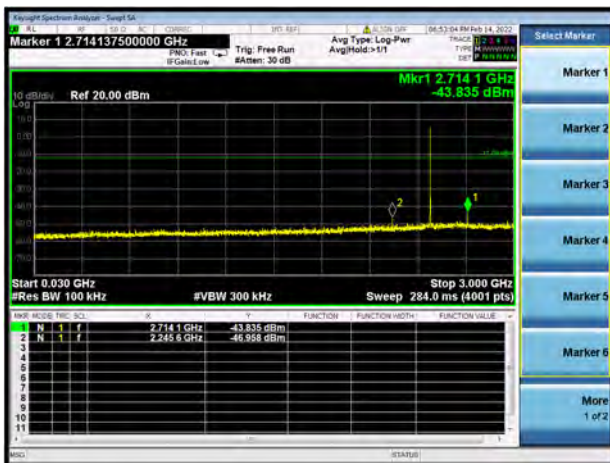

8-DPSK HIGH CHANNEL, SPURIOUS  
3 GHz ~ 25 GHz

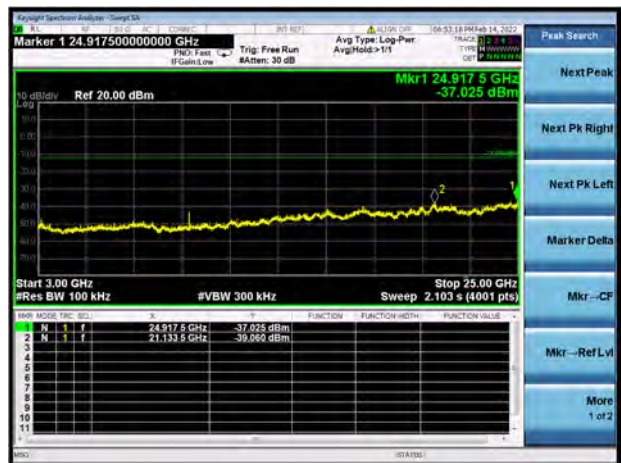



GFSK HOPPING, CARRIER LEVEL

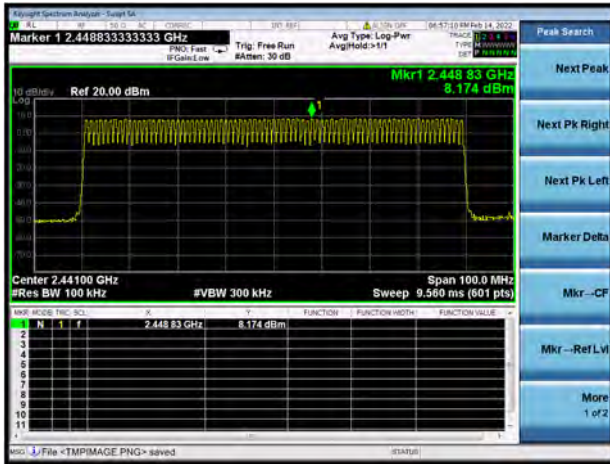

GFSK HOPPING BAND EDGE (LOW)



GFSK HOPPING BAND EDGE (HIGH)



GFSK Hopping Mode, SPURIOUS  
30 MHz ~ 3 GHz

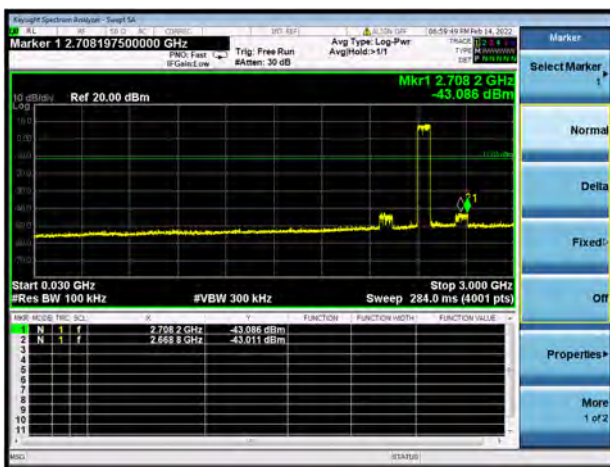

GFSK Hopping Mode, SPURIOUS  
3GHz ~ 25 GHz

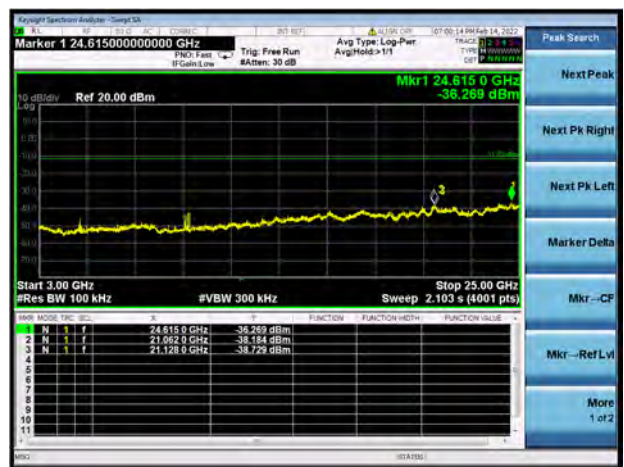



8-DPSK HOPPING, CARRIER LEVEL

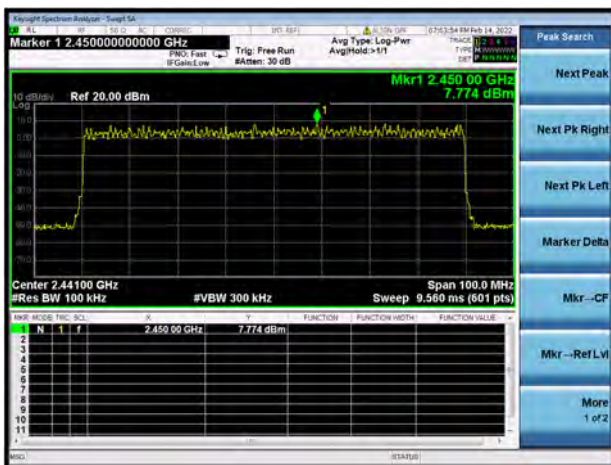

8-DPSK Hopping BAND EDGE (LOW)

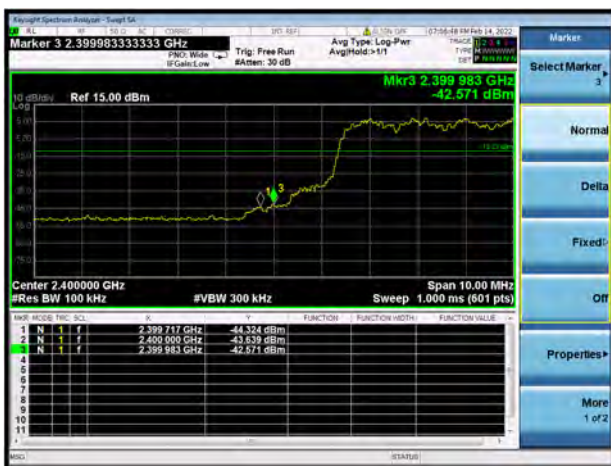

8-DPSK Hopping BAND EDGE (HIGH)

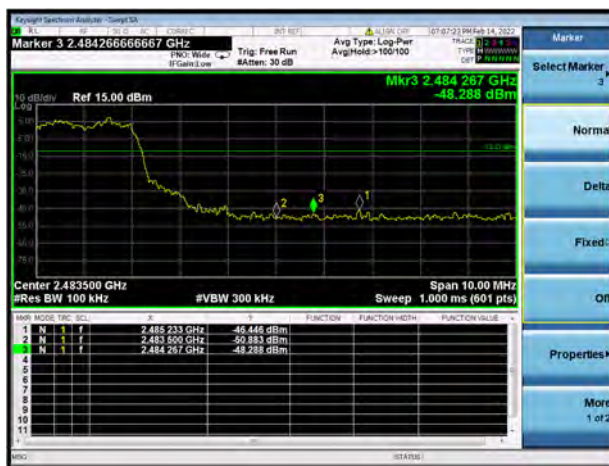

8-DPSK Hopping Mode, SPURIOUS  
30 MHz ~ 3 GHz

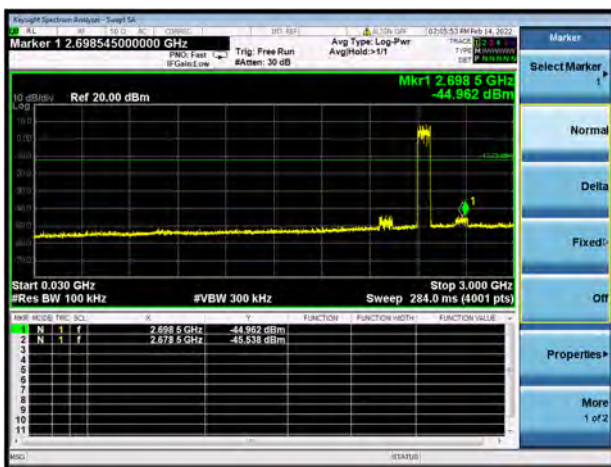

8-DPSK Hopping Mode, SPURIOUS  
3GHz ~ 25 GHz

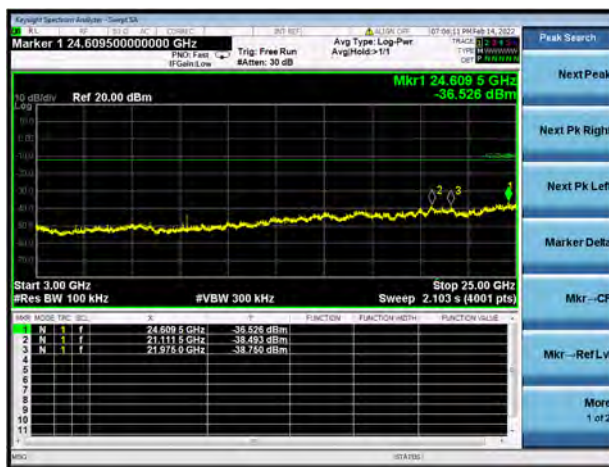

## A.7 Conducted Emissions

Note <sup>1</sup>: The EUT is working in the Normal link mode. All modes have been tested and normal link mode is worst.

Note <sup>2</sup>: Devices subject to Part 15 must be tested for all available U.S. voltages and frequencies (such as a nominal 120 VAC, 60 Hz and 240 VAC, 50 Hz) for which the device is capable of operation. So, The configuration 120 VAC, 60 Hz and 240 VAC, 50 Hz were tested respectively, but only the worst configuration (120 VAC, 60 Hz ) shown here.

Note <sup>3</sup>: Results (dBuV) = Original reading level of Spectrum Analyzer (dBuV) + Factor (dB)

### Test Data and Plots

#### PHASE L

CE Test case\_FCC\_CE\_FCC PART 15B\_Class B

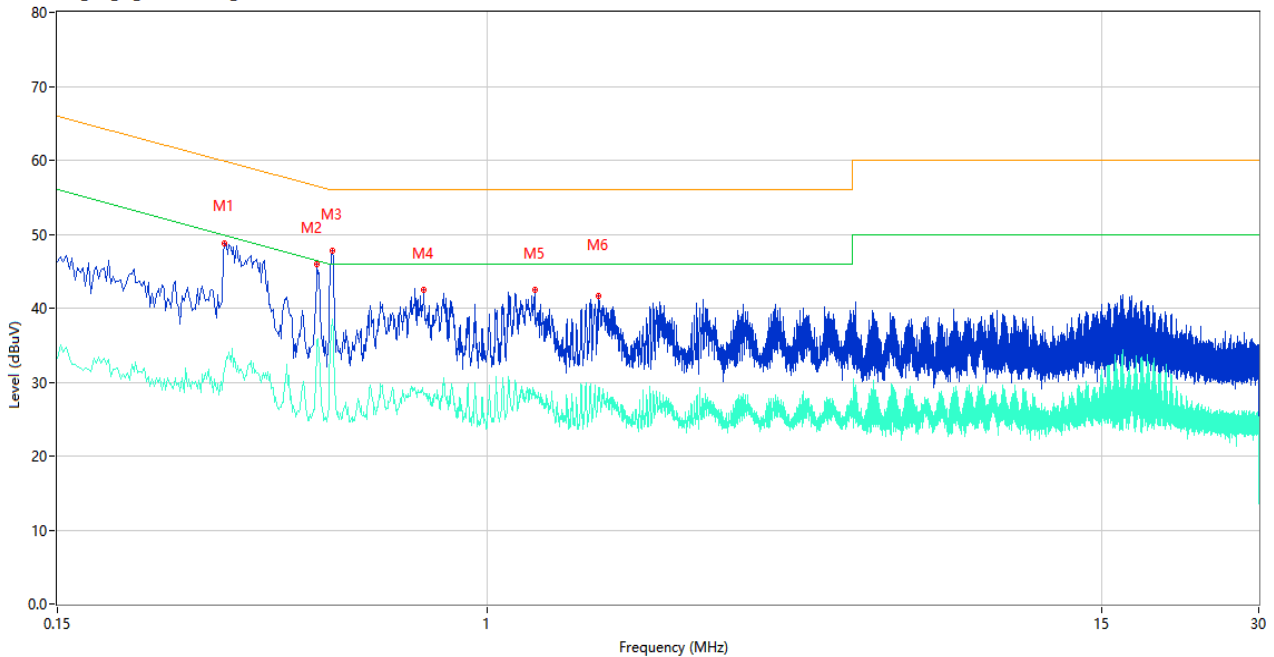

No.	Frequency (MHz)	Results (dBuV)	Factor (dB)	Limit (dBuV)	Over Limit (dB)	Detector	Line	Verdict
1	0.314	48.80	10.88	59.86	-11.06	Peak	L	Pass
1**	0.314	31.48	10.88	49.86	-18.38	AV	L	Pass
2	0.472	45.89	10.92	56.48	-10.59	Peak	L	Pass
2**	0.472	35.59	10.92	46.48	-10.89	AV	L	Pass
3	0.504	47.69	10.92	56.00	-8.31	Peak	L	Pass
3**	0.504	38.52	10.92	46.00	-7.48	AV	L	Pass
4	0.756	42.40	10.81	56.00	-13.60	Peak	L	Pass
4**	0.756	28.33	10.81	46.00	-17.67	AV	L	Pass
5	1.230	42.55	10.71	56.00	-13.45	Peak	L	Pass
5**	1.230	28.20	10.71	46.00	-17.80	AV	L	Pass
6	1.632	41.62	10.73	56.00	-14.38	Peak	L	Pass
6**	1.632	29.28	10.73	46.00	-16.72	AV	L	Pass

PHASE N

CE Test case\_FCC\_CE\_FCC PART 15B\_Class B

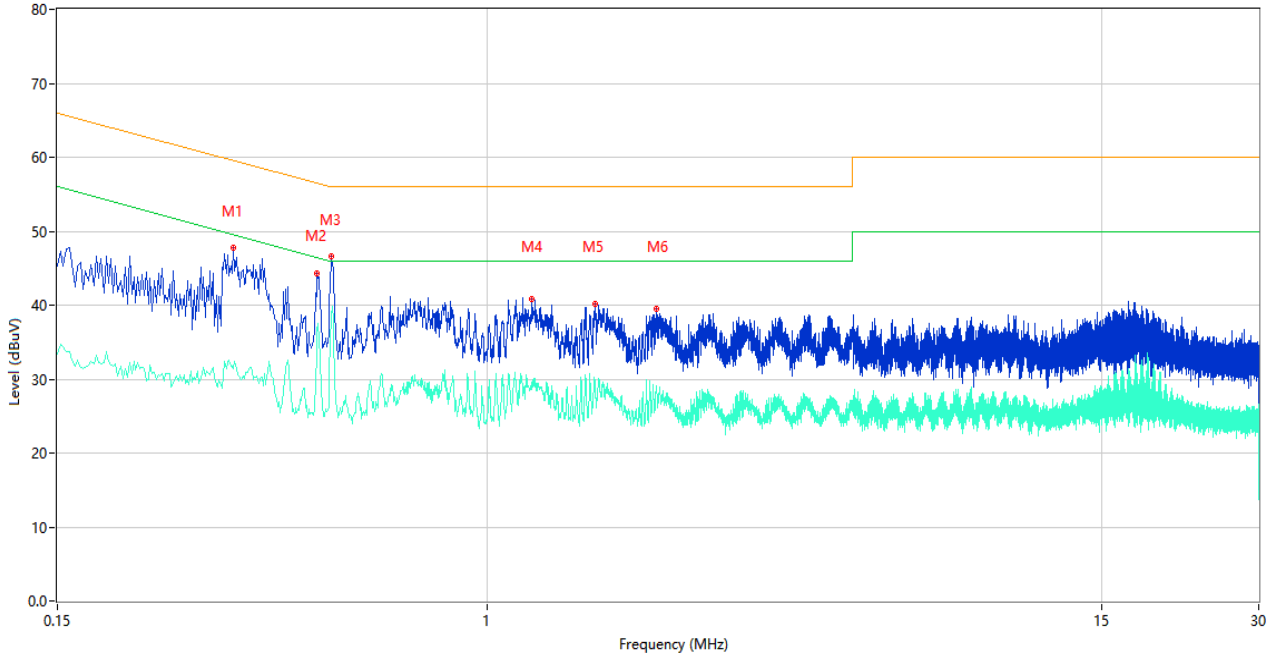

No.	Frequency (MHz)	Results (dBuV)	Factor (dB)	Limit (dBuV)	Over Limit (dB)	Detector	Line	Verdict
1	0.326	47.73	10.89	59.55	-11.82	Peak	N	Pass
1**	0.326	31.35	10.89	49.55	-18.20	AV	N	Pass
2	0.472	44.34	10.92	56.48	-12.14	Peak	N	Pass
2**	0.472	36.50	10.92	46.48	-9.98	AV	N	Pass
3	0.502	46.64	10.92	56.00	-9.36	Peak	N	Pass
3**	0.502	38.50	10.92	46.00	-7.50	AV	N	Pass
4	1.214	40.84	10.71	56.00	-15.16	Peak	N	Pass
4**	1.214	29.07	10.71	46.00	-16.93	AV	N	Pass
5	1.608	40.13	10.73	56.00	-15.87	Peak	N	Pass
5**	1.608	29.11	10.73	46.00	-16.89	AV	N	Pass
6	2.110	39.55	10.74	56.00	-16.45	Peak	N	Pass
6**	2.110	28.92	10.74	46.00	-17.08	AV	N	Pass

## A.8 Radiated Spurious Emission

Note <sup>1</sup>: The symbol of "--" in the table which means not application.

Note <sup>2</sup>: For the test data above 1 GHz, according the ANSI C63.10-2013, where limits are specified for both average and peak (or quasi-peak) detector functions, if the peak (or quasi-peak) measured value complies with the average limit, it is unnecessary to perform an average measurement.

Note <sup>3</sup>: The EUT is working in the Normal link mode below 1 GHz. All modes have been tested and DH5-Hopping mode is the worst.

Note <sup>4</sup>: Results (dBuV/m) = Original reading level of Spectrum Analyzer (dBuV/m) + Factor (dB)

The low frequency, which started from 9 kHz to 30 MHz, was pre-scanned and the result which was 20 dB lower than the limit line per 15.31(o) was not reported.

### Test Data and Plots

#### 30 MHz to 1 GHz, ANT H

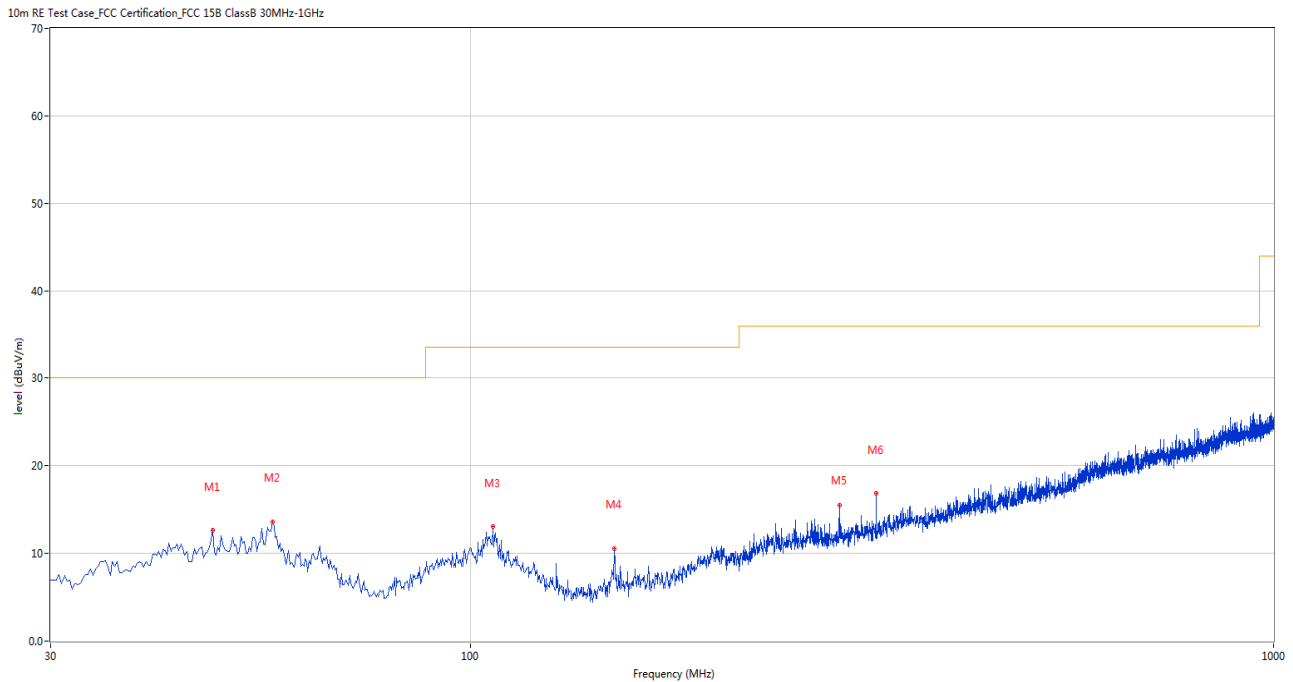

No.	Frequency (MHz)	Results (dBuV/m)	Factor (dB)	Limit (dBuV/m)	Over Limit (dB)	Detector	Table (Degree)	Height (cm)	Antenna	Verdict
1	47.698	12.60	-26.17	30.0	-17.40	Peak	0.00	200	Horizontal	Pass
2	56.668	13.61	-27.10	30.0	-16.39	Peak	156.00	200	Horizontal	Pass
3	106.611	13.02	-27.91	33.5	-20.48	Peak	297.00	200	Horizontal	Pass
4	150.977	10.53	-31.28	33.5	-22.97	Peak	135.00	200	Horizontal	Pass
5	287.956	15.50	-25.38	36.0	-20.50	Peak	135.00	200	Horizontal	Pass
6	319.958	16.82	-24.63	36.0	-19.18	Peak	0.00	200	Horizontal	Pass

30 MHz to 1 GHz, ANT V

10m RE Test Case\_FCC Certification\_FCC 15B ClassB 30MHz-1GHz

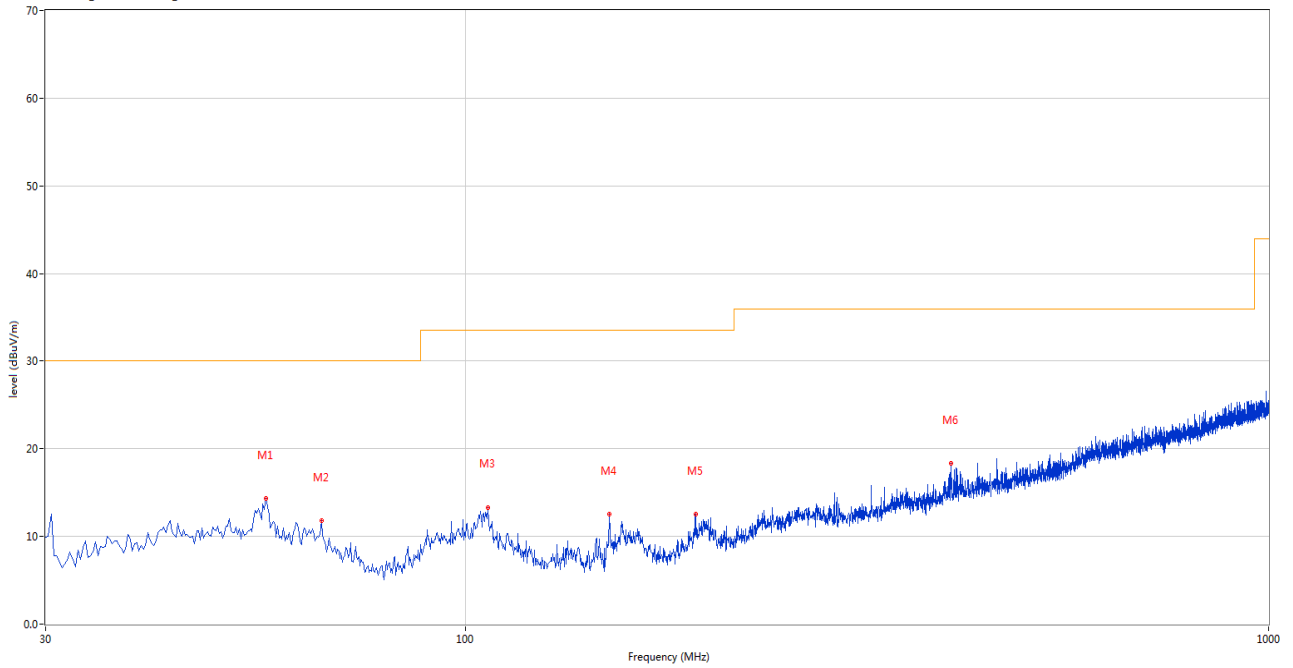

No.	Frequency (MHz)	Results (dBuV/m)	Factor (dB)	Limit (dBuV/m)	Over Limit (dB)	Detector	Table (Degree)	Height (cm)	Antenna	Verdict
1	56.426	14.31	-27.00	30.0	-15.69	Peak	271.00	200	Vertical	Pass
2	66.123	11.75	-28.66	30.0	-18.25	Peak	100.00	200	Vertical	Pass
3	106.611	13.27	-27.91	33.5	-20.23	Peak	236.00	200	Vertical	Pass
4	150.977	12.52	-31.28	33.5	-20.98	Peak	0.00	200	Vertical	Pass
5	193.404	12.49	-28.27	33.5	-21.01	Peak	255.00	100	Vertical	Pass
6	402.629	18.31	-22.31	36.0	-17.69	Peak	159.00	100	Vertical	Pass

Note 1: The marked spikes near 2400 MHz with circle should be ignored because they are Fundamental signal.

Note 2: The spurious from 18GHz-25GHz is noise only, do not show on the report.

**GFSK LOW CHANNEL 1 GHz to 18 GHz, ANT H**

RSE (SRD)\_FCC Part 15C\_FCC 15.247(2.4G)\_1GHz-18GHz

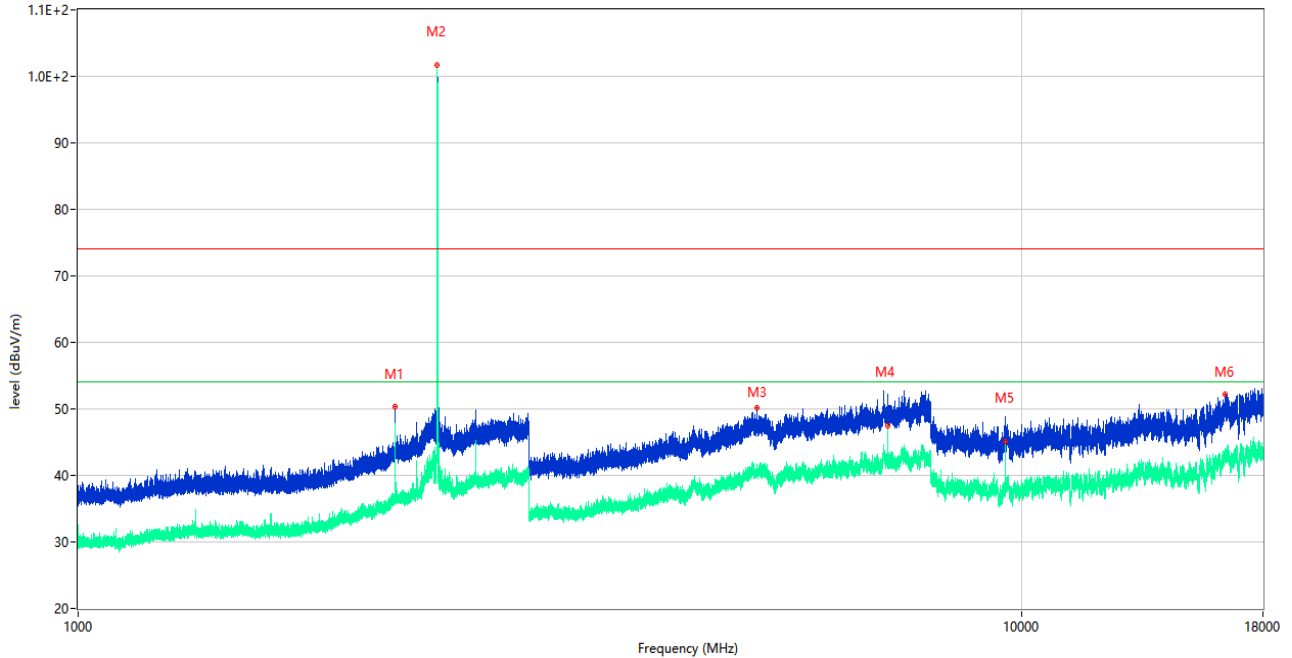

No.	Frequency (MHz)	Results (dBuV/m)	Factor (dB)	Limit (dBuV/m)	Over Limit (dB)	Detector	Table (Degree)	Height (cm)	Antenna	Verdict
1	2167.900	50.33	-13.35	74.0	-23.67	Peak	0.00	150	Horizontal	Pass
1**	2167.900	47.10	-13.35	54.0	-6.90	AV	0.00	150	Horizontal	Pass
2	2401.900	101.82	-13.34	74.0	27.82	Peak	92.00	150	Horizontal	N/A
2**	2401.900	100.81	-13.34	54.0	46.81	AV	92.00	150	Horizontal	N/A
3	5238.500	50.23	-3.22	74.0	-23.77	Peak	341.00	150	Horizontal	Pass
3**	5238.500	40.44	-3.22	54.0	-13.56	AV	341.00	150	Horizontal	Pass
4	7206.500	50.92	-1.10	74.0	-23.08	Peak	0.00	150	Horizontal	Pass
4**	7206.500	47.47	-1.10	54.0	-6.53	AV	0.00	150	Horizontal	Pass
5	9608.588	47.28	-5.08	74.0	-26.72	Peak	343.00	150	Horizontal	Pass
5**	9608.588	45.06	-5.08	54.0	-8.94	AV	343.00	150	Horizontal	Pass
6	16405.575	52.22	0.29	74.0	-21.78	Peak	174.00	150	Horizontal	Pass
6**	16405.575	43.51	0.29	54.0	-10.49	AV	174.00	150	Horizontal	Pass

**GFSK LOW CHANNEL 1 GHz to 18 GHz, ANT V**

RSE (SRD)\_FCC Part 15C\_FCC 15.247(2.4G)\_1GHz-18GHz

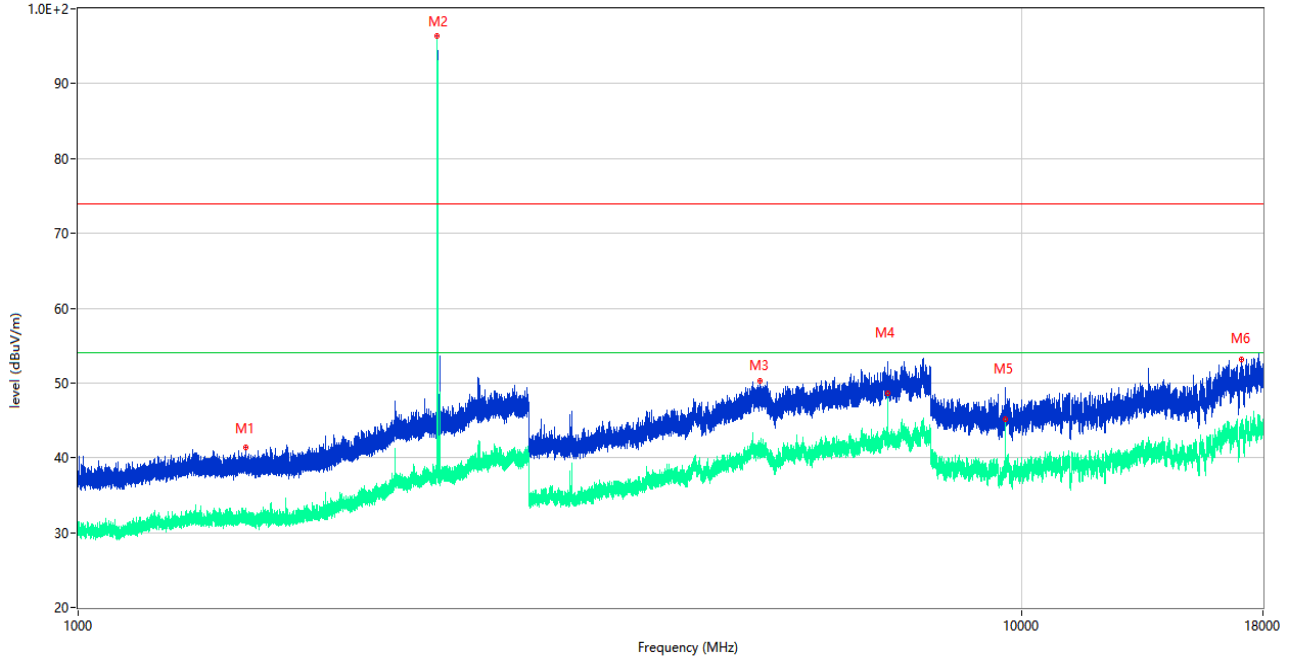

No.	Frequency (MHz)	Results (dBuV/m)	Factor (dB)	Limit (dBuV/m)	Over Limit (dB)	Detector	Table (Degree)	Height (cm)	Antenna	Verdict
1	1503.700	41.37	-17.39	74.0	-32.63	Peak	166.00	150	Vertical	Pass
1**	1503.700	31.63	-17.39	54.0	-22.37	AV	166.00	150	Vertical	Pass
2	2402.000	96.41	-13.34	74.0	22.41	Peak	174.00	150	Vertical	N/A
2**	2402.000	95.21	-13.34	54.0	41.21	AV	174.00	150	Vertical	N/A
3	5276.750	50.31	-3.44	74.0	-23.69	Peak	81.00	150	Vertical	Pass
3**	5276.750	41.03	-3.44	54.0	-12.97	AV	81.00	150	Vertical	Pass
4	7206.750	50.74	-1.12	74.0	-23.26	Peak	183.00	150	Vertical	Pass
4**	7206.750	48.60	-1.12	54.0	-5.40	AV	183.00	150	Vertical	Pass
5	9608.588	48.14	-5.08	74.0	-25.86	Peak	29.00	150	Vertical	Pass
5**	9608.588	45.13	-5.08	54.0	-8.87	AV	29.00	150	Vertical	Pass
6	17079.151	53.13	1.15	74.0	-20.87	Peak	164.00	150	Vertical	Pass
6**	17079.151	42.87	1.15	54.0	-11.13	AV	164.00	150	Vertical	Pass

**GFSK MIDDLE CHANNEL 1 GHz to 18 GHz, ANT H**

RSE (SRD)\_FCC Part 15C\_FCC 15.247(2.4G)\_1GHz-18GHz

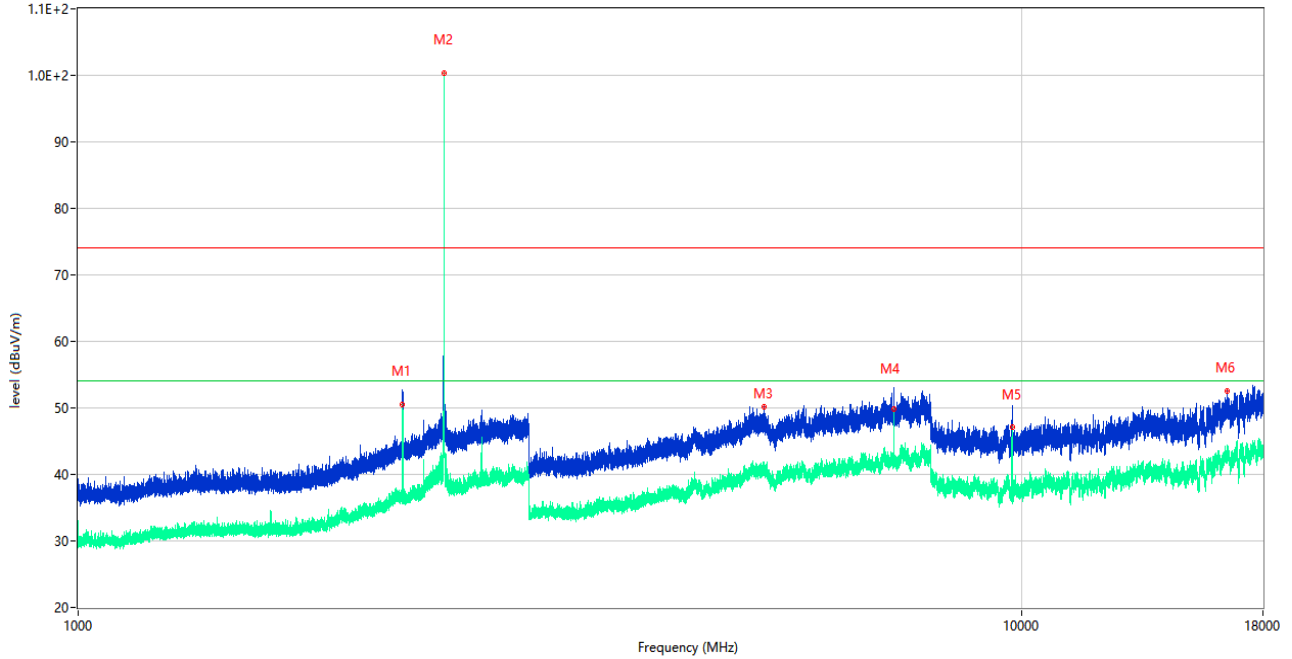

No.	Frequency (MHz)	Results (dBUV/m)	Factor (dB)	Limit (dBUV/m)	Over Limit (dB)	Detector	Table (Degree)	Height (cm)	Antenna	Verdict
1	2207.200	52.77	-13.56	74.0	-21.23	Peak	0.00	150	Horizontal	Pass
1**	2207.200	50.56	-13.56	54.0	-3.44	AV	0.00	150	Horizontal	Pass
2	2440.900	100.49	-12.31	74.0	26.49	Peak	96.00	150	Horizontal	N/A
2**	2440.900	99.50	-12.31	54.0	45.50	AV	96.00	150	Horizontal	N/A
3	5327.500	50.23	-3.39	74.0	-23.77	Peak	292.00	150	Horizontal	Pass
3**	5327.500	40.37	-3.39	54.0	-13.63	AV	292.00	150	Horizontal	Pass
4	7323.500	53.09	-0.58	74.0	-20.91	Peak	307.00	150	Horizontal	Pass
4**	7323.500	49.86	-0.58	54.0	-4.14	AV	307.00	150	Horizontal	Pass
5	9764.625	48.72	-4.97	74.0	-25.28	Peak	332.00	150	Horizontal	Pass
5**	9764.625	47.08	-4.97	54.0	-6.92	AV	332.00	150	Horizontal	Pass
6	16492.463	52.51	-0.00	74.0	-21.49	Peak	91.00	150	Horizontal	Pass
6**	16492.463	42.73	-0.00	54.0	-11.27	AV	91.00	150	Horizontal	Pass



**GFSK MIDDLE CHANNEL 1 GHz to 18 GHz, ANT V**

RSE (SRD)\_FCC Part 15C\_FCC 15.247(2.4G)\_1GHz-18GHz

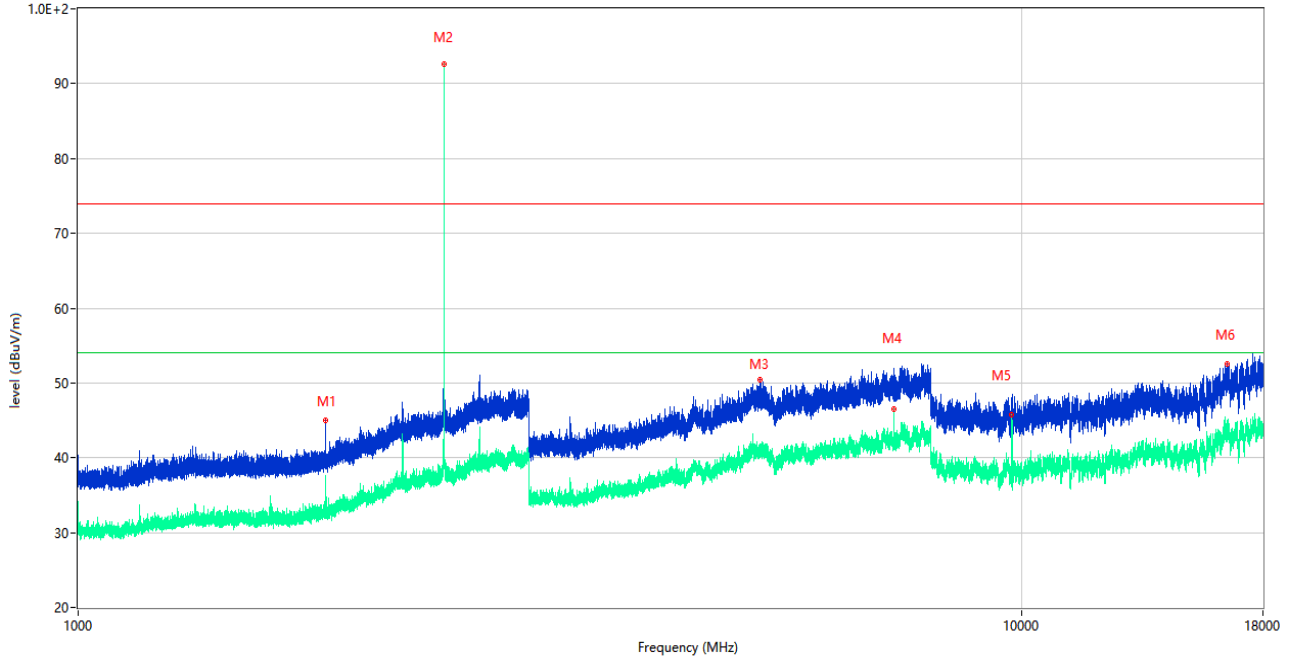

No.	Frequency (MHz)	Results (dBuV/m)	Factor (dB)	Limit (dBuV/m)	Over Limit (dB)	Detector	Table (Degree)	Height (cm)	Antenna	Verdict
1	1827.700	45.06	-17.19	74.0	-28.94	Peak	180.00	150	Vertical	Pass
1**	1827.700	35.70	-17.19	54.0	-18.30	AV	180.00	150	Vertical	Pass
2	2441.000	92.89	-12.31	74.0	18.89	Peak	175.00	150	Vertical	N/A
2**	2441.000	92.23	-12.31	54.0	38.23	AV	175.00	150	Vertical	N/A
3	5273.000	50.38	-3.17	74.0	-23.62	Peak	289.00	150	Vertical	Pass
3**	5273.000	41.25	-3.17	54.0	-12.75	AV	289.00	150	Vertical	Pass
4	7323.500	51.58	-0.58	74.0	-22.42	Peak	204.00	150	Vertical	Pass
4**	7323.500	46.50	-0.58	54.0	-7.50	AV	204.00	150	Vertical	Pass
5	9757.500	47.24	-4.86	74.0	-26.76	Peak	6.00	150	Vertical	Pass
5**	9757.500	45.71	-4.86	54.0	-8.29	AV	6.00	150	Vertical	Pass
6	16509.000	52.47	0.00	74.0	-21.53	Peak	307.00	150	Vertical	Pass
6**	16509.000	43.76	0.00	54.0	-10.24	AV	307.00	150	Vertical	Pass

**GFSK HIGH CHANNEL 1 GHz to 18 GHz, ANT H**

RSE (SRD)\_FCC Part 15C\_FCC 15.247(2.4G)\_1GHz-18GHz

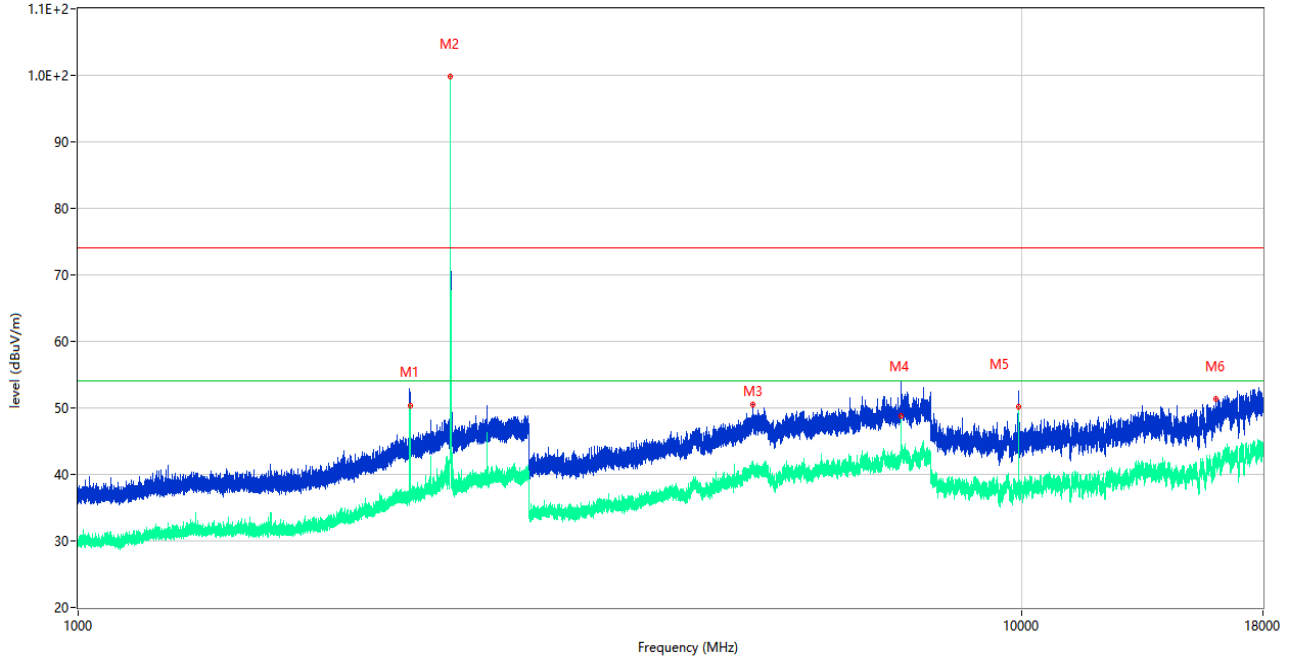

No.	Frequency (MHz)	Results (dBUV/m)	Factor (dB)	Limit (dBUV/m)	Over Limit (dB)	Detector	Table (Degree)	Height (cm)	Antenna	Verdict
1	2246.300	51.97	-13.65	74.0	-22.03	Peak	358.00	150	Horizontal	Pass
1**	2246.300	50.31	-13.65	54.0	-3.69	AV	358.00	150	Horizontal	Pass
2	2479.900	99.95	-13.07	74.0	25.95	Peak	20.00	150	Horizontal	N/A
2**	2479.900	98.96	-13.07	54.0	44.96	AV	20.00	150	Horizontal	N/A
3	5181.500	50.51	-2.15	74.0	-23.49	Peak	108.00	150	Horizontal	Pass
3**	5181.500	40.84	-2.15	54.0	-13.16	AV	108.00	150	Horizontal	Pass
4	7440.500	52.84	0.33	74.0	-21.16	Peak	307.00	150	Horizontal	Pass
4**	7440.500	48.77	0.33	54.0	-5.23	AV	307.00	150	Horizontal	Pass
5	9920.663	51.26	-5.15	74.0	-22.74	Peak	332.00	150	Horizontal	Pass
5**	9920.663	50.23	-5.15	54.0	-3.77	AV	332.00	150	Horizontal	Pass
6	16056.450	51.34	-0.21	74.0	-22.66	Peak	113.00	150	Horizontal	Pass
6**	16056.450	42.09	-0.21	54.0	-11.91	AV	113.00	150	Horizontal	Pass

**GFSK HIGH CHANNEL 1 GHz to 18 GHz, ANT V**

RSE (SRD)\_FCC Part 15C\_FCC 15.247(2.4G)\_1GHz-18GHz

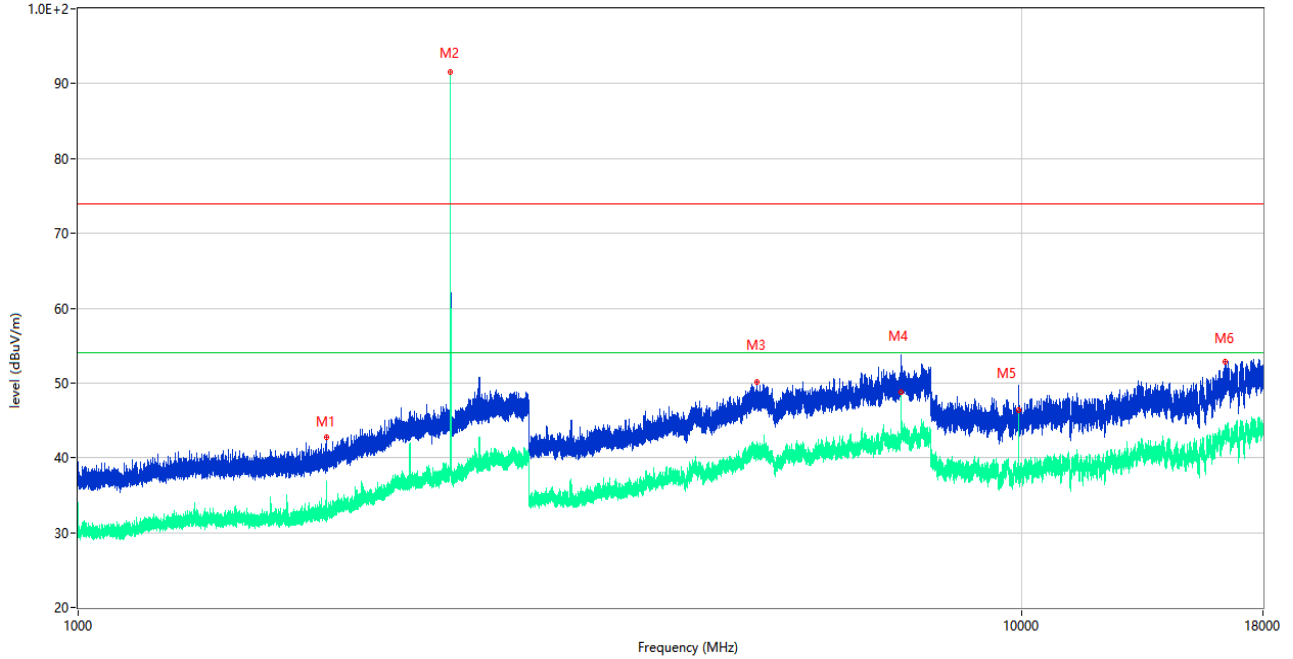

No.	Frequency (MHz)	Results (dBuV/m)	Factor (dB)	Limit (dBuV/m)	Over Limit (dB)	Detector	Table (Degree)	Height (cm)	Antenna	Verdict
1	1832.400	42.74	-17.17	74.0	-31.26	Peak	179.00	150	Vertical	Pass
1**	1832.400	32.72	-17.17	54.0	-21.28	AV	179.00	150	Vertical	Pass
2	2479.900	91.87	-13.07	74.0	17.87	Peak	171.00	150	Vertical	N/A
2**	2479.900	90.81	-13.07	54.0	36.81	AV	171.00	150	Vertical	N/A
3	5235.000	50.18	-3.29	74.0	-23.82	Peak	361.00	150	Vertical	Pass
3**	5235.000	40.64	-3.29	54.0	-13.36	AV	361.00	150	Vertical	Pass
4	7440.500	52.50	0.33	74.0	-21.50	Peak	76.00	150	Vertical	Pass
4**	7440.500	48.73	0.33	54.0	-5.27	AV	76.00	150	Vertical	Pass
5	9920.425	49.47	-5.15	74.0	-24.53	Peak	17.00	150	Vertical	Pass
5**	9920.425	46.34	-5.15	54.0	-7.66	AV	17.00	150	Vertical	Pass
6	16420.537	52.89	0.18	74.0	-21.11	Peak	135.00	150	Vertical	Pass
6**	16420.537	43.15	0.18	54.0	-10.85	AV	135.00	150	Vertical	Pass

8-DPSK LOW CHANNEL 1 GHz to 18 GHz, ANT H

RSE (SRD)\_FCC Part 15C\_FCC 15.247(2.4G)\_1GHz-18GHz

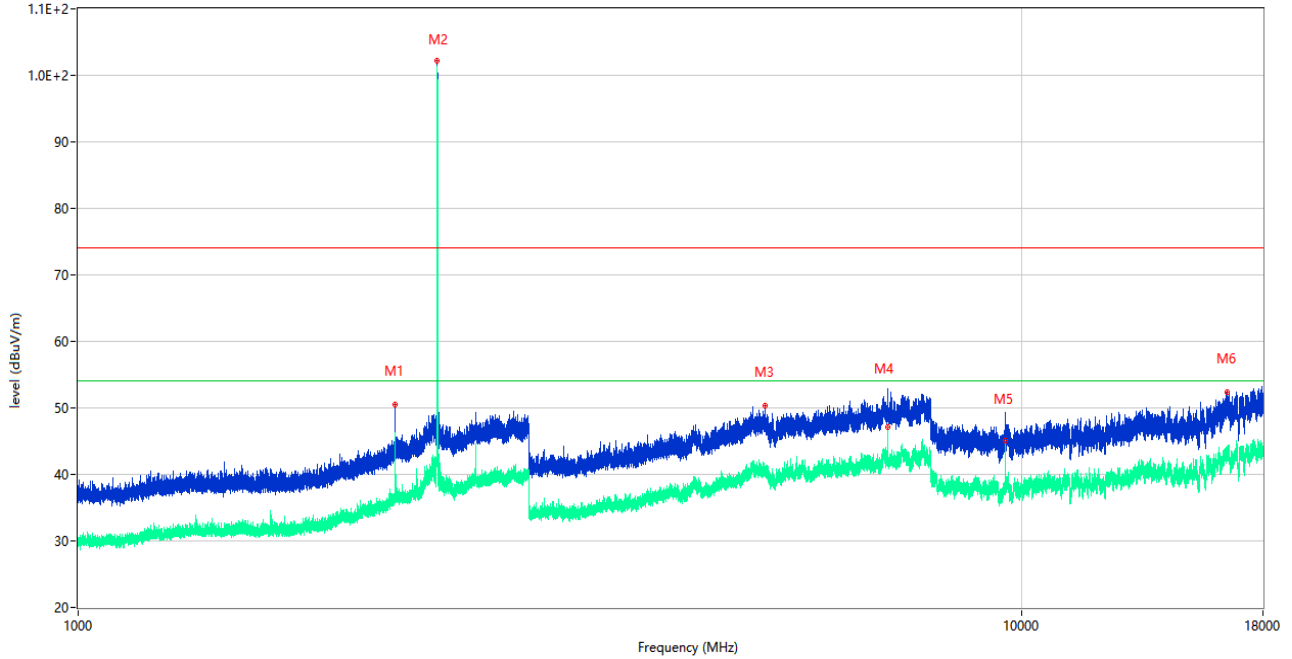

No.	Frequency (MHz)	Results (dBUV/m)	Factor (dB)	Limit (dBUV/m)	Over Limit (dB)	Detector	Table (Degree)	Height (cm)	Antenna	Verdict
1	2168.000	50.58	-13.36	74.0	-23.42	Peak	0.00	150	Horizontal	Pass
1**	2168.000	45.65	-13.36	54.0	-8.35	AV	0.00	150	Horizontal	Pass
2	2401.900	102.23	-13.34	74.0	28.23	Peak	93.00	150	Horizontal	N/A
2**	2401.900	100.49	-13.34	54.0	46.49	AV	93.00	150	Horizontal	N/A
3	5347.250	50.38	-3.20	74.0	-23.62	Peak	349.00	150	Horizontal	Pass
3**	5347.250	40.72	-3.20	54.0	-13.28	AV	349.00	150	Horizontal	Pass
4	7206.750	50.43	-1.12	74.0	-23.57	Peak	316.00	150	Horizontal	Pass
4**	7206.750	47.04	-1.12	54.0	-6.96	AV	316.00	150	Horizontal	Pass
5	9608.588	48.75	-5.08	74.0	-25.25	Peak	332.00	150	Horizontal	Pass
5**	9608.588	45.01	-5.08	54.0	-8.99	AV	332.00	150	Horizontal	Pass
6	16515.037	52.43	0.01	74.0	-21.57	Peak	360.00	150	Horizontal	Pass
6**	16515.037	42.94	0.01	54.0	-11.06	AV	360.00	150	Horizontal	Pass

8-DPSK LOW CHANNEL 1 GHz to 18 GHz, ANT V

RSE (SRD)\_FCC Part 15C\_FCC 15.247(2.4G)\_1GHz-18GHz

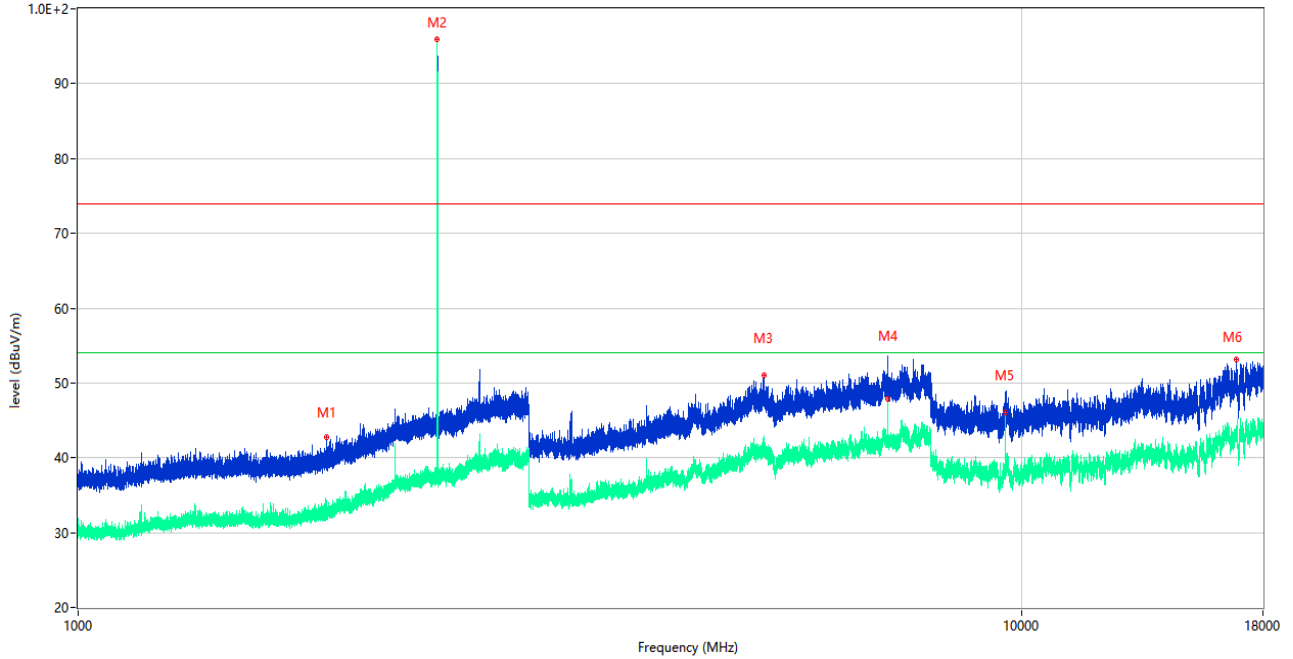

No.	Frequency (MHz)	Results (dBUV/m)	Factor (dB)	Limit (dBUV/m)	Over Limit (dB)	Detector	Table (Degree)	Height (cm)	Antenna	Verdict
1	1831.700	42.72	-17.19	74.0	-31.28	Peak	136.00	150	Vertical	Pass
1**	1831.700	32.06	-17.19	54.0	-21.94	AV	136.00	150	Vertical	Pass
2	2401.900	95.92	-13.34	74.0	21.92	Peak	174.00	150	Vertical	N/A
2**	2401.900	94.96	-13.34	54.0	40.96	AV	174.00	150	Vertical	N/A
3	5331.500	50.99	-3.75	74.0	-23.01	Peak	149.00	150	Vertical	Pass
3**	5331.500	40.43	-3.75	54.0	-13.57	AV	149.00	150	Vertical	Pass
4	7206.500	53.64	-1.10	74.0	-20.36	Peak	100.00	150	Vertical	Pass
4**	7206.500	47.86	-1.10	54.0	-6.14	AV	100.00	150	Vertical	Pass
5	9608.350	48.24	-5.08	74.0	-25.76	Peak	17.00	150	Vertical	Pass
5**	9608.350	46.06	-5.08	54.0	-7.94	AV	17.00	150	Vertical	Pass
6	16889.625	53.18	1.43	74.0	-20.82	Peak	147.00	150	Vertical	Pass
6**	16889.625	43.04	1.43	54.0	-10.96	AV	147.00	150	Vertical	Pass

8-DPSK MIDDLE CHANNEL 1 GHz to 18 GHz, ANT H

RSE (SRD)\_FCC Part 15C\_FCC 15.247(2.4G)\_1GHz-18GHz

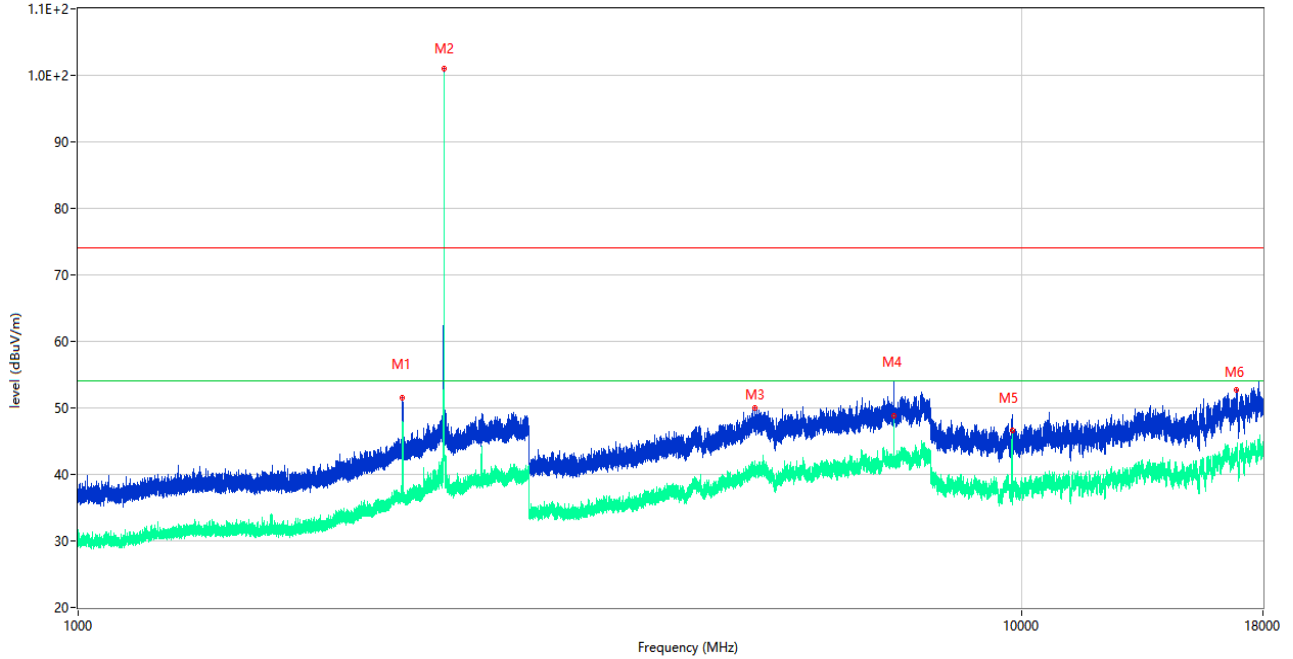

No.	Frequency (MHz)	Results (dBuV/m)	Factor (dB)	Limit (dBuV/m)	Over Limit (dB)	Detector	Table (Degree)	Height (cm)	Antenna	Verdict
1	2207.200	51.53	-13.56	74.0	-22.47	Peak	360.00	150	Horizontal	Pass
1**	2207.200	47.84	-13.56	54.0	-6.16	AV	360.00	150	Horizontal	Pass
2	2441.100	100.95	-12.30	74.0	26.95	Peak	92.00	150	Horizontal	N/A
2**	2441.100	100.19	-12.30	54.0	46.19	AV	92.00	150	Horizontal	N/A
3	5206.250	50.06	-3.41	74.0	-23.94	Peak	148.00	150	Horizontal	Pass
3**	5206.250	42.02	-3.41	54.0	-11.98	AV	148.00	150	Horizontal	Pass
4	7323.250	53.19	-0.60	74.0	-20.81	Peak	314.00	150	Horizontal	Pass
4**	7323.250	48.78	-0.60	54.0	-5.22	AV	314.00	150	Horizontal	Pass
5	9764.625	48.71	-4.97	74.0	-25.29	Peak	340.00	150	Horizontal	Pass
5**	9764.625	46.62	-4.97	54.0	-7.38	AV	340.00	150	Horizontal	Pass
6	16889.363	52.74	1.42	74.0	-21.26	Peak	0.00	150	Horizontal	Pass
6**	16889.363	43.38	1.42	54.0	-10.62	AV	0.00	150	Horizontal	Pass

8-DPSK MIDDLE CHANNEL 1 GHz to 18 GHz, ANT V

RSE (SRD)\_FCC Part 15C\_FCC 15.247(2.4G)\_1GHz-18GHz

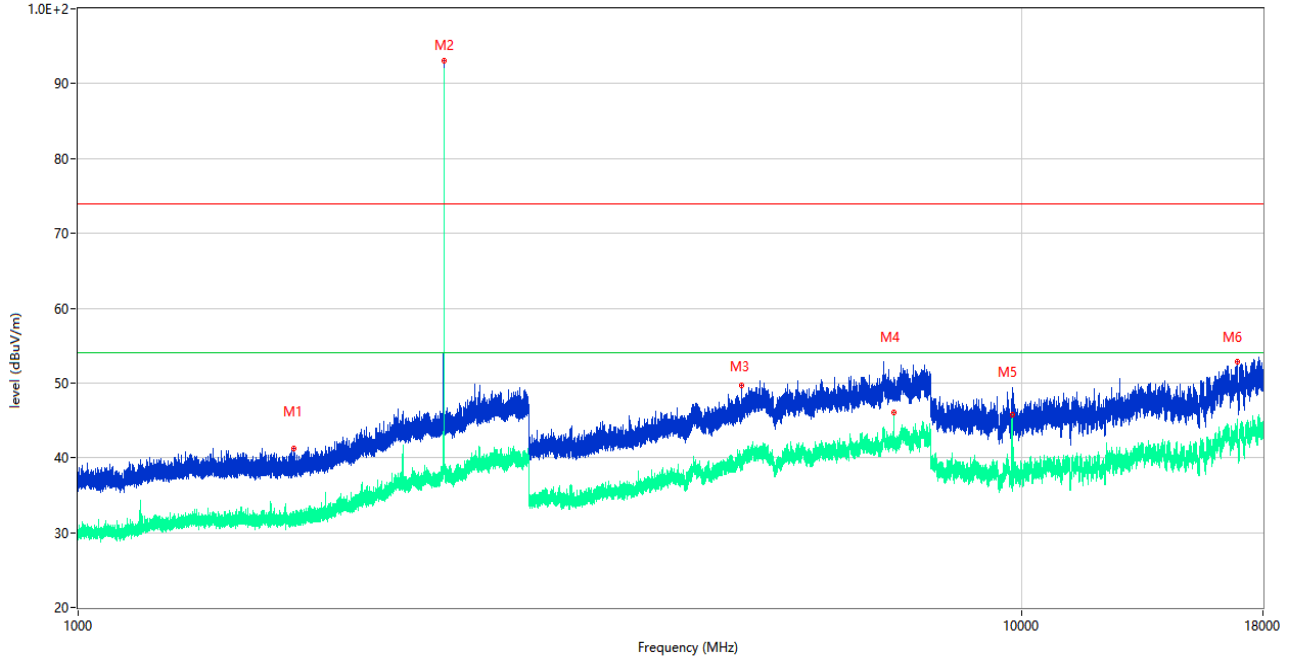

No.	Frequency (MHz)	Results (dBuV/m)	Factor (dB)	Limit (dBuV/m)	Over Limit (dB)	Detector	Table (Degree)	Height (cm)	Antenna	Verdict
1	1692.900	41.22	-17.40	74.0	-32.78	Peak	246.00	150	Vertical	Pass
1**	1692.900	31.58	-17.40	54.0	-22.42	AV	246.00	150	Vertical	Pass
2	2441.200	92.99	-12.29	74.0	18.99	Peak	174.00	150	Vertical	N/A
2**	2441.200	91.98	-12.29	54.0	37.98	AV	174.00	150	Vertical	N/A
3	5050.750	49.71	-3.78	74.0	-24.29	Peak	84.00	150	Vertical	Pass
3**	5050.750	39.34	-3.78	54.0	-14.66	AV	84.00	150	Vertical	Pass
4	7323.750	50.14	-0.56	74.0	-23.86	Peak	108.00	150	Vertical	Pass
4**	7323.750	46.02	-0.56	54.0	-7.98	AV	108.00	150	Vertical	Pass
5	9764.625	48.37	-4.97	74.0	-25.63	Peak	19.00	150	Vertical	Pass
5**	9764.625	45.77	-4.97	54.0	-8.23	AV	19.00	150	Vertical	Pass
6	16915.614	52.87	1.26	74.0	-21.13	Peak	32.00	150	Vertical	Pass
6**	16915.614	42.56	1.26	54.0	-11.44	AV	32.00	150	Vertical	Pass

8-DPSK HIGH CHANNEL 1 GHz to 18 GHz, ANT H

RSE (SRD)\_FCC Part 15C\_FCC 15.247(2.4G)\_1GHz-18GHz

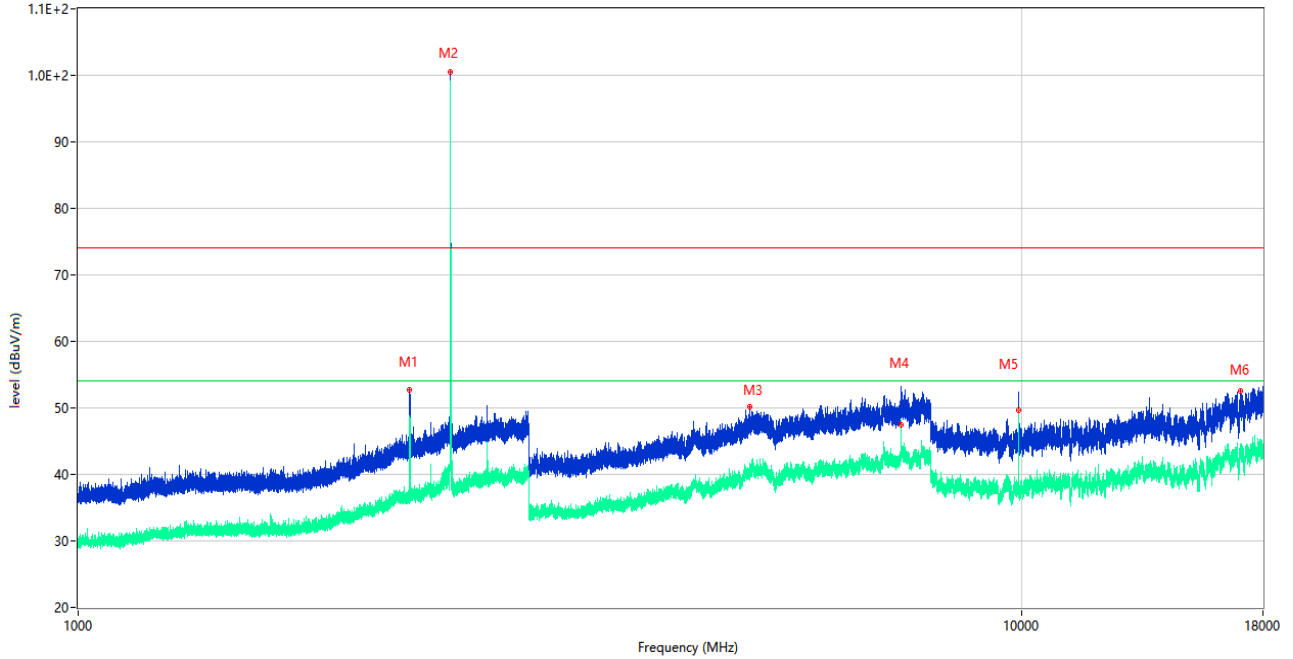

No.	Frequency (MHz)	Results (dBUV/m)	Factor (dB)	Limit (dBUV/m)	Over Limit (dB)	Detector	Table (Degree)	Height (cm)	Antenna	Verdict
1	2246.100	52.64	-13.66	74.0	-21.36	Peak	357.00	150	Horizontal	Pass
1**	2246.100	48.50	-13.66	54.0	-5.50	AV	357.00	150	Horizontal	Pass
2	2480.100	100.54	-13.08	74.0	26.54	Peak	18.00	150	Horizontal	N/A
2**	2480.100	99.15	-13.08	54.0	45.15	AV	18.00	150	Horizontal	N/A
3	5150.000	50.12	-3.51	74.0	-23.88	Peak	108.00	150	Horizontal	Pass
3**	5150.000	41.15	-3.51	54.0	-12.85	AV	108.00	150	Horizontal	Pass
4	7440.000	52.47	0.29	74.0	-21.53	Peak	33.00	150	Horizontal	Pass
4**	7440.000	47.42	0.29	54.0	-6.58	AV	33.00	150	Horizontal	Pass
5	9920.663	50.49	-5.15	74.0	-23.51	Peak	330.00	150	Horizontal	Pass
5**	9920.663	49.73	-5.15	54.0	-4.27	AV	330.00	150	Horizontal	Pass
6	17045.026	52.57	0.88	74.0	-21.43	Peak	329.00	150	Horizontal	Pass
6**	17045.026	43.32	0.88	54.0	-10.68	AV	329.00	150	Horizontal	Pass



8-DPSK HIGH CHANNEL 1 GHz to 18 GHz, ANT V

RSE (SRD)\_FCC Part 15C\_FCC 15.247(2.4G)\_1GHz-18GHz

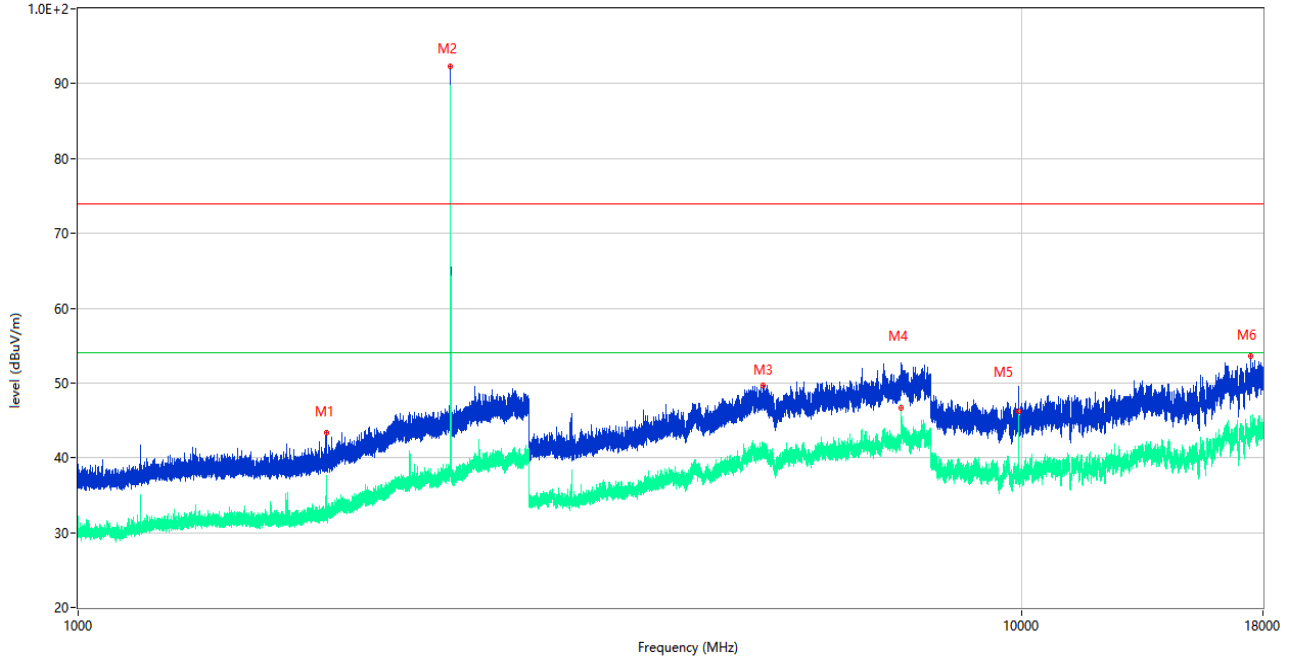

No.	Frequency (MHz)	Results (dBuV/m)	Factor (dB)	Limit (dBuV/m)	Over Limit (dB)	Detector	Table (Degree)	Height (cm)	Antenna	Verdict
1	1831.900	43.33	-17.20	74.0	-30.67	Peak	144.00	150	Vertical	Pass
1**	1831.900	33.21	-17.20	54.0	-20.79	AV	144.00	150	Vertical	Pass
2	2480.000	92.25	-13.08	74.0	18.25	Peak	171.00	150	Vertical	N/A
2**	2480.000	88.74	-13.08	54.0	34.74	AV	171.00	150	Vertical	N/A
3	5319.250	49.65	-3.53	74.0	-24.35	Peak	309.00	150	Vertical	Pass
3**	5319.250	40.82	-3.53	54.0	-13.18	AV	309.00	150	Vertical	Pass
4	7440.500	51.84	0.33	74.0	-22.16	Peak	128.00	150	Vertical	Pass
4**	7440.500	46.68	0.33	54.0	-7.32	AV	128.00	150	Vertical	Pass
5	9920.425	49.47	-5.15	74.0	-24.53	Peak	17.00	150	Vertical	Pass
5**	9920.425	46.17	-5.15	54.0	-7.83	AV	17.00	150	Vertical	Pass
6	17476.575	53.62	3.09	74.0	-20.38	Peak	172.00	150	Vertical	Pass
6**	17476.575	43.91	3.09	54.0	-10.09	AV	172.00	150	Vertical	Pass

## A.9 Band Edge (Restricted-band band-edge)

Note<sup>1</sup>: The lowest and highest channels are tested to verify the band edge emissions. Please refer to the following the plots for emissions values.

Note<sup>2</sup>: The test data all are tested in the vertical and horizontal antenna which the trace is max hold. So these plots have shown the worst case.

Note<sup>3</sup>: According the ANSI C63.10-2013, where limits are specified for both average and peak (or quasi-peak) detector functions, if the peak (or quasi-peak) measured value complies with the average limit, it is unnecessary to perform an average measurement.

Note<sup>4</sup>: The Level (dBuV/m) has been corrected by factor.

### Test Data and Plots

#### GFSK LOW CHANNEL

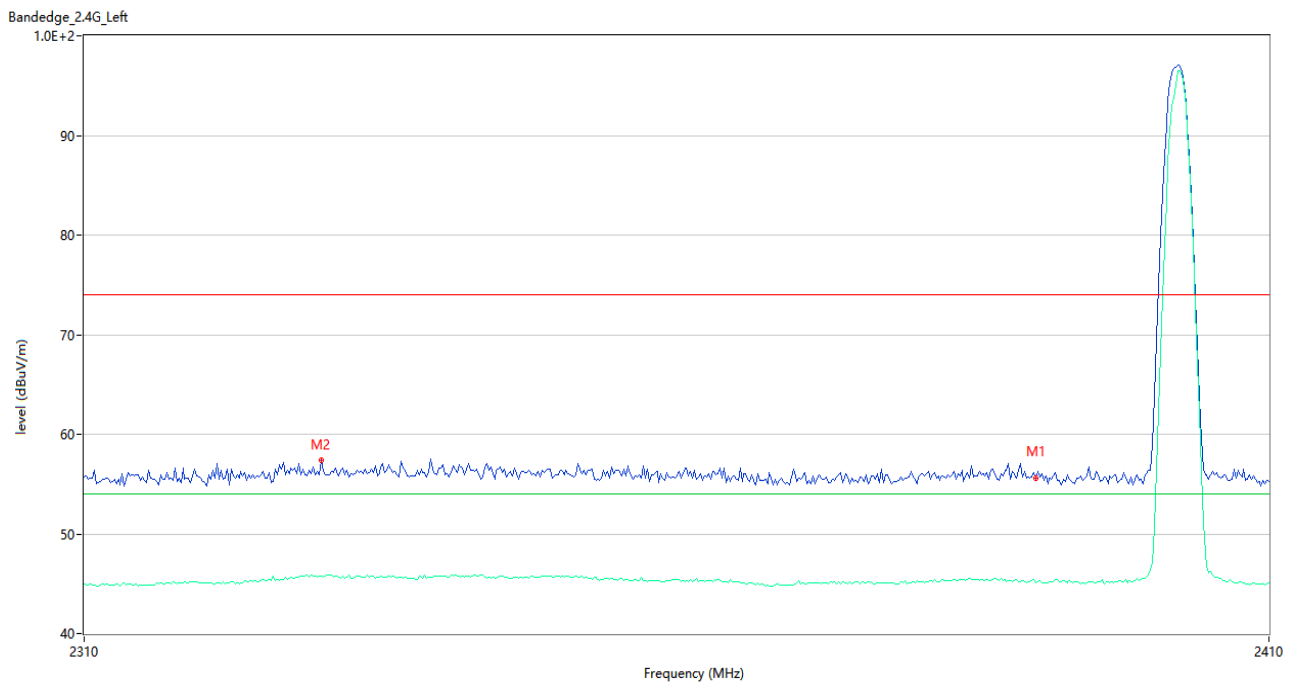

No.	Frequency (MHz)	Results (dBuV/m)	Factor (dB)	Limit (dBuV/m)	Over Limit (dB)	Detector	Table (Degree)	Height (cm)	Antenna	Verdict
1	2390.000	55.65	1.62	74.0	-18.35	Peak	220.00	150	Vertical	Pass
1**	2390.000	45.14	1.62	54.0	-8.86	AV	220.00	150	Vertical	Pass
2	2329.667	57.39	2.43	74.0	-16.61	Peak	6.00	150	Vertical	Pass
2**	2329.667	45.76	2.43	54.0	-8.24	AV	6.00	150	Vertical	Pass

**GFSK HIGH CHANNEL**

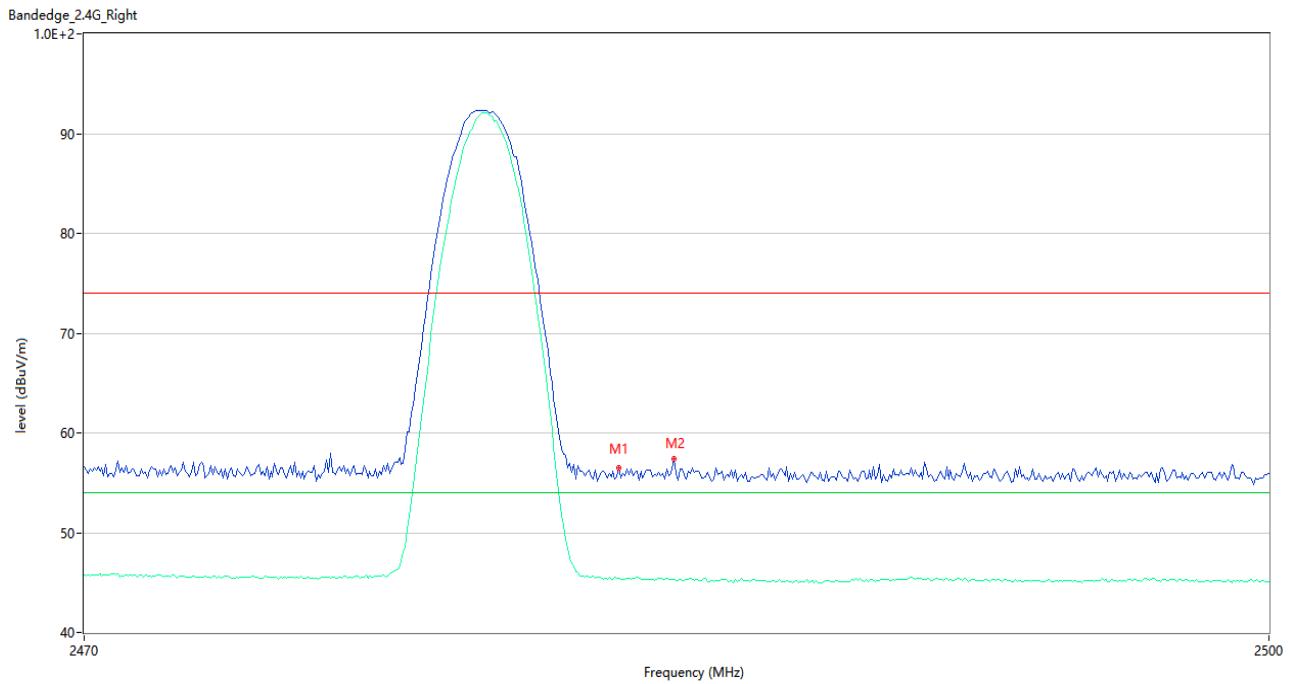

No.	Frequency (MHz)	Results (dBuV/m)	Factor (dB)	Limit (dBuV/m)	Over Limit (dB)	Detector	Table (Degree)	Height (cm)	Antenna	Verdict
1	2483.500	56.46	1.98	74.0	-17.54	Peak	332.00	150	Vertical	Pass
1**	2483.500	45.44	1.98	54.0	-8.56	AV	332.00	150	Vertical	Pass
2	2484.900	57.40	1.93	74.0	-16.60	Peak	302.00	150	Vertical	Pass
2**	2484.900	45.31	1.93	54.0	-8.69	AV	302.00	150	Vertical	Pass

8-DPSK LOW CHANNEL

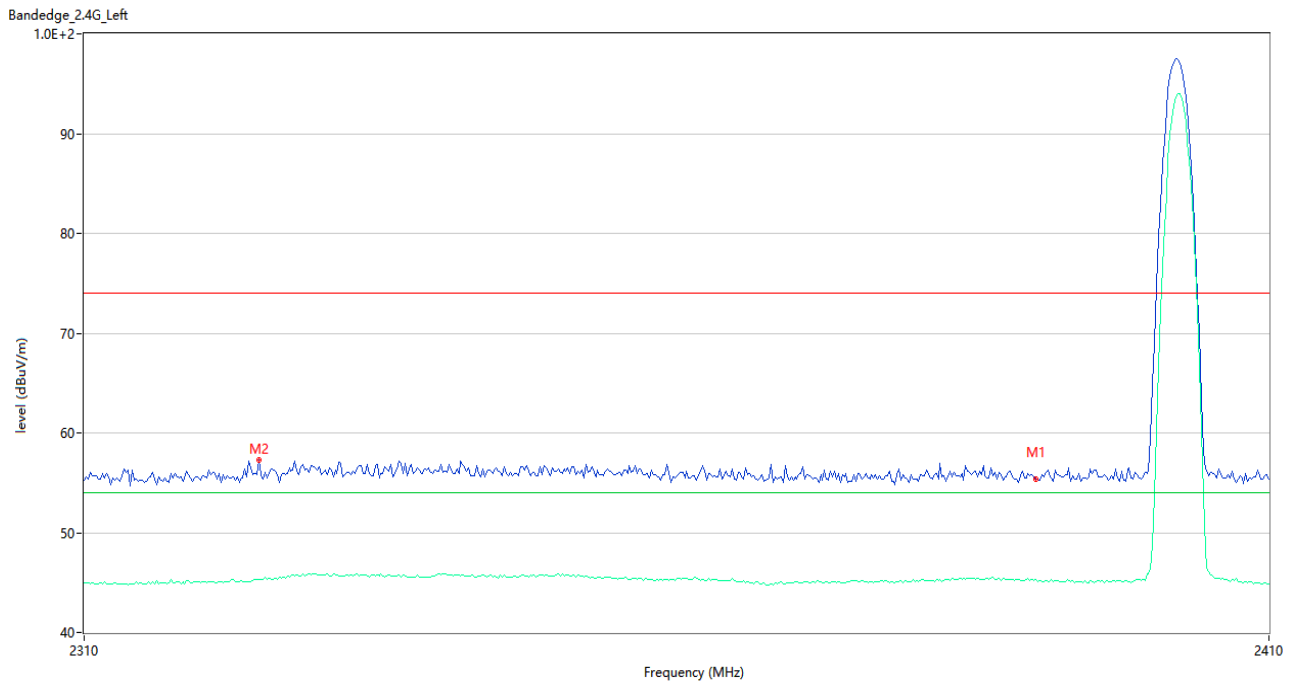

No.	Frequency (MHz)	Results (dBuV/m)	Factor (dB)	Limit (dBuV/m)	Over Limit (dB)	Detector	Table (Degree)	Height (cm)	Antenna	Verdict
1	2390.000	55.41	1.62	74.0	-18.59	Peak	222.00	150	Vertical	Pass
1**	2390.000	45.26	1.62	54.0	-8.74	AV	222.00	150	Vertical	Pass
2	2324.500	57.31	1.98	74.0	-16.69	Peak	344.00	150	Vertical	Pass
2**	2324.500	45.27	1.98	54.0	-8.73	AV	344.00	150	Vertical	Pass

8-DPSK HIGH CHANNEL

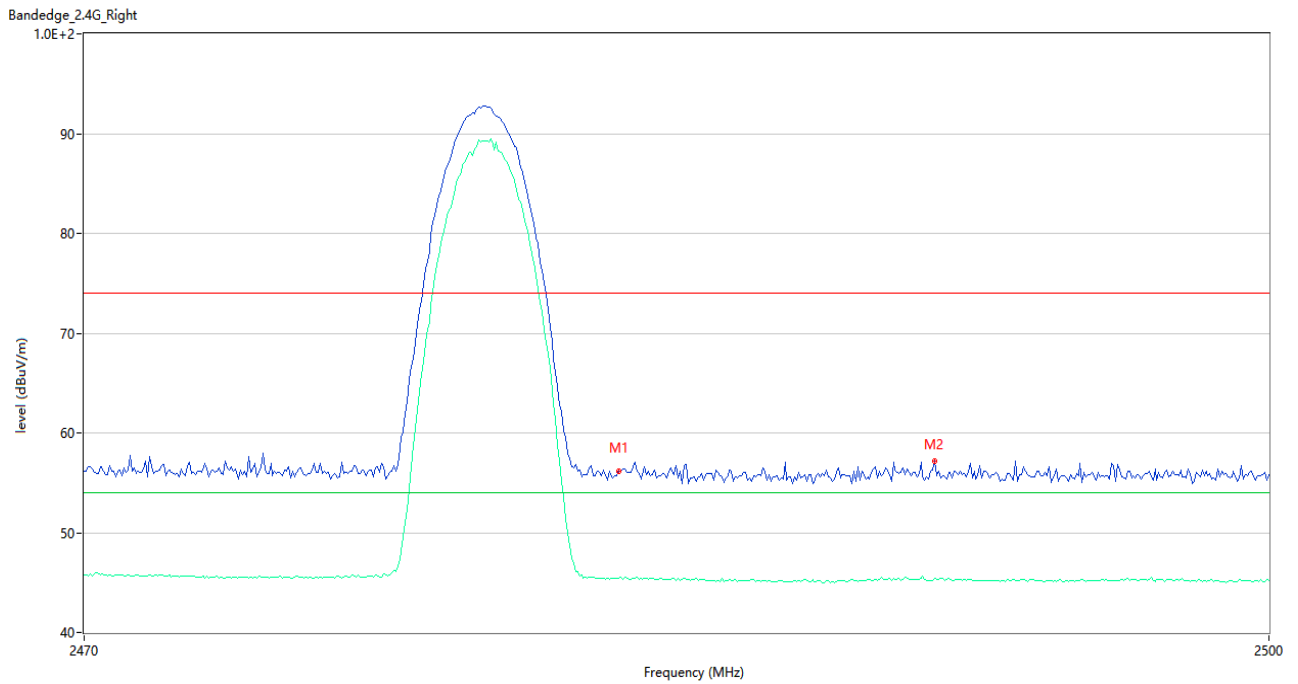

No.	Frequency (MHz)	Results (dBuV/m)	Factor (dB)	Limit (dBuV/m)	Over Limit (dB)	Detector	Table (Degree)	Height (cm)	Antenna	Verdict
1	2483.500	56.10	1.98	74.0	-17.90	Peak	212.00	150	Vertical	Pass
1**	2483.500	45.41	1.98	54.0	-8.59	AV	212.00	150	Vertical	Pass
2	2491.500	57.14	1.91	74.0	-16.86	Peak	352.00	150	Vertical	Pass
2**	2491.500	45.39	1.91	54.0	-8.61	AV	352.00	150	Vertical	Pass

## **ANNEX B TEST SETUP PHOTOS**

Please refer the document “BL-SZ2210947-AR.PDF”.

## **ANNEX C EUT EXTERNAL PHOTOS**

Please refer the document “BL-SZ2210947-AW.PDF”.

## **ANNEX D EUT INTERNAL PHOTOS**

Please refer the document “BL-SZ2210947-AI.PDF”.

-

## Statement

1. The laboratory guarantees the scientificity, accuracy and impartiality of the test, and is responsible for all the information in the report, except the information provided by the customer. The customer is responsible for the impact of the information provided on the validity of the results.
2. The report without China inspection body and laboratory Mandatory Approval (CMA) mark has no effect of proving to the society.
3. For the report with CNAS mark or A2LA mark, the items marked with "☆" are not within the accredited scope.
4. This report is invalid if it is altered, without the signature of the testing and approval personnel, or without the "inspection and testing dedicated stamp" or test report stamp.
5. The test data and results are only valid for the tested samples provided by the customer.
6. This report shall not be partially reproduced without the written permission of the laboratory.
7. Any objection shall be raised to the laboratory within 30 days after receiving the report.

--END OF REPORT--