

**Product Model:** MF8280  
**Product Name:** CREATIVE CHRONO

**01) Product marking and marking Location**

**Front overall view**

**Product overall dimension:** 111.2mm (L) x 103.4mm (W) x 57.3mm (H)  
**Weight:** 0.362 Kg

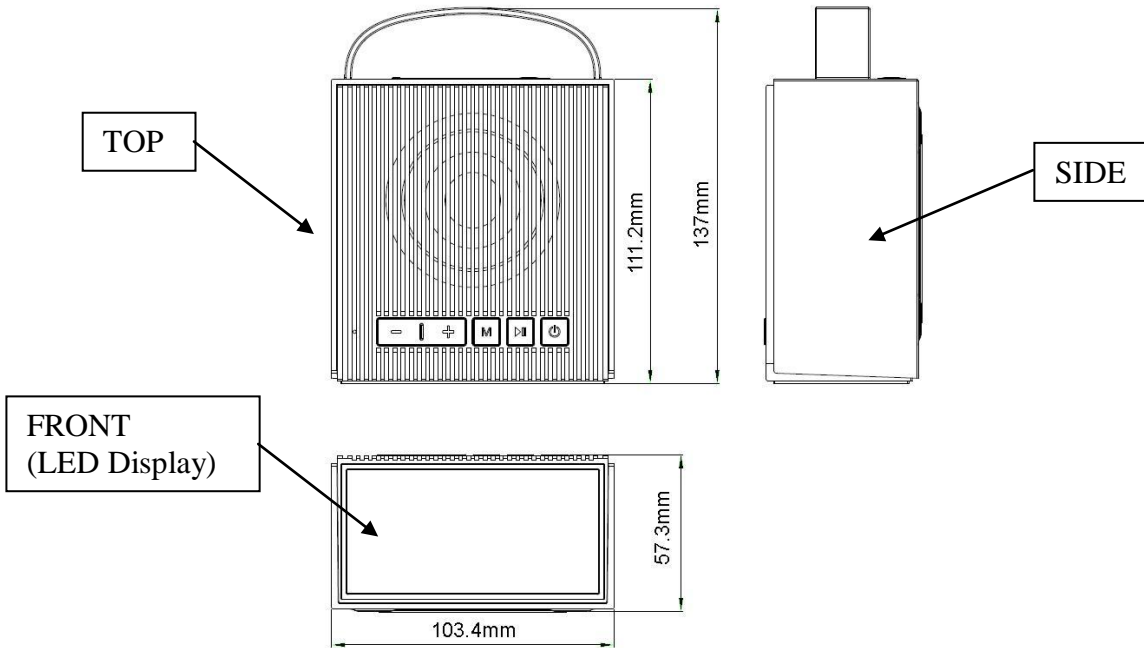

**Top View**

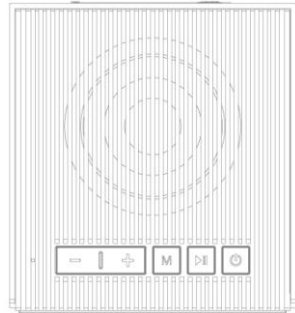

**Bottom View**

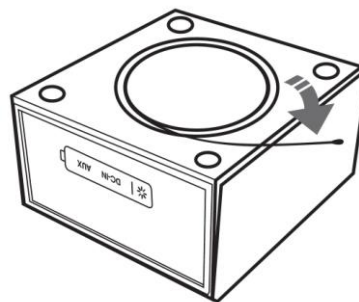

**Back View**

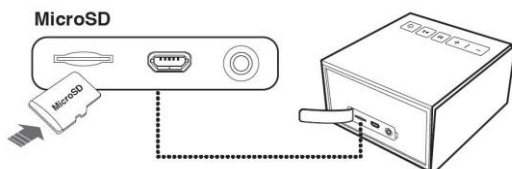
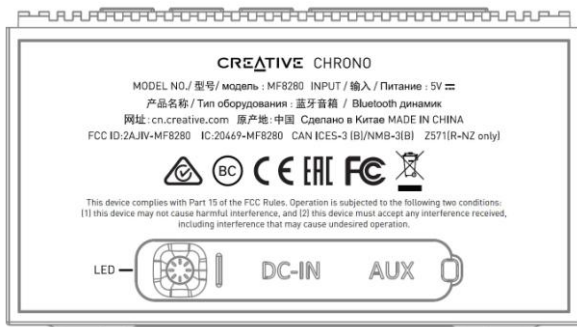

**Bottom View**

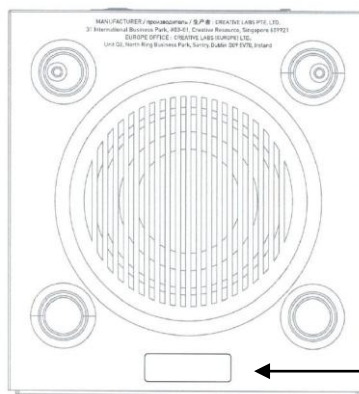

Barcode / Serial no.	S/N: W6MF8280706R00180V 
Date code	W6MF8280706R00180V 7 : YEAR 2017 06 : WEEK 06

## 02) Product marking silkscreen

### a) Location: Back

Dimension: 78mm (L) X 32mm (W)

**CREATIVE CHRONO**

MODEL NO./ 型号/ модель : MF8280 INPUT / 输入 / Питание : 5V 

产品名称 / Тип оборудования : 蓝牙音箱 / Bluetooth динамик

网址: cn.creative.com 原产地: 中国 Сделано в Китае MADE IN CHINA

FCC ID:2AJIV-MF8280 IC:20469-MF8280 CAN ICES-3 (B)/NMB-3(B) Z571(R-NZ only)



This device complies with Part 15 of the FCC Rules. Operation is subjected to the following two conditions:  
 (1) this device may not cause harmful interference, and (2) this device must accept any interference received,  
 including interference that may cause undesired operation.

### b) Location: Bottom enclosure (Upper portion)

Dimension: 66mm (L) X 10mm (W)

MANUFACTURER / производитель / 生产者 : CREATIVE LABS PTE. LTD.

31 International Business Park, #03-01, Creative Resource, Singapore 609921

EUROPE OFFICE : CREATIVE LABS (EUROPE) LTD.

Unit Q2, North Ring Business Park, Santry, Dublin D09 EV70, Ireland

### c) Location: Bottom enclosure (Lower portion)

Dimension: 50mm (L) X 10mm (W)



Barcode / Serial number label

## 03) FCC Marking location

### a) Location: Back

**CREATIVE CHRONO**

MODEL NO./ 型号/ модель : MF8280 INPUT / 输入 / Питание : 5V 

产品名称 / Тип оборудования : 蓝牙音箱 / Bluetooth динамик

网址: cn.creative.com 原产地: 中国 Сделано в Китае MADE IN CHINA

FCC ID:2AJIV-MF8280 IC:20469-MF8280 CAN ICES-3 (B)/NMB-3(B) Z571(R-NZ only)



This device complies with Part 15 of the FCC Rules. Operation is subjected to the following two conditions:  
 (1) this device may not cause harmful interference, and (2) this device must accept any interference received,  
 including interference that may cause undesired operation.

Item	Description	Logo / Statement
01	FCC logo  (Height:5.20mm)	
02	FCC ID	FCCID:2AJIV-MF8280
03	FCC statement	This device complies with Part 15 of the FCC Rules. Operation is subject to the following two conditions: (1) this device may not cause harmful interference, and (2) this device must accept any interference received, including interference that may cause undesired operation.

## 04) Canadian Marking

### a) Location: Back

**CREATIVE CHRONO**

MODEL NO./ 型号/ модель : MF8280 INPUT / 输入 / Питание : 5V 

产品名称 / Тип оборудования : 蓝牙音箱 / Bluetooth динамик

网址 : cn.creative.com 原产地 : 中国 Сделано в Китае MADE IN CHINA

FCC ID: 2AJIV-MF8280 IC: 20469-MF8280 CAN ICES-3 (B)/NMB-3(B) Z571(R-NZ only)







This device complies with Part 15 of the FCC Rules. Operation is subjected to the following two conditions:  
 (1) this device may not cause harmful interference, and (2) this device must accept any interference received,  
 including interference that may cause undesired operation.

Item	Description	Logo / Marking
01	Industry Canada (IC No.)	IC:20469-MF8280
02	Canadian Compliance statement	CAN ICES-3 (B) / NMB-3 (B)

## 05) BC Marking

### a) Location: Back

**CREATIVE CHRONO**

MODEL NO./ 型号/ модель : MF8280 INPUT / 输入 / Питание : 5V 

产品名称 / Тип оборудования : 蓝牙音箱 / Bluetooth динамик

网址 : cn.creative.com 原产地 : 中国 Сделано в Китае MADE IN CHINA

FCC ID: 2AJIV-MF8280 IC: 20469-MF8280 CAN ICES-3 (B)/NMB-3(B) Z571(R-NZ only)









This device complies with Part 15 of the FCC Rules. Operation is subjected to the following two conditions:  
 (1) this device may not cause harmful interference, and (2) this device must accept any interference received,  
 including interference that may cause undesired operation.

### b) Location: Bottom enclosure (Upper portion)

MANUFACTURER / производитель / 生产者 : CREATIVE LABS PTE. LTD.  
 31 International Business Park, #03-01, Creative Resource, Singapore 609921  
 EUROPE OFFICE : CREATIVE LABS (EUROPE) LTD.  
 Unit Q2, North Ring Business Park, Santry, Dublin D09 EV70, Ireland

### c) Location: Bottom enclosure (Lower portion)

Barcode / Serial number label

Item	Description	Logo
01	"BC" logo per CEC efficiency requirement on battery charging systems  (Height: 5.20mm)	
02	Date of manufacture	Barcode / Serial no. <span style="float: right;">S/N: W6MF8280706R00180V  MADE IN CHINA FABRIQUÉ EN CHINE</span>
		Date code <span style="float: right;">W6MF8280706R00180V 7 : YEAR 2017 06 : WEEK 06</span>

## 06) Product packaging outer box



Item	Description	Logo
01	CE marking	
02	Product name and model	<p>Model No.: MF8280</p> <p><b>CREATIVE® CHRONO</b></p>
03	Manufacturer name, Importer name and address	<p>Manufacturer: Creative Labs Pte. Ltd. 31 International Business Park, #03-01 Creative Resource, Singapore 609921</p> <p>Europe Office: Creative Labs (Europe) Ltd. Unit Q2, North Ring Business Park, Santry, Dublin, D09 EV70, Ireland</p>