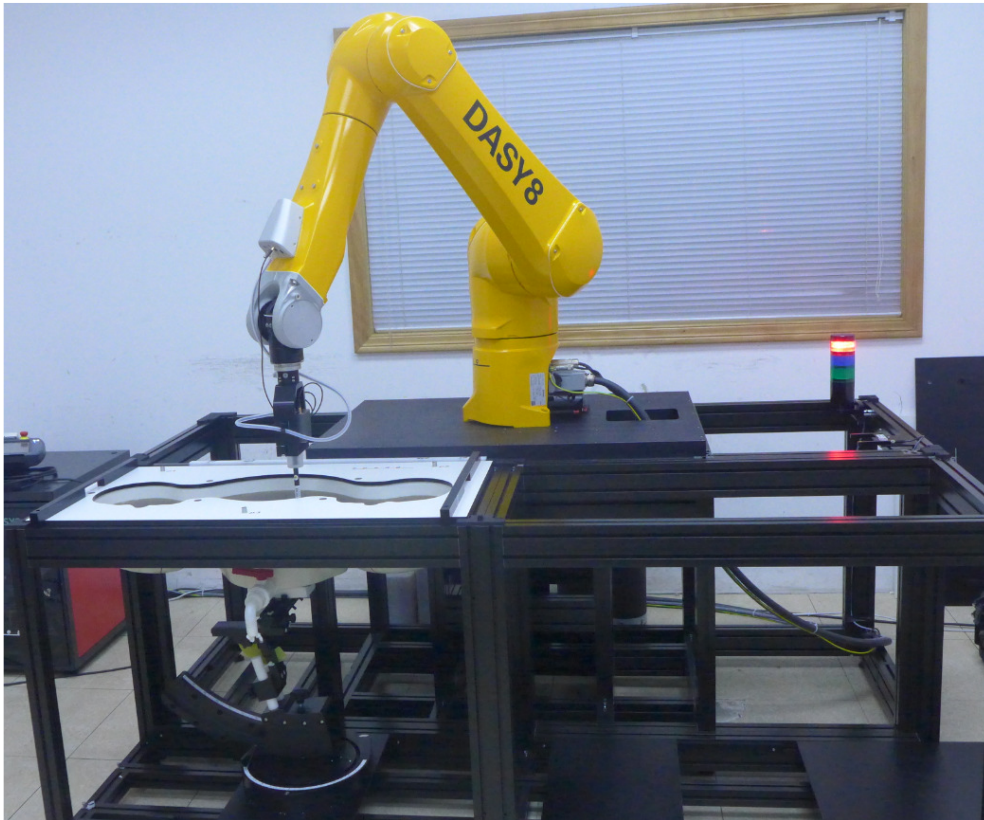


Appendix D

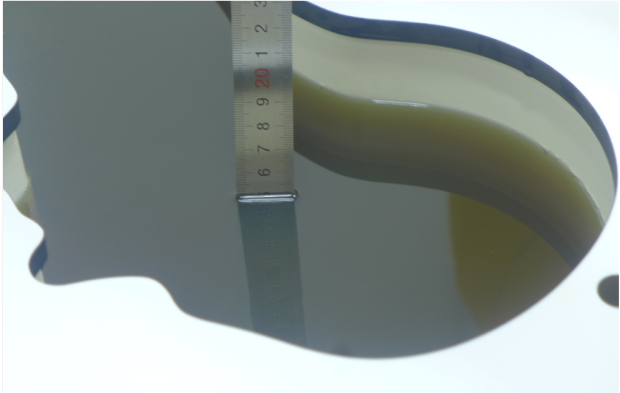
Photographs

1. SAR measurement System
2. Photographs of Tissue Simulate Liquid
3. Photographs of EUT test position
4. EUT Antenna Locations
5. EUT Constructional Details

1. SAR measurement System

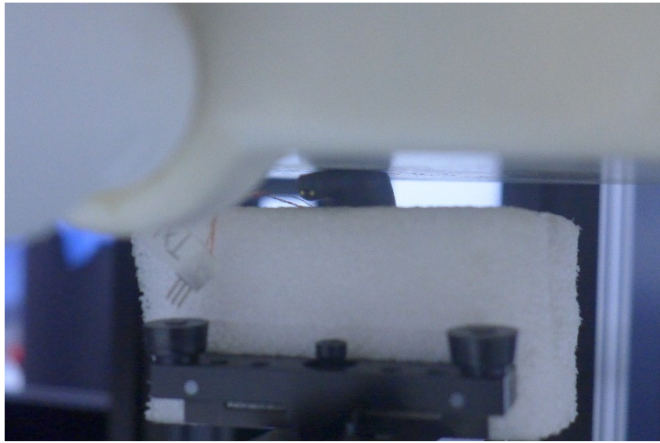
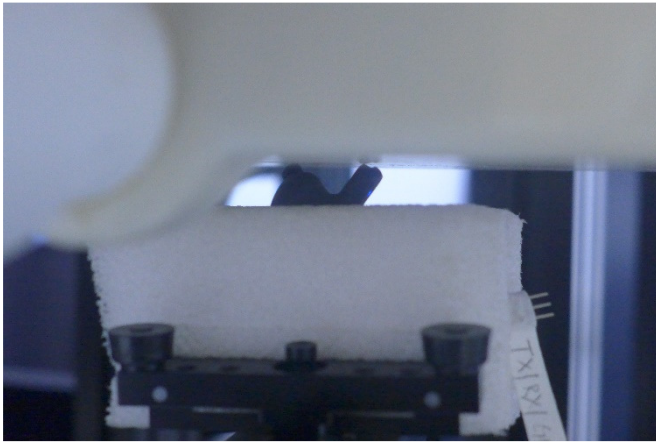
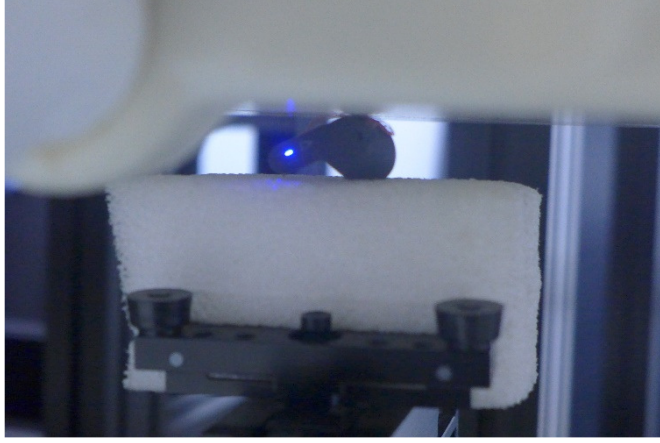

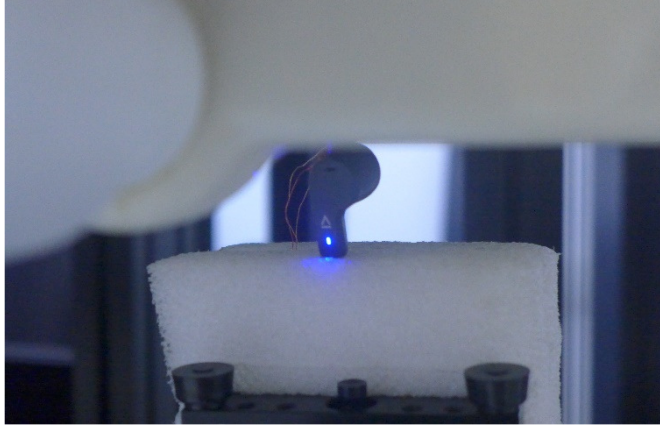
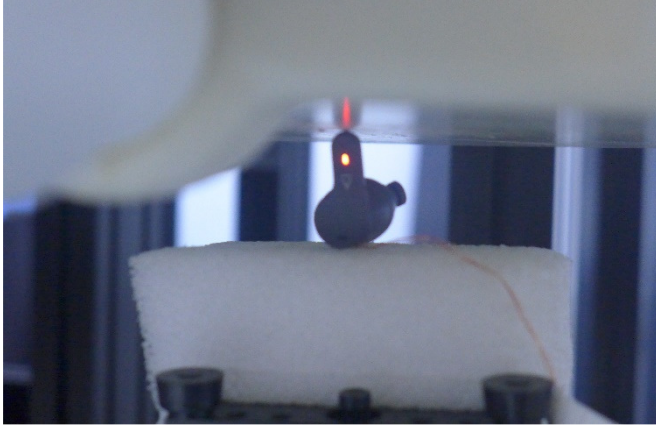


2. Photographs of Tissue Simulate Liquid

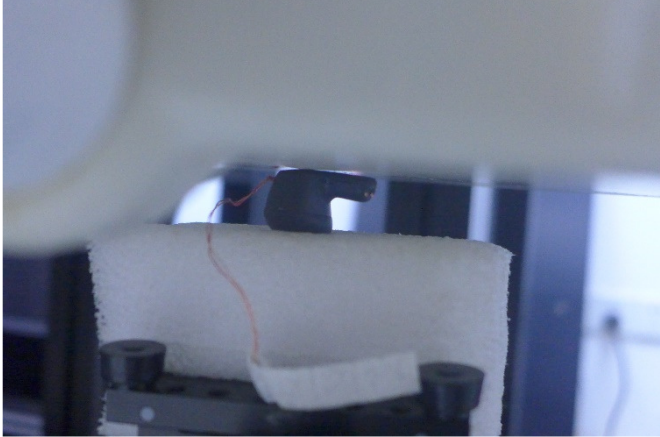

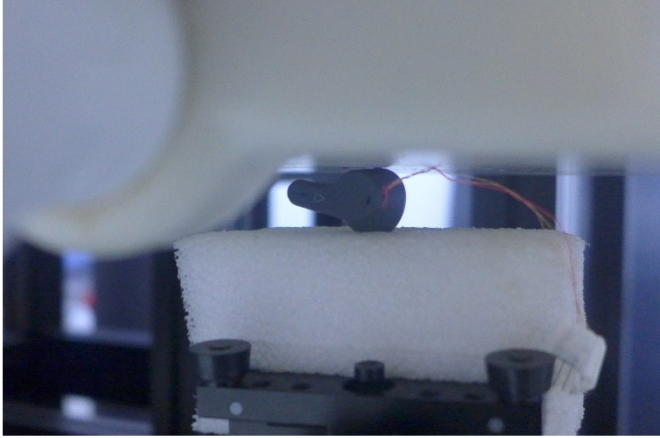
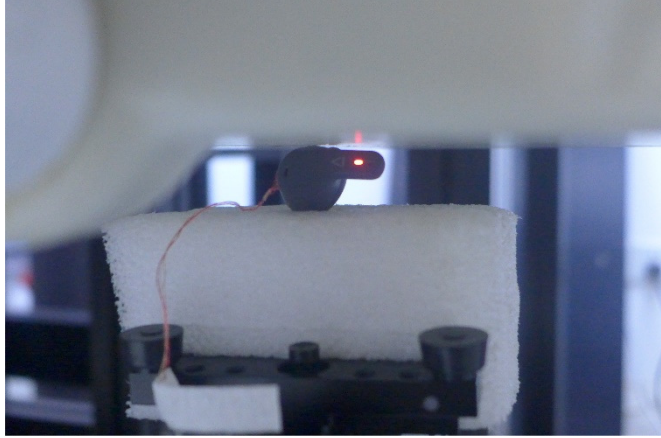
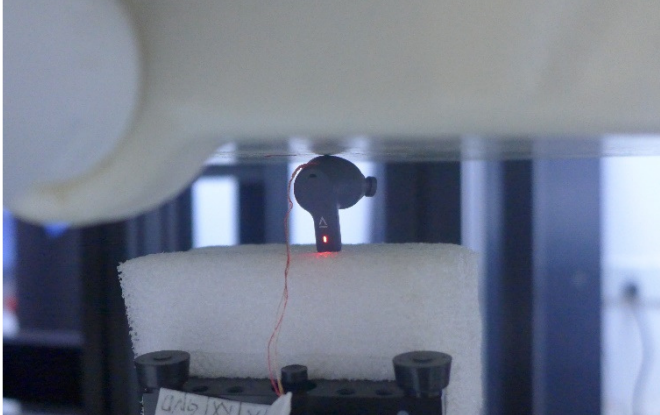
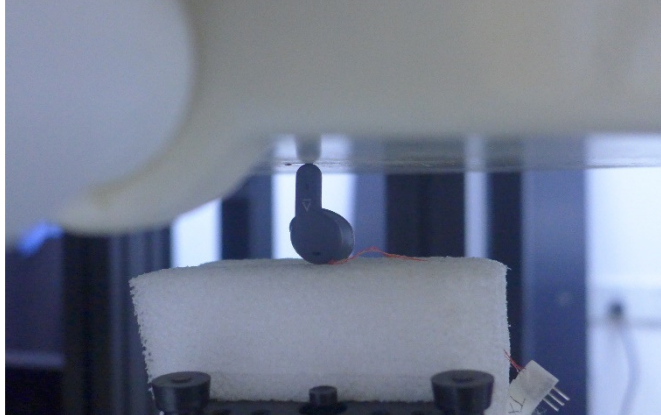
Photo 1: Tissue Simulant Liquid for HBBL600-10000MHz	NA
	NA

3. Photographs of EUT test position

Left:

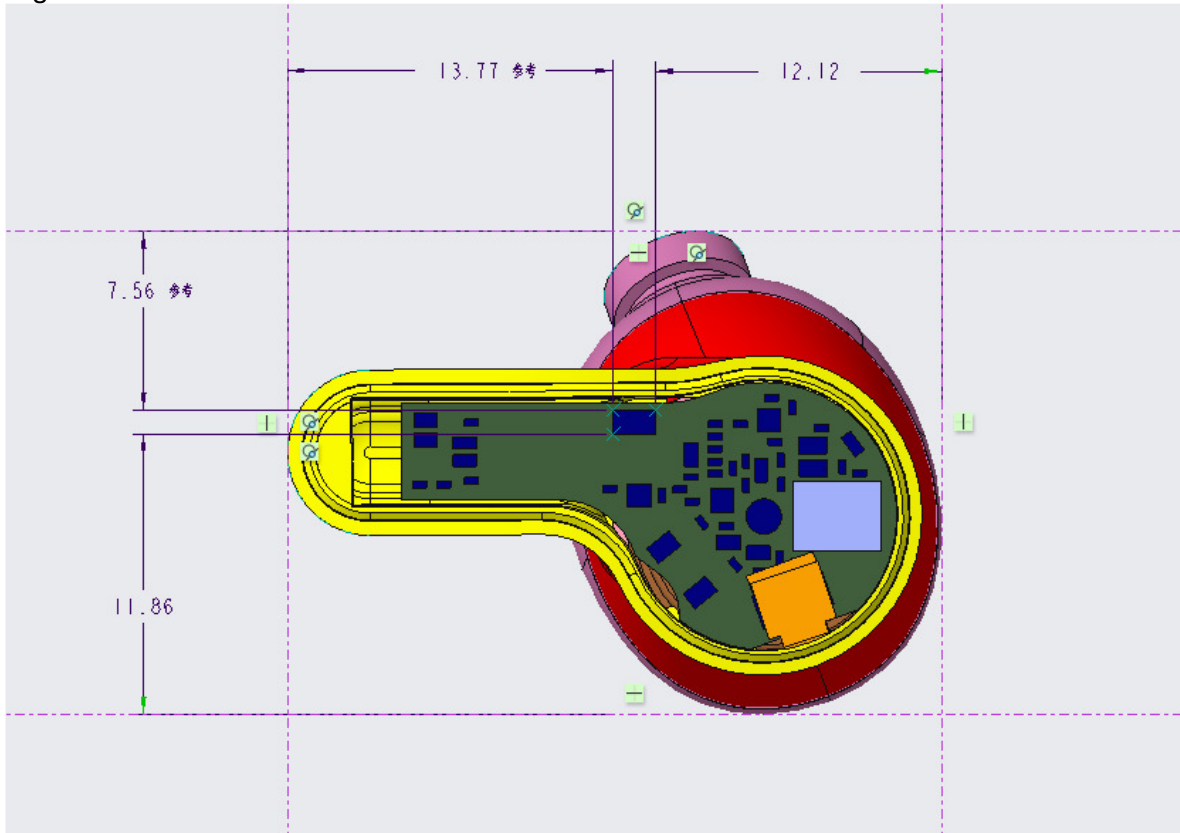
<p>Photo 2: Front side</p>	<p>Photo 3: Touch cheek</p>
	
<p>Photo 4: Left side</p>	<p>Photo 5: Right side</p>
	
<p>Photo 6: Top side</p>	<p>Photo 7: Bottom side</p>
	

Right:

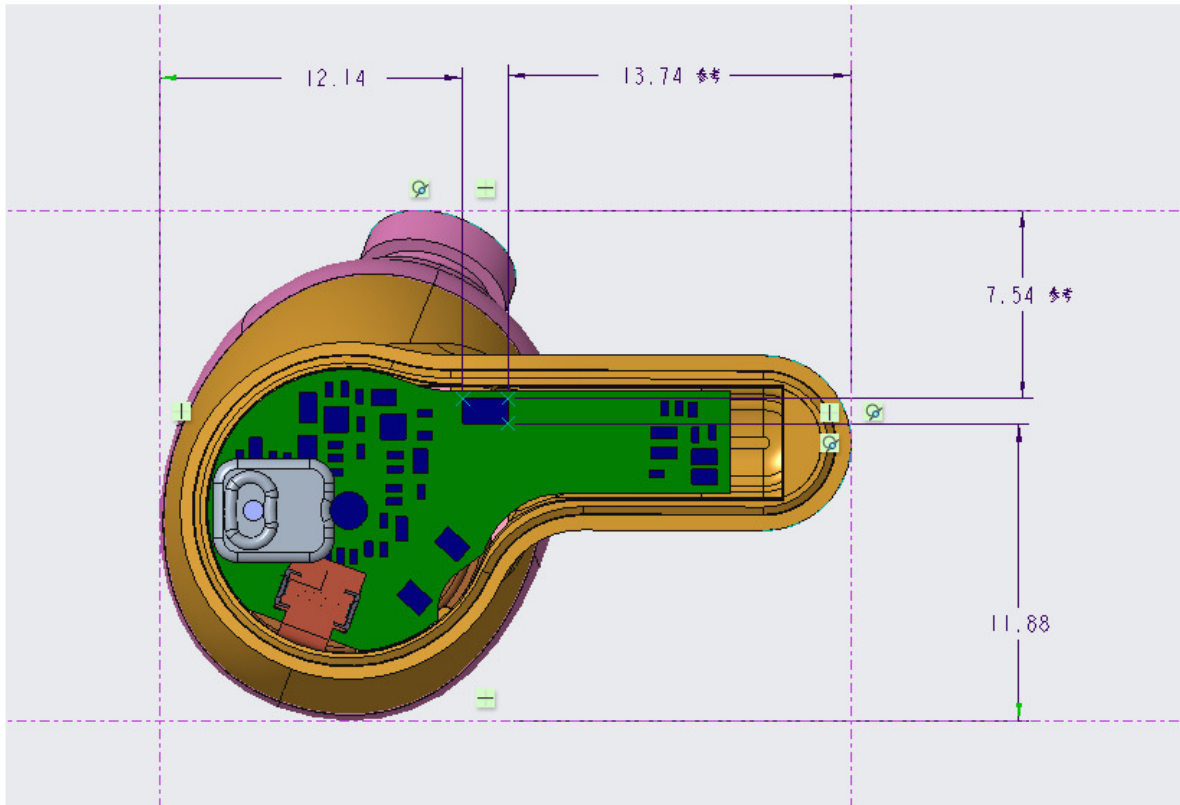
<p>Photo 8: Front side</p>	<p>Photo 9: Touch cheek</p>
	
<p>Photo 10: Left side</p>	<p>Photo 11: Right side</p>
	
<p>Photo 12: Top side</p>	<p>Photo 13: Bottom side</p>
	

4. EUT Antenna Locations

Right:



Left:



5. EUT Constructional Details

Details please Refer to Appendix – External Photo & Internal Photo for SZCR2404001183AT.

-The End-