

TEST REPORT

Applicant Name : PO FUNG ELECTRONIC (HK) INTERNATONAL GROUP COMPANY LIMITED
 Address : Room 1508, 15/F, Office Tower II, Grand Plaza, 625 Nathan Road, Kowloon, Hong Kong
 Report Number : XMTN1220817-37476E-EM-01
 FCC ID: 2AJGMH-888S

Test Standard (s)
 FCC PART 15B

Sample Description

Product Type: FRS Two Way Radio
 Model No.: H-888S
 Multiple Model: MP-888S, FR-888S, TH-888S, MX-888S
 Trade Mark: BAOFENG, POFUNG
 Date Received: 2022-08-17
 Date of Test: 2022-08-22 to 2022-08-23
 Report Date: 2022-08-25

Test Result:	Pass*
--------------	-------

* In the configuration tested, the EUT complied with the standards above.

Prepared and Checked By:

Zeki Ma

Zeki.Ma
 EMC Engineer

Approved By:

Candy Li

Candy Li
 EMC Engineer

Note: This report may contain data that are not covered by the A2LA accreditation and are marked with an asterisk "★".

Shenzhen Accurate Technology Co., Ltd. is not responsible for the authenticity of any test data provided by the applicant. Data included from the applicant that may affect test results are marked with an asterisk '*'. Customer model name, addresses, names, trademarks etc. are not considered data. This report cannot be reproduced except in full, without prior written approval of the Company. Unless otherwise stated the results shown in this test report refer only to the sample(s) tested. This report is valid only with a valid digital signature. The digital signature may be available only under the Adobe software above version 7.0.

Shenzhen Accurate Technology Co., Ltd.

1/F., Building A, Changyuan New Material Port, Science & Industry Park, Nanshan District, Shenzhen, Guangdong, P.R. China

Tel: +86 755-26503290

Fax: +86 755-26503396

Web: www.atc-lab.com

TABLE OF CONTENTS

GENERAL INFORMATION.....	3
PRODUCT DESCRIPTION FOR EQUIPMENT UNDER TEST (EUT).....	3
OBJECTIVE	3
TEST METHODOLOGY	3
MEASUREMENT UNCERTAINTY.....	4
TEST FACILITY.....	4
SYSTEM TEST CONFIGURATION.....	5
JUSTIFICATION	5
EUT EXERCISE SOFTWARE	5
SPECIAL ACCESSORIES.....	5
EQUIPMENT MODIFICATIONS	5
SUPPORT EQUIPMENT LIST AND DETAILS	5
BLOCK DIAGRAM OF RADIATED TEST SETUP.....	6
SUMMARY OF TEST RESULTS	9
TEST EQUIPMENT LIST	10
FCC §15.107 – CONDUCTED EMISSIONS	11
APPLICABLE STANDARD	11
EUT SETUP.....	11
EMI TEST RECEIVER SETUP.....	11
TEST PROCEDURE	12
FACTOR & OVER LIMIT CALCULATION.....	12
TEST DATA	12
FCC §15.109 - RADIATED EMISSIONS	17
APPLICABLE STANDARD	17
EUT SETUP.....	17
EMI TEST RECEIVER & SPECTRUM ANALYZER SETUP	18
TEST PROCEDURE	18
FACTOR & OVER LIMIT CALCULATION.....	18
TEST DATA	19

GENERAL INFORMATION

Product Description for Equipment under Test (EUT)

Product	FRS Two Way Radio
Tested Model	H-888S
Multiple Model	MP-888S, FR-888S, TH-888S, MX-888S
Model Difference	Please refer to the DOS letter.
Frequency Range	467.5625-467.7125 MHz 462.5500-462.7250 MHz
Highest Operation Frequency	467.7125 MHz (provided by the applicant.)
Voltage Range	DC 3.7V from battery DC 4.2V from Charger Base (Note: Only Charging for charger base mode.) DC 5.0V from adapter
Sample number	XMTN1220817-37476E-EM-S1 (Assigned by ATC)
Sample/EUT Status	Good condition
Adapter information	Model: A18A-050100U-US2 Input: 100-240V~50/60Hz,Max 0.2A Output: 5V=1A (The DC line length is 75cm.)
Charging Base	Model: CH-8S-USB Input: DC5V USB Output: DC4.2V==500mA (The DC line length is 90cm.)

Objective

This report is in accordance with Part 2-Subpart J, and Part 15-Subparts A and B of the Federal Communication Commission's rules.

The objective of the manufacturer is to determine the compliance of EUT with FCC Part 15, Class B device.

Test Methodology

All measurements contained in this report were conducted with ANSI C63.4-2014, American National Standard for Methods of Measurement of Radio-Noise Emissions from Low-Voltage Electrical and Electronic Equipment in the range of 9 kHz to 40 GHz.

All radiated and conducted emissions measurement was performed at Shenzhen Accurate Technology Co., Ltd. The radiated testing was performed at an antenna-to-EUT distance of 3 meters.

Measurement Uncertainty

Parameter		Uncertainty
AC Power Lines Conducted Emissions		2.72dB
Emissions, Radiated	9kHz - 30MHz	2.66dB
	30MHz - 1GHz	4.28dB
	1GHz - 18GHz	4.98dB
Temperature		1°C
Humidity		6%
Supply voltages		0.4%

Note: The extended uncertainty given in this report is obtained by combining the standard uncertainty times the coverage factor K with the 95% confidence interval. Otherwise required by the applicant or Product Regulations, Decision Rule in this report did not consider the uncertainty.

Test Facility

The test site used by Shenzhen Accurate Technology Co., Ltd. to collect test data is located on the 1/F., Building A, Changyuan New Material Port, Science & Industry Park, Nanshan District, Shenzhen, Guangdong, P.R. China.

The test site has been approved by the FCC under the KDB 974614 D01 and is listed in the FCC Public Access Link (PAL) database, FCC Registration No.: 708358, the FCC Designation No.: CN1189.

Accredited by American Association for Laboratory Accreditation (A2LA). The Certificate Number is 4297.01

The lab has been recognized by Innovation, Science and Economic Development Canada to test to Canadian radio equipment requirements, the CAB identifier: CN0016. The Registration Number is 5077A.

SYSTEM TEST CONFIGURATION

Justification

The system was configured for testing in a typical fashion (as normally used by a typical user).

Test mode 1: Charging for charger base (The EUT Switch OFF)

Test mode 2: Charging for adapter (The EUT Switch OFF)

Test mode 3: Receiver at 462.6375MHz

Test mode 4: Receiver at 467.6375MHz

EUT Exercise Software

No exercise software.

Special Accessories

No special accessory was used.

Equipment Modifications

No modification was made to the EUT tested.

Support Equipment List and Details

Manufacturer	Description	Model	Serial Number
Unknown	Earphone	Unknown	Unknown
AGILENT	Vector Signal Generator	N5182A	MY50143401

External I/O Cable

Cable Description	Length (m)	From Port	To Port
Audio Cable	1.40	EUT	Earphone
Unshielded un-detachable DC cable	0.75	EUT	adapter
Unshielded un-detachable DC cable	0.90	Charger Base	Receptacle
Unshielded un-detachable AC cable	0.80	Receptacle	LISN

Block Diagram of Radiated Test Setup

For Conducted Emission:

Test mode 1:

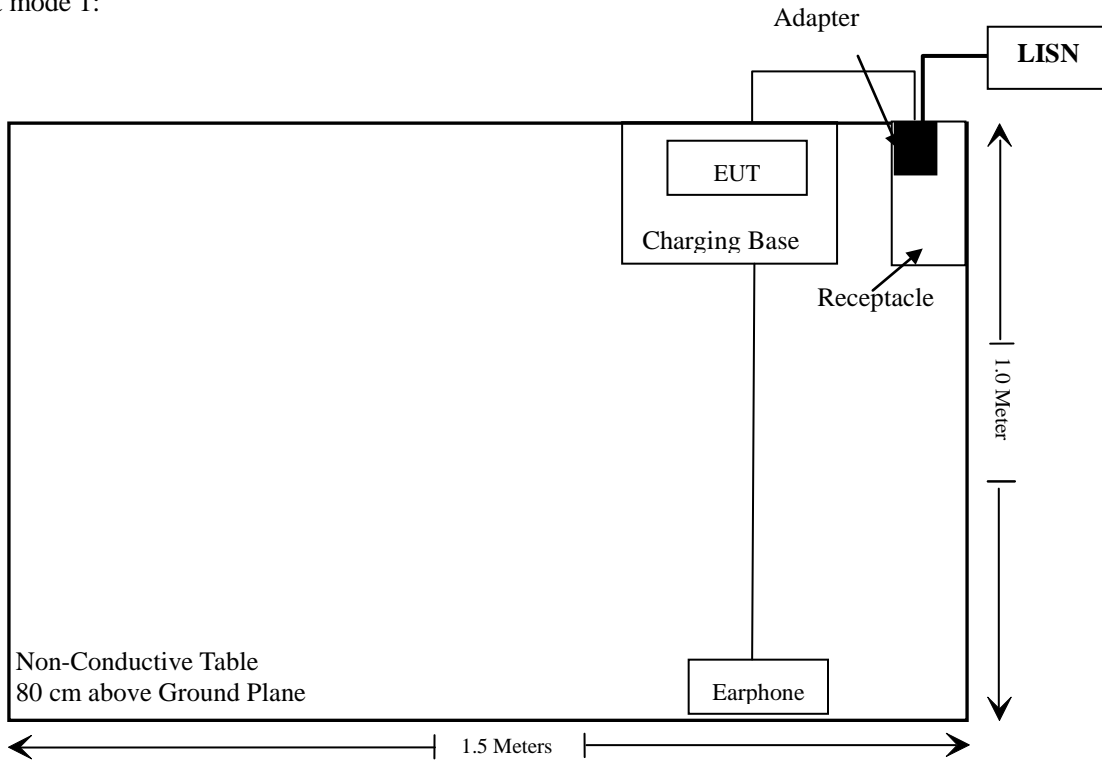

Test mode 2:

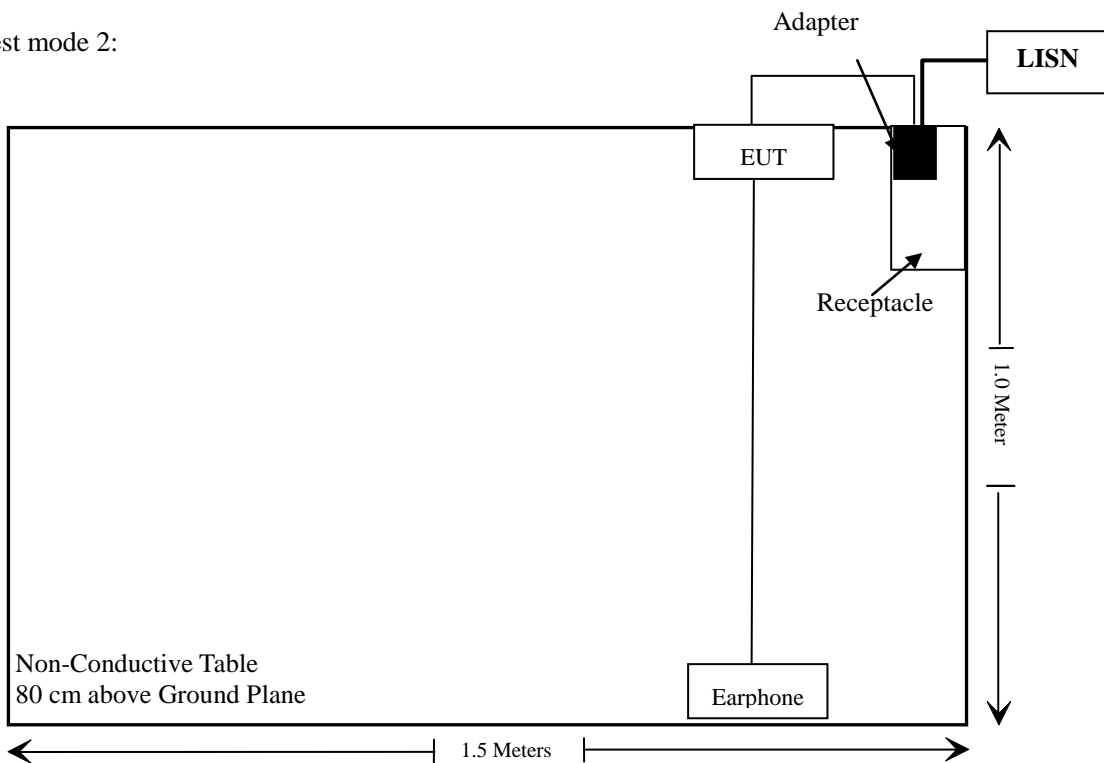

For Radiated Emission:

Test mode 1:

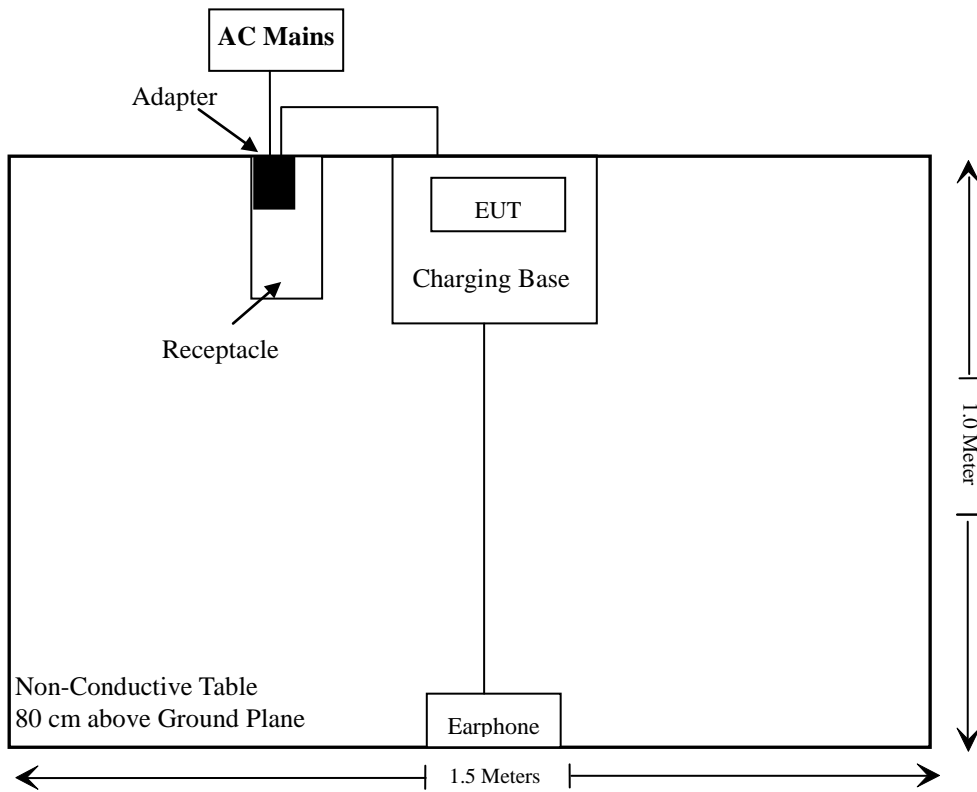

Test mode 2:

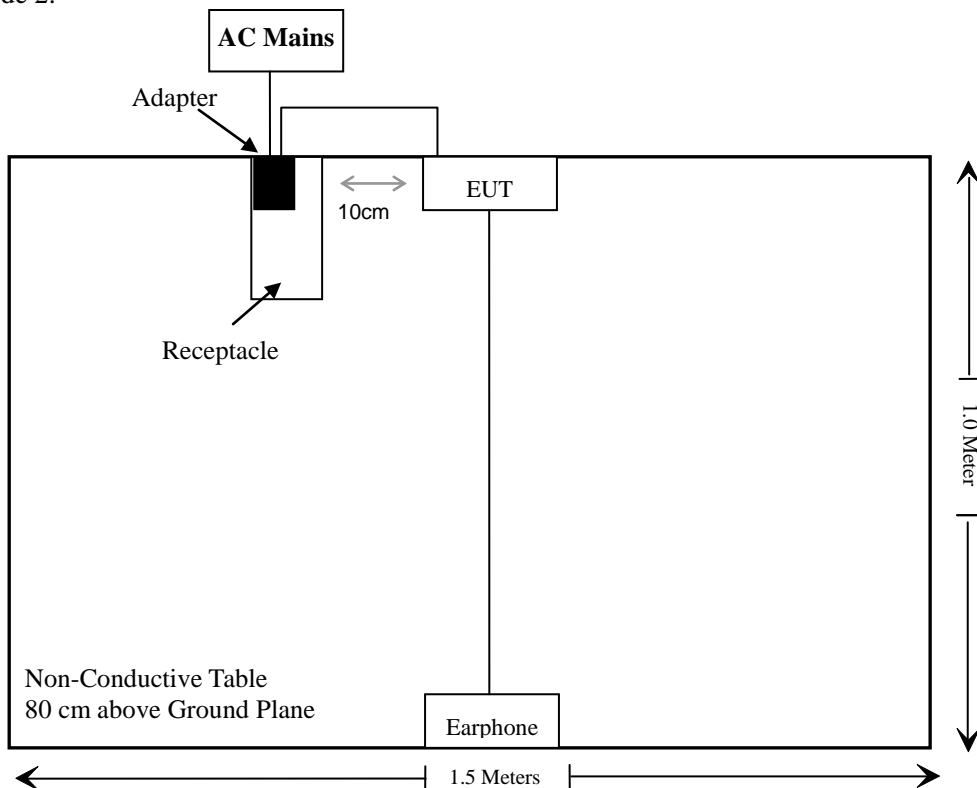

Test mode 3&4:

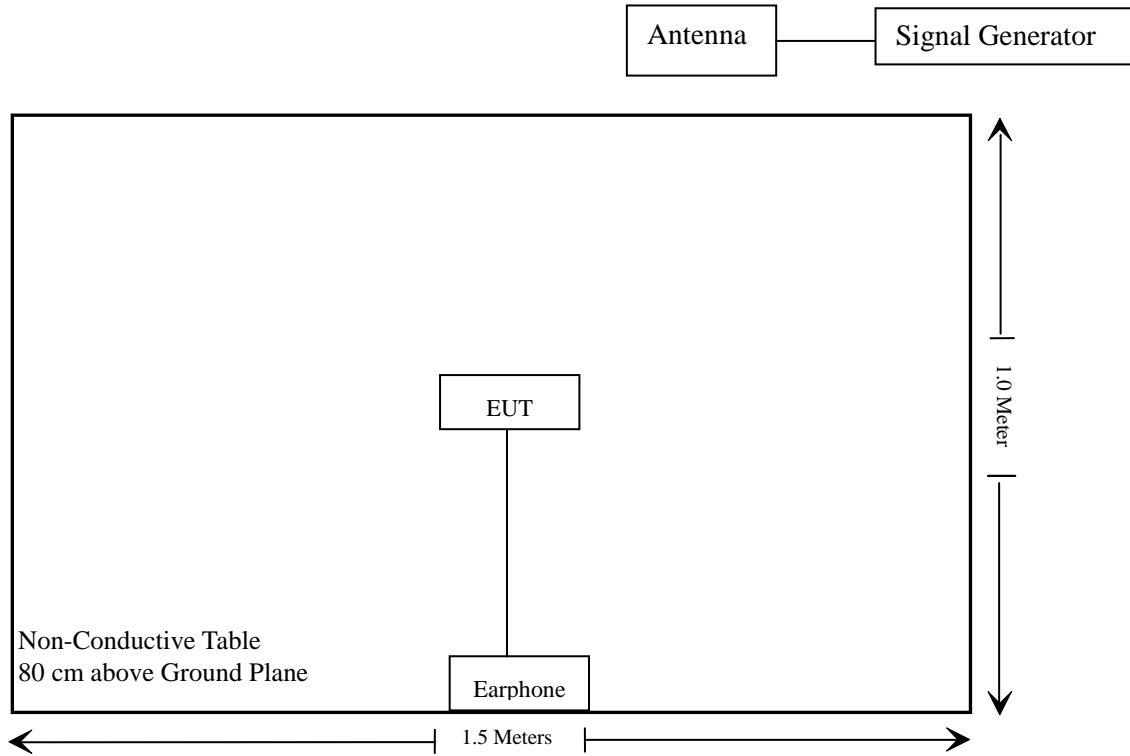

SUMMARY OF TEST RESULTS

FCC Rules	Description of Test	Results
§15.107	Conducted Emissions	Compliant
§15.109	Radiated Emissions	Compliant

TEST EQUIPMENT LIST

Manufacturer	Description	Model	Serial Number	Calibration Date	Calibration Due Date
Conducted Emission Test					
Rohde & Schwarz	EMI Test Receiver	ESCI	100784	2021/12/13	2022/12/12
Rohde & Schwarz	L.I.S.N.	ENV216	101314	2021/12/13	2022/12/12
Anritsu Corp	50 Coaxial Switch	MP59B	6100237248	2021/12/13	2022/12/12
Unknown	RF Coaxial Cable	No.17	N0350	2021/12/14	2022/12/13
Conducted Emission Test Software: e3 19821b (V9)					
Radiated Emissions Test					
Rohde & Schwarz	Test Receiver	ESR	102725	2021/12/13	2022/12/12
Rohde & Schwarz	Spectrum Analyzer	FSV40	101949	2021/12/13	2022/12/12
A.H. Systems, inc.	Preamplifier	PAM-0118P	135	2021/11/09	2022/11/08
SONOMA INSTRUMENT	Amplifier	310 N	186131	2021/11/09	2022/11/08
Schwarzbeck	Bilog Antenna	VULB9163	9163-323	2021/07/06	2024/07/05
Schwarzbeck	Horn Antenna	BBHA9120D	9120D-1067	2020/01/05	2023/01/04
AGILENT	Vector Signal Generator	N5182A	MY50143401	2021/12/13	2022/12/12
Unknown	RF Coaxial Cable	No.10	N050	2021/12/14	2022/12/13
Unknown	RF Coaxial Cable	No.11	N1000	2021/12/14	2022/12/13
Unknown	RF Coaxial Cable	No.12	N040	2021/12/14	2022/12/13
Unknown	RF Coaxial Cable	No.13	N300	2021/12/14	2022/12/13
Unknown	RF Coaxial Cable	No.14	N800	2021/12/14	2022/12/13
Radiated Emission Test Software: e3 19821b(V9)					

* **Statement of Traceability:** Shenzhen Accurate Technology Co., Ltd. attests that all calibrations have been performed in accordance to requirements that traceable to National Primary Standards and International System of Units (SI).

FCC §15.107 – CONDUCTED EMISSIONS

Applicable Standard

According to FCC§15.107

EUT Setup

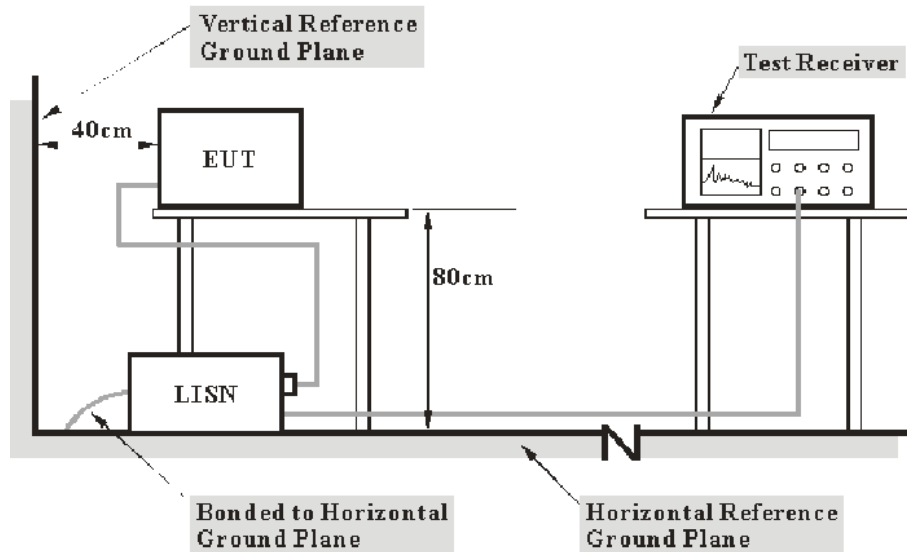

- Note: 1. Support units were connected to second LISN.
 2. Both of LISNs (AMN) 80 cm from EUT and at the least 80 cm from other units and other metal planes support units.

The measurement procedure of EUT setup is according with ANSI C63.4-2014. The related limit was specified in FCC Part 15.107 Class B.

The external I/O cables were draped along the test table and formed a bundle 30 to 40 cm long in the middle.

The spacing between the peripherals was 10 cm.

EMI Test Receiver Setup

The EMI test receiver was set to investigate the spectrum from 150 kHz to 30 MHz.

During the conducted emission test, the EMI test receiver was set with the following configurations:

Frequency Range	IF B/W
150 kHz – 30 MHz	9 kHz

Test Procedure

Maximizing procedure was performed on the six (6) highest emissions of the EUT.

All final data was recorded in the Quasi-peak and average detection mode.

Factor & Over Limit Calculation

The factor is calculated by adding LISN VDF (Voltage Division Factor) and Cable Loss. The basic equation is as follows:

$$\text{Factor} = \text{LISN VDF} + \text{Cable Loss}$$

The “**Over limit**” column of the following data tables indicates the degree of compliance with the applicable limit. For example, an Over limit of -7 dB means the emission is 7 dB below the limit. The equation for calculation is as follows:

$$\begin{aligned}\text{Over Limit} &= \text{Level} - \text{Limit} \\ \text{Level} &= \text{Read Level} + \text{Factor}\end{aligned}$$

Test Data

Environmental Conditions

Temperature:	25 °C
Relative Humidity:	45 %
ATM Pressure:	101.0kPa

The testing was performed by Jason Liu on 2022-08-22.

Test mode 1

AC 120V/60Hz, Line:

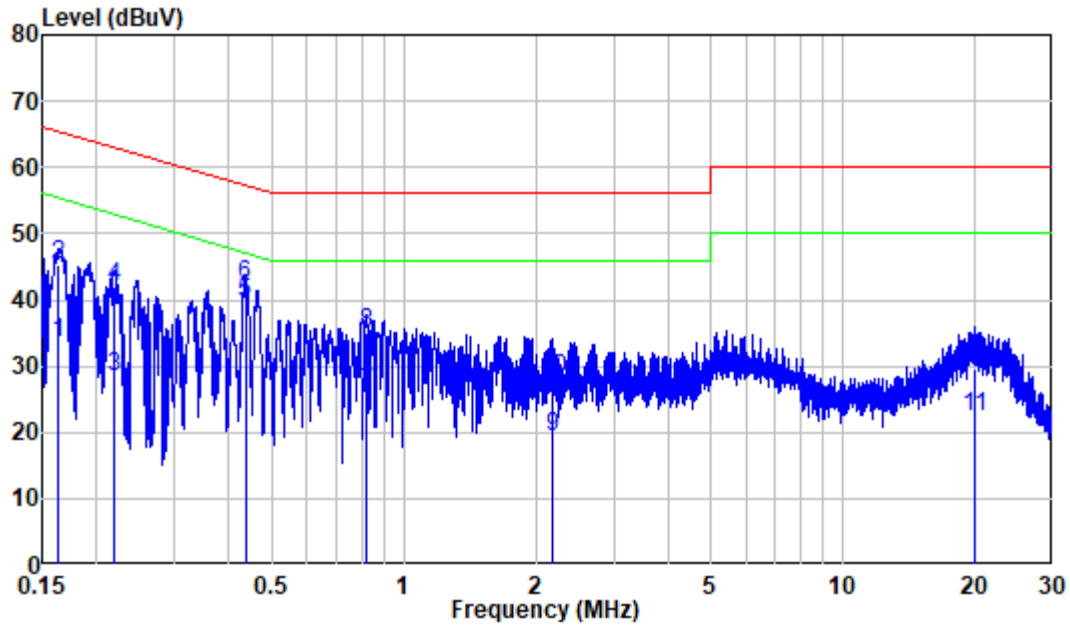

Site : Shielding Room
 Condition: Line
 Job No. : XMTN1220817-37476E-00
 Mode : Charging for charger base
 Power : AC 120V 60Hz

	Freq	Factor	Read Level	Level	Limit Line	Over Limit	Remark
	MHz	dB	dBuV	dBuV	dBuV	dB	
1	0.163	9.80	23.63	33.43	55.32	-21.89	Average
2	0.163	9.80	35.56	45.36	65.32	-19.96	QP
3	0.219	9.80	18.68	28.48	52.85	-24.37	Average
4	0.219	9.80	32.03	41.83	62.85	-21.02	QP
5	0.435	9.80	29.86	39.66	47.15	-7.49	Average
6	0.435	9.80	32.42	42.22	57.15	-14.93	QP
7	0.822	9.81	16.29	26.10	46.00	-19.90	Average
8	0.822	9.81	25.20	35.01	56.00	-20.99	QP
9	2.181	9.82	9.35	19.17	46.00	-26.83	Average
10	2.181	9.82	18.40	28.22	56.00	-27.78	QP
11	19.884	10.00	12.47	22.47	50.00	-27.53	Average
12	19.884	10.00	19.53	29.53	60.00	-30.47	QP

AC 120V/60Hz, Neutral:

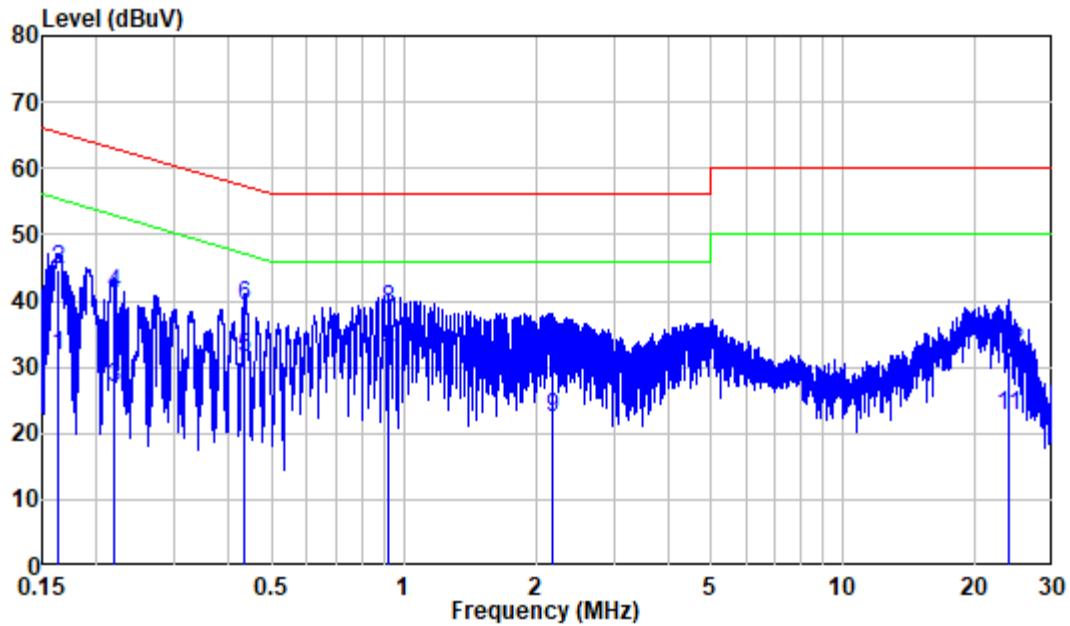

Site : Shielding Room
 Condition: Neutral
 Job No. : XMTN1220817-37476E-00
 Mode : Charging for charger base
 Power : AC 120V 60Hz

	Freq	Factor	Read Level	Limit Level	Limit Line	Over Limit	Remark
	MHz	dB	dBuV	dBuV	dBuV	dB	
1	0.162	9.80	21.79	31.59	55.34	-23.75	Average
2	0.162	9.80	34.74	44.54	65.34	-20.80	QP
3	0.219	9.80	17.19	26.99	52.86	-25.87	Average
4	0.219	9.80	31.21	41.01	62.86	-21.85	QP
5	0.434	9.80	21.66	31.46	47.18	-15.72	Average
6	0.434	9.80	29.41	39.21	57.18	-17.97	QP
7	0.925	9.81	20.72	30.53	46.00	-15.47	Average
8	0.925	9.81	28.83	38.64	56.00	-17.36	QP
9	2.180	9.82	12.52	22.34	46.00	-23.66	Average
10	2.180	9.82	21.55	31.37	56.00	-24.63	QP
11	23.825	10.14	12.52	22.66	50.00	-27.34	Average
12	23.825	10.14	22.28	32.42	60.00	-27.58	QP

Test mode 2

AC 120V/60Hz, Line:

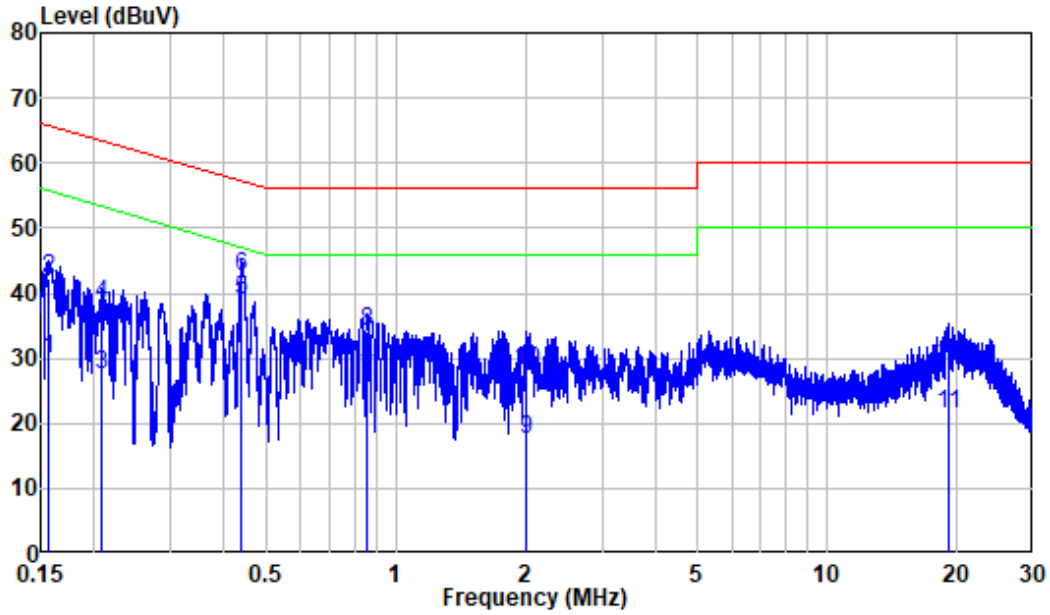

Site : Shielding Room
 Condition: Line
 Job No. : XMTN1220817-37476E-00
 Mode : Charging for adapter
 Power : AC 120V 60Hz

	Freq	Factor	Read Level	Level	Limit Line	Over Limit	Remark
	MHz	dB	dBuV	dBuV	dBuV	dB	
1	0.157	9.80	20.01	29.81	55.63	-25.82	Average
2	0.157	9.80	32.60	42.40	65.63	-23.23	QP
3	0.208	9.80	17.71	27.51	53.28	-25.77	Average
4	0.208	9.80	28.52	38.32	63.28	-24.96	QP
5	0.439	9.80	29.26	39.06	47.09	-8.03	Average
6	0.439	9.80	32.85	42.65	57.09	-14.44	QP
7	0.857	9.81	17.03	26.84	46.00	-19.16	Average
8	0.857	9.81	24.33	34.14	56.00	-21.86	QP
9	2.005	9.82	7.76	17.58	46.00	-28.42	Average
10	2.005	9.82	18.29	28.11	56.00	-27.89	QP
11	19.109	9.99	11.49	21.48	50.00	-28.52	Average
12	19.109	9.99	19.12	29.11	60.00	-30.89	QP

AC 120V/60Hz, Neutral:

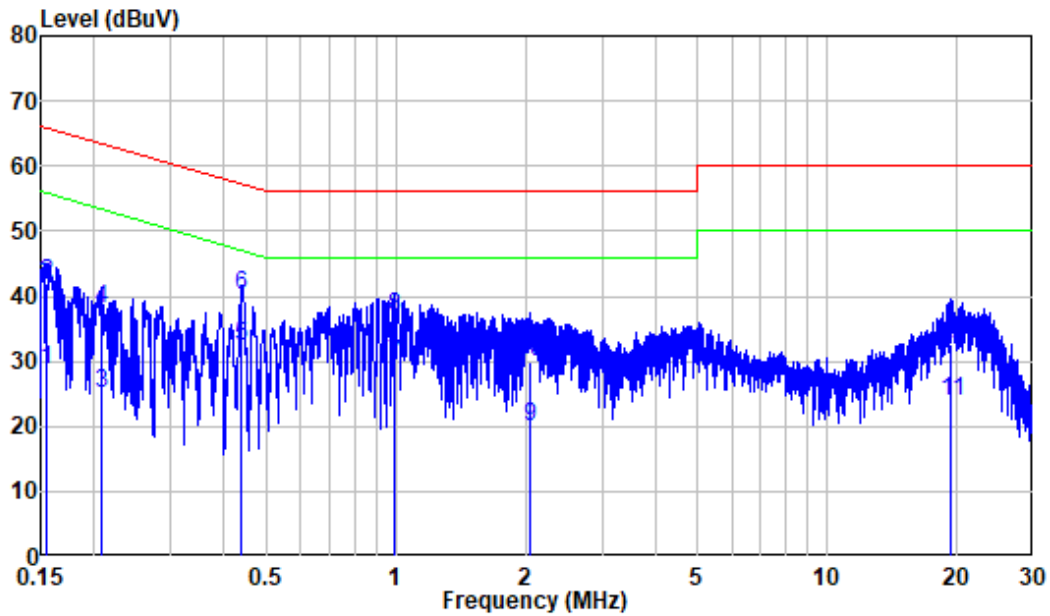

Site : Shielding Room
 Condition: Neutral
 Job No. : XMTN1220817-37476E-00
 Mode : Charging for adapter
 Power : AC 120V 60Hz

	Freq	Factor	Read Level	Level	Limit Line	Over Limit	Remark
	MHz	dB	dBuV	dBuV	dBuV	dB	
1	0.154	9.80	18.74	28.54	55.76	-27.22	Average
2	0.154	9.80	32.29	42.09	65.76	-23.67	QP
3	0.208	9.80	15.12	24.92	53.29	-28.37	Average
4	0.208	9.80	28.27	38.07	63.29	-25.22	QP
5	0.439	9.80	22.63	32.43	47.07	-14.64	Average
6	0.439	9.80	30.26	40.06	57.07	-17.01	QP
7	0.988	9.81	19.89	29.70	46.00	-16.30	Average
8	0.988	9.81	27.16	36.97	56.00	-19.03	QP
9	2.036	9.82	9.98	19.80	46.00	-26.20	Average
10	2.036	9.82	20.06	29.88	56.00	-26.12	QP
11	19.351	10.09	13.73	23.82	50.00	-26.18	Average
12	19.351	10.09	22.43	32.52	60.00	-27.48	QP

FCC §15.109 - RADIATED EMISSIONS

Applicable Standard

FCC §15.109

EUT Setup

Below 1GHz:

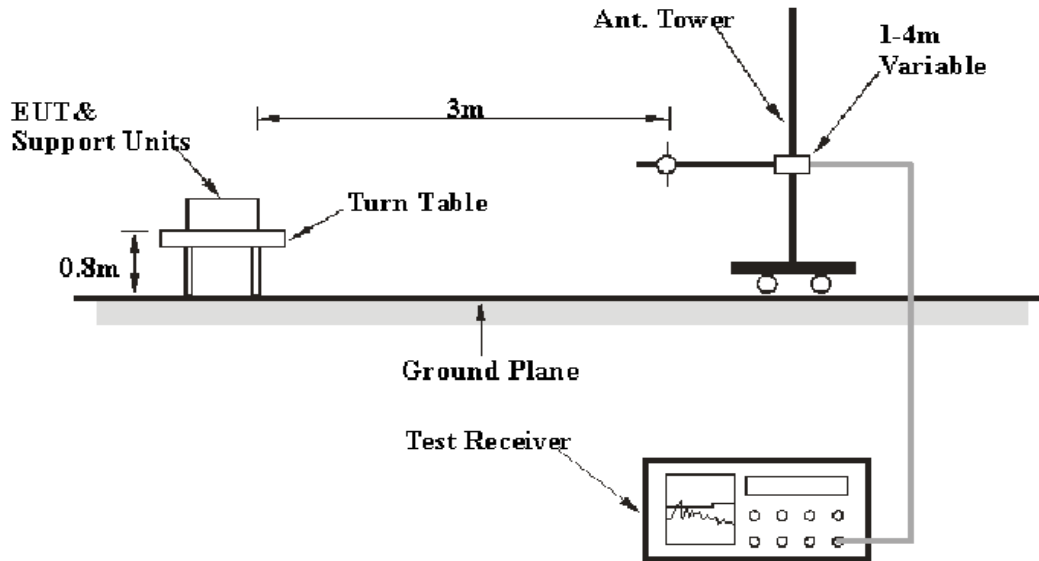

Above 1GHz:

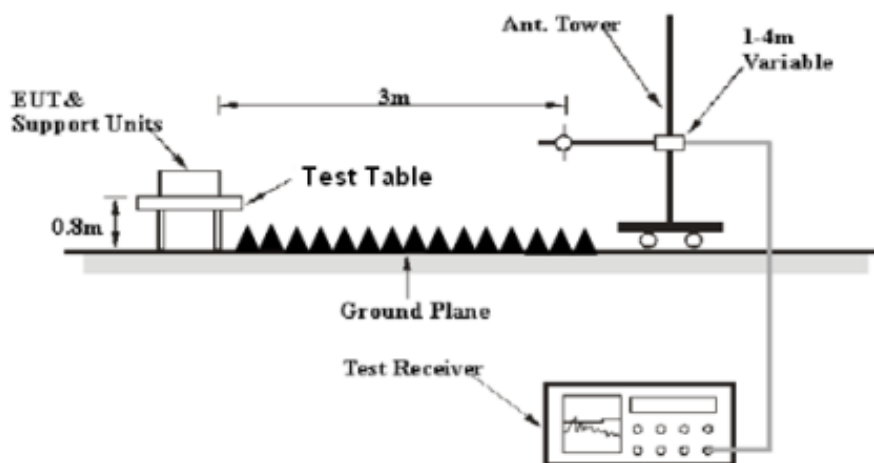

The radiated emission tests were performed in the 3 meters chamber test site, using the setup accordance with the ANSI C63.4-2014. The specification used was the FCC Part 15.109 Class B limits.

The external I/O cables were draped along the test table and formed a bundle 30 to 40 cm long in the middle.

The spacing between the peripherals was 10 cm.

EMI Test Receiver & Spectrum Analyzer Setup

The system was investigated from 30 MHz to 5 GHz.

During the radiated emission test, the EMI test receiver & Spectrum Analyzer Setup were set with the following configurations:

Frequency Range	RBW	Video B/W	IF B/W	Detector
30MHz – 1000 MHz	120 kHz	300 kHz	120kHz	QP
Above 1 GHz	1MHz	3 MHz	/	Peak
	1MHz	10Hz	/	AV

All data was recorded in the Quasi-peak detector mode from 30 MHz to 1 GHz, Peak and average detection mode above 1 GHz.

If the maximized peak measured value complies with the limit, then it is unnecessary to perform QP/Average measurement.

Test Procedure

Maximizing procedure was performed on the highest emissions to ensure that the EUT complied with all installation combinations.

Factor & Over Limit Calculation

The Factor is calculated by adding the Antenna Factor and Cable Loss, and subtracting the Amplifier Gain from the Meter Reading. The basic equation is as follows:

$$\text{Factor} = \text{Antenna Factor} + \text{Cable Loss} - \text{Amplifier Gain}$$

The “**Over Limit**” column of the following data tables indicates the degree of compliance with the applicable limit. For example, a margin of -7dB means the emission is 7dB below the limit. The equation for margin calculation is as follows:

$$\begin{aligned} \text{Over Limit} &= \text{Level} - \text{Limit} \\ \text{Level} &= \text{Reading} + \text{Factor} \end{aligned}$$

Test Data**Environmental Conditions**

Temperature:	28°C
Relative Humidity:	59 %
ATM Pressure:	101.0 kPa

The testing was performed by Level Lion 2022-08-23.

Note: Pre-scan in the X, Y and Z axes of orientation, the worst case Y-axis of orientation was recorded.

30MHz-1GHz:

Test mode 1: Charging for charger base

Horizontal:

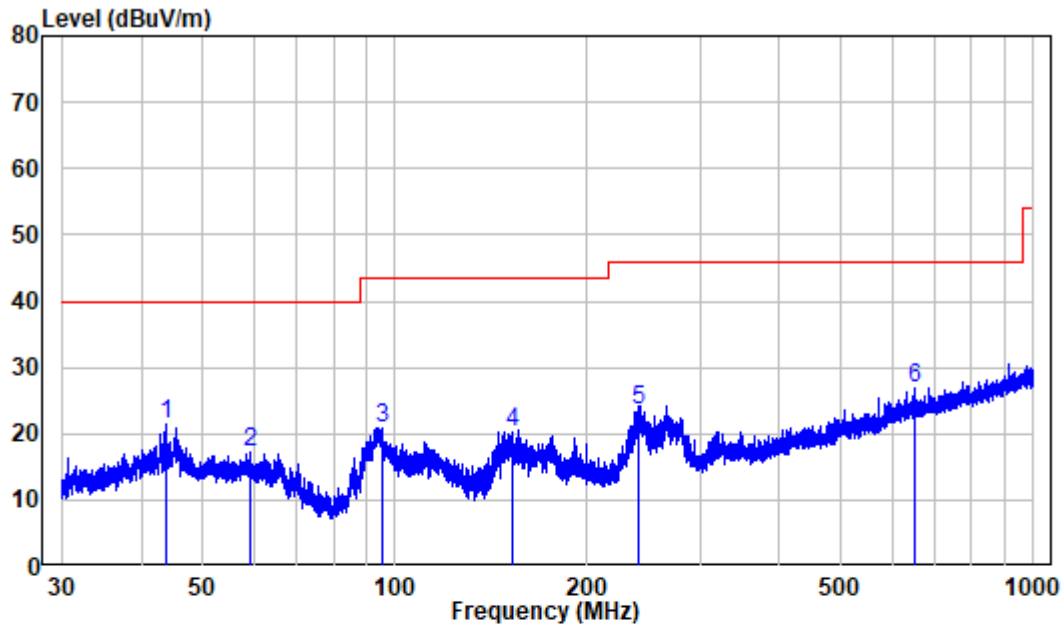

Site : chamber
 Condition: 3m HORIZONTAL
 Job No. : XMTN1220817-37476E-EM
 Test Mode: Charging for charger base

	Freq	Factor	Read Level	Level	Limit Line	Over Limit	Remark
	MHz	dB/m	dBuV	dBuV/m	dBuV/m	dB	
1	43.793	-9.91	31.37	21.46	40.00	-18.54	Peak
2	59.388	-10.40	27.65	17.25	40.00	-22.75	Peak
3	95.427	-12.40	33.32	20.92	43.50	-22.58	Peak
4	152.330	-15.14	35.44	20.30	43.50	-23.20	Peak
5	239.882	-10.91	34.56	23.65	46.00	-22.35	Peak
6	651.942	-1.67	28.41	26.74	46.00	-19.26	Peak

Vertical

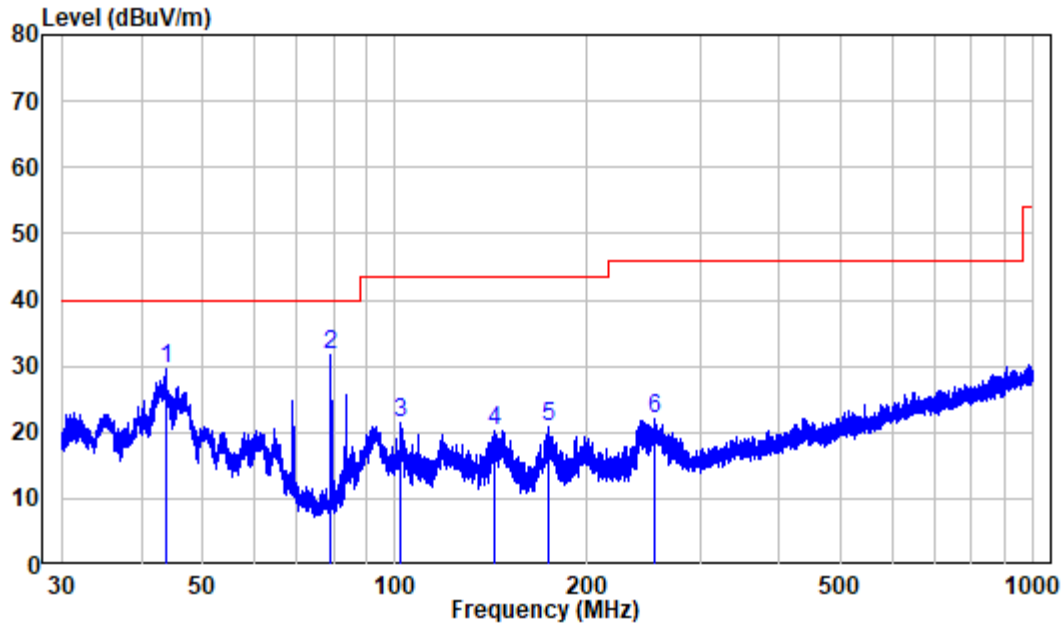

Site : chamber
 Condition: 3m VERTICAL
 Job No. : XMTN1220817-37476E-EM
 Test Mode: Charging for charger base

	Freq	Factor	Read Level	Level	Limit	Over	Remark
	MHz	dB/m	dBuV	dBuV/m	dBuV/m	dB	
1	43.774	-9.91	39.42	29.51	40.00	-10.49	Peak
2	79.277	-16.73	48.31	31.58	40.00	-8.42	Peak
3	101.823	-11.59	33.14	21.55	43.50	-21.95	Peak
4	142.637	-15.52	35.83	20.31	43.50	-23.19	Peak
5	174.271	-13.17	34.11	20.94	43.50	-22.56	Peak
6	255.735	-10.61	32.62	22.01	46.00	-23.99	Peak

Test mode 2: Charging for adapter

Horizontal:

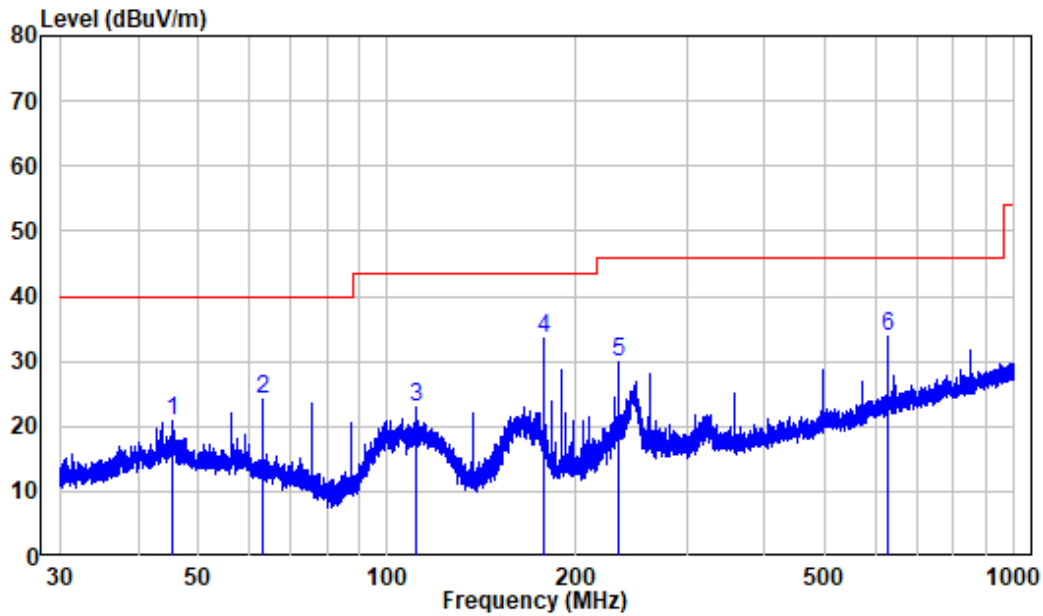

Site : chamber
 Condition: 3m HORIZONTAL
 Job No. : XMTN1220817-37476E-EM
 Test Mode: Charging for adapter

	Freq	Factor	Read Level	Limit Level	Limit Line	Over Limit	Remark
	MHz	dB/m	dBuV	dBuV/m	dBuV/m	dB	
1	45.256	-9.95	30.81	20.86	40.00	-19.14	Peak
2	63.202	-11.86	36.09	24.23	40.00	-15.77	Peak
3	111.103	-12.12	35.00	22.88	43.50	-20.62	Peak
4	177.121	-13.01	46.67	33.66	43.50	-9.84	Peak
5	234.374	-10.99	40.92	29.93	46.00	-16.07	Peak
6	626.724	-2.26	35.97	33.71	46.00	-12.29	Peak

Vertical

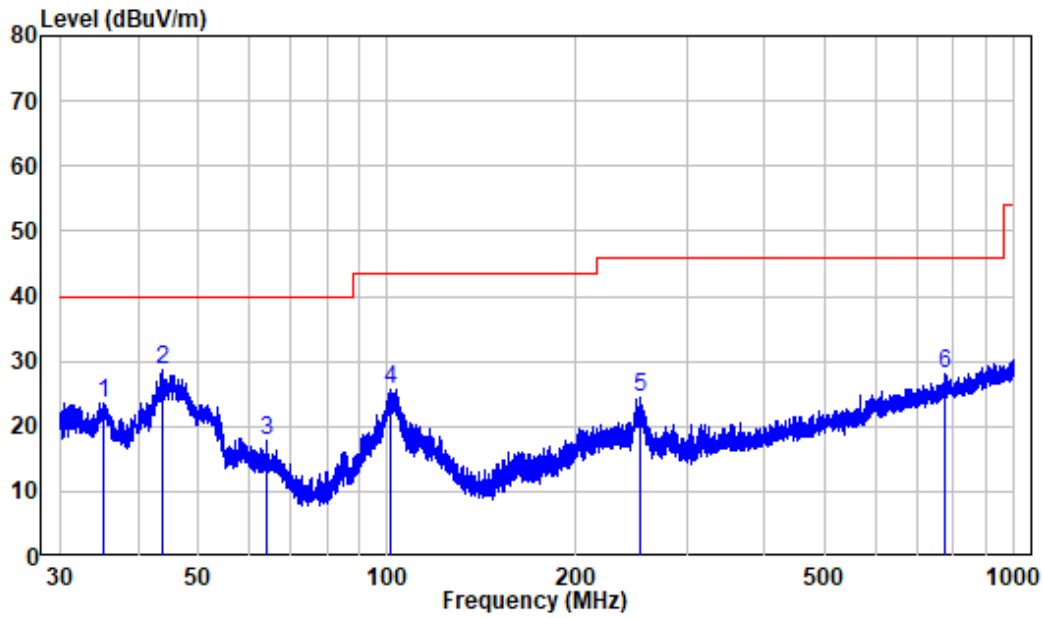

Site : chamber
 Condition: 3m VERTICAL
 Job No. : XMTN1220817-37476E-EM
 Test Mode: Charging for adapter

	Read	Limit	Over			
Freq	Factor	Level	Level	Line	Limit	Remark
MHz	dB/m	dBuV	dBuV/m	dBuV/m	dB	
1	35.236	-11.46	35.13	23.67	40.00	-16.33 Peak
2	43.793	-9.91	38.50	28.59	40.00	-11.41 Peak
3	63.983	-12.14	29.81	17.67	40.00	-22.33 Peak
4	101.466	-11.63	37.44	25.81	43.50	-17.69 Peak
5	253.281	-10.65	35.02	24.37	46.00	-21.63 Peak
6	775.177	0.05	28.11	28.16	46.00	-17.84 Peak

Test mode 3: Receiver at 462.6375MHz

Horizontal:

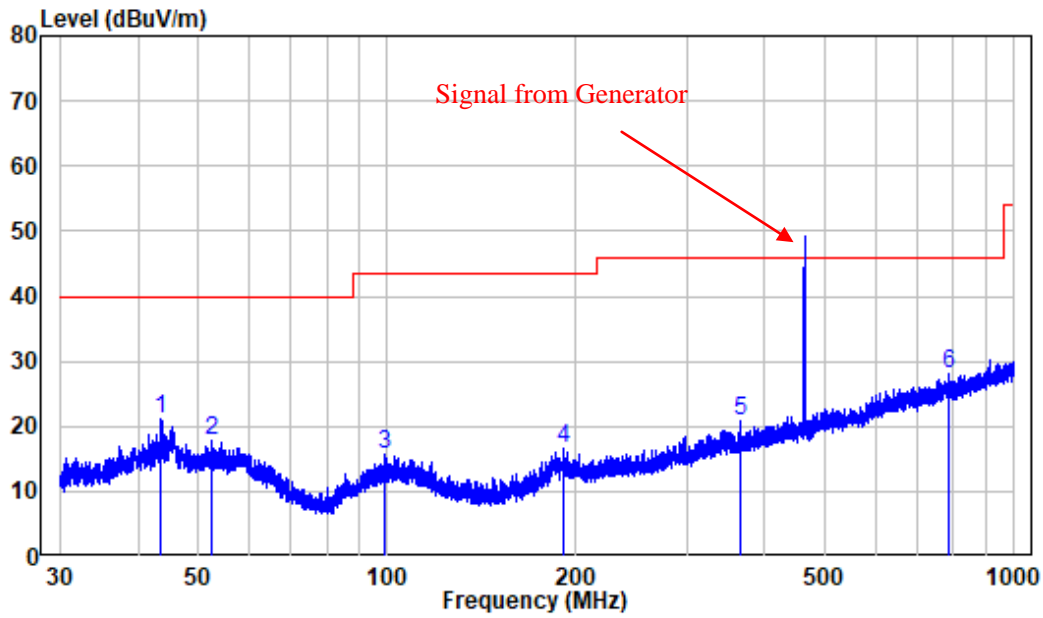

Site : chamber
 Condition: 3m HORIZONTAL
 Job No. : XMTN1220817-37476E-EM
 Test Mode: Receiver at 462.6375MHz

	Freq	Factor	Read Level	Limit Level	Limit Line	Over Limit	Remark
	MHz	dB/m	dBuV	dBuV/m	dBuV/m	dB	
1	43.468	-9.93	31.07	21.14	40.00	-18.86	Peak
2	52.322	-10.03	27.87	17.84	40.00	-22.16	Peak
3	99.310	-11.96	27.67	15.71	43.50	-27.79	Peak
4	191.409	-11.35	28.01	16.66	43.50	-26.84	Peak
5	366.181	-7.49	28.20	20.71	46.00	-25.29	Peak
6	788.542	-0.11	28.31	28.20	46.00	-17.80	Peak

Vertical

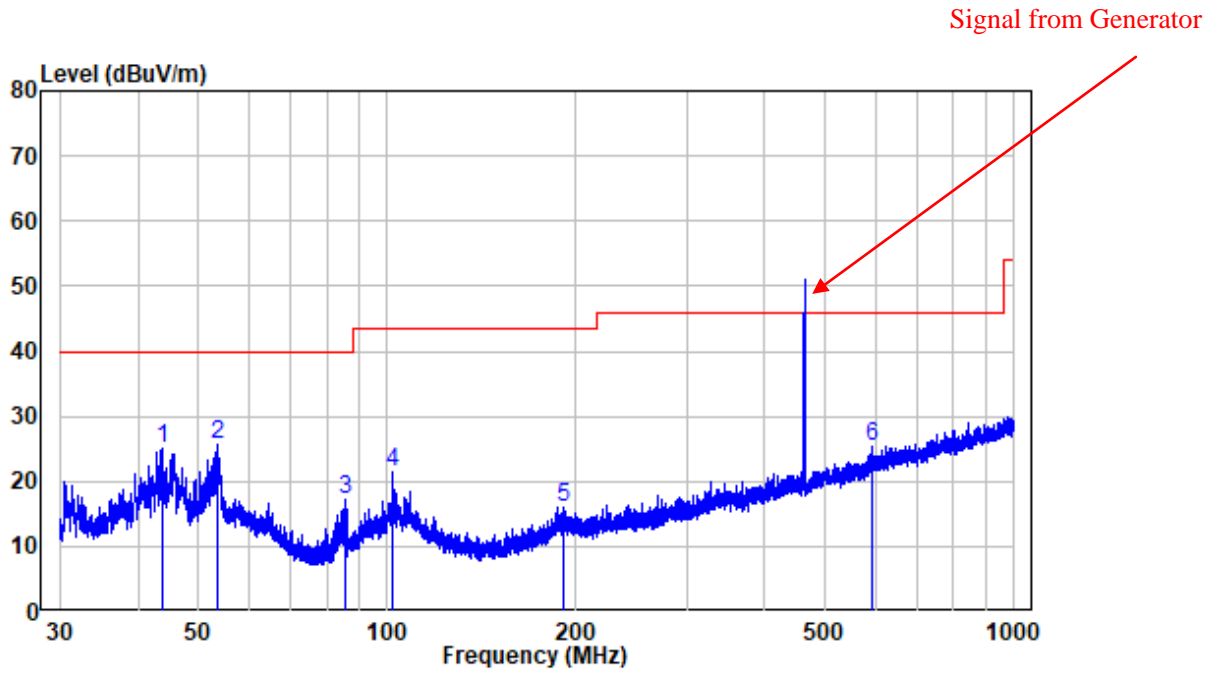

Site : chamber
 Condition: 3m VERTICAL
 Job No. : XMTN1220817-37476E-EM
 Test Mode: Receiver at 462.6375MHz

	Freq	Factor	Read Level	Limit Level	Limit Line	Over Limit	Remark
	MHz	dB/m	dBuV	dBuV/m	dBuV/m	dB	
1	43.793	-9.91	34.91	25.00	40.00	-15.00	Peak
2	53.435	-10.25	35.78	25.53	40.00	-14.47	Peak
3	85.861	-15.27	32.33	17.06	40.00	-22.94	Peak
4	101.867	-11.58	32.98	21.40	43.50	-22.10	Peak
5	190.990	-11.41	27.35	15.94	43.50	-27.56	Peak
6	595.133	-2.68	27.96	25.28	46.00	-20.72	Peak

Test mode 4: Receiver at 467.6375MHz

Horizontal:

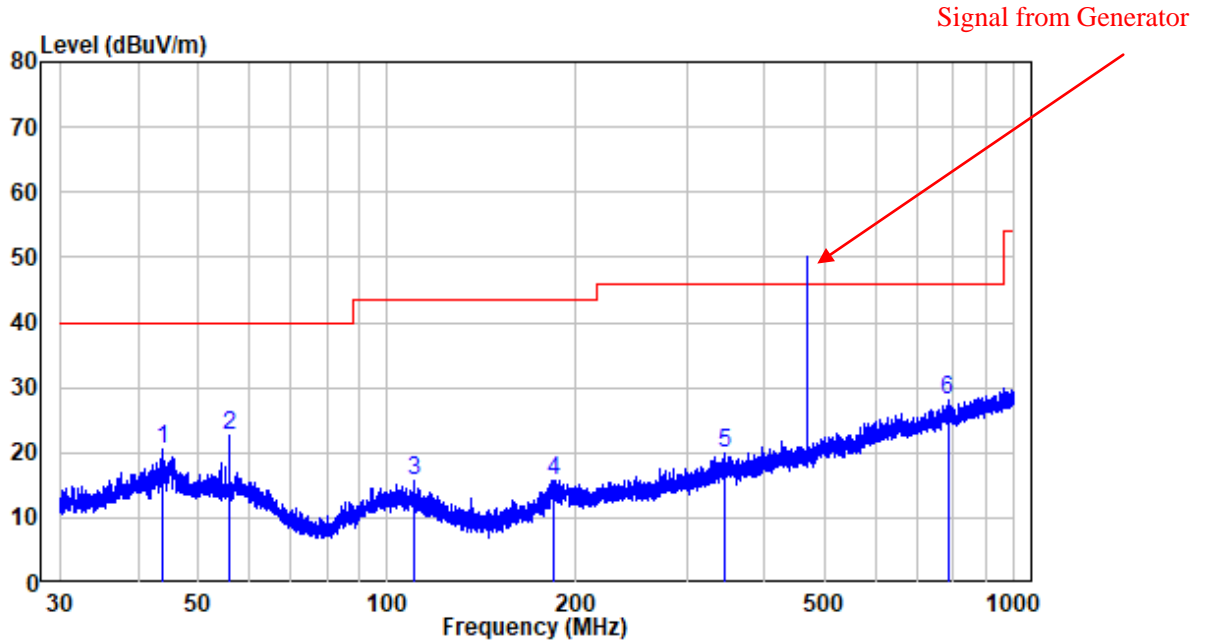

Site : chamber
 Condition: 3m HORIZONTAL
 Job No. : XMTN1220817-37476E-EM
 Test Mode: Receiver at 467.6375MHz

	Freq	Factor	Read Level	Limit Level	Over Limit	Remark
	MHz	dB/m	dBuV	dBuV/m	dBuV/m	dB
1	43.754	-9.91	30.47	20.56	40.00	-19.44 Peak
2	55.878	-10.20	32.88	22.68	40.00	-17.32 Peak
3	110.375	-12.02	27.73	15.71	43.50	-27.79 Peak
4	183.603	-12.34	28.02	15.68	43.50	-27.82 Peak
5	345.141	-7.22	27.09	19.87	46.00	-26.13 Peak
6	783.718	0.01	27.97	27.98	46.00	-18.02 Peak

Vertical

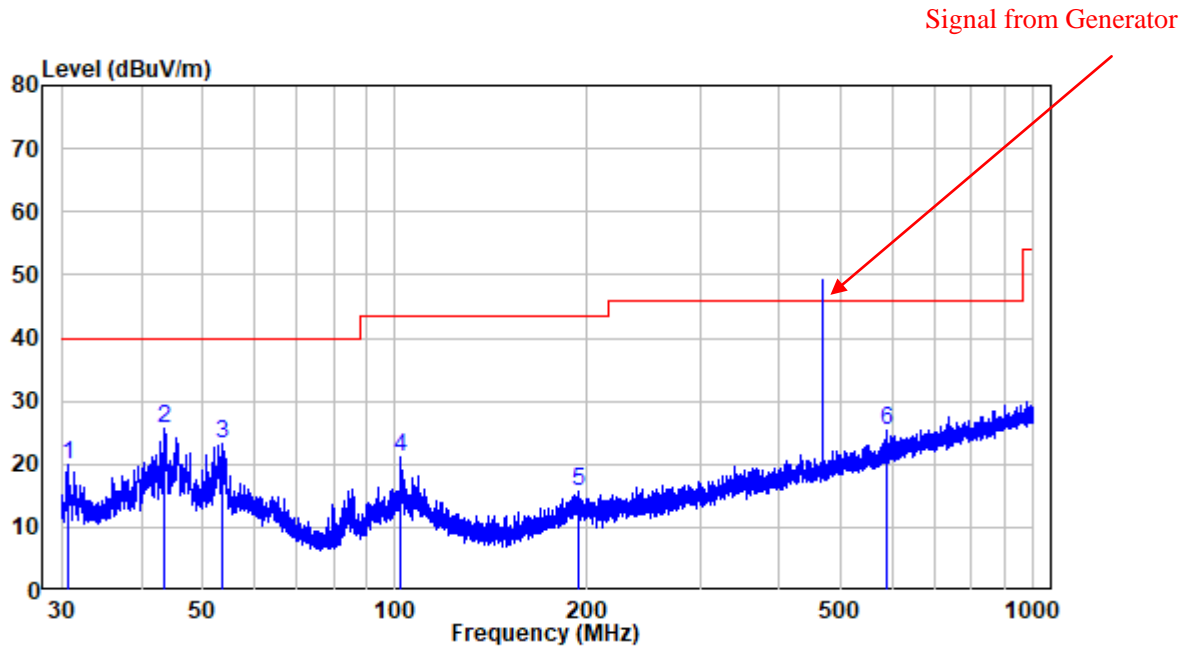

Site : chamber
 Condition: 3m VERTICAL
 Job No. : XMTN1220817-37476E-EM
 Test Mode: Receiver at 467.6375MHz

	Freq	Factor	Read Level	Limit Level	Over Line	Over Limit	Remark
	MHz	dB/m	dBuV	dBuV/m	dBuV/m	dB	
1	30.624	-12.33	32.28	19.95	40.00	-20.05	Peak
2	43.487	-9.93	35.45	25.52	40.00	-14.48	Peak
3	53.435	-10.25	33.40	23.15	40.00	-16.85	Peak
4	101.867	-11.58	32.73	21.15	43.50	-22.35	Peak
5	193.095	-11.28	26.89	15.61	43.50	-27.89	Peak
6	590.456	-2.74	28.13	25.39	46.00	-20.61	Peak

Above 1 GHz:

Test mode 1: Charging for charger base

Horizontal:

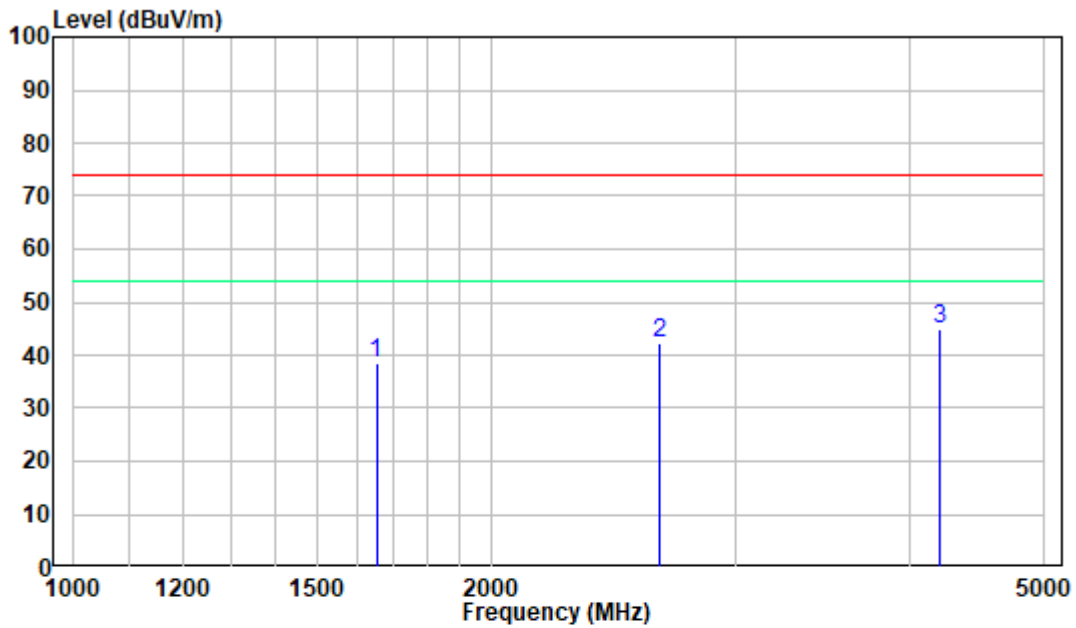

Site : chamber
 Condition: 3m Horizontal
 Job No. : XMTN1220817-37476E-EM
 Test Mode: Charging for charger base

	Freq	Factor	Read Level	Level	Limit Line	Over Limit	Remark
	MHz	dB/m	dBuV	dBuV/m	dBuV/m	dB	
1	1654.000	-9.06	47.60	38.54	74.00	-35.46	Peak
2	2645.000	-6.83	49.21	42.38	74.00	-31.62	Peak
3	4200.000	-5.07	50.07	45.00	74.00	-29.00	Peak

Vertical

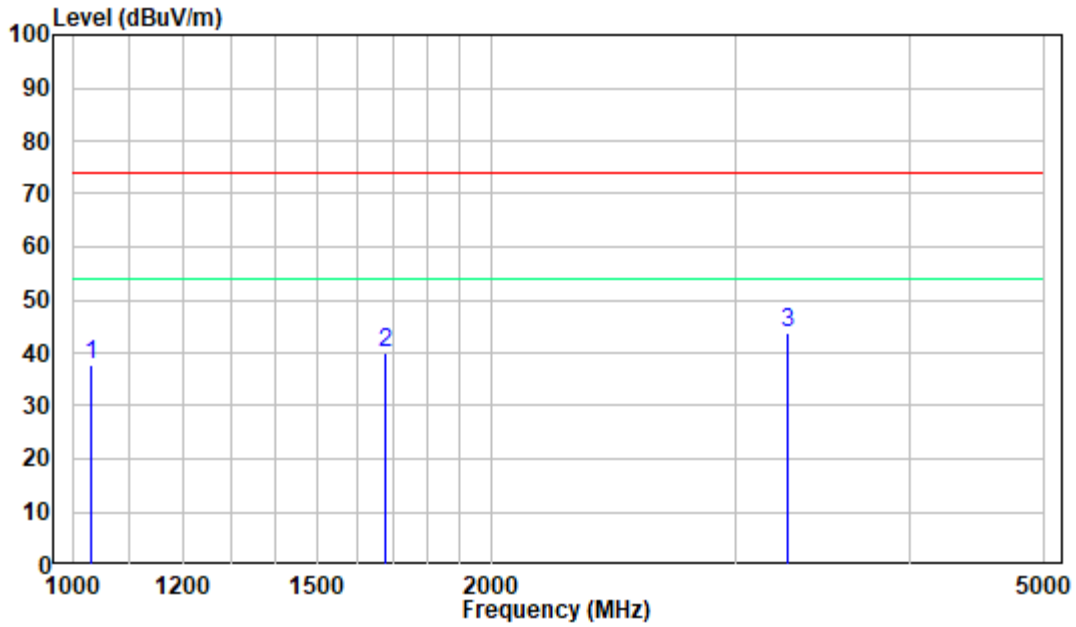

Site : chamber
 Condition: 3m VERTICAL
 Job No. : XMTN1220817-37476E-EM
 Test Mode: Charging for charger base

	Freq	Factor	Read Level	Level	Limit	Over	Remark
	MHz	dB/m	dBuV	dBuV/m	dBuV/m	dB	
1	1032.500	-10.50	48.21	37.71	74.00	-36.29	Peak
2	1681.000	-8.99	48.94	39.95	74.00	-34.05	Peak
3	3273.500	-5.96	49.59	43.63	74.00	-30.37	Peak

Test mode 2: Charging for adapter

Horizontal:

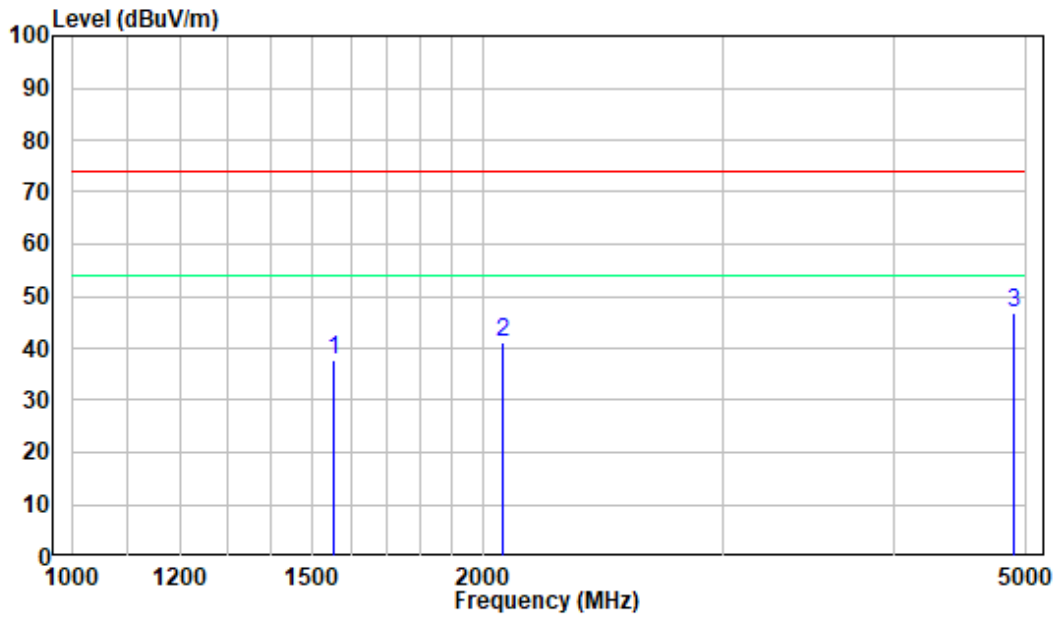

Site : chamber
 Condition: 3m Horizontal
 Job No. : XMTN1220817-37476E-EM
 Test Mode: Charging for adapter

	Freq	Factor	Read Level	Level	Limit Line	Over Limit	Remark
	MHz	dB/m	dBuV	dBuV/m	dBuV/m	dB	
1	1555.000	-9.19	47.04	37.85	74.00	-36.15	Peak
2	2071.000	-7.27	48.50	41.23	74.00	-32.77	Peak
3	4891.500	-3.33	50.28	46.95	74.00	-27.05	Peak

Vertical

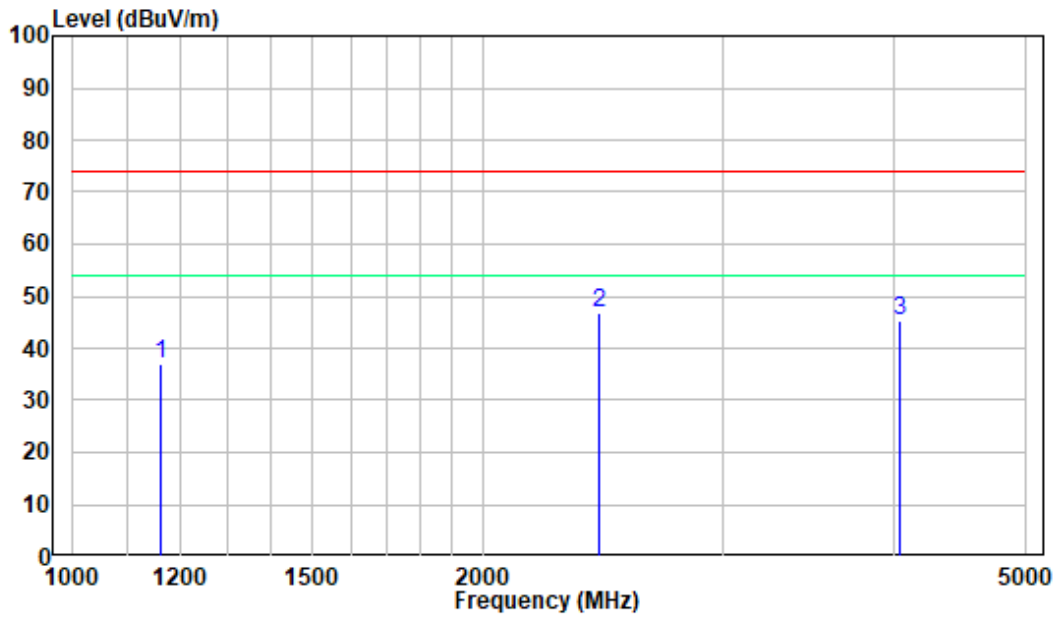

Site : chamber
 Condition: 3m VERTICAL
 Job No. : XMTN1220817-37476E-EM
 Test Mode: Charging for adapter

	Freq	Factor	Read Level	Limit Level	Limit Line	Over Limit	Remark
	MHz	dB/m	dBuV	dBuV/m	dBuV/m	dB	
1	1163.000	-10.30	47.27	36.97	74.00	-37.03	Peak
2	2430.500	-7.23	53.85	46.62	74.00	-27.38	Peak
3	4038.000	-5.35	50.74	45.39	74.00	-28.61	Peak

Test mode 3: receiver at 462.6375MHz

Horizontal:

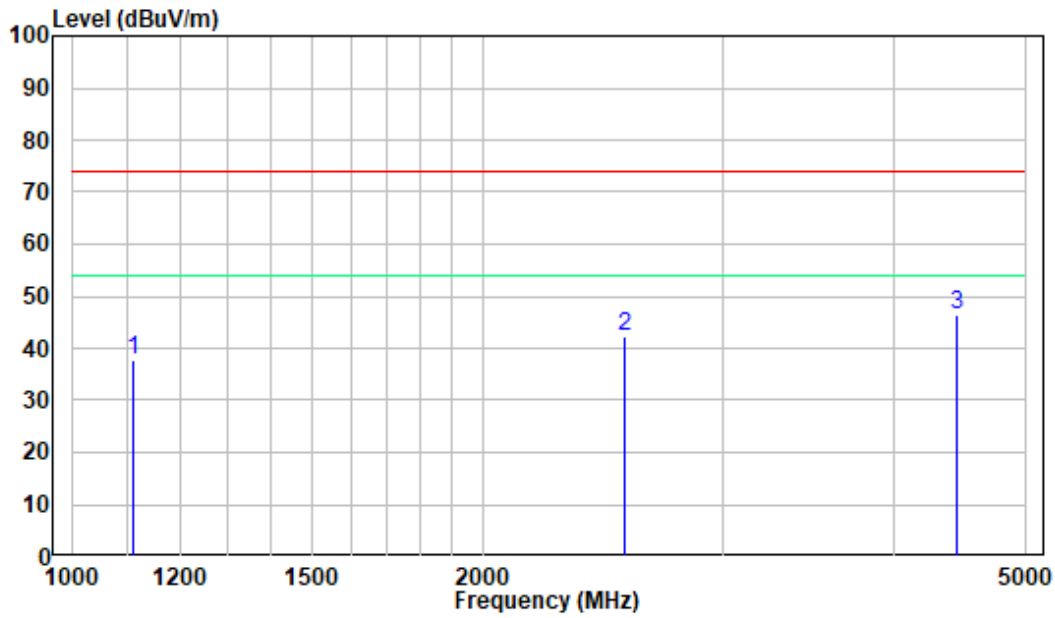

Site : chamber
 Condition: 3m Horizontal
 Job No. : XMTN1220817-37476E-EM
 Test Mode: Receiver at 462.6375MHz

	Freq	Factor	Read Level	Limit Level	Limit Line	Over Limit	Remark
	MHz	dB/m	dBuV	dBuV/m	dBuV/m	dB	
1	1108.000	-10.36	47.99	37.63	74.00	-36.37	Peak
2	2542.500	-6.98	49.11	42.13	74.00	-31.87	Peak
3	4442.500	-4.72	51.07	46.35	74.00	-27.65	Peak

Vertical

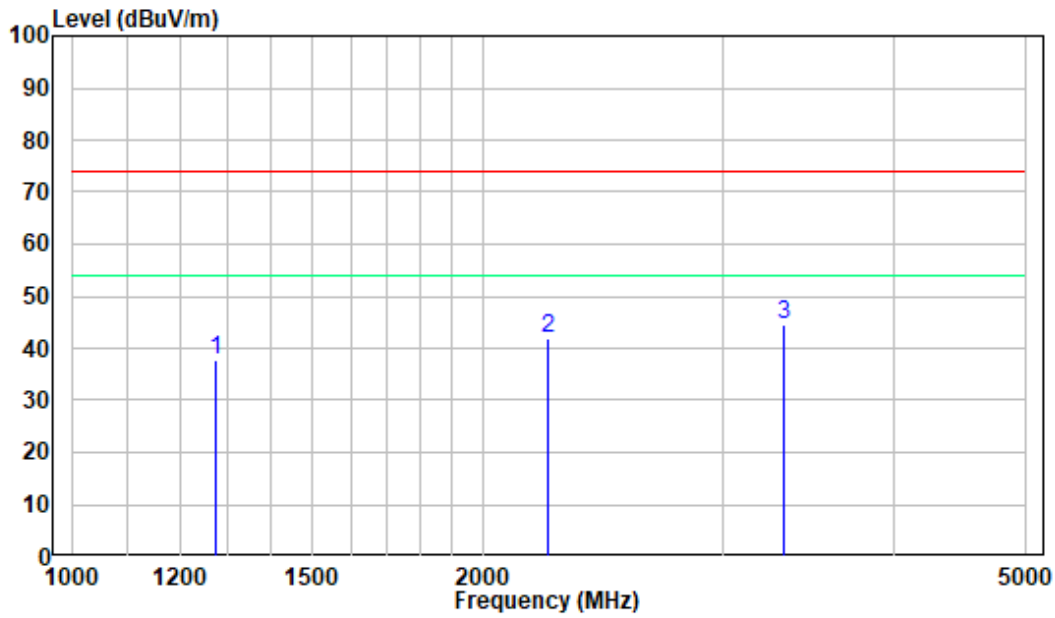

Site : chamber
 Condition: 3m VERTICAL
 Job No. : XMTN1220817-37476E-EM
 Test Mode: Receiver at 462.6375MHz

	Freq	Factor	Read Level	Limit Level	Limit Line	Over Limit	Remark
	MHz	dB/m	dBuV	dBuV/m	dBuV/m	dB	
1	1273.500	-10.15	47.83	37.68	74.00	-36.32	Peak
2	2230.500	-7.22	49.18	41.96	74.00	-32.04	Peak
3	3325.500	-5.98	50.69	44.71	74.00	-29.29	Peak

Test mode 4: receiver at 467.6375MHz

Horizontal:

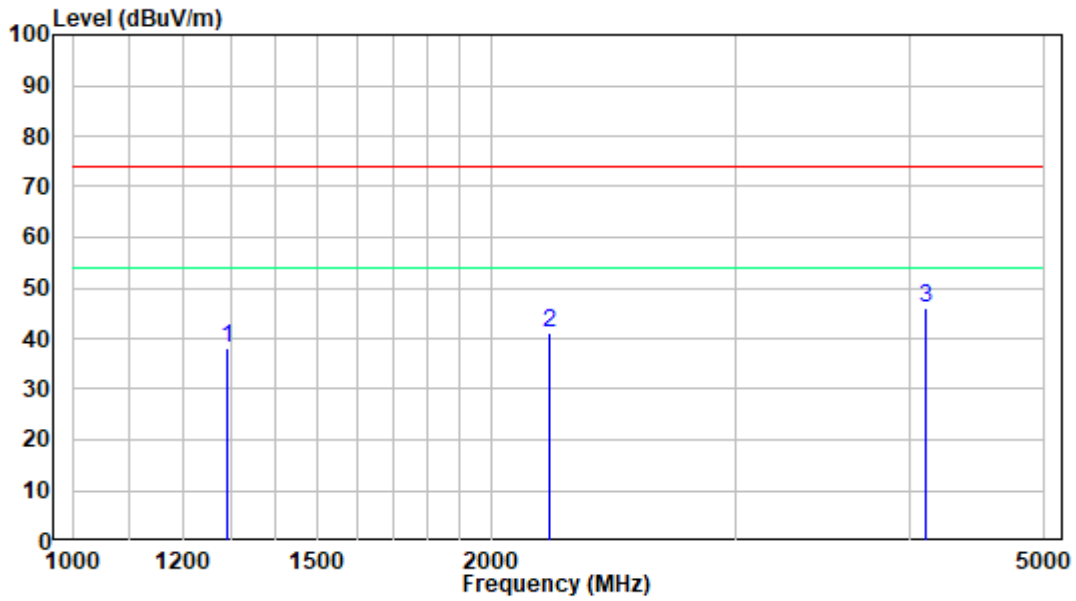

Site : chamber
 Condition: 3m Horizontal
 Job No. : XMTN1220817-37476E-EM
 Test Mode: Receiver at 467.6375MHz

	Freq	Factor	Read Level	Limit Level	Over Limit	Remark
	MHz	dB/m	dBuV	dBuV/m	dBuV/m	dB
1	1294.000	-10.19	48.12	37.93	74.00	-36.07 Peak
2	2201.500	-7.22	48.39	41.17	74.00	-32.83 Peak
3	4103.500	-5.23	51.23	46.00	74.00	-28.00 Peak

Vertical

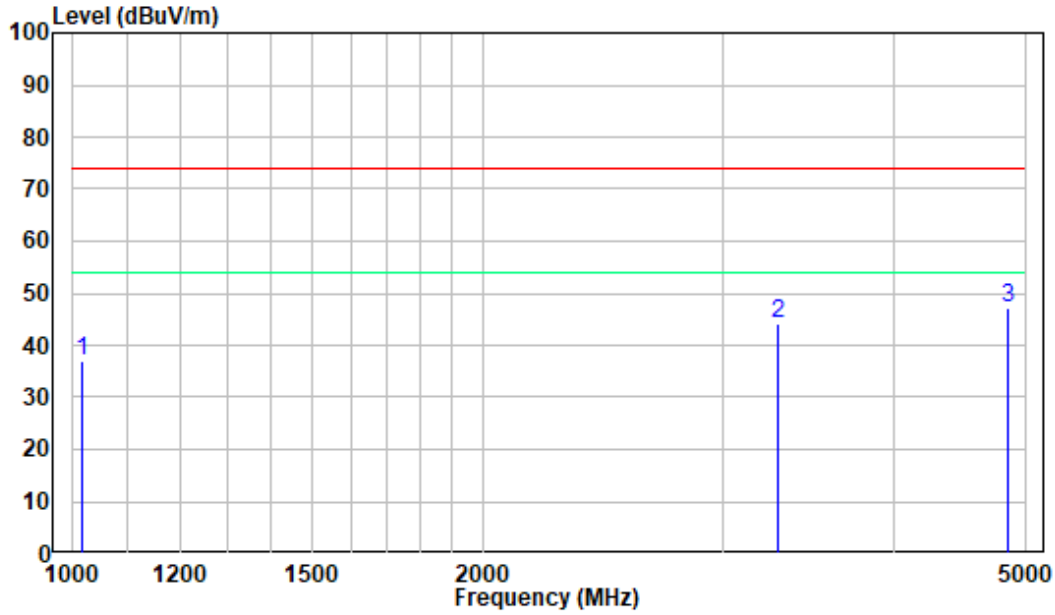

Site : chamber
 Condition: 3m VERTICAL
 Job No. : XMTN1220817-37476E-EM
 Test Mode: Receiver at 467.6375MHz

	Freq	Factor	Read Level	Limit Level	Limit Line	Over Limit	Remark
	MHz	dB/m	dBuV	dBuV/m	dBuV/m	dB	
1	1019.000	-10.52	47.47	36.95	74.00	-37.05	Peak
2	3289.500	-5.95	50.18	44.23	74.00	-29.77	Peak
3	4853.500	-3.52	50.53	47.01	74.00	-26.99	Peak

*******END OF REPORT*******