



NVLAP LAB CODE 600341-0



## TEST REPORT

**Applicant:** PO FUNG ELECTRONIC (HK) INTERNATONAL GROUP  
COMPANY LIMITED

**Address:** Room 1508, 15/F, Office Tower II, Grand Plaza, 625 Nathan Road,  
Kowloon, Hong Kong

**Product Name:** Digital Radio

**FCC ID:** 2AJGM-T20D

**Standard(s):** 47 CFR Part 2  
47 CFR Part 90  
ANSI C63.26-2015  
ANSI/TIA 603-E-2016

**Report Number:** 2402V63745E-RF-00A

**Report Date:** 2024/8/21

The above device has been tested and found compliant with the requirement of the relative standards by Bay Area Compliance Laboratories Corp. (Dongguan).

**Reviewed By:** Gavin Xu  
Title: RF Engineer

**Approved By:** Ivan Cao  
Title: EMC Manager

---

**Bay Area Compliance Laboratories Corp. (Dongguan)**  
No.12, Pulong East 1<sup>st</sup> Road, Tangxia Town, Dongguan, Guangdong, China

Tel: +86-769-86858888

Fax: +86-769-86858891

[www.baclcorp.com.cn](http://www.baclcorp.com.cn)

Note: The information marked ▲ is provided by the applicant, the laboratory is not responsible for its authenticity and this information can affect the validity of the result in the test report. Unless otherwise stated the results shown in this test report refer only to the sample(s) tested. This report cannot be reproduced except in full, without prior written approval of the Company. This report is valid only with a valid digital signature. The digital signature may be available only under the Adobe software above version 7.0. This report may contain data that are not covered by the accreditation scope and shall be marked with ★. This report must not be used by the client to claim product certification, approval, or endorsement by NVLAP, NIST, or any agency of the U.S. Government.

# CONTENTS

<b>DOCUMENT REVISION HISTORY .....</b>	<b>4</b>
<b>1. GENERAL INFORMATION .....</b>	<b>5</b>
<b>1.1 PRODUCT DESCRIPTION FOR EQUIPMENT UNDER TEST (EUT) .....</b>	<b>5</b>
<b>1.2 ACCESSORY INFORMATION.....</b>	<b>5</b>
<b>1.3 ANTENNA INFORMATION DETAIL▲.....</b>	<b>5</b>
<b>1.4 EQUIPMENT MODIFICATIONS .....</b>	<b>5</b>
<b>3. SUMMARY OF TEST RESULTS .....</b>	<b>6</b>
TRANSMITTER OUTPUT POWER .....	6
<b>3. DESCRIPTION OF TEST CONFIGURATION.....</b>	<b>7</b>
<b>3.1 TEST FREQUENCY DETAIL .....</b>	<b>7</b>
<b>3.2 EUT OPERATION CONDITION.....</b>	<b>7</b>
<b>3.3 EUT EXERCISE SOFTWARE.....</b>	<b>7</b>
<b>3.4 SUPPORT EQUIPMENT LIST AND DETAILS .....</b>	<b>7</b>
<b>3.5 SUPPORT CABLE LIST AND DETAILS .....</b>	<b>7</b>
<b>3.6 BLOCK DIAGRAM OF TEST SETUP .....</b>	<b>8</b>
<b>3.7 TEST FACILITY.....</b>	<b>9</b>
<b>3.8 MEASUREMENT UNCERTAINTY .....</b>	<b>9</b>
<b>4. REQUIREMENTS AND TEST PROCEDURES .....</b>	<b>10</b>
<b>4.1 TRANSMITTER FREQUENCY STABILITY .....</b>	<b>10</b>
4.1.1 Applicable Standard.....	10
4.1.2 EUT Setup Block Diagram .....	10
4.1.3 Test Procedure .....	11
4.1.4 Test Data And Result .....	12
<b>4.2 TRANSMITTER OUTPUT POWER .....</b>	<b>13</b>
4.2.1 Applicable Standard.....	13
4.2.2 EUT Setup Block Diagram .....	13
4.2.3 Test Procedure .....	14
4.2.4 Test Data And Result .....	15
<b>4.3 OCCUPIED BANDWIDTH &amp; EMISSION MASK.....</b>	<b>17</b>
4.3.1 Applicable Standard.....	17
4.3.2 EUT Setup Block Diagram .....	18
4.3.3 Test Procedure .....	18
4.3.4 Test Data And Result .....	19
<b>4.4 TRANSMITTER UNWANTED EMISSIONS(CONDUCTED).....</b>	<b>22</b>
4.4.1 Applicable Standard.....	22
4.4.2 EUT Setup Block Diagram .....	22

4.4.3 Test Procedure .....23

4.4.4 Test Data And Result .....24

**4.5 TRANSIENT FREQUENCY BEHAVIOR .....29**

4.5.1 Applicable Standard.....29

4.5.2 EUT Setup Block Diagram .....29

4.5.3 Test Procedure .....30

4.5.4 Test Data And Result .....31

**4.6 MODULATION CHARACTERISTICS. ....33**

4.6.1 Applicable Standard.....33

4.6.2 Test Procedure .....33

4.6.3 Test Data And Result .....35

**4.7 TRANSMITTER UNWANTED EMISSIONS(RADIATED) .....39**

4.7.1 Applicable Standard.....39

4.7.2 Test setup: .....40

4.7.3 Test Procedure: .....41

4.7.4 Test Data And Result .....42

**EXHIBIT A - EUT PHOTOGRAPHS..... 46**

**EXHIBIT B - TEST SETUP PHOTOGRAPHS ..... 47**

## DOCUMENT REVISION HISTORY

Revision Number	Report Number	Description of Revision	Date of Revision
1.0	2402V63745E-RF-00A	Original Report	2024/8/21

## 1. GENERAL INFORMATION

### 1.1 Product Description for Equipment under Test (EUT)

<b>EUT Name:</b>	Digital Radio
<b>EUT Model:</b>	NA-T20D
<b>Multiple Model:</b>	AD-T20D, AT-T20D, BD-T20A, BD-T20B, BD-T20C
<b>Operation Frequency:</b>	410-469 MHz
<b>Modulation Type:</b>	FM, GMSK
<b>Channel Spacing:</b>	12.5 kHz
<b>Rated Output Power: (Conducted)</b>	2W
<b>Rated Input Voltage:</b>	DC 3.7V from battery or DC 5V from Adapter
<b>Serial Number:</b>	2P3F-1
<b>EUT Received Date:</b>	2024/7/27
<b>EUT Received Status:</b>	Good
Note: The multiple models are electrically identical with the test model. Please refer to the declaration letter for more detail, which was provided by manufacturer.	

### 1.2 Accessory Information

Accessory Description	Manufacturer	Model	Parameters
Adapter	Jiangxi Jian Aohai Technology Co., Ltd.	A318-050100W-US2	Input: 100-240Vac 50/60Hz 0.2A Output: 5Vdc 1A

### 1.3 Antenna Information Detail ▲

Antenna Manufacturer	Antenna Type	input impedance (Ohm)	Frequency Range	Antenna Gain
PO FUNG ELECTRONIC (HK) INTERNATIONAL GROUP COMPANY LIMITED	Helical	50	400-470MHz	0 dBi

### 1.4 Equipment Modifications

No modifications are made to the EUT during all test items.

### 3. SUMMARY OF TEST RESULTS

Standard/Rule(s)	Description of Test	Results
§2.1055; §90.213	Transmitter Frequency Stability	Compliant
§2.1046; §90.205	Transmitter Output Power	Compliant
§2.1049; §90.209; §90.210	Occupied Bandwidth & Emission Mask	Compliant
§2.1051; §90.210	Transmitter Unwanted Emissions at Antenna Terminal	Compliant
§2.1053; §90.210	Transmitter Unwanted Emissions-Radiated	Compliant
§90.214	Transient Frequency Behavior	Compliant
§2.1047	Modulation Characteristic	Compliant

### 3. DESCRIPTION OF TEST CONFIGURATION

#### 3.1 Test Frequency Detail

Per C63.26-2015, section 5.1, the lowest frequency, middle frequency, and highest frequency was performed the test as below:

Modulation/ Channel Bandwidth	Test Channel	Frequency (MHz)	Rule Part
FM 12.5kHz	Lowest	410.0125	For Part 90
	Middle	439.5	For Part 90
	Highest	468.9875	For Part 90
GMSK 12.5kHz	Lowest	410.0125	For Part 90
	Middle	439.5	For Part 90
	Highest	468.9875	For Part 90

#### 3.2 EUT Operation Condition

The system was configured for testing in Engineering Mode, which was provided by the manufacturer.

#### 3.3 EUT Exercise Software

No software was used during test.

#### 3.4 Support Equipment List and Details

Manufacturer	Description	Model	Serial Number
/	/	/	/

#### 3.5 Support Cable List and Details

Cable Description	Shielding Type	Ferrite Core	Length (m)	From Port	To
/	/	/	/	/	/

### 3.6 Block Diagram of Test Setup

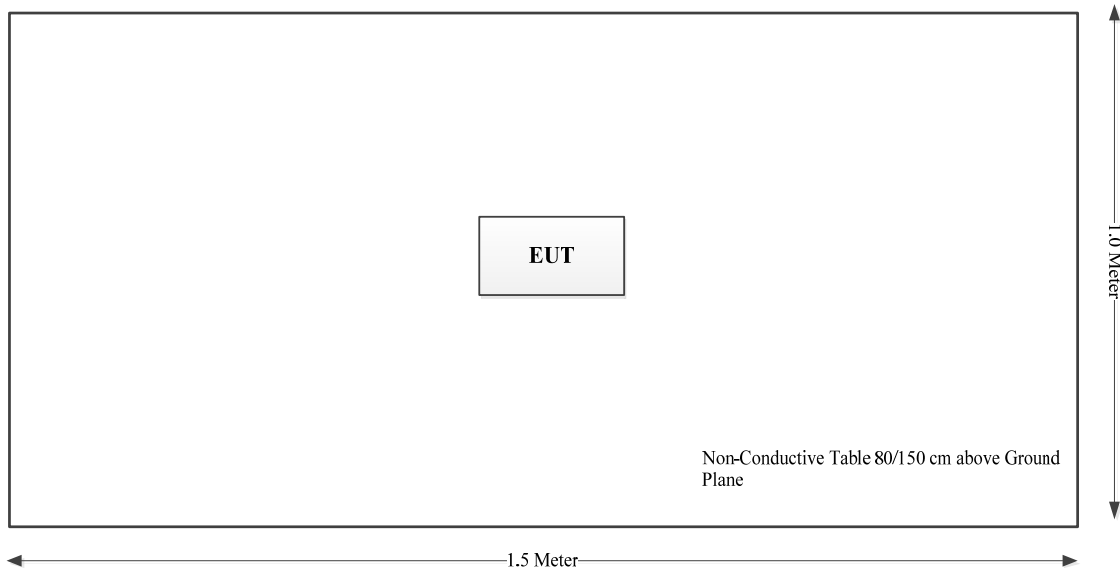



### 3.7 Test Facility

The Test site used by Bay Area Compliance Laboratories Corp. (Dongguan) to collect test data is located on the No.12, Pulong East 1st Road, Tangxia Town, Dongguan, Guangdong, China.

The lab has been recognized as the FCC accredited lab under the KDB 974614 D01 and is listed in the FCC Public Access Link (PAL) database, FCC Registration No. : 829273, the FCC Designation No. : CN5044.

The lab has been recognized by Innovation, Science and Economic Development Canada to test to Canadian radio equipment requirements, the CAB identifier: CN0022.

### 3.8 Measurement Uncertainty

Otherwise required by the applicant or Product Regulations, Decision Rule in this report did not consider the uncertainty. The extended uncertainty given in this report is obtained by combining the standard uncertainty times the coverage factor K with the 95% confidence interval.

Parameter	Measurement Uncertainty
Occupied Channel Bandwidth	±5 %
RF output power, conducted	±0.61dB
RF Frequency	$0.082 \times 10^{-6}$
Unwanted Emissions, radiated	±3.62 dB
Unwanted Emissions, conducted	±2.47 dB
Temperature	±1 °C
Humidity	±5%
DC and low frequency voltages	±0.4%
Duty Cycle	1%

## 4. REQUIREMENTS AND TEST PROCEDURES

### 4.1 Transmitter Frequency Stability

#### 4.1.1 Applicable Standard

FCC §90.213

In the 150-174 MHz band, fixed and base stations with a 12.5 kHz channel bandwidth must have a frequency stability of 2.5 ppm. Fixed and base stations with a 6.25 kHz channel bandwidth must have a frequency stability of 1.0 ppm.

In the 150-174 MHz band, mobile stations designed to operate with a 12.5 kHz channel bandwidth or designed to operate on a frequency specifically designated for itinerant use or designed for low-power operation of two watts or less, must have a frequency stability of 5.0 ppm. Mobile stations designed to operate with a 6.25 kHz channel bandwidth must have a frequency stability of 2.0 ppm.

In the 421-512 MHz band, mobile stations designed to operate with a 12.5 kHz channel bandwidth must have a frequency stability of 2.5 ppm. Mobile stations designed to operate with a 6.25 kHz channel bandwidth must have a frequency stability of 1.0 ppm.

#### 4.1.2 EUT Setup Block Diagram

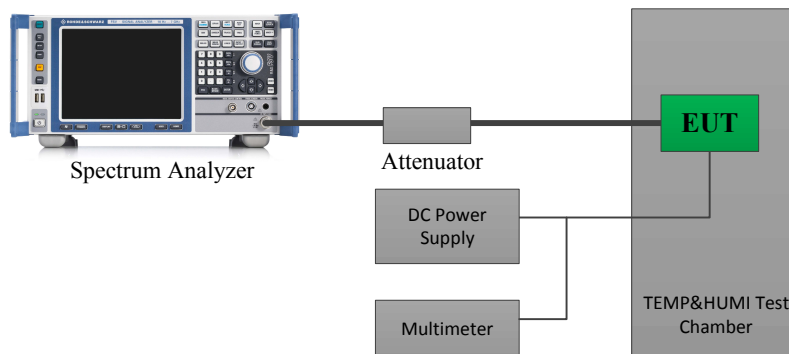

### 4.1.3 Test Procedure

According to ANSI C63.26-2015 Section 5.6:

Frequency stability is a measure of the frequency drift due to temperature and supply voltage variations, with reference to the frequency measured at +20 °C and rated supply voltage.

The operating carrier frequency shall be set up in accordance with the manufacturer's published operation and instruction manual prior to the commencement of these tests. No adjustment of any frequency determining circuit element shall be made subsequent to this initial set-up. Frequency stability is tested:

- a) At 10 °C intervals of temperatures between -30 °C and +50 °C at the manufacturer's rated supply voltage, and
- b) At +20 °C temperature and ±15% supply voltage variations. If a product is specified to operate over a range of input voltage then the -15% variation is applied to the lowermost voltage and the +15% is applied to the uppermost voltage.

During the test all necessary settings, adjustments and control of the EUT have to be performed without disturbing the test environment, i.e., without opening the environmental chamber. The frequency stabilities can be maintained to a lesser temperature range provided that the transmitter is automatically inhibited from operating outside the lesser temperature range. For handheld equipment that is only capable of operating from internal batteries and the supply voltage cannot be varied, the frequency stability tests shall be performed at the nominal battery voltage and the battery end point voltage specified by the manufacturer. An external supply voltage can be used and set at the internal battery nominal voltage, and again at the battery operating end point voltage which shall be specified by the equipment manufacturer.

If an unmodulated carrier is not available, the mean frequency of a modulated carrier can be obtained by using a frequency counter with gating time set to an appropriately large multiple of bit periods (gating time depending on the required accuracy). Full details on the choice of values shall be included in the test report.

**4.1.4 Test Data And Result**

Serial Number:	2P3F-1	Test Date:	2024/8/15
Test Site:	RF	Test Mode:	Transmitting
Tester:	Stu Song	Test Result:	Pass

**Environmental Conditions:**

Temperature: (°C)	26.5	Relative Humidity: (%)	62	ATM Pressure: (kPa)	100.4
----------------------	------	---------------------------	----	------------------------	-------

**Test Equipment List and Details:**

Manufacturer	Description	Model	Serial Number	Calibration Date	Calibration Due Date
R&S	Spectrum Analyzer	FSU 26	200160/026	2023/10/18	2024/10/17
Unknown	Coaxial Cable	C-NJNJ-50	C-0200-03	2023/9/2	2024/9/1
Huaxiang	Coaxial Attenuator	DTS250-30	11022109	2024/6/7	2025/6/6
BACL	TEMP&HUMI Test Chamber	BTH-150-40	30173	2023/10/18	2024/10/17
All-sun	Clamp Meter	EM305A	8348897	2024/8/3	2025/8/2
TDK-Lambda	DC Power Supply	Z+60-14	F-08-EM038-1	N/A	N/A

\* Statement of Traceability: Bay Area Compliance Laboratories Corp. (Dongguan) attests that all calibrations have been performed, traceable to National Primary Standards and International System of Units (SI).

**Test Data:**

Unmodulation, fc = 439.5 MHz				
Temperature	Voltage	Reading	Frequency Error	Limit
°C	Vdc	MHz	ppm	ppm
-30	3.7	439.5003793	0.86	2.5
-20		439.5003529	0.80	
-10		439.5003312	0.75	
0		439.5003096	0.70	
10		439.5002827	0.64	
20		439.5002564	0.58	
30		439.5002313	0.53	
40		439.5002048	0.47	
50		439.5001836	0.42	
20		3.5	439.5002985	
20	4.2	439.5002078	0.47	

## 4.2 Transmitter Output Power

### 4.2.1 Applicable Standard

FCC §90.205

(d) 150-174 MHz. (1) The maximum allowable station ERP is dependent upon the station's antenna HAAT and required service area and will be authorized in accordance with table 1. Applicants requesting an ERP in excess of that listed in table 1 must submit an engineering analysis based upon generally accepted engineering practices and standards that includes coverage contours to demonstrate that the requested station parameters will not produce coverage in excess of that which the applicant requires.

(h) 450-470 MHz.

(1) The maximum allowable station effective radiated power (ERP) is dependent upon the station's antenna HAAT and required service area and will be authorized in accordance with table 2. Applicants requesting an ERP in excess of that listed in table 2 must submit an engineering analysis based upon generally accepted engineering practices and standards that includes coverage contours to demonstrate that the requested station parameters will not produce coverage in excess of that which the applicant requires.

(2) Applications for stations where special circumstances exist that make it necessary to deviate from the ERP and antenna heights in Table 2 will be submitted to the frequency coordinator accompanied by a technical analysis, based upon generally accepted engineering practices and standards, that demonstrates that the requested station parameters will not produce a signal strength in excess of 39 dBu at any point along the edge of the requested service area. The coordinator may then recommend any ERP appropriate to meet this condition.

(3) An applicant for a station with a service area radius greater than 32 km (20 mi) must justify the requested service area radius, which may be authorized only in accordance with table 2, note 4. For base stations with service areas greater than 80 km, all operations 80 km or less from the base station will be on a primary basis and all operations outside of 80 km from the base station will be on a secondary basis and will be entitled to no protection from primary operations.

### 4.2.2 EUT Setup Block Diagram

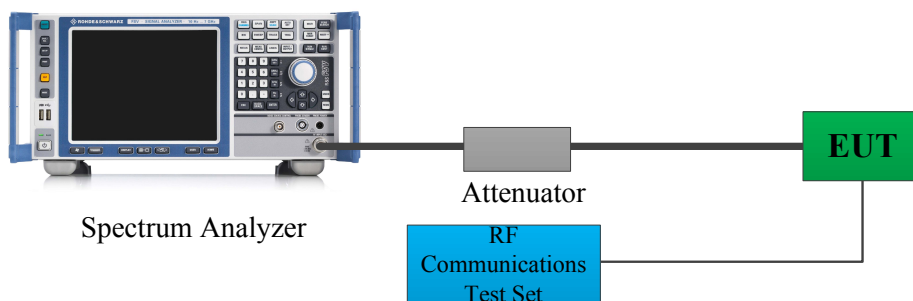

**Note: The Insertion loss of the RF cable, Attenuators was offset into the Spectrum Analyzer.**

### 4.2.3 Test Procedure

C63.26-2015, Clause 5.2.3.3

This procedure can be used to measure the peak power in either a CW-like or noise-like narrowband RF signal. The measurement instrument must have a RBW that is greater than or equal to the OBW of the signal to be measured and a VBW  $\geq 3 \times$  RBW.

- a) Set the RBW  $\geq$  OBW.
- b) Set VBW  $\geq 3 \times$  RBW.
- c) Set span  $\geq 2 \times$  OBW.
- d) Sweep time  $\geq 10 \times$  (number of points in sweep)  $\times$  (transmission symbol period).
- e) Detector = peak.
- f) Trace mode = max hold.
- g) Allow trace to fully stabilize.
- h) Use the peak marker function to determine the peak amplitude level

**4.2.4 Test Data And Result**

Serial Number:	2P3F-1	Test Date:	2024/8/15
Test Site:	RF	Test Mode:	Transmitting
Tester:	Stu Song	Test Result:	Pass

<b>Environmental Conditions:</b>					
Temperature: (°C)	26.5	Relative Humidity: (%)	62	ATM Pressure: (kPa)	100.4

**Test Equipment List and Details:**

Manufacturer	Description	Model	Serial Number	Calibration Date	Calibration Due Date
R&S	Spectrum Analyzer	FSU 26	200160/026	2023/10/18	2024/10/17
Unknown	Coaxial Cable	C-NJNJ-50	C-0200-03	2023/9/2	2024/9/1
Huaxiang	Coaxial Attenuator	DTS250-30	11022109	2024/6/7	2025/6/6
HP	RF Communications Test Set	8920A	3438A05201	2023/10/18	2024/10/17

\* Statement of Traceability: Bay Area Compliance Laboratories Corp. (Dongguan) attests that all calibrations have been performed, traceable to National Primary Standards and International System of Units (SI).

**Test Data:**

Channel Separation	Test Modulation	Test Channel	Test Frequency (MHz)	Conducted Output Power (dBm)	Limit (dBm)
12.5kHz	FM	Low	410.0125	32.43	33.80
		Middle	439.5	32.24	33.80
		High	468.9875	32.80	33.80
12.5kHz	GMSK	Low	410.0125	32.43	33.80
		Middle	439.5	32.22	33.80
		High	468.9875	32.84	33.80

Note:

The rated power level is 2W(33dBm).

The output power shall not exceed by more than 20 percent the manufacturer's rated output power for the particular transmitter specifically listed on the authorization.

**FM, 12.5kHz, Low Channel, 410.0125 MHz**

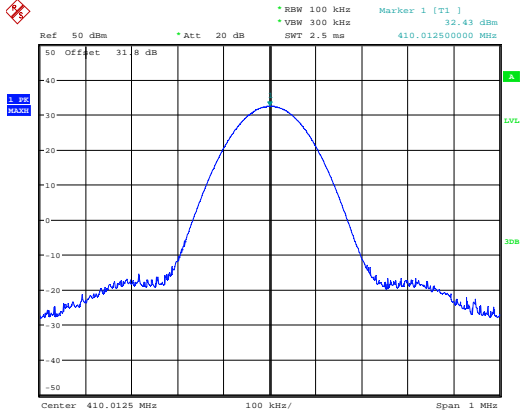

ProjectNo.:2402V63745E-RF Tester:Stu Song  
Date: 15.AUG.2024 13:42:40

**FM, 12.5kHz, Middle Channel, 439.5 MHz**

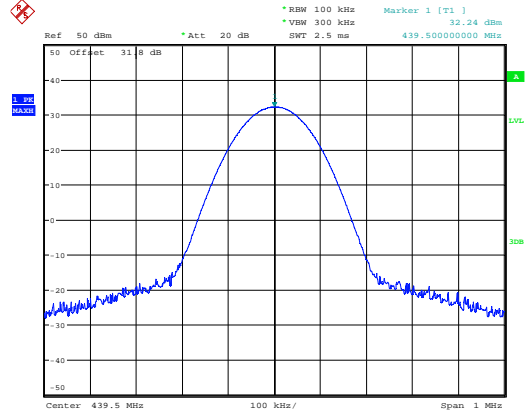

ProjectNo.:2402V63745E-RF Tester:Stu Song  
Date: 15.AUG.2024 13:45:22

**FM, 12.5kHz, High Channel, 468.9875 MHz**

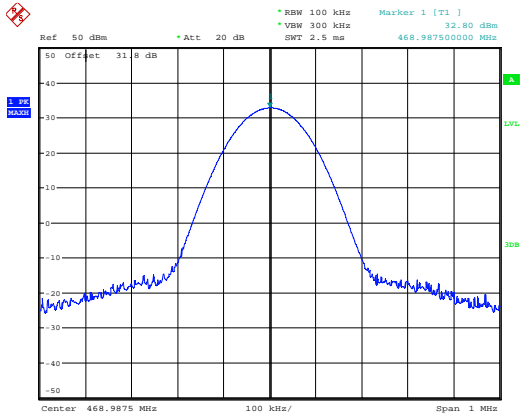

ProjectNo.:2402V63745E-RF Tester:Stu Song  
Date: 15.AUG.2024 13:47:29

**GMSK, 12.5kHz, Low Channel, 410.0125 MHz**

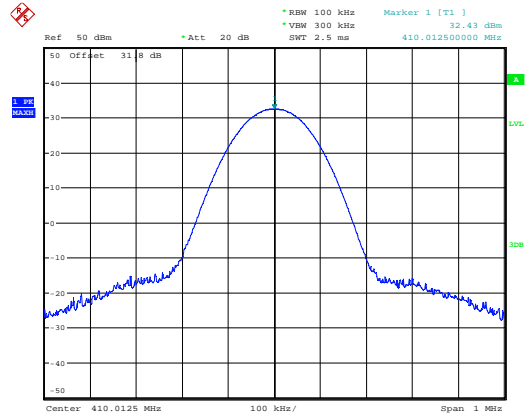

ProjectNo.:2402V63745E-RF Tester:Stu Song  
Date: 15.AUG.2024 13:43:20

**GMSK, 12.5kHz, Middle Channel, 439.5 MHz**

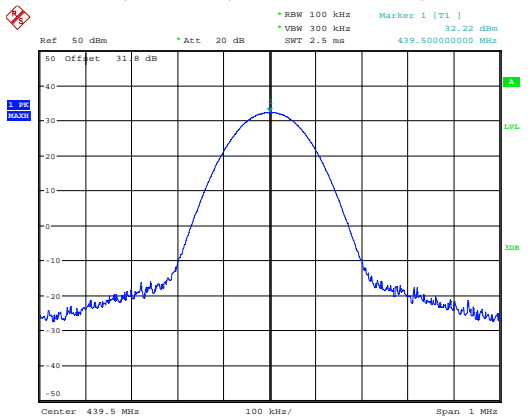

ProjectNo.:2402V63745E-RF Tester:Stu Song  
Date: 15.AUG.2024 13:46:02

**GMSK, 12.5kHz, High Channel, 468.9875 MHz**

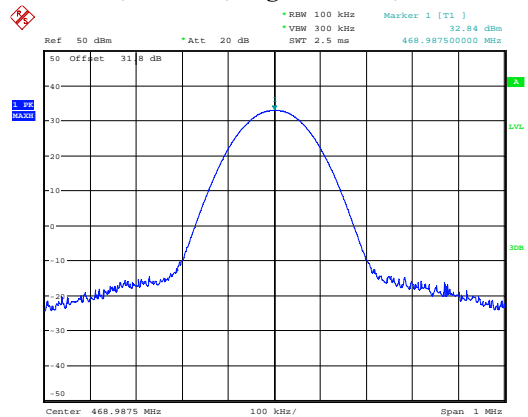

ProjectNo.:2402V63745E-RF Tester:Stu Song  
Date: 15.AUG.2024 13:48:11



## 4.3 Occupied Bandwidth & Emission Mask

### 4.3.1 Applicable Standard

FCC §90.209

(a) Each authorization issued to a station licensed under this part will show an emission designator representing the class of emission authorized. The designator will be prefixed by a specified necessary bandwidth. This number does not necessarily indicate the bandwidth occupied by the emission at any instant. In those cases where §2.202 of this chapter does not provide a formula for the computation of necessary bandwidth, the occupied bandwidth, as defined in part 2 of this chapter, may be used in lieu of the necessary bandwidth.

(b) (5) Unless specified elsewhere, channel spacings and bandwidths that will be authorized in the following frequency bands are given in the following table: STANDARD CHANNEL SPACING/BANDWIDTH

FCC §90.210

Emission Mask D—12.5 kHz channel bandwidth equipment. For transmitters designed to operate with a 12.5 kHz channel bandwidth, any emission must be attenuated below the power (P) of the highest emission contained within the authorized bandwidth as follows:

- (1) On any frequency from the center of the authorized bandwidth  $f_0$  to 5.625 kHz removed from  $f_0$ : Zero dB.
- (2) On any frequency removed from the center of the authorized bandwidth by a displacement frequency ( $f_d$  in kHz) of more than 5.625 kHz but no more than 12.5 kHz: At least  $7.27(f_d - 2.88 \text{ kHz})$  dB.
- (3) On any frequency removed from the center of the authorized bandwidth by a displacement frequency ( $f_d$  in kHz) of more than 12.5 kHz: At least  $50 + 10 \log(P)$  dB or 70 dB, whichever is the lesser attenuation.
- (4) The reference level for showing compliance with the emission mask shall be established using a resolution bandwidth sufficiently wide (usually two or three times the channel bandwidth) to capture the true peak emission of the equipment under test. In order to show compliance with the emission mask up to and including 50 kHz removed from the edge of the authorized bandwidth, adjust the resolution bandwidth to 100 Hz with the measuring instrument in a peak hold mode. A sufficient number of sweeps must be measured to insure that the emission profile is developed. If video filtering is used, its bandwidth must not be less than the instrument resolution bandwidth. For emissions beyond 50 kHz from the edge of the authorized bandwidth, see paragraph (o) of this section. If it can be shown that use of the above instrumentation settings do not accurately represent the true interference potential of the equipment under test, an alternate procedure may be used provided prior Commission approval is obtained.

### 4.3.2 EUT Setup Block Diagram

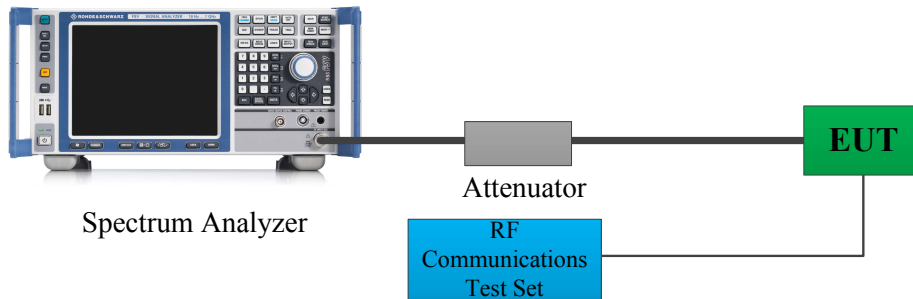

**Note:** The Insertion loss of the RF cable, Attenuators was offset into the Spectrum Analyzer.

### 4.3.3 Test Procedure

According to ANSI C63.26-2015 Section 5.4.4:

The OBW is the frequency bandwidth such that, below its lower and above its upper frequency limits, the mean powers are each equal to 0.5% of the total mean power of the given emission.

The following procedure shall be used for measuring (99%) power bandwidth:

- The spectrum analyzer center frequency is set to the nominal EUT channel center frequency. The frequency span for the spectrum analyzer shall be set wide enough to capture all modulation products including the emission skirts (typically a span of  $1.5 \times \text{OBW}$  is sufficient).
- The nominal IF filter 3 dB bandwidth (RBW) shall be in the range of 1% to 5% of the anticipated OBW, and the VBW shall be set  $\geq 3 \times \text{RBW}$ .
- Set the reference level of the instrument as required to prevent the signal amplitude from exceeding the maximum spectrum analyzer input mixer level for linear operation. See guidance provided in 4.2.3.  
NOTE—Step a), step b), and step c) may require iteration to adjust within the specified tolerances.
- Set the detection mode to peak, and the trace mode to max-hold.
- If the instrument does not have a 99% OBW function, recover the trace data points and sum directly in linear power terms. Place the recovered amplitude data points, beginning at the lowest frequency, in a running sum until 0.5% of the total is reached. Record that frequency as the lower OBW frequency. Repeat the process until 99.5% of the total is reached and record that frequency as the upper OBW frequency. The 99% power OBW can be determined by computing the difference these two frequencies.
- The OBW shall be reported and plot(s) of the measuring instrument display shall be provided with the test report. The frequency and amplitude axis and scale shall be clearly labeled. Tabular data can be reported in addition to the plot(s).

According to ANSI C63.26-2015 Section 5.7.3:

- See Annex I for example emission mask plots.

**4.3.4 Test Data And Result**

Serial Number:	2P3F-1	Test Date:	2024/8/15
Test Site:	RF	Test Mode:	Transmitting
Tester:	Stu Song	Test Result:	Pass

<b>Environmental Conditions:</b>					
Temperature: (°C)	26.5	Relative Humidity: (%)	62	ATM Pressure: (kPa)	100.4

**Test Equipment List and Details:**

Manufacturer	Description	Model	Serial Number	Calibration Date	Calibration Due Date
R&S	Spectrum Analyzer	FSU 26	200160/026	2023/10/18	2024/10/17
Unknown	Coaxial Cable	C-NJNJ-50	C-0200-03	2023/9/2	2024/9/1
Huaxiang	Coaxial Attenuator	DTS250-30	11022109	2024/6/7	2025/6/6
HP	RF Communications Test Set	8920A	3438A05201	2023/10/18	2024/10/17

*\* Statement of Traceability: Bay Area Compliance Laboratories Corp. (Dongguan) attests that all calibrations have been performed, traceable to National Primary Standards and International System of Units (SI).*

**Test Data:**

**Bandwidth:**

Test Mode	Test Channel	Test Frequency (MHz)	99% Occupied Bandwidth (kHz)	26dB Emission Bandwidth (kHz)
FM 12.5kHz	Low	410.0125	9.936	10.721
	Middle	439.5	9.936	10.721
	High	468.9875	9.936	10.721
GMSK 12.5kHz	Low	410.0125	10.176	12.724
	Middle	439.5	10.176	12.644
	High	468.9875	10.176	12.644

Emission Mask please refer to the plots.

FM, 12.5kHz:

Low Channel

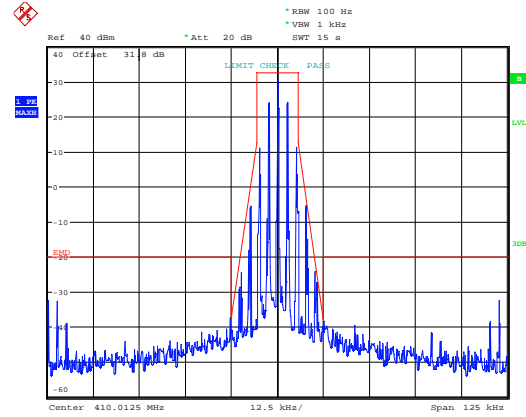
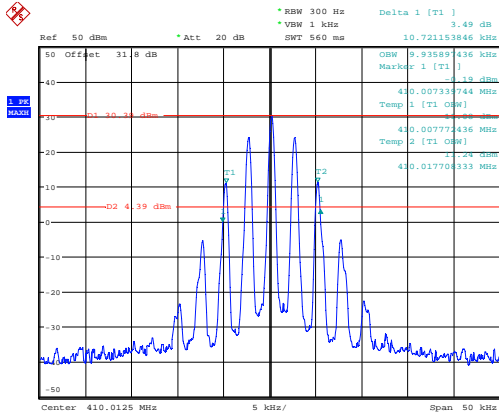

ProjectNo.:2402V63745E-RF Tester:Stu Song  
Date: 15.AUG.2024 13:58:34

ProjectNo.:2402V63745E-RF Tester:Stu Song  
Date: 15.AUG.2024 13:59:40

Middle Channel

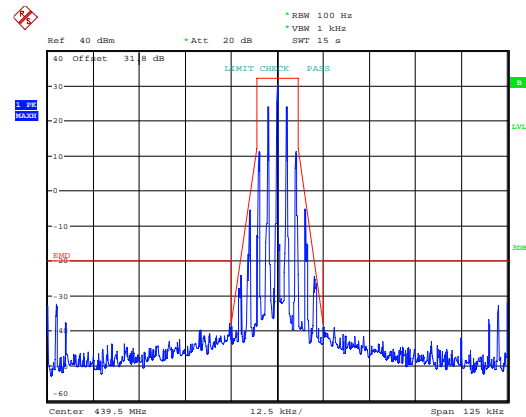
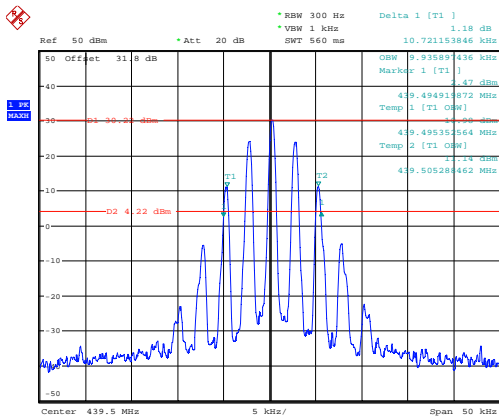

ProjectNo.:2402V63745E-RF Tester:Stu Song  
Date: 15.AUG.2024 14:05:31

ProjectNo.:2402V63745E-RF Tester:Stu Song  
Date: 15.AUG.2024 14:07:23

High Channel

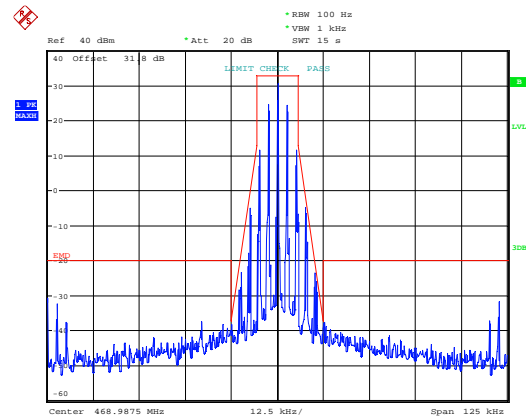
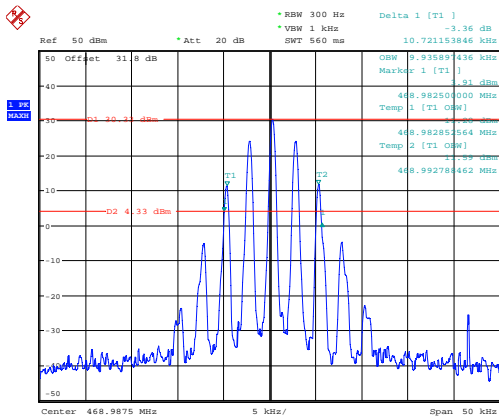

ProjectNo.:2402V63745E-RF Tester:Stu Song  
Date: 15.AUG.2024 14:58:09

ProjectNo.:2402V63745E-RF Tester:Stu Song  
Date: 15.AUG.2024 14:43:46

GMSK, 12.5kHz:

Low Channel

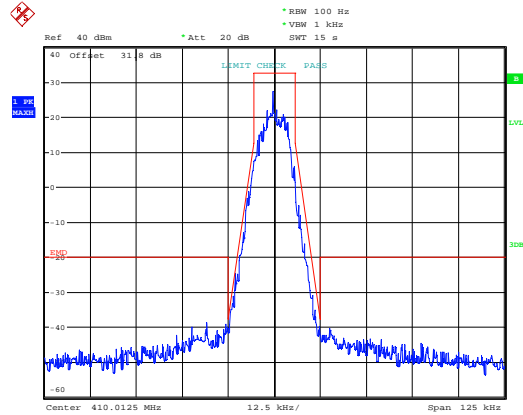
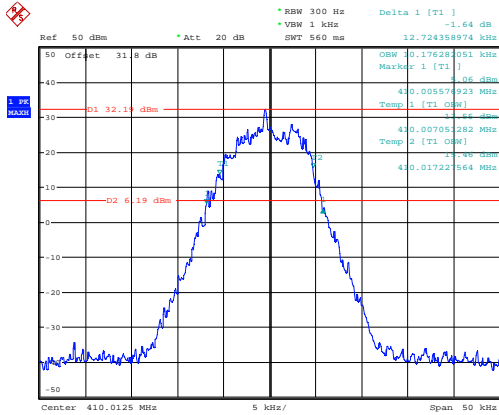

ProjectNo.:2402V63745E-RF Tester:Stu Song  
Date: 15.AUG.2024 14:01:55

ProjectNo.:2402V63745E-RF Tester:Stu Song  
Date: 15.AUG.2024 14:03:20

Middle Channel

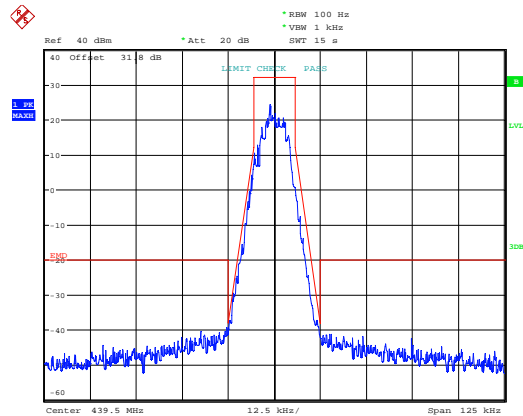
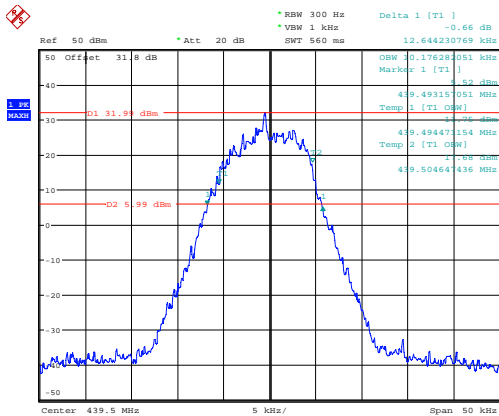

ProjectNo.:2402V63745E-RF Tester:Stu Song  
Date: 15.AUG.2024 14:09:36

ProjectNo.:2402V63745E-RF Tester:Stu Song  
Date: 15.AUG.2024 14:12:00

High Channel

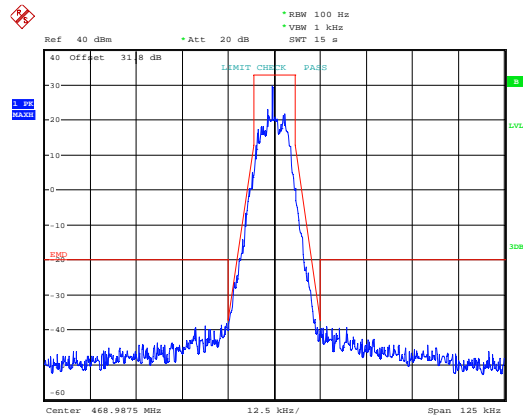
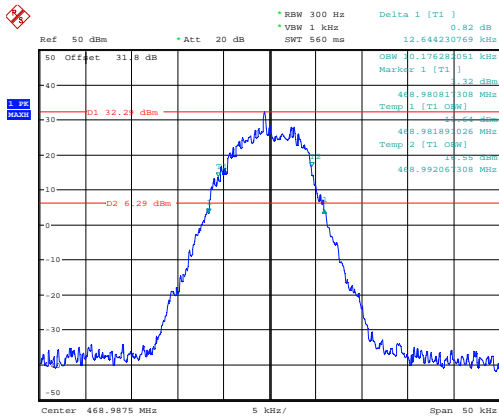

ProjectNo.:2402V63745E-RF Tester:Stu Song  
Date: 15.AUG.2024 14:44:52

ProjectNo.:2402V63745E-RF Tester:Stu Song  
Date: 15.AUG.2024 14:46:42

## 4.4 Transmitter Unwanted Emissions(Conducted)

### 4.4.1 Applicable Standard

FCC §90.210

Emission Mask D—12.5 kHz channel bandwidth equipment. For transmitters designed to operate with a 12.5 kHz channel bandwidth, any emission must be attenuated below the power (P) of the highest emission contained within the authorized bandwidth as follows:

- (1) On any frequency from the center of the authorized bandwidth  $f_0$  to 5.625 kHz removed from  $f_0$ : Zero dB.
- (2) On any frequency removed from the center of the authorized bandwidth by a displacement frequency ( $f_d$  in kHz) of more than 5.625 kHz but no more than 12.5 kHz: At least  $7.27(f_d - 2.88 \text{ kHz})$  dB.
- (3) On any frequency removed from the center of the authorized bandwidth by a displacement frequency ( $f_d$  in kHz) of more than 12.5 kHz: At least  $50 + 10 \log(P)$  dB or 70 dB, whichever is the lesser attenuation.
- (4) The reference level for showing compliance with the emission mask shall be established using a resolution bandwidth sufficiently wide (usually two or three times the channel bandwidth) to capture the true peak emission of the equipment under test. In order to show compliance with the emission mask up to and including 50 kHz removed from the edge of the authorized bandwidth, adjust the resolution bandwidth to 100 Hz with the measuring instrument in a peak hold mode. A sufficient number of sweeps must be measured to insure that the emission profile is developed. If video filtering is used, its bandwidth must not be less than the instrument resolution bandwidth. For emissions beyond 50 kHz from the edge of the authorized bandwidth, see paragraph (o) of this section. If it can be shown that use of the above instrumentation settings do not accurately represent the true interference potential of the equipment under test, an alternate procedure may be used provided prior Commission approval is obtained.

### 4.4.2 EUT Setup Block Diagram

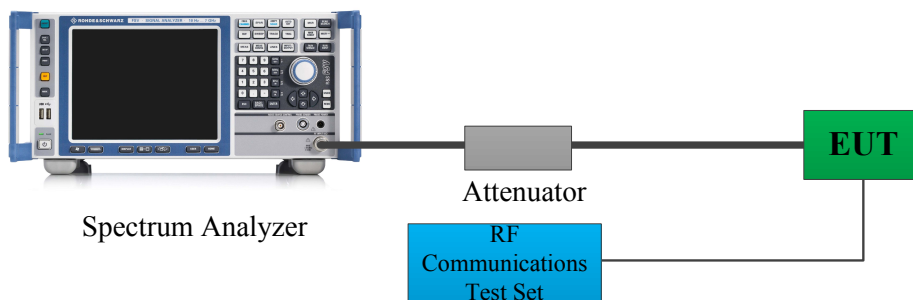

**Note:** The Insertion loss of the RF cable, Attenuators was offset into the Spectrum Analyzer.

#### 4.4.3 Test Procedure

According to ANSI C63.26-2015 Section 5.7.4:

- a) Set the spectrum analyzer start frequency to the lowest frequency generated by the EUT, without going below 9 kHz, and the stop frequency to the lower frequency covered by the measurements previously performed in 5.7.3. As an alternative, the stop frequency can be set to the value specified in 5.1.1, depending on the EUT operating range, if the resulting plot can clearly demonstrate compliance for all frequencies not addressed by the out-of-band emissions measurements performed as per 5.7.3.
- b) When using an average power (rms) detector, ensure that the number of points in the sweep  $\geq 2 \times (\text{span} / \text{RBW})$ . This may require that the measurement range defined by the start and stop frequencies be subdivided, depending on the spectrum analyzer capabilities. This requirement does not apply to peak-detected power measurements. When average power is specified by the applicable regulation, a peak-detector can be utilized for preliminary measurements to accommodate wider frequency spans. Any emissions found in the preliminary measurement to exceed the applicable limit(s) shall be further examined using a power averaging (rms) detector with the minimum number of measurement points as defined above.
- c) The sweep time should be set to auto-couple for performing peak-detector measurements. For measurements that use a power averaging (rms) detector, the sweep time shall be set as described for out-of-band emissions measurements in item d) of 5.7.3.
- d) Identify and measure the highest spurious emission levels in each frequency range. It is not necessary to re-measure the out-of-band emissions as a part of this test. Record the frequencies and amplitudes corresponding to the measured emissions and capture the data plots.
- e) Repeat step b) through step d) for the upper spurious emission frequency range if not already captured by a wide span measurement performed as per the alternative provided in step a). The upper frequency for this measurement is defined in 5.1.1 as a function of the EUT operating range.
- f) Compare the results with the corresponding limit in the applicable regulation.
- g) The test report shall include the data plots of the measuring instrument display and the measured data.

**4.4.4 Test Data And Result**

Serial Number:	2P3F-1	Test Date:	2024/8/15
Test Site:	RF	Test Mode:	Transmitting
Tester:	Stu Song	Test Result:	Pass

<b>Environmental Conditions:</b>					
Temperature: (°C)	26.5	Relative Humidity: (%)	62	ATM Pressure: (kPa)	100.4

**Test Equipment List and Details:**

Manufacturer	Description	Model	Serial Number	Calibration Date	Calibration Due Date
R&S	Spectrum Analyzer	FSU 26	200160/026	2023/10/18	2024/10/17
Unknown	Coaxial Cable	C-NJNJ-50	C-0200-03	2023/9/2	2024/9/1
Huaxiang	Coaxial Attenuator	DTS250-30	11022109	2024/6/7	2025/6/6
HP	RF Communications Test Set	8920A	3438A05201	2023/10/18	2024/10/17

*\* Statement of Traceability: Bay Area Compliance Laboratories Corp. (Dongguan) attests that all calibrations have been performed, traceable to National Primary Standards and International System of Units (SI).*

**Test Data:**



FM, 12.5kHz:

Low Channel

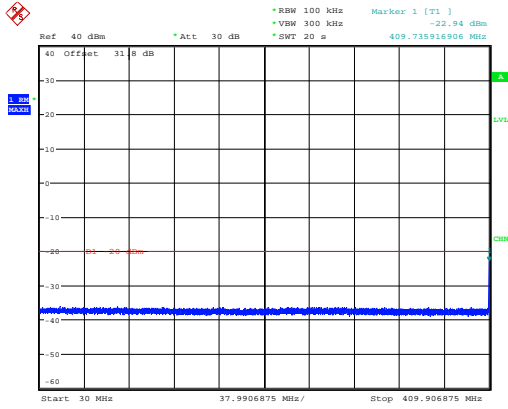

ProjectNo.:2402V63745E-RF Tester:Stu Song  
Date: 15.AUG.2024 15:02:56

Middle Channel

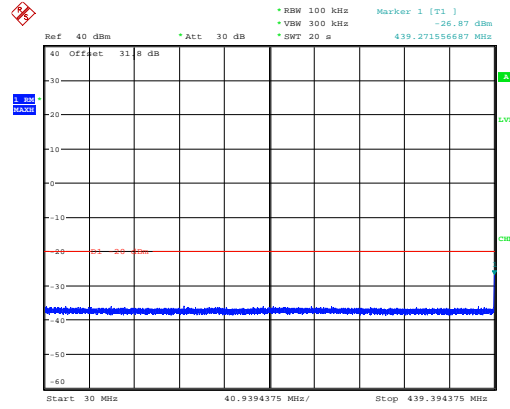

ProjectNo.:2402V63745E-RF Tester:Stu Song  
Date: 15.AUG.2024 15:14:35

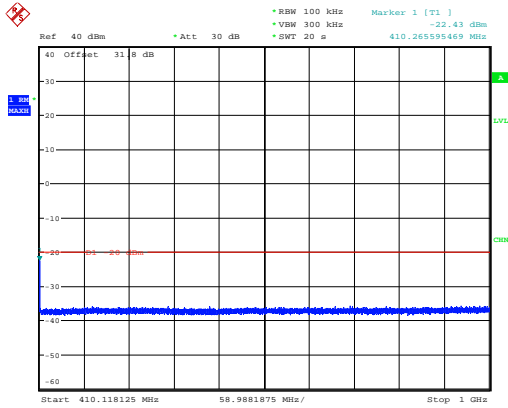

ProjectNo.:2402V63745E-RF Tester:Stu Song  
Date: 15.AUG.2024 15:09:05

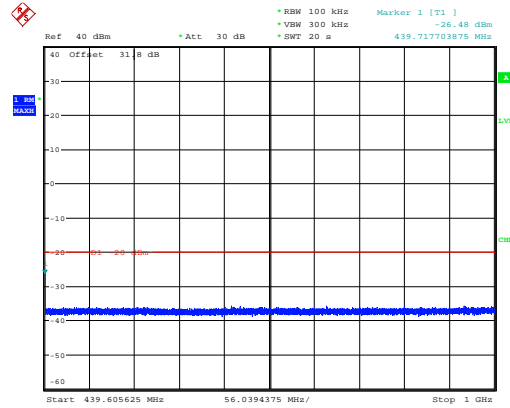

ProjectNo.:2402V63745E-RF Tester:Stu Song  
Date: 15.AUG.2024 15:21:28

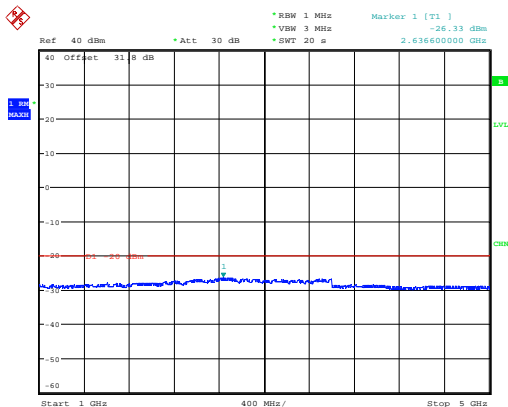

ProjectNo.:2402V63745E-RF Tester:Stu Song  
Date: 15.AUG.2024 15:10:16

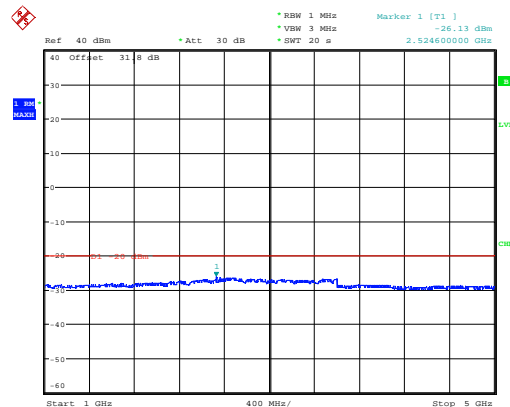

ProjectNo.:2402V63745E-RF Tester:Stu Song  
Date: 15.AUG.2024 15:22:51

### High Channel

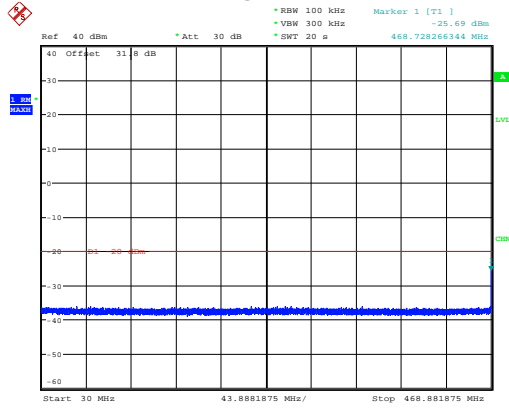

ProjectNo.:2402V63745E-RF Tester:Stu Song  
Date: 15.AUG.2024 15:25:33

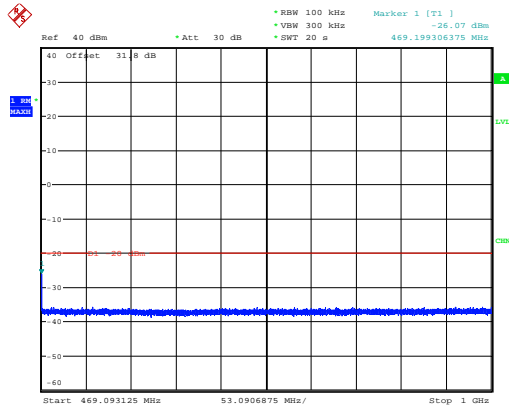

ProjectNo.:2402V63745E-RF Tester:Stu Song  
Date: 15.AUG.2024 15:30:10

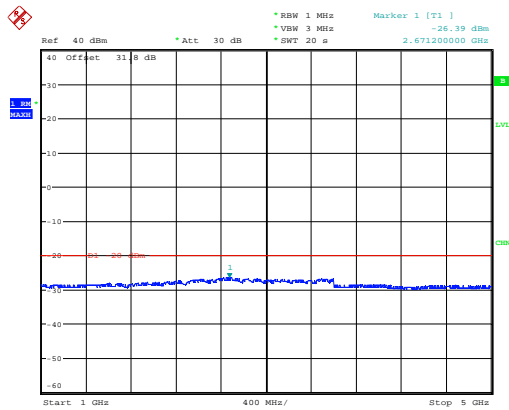

ProjectNo.:2402V63745E-RF Tester:Stu Song  
Date: 15.AUG.2024 15:31:09

GMSK, 12.5kHz:

Low Channel

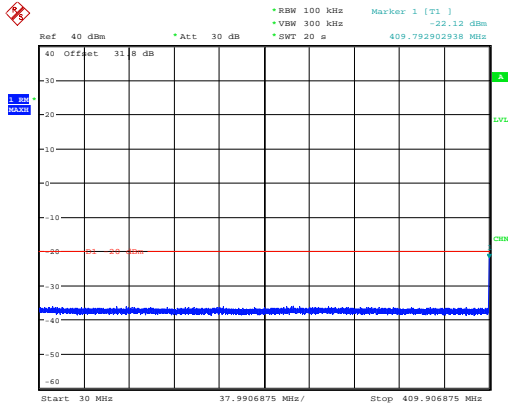

ProjectNo.:2402V63745E-RF Tester:Stu Song  
Date: 15.AUG.2024 15:04:28

Middle Channel

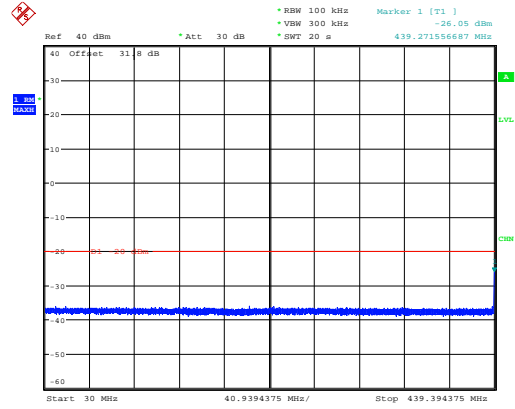

ProjectNo.:2402V63745E-RF Tester:Stu Song  
Date: 15.AUG.2024 15:16:15

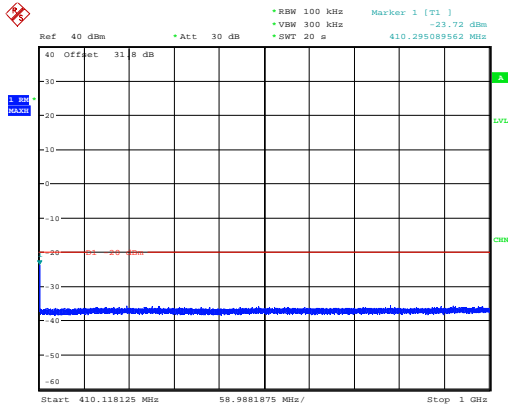

ProjectNo.:2402V63745E-RF Tester:Stu Song  
Date: 15.AUG.2024 15:07:18

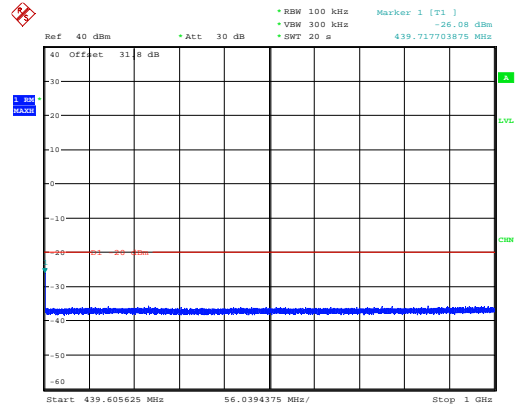

ProjectNo.:2402V63745E-RF Tester:Stu Song  
Date: 15.AUG.2024 15:19:59

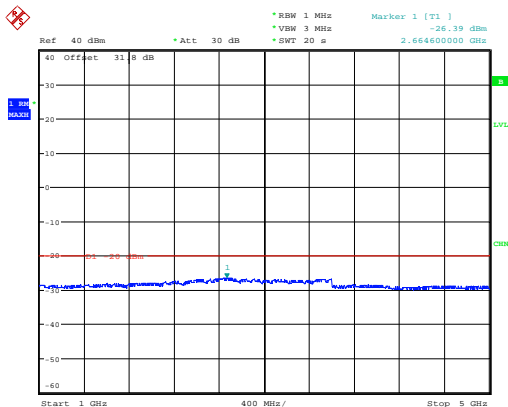

ProjectNo.:2402V63745E-RF Tester:Stu Song  
Date: 15.AUG.2024 15:11:22

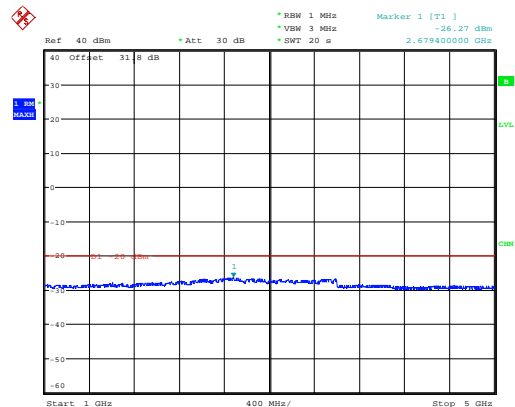

ProjectNo.:2402V63745E-RF Tester:Stu Song  
Date: 15.AUG.2024 15:23:57

### High Channel

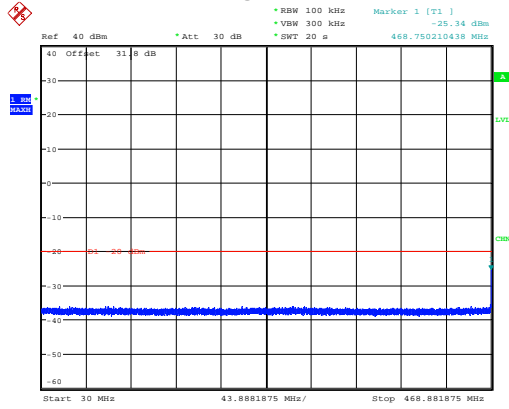

ProjectNo.:2402V63745E-RF Tester:Stu Song  
Date: 15.AUG.2024 15:26:45

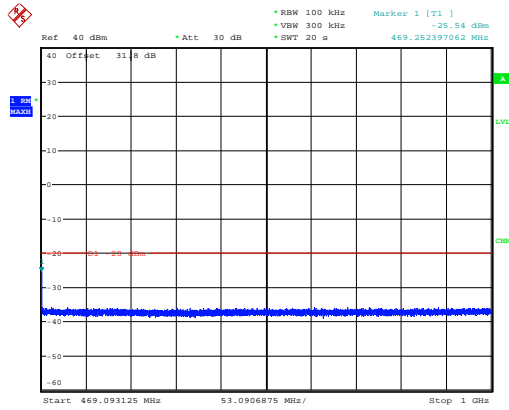

ProjectNo.:2402V63745E-RF Tester:Stu Song  
Date: 15.AUG.2024 15:28:31

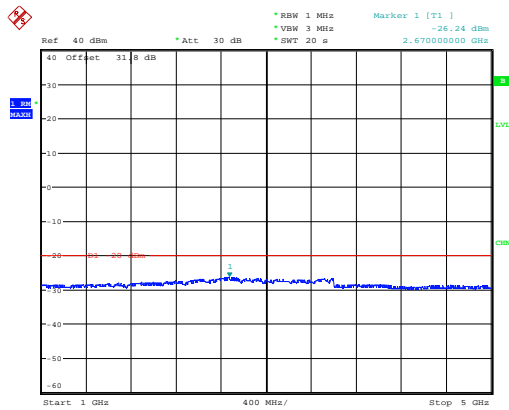

ProjectNo.:2402V63745E-RF Tester:Stu Song  
Date: 15.AUG.2024 15:33:04

### 4.5 Transient Frequency Behavior

#### 4.5.1 Applicable Standard

FCC §90.214

Transmitters designed to operate in the 150-174 MHz and 421-512 MHz frequency bands must maintain transient frequencies within the maximum frequency difference limits during the time intervals indicated:

Time intervals <sup>1 2</sup>	Maximum frequency difference <sup>3</sup>	All equipment	
		150 to 174 MHz	421 to 512 MHz
Transient Frequency Behavior for Equipment Designed to Operate on 12.5 kHz Channels			
t <sub>1</sub> <sup>4</sup>	±12.5 kHz	5.0 ms	10.0 ms
t <sub>2</sub>	±6.25 kHz	20.0 ms	25.0 ms
t <sub>3</sub> <sup>4</sup>	±12.5 kHz	5.0 ms	10.0 ms

#### 4.5.2 EUT Setup Block Diagram

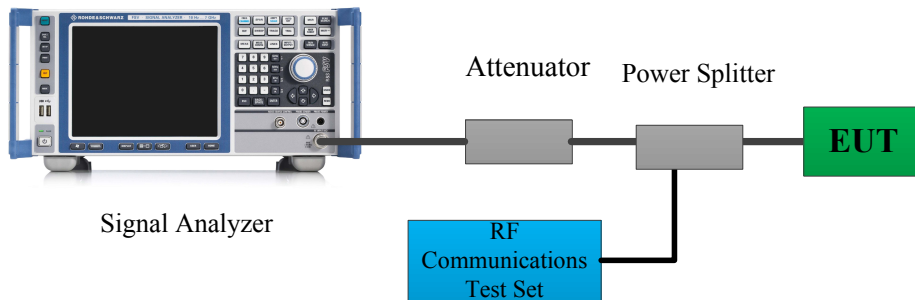

### 4.5.3 Test Procedure

According to ANSI C63.26-2015 Section 6.5.2.2:

- a) Connect the equipment as illustrated.
- b) Connect the output of the transmitter to the signal analyzer with modulation domain analyzer function.
- c) Set the modulation domain analyzer to trigger on the rising edge of the waveform in order to capture a single-shot turn-on of the transmitter signal.
- d) Adjust the display of the modulation domain analyzer for proper viewing of the transmitter transient behavior. Set the timebase reference to the left for observing the transmitter turn-on transient.
- e) Key the transmitter.
- f) Observe the stored display of the modulation domain analyzer. The signal trace shall be maintained within the allowable limits during the periods  $t_1$  and  $t_2$ , and shall also remain within limits following  $t_2$ .
- g) Adjust the modulation domain analyzer to trigger on the falling edge of the transmitter waveform in order to capture a single-shot turn-off transient of the transmitter signal.
- h) Adjust the display of the modulation domain analyzer for proper viewing of the transmitter transient behavior. Set the timebase reference to the right for observing the transmitter turn-off transient.
- i) Unkey the transmitter.
- j) Observe the stored display of the modulation domain analyzer. The signal trace shall be maintained within the allowable limits during the period  $t_3$ .

**4.5.4 Test Data And Result**

Serial Number:	2P3F-1	Test Date:	2024/8/15
Test Site:	RF	Test Mode:	Transmitting
Tester:	Stu Song	Test Result:	Pass

<b>Environmental Conditions:</b>					
Temperature: (°C)	26.5	Relative Humidity: (%)	62	ATM Pressure: (kPa)	100.4

**Test Equipment List and Details:**

Manufacturer	Description	Model	Serial Number	Calibration Date	Calibration Due Date
R&S	Signal Analyzer	FSIQ26	831929/005	2023/11/18	2024/11/17
Unknown	Coaxial Cable	C-NJNJ-50	C-0200-03	2023/9/2	2024/9/1
Huaxiang	Coaxial Attenuator	DTS250-30	11022109	2024/6/7	2025/6/6
HP	RF Communications Test Set	8920A	3438A05201	2023/10/18	2024/10/17

\* Statement of Traceability: Bay Area Compliance Laboratories Corp. (Dongguan) attests that all calibrations have been performed, traceable to National Primary Standards and International System of Units (SI).

**Test Data:**

Note: Test only was performed at high power level.

Channel Spacing (kHz)	Transient Period (ms)	Transient Frequency	Result
12.5	10(t <sub>1</sub> )	±12.5 kHz	Pass
	25(t <sub>2</sub> )	±6.25 kHz	
	10(t <sub>3</sub> )	±12.5 kHz	

Note: During the time from the end of t2 to the beginning of t3, the frequency difference must not exceed the limits specified in §90.213:

For 439.5 MHz 12.5kHz mode, limit is: 439.5 MHz\* 2.5ppm = 1.1kHz

**Tune ON**

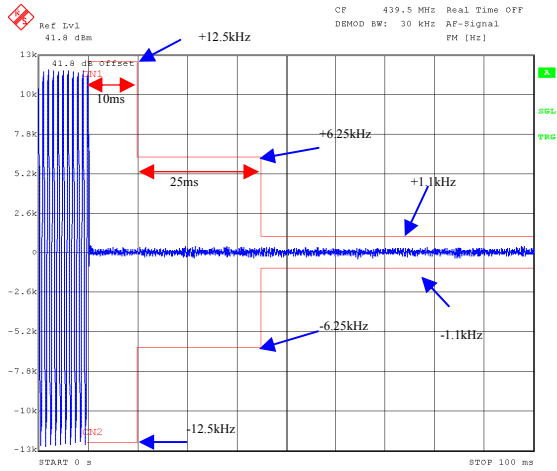

Comment A: ProjectNo.:2402V63745E-RF Tester:Stu Song  
Date: 15.AUG.2024 15:48:16

**Tune OFF**

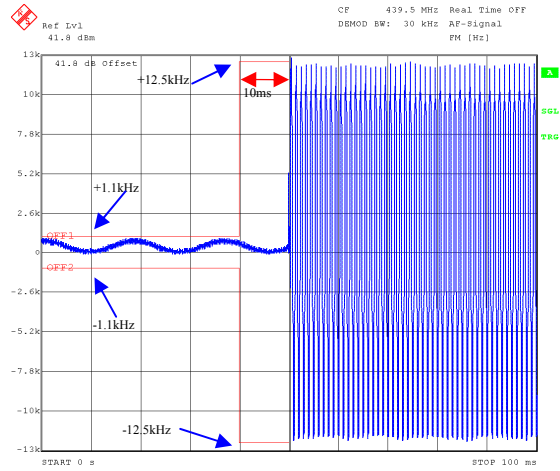

Comment A: ProjectNo.:2402V63745E-RF Tester:Stu Song  
Date: 15.AUG.2024 15:49:48



## 4.6 Modulation characteristics.

### 4.6.1 Applicable Standard

FCC §2.1047

(a) Voice modulated communication equipment. A curve or equivalent data showing the frequency response of the audio modulating circuit over a range of 100 to 5000 Hz shall be submitted. For equipment required to have an audio low-pass filter, a curve showing the frequency response of the filter, or of all circuitry installed between the modulation limiter and the modulated stage shall be submitted.

(b) Equipment which employs modulation limiting. A curve or family of curves showing the percentage of modulation versus the modulation input voltage shall be supplied. The information submitted shall be sufficient to show modulation limiting capability throughout the range of modulating frequencies and input modulating signal levels employed.

(c) Single sideband and independent sideband radiotelephone transmitters which employ a device or circuit to limit peak envelope power. A curve showing the peak envelope power output versus the modulation input voltage shall be supplied. The modulating signals shall be the same in frequency as specified in paragraph (c) of §2.1049 for the occupied bandwidth tests.

(d) Other types of equipment. A curve or equivalent data which shows that the equipment will meet the modulation requirements of the rules under which the equipment is to be licensed.

### 4.6.2 Test Procedure

According to ANSI C63.26-2015 Section 5.3.2:

Modulation limiting test methodology

Modulation limiting is the ability of a transmitter circuit to limit the transmitter from producing deviations in excess of a rated system deviation.

- a) Connect the equipment as illustrated in Figure 1.
- b) Adjust the transmitter per the manufacturer's procedure for full rated system deviation.
- c) Set the test receiver to measure peak positive deviation. Set the audio bandwidth for  $\leq 0.25$  Hz to  $\geq 15000$  Hz. Turn the de-emphasis function off.
- d) Apply a 1000 Hz modulating signal to the transmitter from the audio frequency generator, and adjust the level to obtain 60% of full rated system deviation. This is the 0 dB reference level.
- e) Increase the level from the audio generator by 20 dB in 5 dB increments recording the deviation as measured from the test receiver in each step. Verify that the audio level used to make the OBW measurement is included in the sweep.
- f) Repeat for step e) at 300 Hz, 2500 Hz and 3000 Hz at a minimum using the 0 dB reference level obtained in step d).
- g) Set the test receiver to measure peak negative deviation and repeat step d) through step f).
- h) The values recorded in step f) and step g) are the modulation limiting.
- i) Plot the data set as a percentage of deviation relative to the 0 dB reference point versus input voltage.

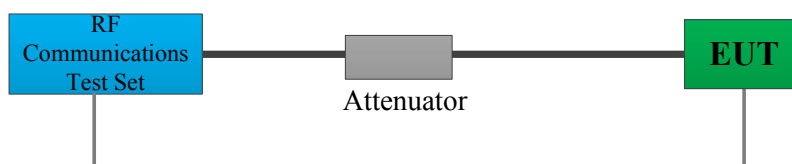

According to ANSI C63.26-2015 Section 5.3.3:

#### Audio frequency response test methodology—Constant Input

- Connect the equipment as illustrated in Figure 3.
- Set the test receiver to measure peak positive deviation. Set the audio bandwidth for  $\leq 50$  Hz to  $\geq 15\ 000$  Hz. Turn the de-emphasis function off.
- Adjust the transmitter per the manufacturer's procedure for full rated system deviation.
- Apply a 1000 Hz tone and adjust the audio frequency generator to produce 20% of the rated system deviation.
- Set the test receiver to measure rms deviation and record the deviation reading as DEVREF.
- Set the audio frequency generator to the desired test frequency between 300 Hz and 3000 Hz.

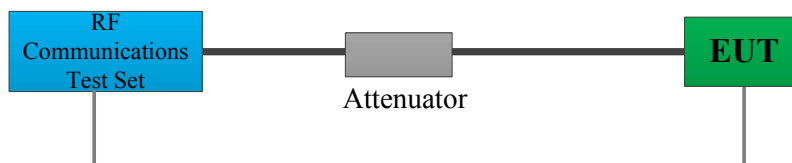

According to ANSI/TIA 603-E-2016 Section 2.2.15:

#### Audio Low Pass Filter Response

- Connect the equipment as illustrated.
- Connect the Audio Generator as close as possible the input of the post limiter low pass filter within the transmitter under test.
- Connect the RF Communications Test Set to the output of the post limiter low pass filter within the transmitter under test.
- Apply a 1000 Hz tone from the audio frequency generator and adjust the level per manufacturer's specifications.
- Record the dB level of the 1000 Hz spectral line on the RF Communications Test Set as  $LEV_{REF}$ .
- Set the audio frequency generator to the desired test frequency between 3000 Hz and the upper low pass filter limit.
- Record RF Communications Test Set levels, at the test frequency in step f).
- Record the dB level on the RF Communications Test Set as  $LEV_{REQ}$ .

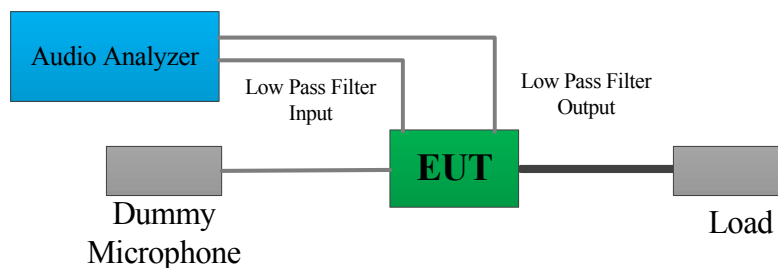

**4.6.3 Test Data And Result**

Serial Number:	2P3F-1	Test Date:	2024/8/15
Test Site:	RF	Test Mode:	Transmitting
Tester:	Stu Song	Test Result:	Pass

<b>Environmental Conditions:</b>					
Temperature: (°C)	26.5	Relative Humidity: (%)	62	ATM Pressure: (kPa)	100.4

**Test Equipment List and Details:**

Manufacturer	Description	Model	Serial Number	Calibration Date	Calibration Due Date
Unknown	Coaxial Cable	C-NJNJ-50	C-0200-03	2023/9/2	2024/9/1
Huaxiang	Coaxial Attenuator	DTS250-30	11022109	2024/6/7	2025/6/6
HP	RF Communications Test Set	8920A	3438A05201	2023/10/18	2024/10/17
R&S	Audio Analyzer	UPV	103447	2023/10/18	2024/10/17

*\* Statement of Traceability: Bay Area Compliance Laboratories Corp. (Dongguan) attests that all calibrations have been performed, traceable to National Primary Standards and International System of Units (SI).*

**Test Data:**

**Audio Frequency Response – High Power**

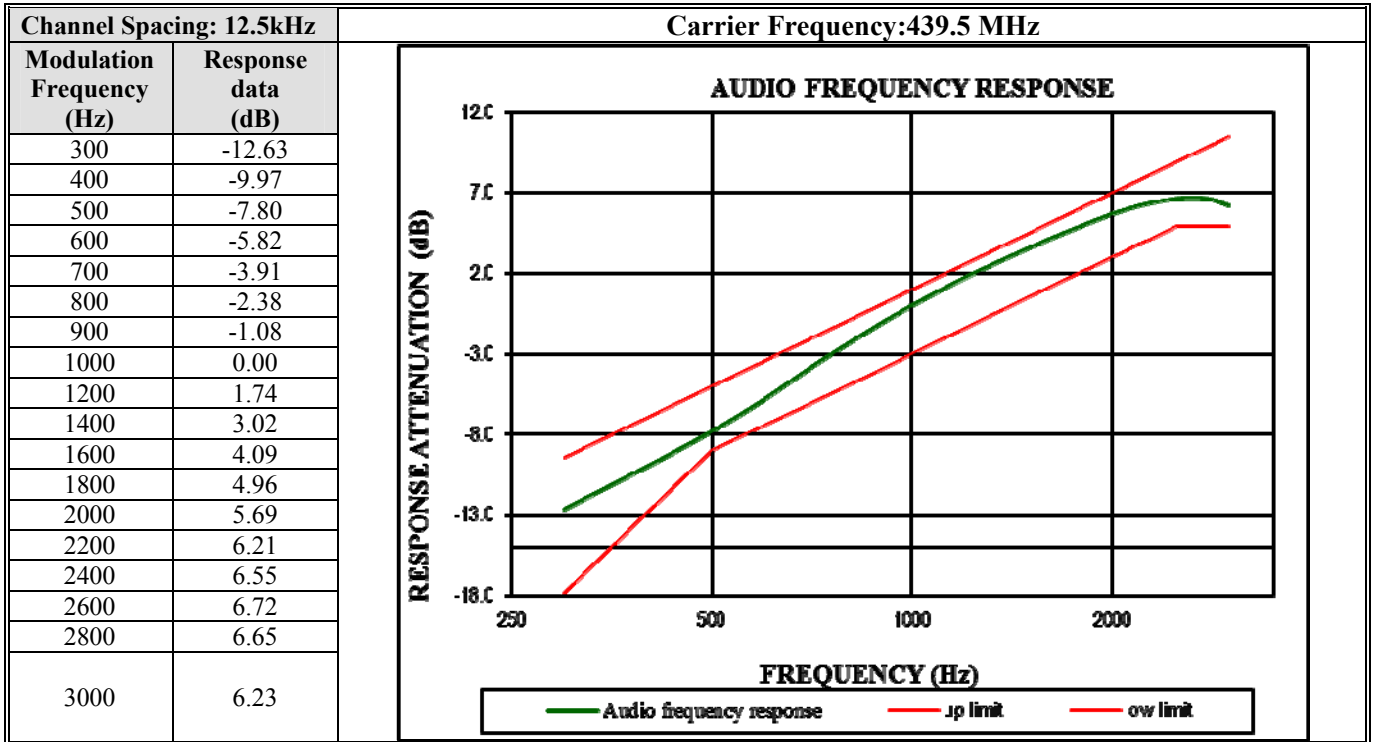

**Audio Frequency Low Pass Filter Response – High Power**

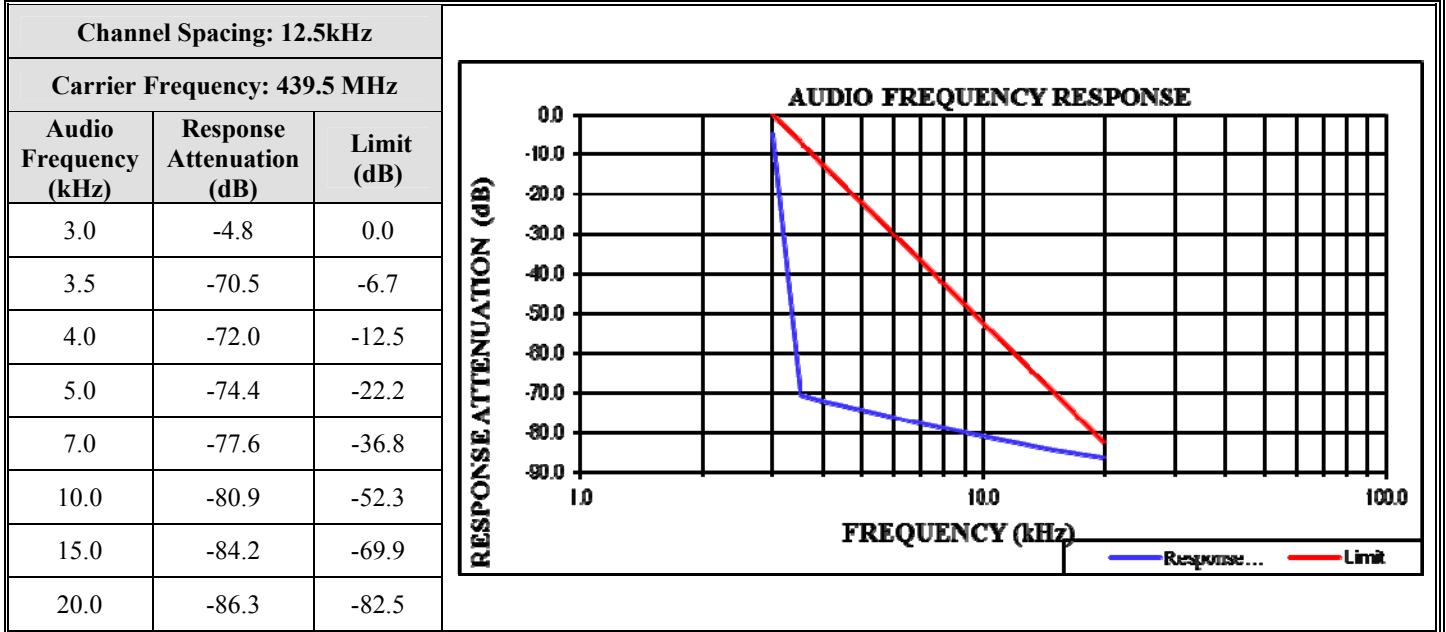

**Modulation Limiting – High Power**

Carrier Frequency: 439.5 MHz, Channel Spacing:12.5kHz											
Audio Frequency(Hz)	DEVIATION (@+0dB)		DEVIATION (@+5dB)		DEVIATION (@+10dB)		DEVIATION (@+15dB)		DEVIATION (@+20dB)		Limit [kHz]
	[kHz]		[kHz]		[kHz]		[kHz]		kHz]		
	Peak Positive	Peak Negative	Peak Positive	Peak Negative	Peak Positive	Peak Negative	Peak Positive	Peak Negative	Peak Positive	Peak Negative	
300	0.476	0.468	0.625	0.624	1.042	0.881	1.474	1.378	1.973	2.096	2.500
1000	1.500	1.500	1.673	1.687	1.647	1.675	1.784	1.831	1.915	1.782	2.500
2500	1.709	1.774	1.780	1.839	1.865	1.854	1.826	1.950	2.179	2.002	2.500
3000	1.861	1.877	1.946	1.948	2.049	2.002	2.037	2.041	2.058	2.081	2.500

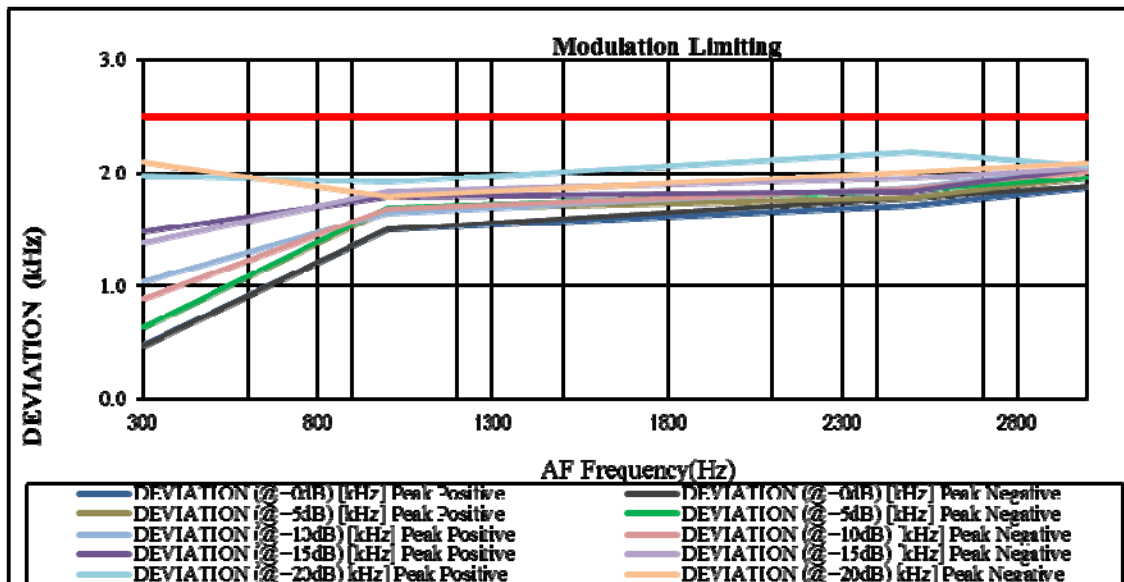

## 4.7 Transmitter Unwanted Emissions(Radiated)

### 4.7.1 Applicable Standard

FCC §90.210

Emission Mask D—12.5 kHz channel bandwidth equipment. For transmitters designed to operate with a 12.5 kHz channel bandwidth, any emission must be attenuated below the power (P) of the highest emission contained within the authorized bandwidth as follows:

- (1) On any frequency from the center of the authorized bandwidth  $f_0$  to 5.625 kHz removed from  $f_0$ : Zero dB.
- (2) On any frequency removed from the center of the authorized bandwidth by a displacement frequency ( $f_d$  in kHz) of more than 5.625 kHz but no more than 12.5 kHz: At least  $7.27(f_d - 2.88 \text{ kHz})$  dB.
- (3) On any frequency removed from the center of the authorized bandwidth by a displacement frequency ( $f_d$  in kHz) of more than 12.5 kHz: At least  $50 + 10 \log(P)$  dB or 70 dB, whichever is the lesser attenuation.
- (4) The reference level for showing compliance with the emission mask shall be established using a resolution bandwidth sufficiently wide (usually two or three times the channel bandwidth) to capture the true peak emission of the equipment under test. In order to show compliance with the emission mask up to and including 50 kHz removed from the edge of the authorized bandwidth, adjust the resolution bandwidth to 100 Hz with the measuring instrument in a peak hold mode. A sufficient number of sweeps must be measured to insure that the emission profile is developed. If video filtering is used, its bandwidth must not be less than the instrument resolution bandwidth. For emissions beyond 50 kHz from the edge of the authorized bandwidth, see paragraph (o) of this section. If it can be shown that use of the above instrumentation settings do not accurately represent the true interference potential of the equipment under test, an alternate procedure may be used provided prior Commission approval is obtained.

4.7.2 Test setup:

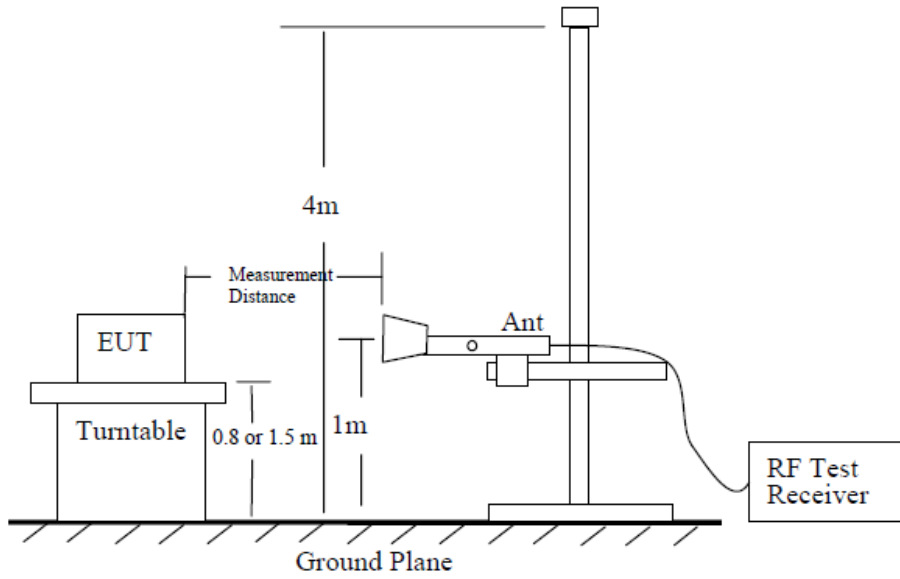

Figure 6—Test site-up for radiated ERP and/or EIRP measurements

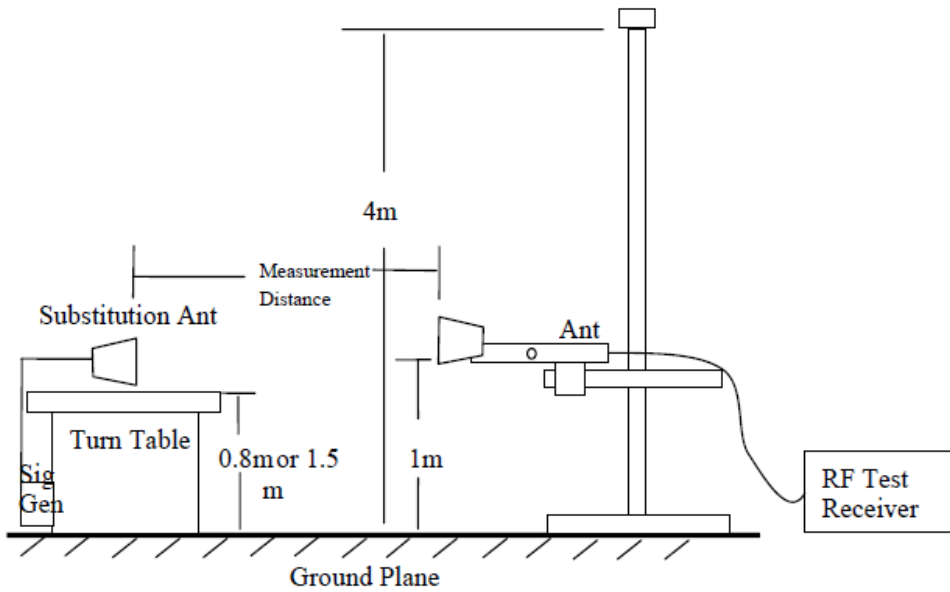

Figure 7—Substitution method set-up for radiated emission



### 4.7.3 Test Procedure:

- a) Place the EUT in the center of the turntable. The EUT shall be configured to transmit into the standard non-radiating load (for measuring radiated spurious emissions), connected with cables of minimal length unless specified otherwise. If the EUT uses an adjustable antenna, the antenna shall be positioned to the length that produces the worst case emission at the fundamental operating frequency.
- b) Each emission under consideration shall be evaluated:
  - 1) Raise and lower the measurement antenna in accordance 5.5.2, as necessary to enable detection of the maximum emission amplitude relative to measurement antenna height.
  - 2) Rotate the EUT through 360° to determine the maximum emission level relative to the axial position.
  - 3) Return the turntable to the azimuth where the highest emission amplitude level was observed.
  - 4) Vary the measurement antenna height again through 1 m to 4 m again to find the height associated with the maximum emission amplitude.
  - 5) Record the measured emission amplitude level and frequency using the appropriate RBW.
- c) Repeat step b) for each emission frequency with the measurement antenna oriented in both the horizontal and vertical polarizations to determine the orientation that gives the maximum emissions amplitude.
- d) Set-up the substitution measurement with the reference point of the substitution antenna located as near as possible to where the center of the EUT radiating element was located during the initial EUT measurement.
- e) Maintain the previous measurement instrument settings and test set-up, with the exception that the EUT is removed and replaced by the substitution antenna.
- f) Connect a signal generator to the substitution antenna; locate the signal generator so as to minimize any potential influences on the measurement results. Set the signal generator to the frequency where emissions are detected, and set an output power level such that the radiated signal can be detected by the measurement instrument, with sufficient dynamic range relative to the noise floor.
- g) For each emission that was detected and measured in the initial test [i.e., in step b) and step c)]:
  - 1) Vary the measurement antenna height between 1 m to 4 m to maximize the received (measured) signal amplitude.
  - 2) Adjust the signal generator output power level until the amplitude detected by the measurement instrument equals the amplitude level of the emission previously measured directly in step b) and step c).
  - 3) Record the output power level of the signal generator when equivalence is achieved in step 2).
- h) Repeat step e) through step g) with the measurement antenna oriented in the opposite polarization.
- i) Calculate the emission power in dBm referenced to a half-wave dipole using the following equation:
$$P_e = P_s(\text{dBm}) - \text{cable loss (dB)} + \text{antenna gain (dBd)}$$
where
  - $P_e$  = equivalent emission power in dBm
  - $P_s$  = source (signal generator) power in dBmNOTE—dBd refers to the measured antenna gain in decibels relative to a half-wave dipole.
- j) Correct the antenna gain of the substitution antenna if necessary to reference the emission power to a half-wave dipole. When using measurement antennas with the gain specified in dBi, the equivalent dipole-referenced gain can be determined from:  $\text{gain (dBd)} = \text{gain (dBi)} - 2.15 \text{ dB}$ . If necessary, the antenna gain can be calculated from calibrated antenna factor information
- k) Provide the complete measurement results as a part of the test report.

**4.7.4 Test Data And Result**

Serial Number:	2P3F-1	Test Date:	Below 1GHz:2024/8/5 Above 1GHz : 2024/8/6
Test Site:	Chamber10m, Chamber B	Test Mode:	Transmitting
Tester:	Zoo Zou, Leo Xiao	Test Result:	Pass

<b>Environmental Conditions:</b>					
Temperature: (°C)	26.6~32.2	Relative Humidity: (%)	35~52	ATM Pressure: (kPa)	99.5~100.1

**Test Equipment List and Details:**

Manufacturer	Description	Model	Serial Number	Calibration Date	Calibration Due Date
Below 1GHz					
Sunol Sciences	Hybrid Antenna	JB3	A060611-1	2023/9/6	2026/9/5
Narda	Coaxial Attenuator	779-6dB	04269	2023/9/6	2026/9/5
Unknown	Coaxial Cable	C-NJNJ-50	C-1000-01	2024/8/1	2025/7/31
Unknown	Coaxial Cable	C-NJNJ-50	C-0400-04	2024/8/1	2025/7/31
Unknown	Coaxial Cable	C-NJNJ-50	C-0530-01	2024/8/1	2025/7/31
R&S	EMI Test Receiver	ESCI	100224	2023/8/18	2024/8/17
EMCO	Adjustable Dipole Antenna	3121C	9109-753	N/A	N/A
Micro-Coax	Coaxial Cable	UFA210B	99G1448	2023/9/9	2024/9/8
Agilent	Signal Generator	E8247C	MY43321350	2023/10/18	2024/10/17
E-Microwave	Band Rejection Filter	OBF-ZP-400-470-NF	OE01201051	2024/1/21	2025/1/20
Above 1GHz					
ETS-Lindgren	Horn Antenna	3115	000 527 35	2023/9/7	2026/9/6
AH	Horn Antenna	SAS-571	1177	2023/2/22	2026/2/21
Xinhang Macrowave	Coaxial Cable	XH750A-N/J-SMA/J-10M	20231117004 #0001	2023/11/17	2024/11/16
Micro-Coax	Coaxial Cable	UFA210B	99G1448	2023/9/9	2024/9/8
Agilent	Signal Generator	E8247C	MY43321350	2023/10/18	2024/10/17
AH	Preamplifier	PAM-0118P	469	2023/8/19	2024/8/18
R&S	Spectrum Analyzer	FSV40	101944	2023/10/18	2024/10/17
E-Microwave	Band Rejection Filter	OBF-ZP-400-470-NF	OE01201051	2024/1/21	2025/1/20
Mini-Circuits	High Pass Filter	VHF-1200+	31102	2024/8/1	2025/7/31

\* Statement of Traceability: Bay Area Compliance Laboratories Corp. (Dongguan) attests that all calibrations have been performed, traceable to National Primary Standards and International System of Units (SI).

**Test Data:**

Please refer to the below table.

Test only was performed at high power level.

After pre-scan in the X, Y and Z axes of orientation, the worst case is below:

**30MHz - 5GHz:**

Frequency (MHz)	Polar (H/V)	Receiver Reading (dBµV)	Substituted Method			Absolute Level (dBm)	Part 90	
			Substituted Level (dBm)	Antenna Gain (dBd/dBi)	Cable Loss (dB)		Limit (dBm)	Margin (dB)
<b>FM mode, Channel Spacing: 12.5 kHz, operation frequency: 410.0125 MHz</b>								
820.03	H	65.45	-32.49	0.00	0.49	-32.98	-20.00	12.98
820.03	V	61.50	-33.34	0.00	0.49	-33.83	-20.00	13.83
1230.04	H	75.62	-48.44	7.60	1.12	-41.96	-20.00	21.96
1230.04	V	80.49	-44.61	7.60	1.12	-38.13	-20.00	18.13
1640.05	H	79.46	-45.80	10.38	0.71	-36.13	-20.00	16.13
1640.05	V	76.49	-49.37	10.38	0.71	-39.70	-20.00	19.70
2050.06	H	74.59	-49.90	11.70	1.11	-39.31	-20.00	19.31
2050.06	V	76.39	-48.30	11.70	1.11	-37.71	-20.00	17.71
2460.08	H	66.59	-56.14	12.78	1.26	-44.62	-20.00	24.62
2460.08	V	70.49	-52.32	12.78	1.26	-40.80	-20.00	20.80
2870.09	H	65.29	-55.82	13.66	1.35	-43.51	-20.00	23.51
2870.09	V	61.30	-60.08	13.66	1.35	-47.77	-20.00	27.77
3280.10	H	62.35	-56.90	13.60	1.59	-44.89	-20.00	24.89
3280.10	V	61.49	-57.77	13.60	1.59	-45.76	-20.00	25.76
3690.11	H	57.59	-61.04	14.01	1.80	-48.83	-20.00	28.83
3690.11	V	56.29	-62.32	14.01	1.80	-50.11	-20.00	30.11
4100.13	H	55.24	-62.46	13.70	1.34	-50.10	-20.00	30.10
4100.13	V	53.24	-64.60	13.70	1.34	-52.24	-20.00	32.24
<b>GMSK mode, Channel Spacing: 12.5 kHz, operation frequency: 410.0125 MHz</b>								
820.03	H	67.48	-30.46	0.00	0.49	-30.95	-20.00	10.95
820.03	V	63.57	-31.27	0.00	0.49	-31.76	-20.00	11.76
1230.04	H	74.65	-49.41	7.60	1.12	-42.93	-20.00	22.93
1230.04	V	78.59	-46.51	7.60	1.12	-40.03	-20.00	20.03
1640.05	H	75.62	-49.64	10.38	0.71	-39.97	-20.00	19.97
1640.05	V	73.29	-52.57	10.38	0.71	-42.90	-20.00	22.90
2050.06	H	69.56	-54.93	11.70	1.11	-44.34	-20.00	24.34
2050.06	V	78.95	-45.74	11.70	1.11	-35.15	-20.00	15.15
2460.08	H	66.32	-56.41	12.78	1.26	-44.89	-20.00	24.89
2460.08	V	70.49	-52.32	12.78	1.26	-40.80	-20.00	20.80
2870.09	H	63.29	-57.82	13.66	1.35	-45.51	-20.00	25.51
2870.09	V	62.59	-58.79	13.66	1.35	-46.48	-20.00	26.48
3280.10	H	60.49	-58.76	13.60	1.59	-46.75	-20.00	26.75
3280.10	V	59.48	-59.78	13.60	1.59	-47.77	-20.00	27.77
3690.11	H	56.29	-62.34	14.01	1.80	-50.13	-20.00	30.13
3690.11	V	55.40	-63.21	14.01	1.80	-51.00	-20.00	31.00
4100.13	H	55.28	-62.42	13.70	1.34	-50.06	-20.00	30.06
4100.13	V	52.31	-65.53	13.70	1.34	-53.17	-20.00	33.17

Frequency (MHz)	Polar (H/V)	Receiver Reading (dBμV)	Substituted Method			Absolute Level (dBm)	Part 90	
			Substituted Level (dBm)	Antenna Gain (dBd/dBi)	Cable Loss (dB)		Limit (dBm)	Margin (dB)
<b>FM mode, Channel Spacing: 12.5kHz, operation frequency: 439.5MHz</b>								
879.00	H	64.59	-31.63	0.00	0.51	-32.14	-20.00	12.14
879.00	V	66.59	-26.32	0.00	0.51	-26.83	-20.00	6.83
1318.50	H	70.65	-53.91	8.43	1.19	-46.67	-20.00	26.67
1318.50	V	79.60	-45.80	8.43	1.19	-38.56	-20.00	18.56
1758.00	H	72.59	-51.99	10.97	0.71	-41.73	-20.00	21.73
1758.00	V	71.65	-53.53	10.97	0.71	-43.27	-20.00	23.27
2197.50	H	75.30	-48.06	10.82	1.14	-38.38	-20.00	18.38
2197.50	V	82.59	-40.67	10.82	1.14	-30.99	-20.00	10.99
2637.00	H	70.40	-52.20	13.16	1.29	-40.33	-20.00	20.33
2637.00	V	69.84	-52.99	13.16	1.29	-41.12	-20.00	21.12
3076.50	H	71.26	-48.71	13.39	1.75	-37.07	-20.00	17.07
3076.50	V	70.25	-49.77	13.39	1.75	-38.13	-20.00	18.13
3516.00	H	55.95	-62.79	13.85	1.59	-50.53	-20.00	30.53
3516.00	V	60.35	-58.39	13.85	1.59	-46.13	-20.00	26.13
3955.50	H	60.19	-57.83	13.73	1.48	-45.58	-20.00	25.58
3955.50	V	56.29	-61.72	13.73	1.48	-49.47	-20.00	29.47
4395.00	H	63.27	-54.53	13.90	1.80	-42.43	-20.00	22.43
4395.00	V	64.50	-53.18	13.90	1.80	-41.08	-20.00	21.08
<b>GMSK mode, Channel Spacing:12.5 kHz, operation frequency: 439.5 MHz</b>								
879.00	H	66.49	-29.73	0.00	0.51	-30.24	-20.00	10.24
879.00	V	66.48	-26.43	0.00	0.51	-26.94	-20.00	6.94
1318.50	H	68.59	-55.97	8.43	1.19	-48.73	-20.00	28.73
1318.50	V	79.46	-45.94	8.43	1.19	-38.70	-20.00	18.70
1758.00	H	73.49	-51.09	10.97	0.71	-40.83	-20.00	20.83
1758.00	V	72.49	-52.69	10.97	0.71	-42.43	-20.00	22.43
2197.50	H	75.59	-47.77	10.82	1.14	-38.09	-20.00	18.09
2197.50	V	81.65	-41.61	10.82	1.14	-31.93	-20.00	11.93
2637.00	H	69.50	-53.10	13.16	1.29	-41.23	-20.00	21.23
2637.00	V	68.75	-54.08	13.16	1.29	-42.21	-20.00	22.21
3076.50	H	71.65	-48.32	13.39	1.75	-36.68	-20.00	16.68
3076.50	V	68.97	-51.05	13.39	1.75	-39.41	-20.00	19.41
3516.00	H	55.49	-63.25	13.85	1.59	-50.99	-20.00	30.99
3516.00	V	58.97	-59.77	13.85	1.59	-47.51	-20.00	27.51
3955.50	H	58.96	-59.06	13.73	1.48	-46.81	-20.00	26.81
3955.50	V	53.26	-64.75	13.73	1.48	-52.50	-20.00	32.50
4395.00	H	62.35	-55.45	13.90	1.80	-43.35	-20.00	23.35
4395.00	V	62.40	-55.28	13.90	1.80	-43.18	-20.00	23.18

Frequency (MHz)	Polar (H/V)	Receiver Reading (dBμV)	Substituted Method			Absolute Level (dBm)	Part 90	
			Substituted Level (dBm)	Antenna Gain (dBd/dBi)	Cable Loss (dB)		Limit (dBm)	Margin (dB)
<b>FM mode, Channel Spacing: 12.5 kHz, operation frequency: 468.9875MHz</b>								
937.97	H	66.98	-27.28	0.00	0.51	-27.79	-20.00	7.79
937.97	V	69.12	-22.01	0.00	0.51	-22.52	-20.00	2.52
1406.96	H	81.65	-42.68	9.03	1.21	-34.86	-20.00	14.86
1406.96	V	85.66	-39.24	9.03	1.21	-31.42	-20.00	11.42
1875.95	H	73.59	-50.02	11.63	0.94	-39.33	-20.00	19.33
1875.95	V	74.11	-49.87	11.63	0.94	-39.18	-20.00	19.18
2344.94	H	72.59	-49.80	11.69	1.26	-39.37	-20.00	19.37
2344.94	V	79.98	-42.45	11.69	1.26	-32.02	-20.00	12.02
2813.93	H	66.59	-55.31	13.21	1.36	-43.46	-20.00	23.46
2813.93	V	64.59	-57.52	13.21	1.36	-45.67	-20.00	25.67
3282.91	H	56.29	-62.99	13.60	1.59	-50.98	-20.00	30.98
3282.91	V	60.35	-58.94	13.60	1.59	-46.93	-20.00	26.93
3751.90	H	60.47	-57.47	13.79	1.66	-45.34	-20.00	25.34
3751.90	V	52.37	-65.45	13.79	1.66	-53.32	-20.00	33.32
4220.89	H	57.98	-60.42	13.98	1.43	-47.87	-20.00	27.87
4220.89	V	55.35	-63.03	13.98	1.43	-50.48	-20.00	30.48
4689.88	H	61.47	-56.53	14.38	1.69	-43.84	-20.00	23.84
4689.88	V	58.95	-59.14	14.38	1.69	-46.45	-20.00	26.45
<b>GMSK mode, Channel Spacing: 12.5 kHz, operation frequency: 468.9875MHz</b>								
937.97	H	62.35	-31.91	0.00	0.51	-32.42	-20.00	12.42
937.97	V	69.59	-21.54	0.00	0.51	-22.05	-20.00	2.05
1406.96	H	80.50	-43.83	9.03	1.21	-36.01	-20.00	16.01
1406.96	V	86.29	-38.61	9.03	1.21	-30.79	-20.00	10.79
1875.95	H	74.65	-48.96	11.63	0.94	-38.27	-20.00	18.27
1875.95	V	75.28	-48.70	11.63	0.94	-38.01	-20.00	18.01
2344.94	H	74.49	-47.90	11.69	1.26	-37.47	-20.00	17.47
2344.94	V	81.57	-40.86	11.69	1.26	-30.43	-20.00	10.43
2813.93	H	67.59	-54.31	13.21	1.36	-42.46	-20.00	22.46
2813.93	V	67.40	-54.71	13.21	1.36	-42.86	-20.00	22.86
3282.91	H	60.49	-58.79	13.60	1.59	-46.78	-20.00	26.78
3282.91	V	60.10	-59.19	13.60	1.59	-47.18	-20.00	27.18
3751.90	H	59.26	-58.68	13.79	1.66	-46.55	-20.00	26.55
3751.90	V	53.29	-64.53	13.79	1.66	-52.40	-20.00	32.40
4220.89	H	57.98	-60.42	13.98	1.43	-47.87	-20.00	27.87
4220.89	V	56.49	-61.89	13.98	1.43	-49.34	-20.00	29.34
4689.88	H	61.35	-56.65	14.38	1.69	-43.96	-20.00	23.96
4689.88	V	59.24	-58.85	14.38	1.69	-46.16	-20.00	26.16

Note 1: The unit of antenna gain is dBd for frequency below 1GHz and is dBi for frequency above 1GHz.

Note 2:

Absolute Level = Substituted Level - Cable loss + Antenna Gain

Margin = Limit - Absolute Level

## **EXHIBIT A - EUT PHOTOGRAPHS**

---

Please refer to the attachment 2402V63745E-RF-EXP EUT EXTERNAL PHOTOGRAPHS and 2402V63745E-RF-INP EUT INTERNAL PHOTOGRAPHS.

---

## **EXHIBIT B - TEST SETUP PHOTOGRAPHS**

---

Please refer to the attachment 2402V63745E-RF-00A-TSP TEST SETUP PHOTOGRAPHS.

**\*\*\*\*\* END OF REPORT \*\*\*\*\***