FCC Test Report

Report No.: AGC02294200302FE08

FCC ID : 2AJGM-P51UV

PRODUCT DESIGNATION : TWO WAY RADIO

BRAND NAME : BAOFENG,POFUNG

MODEL NAME : P51UV, P8UV, P9UV, UV-5R, UV-5R EX, UV-5R+PLUS,
UV-5RTP, GT-3, GT-3TP, BF-R3, UV-S9, UV-B2PLUS,
TR-818UV, 5REPLUS, UV-5X, FF-12P, BF-F8GP, BF-F8TD

APPLICANT : PO FUNG ELECTRONIC(HK) INTERNATIOANL GROUP
COMPANY

DATE OF ISSUE : Jun. 19, 2020

STANDARD(S) : FCC Part 15 Rules

REPORT VERSION : V 1.0

Attestation of Global Compliance (Shenzhen) Co., Ltd

CAUTION:

This report shall not be reproduced except in full without the written permission of the test laboratory and shall not be quoted out of context.



Report Revise Record

Report Version	Revise Time	Issued Date	Valid Version	Notes
V1.0	/	Jun. 19, 2020	Valid	Initial Release



TABLE OF CONTENTS

1. VERIFICATION OF COMPLIANCE	4
2. PRODUCT INFORMATION	5
3. IDENTIFICATION OF THE RESPONSIBLE TESTING LOCATION	6
4. SUPPORT EQUIPMENT LIST	7
5. SYSTEM DESCRIPTION	7
6. SUMMARY OF TEST RESULTS	8
7. FCC RADIATED EMISSION TEST	9
7.1. TEST EQUIPMENT OF RADIATED EMISSION	9
7.2. LIMITS OF RADIATED EMISSION TEST	9
7.3 BLOCK DIAGRAM OF RADIATED EMISSION TEST	9
7.4 PROCEDURE OF RADIATED EMISSION TEST	11
7.5 TEST RESULT OF RADIATED EMISSION TEST	12
8. CONDUCTED EMISSION TEST	16
8.1 PROVISIONS APPLICABLE	16
8.2 MEASUREMENT PROCEDURE	16
8.3 TEST SETUP BLOCK DIAGRAM	17
8.4 TEST RESULT	18
9. ANTENNA CONDUCTED POWER FOR RECEIVERS	20
10. SANNING RECEIVERS AND FREQUENCY CONVERTERS USED WITH SANNING RECEIVERS.	23
APPENDIX 1 PHOTOGRAPHS OF TEST SETUP	25



1. VERIFICATION OF COMPLIANCE

Applicant	PO FUNG ELECTRONIC(HK) INTERNATIOANL GROUP COMPANY
Address	3/F FULOK BLDG 131-133 WING LOK ST SHEUNG WAN, Hong Kong
Manufacturer	PO FUNG ELECTRONIC(HK) INTERNATIOANL GROUP COMPANY
Address	3/F FULOK BLDG 131-133 WING LOK ST SHEUNG WAN, Hong Kong
Factory	PO FUNG ELECTRONIC(HK) INTERNATIOANL GROUP COMPANY
Address	3/F FULOK BLDG 131-133 WING LOK ST SHEUNG WAN, Hong Kong
Product	TWO WAY RADIO
Brand Name	BAOFENG,POFUNG
Test Model	P51UV
Serial Model	P8UV, P9UV, UV-5R, UV-5R EX, UV-5R+PLUS, UV-5RTP, GT-3, GT-3TP, BF-R3, UV-S9, UV-B2PLUS, TR-818UV, 5REPLUS, UV-5X, FF-12P, BF-F8GP, BF-F8TD
Difference Description	The same motherboard and specifications, only the shell design differences & models, trademarks are different
Hardware Version	5RTS.V05
Software Version	5RTS.V05
Measurement	ANSI C63.4: 2014
Date of test	Mar. 03, 2019~Jun. 19, 2020
Deviation	No any deviation from the test method.
Condition of Test	Normal

The above equipment was tested by Attestation Of Global Compliance (Shenzhen) Co., Ltd. for compliance with the requirements set forth in the FCC Rules and Regulations Part 15, the measurement procedure according to ANSI C63.4:2014. This said equipment in the configuration described in this report shows the maximum emission levels emanating from equipment are within the compliance requirements. The test results of this report relate only to the tested sample identified in this report.

Prepared By



Calvin Liu
(Project Engineer)

Jun. 19, 2020

Reviewed By

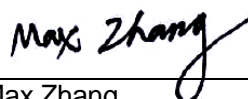

Max Zhang
(Reviewer)

Jun. 19, 2020

Approved By

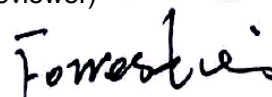

Forrest Lei
(Authorized Officer)

Jun. 19, 2020



2. PRODUCT INFORMATION

The EUT is a **TWO WAY RADIO** designed for voice communication. It is designed by way of utilizing the F3E modulation achieves the system operating.

A major technical description of EUT is described as following:

Communication Type	Voice / Tone only
Modulation	FM
RX Frequency Range	RX:136 MHz -174 MHz, 400MHz -520MHz
Emission Type	F3E
Antenna Designation	Inseparable
Antenna Type	Integral Antenna
Antenna Gain	1.50dBi
Power Supply	DC 7.4V, 3800mAh by battery
Adapter Parameter	Input: AC 100-240V 50/60Hz, 0.25A Output: DC 10V 0.5A
Charger Parameter	Input: DC 10V Output: DC 8.4V 400mA

I/O Port Information (Applicable Not Applicable)

I/O Port of EUT			
I/O Port Type	Q'TY	Cable	Tested with
NA	0	0	0



3. IDENTIFICATION OF THE RESPONSIBLE TESTING LOCATION

Test Site	Attestation of Global Compliance (Shenzhen) Co., Ltd
Location	1-2/F, Building 19, Junfeng Industrial Park, Chongqing Road, Heping Community, Fuhai Street, Bao'an District, Shenzhen, Guangdong, China
Designation Number	CN1259
FCC Test Firm Registration Number	975832
A2LA Cert. No.	5054.02
Description	Attestation of Global Compliance(Shenzhen) Co., Ltd is accredited by A2LA

List Of Test Equipment:

TEST EQUIPMENT OF CONDUCTED EMISSION TEST

Equipment	Manufacturer	Model	S/N	Cal. Date	Cal. Due
TEST RECEIVER	R&S	ESCI	100096	Jul. 12, 2019	Jul. 11, 2020
TEST RECEIVER	R&S	ESCI	100096	Jun. 09, 2020	Jun. 08, 2021
AMN/LISN	R&S	ESH2-Z5	100086	Aug. 22, 2019	Aug. 21, 2020
TEST SOFTWARE	FR	EZ-EMC	AGC-CON03 A	--	--

TEST EQUIPMENT OF RADIATED EMISSION TEST

Equipment	Manufacturer	Model	S/N	Cal. Date	Cal. Due
TEST RECEIVER	R&S	ESPI	101206	Jul. 12, 2019	Jul. 11, 2020
TEST RECEIVER	R&S	ESPI	101206	Jun. 09, 2020	Jun. 08, 2021
ANTENNA	SCHWARZBECK	VULB9168	494	Jan. 09, 2019	Jan. 08, 2021
TEST RECEIVER	R&S	ESCI	100694	June 27, 2019	June 26, 2020
ANTENNA	SCHWARZBECK	VULB9168	D69250	Sep. 20, 2019	Sep. 19, 2020
POSITIONING CONTROLLER	MF	MF-7802	MF780208285	--	--
HORN ANTENNA	ETS LINDGREN	3117	00034609	May. 16, 2019	May. 15, 2021
RF Communication Test Set	HP	8920B	--	Jul. 12, 2019	Jul. 11, 2020
EXA Signal Analyzer	Agilent	N9020A	W1312-60196	Oct. 08, 2019	Oct. 07, 2020
Attenuator	Schaffner	58-30-33	ML030	Oct. 28, 2019	Oct. 27, 2020



4. SUPPORT EQUIPMENT LIST

Device Type	Manufacturer	Model Name	Serial No.	Data Cable	Power Cable
Back clip	--	--	--	--	--
Charger	BAOFENG	CH-5	--	--	--
Adapter	BAOFENG	NA	--	--	0.6m
Lanyard	BAOFENG	NA	--	--	0.1m

5. SYSTEM DESCRIPTION

EUT test procedure:

1. Connect EUT and peripheral devices.
2. Power on the EUT, the EUT begins to work.
3. Make sure the EUT normal working.

EMC TEST MODES

No.	TEST MODES
1	Scanning mode
2	Scanning stopped/Receiving at low channel of 136 MHz -174 MHz
3	Scanning stopped/Receiving at middle channel of 136 MHz -174 MHz
4	Scanning stopped/Receiving at high channel of 136 MHz -174 MHz
5	Scanning stopped/Receiving at low channel of 400 MHz -520 MHz
6	Scanning stopped/Receiving at middle channel of 400 MHz -520 MHz
7	Scanning stopped/Receiving at high channel of 400 MHz -520 MHz

Note: Only the result of the worst case was recorded in the report.



6. SUMMARY OF TEST RESULTS

FCC Rules	Description Of Test	Result
§15.107	Conduction Emission	Compliant
§15.109	Radiated Emission	Compliant
§15.111	Antenna Conducted Power for receivers	Compliant
§15.121(b)	Scanning receivers and frequency converters used with scanning receivers	Compliant



7. FCC RADIATED EMISSION TEST

7.1. TEST EQUIPMENT OF RADIATED EMISSION

7.2. LIMITS OF RADIATED EMISSION TEST

Frequency (MHz)	Distance (m)	Maximum Field Strength Limit (dBuV/m/ Q.P.)
30~88	3	40.0
88~216	3	43.5
216~960	3	46.0
ABOVE 960	3	54.0

Frequency (MHz)	Distance (m)	Maximum Field Strength Limit (dBuV/m/ P.K.)	Maximum Field Strength Limit (dBuV/m/ A.V.)
ABOVE 1G	3	74	54

**Note: The lower limit shall apply at the transition frequency. Because the EUT RX frequency range up to 480 MHz, so the upper the frequency range up to 2 GHz.

7.3 BLOCK DIAGRAM OF RADIATED EMISSION TEST

RADIATED EMISSION TEST SETUP 30MHz-1000MHz

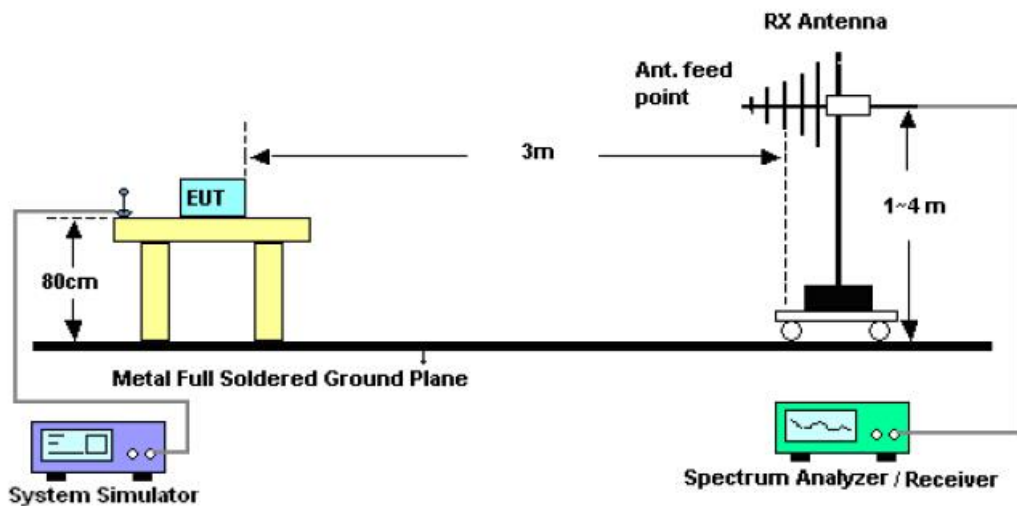

RADIATED EMISSION TEST SETUP ABOVE 1000MHz

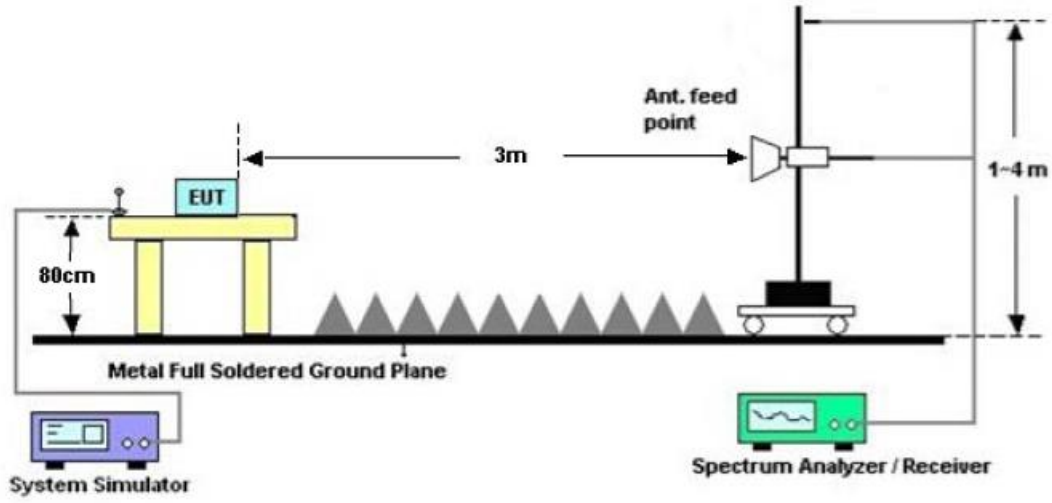

7.4 PROCEDURE OF RADIATED EMISSION TEST

- 1) The equipment was set up as per the test configuration to simulate typical actual usage per the user's manual. When the EUT is a tabletop system, a wooden turntable with a height of 0.8 meters is used which is placed on the ground plane as per ANSI C63.4 (see Test Facility for the dimensions of the ground plane used). When the EUT is floor-standing equipment, it is placed on the ground plane which has a 3-12 mm non-conductive covering to insulate the EUT from the ground plane.
- 2) Support equipment, if needed, was placed as per ANSI C63.4.
- 3) All I/O cables were positioned to simulate typical actual usage as per ANSI C63.4.
- 4) The EUT received power by AC 120V/60Hz.
- 5) The antenna was placed at 3 meter away from the EUT as stated in FCC Part 15. The antenna connected to the Analyzer via a cable and at times a pre-amplifier would be used.
- 6) The Analyzer / Receiver quickly scanned from 30MHz to 1000MHz. The EUT test program was started. Emissions were scanned and measured rotating the EUT to 360 degrees and positioning the antenna 1 to 4 meters above the ground plane, in both the vertical and the horizontal polarization, to maximize the emission reading level.
- 7) The test mode(s) were scanned during the test:
- 8) Recorded at least the six highest emissions. Emission frequency, amplitude, antenna position, polarization and turntable position were recorded into a computer in which correction factors were used to calculate the emission level and compare reading to the applicable limit and Q.P./Peak reading is presented. For emissions below 1GHz, use 120KHz RBW and VBW>=3RBW for QP reading.
- 9) For emissions above 1GHz, use 1MHz RBW and 3MHz VBW for peak reading. Then 1MHz RBW and 10Hz VBW for average reading in spectrum analyzer.
- 10) When the radiated emissions limits are expressed in terms of the average value of the emissions, and pulsed operation is employed, the measurement field strength shall be determined by averaging over one complete pulse train, including blanking intervals, as long as the pulse train does not exceed 0.1 seconds. As an alternative (provided the transmitter operates for longer than 0.1 seconds) or in cases where the pulse train exceeds 0.1 seconds, the measured field strength shall be determined from the average absolute voltage during a 0.1 second interval during which the field strength is at its maximum values.
- 11) If the emissions level of the EUT in peak mode was 3 dB lower than the average limit specified, then testing will be stopped and peak values of EUT will be reported, otherwise, the emissions which do not have 3 dB margin will be repeated one by one using the quasi-peak method for below 1GHz.
- 12) For testing above 1GHz, the emissions level of the EUT in peak mode was lower than average limit (that means the emissions level in peak mode also complies with the limit in average mode), then testing will be stopped and peak values of EUT will be reported, otherwise, the emissions will be measured in average mode again and reported.
- 13) In case the emission is lower than 30MHz, loop antenna has to be used for measurement and the recorded data should be QP measured by receiver. High - Low scan is not required in this case.
- 14) The test data of the worst case condition (mode 1) was reported on the following Data page



7.5 TEST RESULT OF RADIATED EMISSION TEST

Radiated Emission Test –Horizontal -3m Below 1G

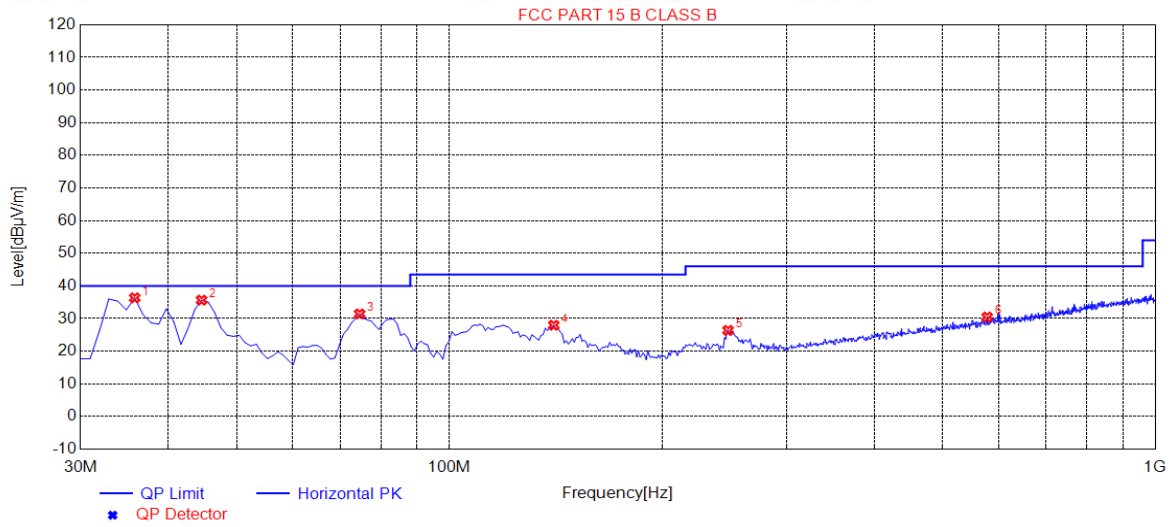

NO.	Freq. [MHz]	Level [dBµV/m]	Factor [dB]	Limit [dBµV/m]	Margin [dB]	Height [cm]	Angle [°]	Polarity
1	35.8200	36.36	13.93	40.00	3.64	100	180	Horizontal
2	44.5500	35.67	14.82	40.00	4.33	100	206	Horizontal
3	74.6200	31.43	11.27	40.00	8.57	100	209	Horizontal
4	140.5800	27.98	14.88	43.50	15.52	100	212	Horizontal
5	248.2500	26.40	14.72	46.00	19.60	100	85	Horizontal
6	578.0500	30.48	23.86	46.00	15.52	100	261	Horizontal

RESULT: PASS



Radiated Emission Test –Vertical -3m Below 1G

FCC PART 15 B CLASS B

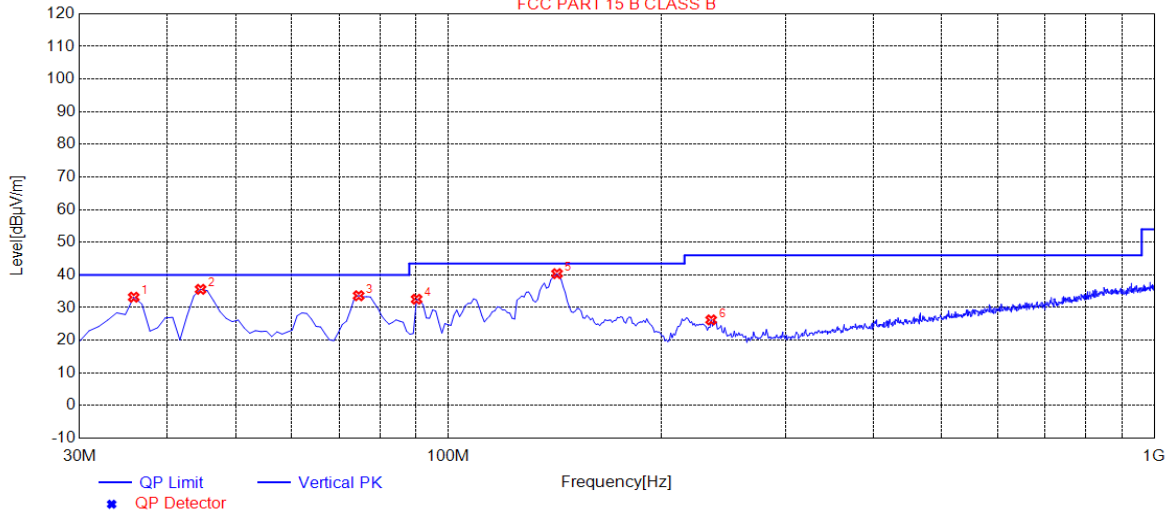

NO.	Freq. [MHz]	Level [dBµV/m]	Factor [dB]	Limit [dBµV/m]	Margin [dB]	Height [cm]	Angle [°]	Polarity
1	35.8200	33.19	13.93	40.00	6.81	100	255	Vertical
2	44.5500	35.60	14.82	40.00	4.40	100	359	Vertical
3	74.6200	33.64	11.27	40.00	6.36	100	174	Vertical
4	90.1400	32.57	10.29	43.50	10.93	100	226	Vertical
5	142.5200	40.40	14.88	43.50	3.10	100	127	Vertical
6	235.6400	26.23	14.48	46.00	19.77	100	157	Vertical



Radiated Emission Test –Horizontal -3m Above 1G

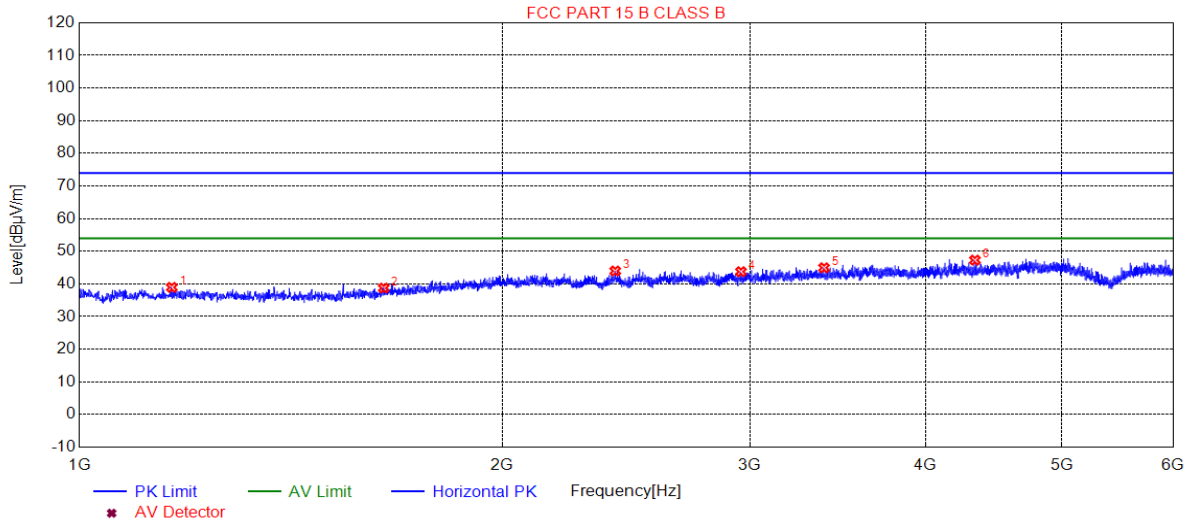

NO.	Freq. [MHz]	Level [dBµV/m]	Factor [dB]	Limit [dBµV/m]	Margin [dB]	Height [cm]	Angle [°]	Polarity
1	1163.5164	38.96	-16.80	74.00	35.04	100	270	Horizontal
2	1646.5647	38.74	-15.57	74.00	35.26	100	240	Horizontal
3	2406.1406	43.97	-10.11	74.00	30.03	100	319	Horizontal
4	2956.6957	43.75	-9.36	74.00	30.25	100	270	Horizontal
5	3387.7388	44.96	-7.99	74.00	29.04	100	82	Horizontal
6	4337.8338	47.30	-5.62	74.00	26.70	100	23	Horizontal



Radiated Emission Test –Vertical -3m Above 1G

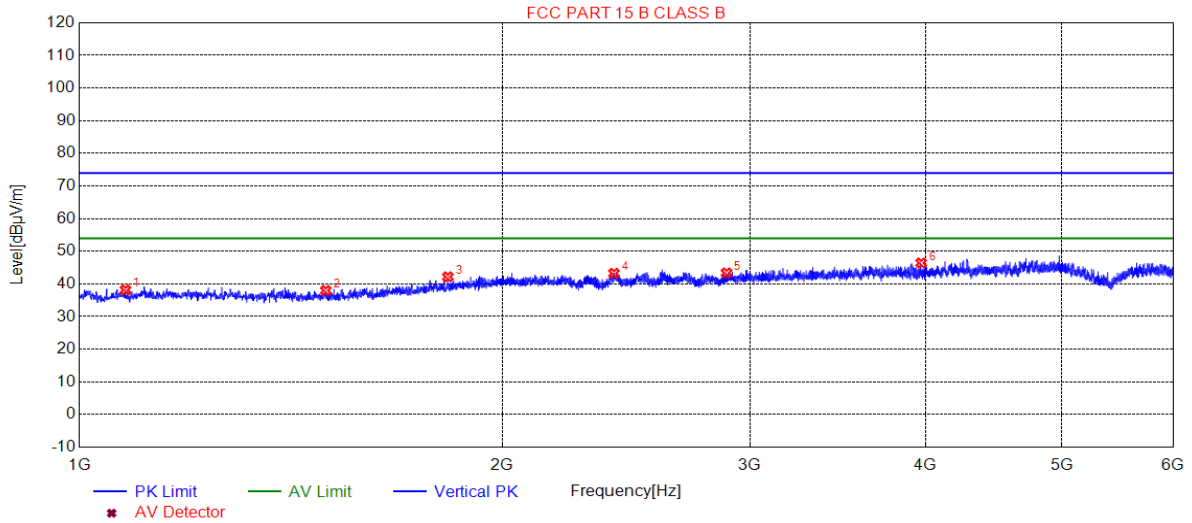

NO.	Freq. [MHz]	Level [dBµV/m]	Factor [dB]	Limit [dBµV/m]	Margin [dB]	Height [cm]	Angle [°]	Polarity
1	1078.5079	38.18	-16.72	74.00	35.82	100	268	Vertical
2	1497.5498	38.01	-17.13	74.00	35.99	100	198	Vertical
3	1829.0829	42.19	-13.64	74.00	31.81	100	327	Vertical
4	2401.1401	43.28	-10.14	74.00	30.72	100	21	Vertical
5	2887.6888	43.38	-9.42	74.00	30.62	100	178	Vertical
6	3972.2972	46.44	-6.56	74.00	27.56	100	41	Vertical

RESULT: PASS

- Note:** 1. Factor=Antenna Factor + Cable loss - Amplifier gain, Margin=Measurement-Limit.
2. The “Factor” value can be calculated automatically by software of measurement system.



8. CONDUCTED EMISSION TEST

8.1 PROVISIONS APPLICABLE

For an intentional radiator that is designed to be connected to the public utility (AC) power line, the, the radio frequency voltage that is conducted back onto the AC power line on any frequencies within the band 150 KHz to 30 MHz shall not exceed the limits in the following table, as measured using a 50uH/50 ohms line impedance stabilization network (LISN). Compliance with the provisions of this paragraph shall be based on the measurement of the radio frequency voltage between each power line and ground at the power terminal. The lower limit applies at the boundary between the frequencies ranges.

Frequency of Emission (MHz)	Conducted Limit(dBuV)	
	Quasi-Peak	Average
0.15 – 0.5	66 to 56 *	56 to 46 *
0.5 – 5	56	46
5 – 30	60	50

* Decreases with the logarithm of the frequency.

8.2 MEASUREMENT PROCEDURE

- (1) The equipment was set up as per the test configuration to simulate typical actual usage per the user's manual. When the EUT is a tabletop system, a wooden table with a height of 0.8 meters is used and is placed on the ground plane as per ANSI C63.4 (see Test Facility for the dimensions of the ground plane used). When the EUT is a floor-standing equipment, it is placed on the ground plane which has a 3-12 mm non-conductive covering to insulate the EUT from the ground plane.
- (2) Support equipment, if needed, was placed as per ANSI C63.4.
- (3) All I/O cables were positioned to simulate typical actual usage as per ANSI C63.4.
- (4) The EUT received AC 120V/60Hz power through a Line Impedance Stabilization Network (LISN) which supplied power source and was grounded to the ground plane.
- (5) All support equipments received AC power from a second LISN, if any.
- (6) The EUT test program was started. Emissions were measured on each current carrying line of the EUT using a spectrum Analyzer / Receiver connected to the LISN powering the EUT. The LISN has two monitoring points: Line 1 (Hot Side) and Line 2 (Neutral Side). Two scans were taken: one with Line 1 connected to Analyzer / Receiver and Line 2 connected to a 50 ohm load; the second scan had Line 1 connected to a 50 ohm load and Line 2 connected to the Analyzer / Receiver.
- (7) Analyzer / Receiver scanned from 150 KHz to 30MHz for emissions in each of the test modes.

During the above scans, the emissions were maximized by cable manipulation.



8.3 TEST SETUP BLOCK DIAGRAM

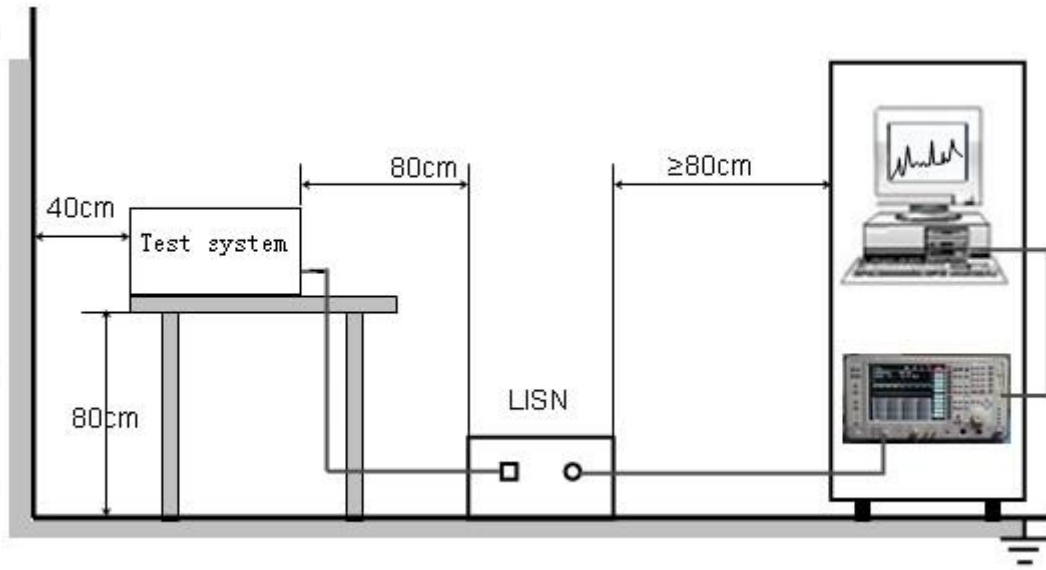

8.4 TEST RESULT

CONDUCTED EMISSION TEST-L

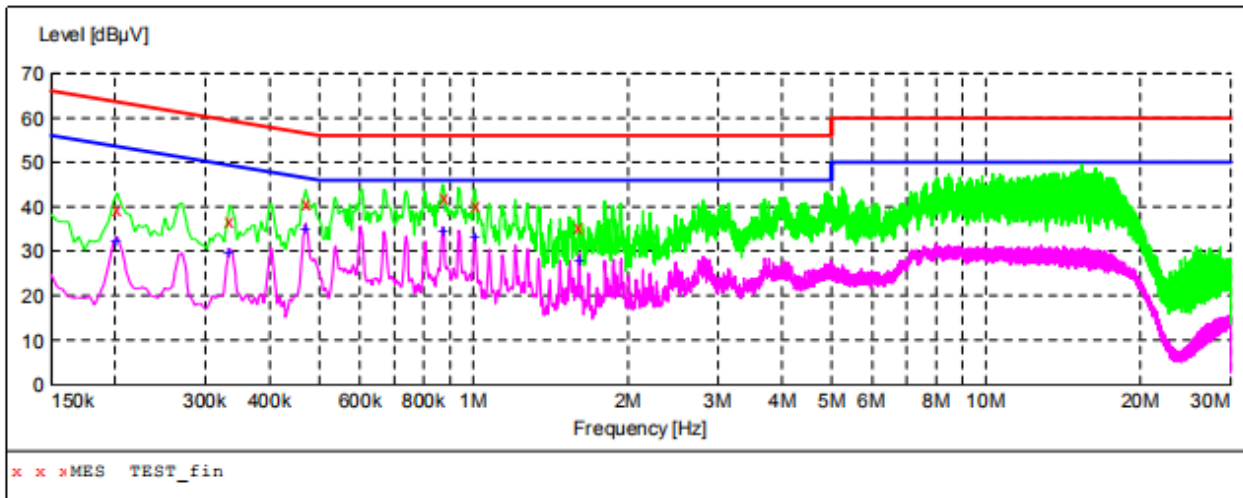

MEASUREMENT RESULT: "TEST_fin"

Frequency MHz	Level dBµV	Transd dB	Limit dBµV	Margin dB	Detector	Line	PE
0.202000	39.70	10.3	64	23.8	QP	L1	FLO
0.334000	36.60	10.2	59	22.8	QP	L1	FLO
0.470000	40.70	10.3	57	15.8	QP	L1	FLO
0.870000	42.20	10.4	56	13.8	QP	L1	FLO
1.006000	40.30	10.4	56	15.7	QP	L1	FLO
1.606000	35.30	10.4	56	20.7	QP	L1	FLO

MEASUREMENT RESULT: "TEST_fin2"

Frequency MHz	Level dBµV	Transd dB	Limit dBµV	Margin dB	Detector	Line	PE
0.202000	32.40	10.3	54	21.1	AV	L1	FLO
0.334000	29.60	10.2	49	19.8	AV	L1	FLO
0.470000	35.20	10.3	47	11.3	AV	L1	FLO
0.870000	34.70	10.4	46	11.3	AV	L1	FLO
1.006000	33.10	10.4	46	12.9	AV	L1	FLO
1.606000	27.80	10.4	46	18.2	AV	L1	FLO

RESULT: PASS



CONDUCTED EMISSION TEST-N

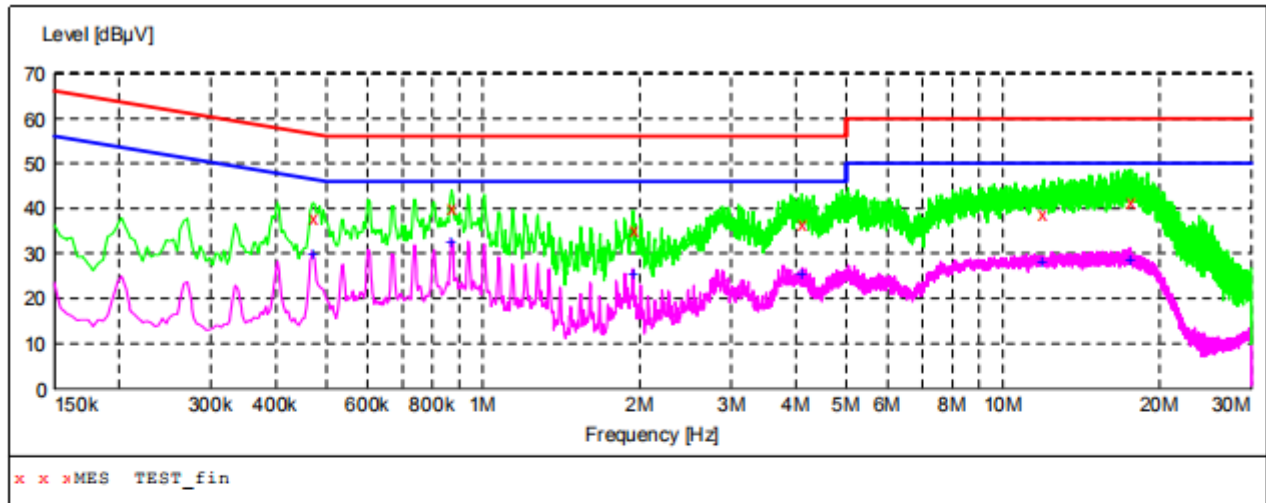

MEASUREMENT RESULT: "TEST_fin"

Frequency MHz	Level dBµV	Transd dB	Limit dBµV	Margin dB	Detector	Line	PE
0.470000	38.10	10.3	57	18.4	QP	N	FLO
0.870000	40.20	10.4	56	15.8	QP	N	FLO
1.946000	35.30	10.4	56	20.7	QP	N	FLO
4.102000	36.50	10.4	56	19.5	QP	N	FLO
11.954000	38.70	10.8	60	21.3	QP	N	FLO
17.622000	41.30	11.0	60	18.7	QP	N	FLO

MEASUREMENT RESULT: "TEST_fin2"

Frequency MHz	Level dBµV	Transd dB	Limit dBµV	Margin dB	Detector	Line	PE
0.470000	29.70	10.3	47	16.8	AV	N	FLO
0.870000	32.40	10.4	46	13.6	AV	N	FLO
1.946000	25.50	10.4	46	20.5	AV	N	FLO
4.102000	25.30	10.4	46	20.7	AV	N	FLO
11.954000	28.10	10.8	50	21.9	AV	N	FLO
17.622000	28.90	11.0	50	21.1	AV	N	FLO

RESULT: PASS



9. ANTENNA CONDUCTED POWER FOR RECEIVERS

LIMIT

The antenna conducted power of the receiver as defined in §15.111 shall not exceed the values given in the following tables

Frequency Range	9 KHz to 2GHz
Limit	2.0 nW (-57 dBm)

TEST CONFIGURATION

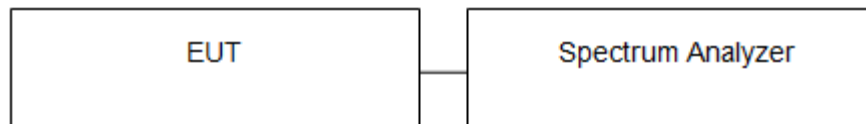

TEST PROCEDURE

1. The receiver antenna terminal connected to a spectrum analyzer.
2. The test data of the worst case condition (mode 1) was reported on the following Data page.

TEST RESULTS

Conducted Measurement (9 KHz to 150 KHz)

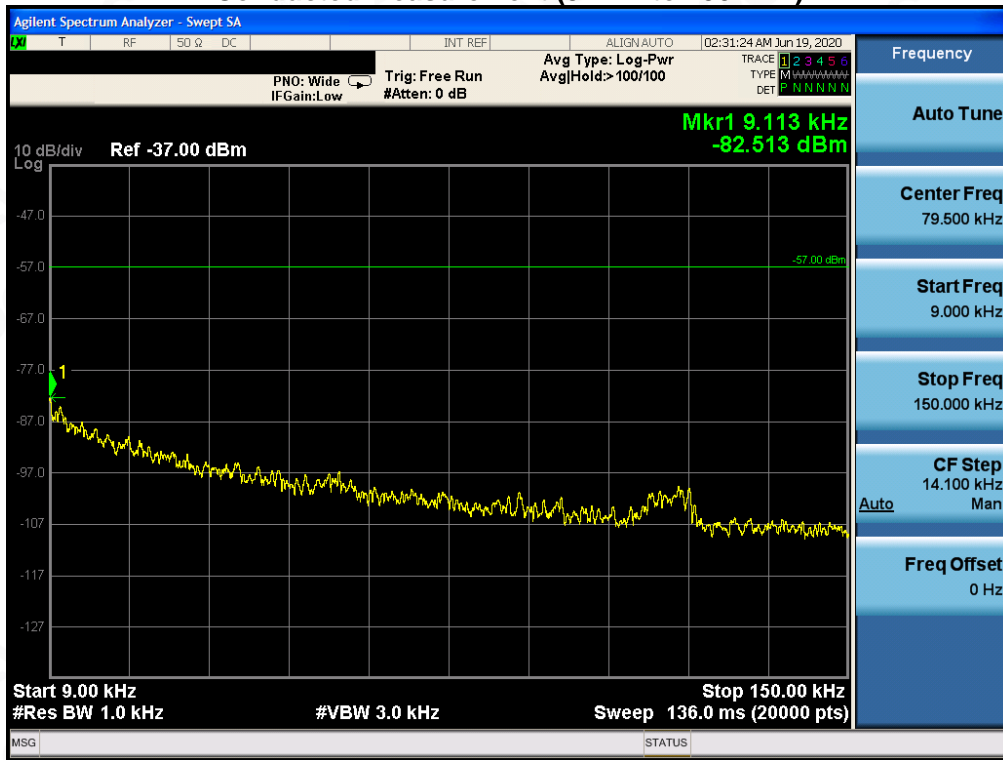

Conducted Measurement (150 KHz to 30MHz)

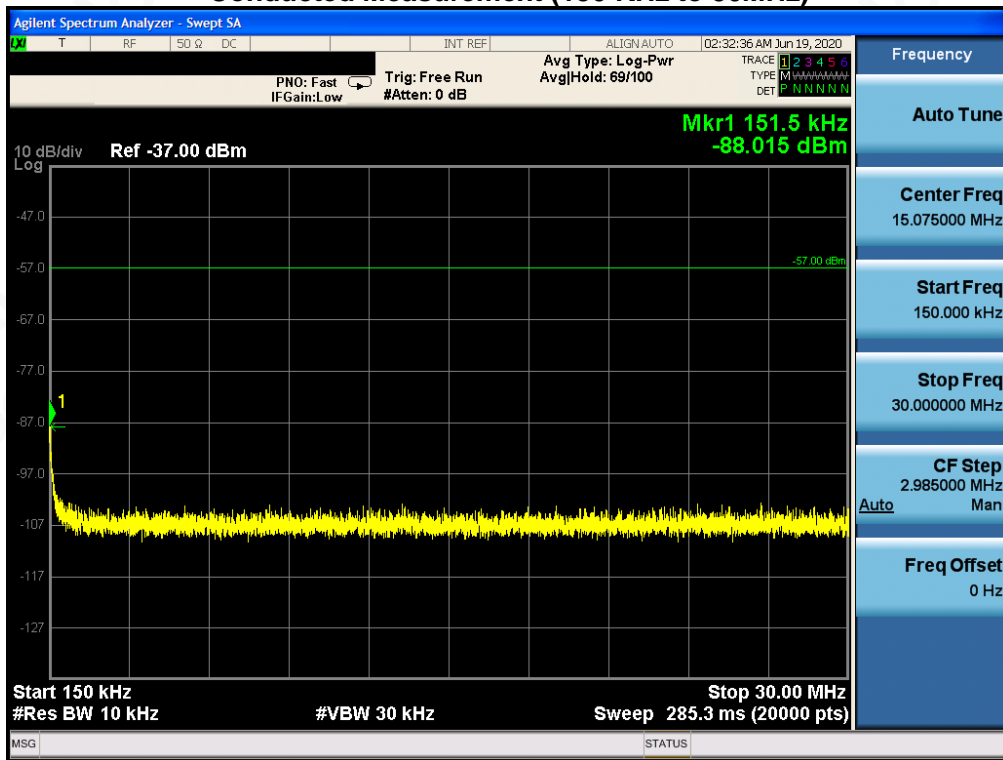

Conducted Measurement (30MHz to 1GHz)

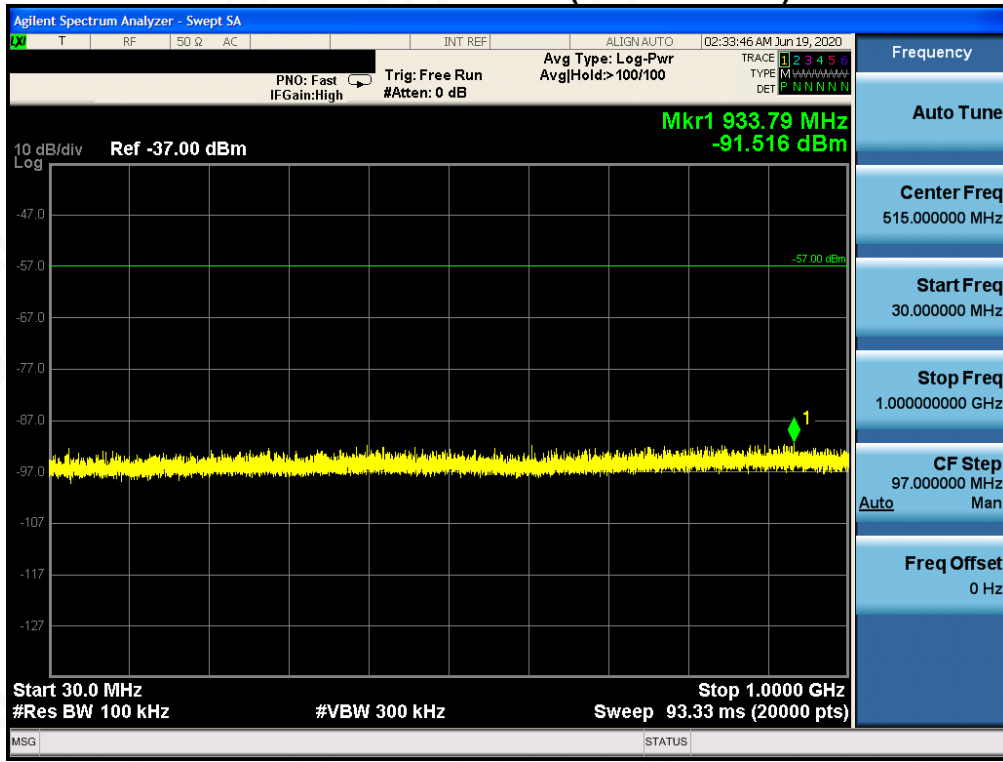

Conducted Measurement (1GHz to 2GHz)

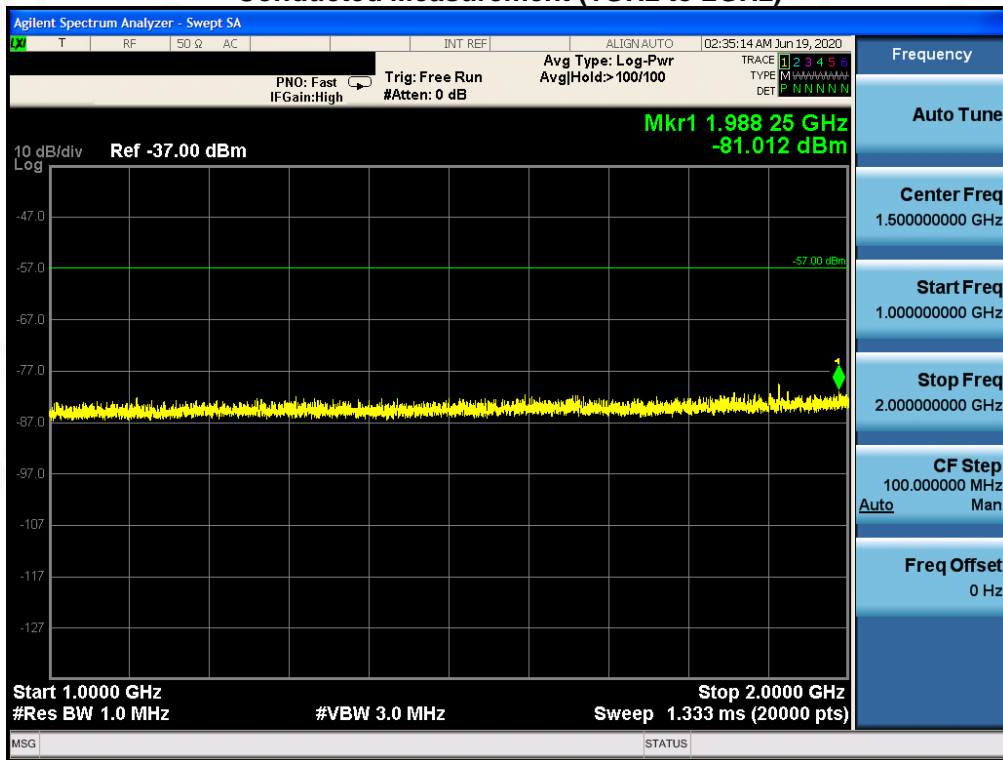

PASS



10. SANNING RECEIVERS AND FREQUENCY CONVERTERS USED WITH SANNING RECEIVERS.

LIMIT

Except as provided in paragraph (c) of this section, scanning receivers shall reject any signals from the Cellular Radiotelephone Service frequency bands that are 38 dB or lower based upon a 12 dB SINAD measurement, which is considered the threshold where a signal can be clearly discerned from any interference that may be present.

TEST CONFIGURATION

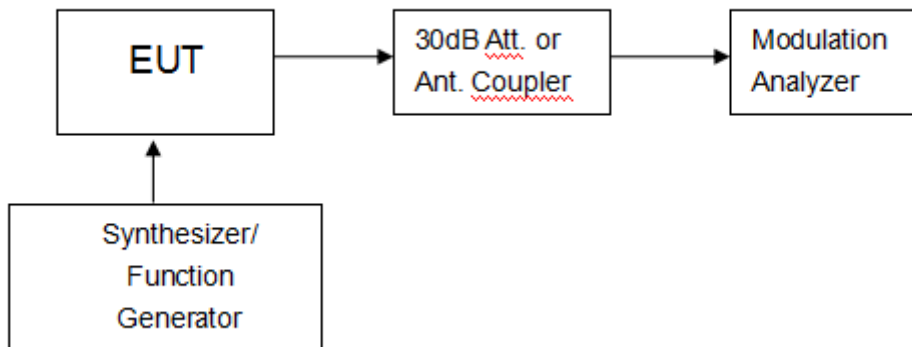

TEST PROCEDURE

Please review the FCC Part 15.121 b section requirements to meet the testing process

TEST RESULTS

VHF:

Frequency Range(MHz)	Channel	Measurement Result (dB)	Limit(dB)	Result
136-174	Bottom	45	> 38	Pass
136-174	Middle	48	> 38	Pass
136-174	Top	44	> 38	Pass



UHF:

Frequency Range(MHz)	Channel	Measurement Result (dB)	Limit(dB)	Result
400-520	Bottom	45	> 38	Pass
400-520	Middle	43	> 38	Pass
400-520	Top	46	> 38	Pass

Note:1.This device meets the requirements of FCC PART 15.121.b
2.The test report only shows the worst test results



APPENDIX 1 PHOTOGRAPHS OF TEST SETUP CONDUCTED EMISSION TEST SETUP



RADIATED EMISSION TEST SETUP-BELOW 1GHZ

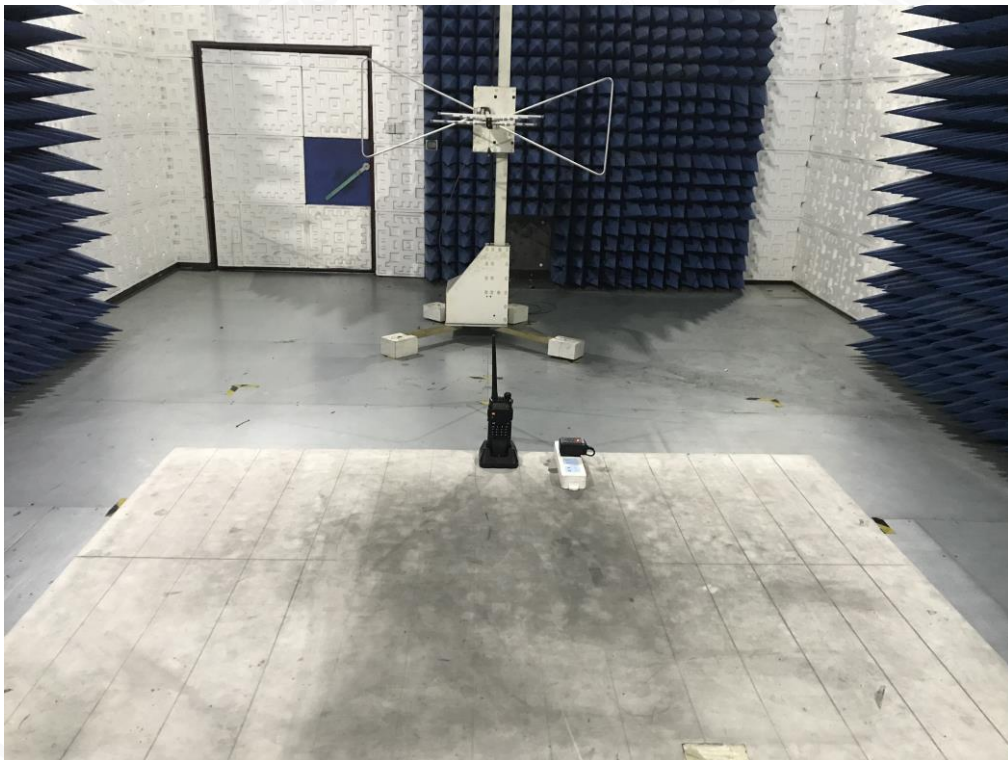

RADIATED EMISSION TEST SETUP-ABOVE 1GHZ

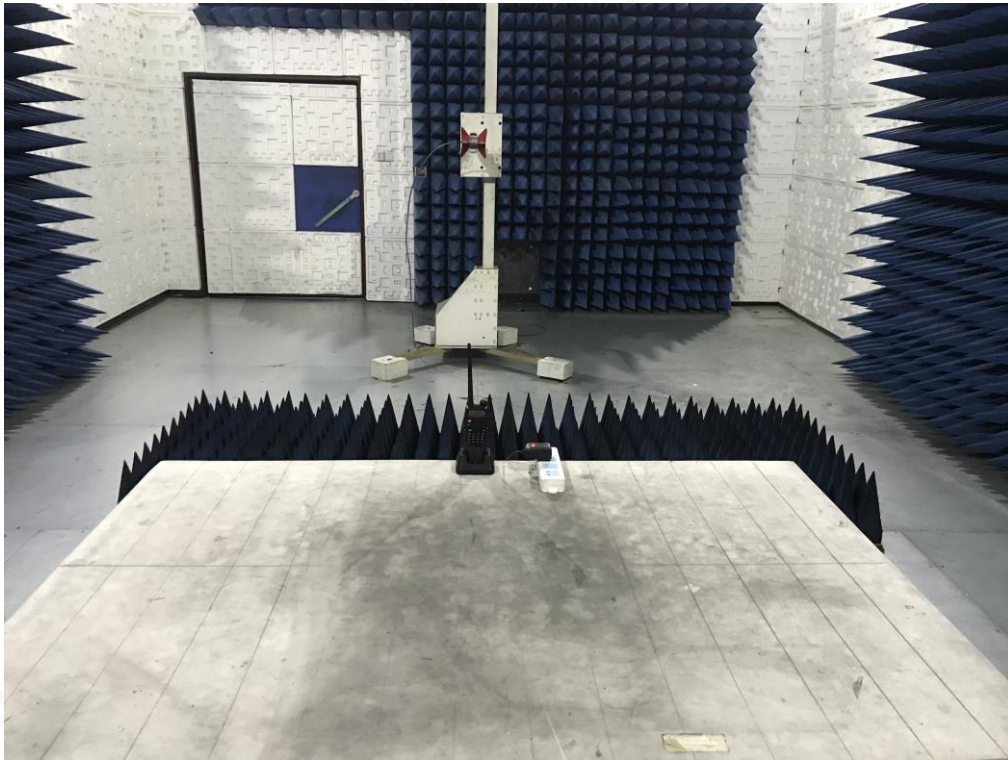

----END OF REPORT----

