

PREFACE

Thank you for purchasing P11UV Two Way Radio, It is a multitask GMRS transceiver. Combining the latest technology in radio communication along with a sturdy mechanical frame, P11UV is the ideal and effective solution for the professionals who need to stay in touch with the working team (in construction sites, buildings, shows, trade fairs or hotels) or for leisure users that just want to keep up with friends and family.

This manual is applicable to the following product: P11UV,BF-UV11, GM-50, TH-88, AR-11X, UV11R and G-11UV Two Way Radios.

IMPORTANT NOTICE:

To help you ward off bodily injury or property loss that may arise from improper operation, please read all the information carefully before using our products. This contains instructions for safe usage and RF energy awareness and control for compliance with applicable standards and regulation.

Safety Information for Pofung Radios

Your wireless handheld portable transceiver contains a low power transmitter. When the talk button is pushed, it sends out radio frequency (RF) signals. The device is authorized to operate at a duty factor not to exceed 50%. In August 1996, the Federal Communications Commissions (FCC) adopted RF exposure guidelines with safety levels for handheld wireless devices.

Table of Contents

1. GETTING STARTED

- 1.1 Regulations and Safety Warnings
- 1.2 Content of the packaging
- 1.3 Main features

2. BATTERY INFORMATION

- 2.1 Charging the Battery Pack
- 2.2 Charger Supplied
- 2.3 Use Caution with the Li-ion Battery
- 2.4 How to Charge
- 2.5 LED Indicator
- 2.6 How to Store the Battery

3. INSTALLATION OF ACCESSORIES

- 3.1 Installing / Removing the Antenna
- 3.2 Installing the belt clip
- 3.3 Installing the battery pack
- 3.4 Additional Speaker/Microphone (Optional)

4. RADIO OVERVIEW

- 4.1 Main controls and parts of the radio
- 4.2 LCD Display

5. BASIC OPERATIONS

- 5.1 Turning your Radio On and Off
- 5.2 Setting the Volume
- 5.3 Choosing a Channel
- 5.4 Talking and Listening

5.5 SCAN

5.6 Monitor

5.7 Keypad lock

5.8 A/B switch

5.9 Flashlight and Emergency Alert

5.10 FM Radio (FM)

5.11 NOAA Weather Radio

5.12 1000Hz, 1450Hz, 1750Hz Tone-burst

6. WORKING THE MENU SYSTEM

6.1 Basic use

6.2 Shortcut Menu operations

6.3 Menu settings

7. ON-LINE SERVICE AND SUPPORT

Appendix A. - Trouble shooting guide

Appendix B. - Technical Specifications

Appendix C. - Shortcut Menu operations

1. GETTING STARTED

1.1 Regulations and Safety Warnings

WARNING! This device complies with Part 15 of the FCC Rules. Operation is subject to the condition that this device does not cause harmful interference.

Important: Any changes or modifications not expressly approved by the party responsible for compliance could void the user's authority to operate this device. Your radio is set up to transmit a regulated signal on an assigned frequency. It is against the law to alter or adjust the settings inside the radio to exceed those limitations. Any adjustments to your radio must be made by qualified technicians.

To be safe and sure:

- Never open your radio's case.
- Never change or replace anything in your radio except the battery.

Your radio might cause TV or radio interference even when it is operating properly. To determine whether your radio is causing the interference, turn it off. If the interference goes away, your radio is causing it. Try to eliminate the interference by moving your radio away from the receiver. If you cannot eliminate the interference, the FCC requires that you stop using the radio.

Hazardous Environments: Do not operate the radio in hazardous environments. Explosion or fire may result.

Do not operate the radio near unshielded electrical blasting caps.

Under certain conditions, radios can interfere with blasting operations and may cause an explosion. Turn your radio OFF to prevent accidental transmission when in a blasting area or in areas posted: "Turn off two-way radio." Construction crews often use remote control RF devices to set off explosives.

Care and Safety: To clean the radio, use a soft cloth dampened with water. Do not use cleaners or solvents because they can harm the body of the unit and leak inside, causing permanent damage. Use a dry, lint-free cloth to clean the battery contacts.

RF Exposure Information

WARNING! Read this information before using the radio. In August 1996 the Federal Communications Commission (FCC) of the United States with its action in Report and Order FCC 96-326 adopted an updated safety standard for human exposure to radio frequency electromagnetic energy emitted by FCC regulated transmitters.

Those guidelines are consistent with the safety standard previously set by both U.S. and international standards bodies. The design of the radio complies with the FCC guidelines and these international standards.

Never allow children to operate the radio without adult supervision and the knowledge of the following guidelines.

WARNING! It is up to the user to properly operate this radio transmitter to insure safe operation. Please adhere to the following:

Use only the supplied or an approved antenna. Unauthorized antennas, modifications, or attachments could impair call quality, damage the radio, or result in violation of FCC regulations.

Do not use the radio with a damaged antenna.

If a damaged antenna comes into contact with the skin, a minor burn may result. Please contact your local dealer for a replacement antenna.

Our PO FUNG ELECTRONIC(HK) INTERNATIOANL GROUP COMPANY radio generators RF electromagnetic energy during transmit mode. This radio is designed for and classified as "Occupational Use Only" ,meaning it must be used only during the course of employment by individuals aware of the hazards, and the ways To Minimize Such hazards.

This radio is NOT intended for use by the "General Population" in an uncontrolled environment. This radio has been tested and complies with the FCC RF exposure limits for "Occupational Use Only" .

In addition, our PO FUNG ELECTRONIC(HK) INTERNATIOANL GROUP COMPANY radio complies with the following Standards and Guidelines with regard to RF energy and electromagnetic energy levels and evaluation of such levels for exposure to humans:

---IEEE Std. 1528:2013 and KDB447498, Evaluating Compliance with FCC Guidelines for Human Exposure to Radio Frequency Electromagnetic Fields.

---American National Standards Institute (C95.1-1992), IEEE Standard for Safety Levels with Respect to Human Exposure to Radio Frequency Electromagnetic Fields, 3 kHz to 300 GHz.

---American National Standards Institute (C95.3-1992), IEEE Recommended Practice for the Measurement of Potentially Hazardous Electromagnetic Fields-RF and Microwave.

The information listed above provides the user with the information needed to make him or her aware of RF exposure, and

what to do to as-sure that this radio operates with the FCC RF exposure limits of this radio.

Electromagnetic Interference/Compatibility

During transmissions, PO FUNG ELECTRONIC(HK) INTERNATIOANL GROUP COMPANY radio generates RF energy that can possibly cause interference with other devices or systems. To avoid such interference, turn off the radio in areas where signs are posted to do so. DO NOT operate the transmitter in areas that are sensitive to electromagnetic radiation such as hospitals, aircraft,and blasting sites.

Occupational/Controlled Use

The radio transmitter is used in situations in which persons are exposed as consequence of their employment provided those persons are fully aware of the potential for exposure and can exercise control over their exposure.

Attention:

This radio complieswith IEEE and ICNIRP exposure limits for occupational/controlled RF exposure emvironment at operating duty factors of up to 50% and is authorized by the FCC for occupational use only. An appropriate warning lable is affixed to all units. In order to comply with RF exposure requirements, a minimum distance of 2.5 cm must be maintained when held-to-face, and body-worn operations are restricted to the approved original accessories (belt clip), a minimum distance of 0 cm. Do not use this device when antenna shows obvious damages.

This product is compliance to FCC RF Exposure requirements and refers to FCC website

<https://apps.fcc.gov/oetcf/eas/reports/GenericSearch.cfm> search for FCC ID: 2AJGM-P11UV to gain further information include SAR Values.

Hand-held Operation (Held-to-Face)

This device was evaluated for typical hand-held (held-to- face) operations with a 1 inch spacing from the front of the radio. For hand-held operation, the radio should be held 1 inch from the user's face in order to comply with FCC RF exposure requirements.

For more information about RF exposure, please visit the FCC web site at www.fcc.gov.

Body-worn Operation

This device was evaluated for body-worn operations with the supplied belt-clip accessory. (All necessary accessories are

included in the package; any additional or optional accessories are not required for compliance with the guidelines.) Third party accessories (unless approved by the manufacturer) should be avoided as these might not comply with FCC RF exposure guidelines.

For more information about RF exposure, please visit the FCC web site at www.fcc.gov.

GMRS Communication

This GMRS (General Mobile Radio Service) feature is a land-mobile service available for short-distance, two-way communications in the USA. You must have a valid FCC license to communicate on these channels. The GMRS frequencies that this radio uses are set aside for communicating with others while hiking, biking, and working; keeping track of family and friends at a crowded public event; checking with travel companions in another car; talking with neighbors; arranging meeting spots with others while shopping at the mall. Licensed users will be issued a call sign by the FCC, which should be used for station identification when operating this radio. GMRS users should also cooperate by engaging in permissible transmissions only, avoiding channel interference with other GMRS users, and being prudent with the length of their transmission time.

FCC License Required

This two-way radio operates on GMRS (General Mobile Radio Service) frequencies which require an FCC (Federal Communications Commission) license. A user must be licensed prior to transmitting on the GMRS band with this radio. Serious penalties could result for unlicensed use of GMRS channels, in violation of FCC rules. Operation of this radio is subject to additional rules specified in 47 C.F.R. Part 95. For licensing information and application forms, please call the FCC Hotline at 800418-FORM. Request form #159 and form #605. Questions regarding the license application should be directed to the FCC at 888-CALL-FCC. Additional information is available on the FCC's website at www.fcc.gov.

NOTE: Even if you operate this radio on GMRS 8-14th channels at low power (0.5 watt), you are required to have an FCC license. Because this radio operates in the 0.5 to 5 watt GMRS power range all GMRS rules apply. Normal GMRS only radios operate 8-14th at a maximum power of 0.5 watt (500 mill watt) power and have an integral (non-detachable) antenna.

FCC Warnings

Replacement or substitution of transistors, regular diodes or other parts of a unique nature, with parts other than those recommended by Pofung may cause a violation of the technical regulations of part 95 of the FCC rules, or violation of type acceptance requirements of part 2 of the rules.

1.2 Content of the packaging

- 1 P111UV transceiver
 - 1 Fast desktop charger
 - 1 Belt clip
 - 1 Li-Ion battery pack 1500mAh 7.4V
 - 1 Wall adaptor
 - Antenna
- *If any item is missing, please verify with your Pofung dealer.

1.3 Main features

- Scan receiving frequency band: 136-174 & 400-520MHz
 - 30 GMRS Channels
 - 10 Selectable Call/Call Alerts
 - 258 Privacy Codes (50 CTCSS Tones and 208 DCS Codes)
 - SOS Emergency function
 - Channel Monitor, Channel Scan, Dual Watch functions
 - CTCSS and DCS codes research
 - Hands-Free Operation (VOX)
 - Frequency step: 2.5/5/6.25/10/12.5/25KHz
 - VOICE: Vocal indication of the function selected
 - Low battery voice indicator
 - LED Flashlight
 - Li-Ion 1500mAh battery pack
 - Up to 8 Mile Range*
 - Output power: $\leq 3.5W$
 - 11 Channels NOAA Weather Radio
 - 1750Hz tone for repeaters
 - FM radio receiver (88-108MHz)
 - TOT (Time out timer) 30/60/90/120/150/180s
 - Busy Channel Lockout function (BCL)
 - Power HI/ LO Settings
 - Squelch adjustable in 9 levels
 - Keypad lock
 - Battery Saver
 - Support USB (Type-C) charging
 - 2pin Kenwood accessory jack
- *Range may vary depending on environmental and/or topographical conditions.

About Range

Your P11UV Series radios are designed to give you maximum range under optimum conditions.

- Maximum Range: Little to No sight Obstruction.
- Medium Range: Partial Obstruction to line of sight.
- Short Range: Major Obstruction to Line of Sight.

Optimum Conditions are:

- Over water
- Open rural areas without obstructions
- Flat areas where you can see the other person

To ensure you get maximum range:

- Be sure to use fresh or fully charged batteries - low batteries will cause low power conditions.
- Be sure you are on a GMRS channel are restricted by the FCC to low power.
- Be sure to set your radio to use Hi power.

2. BATTERY INFORMATION

2.1 Charging the Battery Pack

The Li-ion battery pack is not charged at the factory; please charge it before use. Charging the battery pack for the first time after purchase or extended storage (more than 2 months) may not bring the battery pack to its normal maximum operating capacity. Best operation will require fully charging/ discharging the battery two or three times before the operating capacity will reach its best performance. The battery pack life may be depleted when it's operating time decreases even though it has been fully and correctly charged. If this is the case, replace the battery pack.

2.2 Charger Supplied

Please use the specified charger provided by POFUNG. Other models may cause explosion and personal injury. After installing the battery pack, and if the radio displays low battery with a voice prompt, please charge the battery.

2.3 Use Caution with the Li-ion Battery

- a. Do not short the battery terminals or throw the battery into a fire. Never attempt to remove the casing from the battery pack, as POFUNG cannot be held responsible for any accident caused by modifying the battery.
- b. The ambient temperature should be between 5°C-40°C (40°F - 105°F) while charging the battery. Charging outside this range may not fully charge the battery.
- c. Please turn off the radio before inserting it into the charger. It may otherwise interfere with correct charging.
- d. To avoid interfering with the charging cycle, please do not cut off the power or remove the battery during charging until the green light is on.
- e. Do not recharge the battery pack if it is fully charged. This may shorten the life of the battery pack or damage the battery pack.
- f. Do not charge the battery or the radio if it is damp. Dry it before charging to avoid damage.

WARNING !

When keys, ornamental chain or other electric metals contact the battery terminal, the battery may become damage or injure a human. If the battery terminals are short circuited it will generate a lot of heat. Take care when carrying and using the battery. Remember to put the battery or radio into an insulated container. Do not put it into a metal container.

2.4 How to Charge

Your radios include a charging cradle and battery packs. Follow these instructions to recharge your radios.

Make sure to turn the radio OFF before placing the radio in the charging cradle.

- 1) Connect the adapter's plug to DC IN 10V jack of the charging cradle and plug the other end into an AC outlet.
- 2) Set the charging cradle on the desk or tabletop and place the radio in the charging cradle with the keypad facing forward.
- 3) Make sure that the LED illuminates. Charge the battery pack for 6 hours and remove the radio from the charging cradle after charging.

Note:

- Use only the supplied battery and AC adapter or approved accessories from pofung.
- Charge time may vary depending on the battery life remaining.

- *The battery must be installed for the unit to operate, even if the unit is also connected to external power.*
- *If battery power is low, you cannot operate the radio even using external power. Allow the battery to charge before using. If you try to transmit while power is low, the radio will automatically turn off.*
- *For fastest charging, turn off the radio before charging.*

2.5 LED Indicator

STATUS	LED
No Battery	Green and red alternately flashing
Charge Normally	Red
Fully Charged	Green
Trouble	Red blinks fast for a long time

NOTE: Trouble means battery too warm, battery short-circuited or charger short-circuited.

2.6 How to Store the Battery

- If the battery needs to be stored, keep it in status of 80% discharged.
- It should be kept in low temperature and dry environment.
- Keep it away from hot places and direct sunlight.
 - » Do not short circuit the battery terminals.
 - » Never attempt to remove the casing from the battery pack.
 - » Never store the battery in unsafe surroundings, as a short may cause an explosion.
 - » Do not put the battery in a hot environment or throw it into a fire, as it may cause an explosion.

3. INSTALLATION OF ACCESSORIES

Before the radio is ready for use we need to attach the battery pack, as well as charge the battery.

3.1 Installing/ Removing the Antenna

- a. Installing the Antenna: Screw the antenna into the connector on the top of the transceiver by holding the antenna at its base and turning it clockwise until secure.
- b. Removing the Antenna: Turn the antenna counter-clockwise to remove it.

3.2 Installing the belt clip

- a. To install the BELT CLIP, slide the clip down into the slot on the back of the radio until the BELT CLIP LATCH clicks.
- b. To remove the BELT CLIP, press the LOCK TAB down, and then gently pull the belt clip up toward the top of the radio.

3.3 Installing the battery pack

Before attaching or removing the battery make sure your radio is turned off by turning the power/volume knob all the way counter-clockwise.

To install the battery pack:

- a. With the back of the radio facing you, insert the bottom part of the Li-ion battery pack to the bottom of the radio.
- b. Push down the Li-ion battery pack into the radio until the Battery Lock Tab locks into place.

To remove the battery pack:

- a. Press the Battery Lock Tab downward until the Li-ion battery pack unlocks from the radio.
- b. Pull the Li-ion battery pack away from the radio.



3.4 Installing the Additional Speaker/Microphone (Optional)

Pry open the rubber MIC-Headset jack cover and then insert the Speaker / Microphone plug into the double jack.

4. RADIO OVERVIEW

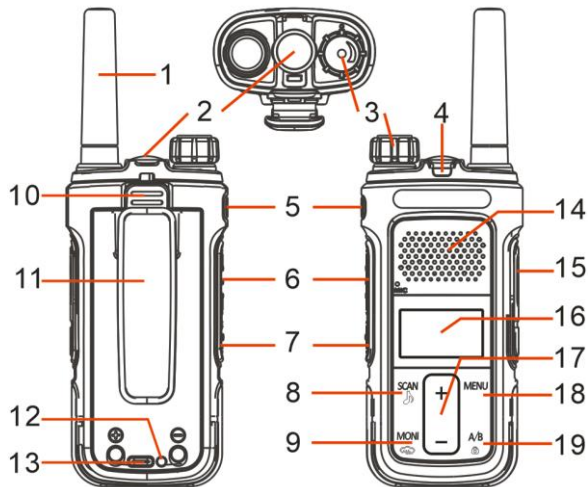
4.1 Main controls and parts of the radio



1.	Antenna
2.	LED Flashlight
3.	Power Switch/ Volume control
4.	Led: transmission (red) / reception (green)
5.	[LAMP]: Press the key once to turn on the flashlight, Press and hold the key again to flash the flashlight, and press the hand again to turn off the flashlight; Press and hold the key to turn on the audible and visual alarm function
6.	[PTT]:Transmit key, hold the key to speak, release the key after speaking, and receive incoming calls;
7.	FM: Press to turn on the radio function, and press again to turn off the radio function;
8.	[SCAN ]: Press to send a CALL ALERT signal; Press and hold to enter SCAN mode.
9.	[MONI ]: Press to enter weather forecast mode; Press and hold to enter MONITOR mode.
10.	Battery release latch
11.	Belt clip
12.	Charging indicator: The red light is always on during charging, and the green light is always on when charging is full.
13.	Micro-USB Charging Port: DC5V USB input
14.	Speaker
15.	External Speaker/Microphone Jack: allows the connection with external devices such as headsets, microphones.
16.	LCD Display
17.	+/- keys: push to select functions or Menu. Channel mode, press + to switch up the channel; press - to switch channel down.
18.	Menu: press to enter the Menu functions and to confirm your selections.
19.	[A/B ] In standby mode, press this key to switch between main/sub channels between A/B channels. Press and hold this key to lock or unlock the keyboard. Menu mode, Press the key to exit the menu; Press to enter SCAN mode. Press and hold to turn KEY LOCK on/off.

4.2 LCD Display

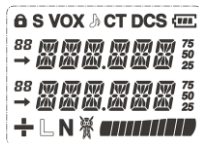

Transmit and receive instructions



In channel mode, display the current channel frequency;
In menu mode, display menu items;



Battery level indicator. When the battery is almost used up, the icon starts blinking and the transmission is blocked. Charge the radio.



Indicates the channel number that you stored



Appears when a positive shift is activated.
Appears when a negative shift is enabled.

VOX

Activation of the VOX function



This icon indicates the keypad lock. To unlock it press A/B key.



This symbol appears during transmission (when you press the PTT key) or reception. When the radio is in rx mode, the led will light up green, while in tx mode it will be red.



Press and release to transmit your unique Call Tone signal to another radio. The other person will hear a two second call tone. This tone is used only to establish voice communications.



This letter is displayed when the Dual Watch function is active.



Low power selection



Narrow bandwidth: N = narrow. When the wide (W) bandwidth is activated, no icon is displayed.



These symbols show that you set a CTCSS code in tx or rx. In tx mode it appears while you are transmitting, while in rx mode it is shown also in stand-by condition.



These symbols show that you set a DCS code in tx or rx. In tx mode it appears while you are transmitting, while in rx mode it is shown also in stand-by condition.



This icon indicates where the radio is operating, in which frequency or function. The arrow is displayed close to the frequency band in use.

WEATHE

Enter weather forecast receiving mode (transmission prohibited in this mode)

5. BASIC OPERATIONS

5.1 Turning your Radio On and Off

To turn your radio **ON**, turn the rotary knob clockwise.

To turn your radio **OFF**, turn the rotary knob counterclockwise.

5.2 Setting the Volume

Increase volume by turning the rotary knob clockwise.

To decrease volume, turn the rotary knob counterclockwise.

Do not hold the radio close to your ear. If the volume is set to an uncomfortable level, it could hurt your ear.

5.3 Choosing a Channel

Your radio has 30 channels and 260 Privacy codes you can use to talk to others. In order to speak to someone, both your radios must be set to the same channel and Privacy code.

Press **[+ / UP]** to move up one channel at a time. Press and hold the key to scroll quickly up the channels.

Press **[- / DOWN]** to move down one channel at a time. Press and hold the key to scroll quickly down the channels.

5.4 Talking and Listening

All radios in your group must be set to the same channel and Sub-Code in order to communicate.

1. Hold your radio 2–3 cm from your mouth.

2. Press and hold the **[PTT]** key while speaking. The Transmit **TX ---** icon appears on the display.

3. Release the **[PTT]** key. You can now receive incoming calls. When you do, the Receive **RX ---** icon appears on the display.

For maximum clarity, hold the radio 2 to 3 cm away and avoid covering the microphone while talking.

5.5 SCAN

Your P11UV can scan all 30 channels for activity. Pressing and holding **[SCAN]** key for 2 seconds to enter. Repeat the same procedure to exit.

Your radio will rapidly scan each of the 30 channels and stop on any active channel. Your radio will resume scanning after 4

seconds when the channel is no longer active.

When you press the **[PTT]** key to transmit on an active channel, the scanning function will stop and remain on the active channel for 5 seconds before resuming scan when **[PTT]** key is no longer pressed.

To resume scanning, quickly press the key.

5.6 Monitor

Press and hold the **[MONI]** key for around 2 second will let you hear noise so you can adjust the volume level of the radio when not receiving a signal. This should be used to check activity on your current channel before transmitting.

Press and hold the **[MONI]** key for 3 second again to get out of Monitor mode.

5.7 Keypad lock

This function locks the keypad to prevent accidental pressure of the controls.

To avoid accidentally changing the radio setting, press the **[A/B]** key for 2 seconds. The  icon will appear on the display. **PTT, LAMP, MONITOR,** and **FM Radio** keys will still be active. Repeat the same procedure to unlock the keypad.

5.8 A/B switch

Press the **[A/B]** switch to select the master frequency.

5.9 Flashlight and Emergency Alert

This function is very useful for night illumination.

To turn it on press **[LAMP]**; push it again, the flash light will be strobe; push it again: it will turn off.

Open radio, press and hold the **[LAMP]** key for about 2 seconds to activate the sound and light alarm function. Press **[LAMP]** key again to exit the alarm state.

5.10 FM Radio (FM)

The frequency range to listen to the radio is 78-108MHz.

With P11UV turned on, Press **[FM]** to turn on the radio. Select the desired radio frequency with the **[+UP]/[-DOWN]** keys. Press **[FM]** to exit FM radio.

Note: while you are listening to the radio, the channel of A / B receiving signal will automatically



switch to the channel mode for normal transmitting and receiving.

When the signal disappears the radio will automatically switch again to FM radio mode.

5.11 NOAA Weather Radio

Your radio can receive weather broadcasts from the NOAA National Weather Service.

While using the Weather Radio, you are not able to receive GMRS communications.

1> To turn on the Weather Radio Broadcast mode, press [MONI ]. WEATHER appears.

2> Press [+UP]/[-DOWN] to select the desired number of weather channels.

3> To exit the Weather Radio Broadcast mode, press [MONI ]. WEATHER disappears.

NOTE: There are 11 NOAA channel frequencies available and these frequencies are common between the US and Canada. You need to know what frequency is being transmitted in your location.

NOAA Weather Radio Frequency List:

Chan.	Freq. (MHz)	Chan.	Freq. (MHz)
WEATHER 1	162.550	WEATHER 7	162.525
WEATHER 2	162.400	WEATHER 8	161.650
WEATHER 3	162.475	WEATHER 9	161.775
WEATHER 4	162.425	WEATHER10	161.750
WEATHER 5	162.450	WEATHER11	162.000
WEATHER 6	162.500	---	---

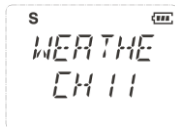

5.12 1000Hz, 1450Hz, 1750Hz Tone-burst

To send out a tone-burst; you simultaneously will press a key while holding down the PTT. No further configuration required using this feature.

The following configurations will transmit accordingly:

- [PTT] +[-DOWN] = Transmits 1450Hz Tone Burst
- [PTT] +[+UP] = Transmits 1750Hz Tone Burst
- [PTT] +[MENU] = Transmits 2100Hz Tone Burst

If you have the keypad lock enabled on your radio, you can still send a 1750Hz tone the regular way without having to unlock your radio.

6. WORKING THE MENU SYSTEM

6.1 Basic use

Using the menu with arrow keys

1> Press the **[MENU]** key to enter the menu.

2> Use the **[+UP]** and **[-DOWN]** keys to navigate between menu items.

3>Once you find the desired menu item, press **[MENU]** again to select that menu item.

4>Use the **[+UP]** and **[-DOWN]** keys to select the desired parameter.





5>When you've selected the parameter you want to set for a given menu item;





a). To confirm your selection, press **[MENU]** and it will save your setting and bring you back to the main menu.

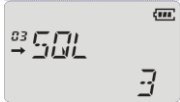

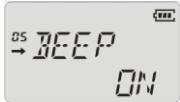

b). To cancel your changes, press **[A/B]** and it will reset that menu item and bring you out of the menu entirely.



6> To exit out of the menu at any time, press the **[A/B]** key.

6.2 Shortcut Menu operations

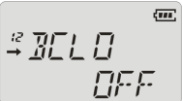
MENU No.	Name (Full Name)	LCD display	Selectable
1	RXCODE -Receiver Privacy Codes		OFF;67.0...D754N The Privacy Codes is off, and the display is OFF. When the display is OFF, press +key to select CTCSS with priority; When the display is OFF, press - key to select DCS with priority.
2	TXCODE -Transmitter Privacy Codes		OFF;67.0...D754N The Privacy Codes is off, and the display is OFF. When the display is OFF, press +key to select CTCSS with priority; When the display is OFF, press - key to select DCS with priority.
3	SQL - Squelch Level		.0-9 Levels .0:Lowest .9:Highest
4	LIGHT -Back Light		.OFF .ON .KEY

5	BEEP - Keypad Beep		.OFF .ON *Allows audible confirmation of a key press.
6	VOX - VOX		.OFF will turn off VOX function. .1:Lowest Sensitivity .5:Highest Sensitivity
7	TXP -Transmit Power		.HIGH-high power transmission; .LOW-low power transmission. *When set to low power, the screen will display the 'L' icon.
8	TDR – Dual Watch Operation		OFF ON *Monitor [A] and [B] at the same time. Activate the dual watch, and the screen will display the 'S' icon.
9	W/N- -Wide/Narrow Bandwidth		WIDE:25.0K NARROW:12.5K

10	SAVE - Battery Saving		OFF: ON:
11	TOT - Time-Out-Timer		OFF,30,60...180S *This feature provides a safety switch that limits transmission time to a programmed value. This will promote battery conservation by not allowing you to make excessively long transmissions, and in the event of a stuck PTT switch it can prevent interference to other users as well as battery depletion
12	BCLO -Busy Channel Lock-out		OFF ON *Disables the[PTT] key on a channel that is already in use. The transceiver will sound a beep tone and will not transmit if the[PTT] key is pressed when a channel is already in use.
13	RING -Call Tone Select		.OFF- close call tone; .Select 1-10 process, you can listen to the call tone.

14	VOICE -Voice Reminding		.OFF - turn off voice prompts; .CHI- voice prompt is Chinese; .ENG- voice prompts in English. *Allows audible voice confirmation of a key press.
15	RESET -Restore defaults		*Resets the radio to factory defaults.

6.3 Menu settings

6.3.1 Receiving with Privacy Codes (RXCODE) - MENU 01

You can configure different Receiving Privacy Codes for each channel. The selected Privacy Code may be different for each channel.

Note: Selecting a Privacy Code of "OFF" will disable the Privacy feature. To communicate between two P11UV radios, all radios in your group must be set to the same channel and Privacy Code selections.

The Receiving Privacy Codes setting steps are as follows:

1> Press **[MENU]** key to enter the main menu, and press **[+UP]/[-DOWN]** key to enter the MENU 01.

2> Press **[MENU]** key again to enter the **RXCODE** menu;

3> Press **[+UP]/[-DOWN]** key to select the Privacy Code, and the selection range is OFF / 67.0~754N.

Note: The state of the Privacy Code is off, and the display is OFF. When the display is OFF, press the [+UP] key to select CTCSS with priority, range 67~254.1Hz (50 groups in total); when the display is OFF, press the [-DOWN] key to select DCS with priority, range D754I-023N (104 groups in total).

During the selection process, Pressing and holding the [+UP]/[-DOWN] key to quickly search for the sub-tone code.

4> Press **[MENU]** key to confirm;

5> Press **[PTT]** or **[A/B]** key to exit the menu mode.

6.3.2 Transmitting with Privacy Codes (TXCODE) --- MENU 02

You can configure different transmission Privacy Codes for each channel. The selected Privacy Code may be different for each channel.

Note: Selecting a Privacy Code of "OFF" will disable the Privacy feature. To communicate between two P11UV radios, all radios in your group must be set to the same channel and Privacy Code selections.

The transmission Privacy Codes setting steps are as follows:

1> Press **[MENU]** key to enter the main menu, and press **[+UP]/[-DOWN]** key to enter the MENU 02.

2> Press **[MENU]** key again to enter the **TXCODE** menu;

3> Press **[+UP]/[-DOWN]** key to select the Privacy Code, and the selection range is OFF / 67.0~754N.

Note: The state of the Privacy Code is off, and the display is OFF. When the display is OFF, press the [+UP] key to select CTCSS with priority, range 67~254.1Hz (50 groups in total); when the display is OFF, press the [-DOWN] key to select DCS with priority, range D754I-023N (104 groups in total).

During the selection process, Pressing and holding the [+UP] / [-DOWN] key to quickly search for the sub-tone code.

4> Press **[MENU]** key to confirm;

5> Press **[PTT]** or **[A/B]** key to exit the menu mode.

6.3.3 Squelch level (SQL) - MENU 03

This function turns on the Squelch when the signal is strong; the Squelch will stay off when the signal is weak. Set the same DCS codes of your group and turn on the squelch.

By setting the level too high, you may not receive the weak signals; while by setting it too low you may receive noises or undesired signals.

NOTE: This transceiver has 10 (0-9) available levels: 0 means that the Squelch is turned on. From level 1 to level 9 you will have different levels of noises reduction.

The higher is the level, the louder will be the Squelch.

The steps for setting the squelch level are as follows:

1> Press **[MENU]** key to enter the main menu, and press **[+UP]/[-DOWN]** key to enter the MENU 03.

2> Press **[MENU]** key again to enter the **SQL** menu;

3> Press **[+UP]/[-DOWN]** key to select the squelch level, select the range 0, 1-9

4> Press **[MENU]** key to confirm;

5> Press **[PTT]** or **[A/B]** key to exit the menu mode.

6.3.4 Backlight intensity (LIGHT) - MENU 04

The LCD backlight is convenient for you to use at night or in a dark environment. The LCD backlight setting steps are as follows:

1> Press **[MENU]** key to enter the main menu, and press **[+UP]/[-DOWN]** key to enter the MENU 04.

2> Press **[MENU]** key again to enter the **LIGHT** menu;

3> Press **[+UP]/[-DOWN]** key to select the LCD backlight switch, and the selection range is ON/OFF/KEY;

Note: ON-backlight will be always on; OFF-backlight will be always off; KEY-touch key will automatically activate the backlight. Without any key operation, the backlight will be automatically turned off after a delay of 5 seconds.

4> Press **[MENU]** key to confirm;

5> Press **[PTT]** or **[A/B]** key to exit the menu mode.

6.3.5 Beep tone (BEEP) - MENU 05

If you enable this function, every time a key is pressed, you will hear a Beep tone. You can set it as follows:

1> Press **[MENU]** key to enter the main menu, and press the **[+UP]/[-DOWN]** key to enter the MENU 05.

2> Press **[MENU]** key again to enter the **BEEP** menu;

3> Press **[+UP]/[-DOWN]** key to select the BEEP switch, and the selection range is ON/OFF;

Note: ON-turn on the key prompt sound; OFF-turn off the key prompt sound.

4> Press **[MENU]** key to confirm;

5> Press **[PTT]** or **[A/B]** key to exit the menu mode.

6.3.6 VOX (VOX) - MENU 06

Your radio has 5 VOX level settings: (OFF/1~5).

This function allows hands-free conversations: just speak in the direction of the microphone and the communication will be automatically activated.

The steps for setting up VOX voice control transmission are as follows:

1> Press **[MENU]** key to enter the main menu, and press the **[+UP]/[-DOWN]** key to enter the MENU 06.

2> Press **[MENU]** key again to enter the **VOX** menu;

3> Press **[+UP]/[-DOWN]** key to select the VOX switch and sensitivity, the selection range is OFF, 1~5;

Note: Level 5 low sensitivity, use under high background noise; Level 1 high sensitivity, use under low background noise. Select 'OFF' will turn off the VOX function. After the VOX function is turned on, the screen will display the 'VOX' icon.

4> Press **[MENU]** key to confirm;

5> Press **[PTT]** or **[A/B]** key to exit the menu mode.

6.3.7 High/low power selection (PWR) - MENU 07

High power is used for transmission in a long distance or complex environment, and low power is used for transmission in close range or open terrain. If you need to change the transmit power, the setting steps are as follows:

1> Press **[MENU]** key to enter the main menu, and press **[+UP] /[-DOWN]** key to enter the MENU 07.

2> Press **[MENU]** key again to enter the **PWR** menu;

3> Press **[+UP]/[-DOWN]** key to select the transmit power, and select the range HIGH/LOW;

NOTE: When set to low power transmission, the screen will display the 'L' icon.

4> Press **[MENU]** key to confirm;

5> Press **[PTT]** or **[A/B]** key to exit the menu mode.

6.3.8 Dual Watch function (TDR) - Menu 08

This function is a dual-channel monitor scan, which can monitor the A and B segments in the normal mode. If a signal is received on the monitoring channel, the scan stays on this channel. The steps for setting the dual-frequency waiting function are as follows:

1> Press **[MENU]** key to enter the main menu, press **[+UP]/[-DOWN]** key to enter the MENU 08.

2> Press **[MENU]** key again to enter the **TDR** menu;

3> Press **[+UP]/[-DOWN]**key to select the dual-frequency wait switch, and the selection range is ON/OFF;

Note: OFF-turn off the dual watch function; ON-turn on the dual watch function.

Turn on the dual watch function; the screen will display the 'S' icon.

- 4> Press **[MENU]** key to confirm;
- 5> Press **[PTT]** or **[A/B]** key to exit the menu mode.

6.3.9 Wide/narrow bandwidth (W/N) - MENU 09

- 1> Press **[MENU]** key to enter the main menu, press **[+UP]/[-DOWN]** key to enter the MENU 09.
 - 2> Press **[MENU]** key again to enter the **W/N** menu;
 - 3> Press **[+UP]/[-DOWN]** key to select the wide and narrow band, and select the range WIDE/NARROW;
- Note: WIDE-wideband 25.0 KHZ; NARROW-narrowband 12.5 KHZ. (Can used Narrow for GMRS)**
- 4> Press **[MENU]** key to confirm;
 - 5> Press **[PTT]** or **[A/B]** key to exit the menu mode.

6.3.10 Power save (SAVE) - MENU 10

To save battery power, this function can turn off the transceiver when no signal is received.

- 1> Press **[MENU]** key to enter the main menu, press **[+UP]/[-DOWN]** key to enter the MENU 10.
 - 2> Press **[MENU]** key again to enter the **SAVE** menu;
 - 3> Press **[+UP]/[-DOWN]** key to select the power saving mode, and the selection range is ON/OFF;
- Note: ON-turn on the power saving mode; OFF-turn off the power saving mode.**
- 4> Press **[MENU]** key to confirm;
 - 5> Press **[PTT]** or **[A/B]** key to exit the menu and return to normal operation mode.

6.3.11 Time out Timer (TOT) - MENU 11

The TOT function is used to prevent a too long transmission. This function temporarily blocks transmissions if the radio has been used beyond the maximum time permitted. Once reached the preset timer, the radio will be forced in reception mode. The transmission time can be set in 6 levels with 30 seconds each (between 30 and 180 seconds). The setting steps are as follows:

- 1> Press **[MENU]** key to enter the main menu, press **[+UP]/[-DOWN]** key to enter the MENU 11.
- 2> Press **[MENU]** key again to enter the **TOT** menu;
- 3> Press **[+UP] / [-DOWN]** key to select the transmission time limit, the selection range is OFF/30S/60S/90S/120S/150S/180S;

- 4> Press **[MENU]** key to confirm;
- 5> Press **[PTT]** or **[A/B]** key to exit the menu mode.

6.3.12 Busy channel lockout (BCL) - MENU 12

When this function is active, if you select a busy channel and press the PTT, the transceiver will not transmit.

- 1> Press **[MENU]** key to enter the main menu, press the **[+UP]/[-DOWN]** key to enter the MENU 12.
- 2> Press **[MENU]** key again to enter the **BCLO** menu;
- 3> Press **[+UP]/[-DOWN]** key to select the switch and select the range ON/OFF;
- 4> Press **[MENU]** key to confirm;
- 5> Press **[PTT]** or **[A/B]** key to exit the menu mode.

6.3.13 Call Tone Select (RING)- MENU 13

This setting will allow you to transmit a unique Call Tone alert to identify your radio when you transmit messages. You can select from one of 10 different Call Tone signals. To Set Call Tone:

- 1> Press **[MENU]** key to enter the main menu, press **[+UP]/[-DOWN]** key to enter the MENU 13.
- 2> Press **[MENU]** key again to enter the **RING** menu;
- 3> Press the **[+UP]/[-DOWN]** key to select a different Call Tone. An example of each call tone will sound for 1.5 seconds.

Note: OFF-turn off the call reminder tone; during the selection of 1-10, you can listen to the call tone.

Before you initiate a voice intercom, you can press the [CALL] key to remind the call.

- 4> Press **[MENU]** again to confirm;
- 5> Press **[PTT]** or **[A/B]** key to exit the menu and return to normal operation mode.

6.3.14 VOICE Selection (VOICE) - MENU 14

Your P11UV radio has voice prompt function for channel and function operation, you can choose to switch voice function or prompt language type. The setting steps are as follows:

- 1> Press **[MENU]** key to enter the main menu, and press **[+UP]/[-DOWN]** key to enter the MENU 14.
- 2> Press **[MENU]** key again to enter the **VOICE** menu;
- 3> Press **[+UP]/[-DOWN]** key to OFF or Chinese and English selection, the selection range is OFF/CHI/ENG

Note: OFF-turn off the voice prompts function; CHI-prompt voice is Chinese; ENG-prompt voice is English.

After turning off the voice prompt function, there will be a beep prompt when you select a channel or menu setting.

4> Press **[MENU]** key to confirm;

5> Press **[PTT]** or **[A/B]** key to exit the menu mode.

6.3.15 Restore factory settings (RESET)-MENU 15

Your P11UV radio has a reset function. To reset the radio, proceed as follows:

1>Press **[MENU]** key to enter the main menu, and press **[+UP]/[-DOWN]** key to enter the **MENU 15**, the screen displays **RESET**.

2> Press **[MENU]** key to confirm, and the radio resets the parameters.

7. ON-LINE SERVICE AND SUPPORT

The Pofung website provides additional information about obtaining service or support for the Pofung line of two-way radios and accessories. Visit: www.pofungshop.com Mail: service@pofungshop.com

FCC Licensing Information This pofung radio operates on Commercial/ Land Mobile frequencies which require a license from the Federal Communications Commission (FCC) for business, personal, education and recreational use. To obtain forms, call the FCC forms hotline at: 1-800-418-3676 or go to <http://www.fcc.gov> For questions concerning commercial licensing, contact the FCC at 1-888CALL-FCC (1-888-225-5322).

Appendix A. – Trouble shooting guide

Phenomena	Analysis	Solution
You cannot turn on the radio.	The battery may be installed improperly.	Remove and reattach the battery.
	The battery power may run out.	Recharge or replace the battery.
	The battery may suffer from poor contact caused by dirty or damaged battery contacts.	Clean the battery contacts or replace the battery.
During receiving, the voice is weak or intermittent.	The battery voltage maybe low.	Recharge or replace the battery.
	The volume level may be low.	Increase the volume.
	The antenna maybe loose or maybe installed incorrectly.	Turnoff the radio, and then remove and reattach the antenna.
	The speaker maybe blocked.	Clean the surface of the speaker.
You cannot communicate with other group members.	The frequency or signaling type maybe inconsistent with that of other members.	Verify that your TX/RX frequency and signaling type are correct.
	You may be too far away from other members.	Move towards other members.
You hear unknown voices or noise.	You may be interrupted by radios using the same frequency.	Change the frequency, or adjust the squelch level.
	The radio in analog mode maybe set with no signaling.	Request your dealer to set signaling for the current channel to avoid interference
You are unable to hear anyone because of too much noise and hiss.	You may be too far away from other members.	Move towards other members.
	You may be in an unfavorable position. For example, your communication may be blocked by high buildings or blocked in an underground area.	Move to an open and flat area, restart the radio, and try again.
	It may be the result of external disturbance (such as electromagnetic interference).	Stay away from equipment that may cause interference.
The radio keeps transmitting.	VOX may be turned on or the headset is not installed in place	Turn off the VOX function. Check that the headphones are in place.

Appendix B. - Technical Specifications

General

Frequency Range	GMRS (RX & TX) 136-174 & 400-512MHz (RX)
Memory Channel	30 GMRS Channels + 11 NOAA Weather
Operation Voltage	DC7.4V \pm 10%
Battery Capacity	1500mAH (Li-Ion)
Frequency Stability	\pm 2.5ppm
Operating Temperature	-20°C to +60°C
Mode of Operation	Simplex
Antenna Impedance	50ohm

Transmitter Part

FM Modulation	11K0F3E@12.5KHz
Spurious Emission	-13dBm < 1GHz , -13dBm > 1GHz
Adjacent Channel Power	60dB @ 12.5 KHz
Transmission current	\leq 600mA

Receiver Part

Receive Sensitivity	0.25 μ V (12dB SINAD)
Adjacent Channel Selectivity	\geq 55dB@12.5KHz
Inter Modulation and Rejection	\geq 55dB@12.5KHz
Conducted Spurious Emission	\leq -57dB@12.5KHz
Rated Audio Power Output	1W @16ohms
Receive current	\leq 350mA
Rated Audio Distortion	\leq 5%

NOTE: All specifications may be modified without prior notice or liability. Thank you.

Appendix C. - GMRS Frequency Chart (MHz)

CH.No	CH.Freq.	Type of Radio	Power Output	CH.No	CH.Freq.	Type of Radio	Power Output
1	462.5625	GMRS	High	16	462.5750	GMRS	High
2	462.5875	GMRS	High	17	462.6000	GMRS	High
3	462.6125	GMRS	High	18	462.6250	GMRS	High
4	462.6375	GMRS	High	19	462.6500	GMRS	High
5	462.6625	GMRS	High	20	462.6750	GMRS	High
6	462.6875	GMRS	High	21	462.7000	GMRS	High
7	462.7125	GMRS	High	22	462.7250	GMRS	High
8	467.5625	GMRS	Low	23	467.5500/462.5500	RPT	High
9	467.5875	GMRS	Low	24	467.5750/462.5750	RPT	High
10	467.6125	GMRS	Low	25	467.6000/462.6000	RPT	High
11	467.6375	GMRS	Low	26	467.6250/462.6250	RPT	High
12	467.6625	GMRS	Low	27	467.6500/462.6500	RPT	High
13	467.6875	GMRS	Low	28	467.6750/462.6750	RPT	High
14	467.7125	GMRS	Low	29	467.7000/462.7000	RPT	High
15	462.5500	GMRS	High	30	467.7250/462.7250	RPT	High

Disclaimer

The Company endeavors to achieve the accuracy and completeness of this manual, but no warranty of accuracy or reliability is given. All the specifications and designs are subject to change without notice due to continuous technological development. No part of this manual may be copied, modified, translated, or distributed in any manner without the prior written consent of the Company.

We do not guarantee, for any particular purpose, the accuracy, validity, timeliness, legitimacy or completeness of the third-party products and contents involved in this manual.



PO FUNG ELECTRONIC (HK) INTERNATIOANL GROUP COMPANY

Address: 3/F FULOK BLDG 131-133 WING LOK ST SHEUNG WAN, Hong Kong

Telephone: +86-595-86752889

Fax: +86-595-86754889

Mail: sales@pofungshop.com

[Http://www.pofungshop.com](http://www.pofungshop.com)

Print version: P11UV_GMRS_V1