

# **MP23/T23 SERIES**

**FRS TWO-WAY RADIO**

**OWNER'S MANUAL**

**ATTENTION!** The radio is a multitask FRS transceiver. Combining the latest technology in radio communication along with a sturdy mechanical frame, the radio is the ideal and effective solution for the professionals who need to stay in touch with the working team (in construction sites, buildings, shows, trade fairs or hotels) or for leisure users that just want to keep up with friends and family.

To help you ward off bodily injury or property loss that may arise from improper operation, please read all the information carefully before using our products.

**Before operating the radio, please read all safety and operating instructions. Save all instructions in a safe place for future reference.**



### **FCC Part 15.21 Warning Statement**

**NOTE: THE GRANTEE IS NOT RESPONSIBLE FOR ANY CHANGES OR MODIFICATIONS NOT EXPRESSLY APPROVED BY THE PARTY RESPONSIBLE FOR COMPLIANCE. SUCH MODIFICATIONS COULD VOID THE USER'S AUTHORITY TO OPERATE THE EQUIPMENT.**

### **Content of the packaging**

Package Content	General	Extreme	Excellence	Honorable
Radio	2	2	4	6
Li-ion Battery	2	2	4	6
Belt Clip	2	2	4	6
Lanyard	2	2	4	6
Power Adapter	1	1	2	1
Desktop Charger	0	1	2	0
Headset	0	2	4	6
Owner's Manual	1	1	1	1

**Note: The number of the above materials may be depending on the number of packages.**

## Main features

- 22 FRS Channels
- 12 NOAA Weather Channels
- 2 Channels Watch
- Channel Monitor
- 155 Privacy Codes (50 CTCSS codes/ 105 DCS codes)
- Hands-Free Operation (VOX)
- Roger Beep Tone
- Battery Level Meter
- Battery/Power Saver
- Low Battery Audible Alert
- 2pin Kenwood headset jack
- Li-Ion 1500mAh battery pack
- Up to 5 km range\*
- Output power: ≤2W (channels 1-7and 15-22)
- NOAA Weather Scan
- Privacy Codes Scan and Store
- Channel Scan Function
- 10 Selectable Call Alerts
- Call Alert
- Keypad Lock
- Emergency Strobe Light
- Backlit LCD Display
- TOT (Time out timer)
- Type-C USB connector for charging
- Keystroke Tones
- Battery Life: up to 18 hours (under typical use conditions)

***\*Range may vary depending on environmental and/or topographical conditions.***

## Installation of Accessories

### Installing and Removing Belt Clips

With the belt clip, you can easily attach the radio to the belt. However, the belt clip must be removed to install or replace the battery.

To remove the belt clip, follow the illustration. Fasten the clip into the slot on the unit in the radio's rear rail until it snaps into the square.

## Install the Li-ion Battery (BL-T22)

Each radio operates with either a Li-ion battery pack or optional 3 AA alkaline batteries. The belt clip should be removed (see below) to ease installation or removal of the batteries.

### • Install

- 1) Remove the belt clip as described in the previous paragraph.
- 2) Insert the battery pack into the appropriate compartment of the device.
- 3) Close the battery compartment with the cover and put the belt clip back in place

### • Remove

- 1) Remove the belt clip as previously described.
- 2) Open the battery compartment as shown in the figure;
- 3) Remove the battery pack from the device;
- 4) Snap the belt clip back into place.
- 5) Close the battery compartment with the cover and put the belt clip back in place.

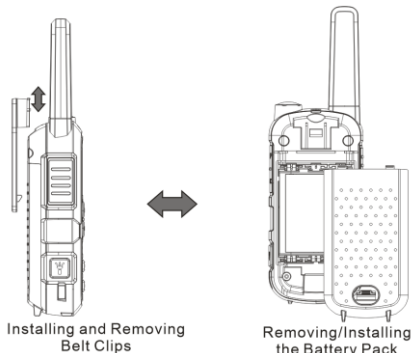

## Install three AA Ni-MH Batteries (3 x AA, rechargeable)

**Warning:** Ni-MH batteries are rechargeable batteries and cannot be mixed with alkaline batteries.

- 1) Turn off the radio.
- 2) With the back of the radio facing you, lift up the battery cover latch, and then remove the battery cover.
- 3) As shown in the figure, insert three AA Ni-MH batteries with + and – polarity (wrong installation of the batteries will cause the unit to fail or damage the unit).
- 4) Close the battery cover. Replace the belt clip and make sure it locks in place.

## Installing the Three AA Alkaline Batteries (non-rechargeable)

**Warning:** Alkaline batteries can only be used in emergency situations and cannot be charged. There is a danger of

explosion when charging alkaline batteries.

- 1) Turn the radio off.
- 2) With the back of the radio facing you, lift the battery cover latch up and remove the cover.
- 3) Insert the three AA Alkaline batteries with + and – polarity as shown inside (Installing the batteries incorrectly will prevent the unit from operating or may damage the unit).
- 4) Close the battery cover. Replace the belt clip, making sure it locks into place.

### **External Speaker/Microphone Jack**

Each radio can be used with an optional external speaker/microphone or headset, freeing your hands for other tasks. To use an optional speaker / microphone or headset:

- 1) Open the rubber cap on the side of the radio.
- 2) Insert the plug(s) into the SPK/MIC jacks.
- 3) Place the ear bud into your ear, and adjust the Microphone into your desired position.

### **Using a Headset**

You can use a headset (#480\_5R) for more private communications. To use a headset, lift the rubber cover from over the headset jack, and then plug in the headset.

**Important:** Your radio is not submersible or waterproof when using a headset jack. When you remove the headset, be sure to fully press the jack cover into place to restore its waterproof capability.

## **Charging the Battery**

### **Charging the Radio**

Two radios can be charged directly by using the supplied charging cradle. A single radio can charge using the Type-C USB port to connect to a USB power source. For fastest charging, turn off the radio before charging.

#### **Warning!**

To avoid the risk of personal injury or property damage from fire or electrical shock, only use the accessories specifically designated for this product. Using the Type-C USB Port

- 1) Connect the included AC adapter with Type-C USB connector cable to the radio's Type-C USB port. Connect the other end to an outlet that provides USB charging power (NOT to a USB hub).
- 2) Charge the batteries for 6 hours until the battery indicator either stops flashing.

### Using the Charging Cradle

- 1) Connect the included AC adapter with USB connector cable to the charging cradle's Type-C USB port. Connect the other end to a standard AC wall outlet.
- 2) Set the charging cradle on the desk or tabletop, and place the radio in the charging cradle with the keypad facing forward.
- 3) Charge the batteries for 6 hours.

#### Note:



- Use only the supplied batteries, charger, and AC adapter or approved accessories.
- Charge time may vary depending on the battery life remaining.
- The batteries must be installed for the unit to operate, even if the unit is also connected to external power.
- If battery power is low, you cannot operate the radio even using external power. Allow the batteries to charge before using.

***\*If you try to transmit while power is low, the radio will automatically turn off.***



**Warning:** Do not charge alkaline batteries. The radio will not be used for a long time, please take out and keep the battery properly.

### Using the Radio Battery Level and Low Battery Alert

This radio has a **Battery Level Meter**  that shows the battery power level. The greater the number of bars visible, the stronger the battery level. When the battery level is low, the **Battery Shell**  icon will flash in the display indicating your batteries should be replaced or recharged if using a rechargeable battery pack.

**Warning!** To avoid the risk of personal injury or property damage from fire or electrical shock, only use accessories specifically designated for this product.

## Main controls and parts of the radio

1. Antenna
2. LCD Display
3. ▲UP button - Press to increase the volume. Menu mode to change settings in MENU.
4. ☞/MENU- Press this control to enter the radios MENU. If you keep it pressed for about 3 seconds, the keypad lock is activated.
5. ⏻/CALL - To send a call to the selected channel. keep pressed to turn on/off the radio.
6. ▼DOWN button - Press to reduce the volume. menu mode to change settings in MENU.
7. Speaker and Built-in microphone
8. LED Flashlight
9. Led indicator: RED - TX; GREEN - RX.
10. **Weather/ MONI** button: Short press to switch between Weather and FRS channels. Keep pressed to activate the Monitor function (for weak signal monitoring).
11. SPK | MIC (under the protective cover) - To connect to external audio devices such as microphones, headphones, etc
12. 🔄/SCAN button - Press this button once to activate SCAN.
13. USB port for the recharge of the radio
14. PTT button (Push-To-Talk)
15. 🚨/LAMP/ Emergency button - When the radio is switched on, press shortly to turn on/off the LED flashlight. keep pressed to turn on/off the emergency alerts.

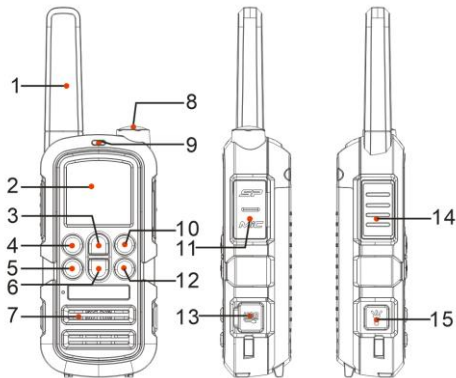

## LCD DISPLAY

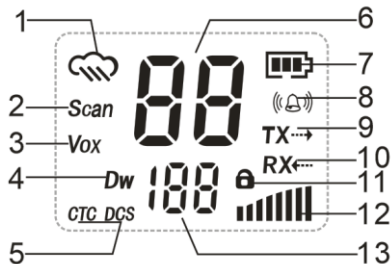

1. NOAA Weather Band Indicator
2. Scan Indicator
3. Activate the VOX function
4. Dual Channel Monitor
5. Select the DCS/CTCSS type of squelch method
6. Channel (1-22)
7. Battery Indicator
8. Emergency alert function activated
9. Transmit Status
10. Receive Status
11. Keypad Lock
12. Transmit power indicator. Low power only in PMR mode
13. Displays the set CTCSS tone or DCS code (CTCSS: 1-50; DCS: 1-105)

## Basic Operations

In order to get the most out of your new radio, read this reference guide completely before attempting to operate the unit.

### Power on/off and volume adjustment

To turn the radio on, keep pressed the [📞/CALL] button.

To adjust the volume level as you prefer, press the [▲] or [▼] button.

In case the radio does not pick up any signal, activate momentarily the Monitor function that allows to detect also weak signals. Then, adjust the volume to the desired level.

To turn the radio off, keep pressed the [📞/CALL] button until a switch off tone is heard.

### Keypad Lock

To avoid accidentally changing the radio settings, press the [🔒/MENU] button for 3 seconds. The 🔒 icon will appear on the display. [PTT], 🗣️, [📞/CALL] and [MONI] keys will still be active. Repeat the same procedure to unlock the keypad.



## Talking on Your Radio

To talk to others using the radio:

- 1) Press and hold the **[PTT]** button and speak in a clear, normal voice about 2-3 inches away from the microphone. While you are transmitting, the **TX→** icon appears on the display. To avoid cutting off the first part of your transmission, pause slightly after pressing the **[PTT]** button before you start talking.
- 2) When you have finished speaking, release the **[PTT]** button. You can now receive incoming calls. While receiving, **RX←** displays.

## Monitor Mode Feature

Your radio allows you to listen for weak signals on the current channel at the press of a key. To turn ON Monitor mode: Press and hold **[🔊/MONI]** for 2 seconds until two beeps sound. The receiver circuit stays open, and both noise and weak signals can be heard. The **RX←** icon blinks. To turn OFF Monitor mode: Press and hold **[🔊/MONI]** for 2 seconds to return to "Normal" mode; two beeps sound and the **RX←** icon stops blinking and disappears.

## Channel Scanning

MP23/T23 can automatically search for signals throughout the FRS bands by scanning, i.e. selecting the channels in rapid sequence. When a signal is detected, the scanning pauses on that channel and you can transmit by pushing **[PTT]**. If you press **[PTT]** during scanning you can transmit on the channel from which the scanning started. The scroll buttons **[▲]** or **[▼]** allow you to change the direction of scanning (from lower channels to higher ones or vice versa) and therefore to skip communications which are of no interest.

Press briefly the button **[🔍/SCAN]** to start scanning.

If you want to stop it, press again **[🔍/SCAN]**. Your transceiver will go back to the channel from which the scanning originally started.

## Scanning Sub-Codes

Press and hold **[🔍/SCAN]** button to enter the Sub-Codes scanning.

A flashing "CTC/DCS" will be in the left status display to indicate the radio is in Sub-Codes scanning mode. In this mode, the lower display will cycle through the Sub-Codes as they are being tested. Once the bits of the received Privacy code are determined, the "CTC/DCS" indicator will stop flashing. Press the [PTT] button to save the scanned tone into memory. During scanning, press and hold [Z/SCAN] button to exit Sub-Code scanning.

## Using the Flashlight

You can use this radio in an emergency. If you press [🚨] button, the radio turns on the high-intensity LED flashlight on your radio.

- Your radio operates normally when the emergency strobe is activated.

- 1) Press [🚨] button once, it will turn on continuously (Always On mode) .

- 2) And then, press [🚨] button once, the Strobe Light emits the emergency signal. (Strobe emergency mode).

- 3) And then, press [🚨] button once, the light will be turned off.

## Emergency Alert

***The Emergency Alert feature can be used to signal members in your group for help. The emergency alarm function is activated by menu operation.***







To activate the emergency alert function, press and hold the [🚨] button for 3 seconds. The radio will send out a loud siren sound and the flashlight will flash.

Press the [🚨] button to exit the emergency alert function.

***WARNING: The Emergency Alert feature should only be used in the even of an actual emergency.***

## Using the Weather Radio/Scan Weather Channel

Your radio has a **NOAA Weather** Radio function, to enable the user to receive weather reports from designated NOAA stations. Your radio also has a **NOAA Weather Scan** function, to enable the user to scan all 12 channels of the NOAA Weather Radio. While using the Weather Radio, you are not able to receive FRS communications.

- 1) To turn the NOAA Weather Scan on, press and hold the [/MONI] button for 5 seconds while in FRS mode,  icon appears. The radio will go to Weather band mode and start scanning all 12 channels and stop on any active channel. When the channel becomes inactive for 10 seconds the radio will resume scanning.
- 2) To stop the NOAA WEATHER (WX) SCAN and set the channel manually on the Weather band, press the [SCAN] button during NOAA weather scan. The radio will stop scanning and the display will show the current Weather band channel setting and the  icon.
- 3) While in Weather band mode, press the [/MENU] button, then press the [▲] or [▼] button to increase or decrease the number to the desired weather channel, and press the [/MENU] button to confirm to select one of the 12 NOAA weather band channels.
- 4) To exit the Weather Radio broadcast mode, press and hold [ /MONI] button.  icon disappears.

## Menu Options

### FRS Menu List

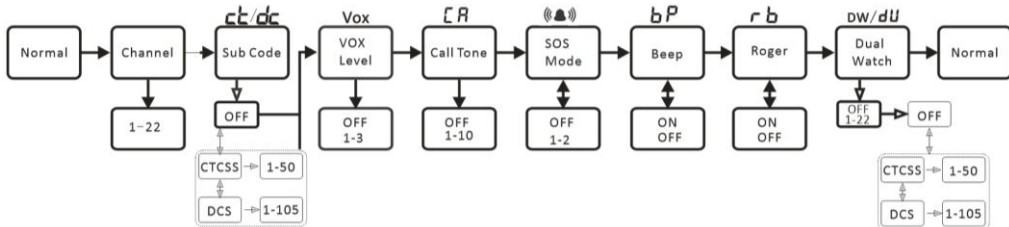

## Selecting the Channel

The channel is the frequency of the radio uses to transmit. Your radio has 16 channels and 155 Sub-Codes you can use to talk to others. In order to speak to someone, both your radios must be set to the same channel and Privacy code.

- 1) Press and hold the [📞/CALL] button until the radio is turned on.
  - 2) Press [📞/MENU] button until the channel number starts to flash.
  - 3) Press [▲] or [▼] to change the channel. Long press on these keys allows you to scroll through the channels rapidly to browse the codes.
  - 4) Press [PTT] button to exit menu or [📞/MENU] button to continue set up.
- If the [📞/MENU] button is locked, please press and hold the [📞/MENU] button for 3 seconds to unlock.

## CTCSS/DCS tones selection

MP23/ T23 can receive in two modes:

- Open traffic: in this case you will hear any communication transmitted on the selected channel;
- Group mode CTCSS/DCS: CTCSS/DCS tones are access keys that allow you to receive only messages coming from parties using the same channel and code. The speaker will remain muted until the correct tone is received.

To activate 1 of 50 different CTCSS/105 DCS tones in RX and TX

- 1) To select CTCSS/DCS, press [📞/MENU] twice until the display shows CTC or DCS (flashing on the lower left).
- 2) By pushing the [▲] or [▼] button the display will show CTCSS (ct blinking) or DCS (dc blinking); press [📞/MENU] to enter the CTCSS or DCS tones. Now select the desired tone with the [▲] or [▼] buttons.
- 3) Press the [PTT] button to exit menu or [📞/MENU] button to continue set up.

## VOX function

MP23/ T23 enables hands free conversations through VOX function.

- 1) To activate VOX function press the [📞/MENU] button 4 times and 'VOX' will appear on the display.
- 2) Use the [▲] or [▼] buttons to select the desired setting:

*The VOX sensitivity can be set in 3 different levels:*

- 1 = high sensitivity (normal voice with no background noise)
- 2 = Medium Sensitivity for most environments
- 3 = low sensitivity (useful in very noisy areas or if you talk loudly)

3) Press the [PTT] button to exit menu or [M/MENU] button to continue set up.

To disable the VOX function follow the instructions above and select option of **(OF: Disabled)**.

## Setting and Transmitting Call Tones

MP23/ T23 can transmit different call tones to other radios in your group so you can alert them that you want to talk. Your radio has 10 call tones for you to choose from.

To select the call tones:

- 1) Press the [M/MENU] button 5 times and "CA" will appear on the display.
- 2) Press [▲] or [▼] to change and listen to the call tone.
- 3) Press the [PTT] button to exit menu or [M/MENU] button to continue set up.

- To disable the Call Tones follow the instructions above and select option of **(OF: Disabled)**.

In order to transmit your call tone to other radios, set up the same channel and Sub-Code on your radio and press the [C/CALL] button.

## Emergency alarm type

With the emergency alert feature, you can signal to your group members that you need help. The alarm signal can only be signaled that you need help by pressing and hold the [V] button after the emergency alarm function of the MP23/ T23 is activated.

Select an emergency alert type:

- 1) To activate emergency alert function press the [M/MENU] button 6 times and until the display shows "📞".
- 2) Use the [▲] or [▼] buttons to select the desired setting:

*oF: Disabled*

*1. Local alarm, the radio itself emits an alarm sound;*

*2. Send an alarm tone on the current channel to signal to group members that you need help.*

3) Press the **[PTT]** button to exit menu or **[M/MENU]** button to continue set up.

***WARNING:** The Distress Alert feature should only be used in a true emergency. If the receiving group does not respond to the distress signal, Baofeng will not assume any responsibility.*

## Keypad beep

To deactivate the keypad beep, follow these steps:

- 1) Press the **[M/MENU]** button 7 times and until “**b<sup>P</sup><sub>off</sub>**” is displayed.
- 2) Use the **[▲]** or **[▼]** buttons until the display shows “**b<sup>P</sup><sub>of</sub>**”.
- 3) Press the **[PTT]** button to exit menu or **[M/MENU]** button to continue set up.

*Now you won't hear any beep at the pressure of any button.*

## ROGER BEEP (End transmission tone)

When the **PTT** button is released, the radio will beep to confirm to other users that your transmission has finished.

To deactivate it:

- 1) Press the **[M/MENU]** button 8 times and until the display shows “**r<sup>b</sup><sub>off</sub>**”;
- 2) Using the buttons **[▲]** or **[▼]** select “off” and “**r<sup>b</sup><sub>of</sub>**” will be displayed;
- 3) Press the **[PTT]** button to exit menu or **[M/MENU]** button to continue set up.

## Dual Watch Mode

Your radio has a **DUAL WATCH** function, to enable user to scan 2 channels for any activity. The first channel will be the current channel setting and the second channel will be the selected channel on the.

To set another channel and start Dual Watch:

- 1) Press the **[M/MENU]** button 9 times and until the display shows “**oF<sup>~</sup><sub>du</sub>**”;
- 2) Using the buttons **[▲]** or **[▼]** select the channel, then press **[M/MENU]**.
- 3) Using the buttons **[▲]** or **[▼]** select the CTCSS/DCS, then press **[M/MENU]**.
- 4) The radio starts to Dual Watch.

*The screen will alternate between home channel and Dual Channel Monitor channel.*

*Note: If you set the same channel and Sub-code as the current channel, Dual Watch doesn't work.*

5) Press the [🔍/SCAN] button to turn the Dual Watch mode OFF.

## Technical Specifications

General Part	
Frequency Range	FRS
Channels	22 FRS/12 Weather
Sub-Codes	50 CTCSS Tones/ 105 DCS Codes
Working temperature	-20°C to +50°C
Operation Voltage	DC 3.7 V ±10%
Operation Mode	Simplex
Dimensions	168mm×57mm×34.5mm (without Antenna)
Weight	150g (Battery pack included)
Antenna Impedance	50ohm
Transmitter Part	
Frequency Stability	±2.5ppm
RF Output Power	2W (FRS)
Max frequency deviation	≤2.5KHz
Audio distortion	≤3%
Adjacent Channel Power	< 60dB
Receiver Part	
Receive Sensitivity	< 0.2μV @20dB SINAD
Audio distortion	≤3%
Audio response	300 Hz ~ 3 KHz

## Appendix B. – Trouble shooting guide

Phenomena	Analysis	Solution
You cannot turn on the radio.	The battery may be installed improperly.	Remove and reattach the battery.
	The battery power may run out.	Recharge or replace the battery.
	The battery may suffer from poor contact caused by dirty or damaged battery contacts.	Clean the battery contacts or replace the battery.
During receiving, the voice is weak or intermittent.	The battery voltage maybe low.	Recharge or replace the battery.
	The volume level may be low.	Increase the volume.
	The speaker maybe blocked.	Clean the surface of the speaker.
You cannot communicate with other group members.	The frequency or signaling type maybe inconsistent with that of other members.	Verify that your TX/RX frequency and signaling type are correct.
	You may be too far away from other members.	Move towards other members.
You hear unknown voices or noise.	You may be interrupted by radios using the same frequency.	Change the frequency, or adjust the squelch level.
	The radio in analog mode maybe set with no signaling.	Request your dealer to set signaling for the current channel to avoid interference
You are unable to hear anyone because of too much noise and hiss.	You may be too far away from other members.	Move towards other members.
	You may be in an unfavorable position. For example, your communication may be blocked by high buildings or blocked in an underground area.	Move to an open and flat area, restart the radio, and try again.
	It may be the result of external disturbance (such as electromagnetic interference).	Stay away from equipment that may cause interference.
The radio keeps transmitting.	VOX may be turned on or the headset is not installed in place	Turn off the VOX function. Check that the headphones are in place.

**NOTE: If the above solutions cannot fix your problems, or you may have some other queries, please contact your dealer for more technical support.**



## Appendix C. –FRS Frequency Chart (MHz)

CH.No	CH.Freq.	RF Power	CH.No	CH.Freq.	RF Power
1	462.5625	High	12	467.6625	Low
2	462.5875	High	13	467.6875	Low
3	462.6125	High	14	467.7125	Low
4	462.6375	High	15	462.5500	High
5	462.6625	High	16	462.5750	High
6	462.6875	High	17	462.6000	High
7	462.7125	High	18	462.6250	High
8	467.5625	Low	19	462.6500	High
9	467.5875	Low	20	462.6750	High
10	467.6125	Low	21	462.7000	High
11	467.6375	Low	22	462.7250	High

## Appendix D. - NOAA Weather Radio Frequency List (US, CAN, AND INTL)

Channel No.	RX Freq.(MHz)	Channel No.	RX Freq.(MHz)
1	162.5500	7	162.5250
2	162.4000	8	161.6500
3	162.4750	9	161.7750
4	162.4250	10	161.7500
5	162.4500	11	162.000
6	162.5000	12	163.275

## Appendix E. - DCS Table

### DCS CODE LIST

Number	Code	Number	Code	Number	Code	Number	Code	Number	Code
1	D023	2	D025	3	D026	4	D031	5	D032
6	D036	7	D043	8	D047	9	D051	10	D053
11	D054	12	D065	13	D071	14	D072	15	D073
16	D074	17	D114	18	D115	19	D116	20	D122
21	D125	22	D131	23	D132	24	D134	25	D143
26	D145	27	D152	28	D155	29	D156	30	D162
31	D165	32	D172	33	D174	34	D205	35	D212
36	D223	37	D225	38	D226	39	D243	40	D244
41	D245	42	D246	43	D251	44	D252	45	D255
46	D261	47	D263	48	D265	49	D266	50	D271
51	D274	52	D306	53	D311	54	D315	55	D325
56	D331	57	D332	58	D343	59	D346	60	D351
61	D356	62	D364	63	D365	64	D371	65	D411
66	D412	67	D413	68	D423	69	D431	70	D432
71	D445	72	D446	73	D452	74	D454	75	D455
76	D462	77	D464	78	D465	79	D466	80	D503
81	D506	82	D516	83	D523	84	D526	85	D532
86	D546	87	D565	88	D606	89	D612	90	D624
91	D627	92	D631	93	D632	94	D645	95	D654
96	D662	97	D664	98	D703	99	D712	100	D723
101	D731	102	D732	103	D734	104	D743	105	D754

**Note: DCS codes can be programmed for use on Channels 1~22 only.**

## Appendix F. - CTCSS Table

CTCSS CHART (Hz)

Number	Frequency	Number	Frequency	Number	Frequency	Number	Frequency	Number	Frequency
1	67.0	2	69.3	3	71.9	4	74.4	5	77.0
6	79.7	7	82.5	8	85.4	9	88.5	10	91.5
11	94.8	12	97.4	13	100	14	103.5	15	107.2
16	110.9	17	114.8	18	118.8	19	123.0	20	127.3
21	131.8	22	136.5	23	141.3	24	146.2	25	151.4
26	156.7	27	159.8	28	162.2	29	165.5	30	167.9
31	171.3	32	173.8	33	177.3	34	179.9	35	183.5
36	186.2	37	189.9	38	192.8	39	196.6	40	199.5
41	203.5	42	206.5	43	210.7	44	218.1	45	225.7
46	229.1	47	233.6	48	241.8	49	250.3	50	254.1

Note: CTCSS Chart can be programmed for use on Channels 1~22 only

### IMPORTANT NOTICE



**WARNINGS:** Replacement or substitution of transistors, regular diodes or other parts of a unique nature, with parts other than those recommended by PO FUNG COMPANY may cause a violation of the technical regulations of part 95 of the FCC rules, or violation of type acceptance requirements of part 2 of the rules. Your radio is set up to transmit a regulated signal on an assigned frequency. Any adjustment to your radio must be made by qualified technicians.

This device complies with Part 15 of the FCC Rules. Operation is subject to the following two conditions: 1) This device may not cause harmful interference, and 2) this device must accept any interference received, including interference that may cause undesired operation.



## **FCC & RSS WARNINGS:**

Any Changes or modifications not expressly approved by the party responsible for compliance could void the user's authority to operate the equipment.

SAR tests are conducted using standard operating positions accepted by the FCC/ISED with the device transmitting at its highest certified power level in all tested frequency bands, although the SAR is determined at the highest certified power level, the actual SAR level of the device while operating can be well below the maximum value. Before a new model is available for sale to the public, it must be tested and certified to the FCC/ISED that it does not exceed the exposure limit established by the FCC/ISED. Tests for each product are performed in positions and locations as required by the FCC/ISED. For body worn operation, this device has been tested and meets the FCC/ISED RF exposure guidelines when used with an accessory designated for this product or when used with an accessory that contains no metal.

To maintain compliance with the FCC/ISED's RF exposure guidelines, hold the transmitter and antenna at least 25mm from your face and speak in a normal voice, with the antenna pointed up and away from the face.

This equipment complies with FCC/ISED radiation exposure limits set forth for an uncontrolled environment. In order to comply with the FCC/ISED RF exposure requirements, the antenna installation must comply with following:

Users must be fully aware of the hazards of the exposure and able to exercise control over their RF exposure to qualify for the higher exposure limits.

Your wireless hand-held portable transceiver contains a low power transmitter. This product sends out radio frequency (RF) signals when the Push-to-Talk (PTT) Button is pressed.

The device is authorized to operate at a duty factor not to exceed 50%.

This device complies with ISED licence-exempt RSS standard (s). Operation is subject to the following two conditions:

(1) this device may not cause interference, and (2) this device must accept any interference, including interference that may cause undesired operation of the device.

Le présent appareil est conforme aux CNR d'ISED licenciables aux ondes radio exemptées de licence.

L'exploitation est autorisée aux deux conditions suivantes:

- (1) l'appareil ne doit pas produire de brouillage, et
- (2) l'utilisateur de l'appareil doit accepter tout brouillage radioélectrique subi, même si le brouillage est susceptible d'en compromettre le fonctionnement.

### **ISED C exposition aux radiations**

*Cet équipement est conforme avec ISED C les limites d'exposition aux rayonnements définies pour un contrôlé environnement.*

*Cet émetteur ne doit pas être co-localisés ou fonctionner en conjonction avec une autre antenne ou émetteur.*

*Cet équipement doit être installé et utilisé avec un minimum de 25mm de distance entre le radiateur et votre corps.*

### **Electromagnetic Interference/Compatibility**

This device complies with Part 15 of the FCC Rules. Operation is subject to the following two conditions:

1. This device may not cause harmful interference, and
2. This device must accept any interference received, including interference that may cause undesired operation.

Changes or modifications not expressly approved by the party responsible for compliance could void your authority to operate the equipment.

Avis de conformité à la FCC: Ce dispositif a été testé et s'avère conforme à l'article 15 des règlements de la Commission fédérale des communications (FCC). Ce dispositif est soumis aux conditions suivantes: 1) Ce dispositif ne doit pas causer d'interférences nuisibles et; 2) Il doit pouvoir supporter les parasites qu'il reçoit, incluant les parasites pouvant nuire à son fonctionnement.

Tout changement ou modification non approuvé expressément par la partie responsable pourrait annuler le droit à l'utilisateur de faire fonctionner cet équipement.

This device complies with Industry Canada license-exempt RSS standard(s). Operation is subject to the following two conditions:

1. This device may not cause interference, and
2. This device must accept any interference received, including interference that may cause undesired operation of the device.

## **Precautions for Portable Terminals**

### **■ Operating Prohibitions**

To protect you against any property loss, bodily injury or even death, be sure to observe the following safety instructions:

1. Do not operate the product in a location containing fuels, chemicals, explosive atmospheres and other flammable or explosive materials. In such location, only an approved Ex-protection model is allowed for use, but any attempt to assemble or disassemble it is strictly prohibited.
2. Do not operate the product near or in any blasting area.
3. Do not operate the product near any medical or electronic equipment that is vulnerable to RF signals.
4. Do not hold the product while driving.
5. Do not operate the product in any area where use of wireless communication equipment is completely prohibited.

### **■ Important Tips**

To help you make better use of the product, be sure to observe the following instructions:

1. Do not use any unauthorized or damaged accessory.
2. Keep the product at least 2.5 centimeters away from your body during transmission.
3. Do not keep the product receiving at high volume for a long time.
4. For vehicles with an air bag, do not place the product in the area over the air bag or in the air bag deployment area.
5. Keep the product and its accessories out of reach of children and pets.
6. Please operate the product within the specified temperature range.
7. Continuous transmission for a long time may lead to heat accumulation within the product. In this case, please keep it at a

proper location for cooling.

8. Handle the product with care.

9. Do not disassemble, modify or repair the product and its accessories without authorization.

### ■ Hazardous Environments

Do not operate the radio in hazardous environments. Explosion or fire may result. Do not operate the radio near unshielded electrical blasting caps.

Under certain conditions, radios can interfere with blasting operations and may cause an explosion. Turn your radio OFF to prevent accidental transmission when in a blasting area or in areas posted: "Turn off two-way radio." Construction crews often use remote control RF devices to set off explosives.

### Precautions for Batteries

#### ■ Charging Prohibitions

To protect you against any property loss, bodily injury or even death, be sure to observe the following safety instructions:

1. Do not charge or replace your battery in a location containing fuels, chemicals, explosive atmospheres and other flammable or explosive materials.
2. Do not charge your battery that is wet. Please dry it with a soft and clean cloth prior to charge.
3. Do not charge your battery suffering deformation, leakage and overheat.
4. Do not charge your battery with an unauthorized charger.
5. Do not charge your battery in a location where strong radiation is present.
6. Overcharge shall always be prohibited for it may shorten the life of your battery.

#### ■ Maintenance Instructions

To help your battery work normally or prolong its life, be sure to observe the following instructions:

1. Accumulated dust on charging connector may affect normal charging. Please use a clean and dry cloth to wipe it on a

regular basis.

1. It is recommended to charge the battery under 5°C~40°C. Violation of the said limit may cause battery life reduction or even battery leakage.
2. To charge a battery attached to the product, turn it off to ensure a full charge.
3. Do not remove the battery or unplug the power cord during charging to ensure a smooth charging process.
4. Do not dispose of the battery in fire.
5. Do not expose the battery to direct sunlight for a long time nor place it close to other heating sources.
6. Do not squeeze and penetrate the battery, nor remove its housing.

### ■ Transportation Instructions

1. Damaged batteries must not be transported.
2. To avoid short circuit, separate the battery from metal parts or from each other if two or more batteries are transported in one packaging.
3. The radio must be switched off and secured against switch-on, if the battery is attached.

The content of the shipment must be declared in the shipping documents and by a Battery Shipping Label on the packaging. Contact your hauler for the local regulations and further information.

### ■ Precautions for Disposal

Once the service life of our products (including but not limited to radios and batteries) has ended, they shall not be disposed as household garbage. Their recycling and disposal shall satisfy your local regulations.



## Disclaimer

The Company endeavors to achieve the accuracy and completeness of this manual, but no warranty of accuracy or reliability is given. All the specifications and designs are subject to change without notice due to continuous technological development. No part of this manual may be copied, modified, translated, or distributed in any manner without the prior written consent of the Company.

We do not guarantee, for any particular purpose, the accuracy, validity, timeliness, legitimacy or completeness of the third-party products and contents involved in this manual.

### **PO FUNG ELECTRONIC (HK) INTERNATONAL GROUP COMPANY LIMITED**

Room 1508, 15/F, Office Tower II, Grand Plaza, 625 Nathan Road, Kowloon, Hong Kong

[Http://www.baofengradio.com](http://www.baofengradio.com)

[www.pofungshop.com](http://www.pofungshop.com)

Print version: MP23/T23(FCC)\_Public\_V1.0